

SERVICE MANUAL



X1161/X1261/X1161A/X1161N/X110/H5360

Date	Revise Version	Description
2009.05.22	V1.0	Initial Issue
2009.06.25	V2.0	Modify Chapter 5
2009.08.06	V3.0	1. Add X1161's extended models: X1161A, X1161N, X110 2. Update Engineering Spec. of Chapter 1 3. Modify Chapter 4
2009.09.16	V4.0	1. Add X1261's extended models: H5360 2. Update Engineering Spec. of Chapter 1 3. Modify Chapter 4

Copyright September, 2009 All Rights Reserved P/N: 36.8CP01G001

SI: *huhui*

TSE: *Rock*

Check: *Joanna*

Approved: *Joseph Li*

Preface

This manual is applied to X1161/X1261/X1161A/X1161N/X110/H5360 projection system. The manual gives you a brief description of basic technical information to help in service and maintain the product.

Your customers will appreciate the quick response time when you immediately identify problems that occur with our products. We expect your customers will appreciate the service that you offer them.

This manual is for technicians and people who have an electronic background. Please send the product back to the distributor for repairing and do not attempt to do anything that is complex or is not mentioned in the troubleshooting.

Note: The information found in this manual is subject to change without prior notice. Any subsequent changes made to the data herein will be incorporated in future edition.

X1161/X1261/X1161A/X1161N/X110/H5360 Service Manual

Copyright September, 2009

All Rights Reserved

Manual Version 4.0

X1161/X1161A/X1161N/X110/X1261/H5360 Comparison List

Models Parts	H5360	X1261	X1161	X1161A	X1161N	X110
NAME LABEL	35.8ER02H001	35.8CQ03H001	35.8CP02H001	35.8CP07H001	35.8CP05H001	35.8CP10H001
MAIN BOARD	70.8ER17GR01	70.8CQ09GR01	70.8CP25GR01	70.8CP27GR01	70.8CP29GR01	70.8CP28GR01
DMD CHIP	48.8ER01G001	48.8CQ01G003	48.8EH01G001			
IO COVER	70.8ER18GR01	70.8CQ08GR01	70.8CP23GR01			
ENGINE	70.8ER15GR01	70.8CQ07GR01	70.8CP22GR01			
SPEAKER	49.8CQ01G001		N/A			
LAMP BLOWER	49.8CS01G002				49.8CS01G001	
SYSTEM FAN	49.8CP02G002				49.8CP02G001	
COLOR WHEEL	70.8ER16GR01	70.8CP21GR01				
LAMP	SP.8ER01GC01	SP.8CP01GC01				
LVPS	75.8FE01GP01	75.8CP03GP01				
LAMP DRIVER	70.8ER20GR01	75.8BA01G002				
BOTTOM COVER	70.8ER19GR01	70.8CP26GR01				
TOP COVER	75.8ER01G001	75.8CP04H001				
FRONT COVER	51.8CP09H021	51.8CP09H001				

Table of Content

Chapter 1 Introduction

Highlight	1-1
Compatible Mode	1-5
Product Overview	1-9

Chapter 2 Disassembly Process & Assembly Process

Equipment Needed & Product Overview	2-1
Disassemble Lamp Cover Module	2-2
Disassemble Lamp Module	2-2
Disassemble Top Cover Module	2-3
Disassemble Top Shielding	2-3
Disassemble Front Cover and IR Sensor Board	2-4
Disassemble Main Board Module and IO Cover Module	2-5
Disassemble Engine Module	2-7
Disassemble Color Wheel Module	2-8
Disassemble DMD Chip and DMD Board	2-8
Disassemble Zoom Ring	2-9
Disassemble Focus Ring	2-9
Disassemble System Fan Module	2-10
Disassemble Blower	2-11
Disassemble LVPS Module	2-11
Disassemble Lamp Driver Module	2-12
Disassemble Interrupt Switch	2-13
Disassemble Bottom Shielding	2-13
Disassemble Speaker (for X1261/H5360)	2-14
Rod Adjustment	2-14
Re-write System and Lamp Usage Hour	2-15
Assemble Speaker (for X1261/H5360)	2-16

Assemble Bottom Shielding	2-17
Assemble Interrupt Switch	2-17
Assemble Lamp Driver Module	2-18
Assemble LVPS Module	2-19
Assemble Blower	2-19
Assemble System Fan Module	2-20
Assemble Focus Ring	2-21
Assemble Zoom Ring	2-21
Assemble DMD Chip and DMD Board	2-22
Assemble Color Wheel Module	2-22
Assemble Engine Module	2-23
Assemble IO Cover and Main Board Module	2-23
Assemble IR Sensor Board and Front Cover	2-25
Assemble Top Shielding	2-26
Assemble Top Cover Module	2-26
Assemble Lamp Module	2-27
Assemble Lamp Cover Module	2-27
Chapter 3 Troubleshooting	
LED Lighting Message	3-1
Main Procedure	3-2
Chapter 4 Function Test & Alignment Procedure	
Test Equipment Needed	4-1
Service Mode	4-1
OSD Reset	4-1
Test Condition	4-2
Test Inspection Procedure	4-3
PC Mode	4-4

	Calibration	4-7
	Video Performance	4-9
	Optical Performance Measure	4-10
	Others	4-12
Chapter 5	Firmware Upgrade	
	Equipment Needed	5-1
	DLP Composer Lite Setup Procedure	5-2
	USB Driver Upgrade Procedure (for X1161 only)	5-4
	Firmware Upgrade Procedure	5-5
	Waveform Download	5-8
Chapter 6	EDID Upgrade	
	EDID Introduction	6-1
	Equipment Needed	6-2
	Setup Procedure (VGA)	6-3
	EDID Key-In Procedure	6-4
	Un-lock SNID and Default Language Reset	6-6
Appendix A		
	Exploded Overview	I
Appendix B		
	Serial Number System Definition	I
	PCBA Code Definition	II
Appendix C		
	RS232 function command summary table (for X1261/H5360)	I

Introduction

1-1 Highlight

No	Item	Description
1	Dimensions (W x H x D)	<ul style="list-style-type: none">• 268 mm x 192 mm x 80 mm
2	Weight	<ul style="list-style-type: none">• <4.9 lbs
3	Tilt Angle	<ul style="list-style-type: none">• 2.7 degree with elevator mechanism
4	Power Supply	<ul style="list-style-type: none">• Universal AC 100 – 240 V ~ 50-60 Hz with PFC input• Variance FAN speed control (Depends on temperature variant)
5	Keystone correction	<ul style="list-style-type: none">• +/-40 degree (80 degree)
6	Cooling system	<ul style="list-style-type: none">• Advanced Air Flow• Two fans with system• Temperature control circuits with adaptive fan rotational speeds• Maximum touch temperature follow UL60950-1
7	Brightness	<ul style="list-style-type: none">• Engineering spec:<ul style="list-style-type: none">• 2250 ANSI Lumens (Typical)• 2000 ANSI Lumens (Minimum)• Marketing spec:<ul style="list-style-type: none">• 2500 ANSI Lumens (Standard)• 2000 ANSI Lumens (ECO)

No	Item	Description
8	Contrast	<ul style="list-style-type: none"> • Engineering spec: For X1161/X1161N/X1161A/X110: <ul style="list-style-type: none"> • 2500: 1 Full White with full power / full Black with eco power (Minimum; projection lens at tele mode) • 3600: 1 Full White with full power / full Black with eco power (Typical; projection lens at tele mode) For X1261: <ul style="list-style-type: none"> • 2100: 1 Full White with full power / full Black with eco power (Minimum; projection lens at tele mode) • 3300: 1 Full White with full power / full Black with eco power (Typical; projection lens at tele mode) For H5360: <ul style="list-style-type: none"> • 2320: 1 Full White with full power / full Black with eco power (Minimum; projection lens at tele mode) • 2900: 1 Full White with full power / full Black with eco power (Typical; projection lens at tele mode) • Marketing spec: <ul style="list-style-type: none"> • 3500: 1 (for X1161/X1161N/X1161A/X110) • 3000: 1 (for X1261) • 3200: 1 (for H5360)
9	Uniformity	<ul style="list-style-type: none"> • Engineering spec: <ul style="list-style-type: none"> • 65% JBMA (Minimum; Full power mode) • 80% JBMA (Typical; Full power mode) • Marketing spec: <ul style="list-style-type: none"> • 85%
10	Throw ratio	<ul style="list-style-type: none"> • 1.95 – 2.15 distance/width @60" (for X1161/X1261/X1161N/X1161A/X110) • 1.55 – 1.7 distance/width @60" (for H5360)
11	Audio	<ul style="list-style-type: none"> • 2W*1 (for X1261 /H5360 only)
12	Projection lens	<ul style="list-style-type: none"> • F# 2.41~2.55, f = 21.79~23.99 mm, 1.10X Mechanical Zoom Lens (for X1161/X1261/X1161N/X1161A/X110) • F# 2.5~2.6, f = 21.86~24 mm, 1.10X Mechanical Zoom Lens (for H5360)
13	Lamp life	<ul style="list-style-type: none"> • 3000 hours, 50% survival rate (Full power Mode) • 4000 hours, 50% survival rate (Eco power Mode)
14	System controller	<ul style="list-style-type: none"> • TI DDP2430 (for X1161/X1261/X1161N/X1161A/X110) • TI DDP2431 (for H5360)
15	Lamp housing	<ul style="list-style-type: none"> • Lamp Assembly could be changed by customer himself, but should read the user manual for instruction in advance • Lamp Assembly should be provided by Coretronic and distributed through authorized agencies

No	Item	Description
16	TI DMD	<ul style="list-style-type: none"> • TI DMD 0.55" 12° 2xLVDS S450 SVGA Digital Mirror Device (for X1161/X1161N/X1161A/X110) • TI DMD 0.55" 12° 2xLVDS S450 XGA Digital Mirror Device (for X1261) • TI DMD 0.62" 12° S450 720p Digital Mirror Device (for H5360)
17	Number of active dots	<ul style="list-style-type: none"> • 800(H) x 600(V) (for X1161/X1161N/X1161A/X110) • 1024(H) x 768(V) (for X1261) • 1280(H) x 720(V) (for H5360)
18	Color wheel	<ul style="list-style-type: none"> • 6 segments (R81Y41G84C31W52B71) (for X1161/X1261/X1161N/X1161A/X110) • 6 segments (R90Y35G85C33W42B75) (for H5360) • 6000 ~ 7650 rpm @ CW 2X and 1.5X (50 ~85Hz)
19	Lamp	<ul style="list-style-type: none"> • 180Watt OSRAM E20.8 open type Lamp (for X1161/X1261/X1161N/X1161A/X110) • 200Watt OSRAM E20.8 open type Lamp (for H5360)
20	Video compatibility	<ul style="list-style-type: none"> • Standards : <ul style="list-style-type: none"> • NTSC (3.58/4.43) • PAL (B/D/G/H/I/M/N) • SECAM (B/D/G/K/K1/L) • HDTV (480i,576i 480p, 576p, 720p, 1080i, 1080p)

No	Item	Description
21	Terminal	<ul style="list-style-type: none"> ● For X1161/1161A/X110: <ul style="list-style-type: none"> • VGA In * 1: One D-Sub 15-Pin Female Connector for PC input and analog Data (Component i/p, HDTV, RGB Sync) • S-video * 1: One Mini DIN 4-Pin connector for S-Video Input Connector • Composite * 1: One RCA Jack for Composite Video Input Connector • USB * 1: One Type-B USB support F/W up-grade and reserve remote Page-Up and Page-Down function ● For X1161N: <ul style="list-style-type: none"> • VGA In * 1: One D-Sub 15-Pin Female Connector for PC input and analog Data (Component i/p, HDTV, RGB Sync) • USB * 1: One Type-B USB support F/W up-grade and reserve remote Page-Up and Page-Down function ● For X1261: <ul style="list-style-type: none"> • VGA In * 1: One D-Sub 15-Pin Female Connector for PC input and analog Data (Component i/p, HDTV, RGB Sync) • S-video * 1: One Mini DIN 4-Pin connector for S-Video Input Connector • Composite * 1: One RCA Jack for Composite Video Input Connector • VGA out * 1: One D-Sub 15-Pin Female Connector for VGA output (Component i/p, HDTV, RGB Sync) • Audio in * 1: One 3.5mm phone jack for Audio input • RS232 * 1: One Mini DIN 3-Pin connector for RS232 ● For H5360 <ul style="list-style-type: none"> • VGA In * 1: One D-Sub 15-Pin Female Connector for PC input and analog Data (Component i/p, HDTV, RGB Sync) • S-video * 1: One Mini DIN 4-Pin connector for S-Video Input • Composite * 1: One RCA jack for Composite Video Input • Component * 1: Three RCA jacks for Component Input • HDMI * 1: Support HDMI v1.3 • Audio in * 1: One 3.5mm phone jack for Audio input • RS232 * 1: One Mini DIN 3-Pin connector for RS232

No	Item	Description
22	Input signal spec.	<ul style="list-style-type: none"> • Hsync Frequency 30~ 100 kHz • Vsync Frequency 50~ 85 Hz • Video Signal RGB (PC) <ul style="list-style-type: none"> • Analog RGB 0.7Vp-p, 75 ohm, Separate TTL H,V Sync • Analog RGB 1Vp-p, 75 ohm, Sync. On Green signal • Analog RGB 0.7Vp-p, 75 ohm, Composite TTL Sync. • Video <ul style="list-style-type: none"> • Composite video 1Vp-p,75 ohm • S-video Luminance 0.714Vp-p, 75 ohm • Chrominance 0.286Vp-p, 75 ohm • Component Video 1Vp-p, 75 ohm
23	Temperature	<ul style="list-style-type: none"> • Operating: <ul style="list-style-type: none"> • for 0 - 2500 ft, 5 - 35 °C • for 2500 - 5000 ft, 5 - 30 °C • for 5000 - 10000 ft, 5 - 25 °C • Storage: -20°C ~ 60°C
24	Maximum Humidity	<ul style="list-style-type: none"> • Operating: 5°C ~ 35°C, 80%RH (Max.), Non-condensing • Storage: -20°C ~ 60°C, 80%RH (Max.), Non-condensing

1-2 Compatible Mode

Compatibility modes (VGA Analog) (for X1161/X1261/X1161N/X1161A/X110)

Compatibility	Resolution	V.Frequency [Hz]	H.Frequency [KHz]
(1) VGA Analog - PC Signal			
VGA	640 x 480	60	31.5
	640 x 480	72	37.9
	640 x 480	75	37.5
	640 x 480	85	43.3
	720 x 400	70	31.5
	720 x 400	85	37.9
SVGA	800 x 600	56	35.1
	800 x 600	60	37.9
	800 x 600	72	48.1
	800 x 600	75	46.9
	800 x 600	85	53.7

Compatibility	Resolution	V.Frequency [Hz]	H.Frequency [KHz]
XGA	1024 x 768	60	48.4
	1024 x 768	70	56.5
	1024 x 768	75	60.0
	1024 x 768	85	68.7
SXGA	1152 x 864	70	63.8
	1152 x 864	75	67.5
	1152 x 864	85	77.1
	1280 x 1024	60	64.0
	1280 x 1024	72	77.0
	1280 x 1024	75	80.0
QuadVGA	1280 x 960	60	60.0
	1280 x 960	75	75.2
SXGA+	1400 x 1050	60	65.3
UXGA	1600 x 1200	60	75.00
Power Mac G4	640 x 480	66.6(67)	34.9
	800 x 600	60	37.9
	1024 x 768	60	48.4
	1152 x 870	75	68.7
	1280 x 960	75	75.0
PowerBook G4	640 x 480	60	31.4
	640 x 480	66.6(67)	34.9
	800 x 600	60	37.9
	1024 x 768	60	48.4
	1152 x 870	75	68.7
	1280 x 960	75	75.0
i Mac DV(G3)	1024 x 768	75	60.0
(2) VGA Analog - Extended Wide timing			
WXGA	1280 x 768	60	47.8
	1280 x 768	75	60.3
	1280 x 768	85	68.6
	1280 x 720	60	44.8
	1280 x 800	60	49.6
	1440 x 900	60	59.9
WSXGA+	1680 x 1050	60	65.3
Horizontal scan rate		30k-100kHz	
Vertical scan rate		50-85Hz	
Max. pixel rate		170MHz	

Compatibility modes (VGA Analog) (for H5360)

Compatibility	Resolution	V.Frequency [Hz]	H.Frequency [KHz]
(1) VGA Analog - PC Signal			
VGA	640 x 480	60	31.5
	640 x 480	72	37.9
	640 x 480	75	37.5
	640 x 480	85	43.3
	640 x 480	120	61.6
SVGA	800 x 600	56	35.2
	800 x 600	60	37.9
	800 x 600	72	48.1
	800 x 600	75	46.9
	800 x 600	85	53.7
	800 x 600	120	77.2
XGA	1024 x 768	60	48.4
	1024 x 768	70	56.5
	1024 x 768	75	60.0
	1024 x 768	85	68.7
	1024 x 768	120	98.8
SXGA	1152 x 864	70	63.8
	1152 x 864	75	67.5
	1152 x 864	85	77.1
	1280 x 1024	60	64.0
	1280 x 1024	72	77.9
	1280 x 1024	75	80.0
	1280 x 1024	85	91.1
QuadVGA	1280 x 960	60	60.0
	1280 x 960	75	75.0
SXGA+	1400 x 1050	60	65.3
UXGA	1600 x 1200	60	75.00
PowerBook G4	640 x 480	60	31.5
	640 x 480	66.6(67)	35
	800 x 600	60	37.88
	1024 x 768	60	48.4
	1152 x 870	75	68.7
	1280 x 960	75	75.2
i Mac DV(G3)	1024 x 768	75	60.0

Compatibility	Resolution	V.Frequency [Hz]	H.Frequency [KHz]
(2) VGA Analog - Extended Wide timing			
WXGA	1280 x 768	60	47.8
	1280 x 768	75	60.3
	1280 x 768	85	68.6
	1280 x 720	60	44.8
	1280 x 800	60	49.6
	1366 x 768	60	47.71
WXGA+	1440 x 900	60	55.9
WSXGA+	1440 x 900	60	65.3
Horizontal scan rate		30k-100kHz	
Vertical scan rate		50-85Hz	
Max. pixel rate		170MHz	

Note: If the Compatibility modes supportive signal is different from User's Manual, please refer to User's Manual.

1-3 Product Overview

Projector Outlook

Front /Upper side

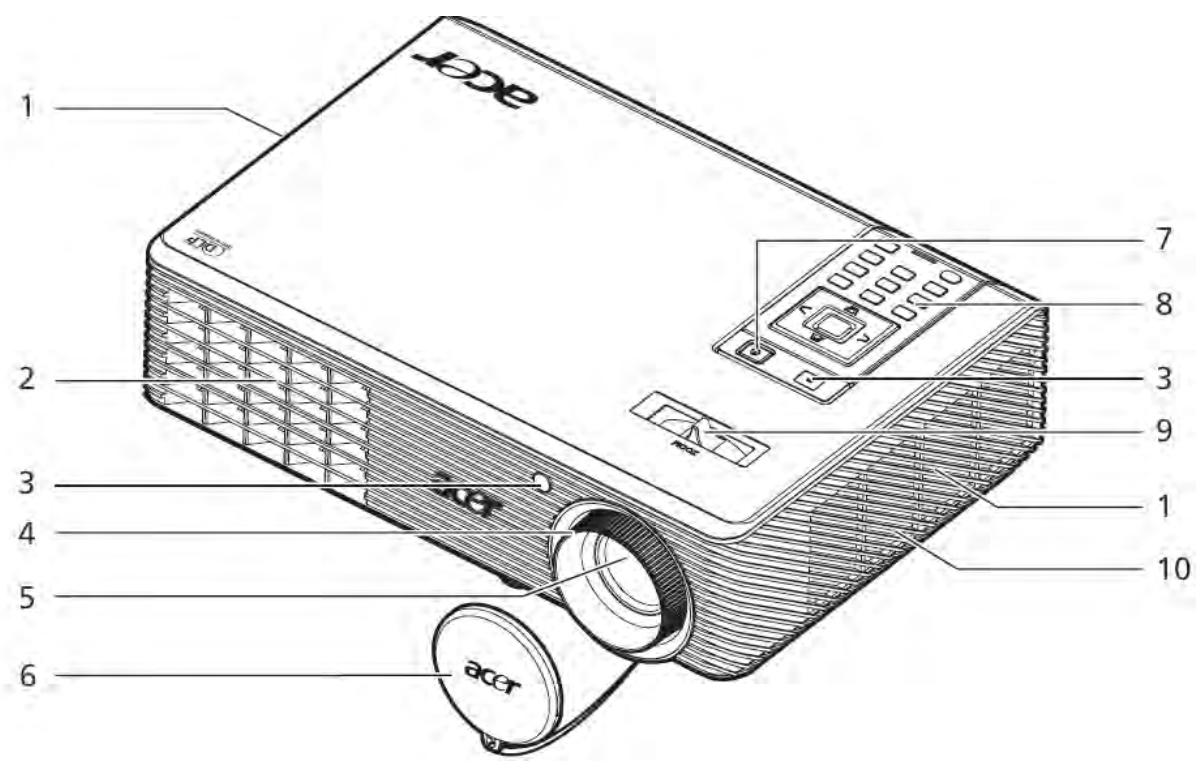

Item	Description	Item	Description
1	Ventilation (inlet)	6	Lens cap
2	Ventilation (outlet)	7	Power button
3	Remote control receivers	8	Remote control
4	Focus ring	9	Zoom lever
5	Zoom lens	10	Horn

Rear side (for X1161/X1261/X1161A/X1161N/X110)

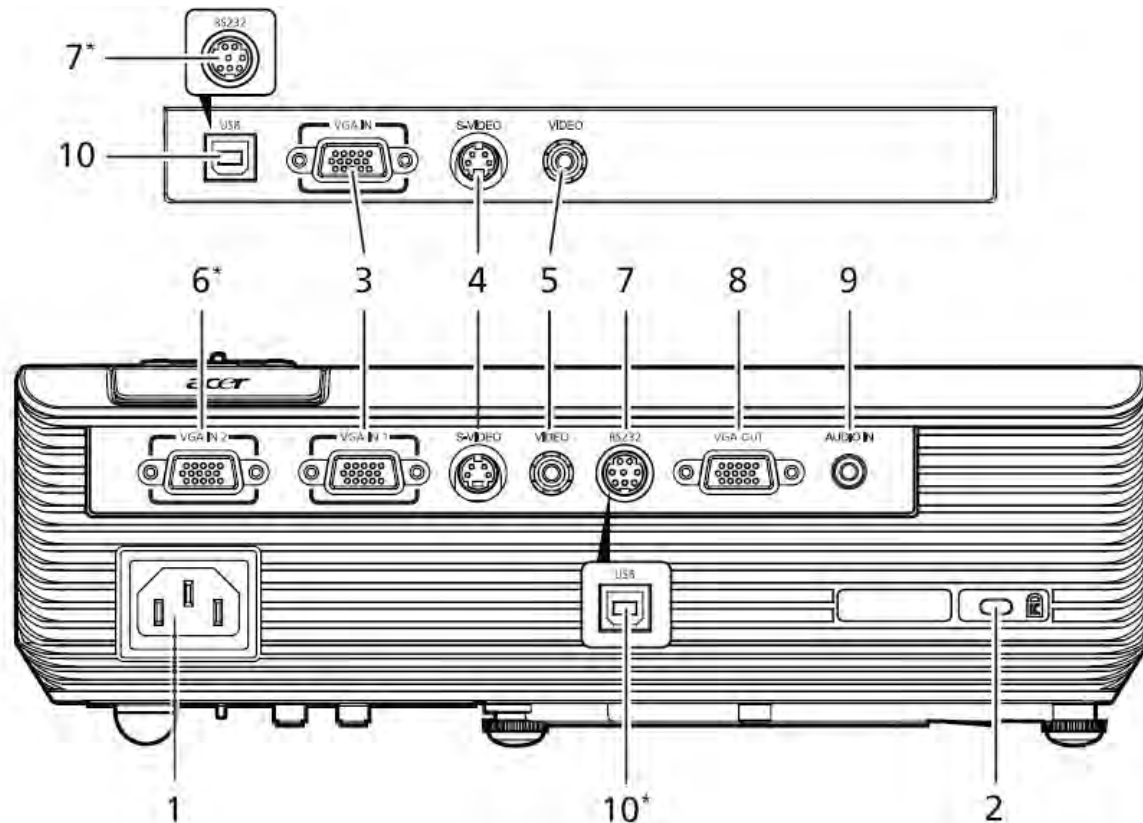

Item	Description	Item	Description
1	Power socket	Below items are for X1261 only:	
2	Kensington™ lock port	4	S-Video input connector
3	PC analog signal/HDTV/component video input connector (VGA IN 1 or VGA IN)	5	Composite video input connector
Below items are for X1161/X1161A/X110 only:		6*	PC analog signal/HDTV/component video input connector (VGA IN 2)
4	S-Video input connector	7	RS232 connector
5	Composite video input connector	8	Monitor loop-through output connector (VGA-Out)
10	USB connector	9	Audio input connector
7*	RS232 connector	10*	USB connector
Below item is for X1161N:			
10	USB connector		



Note: "*" for optional connector port.

Rear side (for H5360)

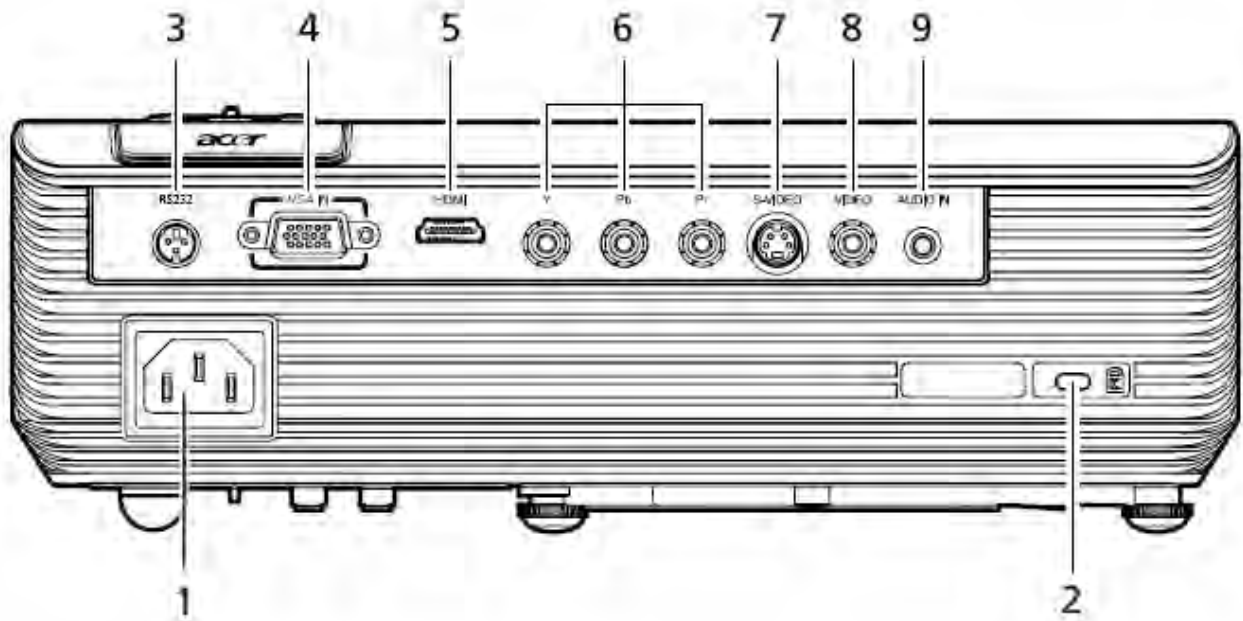





Item	Description	Item	Description
1	Power socket	6	YPbPr input connector
2	Kensington™ lock port	7	S-Video input connector
3	RS232 connector	8	Composite video input connector
4	PC analog signal/HDTV/component video input connector (VGA IN 1 or VGA IN)	9	Audio input connector
5	HDMI connector		

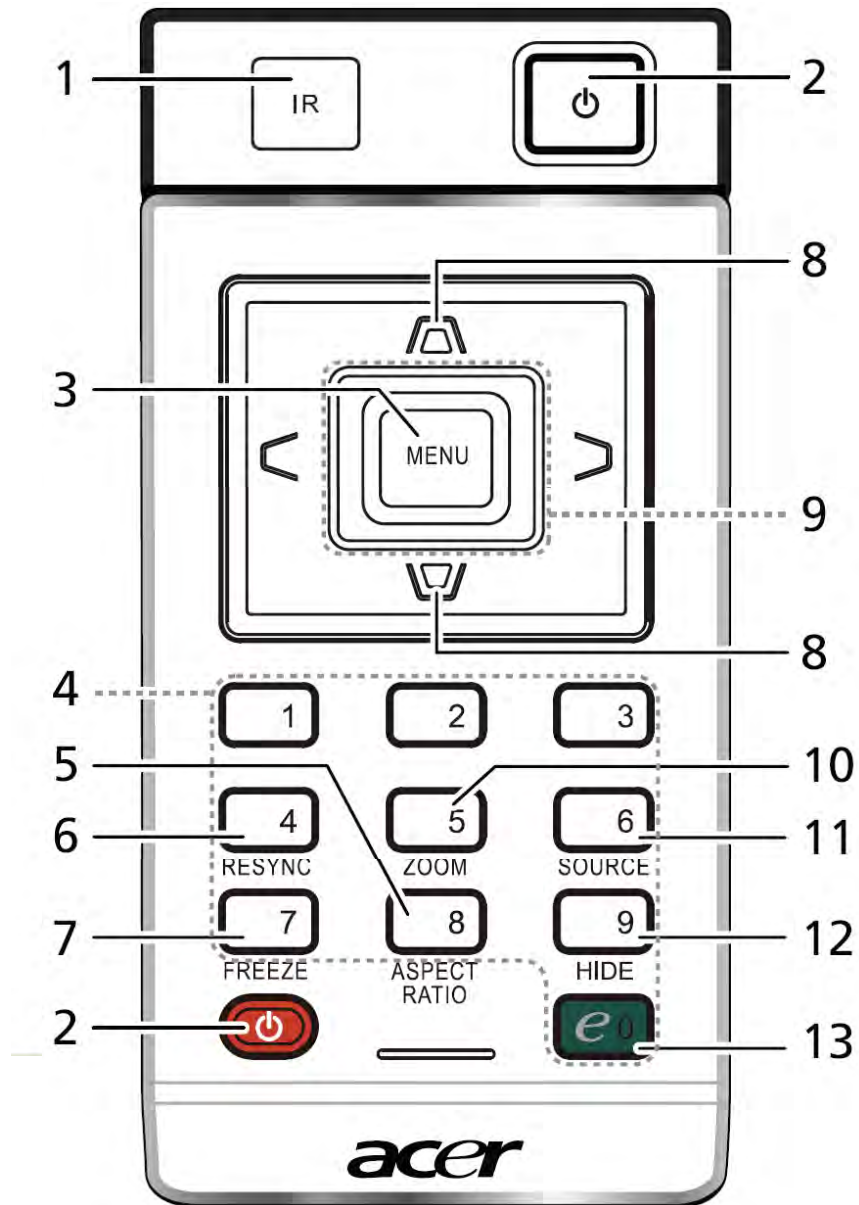

.....

Remote Control and Control Panel Layout



Item	Icon	Function	Description
1		Remote control receiver	Receives signals from remote control.
2		POWER	Refer to the "Turning the Projector On/Off" section.
3		MENU	<ul style="list-style-type: none"> • Press "MENU" to launch the Onscreen display (OSD) menu, back to the previous step for the OSD menu operation or exit the OSD menu. • Confirm your selection of items.
4		KeyPad 0~9	Press "0~9" to input a password in the "Security".
5		KeyPad 0~9	To choose the desired aspect ratio (Auto/4:3/16:9).
6		RESYNC	Automatically synchronizes the projector to the input source.
7		FREEZE	To pause the screen image.
8		KEystone	Adjusts the image to compensate for distortion caused by tilting the projector (± 40 degrees).
9		Four directional select keys	Use up, down, left, right buttons to select items or make adjustments to your selection.
10		ZOOM	Zooms the projector display in or out.
11		SOURCE	Changes the active source.
12		HIDE	Momentarily turns off the video. Press "HIDE" to hide the image, press again to display the image.
13		Empowering key	Unique Acer functions: eView, eTimer, ePower Management.

Note:

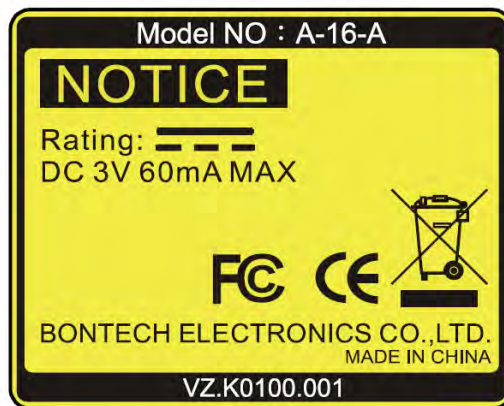

Getting Started

Connecting the Projector

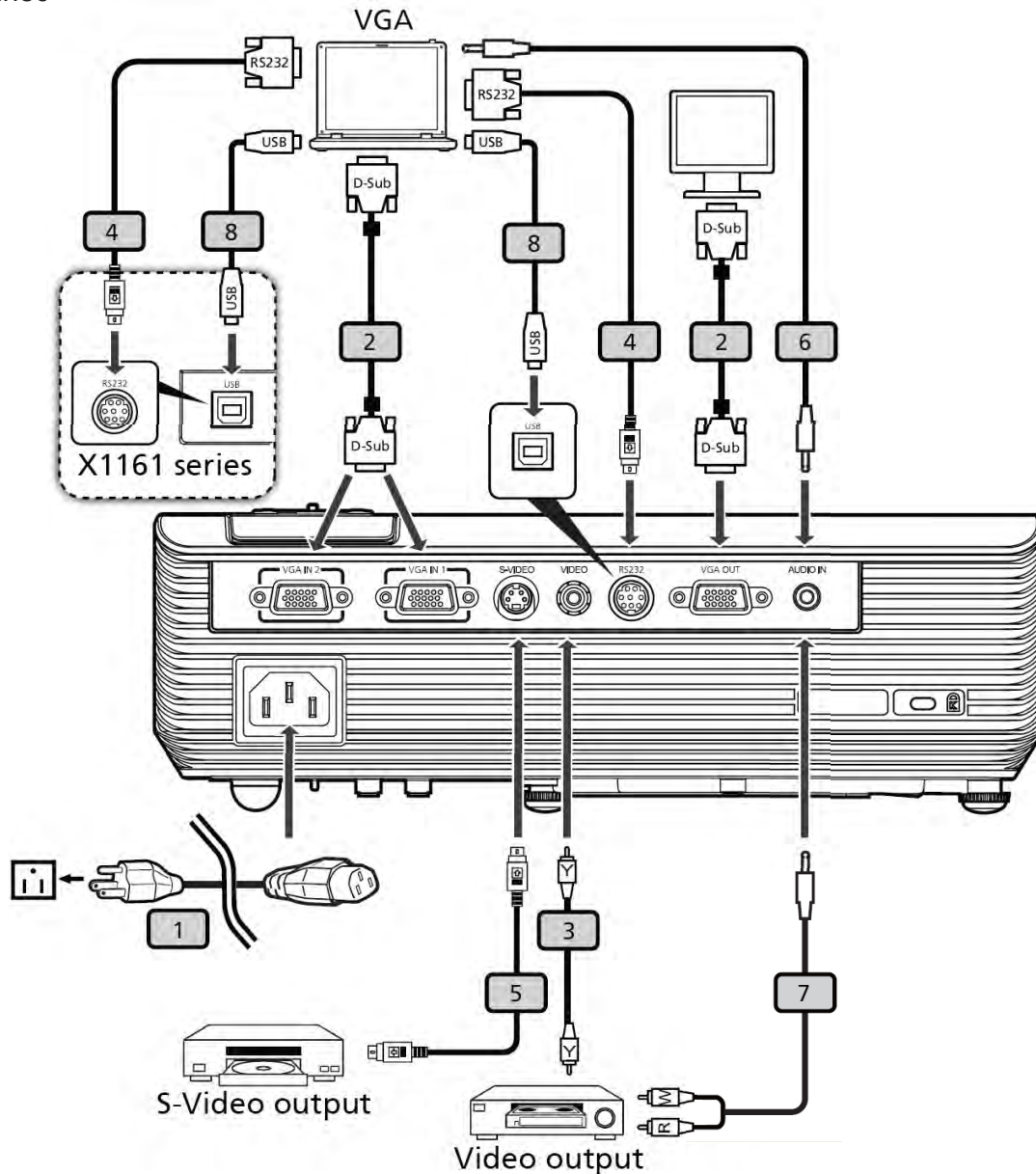

Item	Description	Item	Description
1	Power cord	6	S-Video cable
2	VGA cable	7	Audio cable jack/jack
3	Composite video cable	8	Audio cable jack/RCA
4	RS232 cable	9	USB cable



Note: To ensure the projector works well with your computer, please make sure the timing of the display mode is compatible with the projector.

System Block Diagram (for X1161/X1161A/X110)

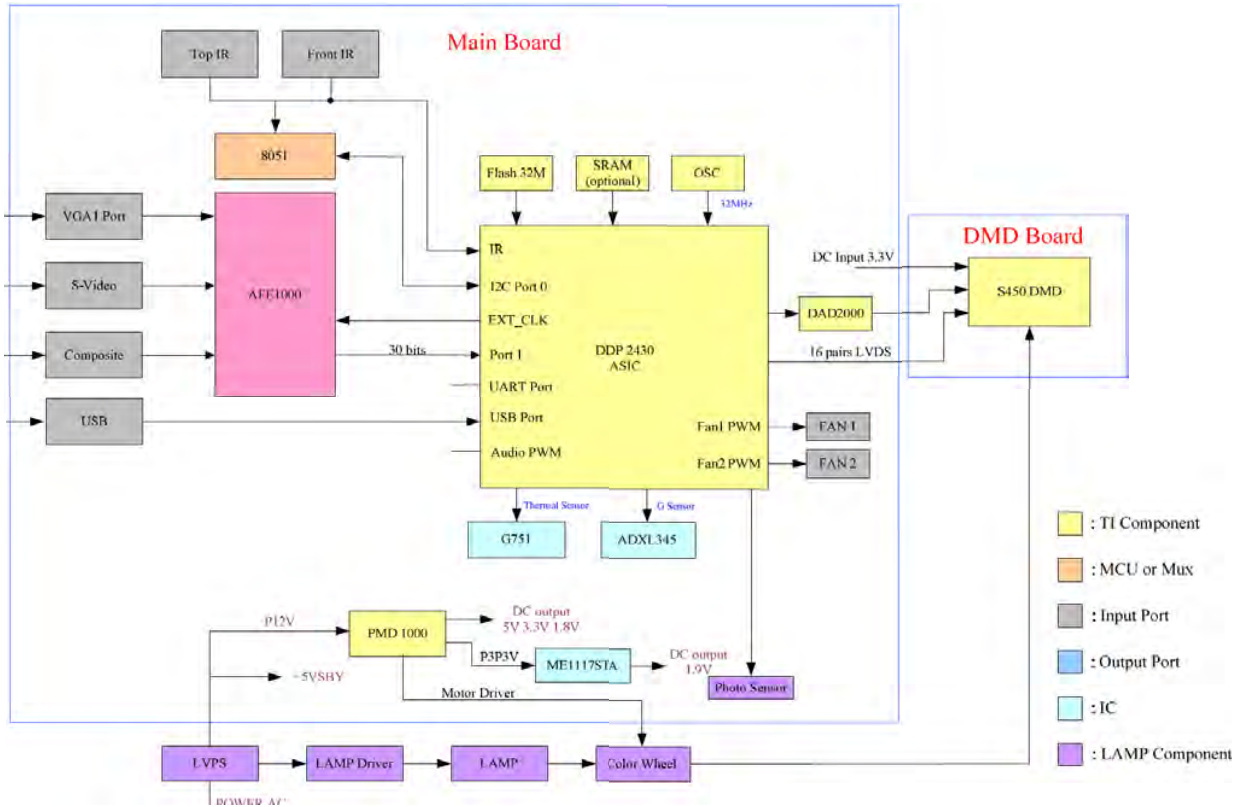

System Block Diagram (for X1261)

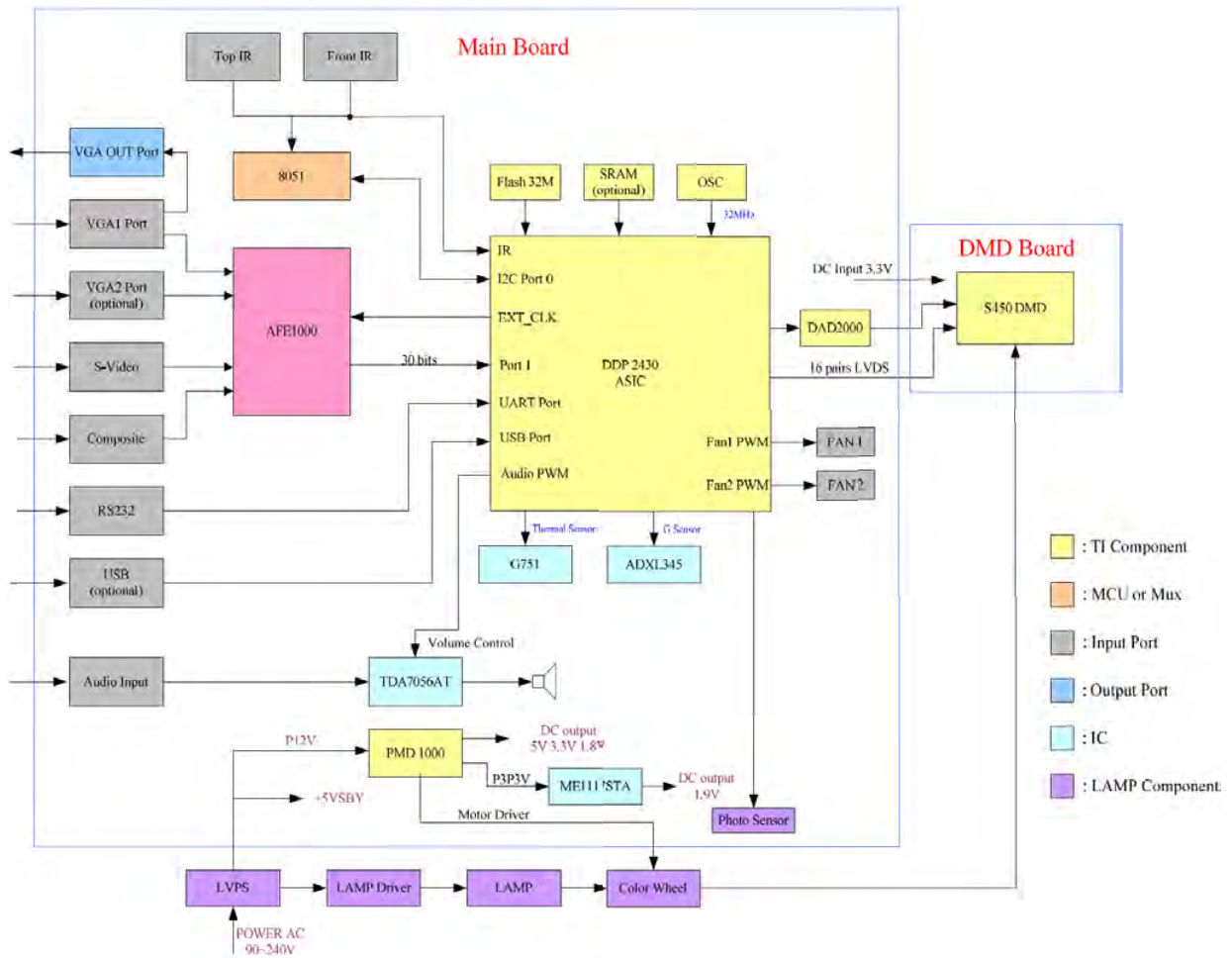

System Block Diagram (for H5360)

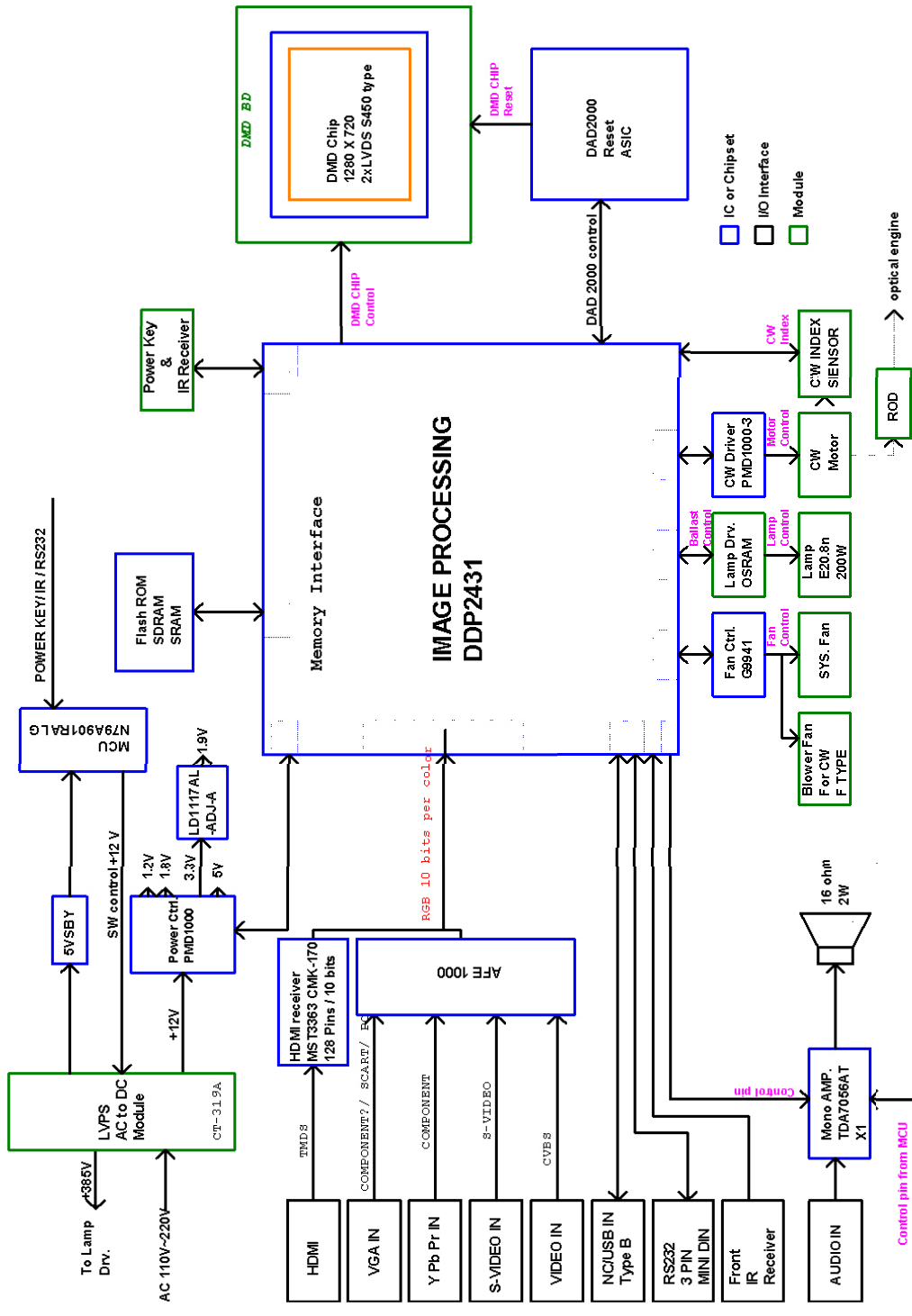

Bottom Cover Dimension

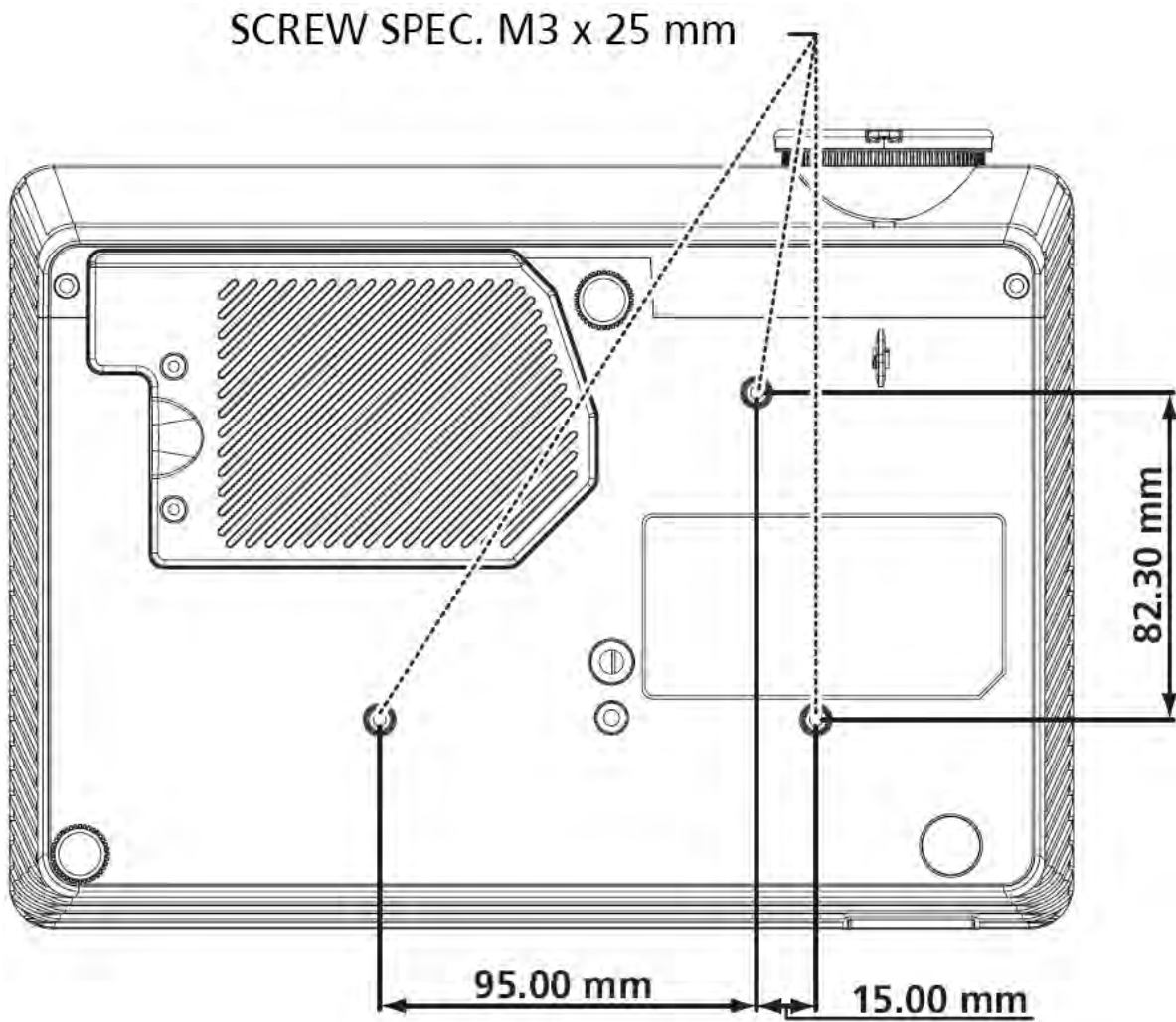

Disassembly & Assembly Process

2-1 Equipment Needed & Product Overview

1. Screw Bit (+): 105
2. Screw Bit (+): 107
3. Screw Bit (-): 107
4. Hex Sleeves 5mm
5. Long Nose Nipper
6. Tweezers
7. Projector

** Before you start: This process is protective level II. Operators should wear electrostatic chains.*

** Note: - If you need to replace the Main Board, you have to get into Service Mode and record the lamp usage hour, please refer to section 2-21.*

- As the process of X1161/ X1161A/X1161N/X110/H5360 disassembling is the same as X1261, we take X1261 for example here.



2-2 Disassemble Lamp Cover Module

1. Loosen 2 screws (as red circle) on the Lamp Cover.
2. Disassemble the Lamp Cover Module.



2-3 Disassemble Lamp Module

1. Loosen 2 screws (as red circle) on the Lamp Module.
2. Take off the Lamp Module.

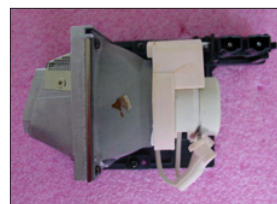
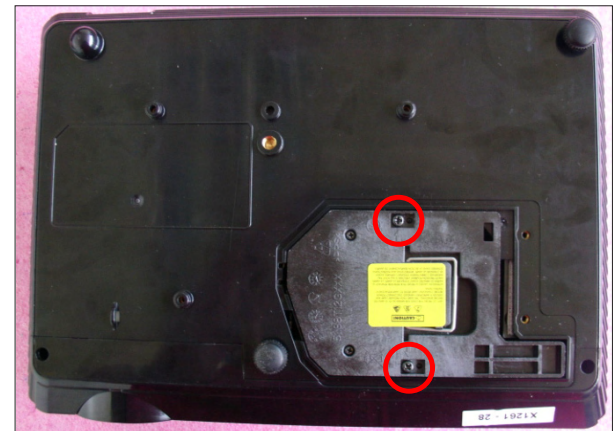

2-4 Disassemble Top Cover Module

1. Unscrew 2 screws (as red circle) from the Bottom Cover.
2. Remove the Top Cover Module.

Note: - When you remove the Top Cover, take care the 6 tenons (as green square).

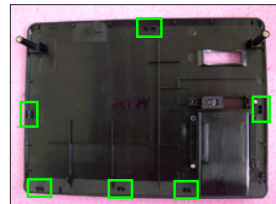

2-5 Disassemble Top Shielding

1. Unscrew 5 screws (as red circle) to disassemble the Top Shielding.

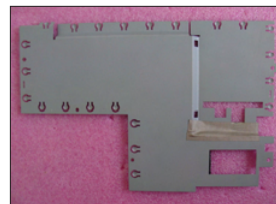
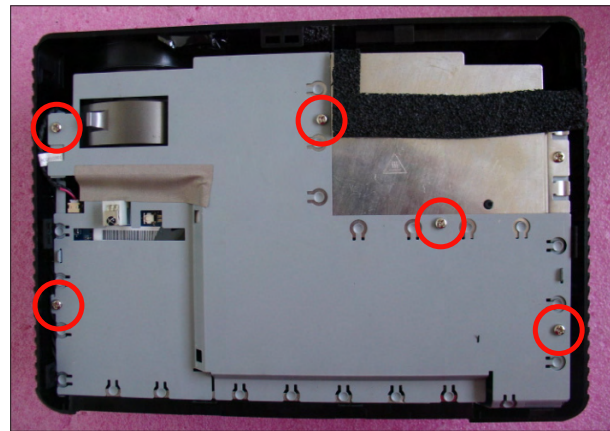

2-6 Disassemble Front Cover and IR Sensor Board

1. Unplug 1 connector (as yellow square).
2. Press two sides (as red arrows point) to unfasten 2 tenons (as green square).
3. Remove the Front Cover.

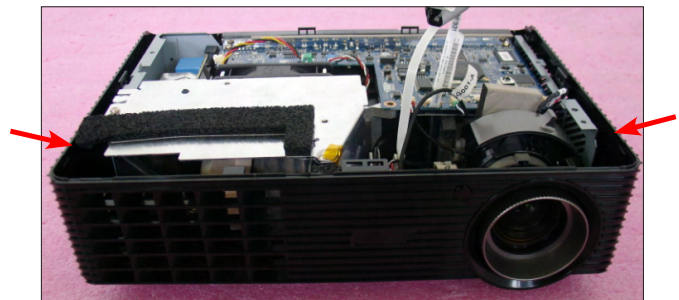
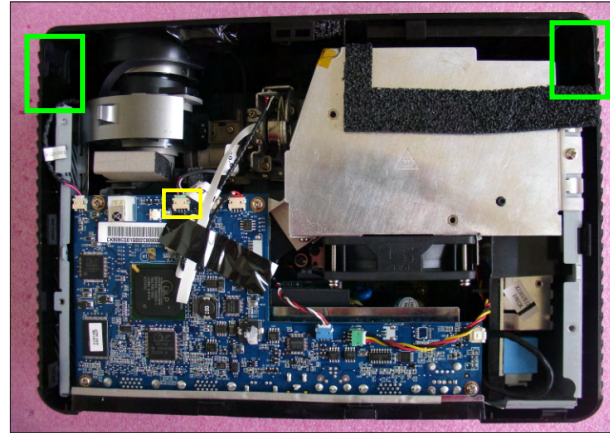

4. Tear off the mylar (as blue square).
5. Unscrew 2 screws (as red circle).
6. Remove the IR Sensor Board and IR Cap.

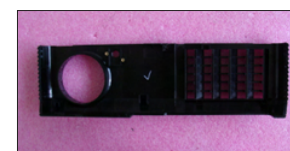
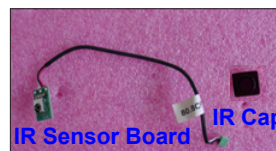
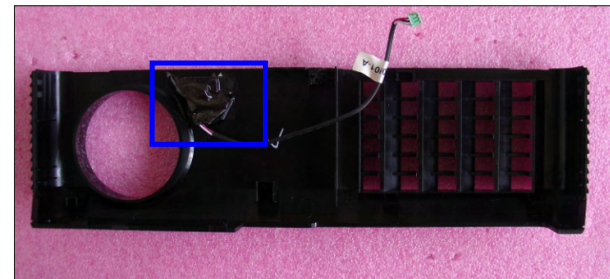

2-7 Disassemble Main Board Module and IO Cover Module

1. Tear off 3M tape (as green square).
2. Unplug 6 connectors (as yellow square).
3. Unscrew 2 screws (as red circle).

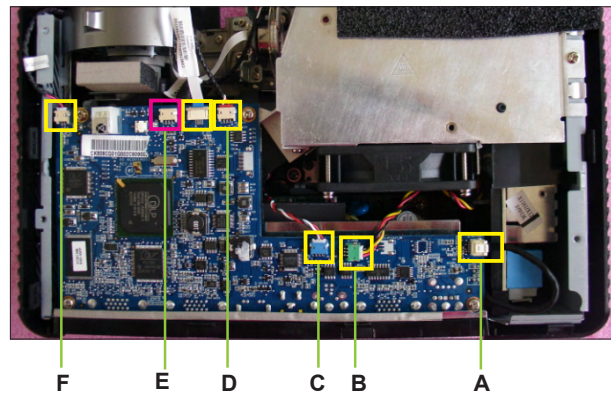
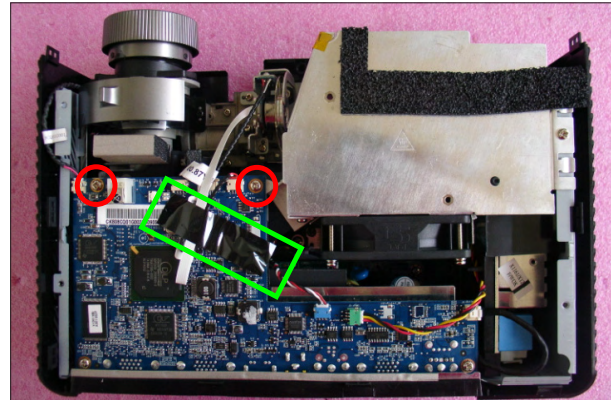

Please refer to the table as below for details of each connector.

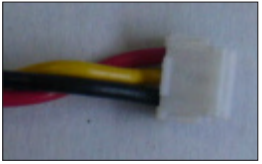
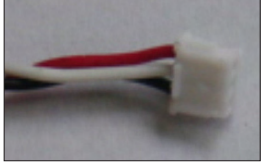
Item	Male Connector on Main Board	The key feature	Figure
A	Lamp Driver	Black wire tube (5 pin)	
B	System Fan	Compose of Red/Yellow/Black Wire (3 pin)	
C	Blower	Compose of Red/Black/White Wire (3 pin)	

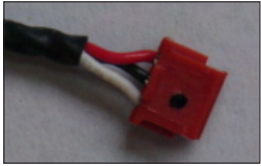
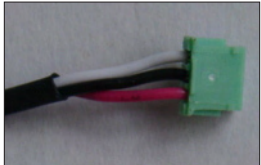
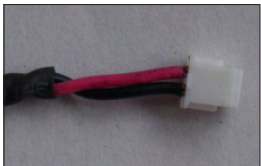
Item	Male Connector on Main Board	The key feature	Figure
D	Photo Sensor	Compose of Red/Black/White Wire and Black wire tube (3 pin)	
E	IR	Compose of Red/Black/Whit Wire and Black wire tube (3 pin)	
F	Speaker (for X1261/H5360)	Compose of Red/Black Wire and Black wire tube (2 pin)	

4. Unplug 1 connector (as blue square).
5. Disassemble the Main Board Mouldle.
6. Unscrew 2 screws (as green circle).

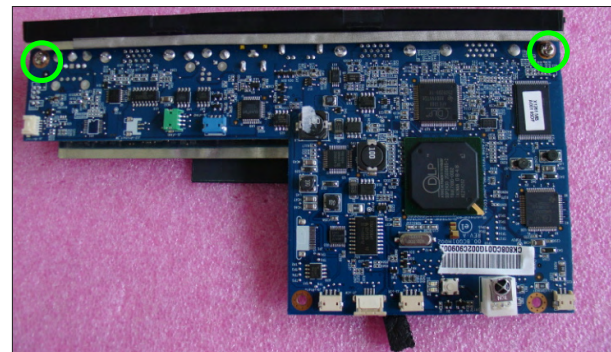
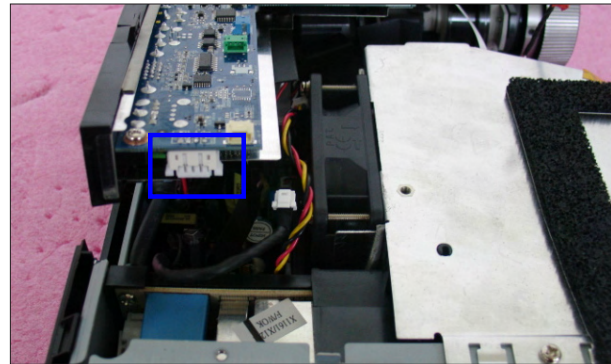

7. Unscrew 4 hex screws (as blue circle).
8. Separate the Main Board and IO Cover Module.

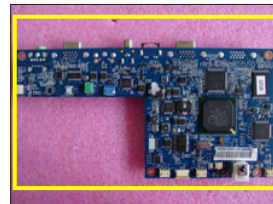
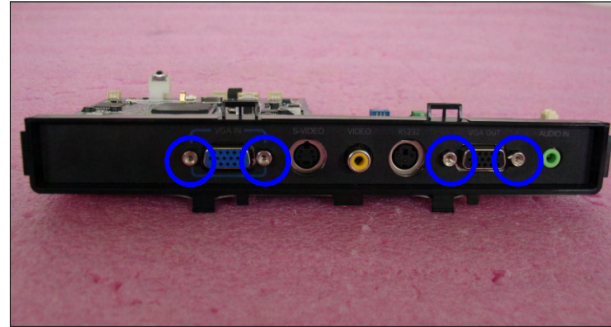

IO Cover



NOTE: Circuit boards > 10 cm² has been highlighted with the yellow rectangle as above image shows. Please detach the Circuit boards and follow local regulations for disposal.

2-8 Disassemble Engine Module

1. Tear off EMI Gasket (as green square).
2. Unscrew 4 screws (as yellow circle) to disassemble the Engine Module.

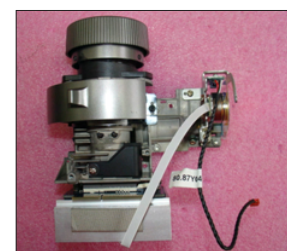
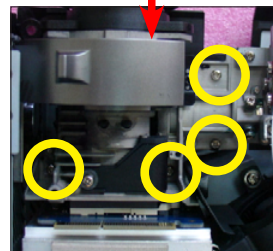
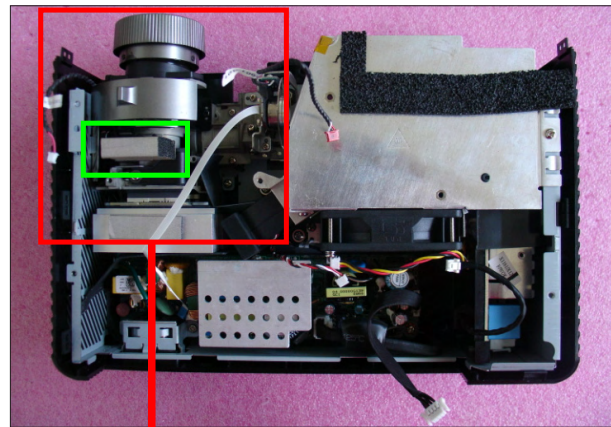

2-9 Disassemble Color Wheel Module

1. Unscrew 2 screws (as red circle) to disassemble the Color Wheel Module.
2. Unscrew 1 screw (as blue circle) to disassemble the Photo Sensor Board from the Color Wheel Module.

Note: - Avoid touching the glass parts of Color Wheel.

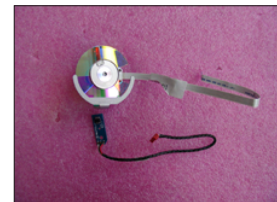
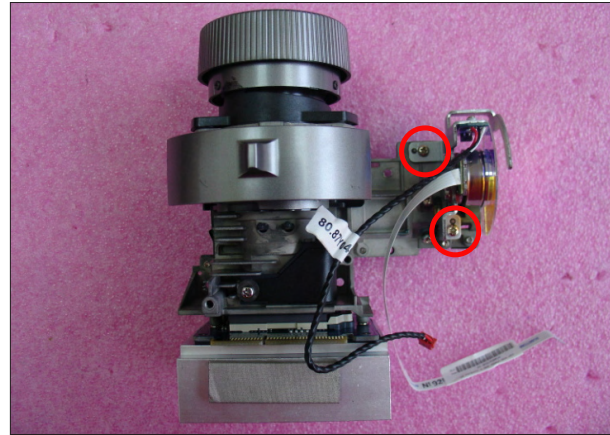

2-10 Disassemble DMD Chip and DMD Board

1. Unscrew 2 screws (as red circle) to disassemble the Heat Sink and DMD Module.
2. Rotate the screw (as yellow circle) 180° counterclockwise to disassemble the DMD Board and DMD Chip.

Note: - Avoid touching the DMD Chip when you disassemble it.

- Pay attention to the fixed position when assembling the DMD Chip.

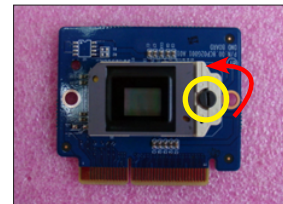
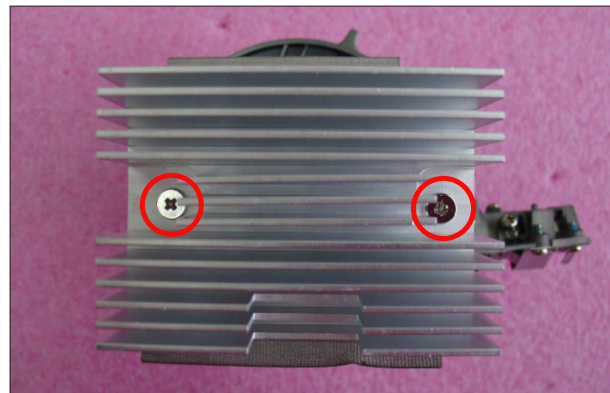

NOTE: Circuit boards > 10 cm² has been highlighted with the yellow rectangle as above image shows. Please detach the Circuit boards and follow local regulations for disposal.



2-11 Disassemble Zoom Ring

1. Unscrew 2 screws (as red circle) to disassemble the Zoom Ring and Zoom Ring Fixed Holder.

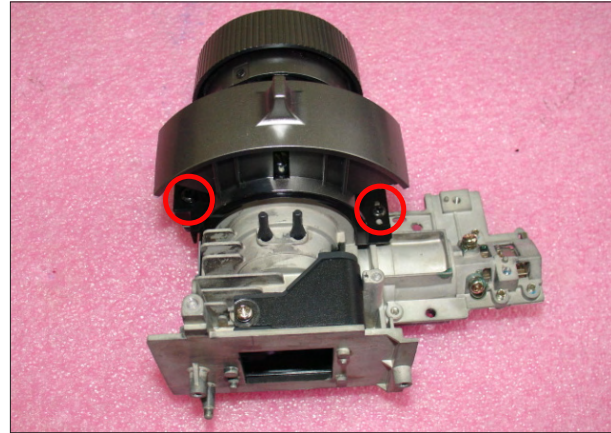

Zoom Ring



Zoom Ring Fixed Holder

2-12 Disassemble Focus Ring

1. Unscrew 3 screws (as red circle) to disassemble the Focus Ring.

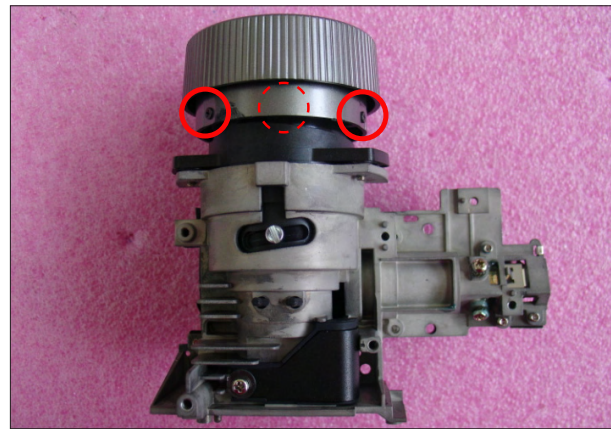

Focus Ring



2-13 Disassemble System Fan Module

1. Unscrew 3 screws (as red circle) to disassemble the Fan Module.
2. Tear off the EMI tape (as green square).
3. Disassemble the System Fan Module.

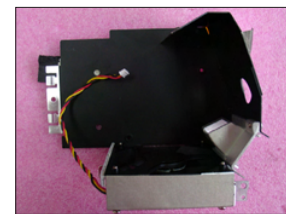
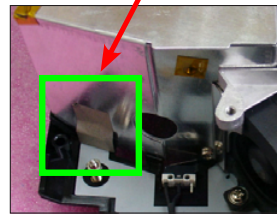
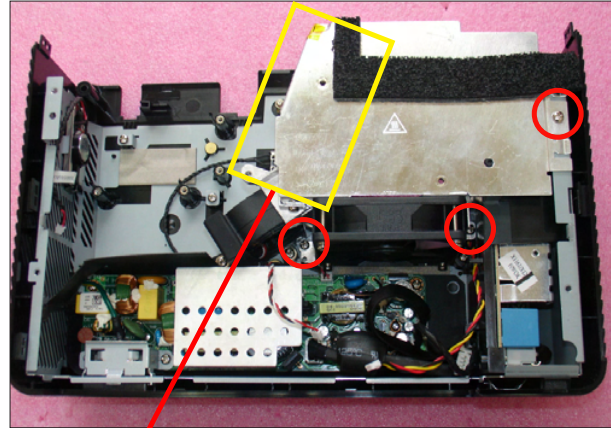

4. Unscrew 4 screws (as blue circle) to separate System Fan and Fan Shielding.

Note: - Take the Fan Module as the right gesture.

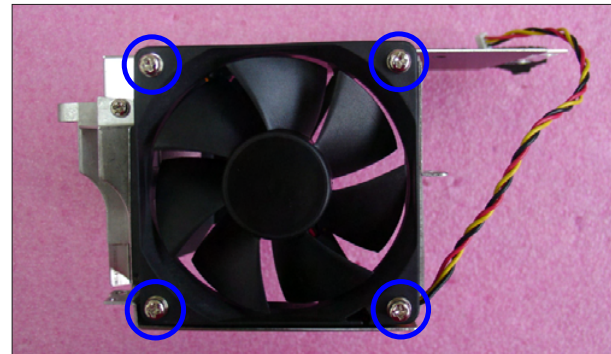

System Fan



Fan Shielding



the right gesture



the wrong gesture

2-14 Disassemble Blower

1. Unscrew 3 screws (as red circle).
2. Disassemble the Blower.

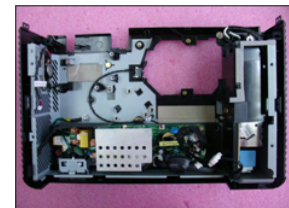
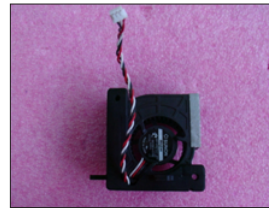
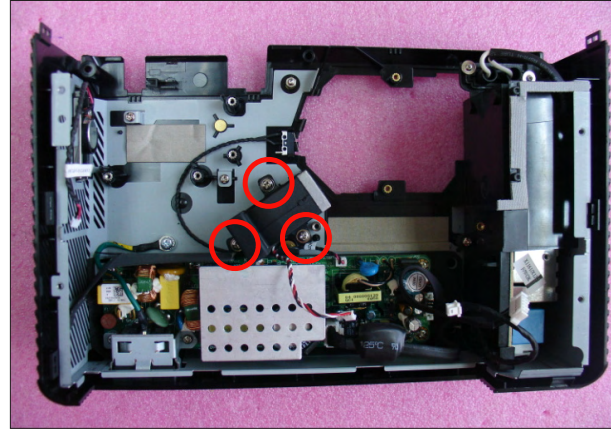

2-15 Disassemble LVPS Module

1. Unplug 2 connectors (as yellow square).
2. Unscrew 6 screws (as red circle).
3. Disassemble the LVPS Module and the AC Inlet Bracket.
4. Unplug 1 connector (as green square).

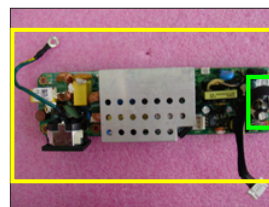
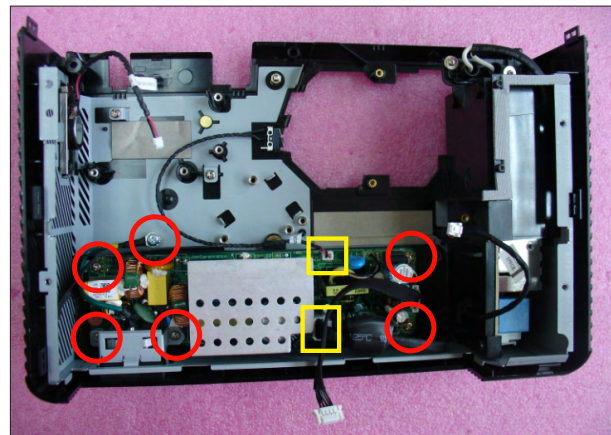

NOTE: Circuit boards > 10 cm² has been highlighted with the yellow rectangle as above image shows. Please detach the Circuit boards and follow local regulations for disposal.



AC Inlet Bracket

2-16 Disassemble Lamp Driver Module

1. Unscrew 1 screw (as red circle) to disassemble the Lamp Driver Module.
2. Unscrew 2 screws (as blue circle).

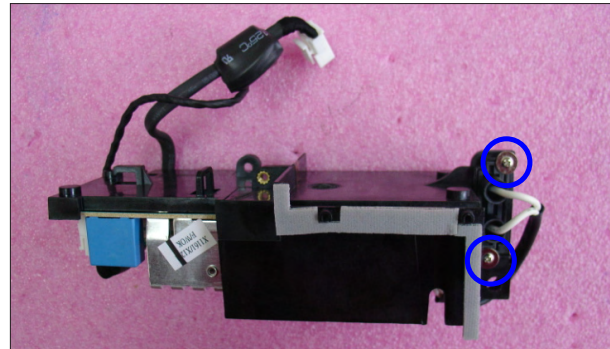
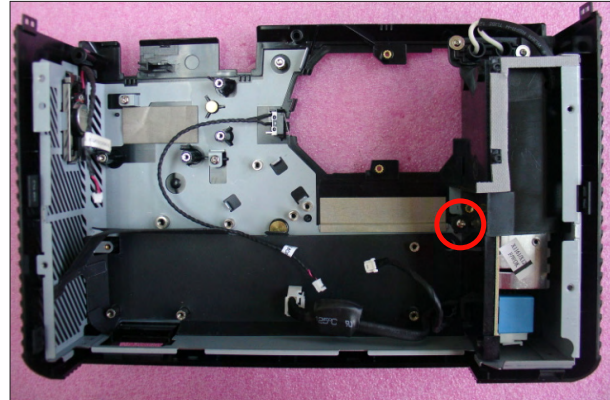

3. Unplug 3 connectors (as green square) to disassemble the cables from Lamp Driver Module.
4. Unscrew 4 screws (as yellow circle) to disassemble the Lamp Driver Module and Lamp Driver Holder.

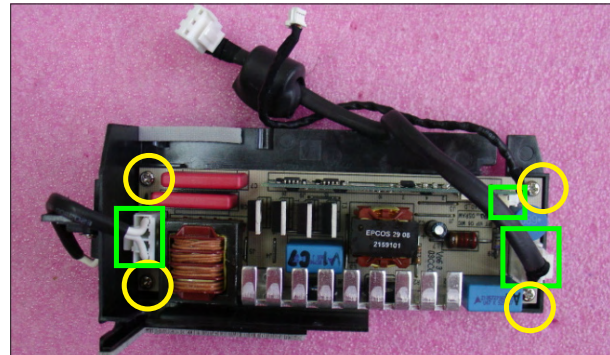

NOTE: Circuit boards > 10 cm² has been highlighted with the yellow rectangle as above image shows. Please detach the Circuit boards and follow local regulations for disposal.

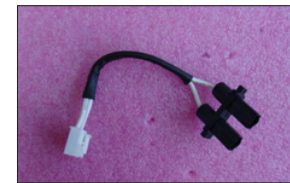

Lamp Driver to Lamp Cable

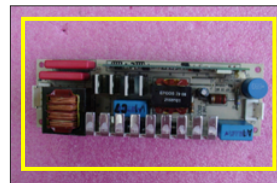

Lamp Driver Holder

2-17 Disassemble Interrupt Switch

1. Unfasten 2 tenons (as green square) to disassemble the Interrupt Switch.

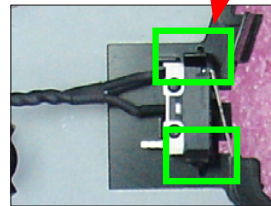
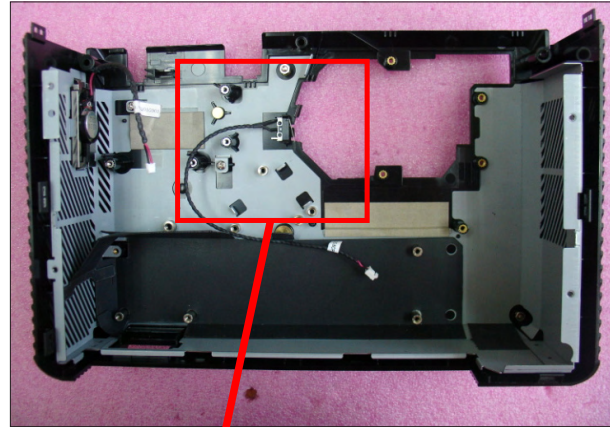

Interrupt Switch

2-18 Disassemble Bottom Shielding

1. Tear off the EMI tapes (as yellow square).
1. Unscrew 2 screws (as red cricle) to disassemble the Bottom Shielding.

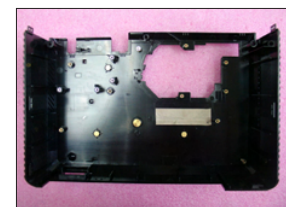
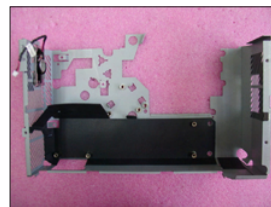
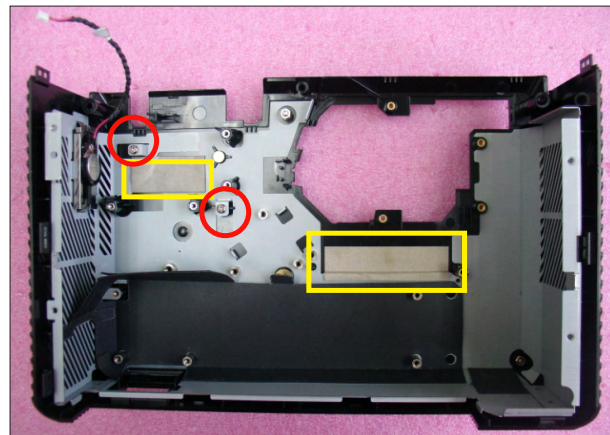

2-19 Disassemble Speaker (for X1261/H5360)

1. Unfasten 2 tenons (as green square) as blue arrows point to disassemble the Speaker.

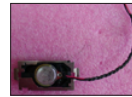
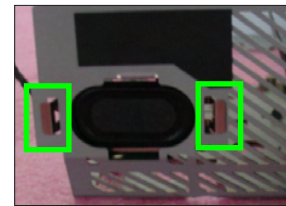
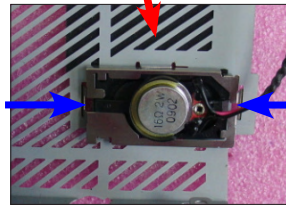
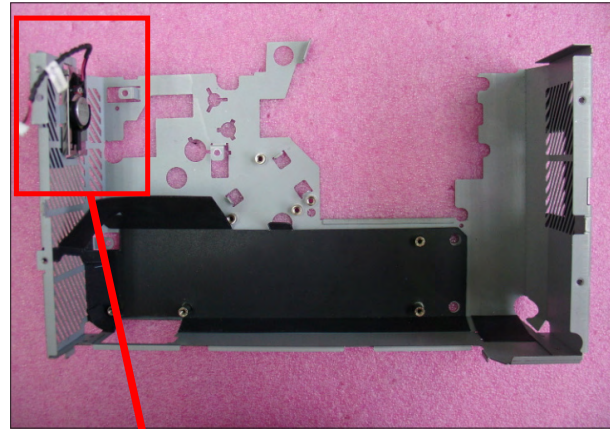

2-20 Rod Adjustment

1. Environment Adjustment
 - The distance between the engine and the screen is 2.38 M.
 - This process should be done at a dark environment (under 2 Lux).
2. Procedure Adjustment
 - Change the screen to "white screen".
 - Adjust the screws by using the rod on the engine module to readjust the image.
(“Screw 1” should be adjusted first, and then “screw 2”. Adjust until the yellowish or bluish parts disappeared.)

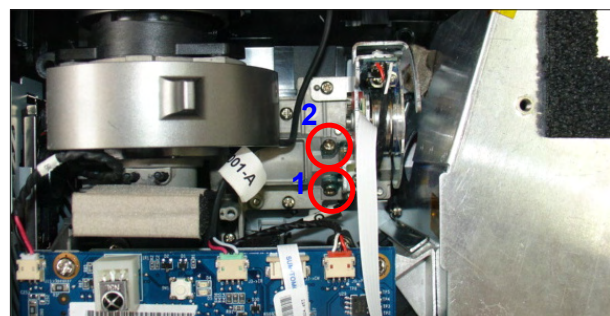
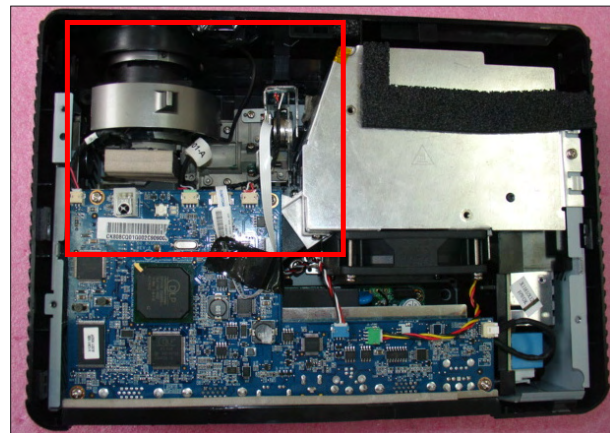

3. Abnormal image inspection

- It should not have any abnormal color at the frame of the image by estimating through the eyes.

Note: - To avoid over adjusting the rod.

- *After the operation, please use the glue to fix the screws.*

2-21 Re-write System and Lamp Usage Hour

1. Get into Service Mode

- Press "Power", "Left", "Left" and "Menu" buttons sequentially to get into Service Mode.

2. Get into Other Settings Mode

- Use "Up" or "Down" buttons to select "Other Settings", then press "Menu" button.

3. Re-write System Hours

- Select "System Hours Adjust" and use "Left" or "Right" buttons to re-write the "System Hours (full)".

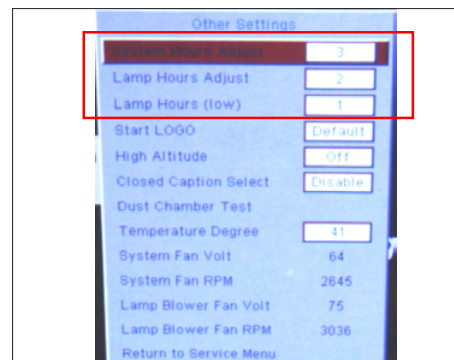
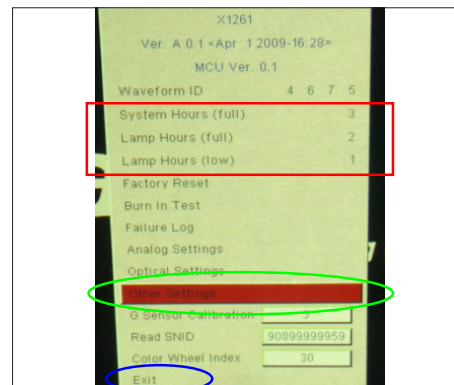

4. Re-write Lamp Hours (Full power mode)

- Select "Lamp Hours Adjust" and use "Left" or "Right" buttons to re-write the "Lamp Hours (full)".

5. Re-write Lamp Hours (ECO mode)

- Select "Lamp Hours" and use "Left" or "Right" buttons to re-write the "Lamp Hours (low)".

6. Exit Service Mode

- Use "Up" or "Down" buttons to select "Exit", press "Menu" button to exit the Service Mode.

*Note: left key = decrease System/Lamp hour
right key =increase System/Lamp hour*

2-22 Assemble Speaker (for X1261/H5360)

1. Fasten 2 tenons (as green square) as blue arrows point to assemble the Speaker.

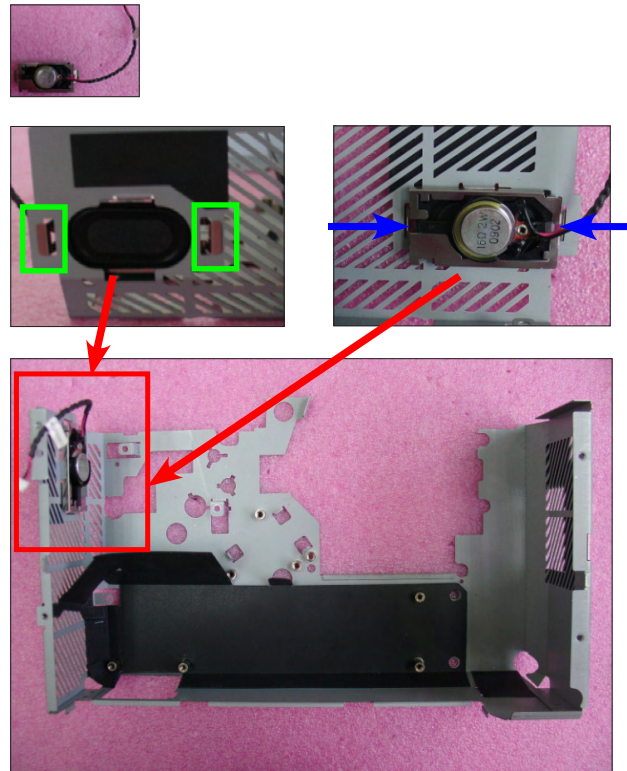

2-23 Assemble Bottom Shielding

1. Screw 2 screws (as red circle) to assemble the Bottom Shielding.
2. Stick the EMI tapes (as yellow square).

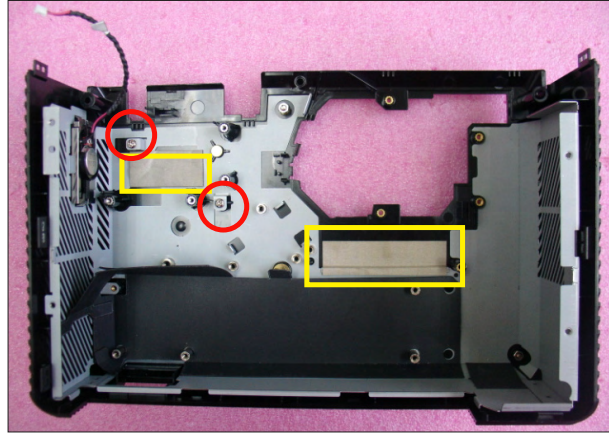
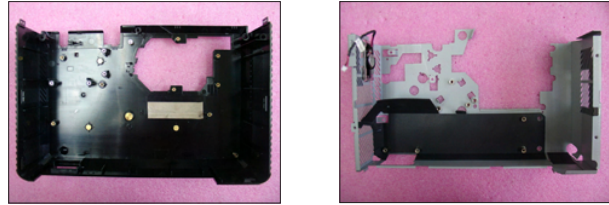

2-24 Assemble Interrupt Switch

1. Fasten 2 tenons (as green square) to assemble the Interrupt Switch.

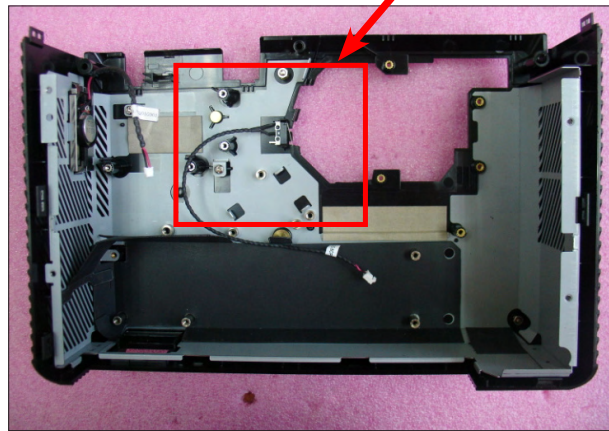
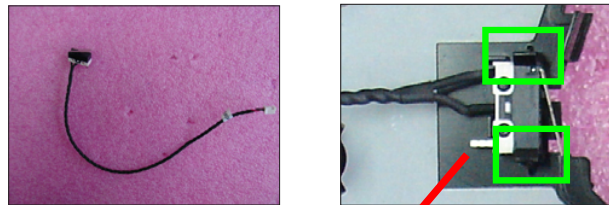

2-25 Assemble Lamp Driver Module

1. Screw 4 screw (as yellow circle) to assemble the Lamp Driver Module and Lamp Driver Holder.
2. Plug 3 connectors (as green square) to assemble the cables on Lamp Driver Module.

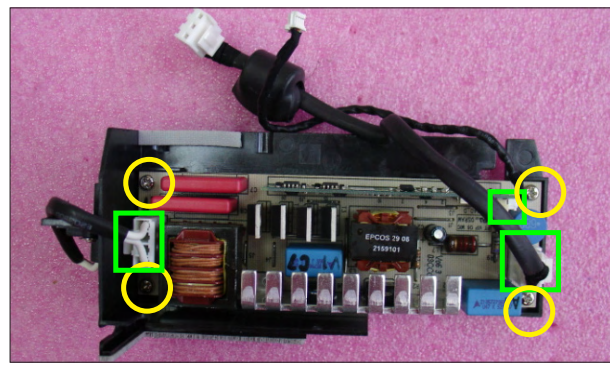
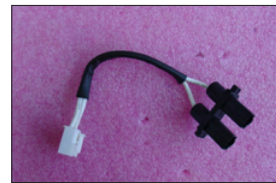
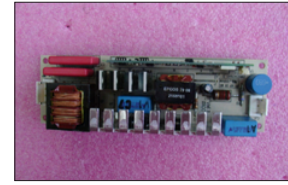
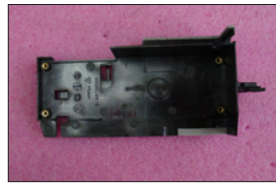

3. Screw 2 screws (as blue circle).
4. Screw 1 screw (as red circle) to assemble the Lamp Driver Module.

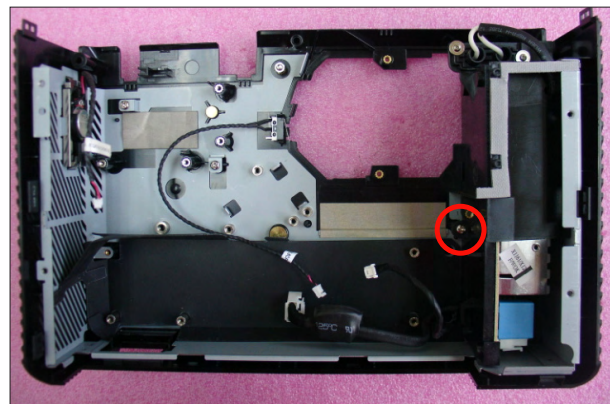
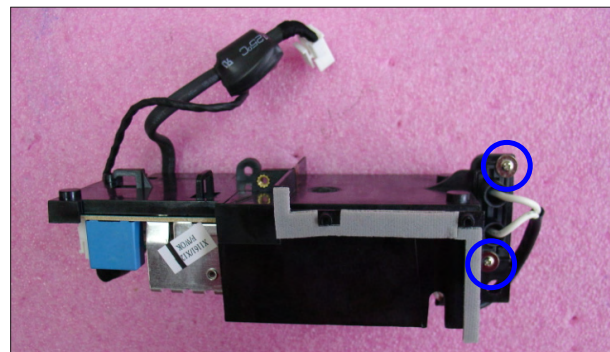

2-26 Assemble LVPS Module

1. Plug 1 connector (as green square).
2. Assemble the LVPS Module and the AC Inlet Bracket.
3. Screw 6 screws (as red circle).
4. Plug 2 connectors (as yellow square).

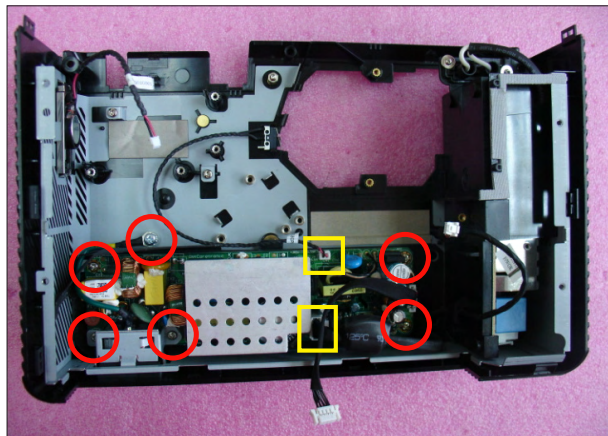
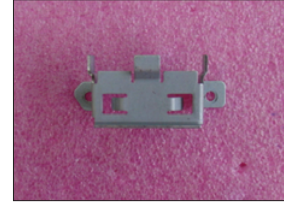
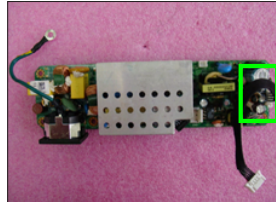

2-27 Assemble Blower

1. Assemble the Blower.
2. Screw 3 screws (as red circle).

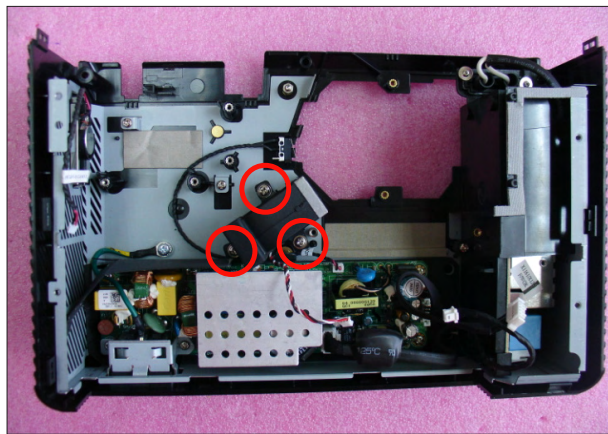
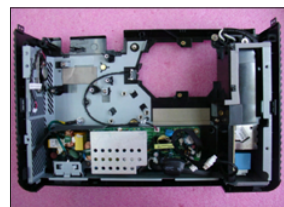
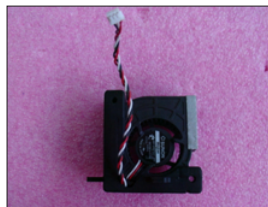

2-28 Assemble System Fan Module

1. Screw 4 screws (as blue circle) to assemble System Fan and Fan Shielding.

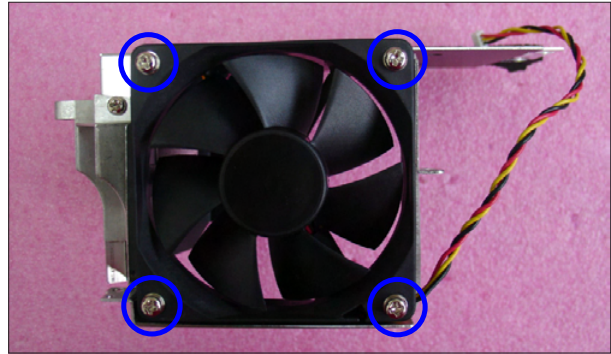
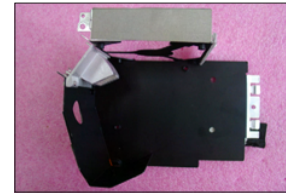

2. Assemble the System Fan Module.
3. Stick the EMI tape (as green square).
4. Screw 3 screws (as red circle) to assemble the Fan Module.

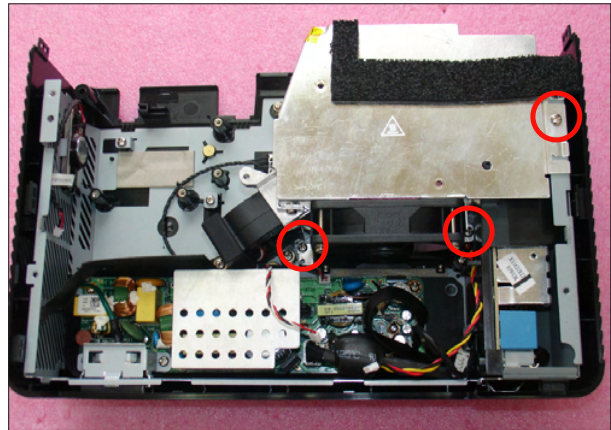
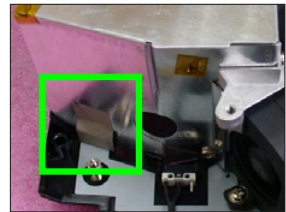

2-29 Assemble Focus Ring

1. Screw 3 screws (as red circle) to assemble the Focus Ring.

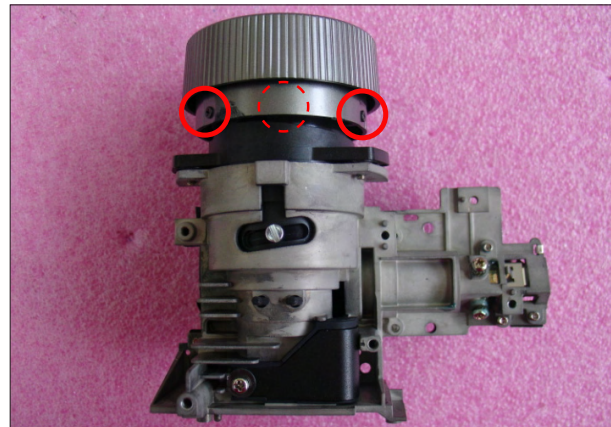
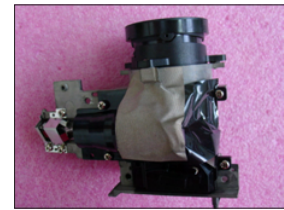

2-30 Assemble Zoom Ring

1. Screw 2 screws (as red circle) to assemble the Zoom Ring and Zoom Ring Fixed Holder.

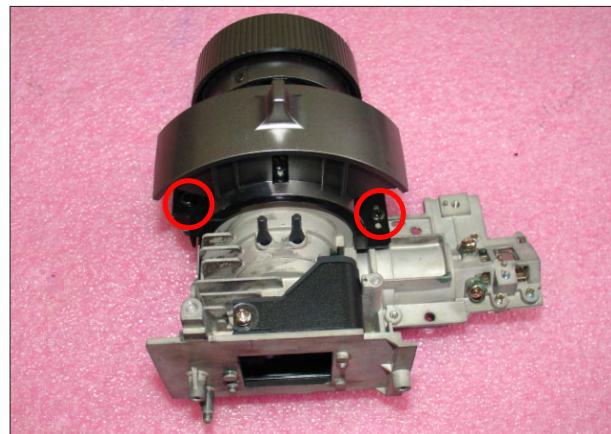

2-31 Assemble DMD Chip and DMD Board

1. Rotate the screw (as yellow circle) 180° clockwise to assemble the DMD Board and DMD Chip.
2. Screw 2 screws (as red circle) to assemble the Heat Sink and DMD Module.

Note: - Avoid touching the DMD Chip.

- Pay attention the fixed position when assembling the DMD Chip.

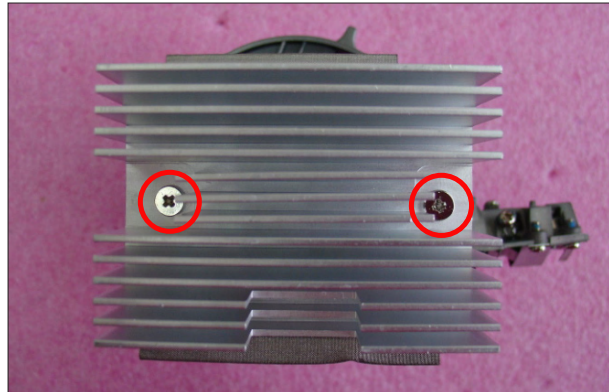
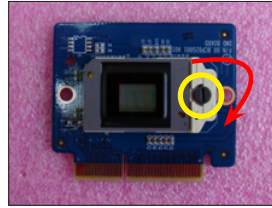
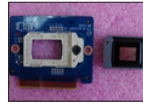

2-32 Assemble Color Wheel Module

1. Screw 1 screw (as blue circle) to assemble the Photo Sensor Board on the Color Wheel Module.
2. Screw 2 screws (as red circle) to assemble the Color Wheel Module on Engine Module.

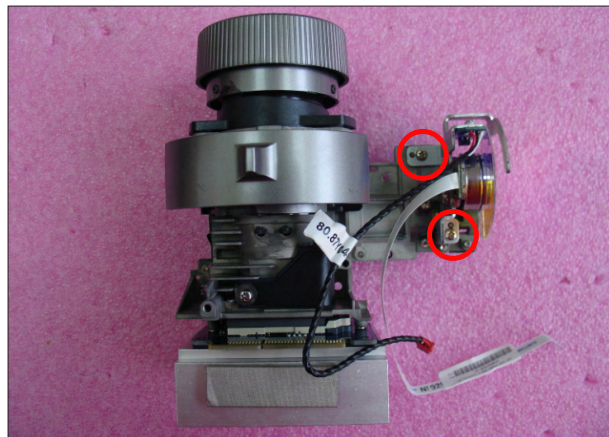
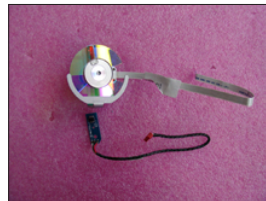

2-33 Assemble Engine Module

1. Screw 4 screws (as yellow circle) to assemble the Engine Module.
2. Stick the EMI Gasket (as green square).

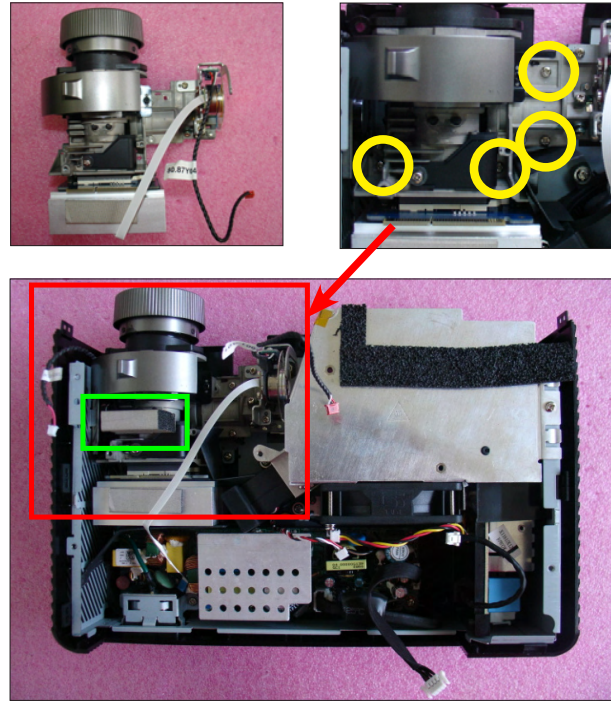

2-34 Assemble IO Cover and Main Board Module

1. Assemble the IO Cover and Main Board Module.
2. Screw 4 hex screws (as blue circle).

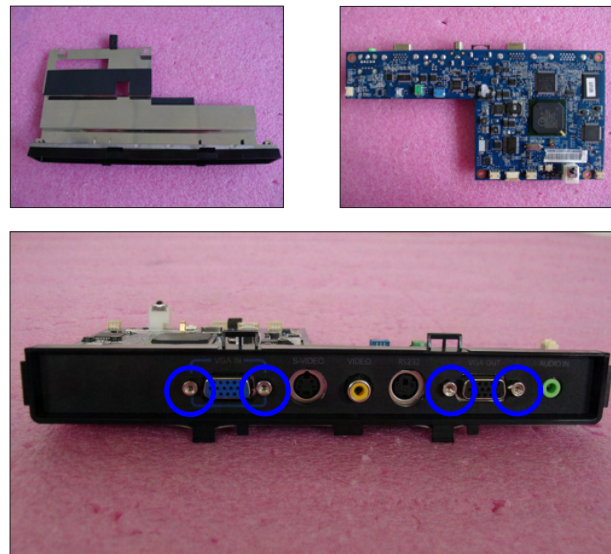

3. Screw 2 screws (as green circle).
4. Assemble the Main Board Module.
5. Plug 1 connector (as blue square).

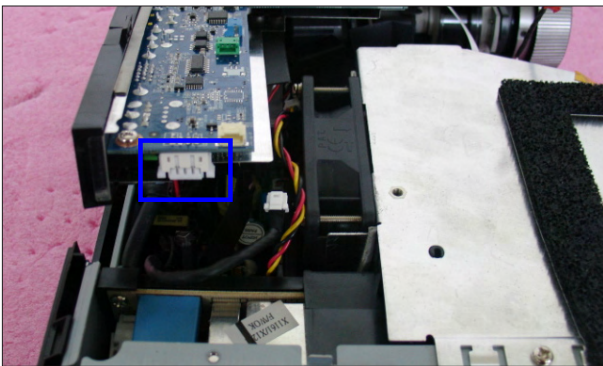
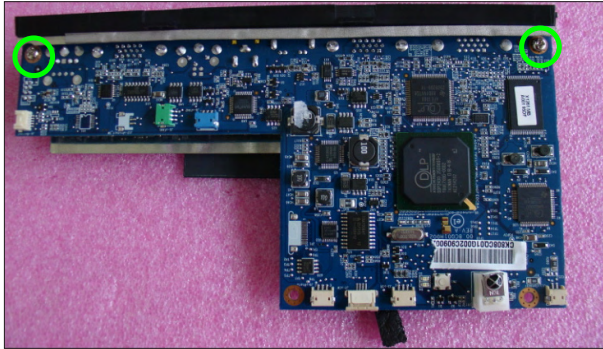

6. Screw 2 screws (as red circle).
7. Plug 6 connectors (as yellow square).
8. Stick 3M tape (as green square) on the Main Board Module.

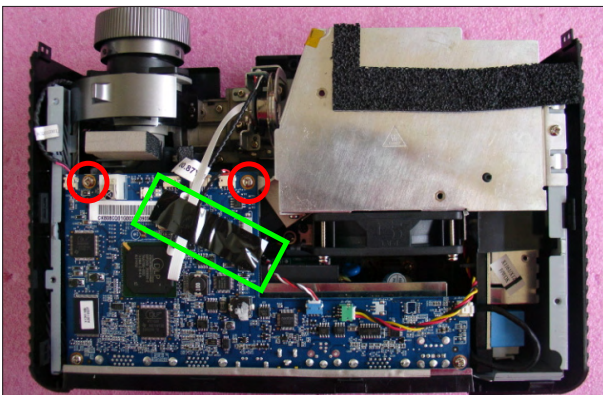
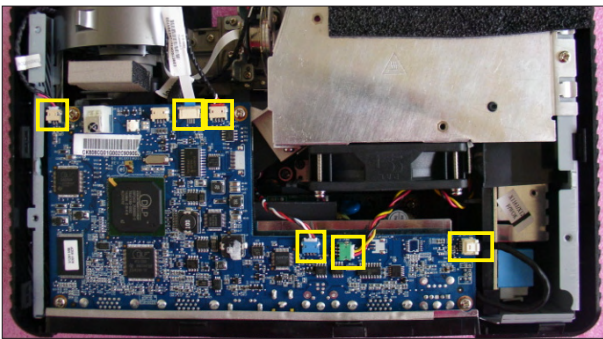

2-35 Assemble IR Sensor Board and Front Cover

1. Assemble the IR Sensor Board and IR Cap.
2. Screw 2 screws (as red circle).
3. Stick the mylar (as blue square).

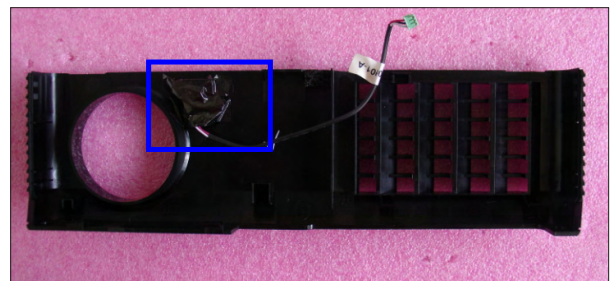
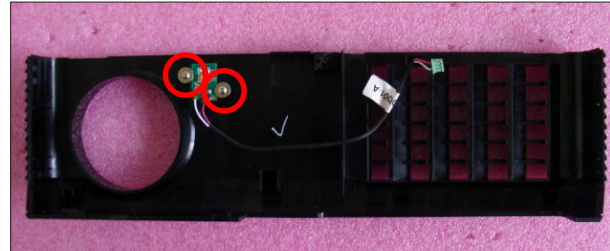

4. Assemble the Front Cover.
5. Press two sides (as red arrows point) to fasten 2 tenons (as green circle).
6. Plug 1 connector (as yellow square).

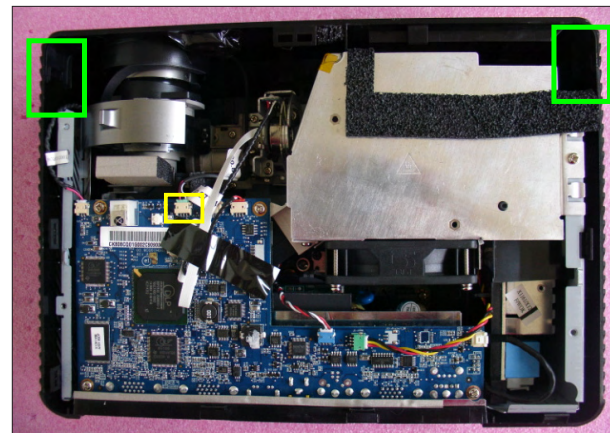
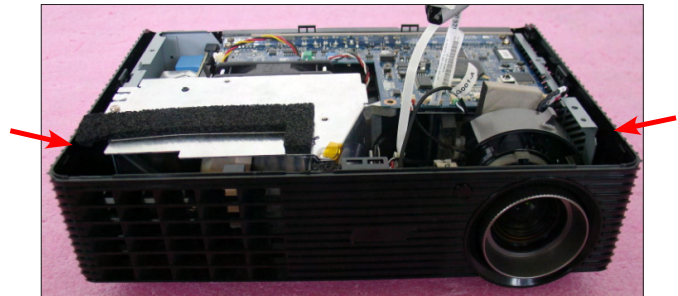

2-36 Assemble Top Shielding

1. Screw 5 screws (as red circle) to assemble the Top Shielding.

Note: Avoid pressuring the Speaker cable (as yellow square) when you assemble the Top shielding. (for X1261/H5360)

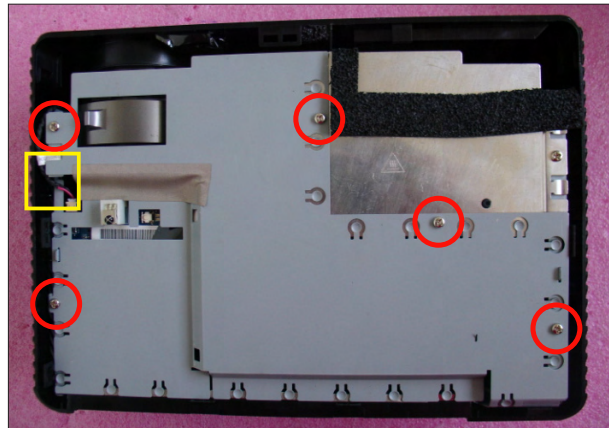
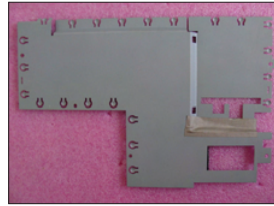

2-37 Assemble Top Cover Module

1. Assemble the Top Cover Module.

Note: Take care the 6 tenons (as green square) when you assemble the Top Cover.

2. Screw 2 screws (as red circle) on the Bottom Cover.

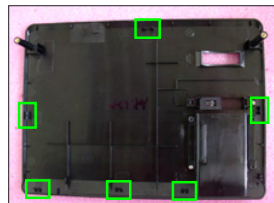

2-38 Assemble Lamp Module

1. Assemble the Lamp Module.
2. Tighten 2 screws (as red circle) on the Lamp Module.

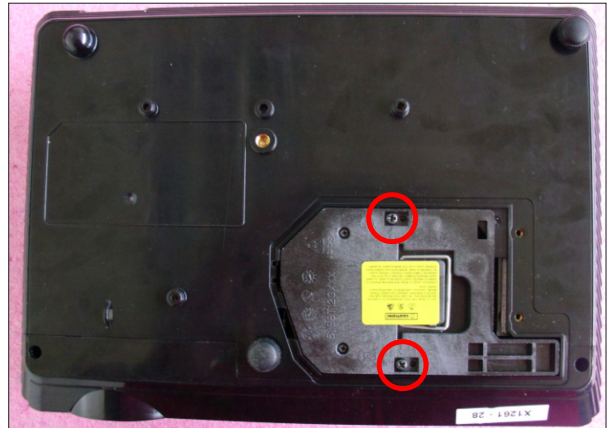
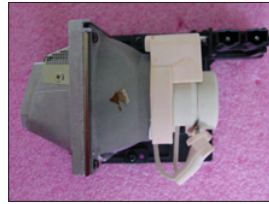

2-39 Assemble Lamp Cover Module

1. Assemble the Lamp Cover Module.
2. Tighten 2 screws (as red circle) on the Lamp Cover.



Troubleshooting

3-1 LED Lighting Message

Message	Power LED	
	Red	Blue
Input Power Plug	Flash ON to OFF 100ms	--
Standby	V	--
Power button ON	--	V
Lamp retry	--	0.5 second H(On), 0.5 second L(Off) flashing
Power off (Cooling state)	0.5 second H(ON), 0.5 second L(OFF) flashing	--
Power button OFF: Cooling completed; Standby Mode	V	--
Error (Thermal Failure)	0.5 second H(On), 0.5 second L(Off) flashing red twice, and blue LED ON 2 second, and by returns	
Error (Fan lock)	0.5 second H(On), 0.5 second L(Off) flashing red twice, and blue LED ON 2 second, and by returns	
Error (Lamp break- down)	0.5 second H(On), 0.5 second L(Off) flashing blue twice, and red LED ON 2 second, and by returns	
Error (Color Wheel Failure)	0.5 second H(On), 0.5 second L(Off) flashing blue twice, and red LED ON 2 second, and by returns	

Note: Steady Light: "V"



No Light: "--"

3-2 Main Procedure

No	Symptom	Procedure
1	No Power	<ul style="list-style-type: none"> - Ensure the Power Cord and AC Power Outlet are securely connected - Ensure all connectors are securely connected and aren't broken - Check LVPS - Check Lamp Driver - Check Main Board
2	Auto Shut Down	<ul style="list-style-type: none"> - Check LED Status <ul style="list-style-type: none"> a. Thermal/Fan Failure: Quick Flashing red twice and Steady blue by returns <ul style="list-style-type: none"> - Check Fan - Check Main Board b. Lamp/Color wheel Failure: Quick Flashing blue twice and Steady red by returns <ul style="list-style-type: none"> - Check Lamp - Check Lamp Driver - Check Color Wheel - Check Photo Sensor - Check Main Board
3	No Light On	<ul style="list-style-type: none"> - Ensure all connectors are securely connected and aren't broken - Check Lamp Cover, Interrupt Switch - Check Lamp Module - Check Lamp Driver - Check LVPS - Check Main Board - Check Color Wheel - Check Photo Sensor Board

No	Symptom	Procedure
4	No Image	<ul style="list-style-type: none"> - Ensure the Signal Cable and Source work (If you connect multiple sources at the same time, use the "Source" button switch) - Ensure all connectors are securely connected and aren't broken - Check Main Board - Check DMD Board - Check DMD Chip - Check Color Wheel - Check Engine Module
5	Mechanical Noise	<ul style="list-style-type: none"> - Check Color Wheel - Check Fan Module
6	Line Bar/Line Defect	<ul style="list-style-type: none"> - Check if the Main Board and the DMD Board are assembled properly - Check Main Board - Check DMD Board - Check DMD Chip
7	Image Flicker	<ul style="list-style-type: none"> - Do "Reset (All data)" of the OSD Menu - Ensure that the signal cables and source are work as well - Check Lamp Driver and waveform - Check Lamp Module - Check Color Wheel - Check Photo Sensor and clean Photo Sensor - Check DMD Board - Check Main Board
8	Color Abnormal	<ul style="list-style-type: none"> - Do "Reset (All data)" of the OSD Menu - Adjust Color Wheel Index - Check Main Board - Check DMD Board - Check Color Wheel

No	Symptom	Procedure
9	Poor Uniformity/ Shadow	<ul style="list-style-type: none"> - Ensure the projection screen without dirt - Ensure the projection lens is clean - Ensure the Brightness is within spec - Check rod alignment - Check Engine Module
10	Dead Pixel/Dust (Out of spec.)	<ul style="list-style-type: none"> - Ensure the projection screen without dirt - Ensure the projection lens is clean - Clean DMD Chip and Engine Module - Check DMD Chip - Check Engine Module
11	Garbage Image	<ul style="list-style-type: none"> - Ensure that the signal cables and source work as well - Check Main Board - Check DMD Board
12	Remote Controller Failed	<ul style="list-style-type: none"> - Remote Controller <ul style="list-style-type: none"> a. Check Battery b. Check Remote Controller c. Check IR Sensor Board d. Check Main Board
13	Function Abnormal	<ul style="list-style-type: none"> - Do "Reset (All data)" of the OSD Menu - Check Main Board
14	Audio Abnormal (X1261/H5360 only)	<ul style="list-style-type: none"> - Ensure that the signal cables and source are work as well - Ensure that your Projector is not in "Mute" mode - Check Main Board - Check Speaker

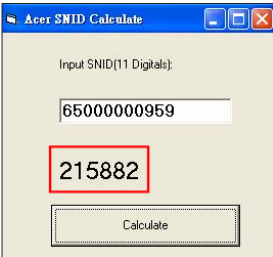
No	Symptom	Procedure
15	Forgetting Password (administrator Password)	<p>- An unique Universal Password which is printed on the Security Card. This unique password is a back door of Administrator Password which will be accepted by projector anytime no matter what the Administrator Password is.</p> <p>- If you forget the Password, please do the following steps to get the Universal Password:</p> <p>(1) Click the "AcerSNID"</p>  <p>(2) Input SNID number. (SNID number is on the Security Card)</p>  <p>(3) Click "Calculate". Then the Universal Password will appear.</p> 
16	Universal Password Failure	<p>- Please confirm whether the SNID number of Service Mode is the same as the SNID number on the backside of projector?</p> <p>- If not, please do the actions as below:</p> <ol style="list-style-type: none"> Execute the EDID Upgrade Procedure (refer to Chapter 6) Execute "Un-lock SNID and Default Language Reset" (refer to 6-5 of Chapter 6) Press "Power", "Left", "Left" and "Menu" buttons sequentially on remote controller to get into Service Mode to obtain the SNID number, then calculate the Universal Password.

Function Test & Alignment Procedure

4-1 Test Equipment Needed

- IBM PC with SVGA/XGA resolution
- DVD player with Multi-system, equipped "Component", "S-Video", "Composite" and "HDMI".
- HDTV Source (480P, 720P, 1080i, 1080P)
- Minolta CL-100
- Quantum Data 802B or CHROMA2327 (Color Video Signal & Pattern Generator)

4-2 Service Mode

1. Turn on the projector
2. Do the following actions sequentially to get into Service Mode
 - (1) Press "Power", "Left", "Left" and "Menu" buttons sequentially on remote controller.
 - (2) Service Mode will be shown.
 - (3) Choose "Exit" to leave the Service Mode after confirming the configuration.

4-3 OSD Reset

1. After final QC step, we have to erase all saved change again and restore the OSD default setting. The following actions will allow you to erase all end-users' settings and restore the default setting:
 - (1) Please get into OSD menu.
 - (2) To execute "Reset" function.

4-4 Test Condition

- Circumstance brightness: Dark room less than 2.0 lux.
- Inspection distance: 1.8 m~2.5 m functional inspection.
- Screen size: 60 inches diagonal.
- After repairing each unit, it should be Run-in (refer to the below table).

Symptom	Run-in Time
Normal repair	2 hours
NFF	4 hours
Auto shutdown	6 hours

- Get into Burn-In Mode

* Cycle setting is based on the defect symptoms. ie: If it is NFF, the run-in time is 4 hours. You have to set the lamp on for 50 min. and lamp off for 10 min for 4 cycles.

Press power → left → left → menu on remote controller	
Choose Burn In > enter	
Lamp On (Min)	Press right key to adjust the time (50)
Lamp Off (Min)	Press right key to adjust the time (10)
Set Burning cycle	Press right key to adjust the cycle
After setting up the time, choose "Enter into Burn In Mode" and press "Menu" button.	

Screen Defects (While replacing DMD Chip, DMD Board, Main Board)

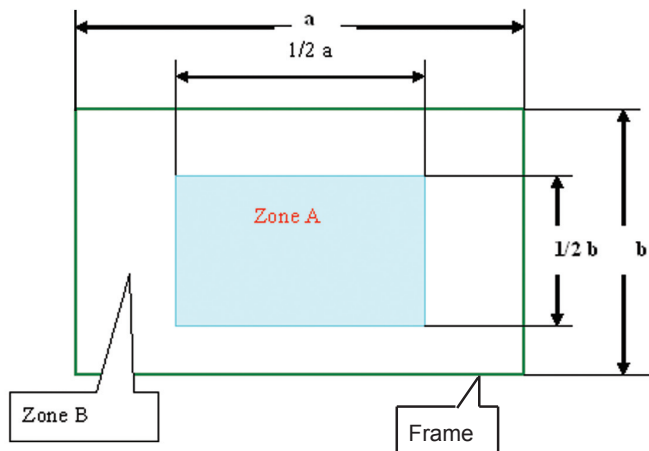

< Figure: Zone A, Zone B, Zone C & Frame (as green line) Definition, Active area=Zone A + Zone B >

Defect specification table

Order	Symptom	Pattern	Criteria
1	Bright pixel (dots)	Gray 10 pattern	$A+B \leq 1$
2	Dark pixel (dots)	White pattern	$A+B \leq 6$
3	Bright blemish	Gray 15 pattern	$A+B \leq 10$
4	Dark blemish	Blue 60 pattern	$A+B \leq 10$
5	Bright dot on frame	Gray 10 pattern	≤ 1
6	Unstable pixel	White & Black pattern	$A+B \leq 1$
7	Adjacent dark pixel	White & Black pattern	$A+B = 0$

4-5 Test Inspection Procedure

Update	Change parts						
	Main Board	Firmware	Color Wheel	Lamp Module	Engine Module	EDID	Lamp Driver
Version Update	v	v					
Color Wheel Index	v		v				
PC Calibration	v	v					
Video Calibration	v	v					
G Sensor Calibration	v	v					
Reset Lamp Hour	v			v			
OSD Reset	v	v					
EDID	v						
Re-write Lamp Hour Usage	v						
Reset Default Language	v	v				v	v
Rod adjustment					v		
Waveform Download							v

Note: - If Color appears abnormal after changing Main Board Module, please do Color Wheel index adjustment.

- After changing parts, check the information above table.

4-6 PC MODE

Note: - When getting into function test, adjust the zoom ring and focus ring to guarantee the image maximum and clearest, then start to test.

- Test signal: analog 800 x 600 @60Hz (for X1161);
analog 1024 x 768 @60Hz (for X1261);
analog 1280 x 720 @60Hz (for H5360).
- We take X1261 for example here.

1. Frequency and tracking boundary

Procedure

- Test equipment: video generator
- Test signal: analog 1024 x 768 @60Hz
- Test pattern: general-1 or master
- Check and see if the image sharpness is well performed.
- If not, re-adjust by the following steps:
 - (1) Select "Frequency" function to adjust the total pixel number of pixel clock in one line period.
 - (2) Select "Tracking" function and use right or left arrow key to adjust the value to minimize video flicker.
- Adjust Resync or Frequency/Tracking/H Image Shift/V Image Shift to the inner screen.

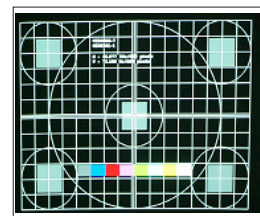

General-1

Inspection item

- Eliminate visual wavy noise by Rsync, Frequency or Tracking selection.
- Check if there is noise on the screen.
- Horizontal and vertical position of the video should be adjustable to the screen frame.

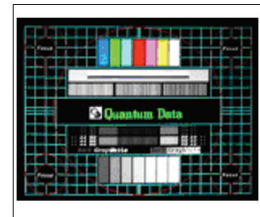

Master

Criteria

- If there is noise on the screen, the product is considered as failure product.
- If there is noise on the screen, use auto or manual "frequency" function or "tracking" function to adjust the screen.
- The PC mode functionally sure be workable include support format with frequency and auto detected functional will be workable.

2. Bright Pixel

Procedure

- Test equipment: video generator

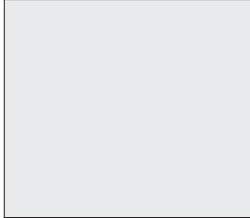
<p>Inspection item</p> <p>Criteria</p>	<ul style="list-style-type: none"> - Test signal: 1024 x 768 @60Hz - Test Pattern: Gray 10 - Bright pixel check - Bright pixel should be no more than 1 under gray 10 pattern. - Adjacent pixels are unacceptable. - Ref. Defect specification table 	 <p>Gray 10</p>
--	--	--

3. Dark Pixel

<p>Procedure</p>	<ul style="list-style-type: none"> - Test equipment: video generator - Test signal: 1024 x 768 @60Hz - Test Pattern: Full white 	 <p>Full white</p>
<p>Inspection item</p> <p>Criteria</p>	<ul style="list-style-type: none"> - Dark pixels check - The dark pixel should be no more than 6 under full white pattern. - Adjacent pixels are unacceptable. - Ref. Defect specification table 	

4. Bright Blemish

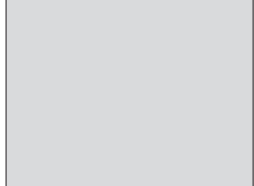
<p>Procedure</p>	<ul style="list-style-type: none"> - Test equipment: video generator - Test signal: 1024 x 768 @60Hz - Test Pattern: Gray 15 	 <p>Gray 15</p>
<p>Inspection item</p> <p>Criteria</p>	<ul style="list-style-type: none"> - Bright blemish check - The bright blemish should be no more than 10 under gray 15 pattern. - Ref. Defect specification table 	

5. Dark Blemish

<p>Procedure</p>	<ul style="list-style-type: none"> - Test equipment: video generator - Test signal: 1024 x 768 @60Hz - Test Pattern: Blue 60 	 <p>Blue 60</p>
<p>Inspection item</p> <p>Criteria</p>	<ul style="list-style-type: none"> - Dark blemish check - The dark blemish should be no more than 10 under blue 60 pattern. 	

- Ref. Defect specification table

6. Focus test

Procedure

- Test equipment: video generator
- Test signal: analog 1024 x 768 @60Hz
- Test pattern: Full screen

Inspection item

- Focus check

Criteria

- From screen 2.38 M via visual to check the focus, look at the entire screen, focus shall be clear, crisp, and sharp over the entire surface of the display pattern. (Blur word on one of the corner after adjustment is acceptable. However, the word should at least be recognizable.)

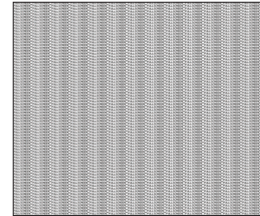

Full screen

7. Color performance

Procedure

- Test equipment: video generator.
- Test signal: 480p, 720p, 1080i
- Test pattern: Master, 64 gray RGBW or SMPTEbar
- * Please refer to 4-2 to get into service mode. Use 720p & 1080p signal, master pattern to do HDTV test. Color cannot discolor to purple and blue.

Inspection item

- Check if each color level is well-functioned.
- Color saturation

Criteria

- Screen appears normal. It should not have any abnormal condition, such as lines appear on the screen and so on.
- Color appears normal.
- It is unacceptable to have few lines flashing.
- RGBW should all appear normal on the screen and sort from R -G-B-W.
- Color levels should be sufficient and normal. (The unidentified color levels on both left and right sides should not over 8 color levels.)
- Gray level should not have abnormal color or heavy lines.
- If color appears abnormal, please get into service mode to do Color Wheel Index adjustment.
- The PC mode functionally sure be workable

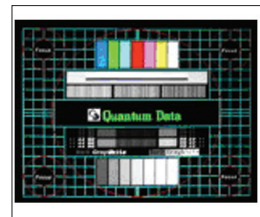

Master



64 gray RGBW

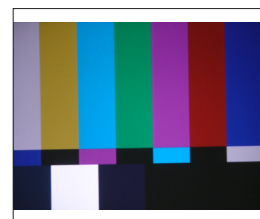

SMPTEbar

include support format with frequency and auto detected functional will be workable.

4-7 Calibration

1. PC Calibration

Procedure

- Test equipment: video generator
- Once Main Board is changed. PC Calibration should be done as well.
 - (1) Test signal analog: 1024 x 768 @60Hz
 - (2) Test Pattern: White (up) Black (down)
- Note
 - (1) Calibration pattern should be in full screen mode.
 - (2) Please press "Power", "Left", "Left" and "Menu" buttons sequentially to get into Service Mode.
 - (3) Choose "Analog Settings", press "Menu" button to access "PC Calibration" for correction in Service Mode. Choose "Exit" to leave the Service Mode.



White/Black

Check pattern

- Test signal: 1024 x 768 @60Hz
- Test pattern: In focus II or 64 gray RGBW
- * After finishing ADC adjustment, check 64 gray RGBW pattern.

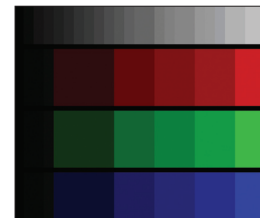

InFocus II / 64 gray RGBW

Inspection item

- Color saturation
- There should not have any lack of RGBW. The color should appear normal and sort in right order.
- Color levels should be sufficient and normal. (the unidentified color levels on both left and right sides should not over 8 color levels.)

Criteria

2. Video Calibration

Procedure

- Test equipment: video generator
- Once Main Board is changed. Video Calibration should be done as well.
 - (1) Test signal: 480i
 - (2) Test Pattern: SMPTEbar
- Note

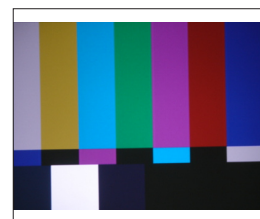

SMPTEbar

- (1) Calibration pattern should be in full screen mode.
 - (2) Please press "Power", "Left", "Left" and "Menu" buttons sequentially to get into Service Mode.
 - (3) Choose "Analog Settings", press "Menu" button to access "Video Calibration for" correction in Service Mode. Choose "Exit" to leave the Service Mode.
- Check pattern
- Test signal: 480i
 - Test pattern: In focus II or 64 gray RGBW
 - * After finishing ADC adjustment, check 64 gray RGBW pattern.
- Inspection item
- Color saturation
- Criteria
- There should not have any lack of RGBW. The color should appear normal and sort in right order.
 - Color levels should be sufficient and normal. (the unidentified color levels on both left and right sides should not over 8 color levels.)

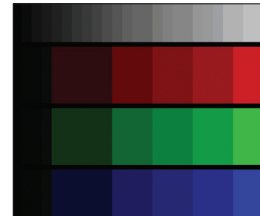

*InFocus II
/ 64 gray RGBW*

3. G Sensor Calibration

- Please put the Projector on a horizontal surface.
- Please press "Power", "Left", "Left" and "Menu" buttons sequentially to get into Service Mode.
- Choose and access "G Sensor Calibration" for correction.

4-8 Video Performance

1. CVBS

Procedure	- Test equipment: DVD player - Test signal: CVBS
Inspection item	- Video performance test
Inspection Distance	- 1.8 M ~2.5 M
Criteria	- Check any abnormal color, line distortion or any noise on the screen.



Motion video

2. S-Video (for X1161/X1161A/X110/X1261/H5360)

Procedure	- Test equipment: DVD player - Test signal: S-Video
Inspection item	- Video performance test
Inspection Distance	- 1.8 M ~2.5 M
Criteria	- Check any abnormal color, line distortion or any noise on the screen.

3. HDTV/ Component

Procedure	- Test equipment: DVD player - Test signal: Ycbcr/YPbPr
Inspection item	- HDTV performance test
Inspection Distance	- 1.8 M ~2.5 M
Criteria	- Check any abnormal color, line distortion or any noise on the screen.

4. Audio Test (for X1261/H5360)

Procedure	- Test equipment: DVD Player - Test signal: CVBS
Inspection item	- Audio performance test
Inspection Distance	- 1.8 M ~2.5 M
Criteria	- Check the sound from speaker - Plug Audio cable into Audio In port, check if "Volume" is normal.

- Adjust the volume to maximum by using the remote controller.
- Check the sound from speaker.
- Check if the "mute" is normal.

5. HDMI Test (for H5360)

Procedure	<ul style="list-style-type: none"> - Test Signal : 720p,1080i - Test Pattern : Any Pattern - Equipment: DVD Player with HDMI output
Inspection item	- HDMI Test
Criteria	- Ensure the image and audio are well performed and the color can not discolor.

4-9 Optical Performance Measure

Inspection Condition
<ul style="list-style-type: none"> - Environment luminance: 2 Lux - Product must be warmed up for 3 minutes - Distances from the screen: 2.38 M - Screen Size: 60 inches diagonal

1. Test equipment

Procedure	<ul style="list-style-type: none"> - Connect VGA IN port of Projector with VGA port of Chroma by VGA cable, press "Menu" button, get into OSD mode, the settings are as below: - "Display mode" is "Bright", "Brightness" is "50", "Contrast" is "70", and the "Format" is "4:3".
-----------	---

2. Brightness

Procedure

- Full white pattern
- Use CL100 to measure brightness values of P1~P9.
- Follow the brightness formula to calculate brightness values.

☀ Brightness Formula

$$\text{Avg. (P1~P9)} \times 1.1\text{m}^2$$

Criteria

- 1100 ANSI lumen

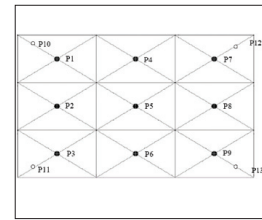

Full white pattern

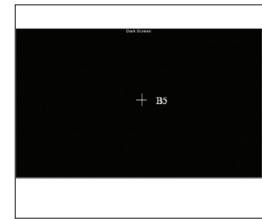

Full black pattern

3. Full On/Full Off Contrast

Procedure

- Full white pattern & full black pattern
- Use CL100 to measure brightness values of full white pattern P5 & full black pattern B5
- Follow Contrast formula to calculate contrast values.

☀ Contrast Formula

$$P5/B5$$

Note: P5 = Lux of center in full white pattern

B5 = Lux of center in full black pattern

Criteria

- 2500: 1 (for X1161/X1161A/X1161N/X110)
- 2100: 1 (for X1261)
- 2300: 1 (for H5360)

4. Uniformity

Procedure

- Full white pattern
- Use CL100 to measure brightness values of P1~P9 (see image: full white).
- Follow the Uniformity formula to calculate average values.

☀ Uniformity Formula

$$\text{JBMA Uniformity} = \text{Avg. (P1, P3, P7, P9)} / P5 \times 100\%$$

Criteria

- 65%

4-10 Others

1. Function Inspection

- General - All OSD functions must be checked for functionality. When OSD menu is displayed, there shall be no visible peaking, ringing, streaking, or smearing artifacts on the screen.
- Factory Default - The factory settings (with appropriate centering, size, geometry distortion, etc.) shall be displayed upon "Recall" is selected from OSD.
- Display Size - All preset modes shall expand to full screen size using OSD Horizontal and Vertical Size controls.
- Display Data Channel (DDC) - The purpose of the DDC test is to verify the DDC1/DDC2B operation of the projector and to verify Plug & Play function.
- Acoustic - High pitch sound from cooling fan and color wheel is unacceptable.

2. Check points for exterior and print pattern

Check item	Check point
Text & Pattern	Missing letters & pattern or blurry prints are unacceptable.
Exterior	Dirt, scrape, water ripples and uneven color are unacceptable.
Focus ring	Focus ring is functioning smoothly.
Logo	Missing logo, missing prints and blurry prints are unacceptable
Screw	All screws should be fixed and in right type.
Pedestal	Well-functioned
Lamp Cover	It should be locked in the correct place.
Plastic Parts	All plastic parts can not be broken and damaged.
Safety or warning label	All safety and warning labels should be visible, including all contents.
Connector	All interface connectors should be complete and workable.

Firmware Upgrade

5-1 Equipment Needed

Software: (DDP 2430 for X1161/X1261/X1161A/X1161N/X110)
(DDP 2431 for H5360)

- DLP Composer Lite 9.2
- Firmware (*.img)
- Library file (X1161 X1261 FlashDeviceParameters) (library file has to put in PC and set right path in 5-4 step 4)

Note: - Please download "DLP Composer Lite 9.2" and "X1161 X1261 FlashDeviceParameters" from website to upgrade FW procedure.

Hardware:

- Projector
- Power cord: 42.50115G001
- RS232 cable: 42.83618G001 (for X1261/H5360)
- USB Cable: 42.87304G001 (for X1161/X1161A/X1161N/X110)
- PC or Laptop

Note: - The FW Upgrade procedure for X1161A/X1161N/X110/H5360 is the same as X1161, we take X1161 for example here.



5-2 DLP Composer Lite Setup Procedure

1. Choose "DLP Composer Lite V9.2 Setup" Program.



2. Click "Next".

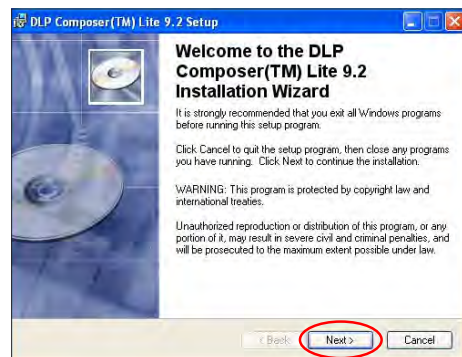

3. Read "License Agreement".

- Choose "I accept and agree to be bound by all the terms and conditions of this License Agreement".

- Click "Next".



4. Click "Next".

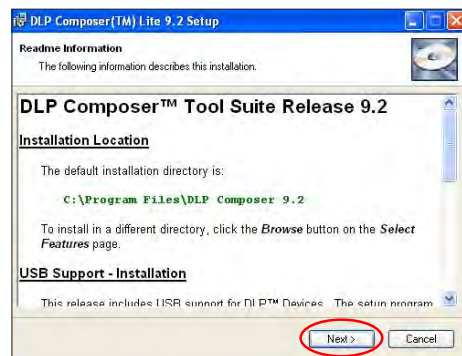

5. Click "Next".

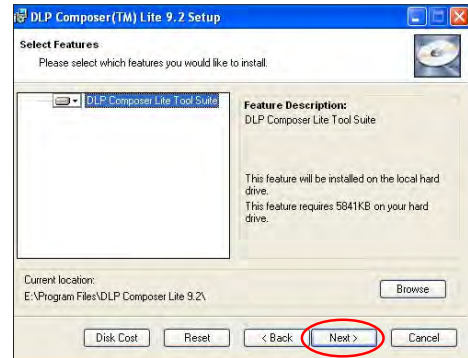

6. Click "Next".

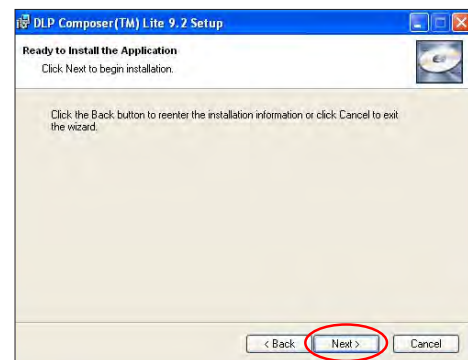

7. The program is executing "installing" status.

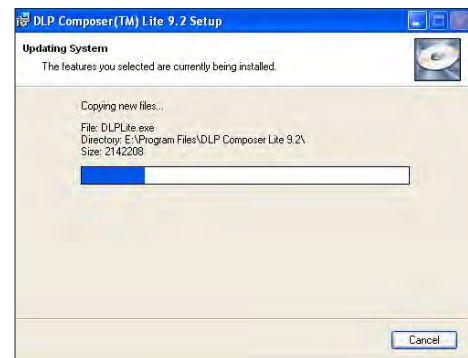

8. Click "Finish".

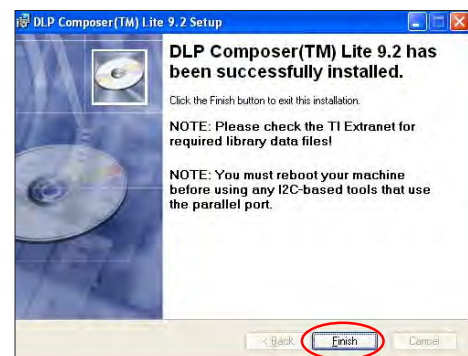

5-3 USB Driver Upgrade Procedure (for X1161/X1161A/X1161N/X110)

1. Set-up

- Hold on "power" button and plug in the power cord.
- The power LED lights red and blue simultaneously after 5 seconds, then loosen "power" button.
- Connect projector with PC by USB cable.

2. Execute Program

- (1) "Found New Hardware Wizard" picture will appear on the screen.
- (2) Select "Install the software automatically (Recommended)".
- (3) Click "Next".
- (4) Searching picture, please wait for several seconds.
- (5) Click "Finish", then the USB driver has been installed successfully.

Note: - If you have installed the USB driver, there is no need to perform this action.

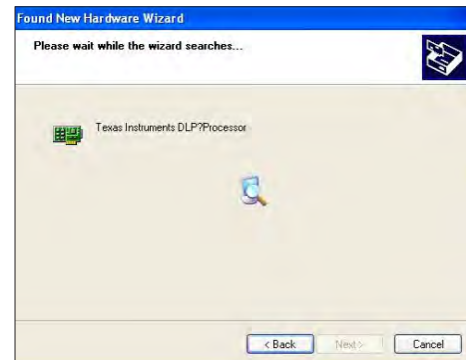
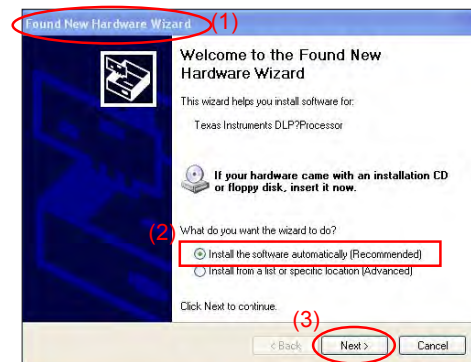

5-4 Firmware Upgrade Procedure

1. Set-up

- Hold on "power" button and plug in the power cord.
- The power LED lights red and blue simultaneously after 5 seconds, then loosen "power" button.
- Connect projector with PC by RS232 cable.
(for X1261/H5360)

*Note: - Please connect projector with PC by USB cable.
(for X1161/X1161A/X1161N/X110)*

- The system fan and the lamp will not operate.

2. Execute the "DLP Composer™ Lite 9.2" file.



3. Click "Edit" and "Perferences".

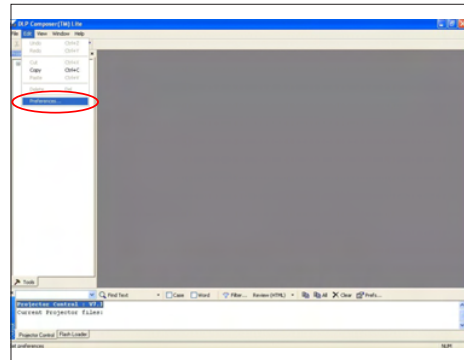

4. Click "Library".

- Click "Browse" and navigate to the directory where you put the DLP Composer installation files in.
- Click "X1161 X1261 FlashDeviceParameters" folder.
- Click "OK".

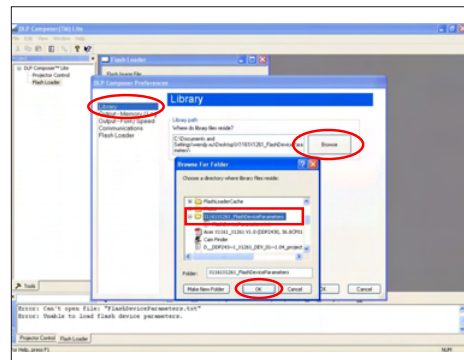

5. Click "Communications".

- Select "Serial Port". (for X1261/H5360)
- Select "USB". (for X1161/X1161A/X1161N/X110)
- Select the COM port which you are using. (for X1261/H5360)
- Click "Configure". (for X1261/H5360)

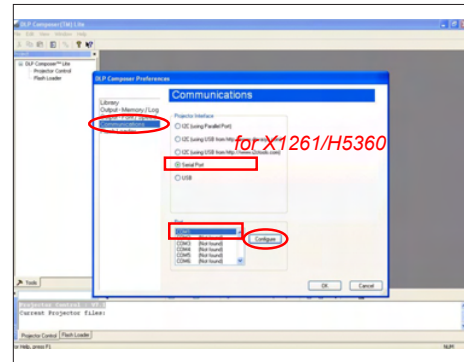

6. For X1261/H5360:

"Serial Port Configuration" picture will appear on the screen.

- Confirm the settings are as the picture A.
- Click "OK".

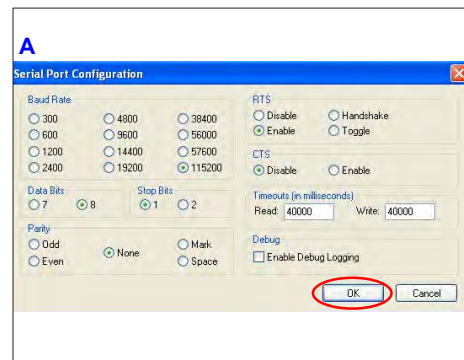

7. Click "OK".

8. Choose "Flash Loader".

- Click "Browse" to search the firmware file (*.img).
- Click "Open".

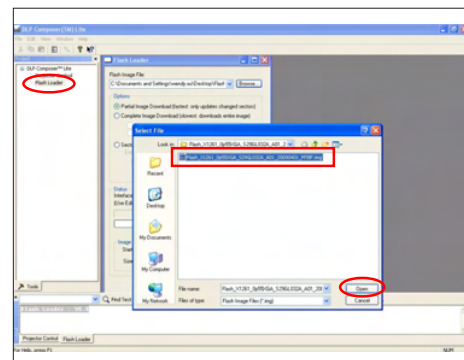
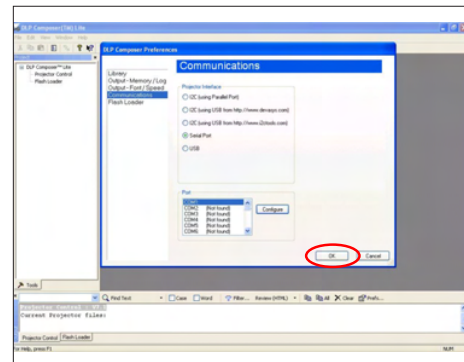

9. Select "Complete Image Download", then click "Reset Bus" to erase the flash memory.

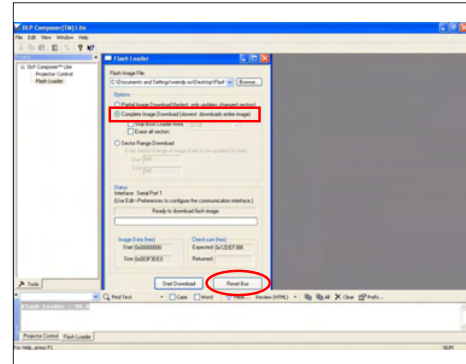

10. If the FW is ready, click "Start Download" to execute the firmware upgrade.

- Click "Yes".

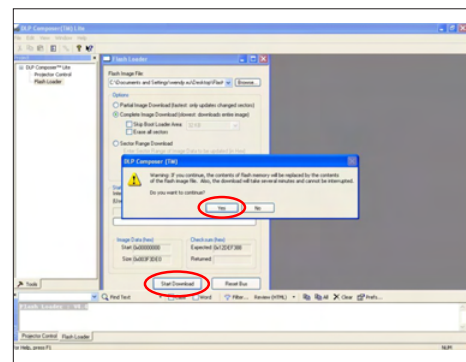

11. It takes about several minutes, the firmware upgrade process is finished, "Download completed" will appear on the screen.

- Unplug RS232 cable and power cord.
(for X1261/H5360)

*Note: Please unplug USB cable and power cord.
(for X1161/X1161A/X1161N/X110)*

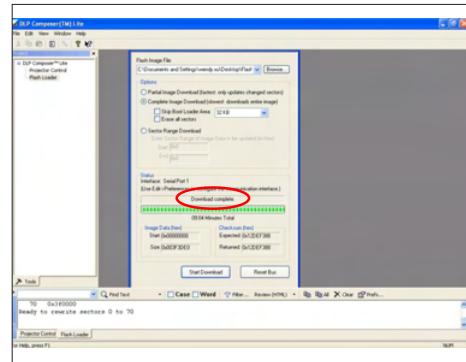

12. Check FW version.

- Re-plug in power cable, then restart the unit and get into the Service Mode to check the firmware version.

(To get into Service Mode, please press "Power", "Left", "Left" and "Menu" buttons sequentially on remote controller.)

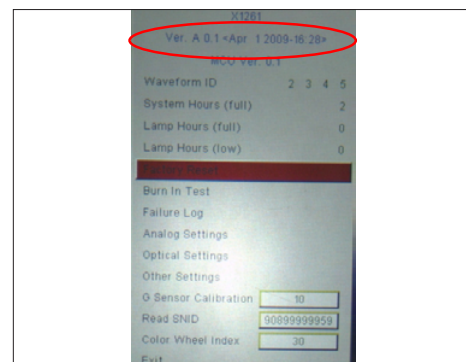

5-5 Waveform Download

- Hold on "power" button and plug in the power cord.
- After 2 seconds, the power LED will flash blue, then loosen "power" button.
- After 5 seconds, the projector will automatically get into standby status.
- Waveform Download is completed.

EDID Upgrade

6-1 EDID Introduction

Extended Display Identification Data is a VESA standard data format that contains basic information about a display device and its capabilities, including vendor information, maximum image size, color characteristics, factory pre-set timings, frequency range limits, and character strings for the monitor name and serial number.

The information is stored in the display and is used to communicate with the system through a Display Data Channel (DDC), which sits between the display device and the PC graphics adapter. The system uses this information for configuration purposes, so the monitor and system can work together.

Note: - The EDID Upgrade procedure for H5360/X1161/X1161A/X1161N/X110 is the same as X1261, we take X1261 for example here.

- As for H5360, it needs to upgrade EDID for HDMI port.

6-2 Equipment Needed

Software

- EDID Program
- EDID File (*.ini)

Hardware

- Projector
- Power Cord for Projector (42.53506G002)
- VGA Cable (42.87305G102)
- HDMI(M) to DVI(F) Adapter (42.82B13G001) (for H5360)
- DVI Cable (42.83N06G001) (for H5360)
- RS-232 9 Pin Cable (pin to pin, F-M) (42.83C07G001)
- Generic Fixture (80.00001.001) for EDID Key-in (Fixture: JP3 must be closed)
- Power Adapter (47.57803G001)
- Monitor
- PC



6-3 Setup Procedure (VGA)

1. Connect all ports

- (1) Connect P1 of fixture with COM Port of PC/Laptop by RS232 Cable.
- (2) Connect P3 of fixture with VGA Port of projector by VGA Cable.
- (3) Plug Power Adapter to JP1 of fixture.
- (4) Plug Power Cord to projector.

Note: You must confirm that the JP3 is closed.

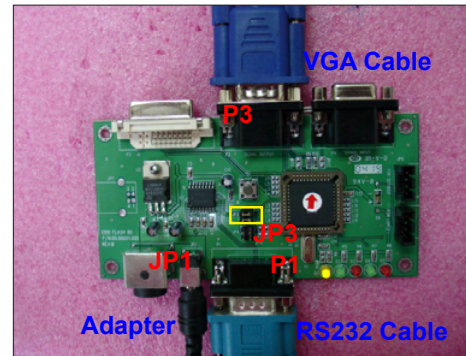

6-4 EDID Key-In Procedure

1. Execute EDID Program

- Double click "EDID" to execute EDID program.



2. Process

- (1) Select the COM Port which you are using.
- (2) Click "Model".
- (3) Select the source file (*.ini).
- (4) Click "Open".
- (5) Key in the Serial Number into the Barcode blank space.
- (6) In "Write Source Select" item, select "Analog".
- (7) Click "Program".

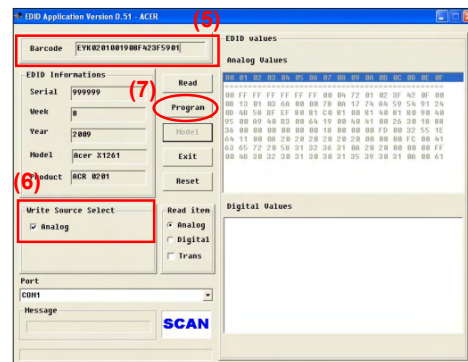
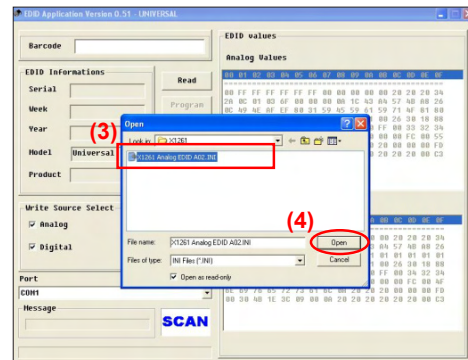
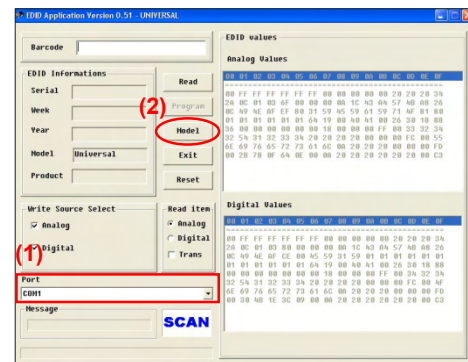

3. Change the cable to Analog

- When the message "Please change the cable to Analog" appear on the screen, click "OK".

4. When the EDID program is completed, a message "OK" will appear on the screen.

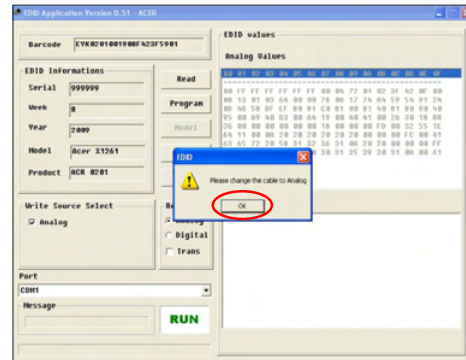

5. Read EDID "Analog" information

- In "Read item", select "Analog" and "Trans", then click the "Read" button.

6. EDID informations will show the result.

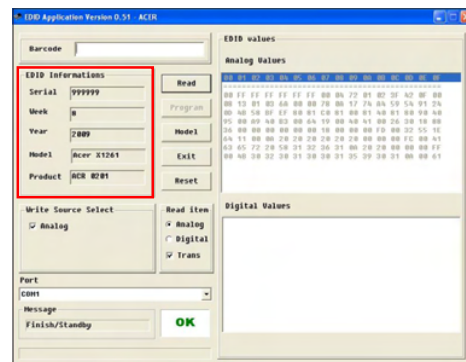
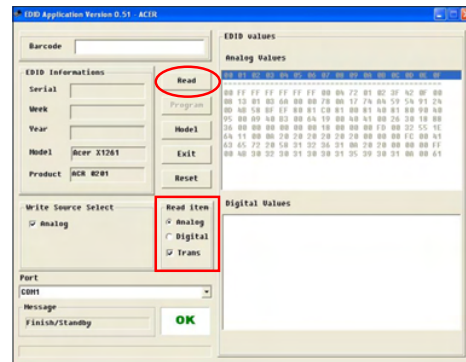
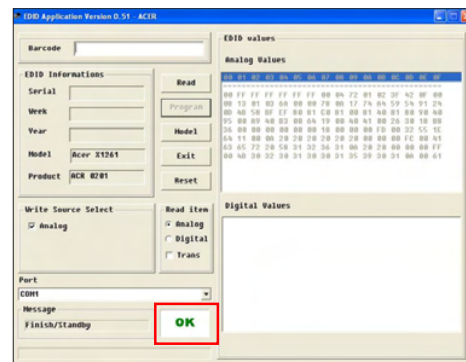

6-5 Un-lock SNID and Default Language Reset

(1) Hold on "power" button then plug in the power cord.

Note: At this moment, power LED flashes red or blue alternately about 2 seconds, then the power LED flashes blue, then loosen "power" button.

(2) After flashing, LED is in steady condition and you can judge the actions as the following table:

Power LED Status	Result
Red	OK
Blue + Red	Fail

Note: If it is fail, please do the actions as above steps item (1)-(2)

S/N General rule:



Use the last 1 digit code (as red word) for language information

Language Code (F)	Default Language
1	English
2	Thailand
3	Japan
4	TC
5	SC
6	Russian
7	Germany
8	Hungarian

Appendix A (Exploded Image)

Note: This chapter is only designed to show the exploded image of the projector. For updated part numbers, please refer to RSPL report.

D.C. X1161

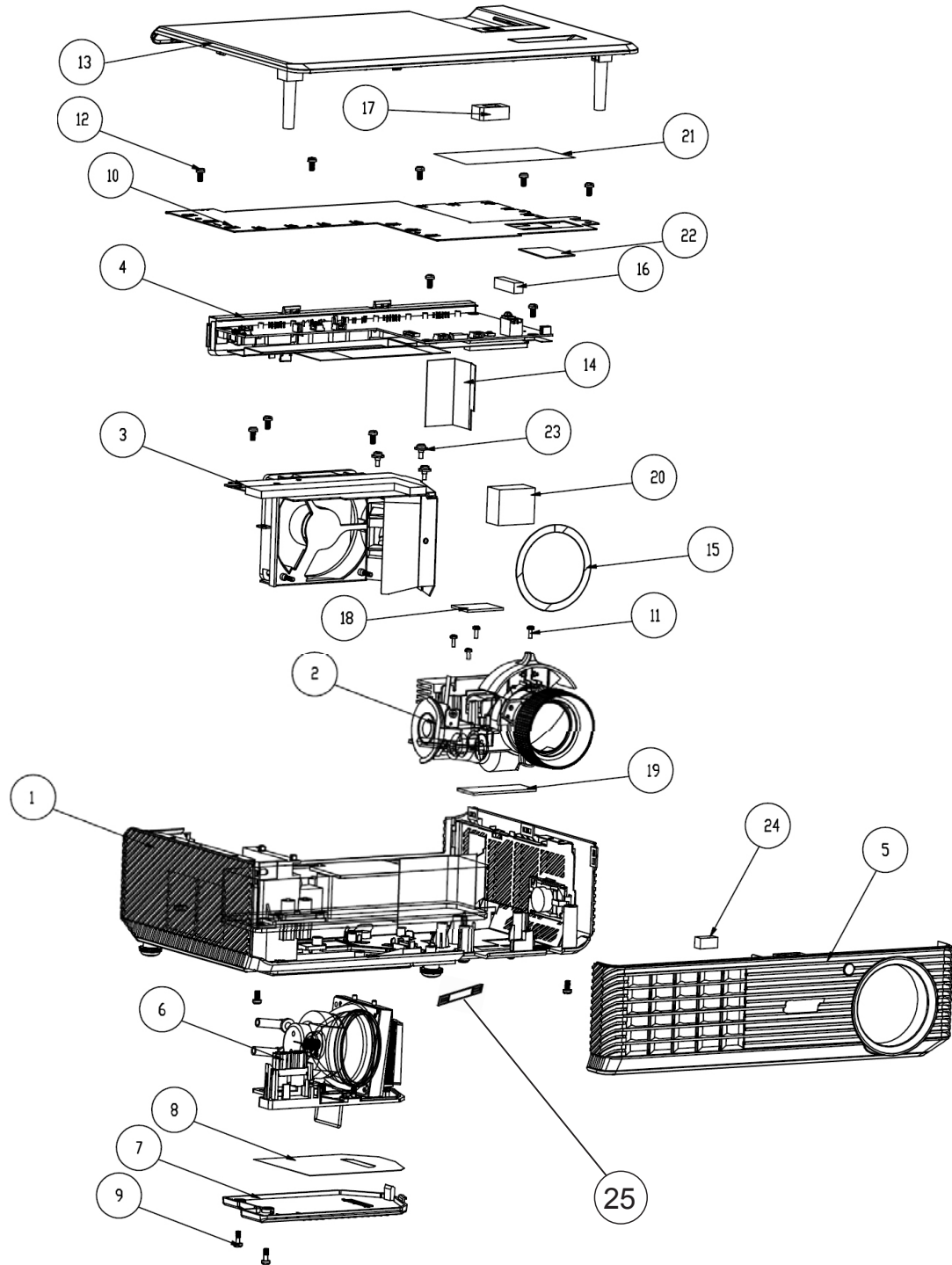

X1161/X1261/X1161A/X1161N/X110/H5360

Confidential

I

Item	P/N	Description	Parts Supply
1	70.8CP01G001	BOTTOM MODULE X1161	
2	70.8CP08G001	ENGINE MODULE X1161	
3	70.8CP07G001	FAN SHIELDING MODULE X1161	
4	70.8CP04G001	IO MODULE X1161	
5	70.8CP03G001	FRONT MODULE X1161	
	SP.8CP01GC01	LAMP MODULE FOR PROJECTOR X1161	V
6	70.8CP06G001	LAMP MODULE X1161	
	70.8CP24GR01	ASSY LAMP COVER MODULE X1161 (SERVICE)	V
7	51.8CP03H001	LAMP COVER LN2520 X1161	
8	61.8CP13G001	LAMP COVER AL FOIL X1161	
9	61.00018G003	LOCK SCREW PAN MECH M3*8.5-3.5 BLACK (1018+HEAT TREATMENT)	
10	61.8CP07G001	TOP SHIELDING SECC X1161	
11	85.1A126G060	SCREW PAN MECH M2.6*6 Ni	
12	85.1A123G060	SCREW PAN MECH M3*6 NI	
13	75.8CP04H001	ASSY TOP COVER X1161	V
14	51.8CP15G001	MYLAR LIGHTCUT ENG-BLOWER X1161	
15	51.8CP18G001	MYLAR FOR LENS X1161	
16	52.8CP07G001	SPONGE LIGHTCUT ZOOM X1161	
17	52.8CP11H001	SPONGE POWER BUTTON X1161	
18	41.87C05G001	EMI GASKET W13*H3*L40	
19	41.83N02G001	EMI GASKET / 6*6*55	
20	41.8BB02G001	EMI GASKET H30*L30*W10	
21	41.89B02G001	EMI TAPE W*20/L*70	
22	41.87F04G001	EMI TAPE L25*W16	
23	61.87340G001	STAND OFF M3*4L D8.0 2100MP	
24	52.8CP09G001	SPONGE LIGHTCUT FR-CW X1161	
25	35.8CP02H001	NAME LABEL X1161	V

D.C. X1261

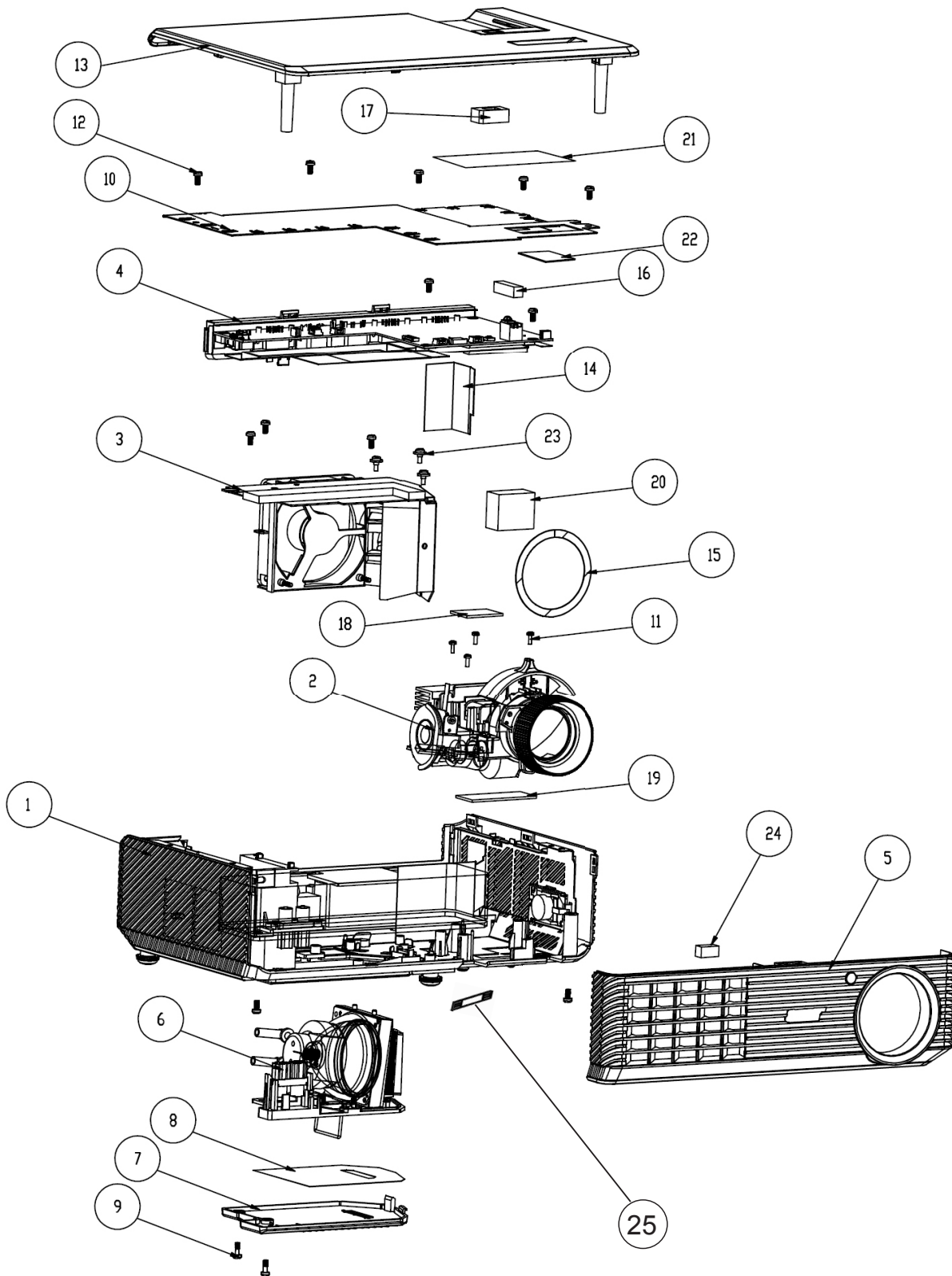

Item	P/N	Description	Parts Supply
1	70.8CQ04G001	BOTTOM MODULE X1261	
2	70.8CQ03G001	ENGINE MODULE X1261	
3	70.8CP07G001	FAN SHIELDING MODULE X1161	
4	70.8CQ01G001	IO MODULE X1261	
5	70.8CP03G001	FRONT MODULE X1161	
	SP.8CP01GC01	LAMP MODULE FOR PROJECTOR X1161	V
6	70.8CP06G001	LAMP MODULE X1161	
	70.8CP24GR01	ASSY LAMP COVER MODULE X1161 (SERVICE)	V
7	51.8CP03H001	LAMP COVER LN2520 X1161	
8	61.8CP13G001	LAMP COVER AL FOIL X1161	
9	61.00018G003	LOCK SCREW PAN MECH M3*8.5-3.5 BLACK (1018+HEAT TREATMENT)	
10	61.8CP07G001	TOP SHIELDING SECC X1161	
11	85.1A126G060	SCREW PAN MECH M2.6*6 Ni	
12	85.1A123G060	SCREW PAN MECH M3*6 NI	
13	75.8CP04H001	ASSY TOP COVER X1161	V
14	51.8CP15G001	MYLAR LIGHTCUT ENG-BLOWER X1161	
15	51.8CP18G001	MYLAR FOR LENS X1161	
16	52.8CP07G001	SPONGE LIGHTCUT ZOOM X1161	
17	52.8CP11H001	SPONGE POWER BUTTON X1161	
18	41.87C05G001	EMI GASKET W13*H3*L40	
19	41.83N02G001	EMI GASKET / 6*6*55	
20	41.8BB02G001	EMI GASKET H30*L30*W10	
21	41.89B02G001	EMI TAPE W*20/L*70	
22	41.87F04G001	EMI TAPE L25*W16	
23	61.87340G001	STAND OFF M3*4L D8.0 2100MP	
24	52.8CP09G001	SPONGE LIGHTCUT FR-CW X1161	
25	35.8CQ03H001	NAME LABEL X1261	V

I.D. X1161

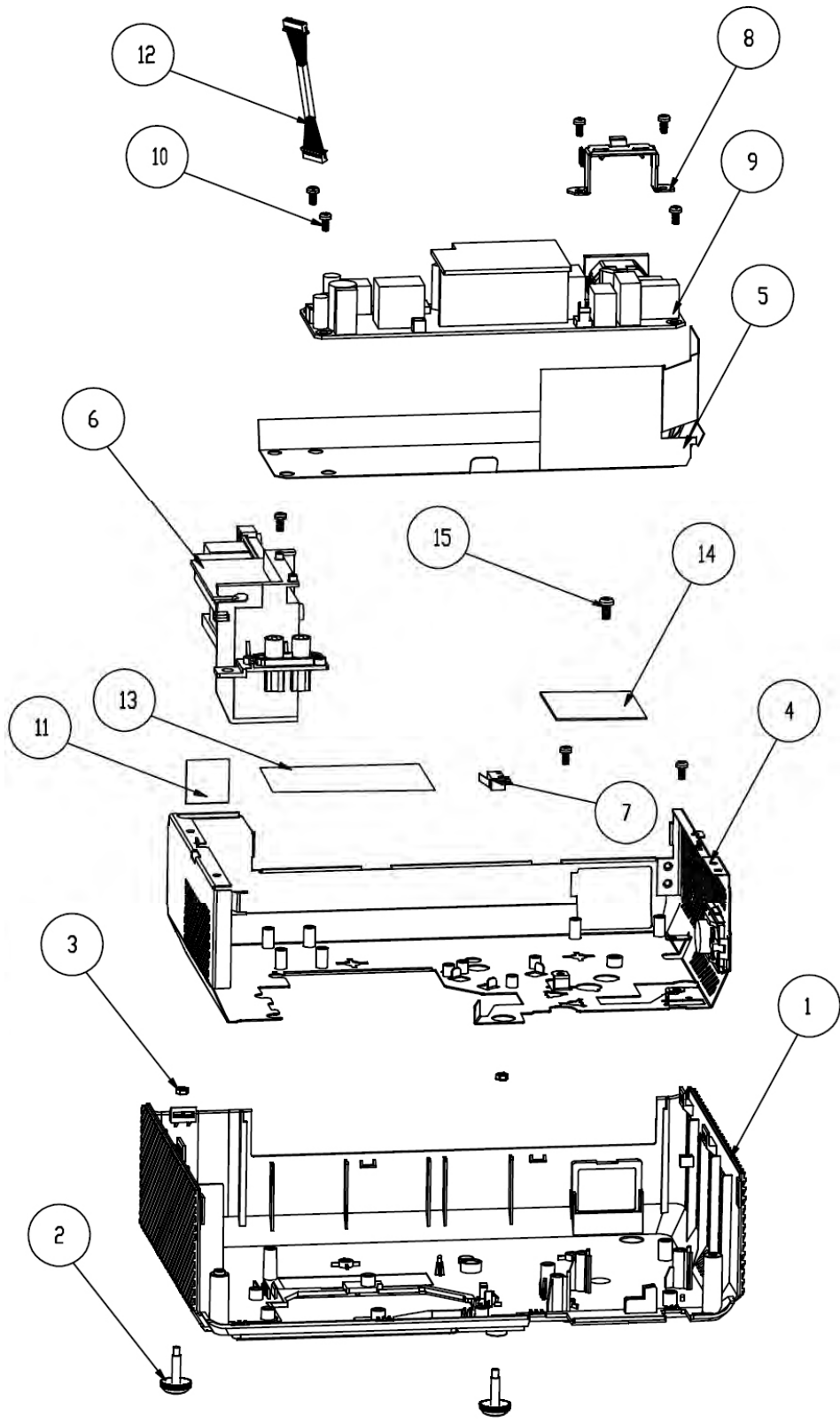

Item	P/N	Description	Parts Supply
	70.8CP26GR01	ASSY BOTTOM COVER MODULE X1161 (SERVICE)	V
1	51.8CP02H001	BOTTOM COVER MN3600H X1161	
2	52.88N07G001	ADJUSTABLE FOOT RUBBER,EP721	
3	86.0A123G024	HEX NUT M3*5.5*0.5P L2.4 Ni	
4	61.8CP06G001	BOTTOM SHIELDING SECC (for X1161)	
	70.8CP05G001	BOTTOM SHIELDING MODULE (for X1261)	
5	51.8CP12G001	MYLAR LVPS X1161	
6	70.8CP14G001	LAMP DRIVER MODULE X1161	
7	75.8CP02G001	ASSY INTERRUPT SWITCH MODULE X1161	
8	61.88T19G001	AC INLET BRACKET FOR X1160E	
9	75.8CP03GP01	LVPS 180W X1161 STB<1W CT-258A	V
10	85.1A123G060	SCREW PAN MECH M3*6 NI	
11	51.88T21G001	MYLAR K-LOCK 0.25t X1160	
12	42.00454G001	W.A 8P 120mm MB TO LVPS X1160	V
13	41.89B02G001	EMI TAPE W*20/L*70	
14	41.89C06G001	EMI GASKET L44*H1*W21	
15	85.1C224G051	SCREW PAN MECH M4*5 COLOR W/TOOTH WASHER Cr3+	

Front Module

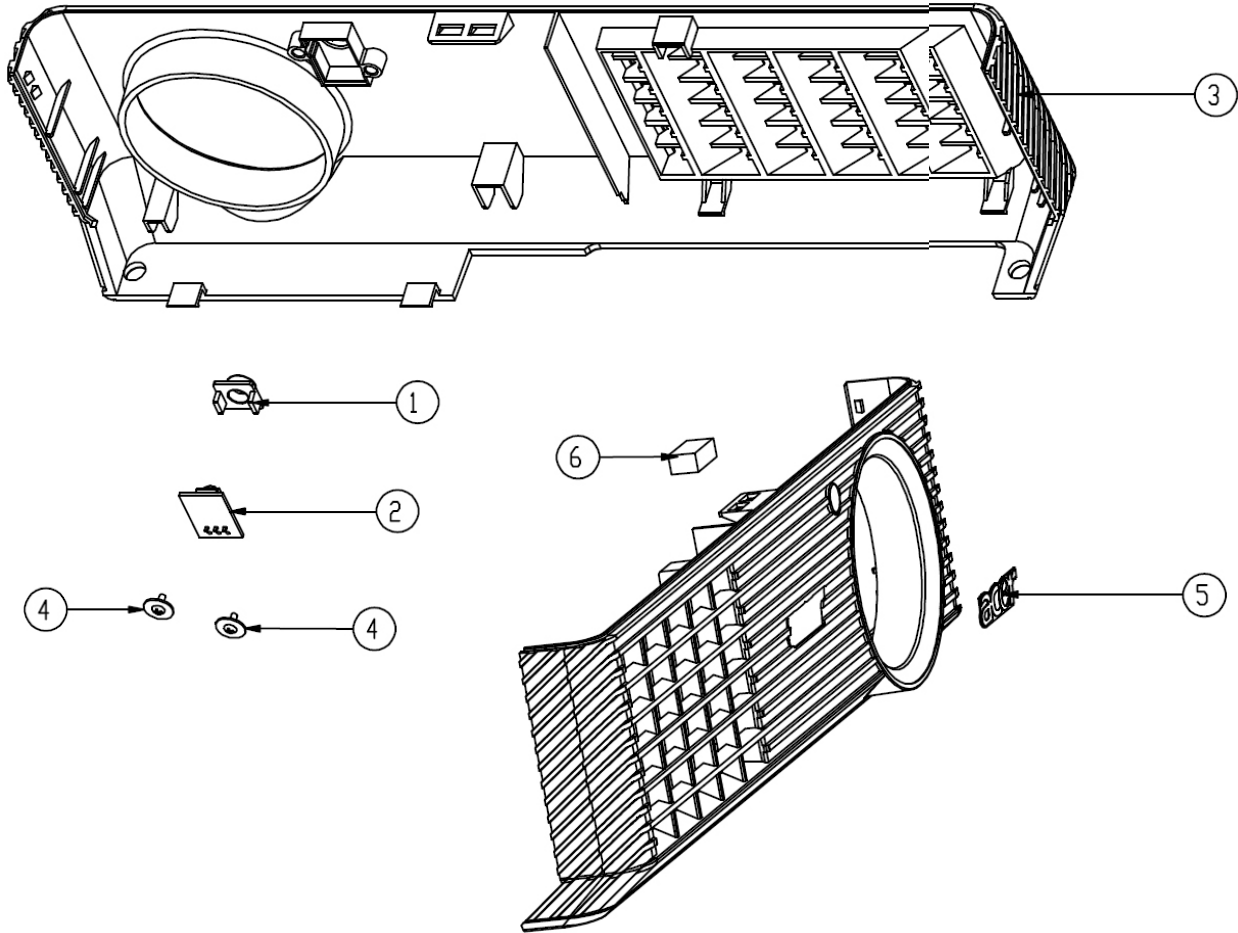

Item	P/N	Description	Parts Supply
1	51.88T24G001	FRONT IR CAP FOR X1160E	
2	80.8CP05G001	PCBA IR SENSOR BD FOR X1161	V
3	51.8CP09H001	FRONT COVER MN3600H X1161	V
4	85.3A122G040	SCREW CAP MECH M2*4 Ni	
5	61.8CP14H001	ACER LOGO FOR X1161	V
6	52.8CP09G001	SPONGE LIGHTCUT FR-CW X1161	

IO MODULE X1161

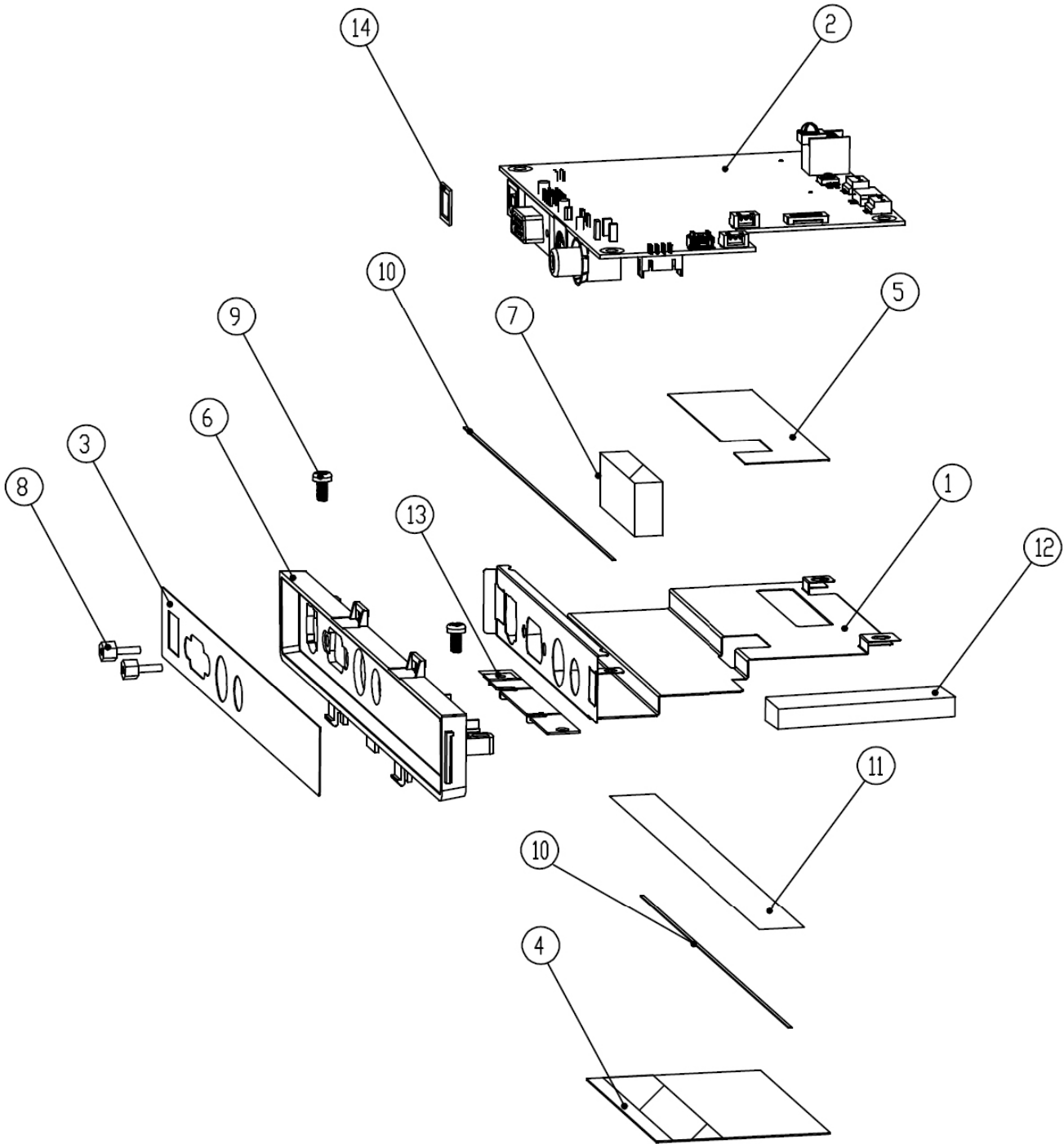

Item	P/N	Description	Parts Supply
1	61.8CP10G001	MAIN SHIELDING SMALL TINPLATE X1161	
	70.8CP25GR01	ASSY MAIN BOARD MODULE X1161 (SERVICE)	V
2	80.8CP01G001	PCBA MAIN BOARD FOR X1161	
3	35.8CP01H001	LABEL IO X1161	
4	51.8CP13G001	MYLAR MAIN-BD TO LVPS X1161	
5	51.8CP16G001	MYLAR MAIN-BD SMALL X1161	
6	51.8CP11H001	IO COVER MN3600H X1161	
7	52.8CP10G001	SPONGE LIGHTCUT IO X1161	
8	85.005AGG408	SCREW HEX I/O #4-40 H4*L8 NI NYLOK	
9	85.1A123G060	SCREW PAN MECH M3*6 NI	
10	41.87F02G001	EMI GASKET W4*H1*L120	
11	41.8CP01G001	EMI TAPE L110*W20	
	70.8CP23GR01	ASSY IO COVER MODULE X1161 (SERVICE)	V
12	52.8CP08G001	SPONGE LIGHTCUT MAINSHIELDING X1161	
13	61.8CP11G001	MAIN SHIELDING SMALL BRKT TINPLATE X1161	
14	41.82G03G001	EMI GASKET USB CONNECTOR EP719	

IO MODULE X1261

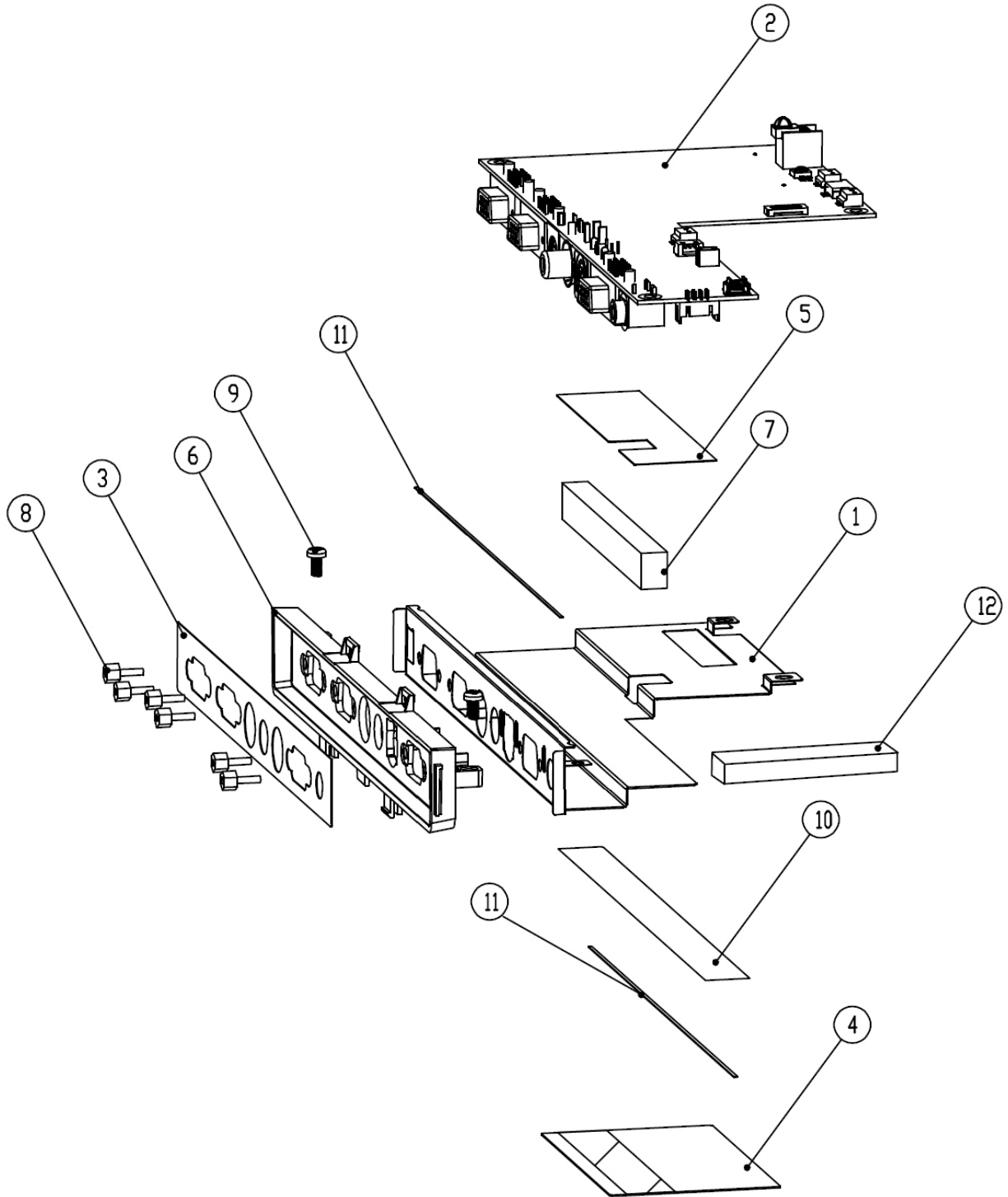

Item	P/N	Description	Parts Supply
1	61.8CP09G001	MAIN SHIELDING TINPLATE X1161	
	70.8CQ09GR01	ASSY MAIN BOARD MODULE X1261 (SERVICE)	V
2	80.8CQ01G001	PCBA MAIN BOARD FOR X1261	
3	35.8CQ02H001	LABEL IO BASE X1261	
4	51.8CP13G001	MYLAR MAIN-BD TO LVPS X1161	
5	51.8CP14G001	MYLAR MAIN-BD X1161	
	70.8CQ08GR01	ASSY IO COVER MODULE X1261 (SERVICE)	V
6	51.8CQ01H001	IO COVER MN3600H X1261	
7	52.8CQ01G001	SPONGE LIGHTCUT IO X1261	
8	85.005AGG408	SCREW HEX I/O #4-40 H4*L8 NI NYLOK	
9	85.1A123G060	SCREW PAN MECH M3*6 NI	
10	41.88T02G001	EMI GASKET L180*W4*H1	
11	41.89B01G001	EMI TAPE L*190/W*13	
12	52.8CP08G001	SPONGE LIGHTCUT MAINSHIELDING X1161	

Bottom Shielding Module

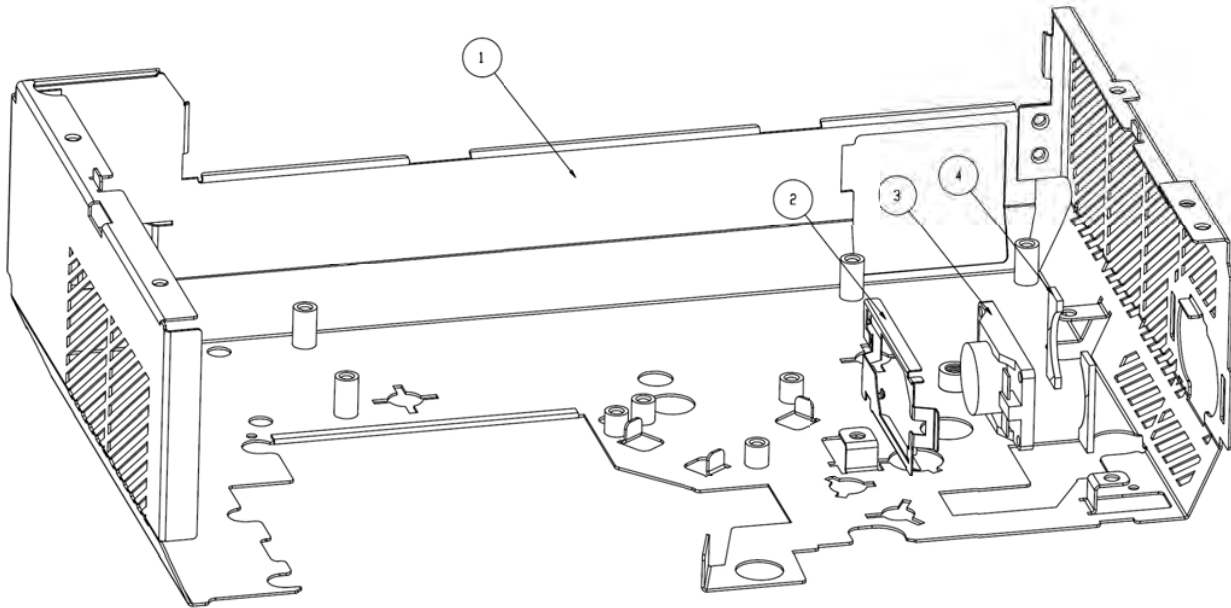

Item	P/N	Description	Parts Supply
1	61.8CP06G001	BOTTOM SHIELDING SECC X1161	
2	61.8CP08G001	SPEAKER BRKT SUS301 X1161	
3	49.8CQ01G001	SPEAKER 2W 16OHM DAB128 90mm X1261	V
4	52.8CP05G001	SPONGE SPEAKER X1161	

One- Fan Module

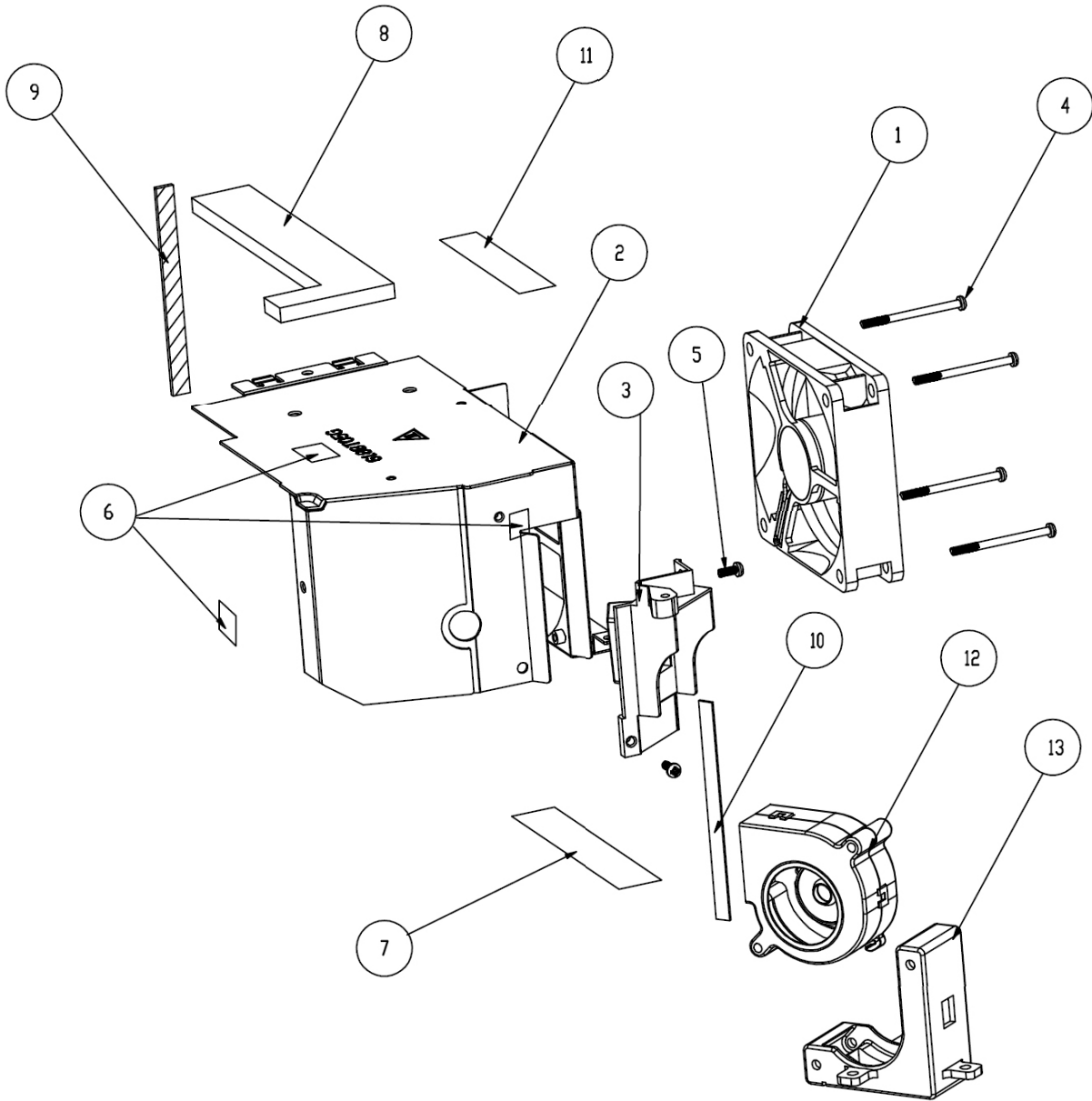

Item	P/N	Description	Parts Supply
1	49.8CP02G001	SUNON 70*70*20mm AXIAL FAN, KDE1207PKV1. MS.B3001.AF.GN	V
2	61.88T05G041	SHIELDING TWO FAN PDG-DSU30	
3	61.8AN01G002	LAMP BLOWER DUCT X15 GENERIC	
4	85.1F123G260	SCREW PAN MECH E/SF M3*26 Ni	
5	85.1A123G060	SCREW PAN MECH M3*6 NI	
6	51.88T18G001	KAPTON 10*10 0.05t X1160	
7	41.89B02G001	EMI TAPE W*20/L*70	
8	52.88T01G001	FAN SIELDING FRONT AIR TIGHT CVS X1160	
9	52.88T08G001	FAN SIELDING AIR TIGHT F12 X1160	
10	52.89T01G001	BLOWER AIR TIGHT F12 H5350	
11	51.81540G001	TAPE 3M J350 17*60mm	
12	49.8CS01G001	SUNON 45*20mm GB1245PKV1-8AY, F TYPE BLOWER FAN	V
13	52.82G08G001	BLOWER 4520 RUBBER EP7190	

Engine Module

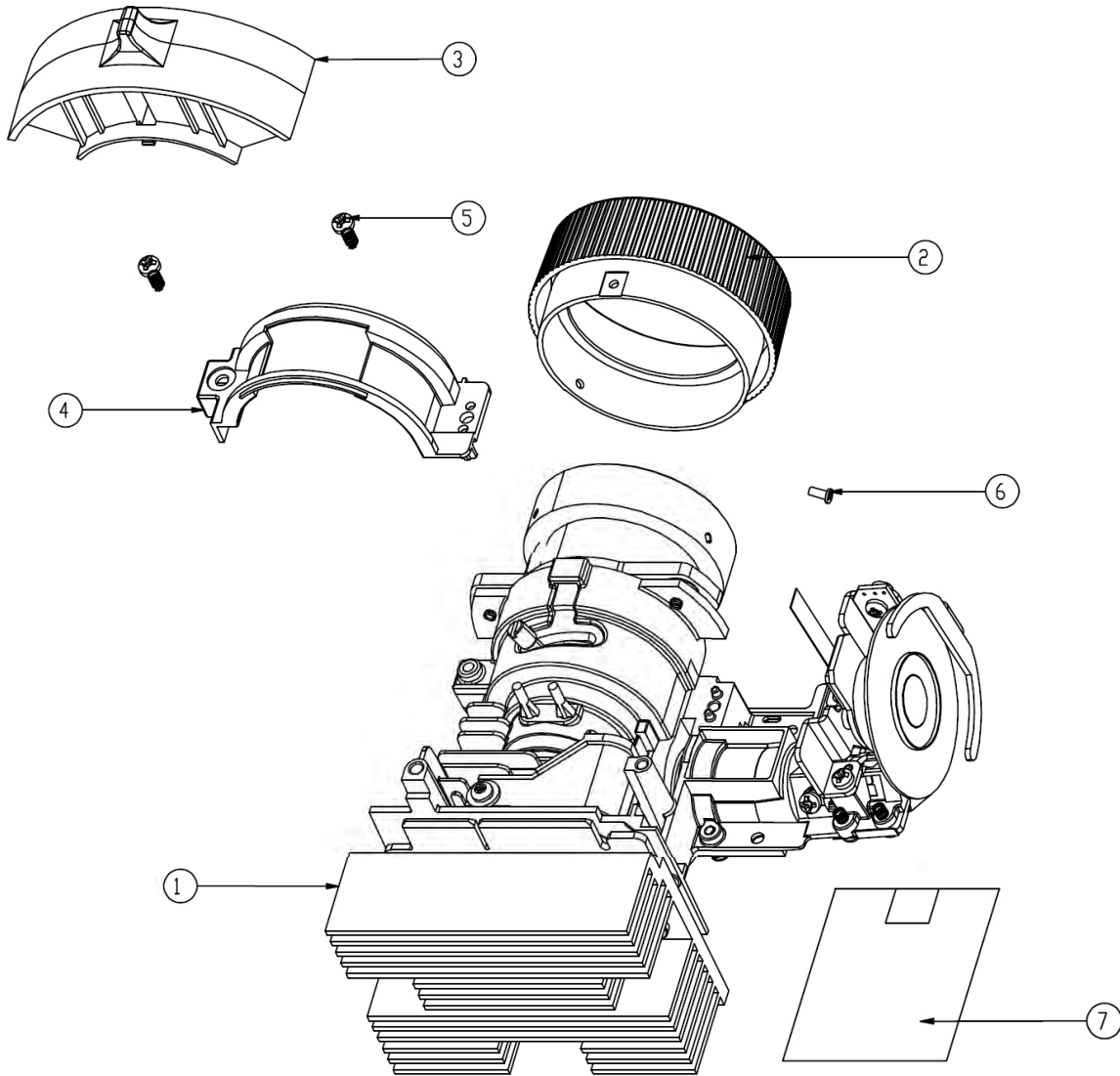

Item	P/N	Description	Parts Supply
1	70.8CP09G001	ASSY OPTICAL ENGINE MODULE Z15 (S450) (for X1161)	
1	70.8CQ02G001	ASSY OPTICAL ENGINE MODULE (for X1261)	
2	51.8CP04H001	FOCUS RING MN3600H X1161	V
3	51.8CP08H001	ZOOM RING MN3600H X1161	V
4	51.89Z04G001	ZOOM RING FIXED HOLDER EX330	
5	85.1A326G060	SCREW PAN HEAD MECH M2.6*6 BLACK	
6	85.WA321G040	SCREW PAN TAP M1.7*4 BLACK	
7	41.89C01G001	EMI TAPE L45*W30	

Assy Engine Module

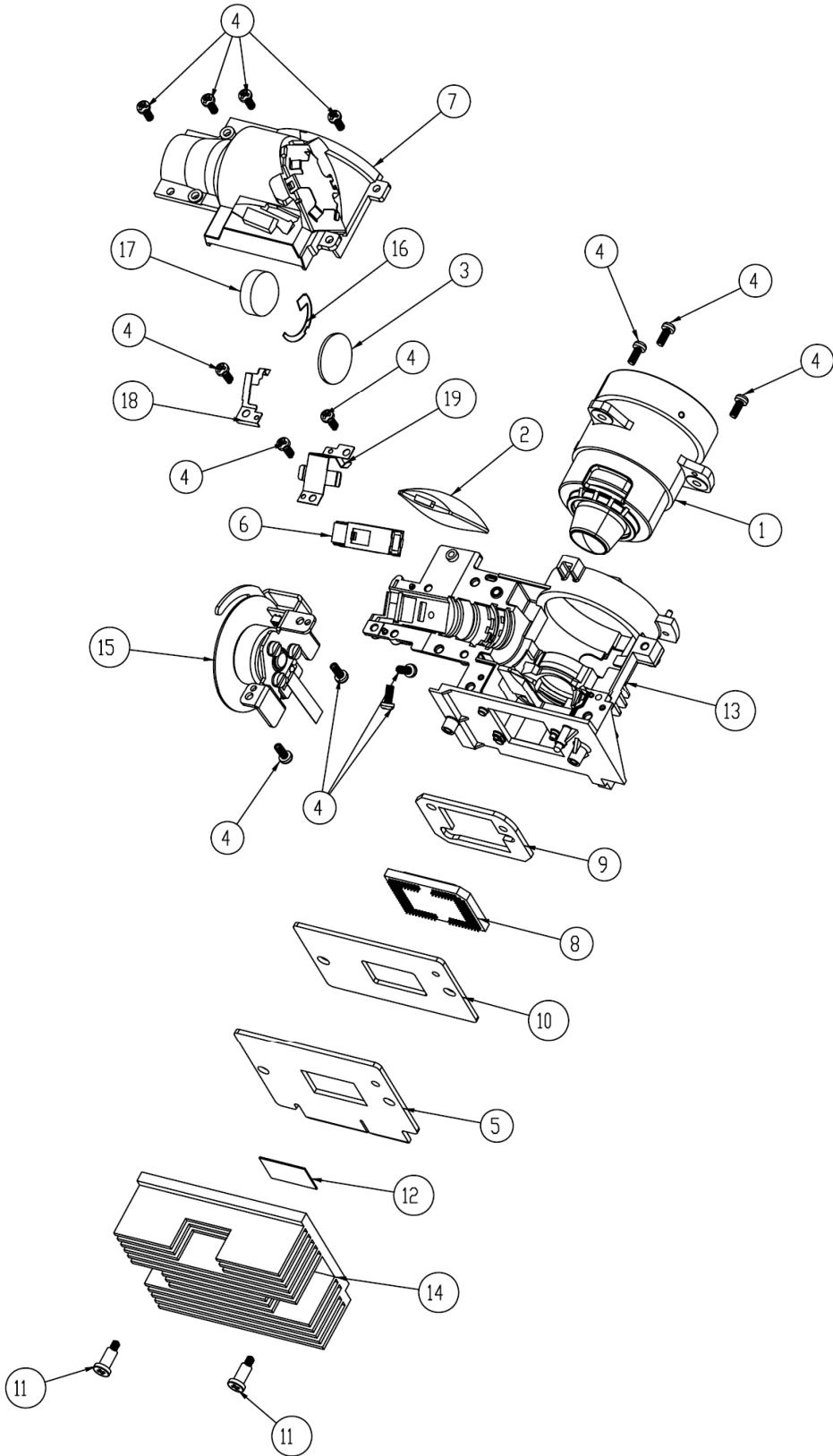

Item	P/N	Description	Parts Supply
1	23.8CP01G001	YO YM39 PROJECTION LENS 1.1X ZOOM	
2	70.8CP15G001	ASSY RELAY MODULE Z15	
3	23.8AH20G001	CONDENSER1 FOR A15W	
	70.8CP22GR01	ASSY ENGINE MODULE X1161 (SERVICE)	V
	70.8CQ07GR01	ASSY ENGINE MODULE X1261 (SERVICE)	V
4	85.1A526G060	SCREW PAN MECH M2.6*6 Ni NYLOK	
5	80.8CP02G001	PCBA DMD BOARD FOR X1161	V
6	70.8CP13G001	ASSY ROD MODULE Z15	
7	70.8CP10G001	ASSY ENGINE BOTTOM COVER Z15	
8	48.8EH01G001	0.55" SVGA 2xLVDS SERIES 450 DMD -8 TI 8060-603cB	V
8	48.8CQ01G001	0.55" XGA 2xLVDS SERIES 450 DMD -8 TI 1076-603cB	V
9	52.8CP01G001	DMD RUBBER X1161	
10	52.8CP02G001	DMD BOARD RUBBER X1161	
11	85.4A826G118	STEP SCREW FOR TYPEX DMD M2.6*11.8mm,X15	V
12	52.8CP04G001	S450 0.55" XGA/SVGA DMD thermal pad, FUJIPO- LY, Sarcon XR-HE, 18.4x12.5x0.5 mm	V
13	70.8CP11G001	ASSY ENGINE BASE Z15	
14	61.8CP02G001	DMD HEATSINK X1161	
15	70.8CP12G001	ASSY COLOR WHEEL MODULE Z15	
16	61.8EF03G001	CONDENSER LIGHT STOP EX615	
17	23.8AH20G002	CONDENSER 2 FOR A15W	
18	61.88N13G002	ROD COVER NEW SUS301 X15	
19	61.88N12G001	ROD SPRING SUS301,X15	

Assy Color Wheel Module Z15

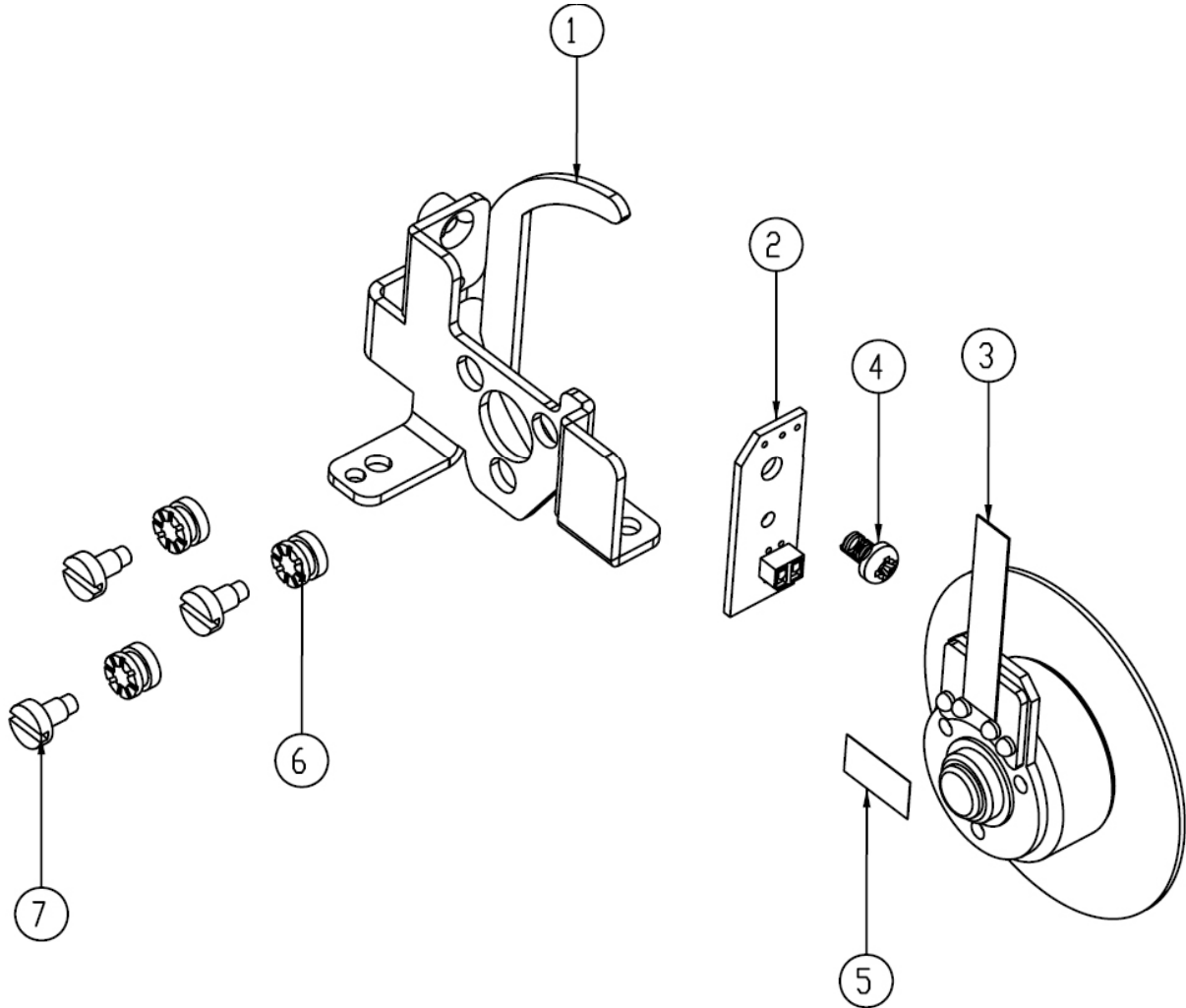

Item	P/N	Description	Parts Supply
1	61.8CP03G001	CW BRACKET SECC X1161	
2	80.8CP04G001	PCBA PHOTO SENSOR BOARD FOR X1161	V
3	23.8EF19G001	YO 6S R81Y41G84C31W52B71_HE3 CW	
4	85.1A126G040	SCREW PAN MECH M2.6*4 Ni	
5	51.82Y29G001	TAPE 3M J350 10*5mm FOR COLOR WHEEL DP715	
	70.8CP21GR01	ASSY COLOR WHEEL MODULE X1161 (SERVICE)	V
6	52.83615G001	COLOR WHEEL DISC RUBBER, EzPro755	
7	61.83628G001	COLOR WHEEL SHOULDER SCREW, EzPro755	

Assy Lamp Driver Module

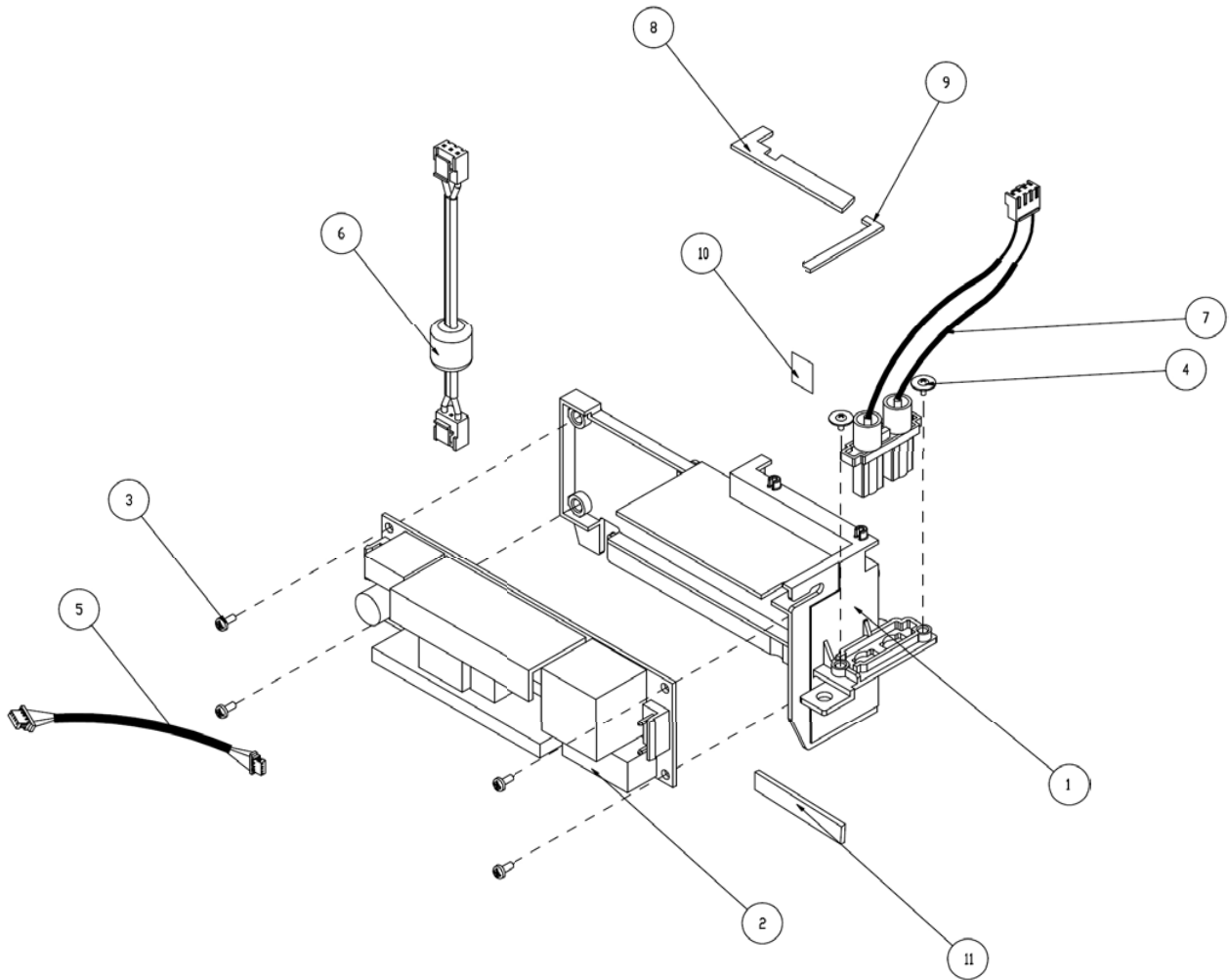

Item	P/N	Description	Parts Supply
1	51.88T11G003	HOLDER LAMP DRIVER FOR H5350	
2	75.8BA01G002	ASSY OSRAM LAMP DRIVER O6 MIC 180W (Gen5_Panyu+E20.8)	V
3	85.1A123G060	SCREW PAN MECH M3*6 NI	
4	85.3A122G040	SCREW CAP MECH M2*4 Ni	
5	42.00422G001	W.A 5P 150mm LAMP DRIVER TO MB X1160	V
6	42.00447G001	CABLE W.A. 2P #20 180mm LVPS TO LAMP DRIVER FOR X1260K	V
7	42.00436G002	CABLE W.A. 2P #22 100mm LAMP DRIVER TO LAMP X1160	
8	52.88T02G001	LAMP DRIVER HOLDER AIR TIGHT F12 X1160	
9	52.88T03G001	LAMP DRIVER HOLDER AIR TIGHT-FR F12 X1160	
10	51.88T18G001	KAPTON 10*10 0.05t X1160	
11	52.86K01G001	LAMP SPONGE F12 35X5X3.2mm EP709	

X1161/X1261/X1161A/X1161N/X110/H5360

Confidential

XIX

A.K.

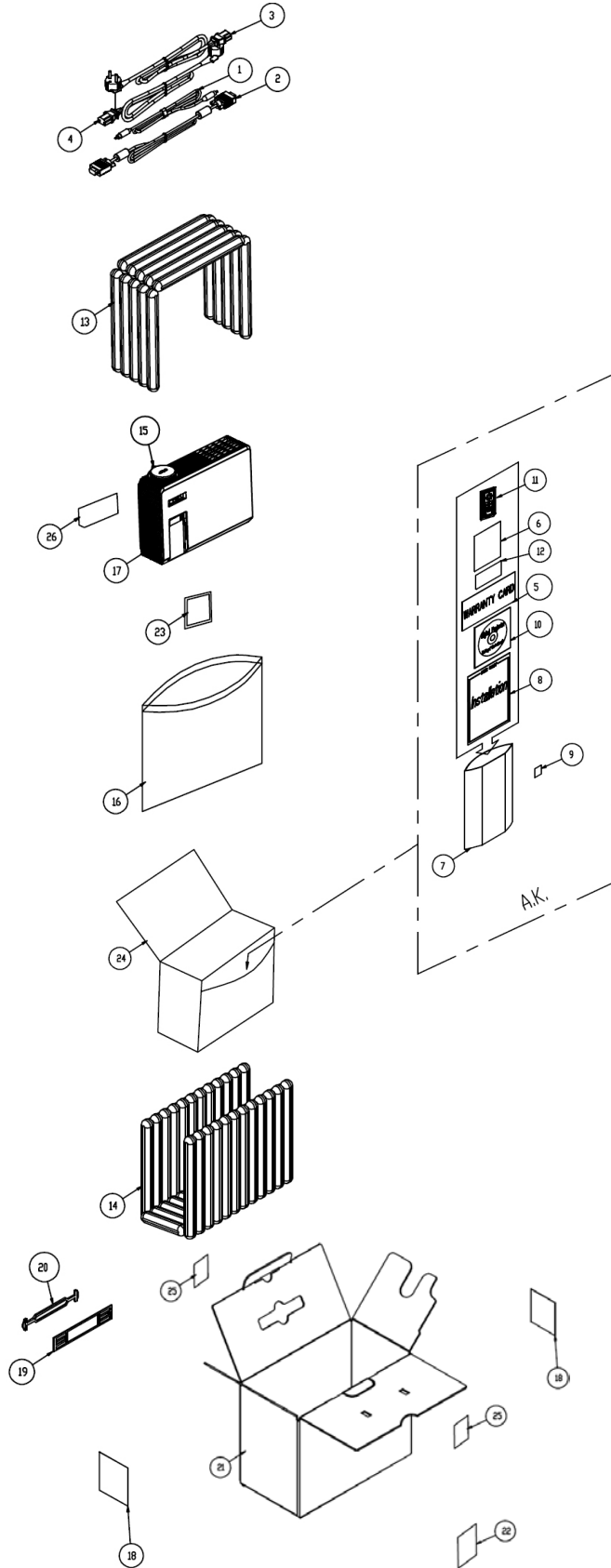

X1161/X1261/X1161A/X1161N/X110/H5360

Confidential

XX

Item	P/N	Description	Parts Supply
1	42.87205G001	CABLE COMPOSITE VIDEO 1.8M 3200MP	
2	42.00200G002	CABLE VGA 15P 1.8M BLK EP739	
3	42.00110G011	CABLE POWER CORD 1.8M SP-60/IS-14 UK DIS-WARNING LABEL	
4	42.00120G011	CABLE POWER CORD 1.8M SP-023/IS-14 EU-ROPE DIS-WARNING LABEL	
5	36.00006G031	WARRANTY CARD ,EUROPE FOR ACER	
6	36.00027G001	SERVICE STATION CARD	
7	51.86213G002	PE BAG ZIPPER #9 W/RECYCLING MARK FOR OPTOMA	
8	36.8CP02G001	QUICK START CARD MULTILINGUAL	
9	35.82001G111	AK LABEL 3"*3" BLANK	
10	36.8CP01H001	USER'S GUIDE MULTILINGUAL (CD) ACER X1161/ X1261	
11	45.8CP01G001	INFRARED REMOTE CONTROLLER X1161 X3 "BONTECH"	V
12	36.00029G001	SECURITY CARD FOR ACER	
13	56.8CP01G001	AIR BAG RIM X1161	
14	56.8CP02G001	AIR BAG TOP-BOTTOM X1161	
15	75.8CP05H001	BUY ASSY LENS CAP X1161	
16	51.52109G005	PE BAG 450*350*0.07 FOR OPTOMA EP720	
17	DC.8CP01G001	D.C. X1161	
18	35.52302G091	LABEL CARTON 108*92 BLANK	
19	51.00200G001	HANDLE BAR 2. PE HD70	
20	51.00201G001	HANDLE BAR 1.PE HD70	
21	55.8CP01G001	CARTON CARRY BOX X1161	
22	35.82V02G001	LABEL CARTON(SEAL) 110*50mm PD120	
23	57.00001G001	PACK SIO2 DRIER 20g	
24	53.88T01G001	SOFT CARRY BAG X1160	
25	35.8CP03G001	LABEL CARTON STICKER X1161	
26	35.86301G001	SPEC LABEL BLANK PD120	V

Appendix B

I. Serial Number System Definition

Serial Number Format for Projector (take X1261 for example)

EYK0201001 **915** **00000** **59** **0** **1**

①

②

③

④

⑤

⑥

- ① : **EYK0201001 = Part Number**
- ② : **915 = Date Code (ex:2009 = 9, the fifteenth week of the year = 15)**
- ③ : **00000 = Serial Numbers**
- ④ : **59 = Manufacturing Code**
- ⑤ : **0 = Version Code**
- ⑥ : **1 = Auto-Language Code**

EX: EYK0201001915000005901

This label represents the serial number for X1261. It is produced at CPC on fifteenth week of 2009. Its serial code is 00000.

II. PCBA Code Definition

PCBA Code for Projector

<u>A</u>	<u>B</u>	<u>XXX</u>	<u>XXXXXXXXXX</u>	<u>CC</u>	<u>XXX</u>	<u>EEEE</u>
①	②	③	④	⑤	⑥	⑦
①	:	ID				
②	:	Vendor Code				
③	:	Firmware Version				
④	:	P/N				
⑤	:	MB version				
⑥	:	Date Code				
⑦	:	S/N				

Appendix C

RS232 function command summary table (for X1261/H5360)

General command type (Projector “receives” commands)

No	Code (character)	Function feature
1	OKOKOKOKOK\r	Power On
2	* 0 IR 001\r	Power On
3	* 0 IR 002\r	Power Off
4	* 0 IR 004\r	Keystone
5	* 0 IR 006\r	Mute
6	* 0 IR 007\r	Freeze
7	* 0 IR 008\r	Menu
8	* 0 IR 009\r	Up
9	* 0 IR 010\r	Down
10	* 0 IR 011\r	Right
11	* 0 IR 012\r	Left
12	* 0 IR 014\r	Re-Sync
13	* 0 IR 015\r	Source Analog RGB for D-sub
14	* 0 IR 017\r	Source PbPr for D-sub
15	* 0 IR 018\r	Source S-Video
16	* 0 IR 019\r	Source Composite Video
17	* 0 IR 021\r	Aspect ratio 16:9
18	* 0 IR 022\r	Aspect ratio 4:3
19	* 0 IR 023\r	Volume +
20	* 0 IR 024\r	Volume –
21	* 0 IR 025\r	Brightness
22	* 0 IR 026\r	Contrast
23	* 0 IR 027\r	Color Temperature
24	* 0 IR 030\r	Hide
25	* 0 IR 031\r	Source
26	* 0 IR 032\r	Video: Color saturation adjustment
27	* 0 IR 033\r	Video: Hue adjustment
28	* 0 IR 034\r	Video: Sharpness adjustment
29	* 0 IR 035\r	Query Model name

No	Code (character)	Function feature
30	* 0 IR 036\r	Query Native display resolution
31	* 0 IR 037\r	Query company name
32	* 0 IR 042\r	Keystone Up
33	* 0 IR 043\r	Keystone Down
34	* 0 IR 046\r	Zoom
35	* 0 IR 047\r	e-Key
36	* 0 IR 048\r	Color RGB
37	* 0 IR 049\r	Language

Note: The command with end "\r" means "Enter".