

ULTRA-CURVE® PRO DSP8024



User's Manual

Version 1.2 June 2001

ENGLISH



www.behringer.com

SAFETY INSTRUCTIONS

CAUTION: To reduce the risk of electric shock, do not remove the cover (or back). No user serviceable parts inside; refer servicing to qualified personnel.



WARNING: To reduce the risk of fire or electric shock, do not expose this appliance to rain or moisture.



This symbol, wherever it appears, alerts you to the presence of uninsulated dangerous voltage inside the enclosure—voltage that may be sufficient to constitute a risk of shock.



This symbol, wherever it appears, alerts you to important operating and maintenance instructions in the accompanying literature. Read the manual.

DETAILED SAFETY INSTRUCTIONS:

All the safety and operation instructions should be read before the appliance is operated.

Retain instructions:

The safety and operating instructions should be retained for future reference.

Heed warnings:

All warnings on the appliance and in the operating instructions should be adhered to.

Follow instructions:

All operation and user instructions should be followed.

Water and moisture:

The appliance should not be used near water (e.g. near a bathtub, washbowl, kitchen sink, laundry tub, in a wet basement, or near a swimming pool etc.).

Ventilation:

The appliance should be situated so that its location or position does not interfere with its proper ventilation. For example, the appliance should not be situated on a bed, sofa rug, or similar surface that may block the ventilation openings: or placed in a built-in installation, such as a bookcase or cabinet that may impede the flow of air through the ventilation openings.

Heat:

The appliance should be situated away from heat sources such as radiators, heat registers, stoves, or other appliances (including amplifiers) that produce heat.

Power source:

The appliance should be connected to a power supply only of the type described in the operating instructions or as marked on the appliance.

Grounding or polarization:

Precautions should be taken so that the grounding or polarization means of an appliance is not defeated.

Power-cord protection:

Power supply cords should be routed so that they are not likely to be walked on or pinched by items placed upon or against them, paying particular attention to cords and plugs, convenience receptacles and the point where they exit from the appliance.

Cleaning:

The appliance should be cleaned only as recommended by the manufacturer.

Non-use periods:

The power cord of the appliance should be unplugged from the outlet when left unused for a long period of time.

Object and liquid entry:

Care should be taken so that objects do not fall and liquids are not spilled into the enclosure through openings.

Damage requiring service:

The appliance should be serviced by qualified service personnel when:

- the power supply cord or the plug has been damaged; or
- objects have fallen, or liquid has been spilled into the appliance; or
- the appliance has been exposed to rain; or
- the appliance does not appear to operate normally or exhibits a marked change in performance; or
- the appliance has been dropped, or the enclosure damaged.

Servicing:

The user should not attempt to service the appliance beyond that which is described in the operating instructions. All other servicing should be referred to qualified service personnel.

FOREWORD

Dear Customer,

welcome to the team of ULTRA-CURVE PRO users and thank you very much for expressing your confidence in BEHRINGER products by purchasing this unit.

It is one of my most pleasant tasks to write this letter to you, because it is the culmination of many months of hard work delivered by our engineering team to reach a very ambitious goal: making an outstanding device better still. The ULTRA-CURVE has for quite a long time been a standard tool used by numerous studios and PA rental companies. The task to improve one of our best-selling products certainly meant a great deal of responsibility, which we assumed by focusing on you, the discerning user and musician. It also meant a lot of work and night shifts to accomplish this goal. But it was fun, too. Developing a product usually brings a lot of people together, and what a great feeling it is when everybody who participated in such a project can be proud of what we've achieved.

It is our philosophy to share our joy with you, because you are the most important member of the BEHRINGER family. With your highly competent suggestions for new products you've greatly contributed to shaping our company and making it successful. In return, we guarantee you uncompromising quality (manufactured under ISO9000 certified management system) as well as excellent technical and audio properties at an extremely favorable price. All of this will enable you to fully unfold your creativity without being hampered by budget constraints.

We are often asked how we can manage it to produce such high-grade devices at such unbelievably low prices. The answer is quite simple: it's you, our customers! Many satisfied customers means large sales volumes enabling us to get better conditions of purchase for components, etc. Isn't it only fair to pass this benefit back to you? Because we know that your success is our success, too!

I would like to thank all people whose help on "Project ULTRA-CURVE PRO" has made it all possible. Everybody has made very personal contributions, starting from the designers of the unit via the many staff members in our company to you, the user of BEHRINGER products.

My friends, it's been worth the trouble!

Thank you very much,

A handwritten signature in black ink, consisting of a stylized 'U.' followed by a long horizontal line that ends in a small upward tick.

Uli Behringer

ULTRA-CURVE PRO

Ultra-high performance digital stereo mainframe powered by two 24-bit high-speed digital signal processors

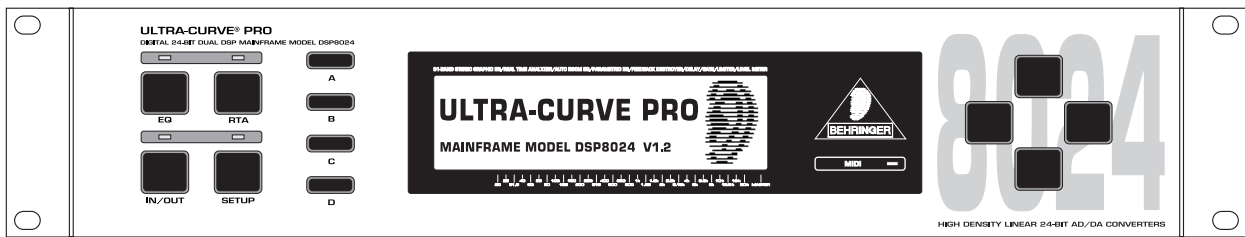

- ▲ High-end AKM and CRYSTAL 24-bit AD/DA converters for ultra-high dynamic range and resolution
- ▲ Open-ended & “future-proof” architecture allows for future software upgrades
- ▲ Ultra-musical dual 31-band graphic equalizer with “true frequency response” characteristics
- ▲ Low/high/bell shelving tool with variable slope (3 - 30 dB)
- ▲ Real time analyzer with peak hold, variable integration, cursor read-out and 10 user-memories
- ▲ Automatic room equalization using microphone input and internal noise generator
- ▲ Additional 6 bands of fully parametric equalizer/notch filter with up to 1/60th octave bandwidth
- ▲ Integral fully automatic feedback destroyer with intelligent signal analyzer for ultra-fast feedback suppression
- ▲ Integral digital “brick wall” limiter protects against any clipping and dangerous sound pressure levels
- ▲ Integral digital noise gate with BEHRINGER’s unique IRC (Interactive Ratio Control)
- ▲ Integral delay with up to 2.5 seconds delay time selectable in milliseconds, meter and feet
- ▲ Ultra-accurate level peak meter with peak hold and selectable reference levels (+4 dBu/-10 dBV/DIG MAX)
- ▲ Full MIDI parameter and snapshot control for realtime editing
- ▲ Free EQ-Design software allows for total remote control via PC (download at www.behringer.com)
- ▲ 100 user memories can be stored under any alphabetic name. Memory backed by a long-life battery
- ▲ Security key password can be installed for user selective RTA and EQ memory protection and unattended use
- ▲ EQ and analyzer curves may be copied, compared, added or subtracted for extreme flexibility
- ▲ Crossfade feature to fade between two settings and stereo link facility to synchronize both channels
- ▲ 24-bit AES/EBU interface for digital inputs and outputs at 32, 44.1 and 48 kHz (optional)
- ▲ Large high-resolution LCD graphic display with high-contrast LED backlight
- ▲ Servo-balanced inputs and outputs on gold-plated XLR and 1/4" TRS connectors for high signal integrity
- ▲ Relay-controlled hard-bypass with an auto-bypass function during power failure (failsafe relay)
- ▲ High-quality components and exceptionally rugged construction ensure long life and durability
- ▲ Internal power supply design for professional applications
- ▲ Manufactured under ISO9000 certified management system

TABLE OF CONTENTS

1. INTRODUCTION	6
1.1 The design concept	6
1.2 Before you begin	6
1.3 Control elements	7
2. OPERATION	8
2.1 EQ mode	9
2.1.1 Operating the graphic equalizer	9
2.1.2 The level meter	9
2.1.3 The FEEDBACK DESTROYER	10
2.1.4 Delay	11
2.1.5 Equalizer editing	11
2.1.6 EQ setup	13
2.2 Real time analyzer	14
2.2.1 Program administration	15
2.2.2 Toolbox	15
2.2.3 Choosing a source	15
2.2.4 Decay	15
2.2.5 RTA setup	16
2.3 AUTO-Q function	17
2.4 General setup	18
3. APPLICATIONS	20
3.1 Using the ULTRA-CURVE PRO as a summing EQ in a PA	20
3.2 Using the ULTRA-CURVE PRO for monitor EQ purposes	22
3.3 Using the ULTRA-CURVE PRO in the recording studio	23
3.4 The ULTRA-CURVE PRO as a delay unit	23
4. "TRUE RESPONSE" CHARACTERISTIC	25
5. ULTRA-CURVE PRO structure	26
5.1 Hardware	26
5.2 EQ mode	27
5.3 RTA mode	28
6. INSTALLATION	29
6.1 Mains connection	29
6.2 Audio connections	29
6.3 Digital audio connections per AES/EBU (optional)	30
6.4 MIDI connections	31
7. APPENDIX	31
7.1 AES8024 option	31
7.2 Changing the memory protect battery	31
7.3 MIDI implementation	32
7.4 Software	33
8. TECHNICAL SPECIFICATIONS	34
9. WARRANTY	36

1. INTRODUCTION

The BEHRINGER ULTRA-CURVE PRO is a fully digital sound processing device based on DSPs and 24-bit A/D and D/A converters. The high-speed DSPs are capable of performing any process in fractions of a second, the only element governing their performance being the software. The enormous flexibility available means that the ULTRA-CURVE PRO has a range of features greatly exceeding those found in a conventional analog graphic equalizer—at a price previously unimaginable.

The BEHRINGER ULTRA-CURVE PRO has two channels which can be used independently or coupled via software.

 **The following operational manual will introduce you to the ULTRA-CURVE PRO and its various functions. After reading the manual carefully, make sure it is always on hand for future reference.**

1.1 The design concept

The philosophy behind BEHRINGER products guarantees a no-compromise circuit design and employs the best choice of components. Top-quality 24-bit AD/DA converters which belong to the best components available owing to its outstanding specifications and excellent sonic characteristics. Two 24-bit DSPs are used as the heart of the ULTRA-CURVE PRO. These perform the precise calculations needed for the processing of the complex algorithms. Additionally, the ULTRA-CURVE PRO uses high quality resistors and capacitors with very tight tolerances, high-grade switches, ultra low-noise operational amplifiers as well other selected components.

The ULTRA-CURVE PRO DSP8024 uses SMD technology (Surface Mounted Device). These subminiature components known from aerospace technology allow for an extreme packing density, plus the unit's reliability could be improved. Additionally, the unit is manufactured in compliance with the ISO9000 certified management system.

Fail-safe relays have been incorporated into the design of the BEHRINGER ULTRA-CURVE PRO, which automatically and silently bypass the unit in the event of power supply disconnection or failure. These relays are also active at switch-on to isolate the ULTRA-CURVE PRO until the power rails have settled, thus preventing the possibility of a potentially damaging switch-on thump.

1.2 Before you begin

Your BEHRINGER ULTRA-CURVE PRO was carefully packed in the factory and the packaging was designed to protect the unit from rough handling. Nevertheless, we recommend that you carefully examine the packaging and its contents for any signs of physical damage, which may have occurred in transit.

 **If the unit is damaged, please do not return it to us, but notify your dealer and the shipping company immediately, otherwise claims for damage or replacement may not be granted. Shipping claims must be made by the consignee.**

The BEHRINGER ULTRA-CURVE PRO fits into two standard 19" rack unit of space (2 U). Please allow at least an additional 4" depth for the connectors on the back panel.

Be sure that there is enough space around the unit for cooling and please do not place the ULTRA-CURVE PRO on high temperature devices such as power amplifiers etc. to avoid overheating.

 **Before you connect your ULTRA-CURVE PRO to the mains, please make sure that your local voltage matches the voltage required by the unit!**

The mains connection of the ULTRA-CURVE PRO is made by using a mains cable and a standard IEC receptacle. It meets all of the international safety certification requirements.

 **Please make sure that all units have a proper ground connection. For your own safety, never remove or disable the ground conductor of the unit or of the AC power cable.**

As standard, the BEHRINGER ULTRA-CURVE PRO is installed with electronically servo-balanced inputs and outputs. The circuit design features automatic hum rejection for balanced signals, permitting trouble-free operation even at the highest operating levels. Externally induced power-line hum, etc. is thus suppressed effectively.

The automatic servo function recognizes the presence of unbalanced connectors and adjusts the nominal level internally to avoid level differences between the input and output signals (6 dB correction).

The optional digital input and output (AES/EBU interface) connections are balanced with a negative ground. High-quality connectors ensure isolated, noise-free signal throughput. The MIDI connections (IN/OUT/THRU) have been realized with standardized DIN plug-in connectors. Optocouplers have been used for isolated data communications.

1.3 Control elements

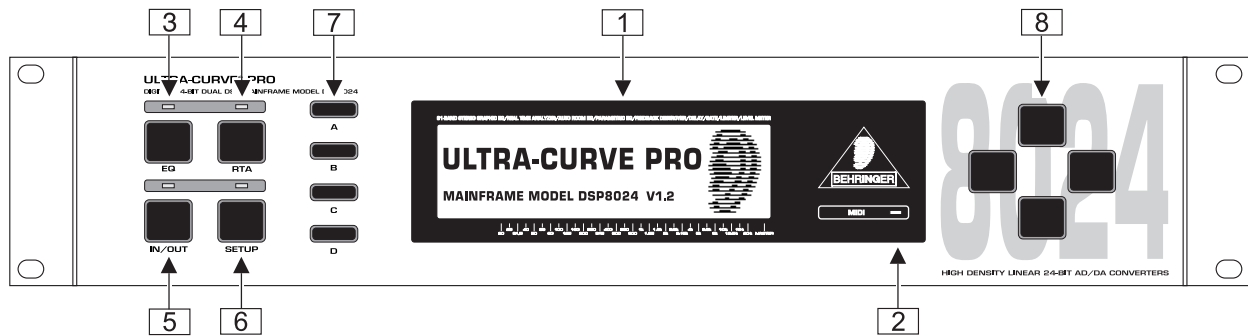



Fig. 1.1: The control surface of the ULTRA-CURVE PRO

- 1 The heart of the front panel is the LED backlighted 240 x 64 active *DISPLAY*. The control of the ULTRA-CURVE PRO is centered around the central display. The user interface is for a large part graphical, complemented by four text based setup menus. The function of the softkeys is displayed right next to these keys, their function changes to accommodate different features.
- 2 To the right of the display you will find the *MIDI LED* which registers incoming MIDI messages.
- 3 The *EQ* key switches the ULTRA-CURVE PRO into equalizer mode. In this mode, the EQ, FEEDBACK DESTROYER, LIMITER and DELAY functions may be used.
- 4 The *RTA* key switches the ULTRA-CURVE PRO into analyzer mode. This mode is solely concerned with measuring and signal generation, the sound will not be affected!
- 5 *IN/OUT* key. The ULTRA-CURVE PRO can be switched into the signal path (LED is green) or switched out (bypass, LED dark). The LED flickering red indicates DSP overflow. This does not necessarily mean "clipping". Flickering starts as soon as an internal overflow in one of the filters occurs, while input and output levels may be o.k. When this LED lights up often, reduce the input level or the ULTRA-CURVE PRO's gain level.
- 6 The *SETUP* key allows entry into the setup menus where all the basic adjustments of the device are to be found, such as the choice of input source, sample rate, password protection, MIDI configuration etc. Pressing once will open either the EQ setup or RTA setup, depending on the function of the unit. Holding the key down for two seconds or more will open the general setup windows consisting of a global setup and a MIDI setup window. Pressing the setup key here will toggle between both general setup windows.
- 7 To the left of the display four *SOFTKEYS*, labelled A, B, C and D respectively, are to be found arranged vertically. Their functions can be defined by the user software and displayed to the immediate right of each key by the appropriate pictogram in the display. Each pictogram and its associated functions will be comprehensively explained in chapter 2. You will find function diagrams for both EQ and RTA mode as well as a list of all pictograms used on an extra sheet.
- 8 To the right of the display the *CURSOR KEYS* are to be found. These are used:
 1. to select individual filter frequencies, and the master fader in equalizer mode (horizontal)
 2. to adjust the value of each selected frequency (vertical)
 3. to position the measurement cursor in analyzer mode (horizontal)
 4. in both operating modes, to choose the program position (vertical)
 5. to select a field in the SETUP menu (horizontal and vertical)

 In each case pressing on the opposite key while holding the key being used will accelerate the operation being carried out.

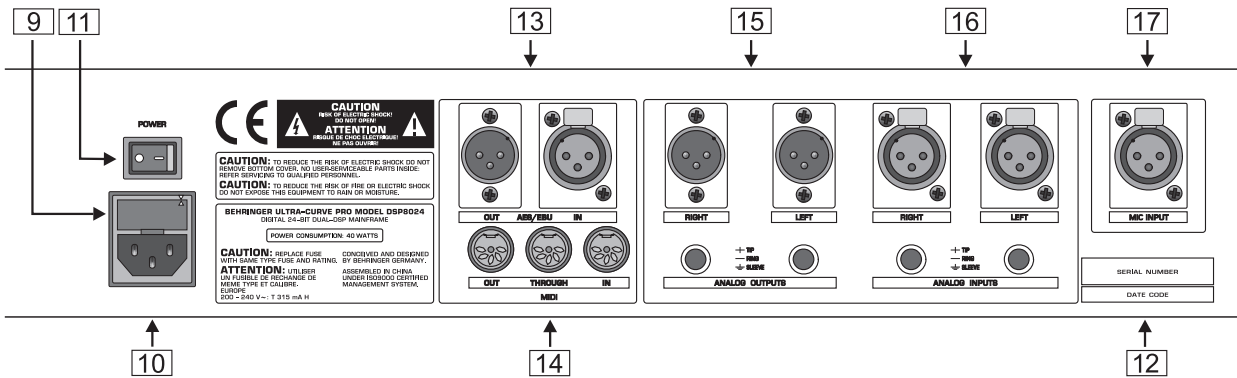

Fig. 1.2: The rear panel layout of the ULTRA-CURVE PRO

- 9 This is the **MAINS CONNECTOR/FUSE HOLDER/VOLTAGE SELECTOR**. Before you connect the unit, please make sure that the displayed voltage corresponds to your mains supply. Please note that, depending on the mains voltage supplied to the unit, the correct fuse type and rate must be installed. In some units, the fuse holder can be inserted in two positions to switch between 220 to 240 V and 100 to 120 V. Please note that a higher fuse rating must be used when operating the unit outside of Europe with 115 V (see chapter 6 “INSTALLATION”).
- 10 Please use the enclosed mains cable to connect the unit to the mains power supply.
- 11 The **MAINS SWITCH** is to be found above the mains socket. The switch is situated on the rear panel to make the ULTRA-CURVE PRO tamper proof with unattended use. The unit will bypass on power failure but cannot be bypassed when a password is set.
- 12 **SERIAL NUMBER**. Please take the time to have the warranty card filled out completely by your specialized dealer, and return it within 14 days after the date of purchase, so as to be entitled to benefit from our extended warranty. You may also use our online registration option available on the Internet at www.behringer.com.
- 13 **AES/EBU IN** and **AES/EBU OUT**. These are the ULTRA-CURVE PRO’s digital input and output (optional). The analog output signal is also present at the (analog) outputs when the digital out is used. Both signals can be used in parallel.
- 14 These are the ULTRA-CURVE PRO’s **MIDI connectors (MIDI IN/OUT/THRU)**. Via these connectors total remote control is possible.
- 15 **ANALOG OUTPUTS**. These are the ULTRA-CURVE PRO’s analog outputs. When the AES/EBU option is installed the analog output will still be present at these outputs, so that both analog and digital out can be used in parallel.
- 16 These are the ULTRA-CURVE PRO’s **ANALOG INPUTS**.
- 17 This is the **MIC INPUT** socket for the reference microphone.

2. OPERATION

The BEHRINGER ULTRA-CURVE PRO is a flexible, universally applicable sound processing and measurement device, whose operations may be divided into two basic areas; signal processor (equalizer, limiter) or real Time analyzer (RTA). For this reason, you always operate in either EQ or RTA mode. Simultaneous operation of both is not possible!

Upon switching on the ULTRA-CURVE PRO you will be presented either the main equalizer (EQ), or analyzer (RTA) window. By pressing the EQ or RTA key, the ULTRA-CURVE PRO will switch from RTA- into EQ mode and vice versa. When the ULTRA-CURVE PRO is switched from one mode to the other, the outputs will be briefly muted.

2.1 EQ mode

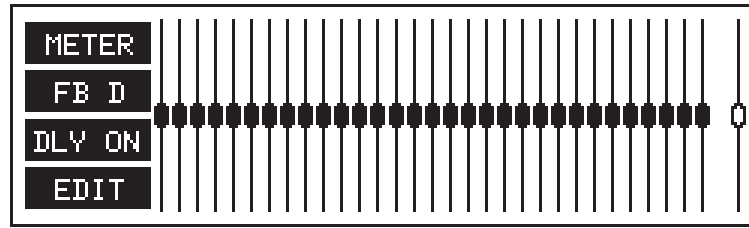

Fig. 2.1: Main EQ window of the ULTRA-CURVE PRO

The display shows a 31-band graphic equalizer, along with the main fader for overall level control—slightly separated on the right hand side. On the left are the pictograms for the softkeys, which are used to open the sub-menus.

2.1.1 Operating the graphic equalizer

The selected controller is illustrated highlighted in the display. The vertical cursor keys are used to adjust levels, the horizontal keys to select the controller to be adjusted. When you depress a cursor key, an information window appears showing the selected frequency, the level of boost or attenuation applied to each of the two channels, as well as the program number and program name:

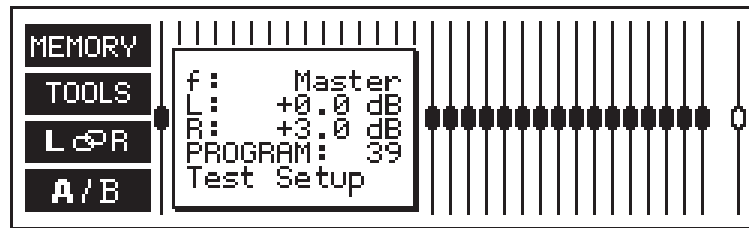

Fig. 2.2: Graphic EQ information window

The information window disappears after four seconds if no further key has been pressed.

Depressing a key once will result in a parameter changing by the smallest applicable increment. The adjacent fader will be selected, or a level will be adjusted by 0.5 dB. Depressing and holding the cursor key results in a continuous change in the parameter. The rate of change remains constant. You can increase the rate of change by first depressing and holding the key used to change the relevant parameter, and then—still holding the first key—depress the one opposite.

2.1.2 The level meter

By pressing softkey A **METER** you leave the main EQ window and access the menu to display levels.

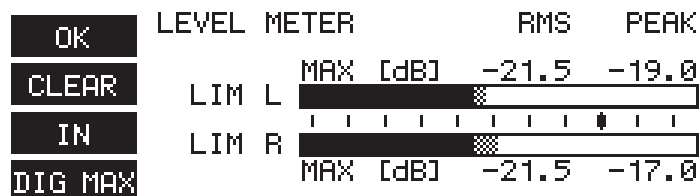

Fig. 2.3: LEVEL METER display

You can use the level meter to control the input and output levels of the ULTRA-CURVE PRO. The bargraph display controls the effective RMS level (massive parts of the bars), and the peak level (checkered tips of the bars), both simultaneously. To save your eyes, the release time of the peak display is 20 dB/s. The maximum levels are memorized and numerically displayed.

When the limiter threshold is exceeded, the indication LIM will appear in the level meter display to indicate that the limiter is attenuating the output.

With softkey A **OK** you leave the level meter, and return to the main EQ window.

With softkey B **CLEAR** you erase the maximum levels from the memory.

With softkey C **IN / OUT** you switch the display from the ULTRA-CURVE PRO input and output.

With key D you can choose between three different tables of reference levels. The 0 dB point is indicated by a bold marker, while at the same time, the numerical display changes. **Dig max** refers to the digital peak level. This level may not—under any circumstances—be exceeded! This will result in a very noticeable form of distortion, which occurs much faster, and sounds very much more unpleasant, than the familiar distortion associated with analog devices. **+4dBu** refers to the operating level found in professional audio equipment (analog inputs and outputs of the ULTRA-CURVE PRO). **-10dBV** refers to the operating level found in homerecording and domestic audio equipment, a typical example being tape recorders with RCA connectors. When setting the ULTRA-CURVE PRO internal level, or when using the optional AES/EBU interface, the peak level display of the DIG MAX scale is the only one to use. The +4 dBu and -10 dBV scales serve to monitor the analog inputs and outputs of the ULTRA-CURVE PRO.

Please note that the RMS level will usually be quoted in the technical specifications of analog devices for example, for the input sensitivity of power amplifiers. The effective level always lies below the peak level.

👉 The difference between them depends on the signal characteristics for a static sine wave, the effective level is about 3 dB below the peak level. For a dynamic signal the difference is in the region of 8 dB.

The DIG MAX level is, of course, related to the analog input and output levels, as 0 dB DIG MAX corresponds to the maximum output level of the ULTRA-CURVE PRO. The following example, using a sine wave at maximum amplitude, clearly illustrates the relationship between the various scales:

Scale	Reading	
	RMS	PEAK
DIGMAX	-3 dB	0 dB
+4 dBu	+6 dB	+12 dB
-10 dBV	+21 dB	+24 dB
Maximum level:	+16 dBu	

Tab. 2.1: Level meter scale correlation

As can be seen from the above table, the ULTRA-CURVE PROs maximum analog output level is +16 dBu, or +14 dBV.

The ULTRA-CURVE PROs analog inputs can handle signals of up to +21 dBu, but it is important to remember that, in case of such high input levels, the digital limiter may operate if the level in the equalizer is not appropriately lowered. Please refer to the operation of the digital limiter explained in section 2.1.6.

2.1.3 The FEEDBACK DESTROYER

By pressing softkey B **FB-D** you leave the main EQ window and go into the FEEDBACK DESTROYER menu.

	MODE	FREQUENCY	BW[OCT]	G[dB]
+	L: AUT	20.000 Hz	1/60	+0.0
+	R: SGL	20.000 Hz	1/60	+0.0
-	L: LCK	20.000 Hz	1/60	+0.0
-	R: OFF	20.000 Hz	1/60	+0.0
-	L: PAR	20.000 Hz	1/60	+0.0
-	R: PAR	20.000 Hz	1/60	+0.0

Fig. 2.4: FEEDBACK DESTROYER menu

The display will show the current settings for all six of the ULTRA-CURVE PRO parametric equalizers (selected frequency, bandwidth and degree of boost or attenuation). Additionally it will show whether the parameters are fixed (PAR), or are set for automatic search, to function as the FEEDBACK DESTROYER (AUT or SGL). Auto

search means that the audio signal is continuously examined for signs of feedback. If feedback is detected, the ULTRA-CURVE PRO will assign an appropriate filter to the relevant frequency and apply narrow band attenuation, also known as a “notch filter”. The parameters which have been used will be continuously displayed.

The next feedback will be dealt with by the next available filter. When all the filters have been used, and feedback still occurs, the filter used for the first, or oldest frequency will be released to deal with the newest one. If feedback occurs very close to a frequency already being treated, or reappears at a frequency to which a filter has already been applied, the filter already in use will have its parameters changed to deal with the new problem—i. e. the bandwidth will be widened, or the attenuation increased.

In single shot mode (SGL) the filter will not release a setting which has been achieved, this is particularly useful with problems at fixed frequencies like turntable resonances and fixed microphone and monitor positions. If feedback is detected the filter will deal with that frequency and the status of that filter will change to locked (LCK). It will only widen its bandwidth or increase the attenuation but it will not release that frequency to deal with a new feedback frequency. Please note the application example in section 3.2.

2.1.4 Delay

By pressing softkey C **DLV ON/ DLV OFF** the built in signal delay can be switched on or off. The display shows the current status:

1. **DLV OFF** = switched off
2. **DLV ON** = switched on, signal will be delayed by the preset numerical value.

You can set the delay time in the EQ SETUP menu (see chapter 2.1.6). Among its many uses, it can be used to compensate for time path differences between two sets of loudspeakers set at different distances to the listener. See chapter 3.4 for an application example.

2.1.5 Equalizer editing

By pressing softkey D **EDIT** or by using a cursor key, the function of the softkeys is changed, and this is highlighted by a new set of pictograms. With these, you can access either further sub-menus with their own functions, or carry out important switching functions. We remind you to the function diagrams on the extra sheet. They give you an overview of the way all the menus and sub menus are inserted into one other, in EQ and RTA mode respectively.

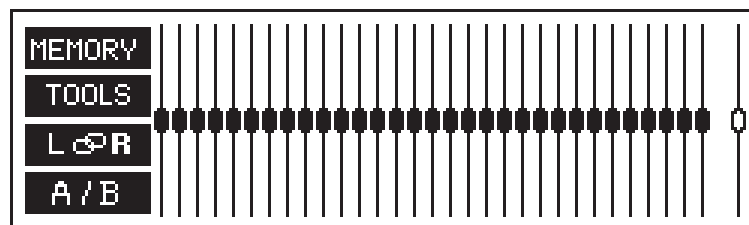

Fig. 2.5: EQ EDITING display

You can now enter with softkey A **MEMORY** the program administration to store, load and name settings with softkey B **TOOLS** the tools menu, with softkey C **L ↔ R/ L ↔ R** the channel switching (stereolink on), **L / R** the channel switching (stereolink off) and with softkey D **A / B / A / B** the comparison functions.

Program administration

A program contains the settings for the graphic equalizer, the parametric filters and the delay. Softkey A **MEMORY** allows access to further sub menus which are used to organize the program administration:

a) Loading programs

Softkey A **LOAD**: This shows, in the equalizer display, the same information window as shown when operating a fader. However, in contrast to normal equalizer operation, you cannot change the level with the cursor key, instead you can select a new program. You can confirm this with **OK** or cancel it with **CANCEL**. In both cases you are then returned back to the EDIT menu.

Using softkey D **CLEAR** you can reset all the current ULTRA-CURVE PRO settings—the graphic equalizer, the parametric filters (also in feedback destroyer mode) and the delay—to zero. You will first be presented with the

question "CLEAR PROGRAM IN MEMORY?" which can be confirmed with **OK**. By using **CANCEL** you can stop at this point and leave the settings as they are.

We recommend that you make use of this feature whenever you have something completely new to do and have to start from scratch. This way, you can carry on without the danger that maybe an old feedback destroyer setting is in the place which could cause problems. In any case it is the quickest and most convenient way to reset all the parametric filters.

b) Saving programs

Softkey B **STORE**: The procedure of saving a program is analogous to that of loading one. The memory location is selected with the vertical cursor keys, is confirmed with **OK** or cancelled with **CANCEL**. If a program location is already occupied, the warning "OVERWRITE PROGRAM?" will appear. Pressing **OK** once more allows you to confirm the save, **CANCEL** means it does not take place, and the program already in place remains undisturbed. When **OK** is pressed a window is opened where the name can be entered when an empty memory place is used or the previous name can be edited.

Important to note here is that program names can have a maximum of twelve characters. You will see a window in the equalizer display, showing the available characters. Choose the character you require with the cursor key, which is to be found in the part of the name field highlighted by blinking. You can change position using the arrows keys **←** / **→**, **CLEAR** removes all characters. Having completed the name you wish to use, pressing **OK** returns you to the EDIT menu.

c) Additive and subtractive editing of programs

Load firstly the program to which you wish to add or subtract another program, then press softkey D **CALC**. In the pictograms either a plus or a minus will appear or disappear. If you now wish to load and add a program onto the one already in memory, press softkey D **CALC** until a + appears. Using key A **LOAD+**, you can now choose and load a further program, which will be added to the one already in memory. The same procedures apply for subtraction and saving.

The tools menu

Using softkey B **TOOLS** you can enter the sub-menus which contain a number of tools to edit the graphic equalizer. They affect the selected channel, except when the stereolink function is active (see section 2.1.6) when they effect both channels.

a) Resetting all faders to zero

Softkey A **ZERO**: All the graphic equalizer faders including the master fader will be reset to zero. Having carried this out, you can confirm the changes made with **OK** or you can cancel them with **CANCEL**. In either case, you will be then returned to the EDIT menu. With softkey C **L↔R** / **L↔R** or **L** / **R** respectively, you can check the status of each channel on the display, before confirming the changes as mentioned above. While doing this, you cannot make any other changes.

b) Inverting the current settings

Softkey B **INVERT**: This causes the levels of all the graphic faders, with the exception of the master fader, to invert. I. e. a value of +5 becomes -5, -2 becomes +2 etc. This edit can be confirmed as above.

c) Copying the current setting to the other channel

Softkey C **L→R** / **L←R**: The current setting will be copied to the other channel. Confirmation as above.

d) The shelving tool

Softkey D **SHELV**: You will be presented with the shelving menu. By repeatedly pressing softkey D you can switch between three different tools:

 creates a shelving curve below the selected frequency.

 creates a shelving curve above the selected frequency.

 creates a peaking response centered on the selected frequency.

You can use the horizontal cursor keys to choose the frequency at which or from which the tool will operate. You can use the vertical cursor keys to adjust the level. The shelving function is always superimposed upon any graphic or parametric curve already existing in RAM. In other words, the relative levels of adjacent frequency bands are maintained, while the overall slope is altered. You can create curves with varying slopes, the slope can be adjusted, in 3 dB steps, from a slope of 6 to 30 dB per octave.

Having confirmed the edit with **OK**, the ULTRA-CURVE PRO will leave the shelving mode, and return to the EDIT menu. By pressing **CANCEL** the settings made in the shelving menu will be cancelled, and you return to the EDIT menu.

Channel switching

In the EDIT menu, you can switch back and forth between the two channels, using softkey C. The pictogram for softkey C will show you which channel is active, and whether or not the channels are connected to each other via the stereolink function:

- L R** left channel, stereolink on
- L R** right channel, stereolink on
- L** left channel, stereolink off
- R** right channel, stereolink off.

Comparison functions

Softkey D **A/B** (A highlighted) or **A/B** (B highlighted) allows you to compare the current setting with the settings pertaining to the program as it was loaded.

- A/B** (A highlighted) denotes the program as it was on loading.
- A/B** (B highlighted) denotes the most recent setting.

If you are not satisfied with the new setting, you can return to **A/B** (A highlighted), and from there you can start again. Once you start to edit, the pictogram will change to **A/B** (B highlighted), immediately showing the new status of the program. Upon loading a new program, **A/B** (neither A nor B highlighted) will be shown, indicating the “not-yet-edited” status of the program.

2.1.6 EQ setup

You can access the EQ SETUP menu by pressing the SETUP key while the ULTRA-CURVE PRO is in EQ mode. The EQ SETUP window appears in the display and the LED above the SETUP key starts to flash.

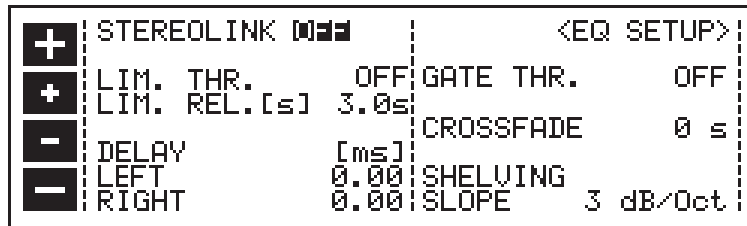

Fig. 2.6: EQ SETUP window

You can use the cursor key to choose either the value or the condition to be changed. The active edit field will be highlighted by being displayed inverted. You can change status or value by using the softkeys marked **-/-** and **+/+** respectively.

STEREO LINK ON

The intelligent stereolink function links the two channels, forming a stereo pair, in which all adjustments made have an equal, simultaneous effect on both channels. It is important to understand that this also applies when the two channels have different response curves set! The edits performed will make adjustments of equal value, independent of the original settings. For example: right channel, fader 4 was at +3, increasing 5 dB bring it to +8. Left channel, fader was at -4. It will be moved to +1 (in other words, the incremental changes are the same on both channels, but the absolute settings may still differ from each other). A further point to watch out for is the situation where a fader on one channel has been raised by a value which will take the corresponding fader on the other, linked channel above the maximum boost which the ULTRA-CURVE PRO is capable of making, namely 16 dB. Because this is not possible, all the other faders will be automatically attenuated by the appropriate amount, and the master channel fader will be raised in compensation, in order to achieve the desired frequency response.

STEREO LINK OFF

Switches off the channel link. The two channels can now be set fully independent of each other.

CROSSFADE

The CROSSFADE function causes a “soft” or gradual transition from one program when switching into another. This helps prevent any clicks or other noises, which can be caused by very sudden changes to a program. The faders are seen to creep to their new positions on the display. You may choose the time taken for this to occur, from 0 to 15 seconds being allowed. Please note that a setting of 0 seconds results in a “hard” switch over,

possibly causing the noises mentioned above.

SHELVING SLOPE

This is a tool which you can use to easily add high shelving, low shelving and bell-shaped response curves to the graphic equalizer (see section 2.1.5 on previous page).

LIMIT THRESHOLD

The ULTRA-CURVE PRO has an integrated digital limiter to protect against overloading and resulting distortion. Its Attack Time is zero, in other words, it reacts “in advance”. This way it acts as a real “brick wall” and can be used in combination with the security password to create a absolute limiter to prevent noise pollution.

The operating threshold of the limiter can be set, in 1 dB steps, anywhere from 0 dB down to -36 dB. The levels given in dB are relative to the maximum output signal (DIG MAX) of the ULTRA-CURVE PRO (0 dB DIG MAX equates to +16 dBu or +14 dBV). Additionally, you can deactivate the limiter by choosing the setting OFF.

LIMIT RELEASE

When the signal falls below the limiter threshold, the gain reduction is returned to zero. The rate of change is governed by a time constant (release time) which can be defined between 0.5 and 5 seconds.

NOISE GATE THRESHOLD

You can mute noise (e. g. from a mixing desk, or keyboards) which might appear during program pauses, by using the built in NOISE GATE function. As soon as the signal level is lower than the Threshold you will have set, the ULTRA-CURVE PRO's outputs will be muted. The Threshold may be anywhere from OFF to -44 dB, the scale again referring to the digital maximum. Additionally, you can deactivate the noise gate by choosing the setting OFF.

DELAY

The delay is adjustable in steps of 0.1 ms. The maximum delay time you can choose is limited to 2.5 seconds—for both channels independently, of course. You can adjust the delay value in meters and feet as well. The edited value is automatically converted (temperature 20° C and relative air humidity of 80%).

2.2 Real time analyzer

The integrated real time analyzer of the BEHRINGER ULTRA-CURVE PRO enables 1/3-octave measurements with a precision of 0.25 dB. Of course, you can adapt the display to your own needs and habits. By pressing the RTA key you enter the RTA mode.

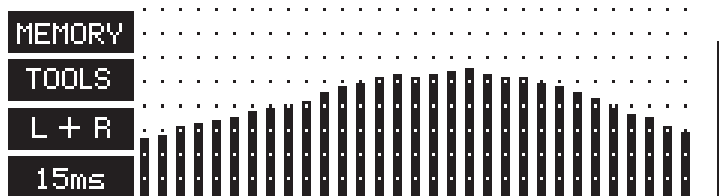

Fig. 2.7: Main RTA window

The RTA display shows the 31 1/3-octave frequencies, with the overall level to the right, similar in general to the equalizer display. To the left is the pictogram containing the softkeys. By moving the horizontal cursor keys or the one pointing upwards, you can “freeze” the display, simultaneously displaying a set of crosshairs, and an information window (see figure on top of next page). Using the cursor key pointing downwards will make the crosshairs and the information window disappear as well as “de-freeze” the display. The information window displays the precise values pertaining to the selected frequency, along with the number of the RTA program currently in use. By moving the crosshairs to any given frequency band, or the overall level, you can display the details of the chosen band in the information window.

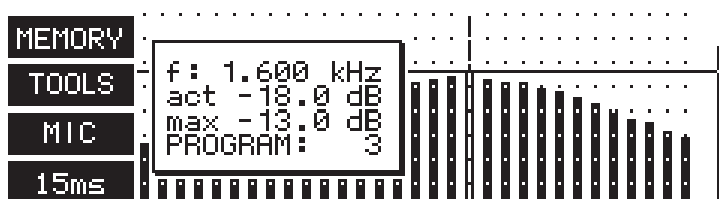

Fig. 2.8: RTA display with information window

f: the frequency in Hertz of the selected band,

act: the level present as the display was frozen,

max: the highest level reached on this frequency up to the point in time when the display was frozen (the maximum values stored in memory can be replaced).

 **The levels displayed in the RTA refer to the digital maximum.**

PROGRAM: Shows the current RTA program number (1-10). In contrast to EQ programs, it is not possible to name RTA programs.

If after approx. four seconds, no cursor key is pressed, the information window will disappear. The display, however, remains frozen. By re-pressing the RTA key, you can return the ULTRA-CURVE PRO to the dynamic display.

2.2.1 Program administration

By using softkey A **MEMORY** you gain access to the sub-menus used for program administration.

a) Loading measurements

Softkey A **LOAD**: The information window appears in the display, and the measurement will simultaneously be displayed in the selected memory location. You can use the vertical cursor key to select the 10 memory locations. In doing this, their current contents will be displayed. By using **OK** you load the stored measurement. The horizontal cursor may be used here to select individual bands, whose values will also be displayed. **CANCEL** stops the loading procedure. In either case, you will then be returned to the RTA menu. Press the RTA key once more when you wish to leave the stored display, and return to the current, dynamic display.

b) Storing measurements

Softkey B **STORE**: Storing involves the same procedure as loading, you choose the memory location with the vertical cursor keys, confirm with **OK**, cancel with **CANCEL**. In contrast to the equalizer, memory locations already filled will be overwritten without further warning.

c) Transferring measurements to the equalizer

Softkey C **RTA→EQ**: The measurement currently displayed will be transferred to the equalizer, but with its values inverted (+5 becomes -5 etc.). This feature enables minor compensating settings to be easily made. By means of a sub menu you can decide if you want the measurement to be transferred to the left, the right or both channels: **L** left channel, **R** right channel, **L+R** both channels.

2.2.2 Toolbox

Using softkey B **TOOLS**, you can access the toolbox menu. With softkey A **AUTO-Q** you can start the ULTRA-CURVE PRO automatic measurement sequence. You can choose, using a sub menu, whether to have the left, right, or both channels automatically measured. See for the AUTO-Q function chapter 2.3.

With softkey B **HOLD** you can toggle between maximum hold on/off. To indicate that the hold function is on, **HOLD** will become bold.

The softkey C **RESET** will reset the maximum value indicators.

With softkey D **M-GAIN** or **A-GAIN** you can switch between manual and automatic level correction for the RTA display. The pictogram shows the current status. The automatic gain function is very useful in providing an ideal RTA display. Various types of program material and different level will always be displayed conveniently in the middle of the display. In the RTA SETUP menu the gain can be set manually. You can return to the first RTA window by pressing the RTA switch.

 **A quick and convenient way to find a suitable manual gain setting is to engage automatic gain until normal levels are reached and then switch to manual gain.**

2.2.3 Choosing a source

With softkey C you can decide which signal is to be analyzed. The choices available are shown in the pictogram: **L**: The left channel will be measured. **R**: The right channel will be measured. **L+R** mono: the two channels are summed, and then measured. **MIC**: The signal at the reference microphone input will be measured.

2.2.4 Decay

With softkey D **15ms / 65ms / 250ms / 1s** you can set the decay time for measurements. Values of 15, 65, 250 and 1000 milliseconds (1.0 s) can be entered. The current value is shown in the pictogram. Please note that

increasing the decay results in a slower display.

 **Short decays are necessary to display fast processes, whereas using long decays with static signals will result in a “quieter” display, which is usually desirable for this type of signal.**

2.2.5 RTA setup

The RTA SETUP menu is opened by pressing the SETUP key. The RTA SETUP window appears in the display and the LED above the SETUP key flashes.

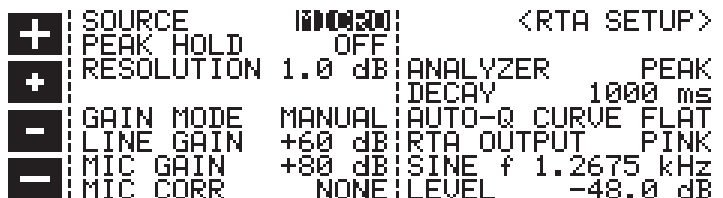



Fig. 2.9: RTA SETUP window

You can use the cursor key to choose the parameters or values you wish to edit. The currently selected field is highlighted by inverting. You can change parameters or values with the softkeys marked  and  respectively.

SOURCE

This field is used, as is the case in the RTA menu to select the signal source for the analyzer. The display here reads as follows: mono, left, right and micro, each referring to the sources available.

PEAK HOLD

ON = peak level indicator ON, OFF = peak level indicator OFF.

RESOLUTION

You can use this field to set the resolution of the graphic display, choosing between 0.5 dB per pixel, or 1 dB per pixel. (A pixel is the smallest single point the display screen can generate). When measuring a steady signal e. g. when using pink noise to adjust a loudspeaker system, the use of the finer resolution is recommended.

ANALYZER

Used to switch the measurement filter between peak and RMS characteristics.

DECAY

Setting the decay: 15, 65, 250 or 1000 milliseconds per 20 dB.

AUTO-Q CURVE

You can use one of the 100 stored equalizer settings as a target curve for the auto-q function. If no program number has been given, “FLAT” will be displayed, meaning that an attempt will be made to achieve a linear response.

GAIN MODE

The ULTRA-CURVE PRO analyzer is capable of setting itself dynamically to suit the input signal level. This frees you from adjusting the input level manually. In this AUTO mode, the gain levels selected by the ULTRA-CURVE PRO will be shown in the respective LINE GAIN and MIC GAIN fields. The automatic adjustment can be switched off (MANUAL).

LINE GAIN

When operating in manual mode, the input amplification for the internal signal is displayed in this field. It can be adjusted, in 4 dB steps, from 0 to 60 dB. (This feature is solely used in RTA mode).

MIC GAIN

As above, for the reference microphone Input. Gain can be adjusted from 20 to 80 dB.

MIC CORR

You can use one of the stored EQ curves as a corrective curve for the analyzer measurement, to compensate for any frequency response variations caused by the reference microphone. In the field the chosen program position, and the chosen side (L/R) are displayed. NONE = no corrective curve.

There are three fields in which you can choose which type of output signal from the ULTRA-CURVE PRO digital generator you wish to use to make a measurement.

RTA OUTPUT

You can choose the type of output signal you need in this field: PINK = pink noise, WHITE = white noise, SINE

= sine wave, OFF = signal generator off or INPUT = input signal.

White noise is composed of multitudes of sine waves packed close together, of equal amplitude, whose phases are random compared to each other (statistically different from each other). Their “density” or, spectral intensity is constant at any given frequency. With pink noise, the spectral intensity is inversely proportional to the frequency. In other words, the intensity of White Noise is constant for an absolute bandwidth e. g. 50 to 100 Hz, or 5,000 to 5,050 Hz whereas for pink noise, the intensity is constant over a relative bandwidth e. g. an octave (50 to 100Hz, 5,000 to 10,000 Hz). The difference between white and pink noise can be highlighted by the following example. By taking a situation where the intensity of both pink and white noise found between 20 and 40 Hz is arranged to be the same for both types of noise, it follows that, in the case of pink noise, the same intensity will be found between 10,000 and 20,000 Hz, both bandwidths being one octave. However, as the number of discrete frequencies between 10,000 and 20,000 Hz is five hundred times greater than between 20 and 40 Hz, it follows that the intensity of White Noise present between these two frequencies is correspondingly greater.

SINE f

You use this field to set the frequency of the sine wave. It is adjustable in 1/60 octave steps from 20 Hz to 20 kHz.

LEVEL

The output level can be adjusted in 1 dB steps from 0 dB to -48 dB (with reference to the digital maximum). The internal digital signal generator is routed into the outputs when you switch into RTA mode. As a rule, pink noise is used for system measurement.

 **Use the RTA-lock function to prevent accidental signal interruption when using the ULTRA-CURVE PRO for live purposes.**

 **Before the noise signal reaches the output of the ULTRA-CURVE PRO, it passes the EQ. That’s why the current EQ settings have an effect on the noise signal. As a result, it may be necessary to reduce the level parameter value to i. e. -12 dB, to prevent clipping.**

2.3 AUTO-Q function

With the AUTO-Q function it is possible to automatically adjust the equalizer of the ULTRA-CURVE PRO. The ULTRA-CURVE PRO measures the total system response including the influence of both the speakers and the room and translates it to the right setting to achieve the desired response.

You can use one of the 100 stored equalizer settings as a target curve for the AUTO-Q function. The curve setting will then correspond to the fader positions of the program selected. (The target curves for each channel may differ from each other). If no program number has been given, “FLAT” will be displayed, meaning that an attempt will be made to achieve a linear response.

It is also possible to use one of the stored EQ curves as a corrective curve for the analyzer measurement, to compensate for any frequency response variations caused by the reference microphone. In the field the chosen program position, and the chosen side (L/R) are displayed. NONE = no corrective curve.

First connect the ULTRA-CURVE PRO as a normal equalizer in the system that will be measured. Connect a reference microphone to the microphone input on the rear panel of the ULTRA-CURVE PRO. Make sure that the RTA setup is correct. The basic settings will be:

Basic settings in the RTA SETUP	
SOURCE	MICRO
GAIN MODE	AUTO
MIC CORR	NONE
AUTO-Q CURVE	FLAT
RTA OUTPUT	PINK

Tab. 2.2: AUTO-Q settings

Pressing softkey A **TOOLS** in the RTA menu will give access to the RTA toolbox. Pressing the softkey A **AUTO-Q** will open the AUTO-Q menu. In this menu it is possible to choose the left, right or both channels to be measured and automatically adjusted. **L** left channel, **R** right channel, **L+R** both channels, first left, then right.

The ULTRA-CURVE PRO automatic measurement procedure has several functions which are designed to prevent unusable settings from being made. For example, it will question whether a band has to be boosted by

more than 12 dB to reach the desired frequency response. If this is the case, you may assume that the loudspeaker system being used is not capable of reproducing this frequency (typically if it is a very low or high frequency). The ULTRA-CURVE PRO will therefore completely avoid the boosting of this frequency to any extent. This will avoid any overloading of the loudspeakers.

Please bear in mind that the test signal passes through the equalizer during the measurement procedure. Therefore, the EQ settings have influence on the manner in which the automatic adjustment takes place. For example: If you lower the level of frequencies below 100 Hz before starting auto-Q, it will result in these frequencies not being adjusted. The level detected by the ULTRA-CURVE PRO in that region will not be sufficient to boost those frequencies. On the other hand, boosting frequencies beforehand can result in them being loud enough to be automatically equalized. This makes sense when they would normally be unaffected by the automatic procedure. You can for instance boost frequencies below 80 Hz or above 10 kHz to extend the frequency range contributing to the measurement. The latter option will put extra strain on the used system but that can be acceptable under certain conditions i. e. when the levels are relatively low and the highest quality sound is required.

The measuring process begins with the automatic levelling. Then you will notice the coloring of the pink noise test signal. This means that the individual EQ-bands are adjusted. When the auto-Q process is finished the ULTRA-CURVE PRO can be set in EQ mode where it automatically displays the achieved EQ setting.

 **After using the auto-Q it is well-advised to even out great differences between individual bands to avoid overflow problems. Especially in the low frequency region it is best to have a more gentle flowing frequency response.**

 **When you want to finish the measuring process prematurely and save the filter setting, press **OK**. By pressing **CANCEL** the measuring process will be aborted, without changing the original setting.**

In the event of the error message “NO SIGNAL DETECTED”, check the measuring microphone. It is possible that the sensitivity is too low. In this case another microphone should be used, or measuring should be carried out over an external preamplifier. The adjusted curve is automatically displayed, you can further edit and save this curve.

It is important to use a high quality reference microphone with a flat frequency response. The BEHRINGER ECM8000 measurement microphone especially designed for this purpose and forms a balanced combination with the ULTRA-CURVE PRO. Correct positioning is also fundamental to achieving a good result. It is often best to perform several measurements on slightly different locations to avoid problems as overcompensating one single position. See chapter 3 for correct microphone positioning.

2.4 General setup

The SETUP menu consists of four windows. Having the EQ or RTA mode active will determine which window is opened on going into SETUP. Pressing the SETUP key for more than two seconds will enter the general setup mode which consists of two windows, the GLOBAL SETUP window and the MIDI SETUP window. These windows contain the basic functions shared by, and affecting both operating modes. The basic configuration will be determined in these windows, which will be referred to as the configuration windows. Pressing the setup key will toggle between page 1 & 2. The other windows can only be reached from here by leaving the SETUP menu by pressing either the EQ or RTA key, and then re-pressing the SETUP key to enter the relevant window.







	VIEWING ANGLE	31	<GLOBAL SETUP>	
	INPUT ANALOG	48.0 KHz	RTA LOCK SECURITY	OFF UNLOCK
	PROTECT MEM	OFF	EQ HIGH	OFF
	EQ LOW	OFF	RTA HIGH	OFF
	RTA LOW	OFF		

Fig. 2.10: GLOBAL SETUP menu

The cursor keys are used to select the value or parameter to be changed. The active edit field will be highlighted in reverse color. Changing status or a value can be achieved by use of the  and  softkeys.

INPUT

The input field is used to determine whether the input signal should be derived from the optional digital input, or from the analog input. Furthermore, in analog mode, this is where you can select the sampling rate, 44.1 kHz or 48 kHz. The digital input will automatically synchronize to either 32, 44.1 or 48 kHz. When changing sample

rates, the ULTRA-CURVE PRO will be muted for approx. 1 sec., as all the filter parameters have to be recalculated.

In purely analog mode the 48 kHz rate should be used. Apart from the fact that the high sample rate gives the widest frequency response and correspondingly the best possible sound, at this rate the fastest signal processing takes place.

VIEWING ANGLE

Viewing angle controls the contrast adjustment for the display, in increments from 0 to 31. A second possibility to adjust display contrast is pressing cursor UP or cursor DOWN respectively while pressing the SETUP key.

RTA LOCK

When RTA lock is switched on, it is not possible to enter RTA mode. This is designed to prevent unauthorized or accidental selection of this mode. RTA LOCK should only be deactivated when the ULTRA-CURVE PRO is to be used specifically to analyze sound, or if it is to be used in conjunction with another ULTRA-CURVE PRO operating as an equalizer solely for analysis purposes. (Think of the consequences of the situation where you are using the ULTRA-CURVE PRO as a PA equalizer, and somebody, by accident, presses the RTA key. This could even, in the worst case, result in the concert sound which you had so carefully equalized being replaced by the pink noise of the analyzer, and this at the full power rating of your system!)

SECURITY

The SECURITY function offers effective protection against unauthorized use of the ULTRA-CURVE PRO. UNLOCK means, that all functions may be accessed, with the exception of the programs which are secured under PROTECT MEMORY. LOCK prevents any of the adjustment parameters on the device being accessed, the only exceptions being the DISPLAY of the present equalizer setting, plus the input and output level with the LEVEL METER. The only other way to make changes is via MIDI. In order to use the SECURITY function, a PASSWORD must be entered, which is done using the cursor keys and the softkeys. The softkeys are used to select the letter or symbol to be used, and they have the following functions:

Softkey A = **OK** confirms entry of the password and immediately activates the LOCK status.

Softkey B = **←** and C = **→** move the cursor left and right within the password.

Softkey D = **CLEAR** erases any characters which may have already been entered.

To unlock: go into the SETUP menu. The relevant password field is immediately accessed, and the password may be re-entered. This causes the ULTRA-CURVE PRO to return to the unlock status. If the device is locked without entering the password, simply enter OK to unlock.

👉 Do not forget the password! If this happens, there is only one way to remove it: You must open the casing of the ULTRA-CURVE PRO, and take the battery out for a short while. After replacing it, and switching back on, the original factory presets will be reloaded. Warning! Doing this means you loose all your programs, and void the warranty!

PROTECT MEM

The protect memory function switches the write protect for the program memory on and off. You can use a password in this case, too.

EQ LO/EQ HI

The two functions EQ LO and EQ HI determine the area of program memory which will be protected by the protect memory function. EQ LO determines the lowest, EQ HI the highest program number of the protected area. Switching OFF means the protect memory function is deactivates only for the equalizer.

RTA LO/RTA HI

The two functions operate identically to EQ LO and EQ HI, except they determine the protection of the RTA programs. All the SETUP settings are stored when switching off the ULTRA-CURVE PRO, and remain unchanged until you re-edit them.

Refer to the MIDI SETUP for all MIDI settings.

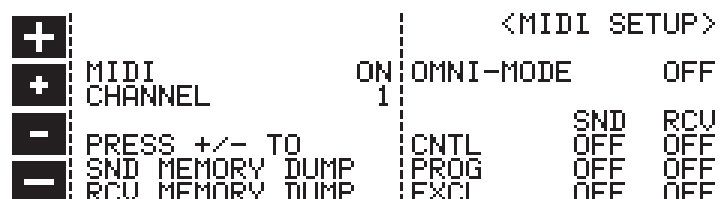

Fig. 2.11: MIDI Setup window

MIDI

Here the MIDI function is switched on or off. Toggle between ON and OFF with the +/- buttons.

CHANNEL

This field indicates the current MIDI channel. OMNI MODE signifies that MIDI commands from all channels are received.

SND MEMORY DUMP

You can send a MIDI dump using the +/- buttons. The complete memory will be transferred and can be stored externally.

RCV MEMORY DUMP

You can start the reception of a MIDI dump using the +/- buttons. The externally saved data can be reloaded.

CNTL

MIDI control change data can be sent and received. The first controller number is selected using the +/- buttons. The following 64 numbers correspond to the frequencies 20 Hz to 20 kHz and Master. First the left, and then the right channel.

PROG

MIDI program changes can be sent and received. This is chosen by ON and OFF respectively in the display.

EXCL

System exclusive data can be sent and received. This is advantageous for communication with the EQ-Design remote control software.

3. APPLICATIONS

The open mainframe architecture of the BEHRINGER ULTRA-CURVE PRO with its many audio processing features allows it to be used in a multitude of different ways. The following examples will give you an idea of the versatility of the device.

3.1 Using the ULTRA-CURVE PRO as a summing EQ in a PA

This will probably be the most common use for the ULTRA-CURVE PRO.

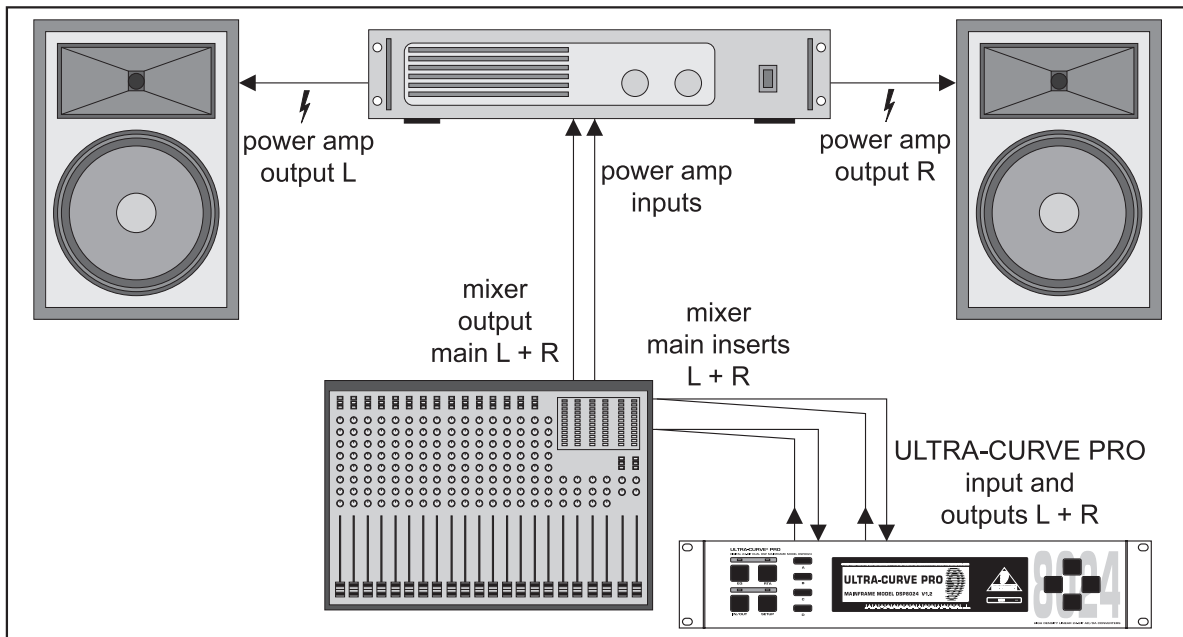

Fig. 3.1: The ULTRA-CURVE PRO as a summing equalizer in a PA

To obtain the best results the following points should be paid close attention to:

Experience has shown that, before beginning to use the equalizer, it is sensible to listen to a variety of music and speech material with which you are thoroughly familiar, playing these references “straight” through the system without any corrective EQ. Should any form of distortion, or unwanted effect be noticed, it will most likely be due to overloading or signal mismatch within the system, which should first be corrected.

The importance of loudspeaker positioning cannot be overemphasized! There is no equalizer available which can compensate for sound which is “washed out”, imprecise and unclear due to interference from walls or ceilings. You can achieve drastic improvements in sound quality by careful repositioning of your loudspeakers.

In the case of an active system with two, three or more loudspeakers served by a crossover you must pay particular attention to travel path time differences and phase coherence between the different components of the system. (The BEHRINGER SUPER-X PRO CX2310 and CX3400 crossovers, with variable crossover frequency settings, phase reverse and electronic time path correction give you all the tools required to carry out these corrections.)

Once the above points have been attended to, the ULTRA-CURVE PRO may be put to work. By using the automatic measurement procedure you will quickly get a usable basic EQ setting. Pay particular attention to the placement of the reference microphone. It should be placed in the direct radiation path of the loudspeaker system and may not be interfered with by anything causing a disturbance in the room acoustic. Placement behind curtains, less than three feet from side or rear walls, or on a balcony is to be avoided, as these positions inevitably exhibit a “colored”, false acoustic. Background noise should be at least 6 dB (preferably 10 dB) below the nominal working level, otherwise it will influence the measurement to the extent that it cannot be relied upon to proceed with a workable system equalization. Disturbances such as mains hum, or narrow band resonances may be effectively eliminated with the ULTRA-CURVE PRO’s parametric filters. They should be dealt with before proceeding with a measurement.

After the automatic measurement has been completed you have a basic setup, which you should start to finely adjust manually.

A linear or “flat” frequency response is not always the setting to go for. In the case of a system which will be used for speech purposes, the priority has to be ease of intelligibility, which requires that the bass response of the system should fall off. Anything below the fundamental frequency of speech will cause problems.

Very low and high frequencies will usually be amplified (carried over) to a much lesser extent. There is no sense in driving a loudspeaker cabinet designed only for speech/vocal use hard at frequencies below 50 Hz. Apart from the increase in power required, this can also result in very expensive loudspeaker repairs.

👉 Always be aware of and work within the physical limitations of your system.

If time allows make several measurements with the reference microphone in different positions. The next figure shows some suitable positions for taking measurements.

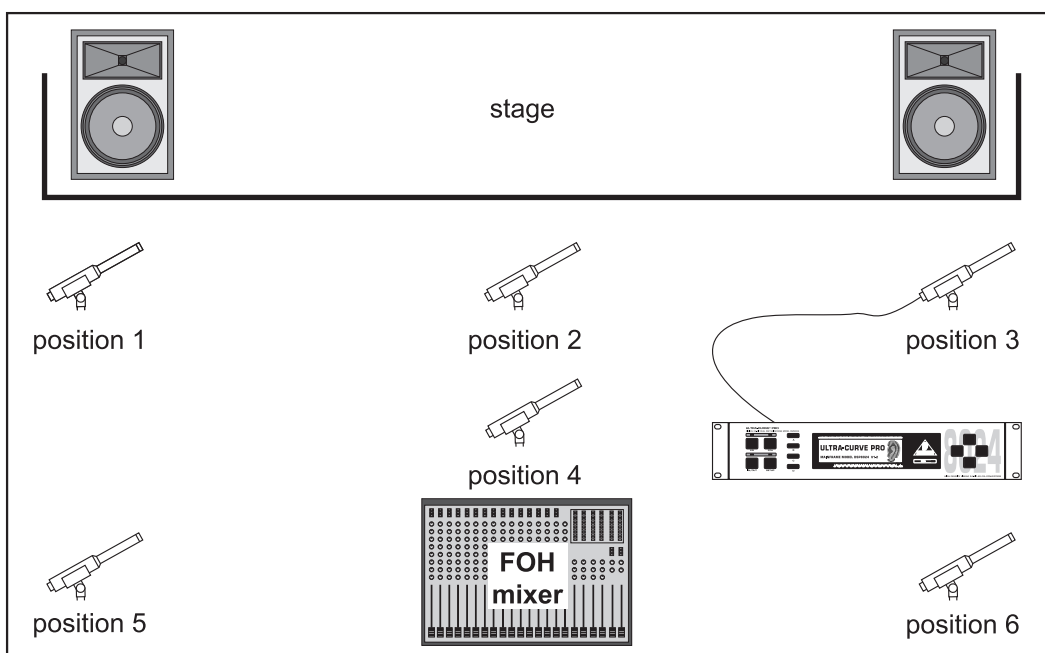

Fig. 3.2: Recommended positions for measurements with the reference microphone

Positions 1 and 2 are about three feet directly in front of the loudspeaker system, positioned halfway between the middle and high frequency components. These measurements can be used as a control of the basic system functions.

Position 3 is about seven feet in front of the stage centre. Measurements taken here should show an identical response above 250 Hz as obtained from positions 1 and 2. Due to the summing of both loudspeaker systems, the level below 250 Hz should be 3 dB higher.

Position 4 is some way back from position 3, directly in front of the FOH mixing position. (FOH means front of house). The measurements here should be the same as at position 3, with a lower level.

Positions 5 and 6 are on the axes of the two loudspeaker systems, three feet away from the rear wall. These measurements are used to detect any problems caused by standing waves or reflections.

Make sure to save the resulting frequency response curves for comparison purposes. Any major differences between the various measurements should be interpreted as warnings of phase problems within the system or acoustical problems in the room. If you are not able to deal with the source of these problems (by moving speakers, or changing the venue), then you can only attempt to find a workable compromise with the equalizer. For this purpose, the various stored measurements will be of great assistance.

After reaching the desired frequency settings on the equalizer, walk around the room and pay particular attention to any change in the sound as you move around. Don't forget to periodically listen to your reference music and spoken material to help "refresh" your ears and particularly to get a more objective feeling for the characteristics and sound of your system and the room.

You must be prepared to invest plenty of time and patience to obtain an effective equalizer setting! Beware of using extreme settings to achieve the sound you are looking for. They are inevitably a warning that something is wrong with your system.

An equalizer cannot compensate for a bad sound system, however it is a flexible and very useful tool for fine tuning sound. With practice you will see that subtle changes brought about with the equalizer can greatly enhance the ability of your system to deliver a clear, well defined sound, measurably improving its overall quality.

3.2 Using the ULTRA-CURVE PRO for monitor EQ purposes

In using the ULTRA-CURVE PRO in a monitor signal path, you should apply the ground rules discussed in the last section for PA use. In addition, the ULTRA-CURVE PRO has a number of features designed specifically to assist in monitor equalizing.

The feedback destroyer enables you, during sound check, to locate and control any frequencies causing feedback problems. (In this case, having detected a problem frequency, you match the filter to the frequency by switching to either SGL (Single Shot) or OFF (static) in the FB D menu).

In the case of microphones which are constantly moving (typically hand held vocal microphones) the feedback conditions are continuously changing. Use the feedback destroyer filter in searching mode ("S") to compensate for this.

The feedback destroyer is only suitable for use with signals with a large, changing dynamic (speech, singing, percussion). Long, static signals such as synthesizer or flute, whose sound characteristics have similarities to sine waves, cannot be distinguished from feedback, resulting in their signal being constantly dampened.

If, in „SEARCH“ mode, all the available filters are being used, in the case of a new frequency being found, the "oldest" filter in use will be released from its set frequency and made available for the new one.

The feedback destroyer cannot work miracles! It is capable of raising the feedback threshold by several dB. Seeing the feedback destroyer switching on should be interpreted as a warning signal. Lower the overall volume on stage.

 **The feedback destroyer remains active in all (graphic) EQ menus. In the setup menus as well as the level meter menu the parameters of all filters are fixed. The feedback destroyer pauses activity in these menus.**

In principle the stage volume really should be kept as low as possible, because:

1. It is better for everybody's hearing,
2. it results in fewer feedback problems and
3. it is easier to get a good FOH sound.

The monitor level tends to rise during the course of a concert. Therefore you should use any pause in the concert to reduce all monitor levels by about 3 dB. This reduction will, if at all, be barely noticeable to the

musicians—their hearing will recover sensitivity during a pause—the end result is that you recover valuable headroom.

If you are repeatedly using the same monitor loudspeakers, you can save the EQ settings which you have set for these speakers (store them under names such as wedge 15" or drumfill). Extremely low frequencies should be filtered out to avoid a “muddy” stage sound.

👉 Set the shelving tool to give you a high pass filter. (Set the shelving slope in EQ SETUP to 12 to 18 dB/oct.) By using the horizontal cursor keys you can easily change the cut-off frequency for the high pass filter, to enable you to rapidly tailor the monitor sound to suit the program being reproduced.

If you have a large system with a separate monitor mix and more than four independent monitor submixes, we recommend the use of one ULTRA-CURVE PRO solely as an analyzer. The next figure gives an example for the use of several ULTRA-CURVE PRO in a multiway monitor application.

The AFL output from the monitor mixing desk is normally used to feed a loudspeaker at the mixing position. You can feed this output through the analyzer line input. The ULTRA-CURVE PRO will then switch its display from microphone to line, and the output signal from the AFL will be present at the line input to be analyzed.

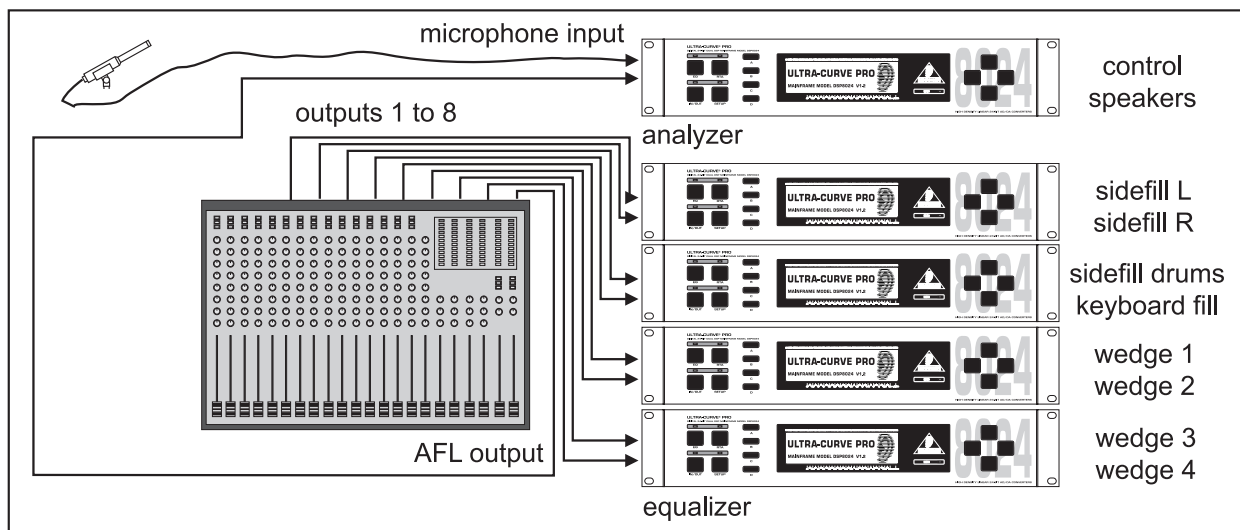

Fig. 3.3: Several ULTRA-CURVE PRO in a multiway monitor application

3.3 Using the ULTRA-CURVE PRO in the recording studio

There are countless uses for the ULTRA-CURVE PRO in the studio. The only limits are those set by your own imagination. Here are a few examples:

As the equalizer for the studio monitor system. In addition to the usual graphic EQ use, you can use the parametric filters to eliminate narrow band room resonances, standing waves etc.

As mastering equalizer. By using the STEREO LINK function you need only set one channel of the equalizer to achieve the desired EQ setting. The parametric filters are also very useful for this purpose. By using the optional AES/EBU digital inputs and outputs you can treat material working solely in a digital environment.

👉 The STEREO LINK function does not apply to the parametric filters!

As a sound tool for any purpose. If you are working with a sequencer, you can program the equalizer, via MIDI, to give you a “moving EQ” automation - you can control individual graphic faders, and store their movements per MIDI, enabling you to reproduce the EQ mix settings at any time.

3.4 The ULTRA-CURVE PRO as a delay unit

In a large sound installation loudspeaker systems are often placed a considerable distance away from the stage, or are suspended at a height (flown), in order to give those sections of the audience further away from

the stage the same clear, direct sound as those with better positions. In order to compensate for the time differences existing between the main L and R loudspeakers and those further away, the signal to the latter will be sent through an electronic delay device. This usually is a separate line-delay unit designated solely for this purpose. The ULTRA-CURVE PRO removes the necessity of a separate delay unit, as it can produce a signal delay for the material it is processing. This operates just as comfortably and effectively as having a dedicated delay unit. The delay settings are be stored with the program. If several groups of identical loudspeakers are being used, each having a different Delay time, they can be controlled by a multiple ULTRA-CURVE PRO system, interconnected via the optional AES/EBU digital interfaces, thus avoiding any signal deterioration.

If we assume, for the purposes of this example, that the same type of loudspeakers are being used in the various locations, under similar acoustic conditions (e.g. open air), then we can operate the system as follows:

The first ULTRA-CURVE PRO in the chain will be set up as in section 3.1, operating here as the signal source.

The second ULTRA-CURVE PRO provides the equalization for all successive loudspeakers, the EQ settings can be used to compensate for the difference between the equalization of the stage L and R speakers and the remote loudspeaker groups. The Delay setting corresponds to the time difference between the main L and R loudspeakers and the first loudspeaker group.

The third ULTRA-CURVE PRO receives an equalized, delayed signal, therefore requiring only a further delay to allow for the time difference between loudspeaker groups 1. and 2. Fine adjustments with the equalizer may, of course, also be made.

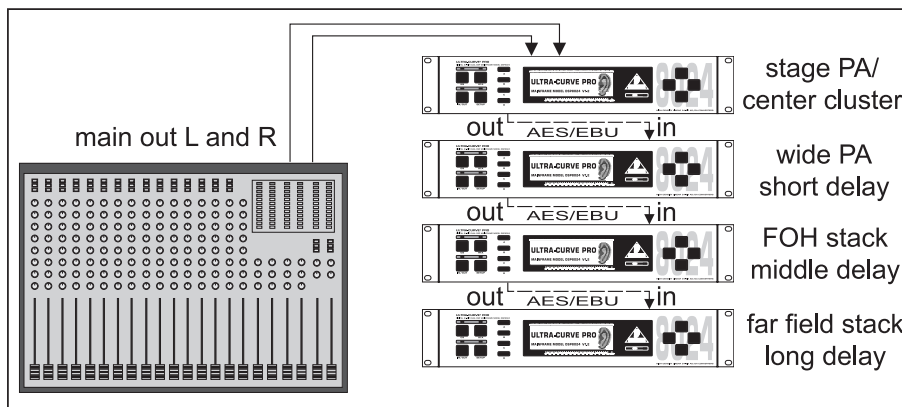

Fig. 3.4: Several ULTRA-CURVE PROs in an “advanced” Delay application

The same applies to ULTRA-CURVE PRO No. 4, the Delay time in this case allowing for the time difference between loudspeaker groups 2 and 3. This method of digitally “chaining” the ULTRA-CURVE PRO through AES/EBU can only work when using the same type of loudspeakers, or at least when a minimum of equalization will be carried out by the ULTRA-CURVE PRO placed after the first one in the chain. The reason for this is that despite the maintenance of signal quality afforded by digital signal processing and transfer, by linking several digital filters in series with each other, the quantization noise from each device will be summed, which can result in it becoming an audible noise problem.

This noise will not arise when a series of DELAYs are linked together as no processing takes place, instead the signal is merely stored briefly in each unit. If equalizer settings are required which differ substantially from each other, it is recommended to link the units in parallel to each other, either via analog, or using an AES/EBU signal distributor.

4. “TRUE RESPONSE” CHARACTERISTIC

The BEHRINGER ULTRA-CURVE PRO differs greatly from conventional graphic equalizers, in its filter concept and resulting method of operation. Conventional graphic equalizers are, by the physical nature of their design, subject to strong interaction between adjacent filters, resulting in a difference between the frequency curve suggested by the fader position, and the real frequency curve achieved. This difference itself varies depending on the amount of frequency boost or attenuation applied. The same interaction occurs in digital filters, due to the finite filter slope used. However, digital control allows us to predict these interactions, and—by generating a compensating value for each affected filter—to compensate for them.

The algorithm necessary to achieve this has been specially developed for the ULTRA-CURVE PRO, making it a “true response” equalizer. The advantages of this are directly apparent. Formerly, you had to know exactly what effect a given equalizer setting on your graphic equalizer would really achieve. If you give the ULTRA-CURVE PRO a particular setting, you can be sure that the resulting frequency curve will reflect the visual setting of the frequency filters. The ULTRA-CURVE PRO takes the guesswork and indeed the “witchcraft” out of equalizing. The new control concept of the ULTRA-CURVE PRO does, however, result in it having characteristics which need to be explained here. Equalizer settings with extreme differences in levels between adjacent frequency bands require in some cases internal boosting and attenuation of up to 48 dB. Theoretically, this is quite possible, but can quickly lead to overloading and distortion of individual filters.

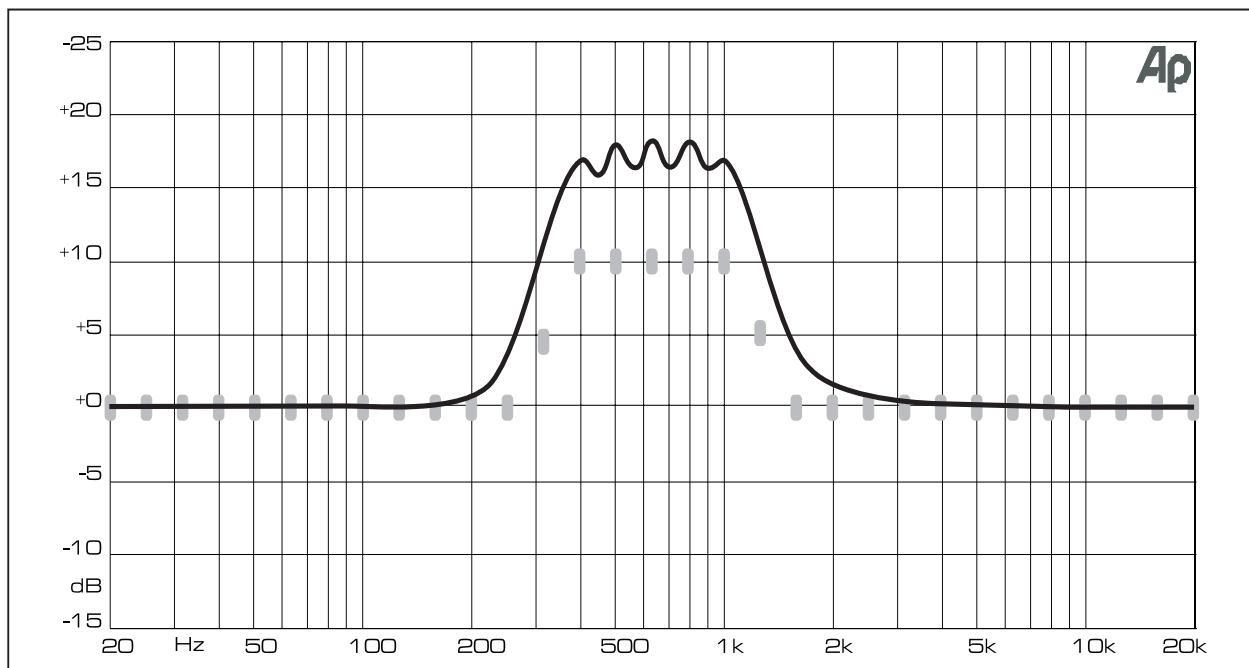

Fig. 4.1: Graphic equalizer with a fixed Q of 7

A traditional graphic equalizer tends to overload when several neighboring filters are simultaneously boosted, since their combined effects will be summed, resulting in an overloading of the summed signal. If neighboring filters are widely different in setting they will level out each others effect. This results in little alteration of the processed signal and the need for extreme settings to achieve minimal change

At first glance, the concept used in the ULTRA-CURVE PRO may seem unusual. However, after using it you will realize that the “true response” concept allows you to use the ULTRA-CURVE PRO intuitively, and that it is more straightforward to achieve the desired result. In order to set filter curves with very extreme slopes, the ULTRA-CURVE PRO offers three extra, full parametric equalizers per channel, each having a wide range of settings.

To clearly illustrate the above principles in operation, we give you some examples. The settings shown here are unlikely to be ever used in practice, nevertheless they serve to illustrate the difference between the ULTRA-CURVE PRO and a conventional graphic equalizer.

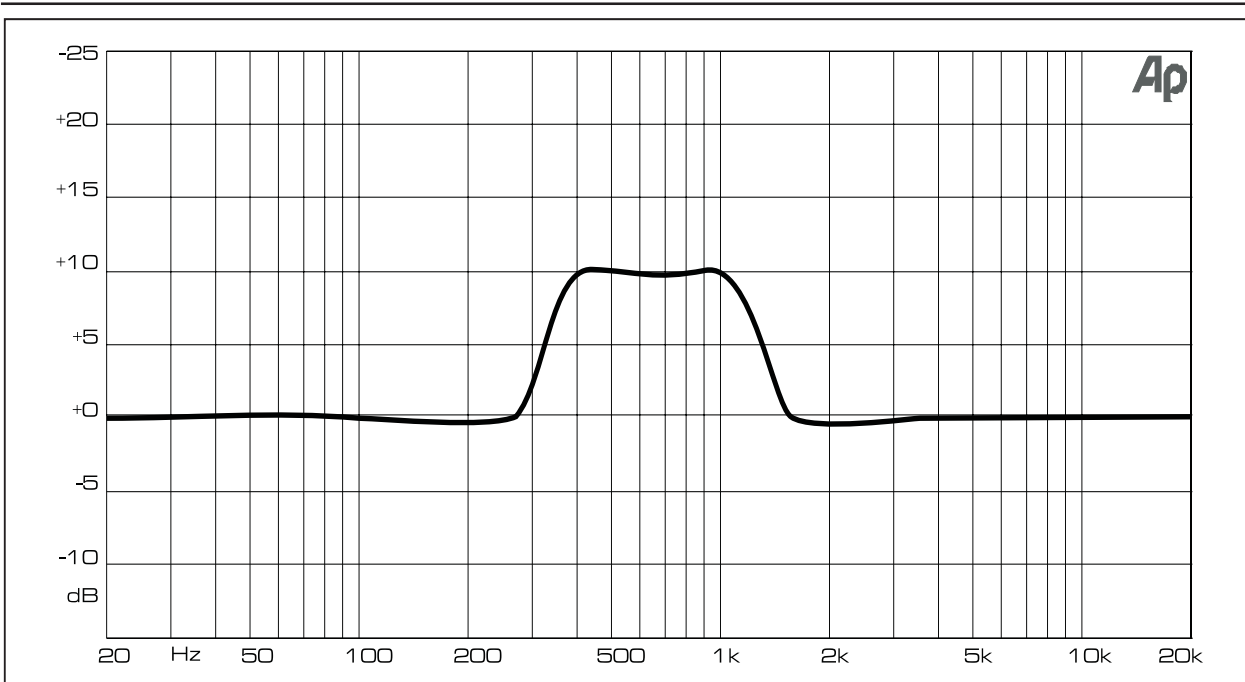

Fig. 4.2: ULTRA-CURVE PRO with “true response”

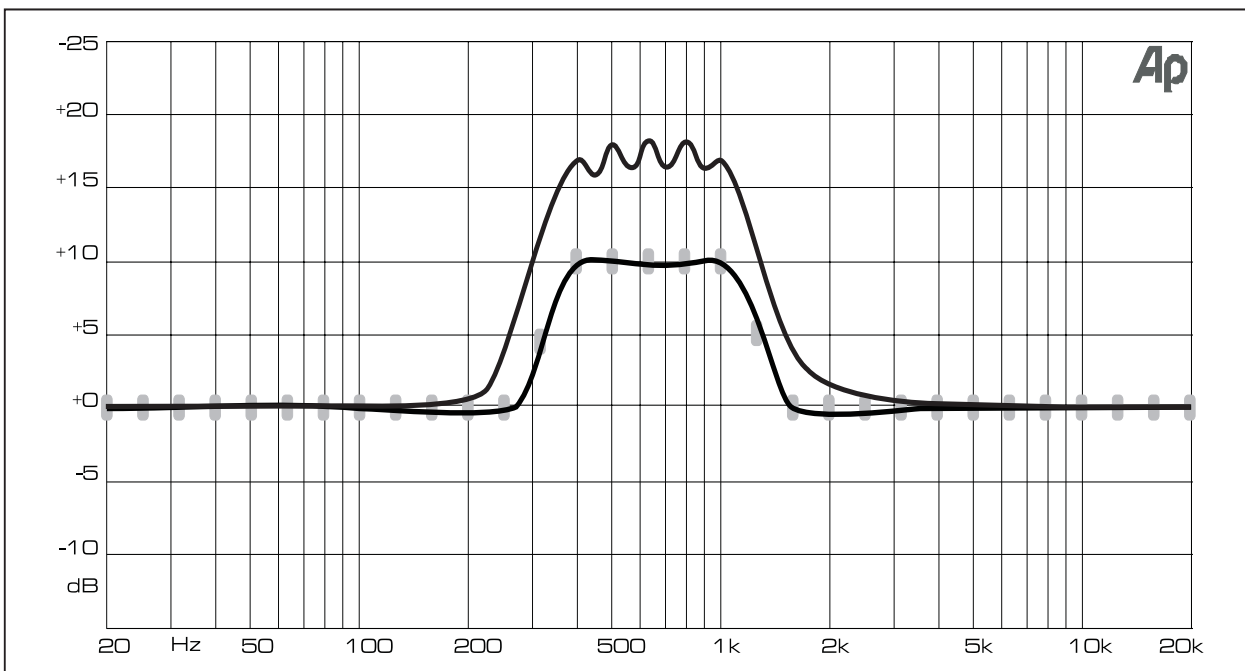

Fig. 4.3: Combination of 4.1 and 4.2—with the fader positions added

5. ULTRA-CURVE PRO STRUCTURE

5.1 Hardware

The analog input signals first pass through the electronic balancing amplifier and are then fed to the A/D converters. Here they are converted into a time division multiplex digital signal suitable for the DSPs. The reference microphone input feeds a balanced amplifier, which raises the signal level by 20 dB. The signal is then sent through a switch

to one of the A/D converter inputs. Switching onto a particular input can be carried out in the RTA or RTA SETUP menu. The digital input signal goes straight through the transformer balanced input directly to the DSPs (applicable only when the AES/EBU option is installed). Switching between the analog and digital input sources is done in the SETUP menu. Signal processing is accomplished by the two DSPs. They are succeeded by the D/A converters, which reconstruct the left and right analog signals. Finally, they are sent to the electronically balanced outputs. In the case of an ULTRA-CURVE PRO with fitted AES/EBU option, the digital signal, on leaving the DSPs, will be sent to the digital output, as well as to the D/A converter. The digital output is transformer balanced, providing a transmission in the digital domain free of induced hum and noise.

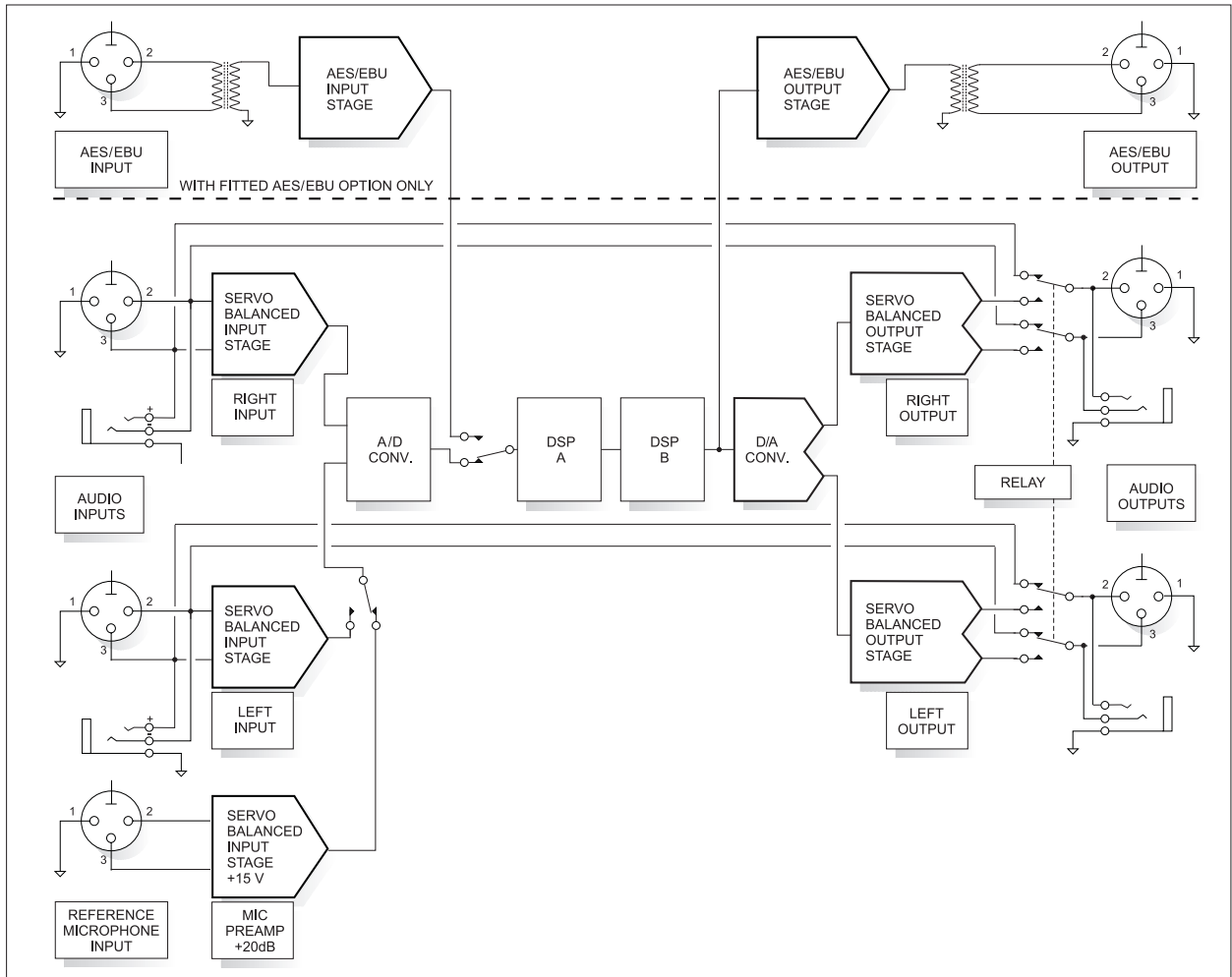

Fig. 5.1: Block diagram of the ULTRA-CURVE PRO hardware

5.2 EQ mode

DSP 1 sends the unprocessed audio signal for the right channel to the second DSP, and processes the signal for the left channel.

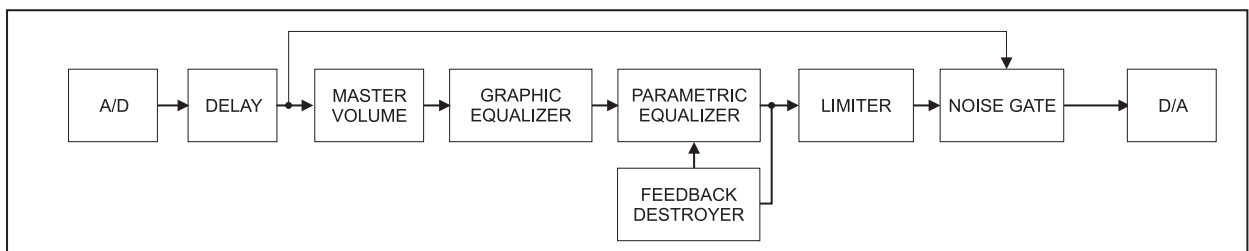

Fig. 5.2: Block diagram of the ULTRA-CURVE PRO software in equalizer mode

At first, the level will be determined before processing. This information is sent to and displayed by the level meter. Apart from this the input signal will be delayed if a delay time is set. Once again, a level will be determined, this time from the delayed signal. This will be used to control the noise gate. At the same time, the overall level (master volume) will be set. This is done prior to processing, so that the processing filters in the signal path will not be overloaded. Next are the graphic and parametric filters. 34 filters will be operated in sequence, starting with the lowest frequency (20 Hz). The last three in the sequence are the parametric filters. They have a special characteristic in that they receive control signals from the feedback destroyer.

After processing by the filters the signal will be controlled for feedback. When the feedback destroyer is switched on, a control signal for one of the parametric filters will be generated. In addition to this the filtered signal will be sent to the digital limiter. When switched on, it ensures that the signal level will be limited to the level set. Finally, we find the level control of the noise gate. Here the input level is continuously compared with the threshold setting. As soon as the level drops below the threshold, the ULTRA-CURVE PRO output will be muted. Following this final processing function, the output level will be measured and sent to the level meter. The processed signal for the left channel will then be sent on to DSP 2. It carries out the same processing as above, but solely for the right channel.

5.3 RTA mode

The integrated RTA in the BEHRINGER ULTRA-CURVE PRO allows audio spectral analysis with a 1/3 octave resolution to an accuracy of 0.5 dB. The associated display may be customized in a number of different ways to suit your preferred way of working. Press the RTA key to access the RTA mode.

The digital signal processing in the ULTRA-CURVE PRO takes place in the two DSPs, each of which has a specific function. In equalizer mode, each channel has a DSP assigned to it. In analyzer mode, the signal processing is divided between the two DSPs, the first dealing with the RTA functions, the second looking after signal generation and equalizing. The procedures which we will describe here are carried out extremely quickly, in some cases simultaneously. The sequence as described does not always reflect the real processing sequence, instead it follows a more logical train of thought.

DSP 1:

First we must choose a signal source for measurement. When mono is selected as signal source, both input channels will be summed. Next the signal level will be adjusted. This adjustment may be fully automatic (gain mode = auto). The signal will be analyzed and the measured levels prepared for the display.

DSP 2:

First of all, the signal to be measured will be generated (a sine wave with variable frequency, or white or pink noise). The signal will be then adjusted to the required level. Finally, the measurement signal will be filtered, just as in equalizer mode. The filter processing corresponds to the equalizer setting of the channel currently active. The measurement signal generated and filtered will be sent simultaneously to both outputs. When the auto-Q function is switched on, the filter parameters for the selected channel(s) and the output selection are automatically set.

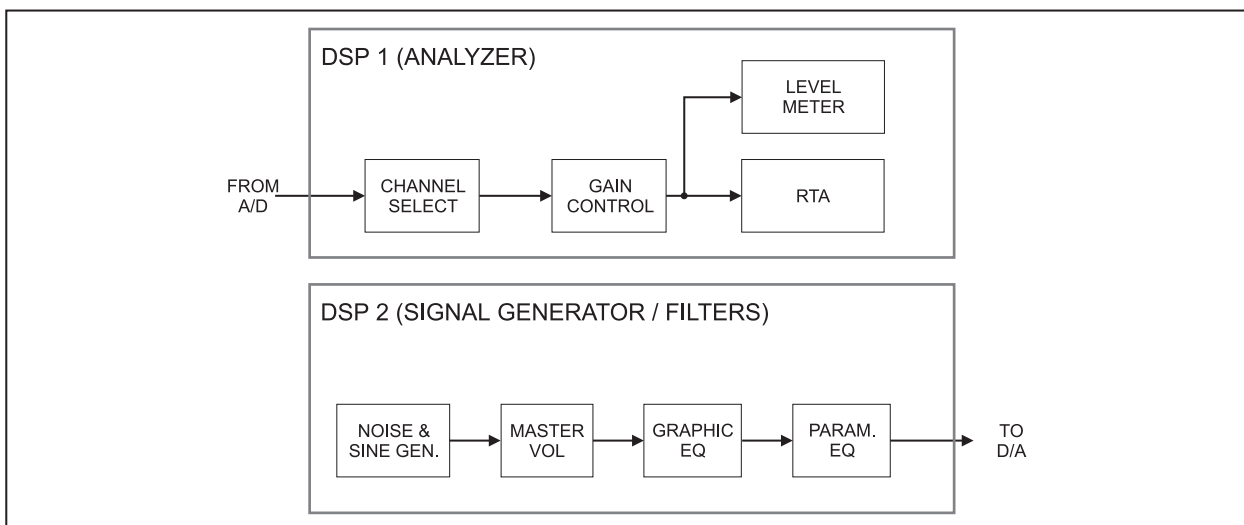

Fig. 5.3: Block diagram of the ULTRA-CURVE PRO software in RTA mode

6. INSTALLATION

6.1 Mains connection

Before you switch on the unit, check that it is configured to match your AC mains voltage requirements. If it does not comply, then it is necessary to switch the operating voltage to the correct supply requirements before turning on the unit, otherwise the unit could be severely damaged. You will find this combined fuse holder/voltage selector at the back, adjacent to the IEC receptacle. **IMPORTANT: This does not apply for general export models which are built for one operating voltage only.**

The AC voltage selection is defined by the position of the fuse holder. If you intend to change the operating voltage, remove the fuse holder and twist it by 180 degrees before you reinsert it. Matching the two markers monitors the selected voltage.

The mains connection of the ULTRA-CURVE PRO is made by using a mains cable and a standard IEC receptacle. It meets all of the international safety certification requirements.

 **If the unit is switched to an other operating voltage, the fuse rating must be changed. See the technical specifications in the appendix.**

6.2 Audio connections

As standard, the BEHRINGER ULTRA-CURVE PRO is installed with electronically servo-balanced inputs and outputs. The new circuit design features automatic hum and noise reduction for balanced signals and thus allows for trouble-free operation, even at high operating levels. Externally induced mains hum etc. will be effectively suppressed. The automatic servo-function recognizes the presence of unbalanced connectors and adjusts the nominal level internally to avoid level differences between the input and output signals (correction 6 dB).

 **Please ensure that only qualified persons install and operate the ULTRA-CURVE PRO. During installation and operation the user must have sufficient electrical contact to earth. Electrostatic charges might affect the operation of the ULTRA-CURVE PRO!**

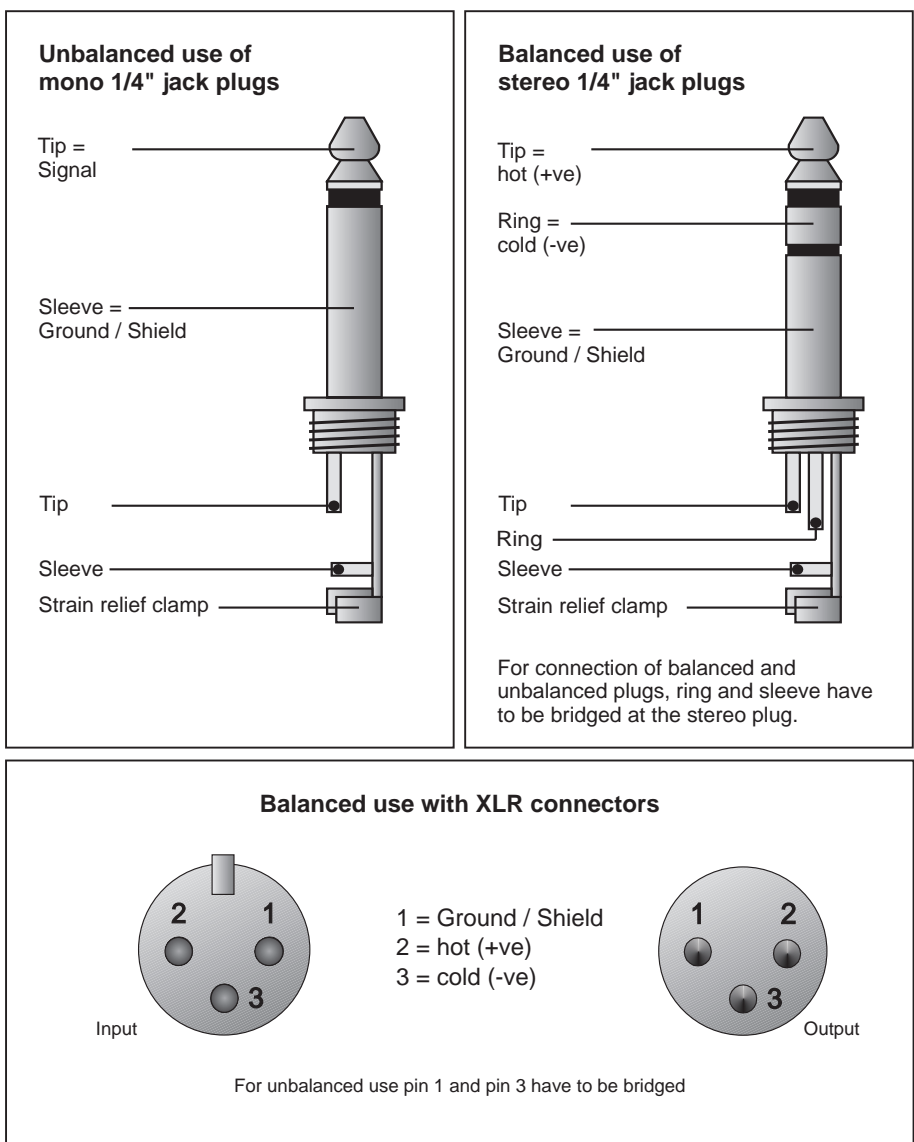

Fig. 6.1: Different plug types

6.3 Digital audio connections per AES/EBU (optional)

The AES/EBU interface (**A**udio **E**ngineering **S**ociety/**E**uropean **B**roadcasting **U**nion) is the most widely used digital interface for professional audio devices. The connection is balanced, negative earth, using bipolar shielded cable with XLR connectors. We recommend the use of a high quality low capacitance cable capable of transmitting the wide bandwidth signal (with frequencies of over 3 MHz) error free. The AES/EBU signal can carry, in addition to the pure audio material (up to 24-bit), various code signals using a built in emphasis, including the sampling rate present, time code information and user-definable bits. The S/PDIF digital format found in consumer products has similarities in its data structure to the AES/EBU format. It is in principle possible to connect an S/PDIF device (**S**ony **P**hilips **D**igital **I**nterface **F**ormat) to the ULTRA-CURVE PRO AES/EBU input, although this was not intended in the design of the two formats. The S/PDIF connector is normally an unbalanced RCA socket, requiring the use of an adaptor. Connect the tip of the RCA socket to pin 2 of the XLR, and the RCA shield to pin 3 of the XLR. The connection between the two devices should be as short as possible.

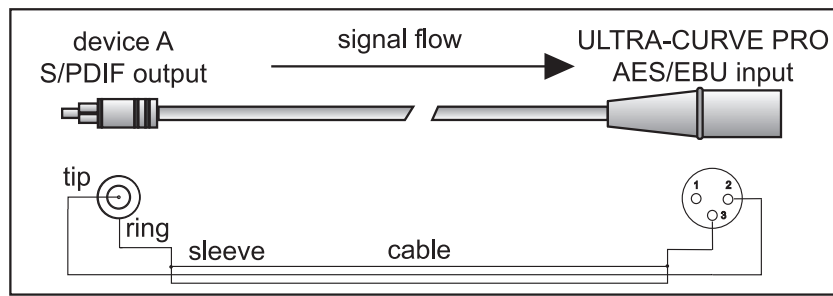

Fig. 6.2: Adaptor S/PDIF out > ULTRA-CURVE PRO AES/EBU in

Connecting from the ULTRA-CURVE PRO AES/EBU output to an S/PDIF input will probably not work, because the copy prohibit function present at the S/PDIF device will be triggered by a channel status bit, or possibly another AES/EBU defined bit, preventing data transfer.

6.4 MIDI connections

The MIDI (**M**usical **I**nstruments **D**igital **I**nterface) standard was developed in the early 1980s to allow electronic musical instruments from different manufacturers to communicate with each other. The use of MIDI has developed over the intervening years to the stage where it is now common to find complete recording studios operating entirely on a MIDI basis. The centrepiece in such a studio is usually a computer running a sequencer software which not only controls various keyboards, samplers and sound modules, but can also run the programming of outboard effect devices, typically digital reverberation and delay units. The ULTRA-CURVE PRO may be controlled in real time in this studio environment.

The MIDI connectors found on the rear panel are of the universally used 5 pin DIN type. You require suitable MIDI cables to connect the ULTRA-CURVE PRO to other MIDI devices. Normally complete cables will be purchased for this use, you can of course make your own, using a high quality cable with two cores and shielding (like microphone cable), with as connectors two good 180 degree DIN plugs. Pin 2 (center) is connected to the cable's shield, pins 4 and 5 (left and right next to 2) carry the two cores, pins 1 and 3 are not used. MIDI cables should have a maximum length not exceeding 45 feet.

7. APPENDIX

7.1 AES8024 option

The digital AES/EBU input and output consists of an additional circuit board with the driver software for the AES/EBU connections, the XLR connectors and balancing transformers, plus an update for the operating software.

You have the choice of ordering the option with the purchase of your ULTRA-CURVE PRO, or adding it at a later stage. To do this, please contact our Customer Support.

 **Return your ULTRA-CURVE PRO to us for the installation, otherwise you will invalidate your warranty.**

7.2 Changing the tip memory protect battery

The battery which maintains the program memory when power is switched off has a life of several years, depending on the frequency and duration of use. When the battery starts to run out you will see the message:

WARNING: BATTERY LOW.



You should send the unit back to us as quickly as possible. We are able to replace the battery without losing the programs stored in the memory. If you fail to heed the warning to replace the battery, the display will show the message:

BATTERY EMPTY: MEMORY CLEARED.

If this happens, you will have lost all your programs. Furthermore, new programs will also be lost once the

ULTRA-CURVE PRO is switched off.

If you decide to replace the battery yourself please note that you will invalidate your warranty.

-  **Disconnect the ULTRA-CURVE PRO from mains before opening the enclosure.**
-  **Warning: Danger of explosion when battery is placed incorrectly! Replace only with the same type (see technical specifications). When replacing the battery, the correct polarity should be observed.**
-  **Empty batteries are toxic waste and must be disposed of properly.**

7.3 MIDI implementation

Function		Transmitted	Recognized	Remarks
Basic	Default	X	1 - 16	memorized
Channel	Changed	X	1 - 16	-16
Mode	Default	X	1,2,3,4	
	Messages	X	X	
	Altered	X	X	
Note		X	X	
Number	True Voice	X	X	
Velocity	Note ON	X	X	
	Note OFF	X	X	
After Touch	Key's	X	X	
	Ch's	X	X	
Pitch Bender		X	X	
Control Change		O	O	offset of the first controller adjustable (refer to next table)
Progr. Change	True #	0 - 99	0 - 99	1 - 100
System Exclusive		O	O	
System	Song Pos	X	X	
	Song Sel	X	X	
Common	Tune	X	X	
System	Clock	X	X	
Real Time	Commands	X	X	
Aux	Local ON/OFF	X	X	
	All notes OFF	X	X	
Messages	Active Sense	X	X	
	Reset	X	X	
Notes		X	X	

Mode 1: OMNI ON, POLY
Mode 2: OMNI ON, MONO

Mode 3: OMNI OFF, POLY
Mode 4: OMNI OFF, MONO

O = YES
X = NO

Tab. 7.1: MIDI implementation

Status Bytes			
Program Changes		Pcxx	c = Channel xx = Program (0..99)
Controller		Controller Offset adjustable from 0 to 64 * Ccxx c = Channel xx = Number	
Data Bytes			
Contrl. Number	Parameter	Definition	Range
0-30	EQ Left	20 Hz, 25 Hz, ..., 16 kHz, 20 kHz	0 - 127
31	Master Level Left		0 - 127
32-62	EQ Right	20 Hz, 25 Hz, ..., 16 kHz, 20 kHz	0 - 127
63	Master Level Right		0 - 127

Tab. 7.2: MIDI controller

* You can adjust an offset for the MIDI controller. The MIDI controller will start from the chosen position.

7.4 Software

The ULTRA-CURVE PRO operating software is under continuous development to improve its performance and control, and to keep pace with your expectations and requirements. Therefore you are asked to contact us with your needs, suggestions and ideas. We will make every effort to put your ideas into use in successive software updates. In order to receive a new software update, you must send your ULTRA-CURVE PRO to us. Information about new software versions will be available through music magazines, from your dealer or directly from BEHRINGER (+49 2154 920666).

 **The current software version will always be displayed shortly after switching the ULTRA-CURVE PRO on.**

8. TECHNICAL SPECIFICATIONS

Analog audio inputs

Connectors	XLR and 1/4" TRS connectors
Type	servo-balanced input with RF rejection
Impedance	50 kOhm balanced, 25 kOhm unbalanced
Max. input Level	+21 dBu balanced and unbalanced
CMRR	typical 40 dB, >55 dB @ 1 kHz

Analog audio outputs

Connectors	XLR and 1/4" TRS connectors
Type	DC-decoupled, servo-balanced output stage
Impedance	60 Ohm balanced, 30 Ohm unbalanced
Max. output level	+16 dBu balanced and unbalanced

System

Bandwidth	20 Hz to 20 kHz (+0, -0.5 dB)
Signal to noise ratio	103 dB unweighted, 22 Hz to 22 kHz
THD+N	0.004 % @ 1 kHz/+4 dBu
Crosstalk	< -103dB, 22 Hz to 22 kHz

Bypass

Type	relay-controlled bypass
------	-------------------------

Reference microphone input

Type	servo-balanced input
Impedance	2 kOhms
Nominal operating level	-60 dBu to 0 dBu
Max input level	+1 dBu
Phantom power	+15 V

Digital audio input (optional)

Type	AES/EBU transformer-balanced
Impedance	10 kOhms balanced
Nominal input level	3-10 V peak-to-peak

Digital audio output (optional)

Type	AES/EBU transformer-balanced
Impedance	100 Ohms balanced
Output level	5 V peak-to-peak

MIDI interface

Type	5-Pin DIN-socket in/out/thru
Implementation	refer to MIDI implementation chart

Digital processing

Converters	24-bit Sigma-Delta
Sampling rate	48 kHz, 44.1 kHz, (32 kHz, only AES/EBU)

Graphic equalizer (GEQ)

Type	digital 1/3 octave equalizer
Frequency range	31 filters on ISO center frequencies, from 20 Hz to 20 kHz
Bandwidth	1/3 octave
Boost/Attenuation	variable from +16 to -16 dB in steps of 0.5 dB (true response)

Parametric equalizer (PEQ)

Type	3 independent filters per channel
Frequency range	20 Hz to 20 kHz, adjustable in steps of 1/60 octave
Bandwidth	1/60 to 2 octaves, adjustable in steps of 1/60 octave
Gain	variable from +16 to -48 dB in steps of 0.5 dB

Feedback destroyer (FB D)

Type	DSP-controlled digital signal analysis
Filter	3 independent, digital notch filters per channel, user selectable as fixed or dynamic filters for automatic feedback suppression
Frequency range	20 Hz - 20 kHz, adjustable in steps of 1/60 octave
Bandwidth	2/60 to 12/60 octaves, depending on the characteristic of the feedback
Attenuation	up to -48 dB, depending on the gain of the feedback

Digital delay

Type	digital stereo delay
Maximum delay time	2.5 s, independently adjustable for each channel
Minimum resolution	0.1 msec
Delay unit	seconds, meters or feet

Level meter

Type	Digital level meter with simultaneous graphical display of peak and RMS values
Attack/Decay (RMS)	60 dB/s
Attack (Peak)	1 sample
Decay (Peak)	20 dB/s

Noise gate

Type	digital IRC (Interactive Ratio Control)
Threshold	variable from -44 to -96 dB in steps of 1 dB
Attack/Release	processor controlled, program dependent

Limiter

Type	digital IGC (Interactive Gain Control)
Threshold	variable from 0 to -36 dB in steps of 1 dB
Release	500 to 5000 ms in steps of 250 ms

Real time analyzer (RTA)

Type	digital 1/3 octave analyzer
Frequency range	31 filters on ISO center frequencies, from 20 Hz to 20 kHz
Detectors	peak or RMS
Decay	variable 1 s, 250 msec, 65 msec or 15 msec (per 20 dB)
Sine wave generator	frequency adjustable from 20 Hz to 20 kHz in steps of 1/60 octave, gain adjustable from 0 to -48 dB in steps of 0.5 dB
Noise generator	white or pink characteristic, gain adjustable from 0 to -48 dB in steps of 0.5 dB

Display

Type	240 x 64 dot matrix, liquid crystal display (LCD)
Backlight	LED array
Contrast	adjustable

Memory

EQ programs	100 memory locations, capable of storing all relevant settings for GEQ, PEQ, FB D and DELAY in addition to a program name with 12 characters
RTA measurements	10 memory locations
Password protection	2 levels, memory protect or security lock, both protected with an alphanumerical 12 digit password

Power supply

Operating voltage	USA/Canada	120 V ~, 60 Hz
	U.K./Australia	240 V ~, 50 Hz
	Europe	230 V ~, 50 Hz
	general export model	100 - 120 V ~, 200 - 240 V ~, 50 - 60 Hz

Power consumption	max. 30 W
Fuse rating	100 - 120 V ~: T 630 mA H
	200 - 240 V ~: T 315 mA H

Mains connection	standard IEC receptacle
Battery	Lithium CR 2032, 3 V, 180 mAh
Battery life	3 years, typical

Physical

Dimensions (H * W * D)	3 1/2" (89 mm) * 19" (482.6 mm) * 12" (304.8 mm)
Net weight	app. 5 kg
Shipping weight	app. 6.6 kg

BEHRINGER is constantly striving to maintain the highest professional standards. As a result of these efforts, modifications may be made from time to time to existing products without prior notice. Specifications and appearance may differ from those listed or illustrated.

9. WARRANTY

§ 1 WARRANTY CARD/ONLINE REGISTRATION

To be protected by the extended warranty, the buyer must complete and return the enclosed warranty card within 14 days of the date of purchase to BEHRINGER Spezielle Studiotechnik GmbH, in accordance with the conditions stipulated in § 3. Failure to return the card in due time (date as per postmark) will void any extended warranty claims.

Based on the conditions herein, the buyer may also choose to use the online registration option via the Internet (www.behringer.com or www.behringer.de).

§ 2 WARRANTY

1. BEHRINGER (BEHRINGER Spezielle Studiotechnik GmbH including all BEHRINGER subsidiaries listed on the enclosed page, except BEHRINGER Japan) warrants the mechanical and electronic components of this product to be free of defects in material and workmanship for a period of one (1) year from the original date of purchase, in accordance with the warranty regulations described below. If the product shows any defects within the specified warranty period that are not due to normal wear and tear and/or improper handling by the user, BEHRINGER shall, at its sole discretion, either repair or replace the product.
2. If the warranty claim proves to be justified, the product will be returned to the user freight prepaid.
3. Warranty claims other than those indicated above are expressly excluded.

§ 3 RETURN AUTHORIZATION NUMBER

1. To obtain warranty service, the buyer (or his authorized dealer) must call BEHRINGER (see enclosed list) during normal business hours **BEFORE** returning the product. All inquiries must be accompanied by a description of the problem. BEHRINGER will then issue a return authorization number.
2. Subsequently, the product must be returned in its original shipping carton, together with the return authorization number to the address indicated by BEHRINGER.
3. Shipments without freight prepaid will not be accepted.

§ 4 WARRANTY REGULATIONS

1. Warranty services will be furnished only if the product is accompanied by a copy of the original retail dealer's invoice. Any product deemed eligible for repair or replacement by BEHRINGER under the terms of this warranty will be repaired or replaced within 30 days of receipt of the product at BEHRINGER.
2. If the product needs to be modified or adapted in order to comply with applicable technical or safety standards on a national or local level, in any country which is not the country for which the product was originally developed and manufactured, this modification/adaptation shall not be considered a defect in materials or workmanship. The warranty does not cover any such modification/adaptation, irrespective of whether it was carried out properly or not. Under the terms of this warranty, BEHRINGER shall not be held responsible for any cost resulting from such a modification/adaptation.

3. Free inspections and maintenance/repair work are expressly excluded from this warranty, in particular, if caused by improper handling of the product by the user.

This also applies to defects caused by normal wear and tear, in particular, of faders, potentiometers, keys/buttons and similar parts.

4. Damages/defects caused by the following conditions are not covered by this warranty:

- ▲ misuse, neglect or failure to operate the unit in compliance with the instructions given in BEHRINGER user or service manuals.
- ▲ connection or operation of the unit in any way that does not comply with the technical or safety regulations applicable in the country where the product is used.
- ▲ damages/defects caused by force majeure or any other condition that is beyond the control of BEHRINGER.

5. Any repair or opening of the unit carried out by unauthorized personnel (user included) will void the warranty.

6. If an inspection of the product by BEHRINGER shows that the defect in question is not covered by the warranty, the inspection costs are payable by the customer.

7. Products which do not meet the terms of this warranty will be repaired exclusively at the buyer's expense. BEHRINGER will inform the buyer of any such circumstance. If the buyer fails to submit a written repair order within 6 weeks after notification, BEHRINGER will return the unit C.O.D. with a separate invoice for freight and packing. Such costs will also be invoiced separately when the buyer has sent in a written repair order.

§ 5 WARRANTY TRANSFERABILITY

This warranty is extended exclusively to the original buyer (customer of retail dealer) and is not transferable to anyone who may subsequently purchase this product. No other person (retail dealer, etc.) shall be entitled to give any warranty promise on behalf of BEHRINGER.

§ 6 CLAIM FOR DAMAGES

Failure of BEHRINGER to provide proper warranty service shall not entitle the buyer to claim (consequential) damages. In no event shall the liability of BEHRINGER exceed the invoiced value of the product.

§ 7 OTHER WARRANTY RIGHTS AND NATIONAL LAW

1. This warranty does not exclude or limit the buyer's statutory rights provided by national law, in particular, any such rights against the seller that arise from a legally effective purchase contract.
2. The warranty regulations mentioned herein are applicable unless they constitute an infringement of national warranty law.

The information contained in this manual is subject to change without notice. No part of this manual may be reproduced or transmitted in any form or by any means, electronic or mechanical, including photocopying and recording of any kind, for any purpose, without the express written permission of BEHRINGER Spezielle Studiotechnik GmbH.

BEHRINGER, ULTRA-CURVE and FEEDBACK DESTROYER are registered trademarks. ALL RIGHTS RESERVED.

© 2001 BEHRINGER Spezielle Studiotechnik GmbH.

BEHRINGER Spezielle Studiotechnik GmbH, Hanns-Martin-Schleyer-Str. 36-38, 47877 Willich-Münchheide II, Germany

Tel. +49 (0) 21 54 / 92 06-0, Fax +49 (0) 21 54 / 92 06-30