

PIXMA MP830

SERVICE MANUAL

Canon

Trademarks

Product and brand names appearing in this manual are registered trademarks or trademarks of the respective holders.

Copyright

All rights reserved. No parts of this manual may be reproduced in any form or by any means or translated into another language without the written permission of Canon Inc., except in the case of internal business use.

Copyright © 2006 by Canon Inc.

CANON INC.

Inkjet Device Quality Assurance Div. 2

451, Tsukagoshi 3-chome, Saiwai-ku, Kawasaki-shi, Kanagawa 212-8530, Japan



I. MANUAL OUTLINE

This manual consists of the following three parts to provide information necessary to service the PIXMA MP830:

Part 1: Maintenance

Information on maintenance and troubleshooting of the PIXMA MP830

Part 2: Technical Reference

New technology and technical information such as FAQ's (Frequently Asked Questions) of the PIXMA MP830

Part 3: Appendix

Block diagrams and pin layouts of the PIXMA MP830

Reference:

This manual does not provide sufficient information for disassembly and reassembly procedures. Refer to the graphics in the separate Parts Catalog.



II. TABLE OF CONTENTS

Part 1: MAINTENANCE

1. MAINTENANCE

- 1-1. Adjustment, Periodic Maintenance, Periodic Replacement Parts, and Replacement Consumables by Service Engineer
- 1-2. Customer Maintenance
- 1-3. Product Life
- 1-4. Special Tools
- 1-5. Serial Number Location

2. LIST OF ERROR DISPLAY / INDICATION

- 2-1. Operator Call Errors
- 2-2. Service Call Errors
- 2-3. Fax Errors
- 2-4. Other Error Messages
- 2-5. Warnings
- 2-6. Troubleshooting by Symptom

3. REPAIR

- 3-1. Notes on Service Part Replacement (and Disassembling / Reassembling)
- 3-2. Special Notes on Repair Servicing
 - (1) Power supply unit removal / reassembly
 - (2) Cassette, front door (paper output tray), and door damper removal
 - (3) Emblem removal
 - (4) Side cover (right and left) removal
 - (5) Front cover (right and left) removal
 - (6) DF front cover removal
 - (7) DF rear cover removal
 - (8) Stop arm removal
 - (9) DF grip cover and DF right cover removal
 - (10) Document feed unit removal
 - (11) Separation tab, document feed roller, and separation roller cleaning
 - (12) DF cable cover removal
 - (13) ADF hinge removal
 - (14) Operation panel (right and left) removal
 - (15) LCD upper cover removal
 - (16) Operation panel unit removal
 - (17) LCD unit removal
 - (18) Logic board ass'y wiring
 - (19) Scanner stop arm removal
 - (20) Scanner stopper removal
 - (21) Cable holder sheet position
 - (22) Scanner unit removal
 - (23) Main case unit removal
 - (24) Base case and printer unit wiring
 - (25) Logic board ass'y removal
 - (26) Printer unit removal

- 3-3. Adjustment / Settings
 - (1) Paper feed motor adjustment
 - (2) Grease application
 - (3) Waste ink counter setting
 - (4) White sponge sheet attachment
 - (5) User mode
 - (6) Service mode

- Service mode operation

- Destination settings

- LF correction

- Waste ink amount setting

- Button and LCD test

- 3-4. Verification Items
 - (1) Service test print
 - (2) EEPROM information print
 - (3) Fax report

4. MACHINE TRANSPORTATION

Part 2: TECHNICAL REFERENCE

- 1. NEW TECHNOLOGIES
- 2. CLEANING MODE AND AMOUNT OF INK PURGED
- 3. PRINT MODE
 - 3-1. Normal Color Printing via Computer
 - 3-2. Normal Grayscale Printing via Computer
 - 3-3. Borderless Printing via Computer
 - 3-4. Duplex Printing via Computer
 - 3-5. Camera Direct Printing
 - 3-6. Card Direct Printing
 - 3-7. Copying
- 4. FAQ (Problems Specific to the MP830 and Corrective Actions)

Part 3: APPENDIX

- 1. BLOCK DIAGRAM
- 2. CONNECTOR LOCATION AND PIN LAYOUT
 - 2-1. Logic Board Ass'y
 - 2-2. NCU Board
 - 2-3. Relay Board
 - 2-4. Card Slot Board
 - 2-5. Operation Panel Board
 - 2-6. Carriage Board (Print Head Connector)
- 3. PIXMA MP830 SPECIFICATIONS

Part 1

MAINTENANCE



1. MAINTENANCE

1-1. Adjustment, Periodic Maintenance, Periodic Replacement Parts, and Replacement Consumables by Service Engineer

(1) Adjustment

Adjustment	Timing	Purpose	Tool	Approx. time
EEPROM initialization	At logic board replacement	To initialize settings.	None.	1 min.
Destination settings (EEPROM settings)	At logic board replacement	To set the destination.	None. Perform in the service mode.	1 min.
Waste ink counter resetting (EEPROM settings)	- At logic board replacement - At waste ink absorber replacement	To reset the waste ink counter.	None. Perform in the service mode.	1 min.
Waste ink amount setting (EEPROM settings)	- At logic board replacement	To set the waste ink amount to the waste ink counter.	None. Perform in the service mode.	1 min.
Paper feed motor position adjustment	At paper feed motor replacement	To adjust the belt tension. (Position the paper feed motor so that the belt is stretched tight.)	None.	5 min.
CD / DVD detection sensor light volume correction *1	- At logic board replacement - At carriage unit replacement	To correct the light volume for the CD / DVD detection sensor.	None. Perform in the service mode.	2 min.
Grease application	- At carriage unit replacement - At PR shaft ass'y replacement - At CL base or CL gear replacement	- To maintain sliding properties of the carriage shaft and the lift cam shaft. - To protect the machine's sliding portions (gears and Open button).	FLOIL KG-107A MOLYKOTE PG-641	1 min.
Ink system function check	- At logic board replacement - At platen unit replacement - At carriage unit replacement	To maintain detection functionality for presence of the ink tanks and each ink tank position.	None. Perform in the service mode.	1 min.
Line feed correction	- At logic board replacement - At feed roller ass'y replacement	To correct the line feed tolerant accuracy.	None.	3 min.
LCD language settings	At logic board replacement	To set the language to be displayed on the LCD.	None. Perform in the user mode.	1 min.
Document pressure sheet position adjustment	- At document pressure sheet replacement - At document feed base replacement	To adjust the pressure sheet to fit in place to the four corners of the platen glass when the cover is closed.	None.	2 min.

Note: DO NOT loosen the red screws at both ends of the carriage shaft, securing the print head position, as they are not re-adjustable.

The red screws securing the paper feed motor may be loosened only at replacement of the paper feed motor unit.

*1: Only for CD / DVD printing supported regions.

(2) Periodic maintenance

No periodic maintenance is necessary.

(3) Periodic replacement parts

There are no parts in this machine that require periodic replacement by a service engineer.

(4) Replacement consumables

There are no consumables that require replacement by a service engineer.

1-2. Customer Maintenance

Adjustment	Timing	Purpose	Tool	Approx. time
Print head alignment	At print head replacement.	To ensure accurate dot placement.	- Machine buttons - Computer (automatic settings via the MP driver)	3 min.

Print head cleaning	When print quality is not satisfying.	To improve nozzle conditions.	- Machine buttons - Computer (settings via the MP driver)	1 min.
Print head deep cleaning	When print quality is not satisfying, and not improved by print head cleaning.	To improve nozzle conditions.	- Machine buttons - Computer (settings via the MP driver)	2 min.
Ink tank replacement	When an ink tank becomes empty. ("No ink error" displayed on the monitor, or short flashing of an ink tank LED)	To replace the empty ink tank.	None.	2 min.
Paper feed roller cleaning	When paper does not feed properly.	To clean the paper feed rollers.	Machine buttons	2 min.
CD / DVD print position adjustment* ¹	At CD / DVD printing, when necessary.	To correct CD / DVD print position.	Computer (application software)	5 min.
Bottom plate cleaning	When the back side of the paper is smeared.	To clean the platen ribs.	- Machine buttons - Computer (settings via the MP driver)	1 min.
Scanning area cleaning	When the following are dirty: - Platen glass - Document pressure sheet - ADF glass - White sheet in the back of the ADF	To clean the applicable items.	Soft, dry, and clean lint-free cloth.	1 min.
ADF cleaning	When inside of the ADF cover is dirty.	To clean the inside of the ADF cover	Soft, dry, and clean lint-free cloth.	1 min.
ASF sub-roller cleaning	When the paper fed from the ASF is smeared due to ink mist attached to the ASF sub-rollers.	To clean the ASF sub-rollers.	- Plain paper - Machine buttons (paper feed roller cleaning) [See Part 2, 4. FAQ, How to make and set the ASF sub-roller cleaning sheet, for details]	1 min.

*1: Only for CD / DVD printing supported regions.

1-3. Product Life

(1) Machine

Specified print volume (I) or the years of use (II), whichever comes first.

(I) Print volume: 19,000 pages

Fax	1,500 character pattern	230 pages
Black	1,500 character pattern	10,260 pages
Color	A4, 7.5% duty per color pattern	7,450 pages
	A4, photo, borderless printing	150 pages
	4 x 6, photo, borderless printing	610 pages
	Postcard, photo, borderless printing	300 pages

(II) Years of use: 5 years of use

(2) Print head

Same as the machine life.

(3) Ink tank (target value)

Pattern	Ink tank used	Print yield
Black text	PGI-5BK	Approx. 880 pages
Color chart	PGI-5BK	Approx. 1,250 pages
	CLI-8C	Approx. 710 pages
	CLI-8M	Approx. 500 pages
	CLI-8Y	Approx. 480 pages

Photo chart	CLI-8BK	Approx. 1,100 pages
	CLI-8C	Approx. 280 pages
	CLI-8M	Approx. 250 pages
	CLI-8Y	Approx. 390 pages

Black text: When printing the Canon standard pattern (1,500 characters per page) on A4 size plain paper, with the default settings in the Windows XP driver, using Word 2003.

Color chart: When printing the ISO/JIS-SCID N5 pattern on A4 size plain paper in bordered printing, with the default settings in the Windows XP driver, using Photoshop 7.0.

Photo chart: When printing the Canon standard pattern on 4" x 6" Photo Paper Plus Glossy in borderless printing, with the default settings in the Windows XP driver, using Windows XP Photo Printing Wizard.

The print yield in the table above is an average value measured in continuous printing, using the ink tank immediately after it is unsealed, until the ink is out. Ink yield may vary depending on texts and photos printed, application software, print mode, and type of paper used.

When the machine is turned on and while printing, each ink may be used for protecting the print head and maintaining print quality.

1-4. Special Tools

Name	Tool No.	Application	Remarks
FLOIL KG-107A	QY9-0057-000	To be applied to the sliding portions of the carriage shaft, lift cam shaft, and machine's sliding portions (gears).	In common with the S520.
MOLYKOTE PG-641	CK-0562-000	To be applied to the Open button sliding portion.	In common with the i950.

1-5. Serial Number Location

On the carriage flexible cable holder (visible on the right of the carriage after the machine is turned on, the scanning unit is opened, and the carriage moves to center).



[To the table of contents](#)

[To the top](#)

← <Part 1: 1. MAINTENANCE> →

2. LIST OF ERROR DISPLAY / INDICATION

Errors and warnings are displayed by the following ways:

- 1) Operator call errors are indicated by the Alarm LED lit in orange, and the error and its solution are displayed on the LCD in text and by icon.
- 2) Warnings during printing from a computer are displayed on the printer driver Status Monitor.
- 3) Error codes are printed in the "operator call/service call error record" area in EEPROM information print.

Buttons valid when an operator call error occurs:

- 1) ON/OFF button: To turn the machine off and on again.
- 2) OK button: To clear and recover from an error. In some operator call errors, the error will automatically be cleared when the cause of the error is eliminated, and pressing the OK button may not be necessary.
- 3) Stop/Reset button: To cancel the job at error occurrence, and to clear the error.

2-1. Operator Call Errors (by Alarm LED Lit in Orange)

Error	Error code	Message on the LCD	Solution
No paper (ASF).	[1000]	Auto sheet feeder. There is no paper. Load paper and press [OK].	Set the paper in the ASF, and press the OK button.
No CD / DVD tray* ¹ .	[1001]	There is no CD-R tray. Attach the tray and press [OK].	Set the CD / DVD tray, and press the OK button.
No paper in the front paper feed cassette.	[1003]	Cassette. There is no paper. Load paper and press [OK].	Set the paper in the cassette, and press the OK button.
No CD or DVD* ¹ .	[1002]	Printable disc is not set. Correctly place a disc in the CD-R tray and press [OK].	Set a CD or DVD in the CD / DVD tray (which is ejected at error occurrence), and inset the CD / DVD tray in the proper position. Then, press the OK button.
Paper jam.	[1300]	The paper is jammed. Clear the paper and press [OK].	Remove the jammed paper, and press the OK button.
Paper jam in the rear guide.	[1303]		
Paper jam in the under guide.	[1304]		
No ink.	[1600]	Ink has run out. Replace the ink tank and close the cover. (U041)	Replace the empty ink tank(s), and close the cover. Pressing the OK button will clear the error without ink tank replacement, however, ink may run out during printing.
Ink tank not installed.	[1660]	The following ink tank cannot be recognized. (Applicable ink tank icon) (U043)	Install the applicable ink tank(s) properly, and confirm that the LED's of all the ink tanks light red.
The print head is not installed, or it is not properly installed.	[1401]	Print head is not installed. Install the print head. (U051)	Install the print head properly.
Print head temperature sensor error	[1403]	The type of print head is incorrect. Install the correct print head.	Re-set the print head. If the error is not cleared, the print head may be defective. Replace the print head.
Faulty EEPROM data of the print head	[1405]		
Inner cover open before start of printing on paper (print continuable). ^{*2}	[1841]	Inner cover is open. Close the inner cover and press [OK].	Close the inner cover, and press the OK button.
Inner cover open during printing on paper (print NOT continuable). ^{*2}	[1846]		Close the inner cover, and press the OK button to clear the error. The paper being printed at error occurrence will be ejected without printing the remaining data for the ejected paper, then printing will resume from the next page.
Inner cover open before start of printing on paper (print continuable). ^{*1}	[1851]		Close the inner cover, and press the OK button.
Inner cover open during printing on paper (print	[1856]		Close the inner cover, and press the OK button to clear the error. The paper being

NOT continuable). ^{*1}			printed at error occurrence will be ejected without printing the remaining data for the ejected paper, then printing will resume from the next page.
Inner cover closed before start of CD / DVD printing (print continuable). ^{*1}	[1850]	Open the inner cover, place the CD-R tray and press [OK].	Open the inner cover which functions as the CD / DVD tray feeder, set the CD / DVD tray in the feeder, and press the OK button.
Inner cover closed during CD / DVD printing (print NOT continuable). ^{*1}	[1855]		Open the inner cover, and press the OK button to clear the error. The CD or DVD being printed at error occurrence will be ejected without printing the remaining data for the ejected CD or DVD, then the next print job will be done.
Multiple ink tanks of the same color installed.	[1681]	More than one ink tank of the following color is installed. (U075)	Replace the wrong ink tank(s) with the correct one(s).
Ink tank in a wrong position.	[1680]	Some ink tanks are not installed in place. (U072)	Install the ink tank(s) in the correct position.
Warning: The waste ink absorber becomes almost full.	[1700]	The waste ink absorber is almost full. Press [OK] to continue but early replacement recommended. <See manual>	Press the OK button. The service call error, indicating the waste ink absorber is full, is likely to occur soon.
The connected digital camera or digital video camera does not support Camera Direct Printing.	[2001]	Incompatible device detected. Remove the device.	Remove the cable between the camera and the machine.
Automatic duplex printing cannot be performed.	[1310]	This paper is not compatible with duplex printing. Remove the paper and press [OK].	Press the OK button to eject the paper being used at error occurrence. Printing will resume from on the front side of the next page. Data which was to be printed on the back side of paper at error occurrence is skipped (not printed).
Failed in automatic print head alignment.	[2500]	Auto head align has failed. Press [OK] and repeat operation. <See manual>	Press the OK button. - If paper is being fed at error occurrence, the error is indicated after the paper is ejected. - If the error occurs, the print head alignment values are not changed. - After exit from the error by the OK button, the automatic print head alignment will not be re-done. The error will occur when the print head alignment pattern is not printed due to no ink or non-ejection of ink.
The remaining ink amount unknown.	[1683]	(Applicable ink tank icon) The remaining level of the following ink cannot be correctly detected.	An ink tank which has once been empty is installed. Replace the applicable ink tank with a new one. Printing with a once-empty or refilled ink tank can damage the print head. If printing is continued without replacing the refilled ink tank, press the Stop/Reset button for 5 sec. or longer to record the use of a refilled ink tank. Note: After the above operation, the function to detect the remaining ink amount is disabled.
Ink tank not recognized.	[1684]	(Applicable ink tank icon) The following ink tank cannot be recognized. (U140)	A non-supported ink tank is installed (the ink tank LED is turned off). Install the supported ink tanks.
Ink tank not recognized.	[1410 to 1419] [1682]	(Applicable ink tank icon) The following ink tank cannot be recognized. (U150)	An error occurred in an ink tank (the ink tank LED is turned off). Replace the ink tank(s).
Scanning unit (printer cover) open.	[1200]	Cover is open. Close the cover.	Close the scanning unit (printer cover).
Scanner lock switch locked.	[5020]	Release the scanner lock switch and turn the power off and back on.	Turn the machine off, unlock the scanner lock switch, then turn the machine on again.

*1: Only for models supporting CD / DVD printing

*2: Only for models not supporting CD / DVD printing

2-2. Service Call Errors (by Cyclic Blinking in Orange (Alarm LED) and Green (COPY button), or Alarm LED Lit in Orange)

Service call errors are indicated by the number of cycles the Alarm LED and COPY button blink, and the corresponding error code is displayed on the LCD.

Cycles of blinking in orange (Alarm LED) and green (COPY button)	Error	Error code	Conditions	Solution (Replacement of listed parts, which are likely to be faulty)
2 times	Carriage error	[5100]	An error occurred in the carriage encoder signal.	- Carriage unit - Timing slit film - Logic board - Carriage motor
3 times	Line feed error	[6000]	An error occurred in the LF encoder signal.	- Timing sensor unit - Timing slit disk film - Feed roller - Platen unit - Logic board - Paper feed motor
4 times	Purge cam sensor error	[5C00]	An error occurred in the purge unit.	- Purge unit - Logic board
5 times	ASF (cam) sensor error	[5700]	This error takes place when feeding paper from the ASF after an error occurred in the ASF cam sensor.	- Sheet feed unit
6 times	Internal temperature error	[5400]	The internal temperature is not proper.	- Logic board - Carriage unit
7 times	Waste ink absorber full	[5B00]	The waste ink absorber is full.	- Ink absorber kit
8 times	Print head temperature rise error	[5200]	The print head temperature exceeded the specified value.	- Print head - Logic board
9 times	EEPROM error	[6800]	A problem occurred in writing to the EEPROM.	- Logic board
11 times	Carriage lift mechanism error	[5110]	The carriage did not move up or down properly.	- PR lift shaft - Sheet feed unit - Logic board - Carriage lift sensor unit
12 times	AP position error	[6A00]	An error occurred in the AP motor during purging operation.	- Sheet feed unit - Logic board - Purge unit
13 times	Paper feed position error	[6B00]	An error occurred in the paper feed motor.	- Sheet feed unit - Logic board
14 times	Paper feed cam sensor error	[6B10]	An error occurred in the paper feed cam sensor during paper feeding from the front paper feed cassette. This error is also indicated when the waste ink counter is 60% or more, and a paper jam occurs in the under guide.	- Sheet feed unit - Logic board
15 times	USB Host VBUS overcurrent	[9000]	The USB Host VBUS is overloaded.	- Logic board
16 times	Valve sensor error	[6C00]	An error occurred in the valve sensor during cleaning.	- Logic board - Purge unit
17 times	Motor driver error	[6D00]	The AD conversion value indicating the motor driver temperature is not proper.	- Logic board
19 times	Ink tank position sensor error	[6502]	None of the ink tank position is detected.	- Platen unit - Logic board
20 times	Other hardware error	[6500]	The PCI bus error is detected by the ASIC.	- Logic board
22 times	Scanner error	[5010]	The scanner unit cannot detect the home position, or the scanner unit warming-up is not done properly at power-on. On the LCD, "Scanner is not operating correctly." is displayed.	- Scanner unit
Continuous alternate	ROM error	[6100]	The check sum value is incorrect in the ROM check at	- Logic board

blinking			hard-power-on.	
Alarm LED lit	RAM error	[6300]	The RAM error occurred in the RAM check at hard-power-on.	- Logic board

Note: Before replacement of the logic board ass'y, check the waste ink amount (by service test print or EEPROM information print). If the waste ink amount is 7% or more, also replace the ink absorber kit (QY5-0153) when replacing the logic board ass'y. [See Section 3-3. Adjustment / Settings, (6) Service mode, for details.]

2-3. Fax Errors

For errors other than those listed below, please refer to the "G3 / G4 Facsimile Error Code List (Rev. 2)."

(1) User error codes

Error code	TX / RX	Meaning
#001	TX	Document jam
#003	TX / RX	Document is too long, or page time-over
#005	TX / RX	Initial identification (T0 / T1) time-over
#009	RX	Recording paper jam, or no recording paper
#012	TX	No recording paper at the receiving machine
#017	TX	Redial time-over, but no DT detected
#018	TX	Auto dialing transmission error, or redial time-over
#022	TX	Call failed (no dial registration)
#037	RX	Memory overflow at reception of an image
#085	TX	No color fax function supported in the receiving machine
#099	TX / RX	Transmission terminated mid-way by pressing the Stop/Reset button
#995	TX / RX	During TX (sending): Memory transmission reservation cancelled During RX (receiving): Image data received in the memory cleared

(2) Service error codes

Error code	TX / RX	Meaning
##100	TX	Re-transmission of the procedure signal has been attempted the specified number of times, but failed.
##101	TX / RX	Sender's modem speed does not match the receiving machine.
##102	TX	Fallback is not available.
##103	RX	EOL has not been detected for 5 seconds (or 15 seconds in CBT).
##104	TX	RTN or PIN has been received.
##106	RX	The procedure signal has been expected for 6 seconds, but not received.
##107	RX	Fallback is not available at the sending machine.
##109	TX	After DCS transmission, a signal other than DIS, DTC, FTT, CFR, or CRP has been received, and re-transmission of the procedure signal has been attempted the specified number of times but failed.
##111	TX / RX	Memory error
##114	RX	RTN has been received.
##200	RX	A carrier has not been detected for 5 seconds during image reception.
##201	TX / RX	DCN has been received in a method other than the binary procedure.
##204	TX	DTC has been received even when there is no sending data.
##220	TX / RX	System error (main program hang-up)
##224	TX / RX	An error has occurred in the procedure signal in G3 transmission.
##226	TX / RX	The stack pointer has shifted from the RAM area.
##229	RX	The recording area has been locked for 1 minute.
##232	TX	The encoder control unit has malfunctioned.
##237	RX	The decoder control unit has malfunctioned.
##238	RX	The print control unit has malfunctioned.
##261	TX / RX	A system error has occurred between the modem and the system control board.

##280	TX	Re-transmission of the procedure signal has been attempted the specified number of times, but failed.
##281	TX	Re-transmission of the procedure signal has been attempted the specified number of times, but failed.
##282	TX	Re-transmission of the procedure signal has been attempted the specified number of times, but failed.
##283	TX	Re-transmission of the procedure signal has been attempted the specified number of times, but failed.
##284	TX	After TCF transmission, DCN has been received.
##285	TX	After EOP transmission, DCN has been received.
##286	TX	After EOM transmission, DCN has been received.
##287	TX	After MPS transmission, DCN has been received.
##288	TX	After EOP transmission, a signal other than PIN, PIP, MCF, RTP, RTN has been received.
##289	TX	After EOM transmission, a signal other than PIN, PIP, MCF, RTP, RTN has been received.
##290	TX	After MPS transmission, a signal other than PIN, PIP, MCF, RTP, RTN has been received.
##670	TX	In V.8 late start, the DIS V.8 ability from the receiving machine was detected, and CI was sent in response; however, the procedure failed, causing T1 time-over.
##671	RX	In V.8 call reception, the procedure fails to proceed to phase 2 after CM detection, causing T1 time-over.
##672	TX	In V.34 transmission, the procedure fails to proceed from phase 2 to phase 3 or later, causing T1 time-over
##673	RX	In V.34 reception, the procedure fails to proceed from phase 2 to phase 3 or later, causing T1 time-over
##674	TX	In V.34 transmission, the procedure fails to proceed from phase 3 or 4 to the control channel or later, causing T1 time-over
##675	RX	In V.34 reception, the procedure fails to proceed from phase 3 or 4 to the control channel or further, causing T1 time-over
##750	TX	After transmitting PPS-NULL in ECM transmission, no significant signal has been received, and re-transmission of the procedure signal has been attempted the number of specified times but failed.
##752	TX	After transmitting PPS-NULL in ECM transmission, DCN has been received.
##753	TX	After transmitting PPS-NULL in ECM transmission, re-transmission of the procedure signal has been attempted the number of specified times but failed, or T5 time-over (60 sec.) has occurred.
##754	TX	After transmitting PPS-NULL in ECM transmission, re-transmission of the procedure signal has been attempted the number of specified times but failed.
##755	TX	After transmitting PPS-MPS in ECM transmission, no significant signal has been received, and re-transmission of the procedure signal has been attempted the number of specified times but failed.
##757	TX	After transmitting PPS-MPS in ECM transmission, DCN has been received.
##758	TX	After transmitting PPS-MPS in ECM transmission, re-transmission of the procedure signal has been attempted the number of specified times but failed, or T5 time-over (60 sec.) has occurred.
##759	TX	After transmitting PPS-MPS in ECM transmission, re-transmission of the procedure signal has been attempted the number of specified times but failed.
##760	TX	After transmitting PPS-EOM in ECM transmission, no significant signal has been received, and re-transmission of the procedure signal has been attempted the number of specified times but failed.
##762	TX	After transmitting PPS-EOM in ECM transmission, DCN has been received.
##763	TX	After transmitting PPS-EOM in ECM transmission, re-transmission of the procedure signal has been attempted the number of specified times but failed, or T5 time-over (60 sec.) has occurred.
##764	TX	After transmitting PPS-EOM in ECM transmission, re-transmission of the procedure signal has been attempted the number of specified times but failed.
##765	TX	After transmitting PPS-EOP in ECM transmission, no significant signal has been received, and re-transmission of the procedure signal has been attempted the number of specified times but failed.
##767	TX	After transmitting PPS-EOP in ECM transmission, DCN has been received.
##768	TX	After transmitting PPS-EOP in ECM transmission, re-transmission of the procedure signal has been attempted the number of specified times but failed, or T5 time-over (60 sec.) has occurred.
##769	TX	After transmitting PPS-EOP in ECM transmission, re-transmission of the procedure signal has been attempted the number of specified times but failed.
##770	TX	After transmitting EOR-NULL in ECM transmission, no significant signal has been received, and re-transmission of the procedure signal has been attempted the number of specified times but failed.
##772	TX	After transmitting EOR-NULL in ECM transmission, DCN has been received.
##773	TX	After transmitting EOR-NULL in ECM transmission, re-transmission of the procedure signal has been attempted the number of specified times but failed, or T5 time-over (60 sec.) has occurred.
##774	TX	After transmitting EOR-NULL in ECM transmission, ERR has been received.
##775	TX	After transmitting EOR-MPS in ECM transmission, no significant signal has been received, and re-transmission of the procedure signal has been attempted the number of specified times but failed.
##777	TX	After transmitting EOR-MPS in ECM transmission, DCN has been received.
##778	TX	After transmitting EOR-MPS in ECM transmission, re-transmission of the procedure signal has been attempted the

		number of specified times but failed, or T5 time-over (60 sec.) has occurred.
##779	TX	After transmitting EOR-MPS in ECM transmission, ERR has been received.
##780	TX	After transmitting EOR-EOM in ECM transmission, no significant signal has been received, and re-transmission of the procedure signal has been attempted the number of specified times but failed.
##782	TX	After transmitting EOR-EOM in ECM transmission, DCN has been received.
##783	TX	After transmitting EOR-EOM in ECM transmission, re-transmission of the procedure signal has been attempted the number of specified times but failed, or T5 time-over (60 sec.) has occurred.
##784	TX	After transmitting EOR-EOM in ECM transmission, ERR has been received.
##785	TX	After transmitting EOR-EOP in ECM transmission, no significant signal has been received, and re-transmission of the procedure signal has been attempted the number of specified times but failed.
##787	TX	After transmitting EOR-EOP in ECM transmission, DCN has been received.
##788	TX	After transmitting EOR-EOP in ECM transmission, re-transmission of the procedure signal has been attempted the number of specified times but failed, or T5 time-over (60 sec.) has occurred.
##789	TX	After transmitting EOR-EOP in ECM transmission, ERR has been received.
##790	RX	After receiving EOR-EOP in ECM reception, ERR has been transmitted.
##791	TX / RX	During the ECM mode procedure, a signal other than a significant one has been received.
##792	RX	In ECM reception, PPS-NULL between partial pages has not been detected.
##793	RX	During high-speed signal reception in ECM, no effective frame has been detected, and a time-over has occurred.

2-4. Other Error Messages

Message on the LCD	Cause	Solution
The selected paper cannot be fed from cassette. Change the paper source.	The paper type being used is not supported for paper feeding from the cassette.	Change the paper source to the ASF.
Cannot specify the followings together. Change one of the settings.	Settings made conflict each other.	The error message is displayed for a while, then the LCD automatically returns to the display before the error occurrence.
Device memory is full. Cannot continue process. Reduce the number of photos to print.	The memory is not sufficient to do the print job.	Reduce the amount of data to be printed, or print from a computer.
Failed to scan. Either document cannot be scanned or is not placed on the platen glass.	The machine failed in scanning the document for Fit-to-page copy, or photos or films were not recognized in pre-scanning.	Press the OK button to clear the error. The LCD automatically returns to the display before the error occurrence.
Press ◁. (▷: Color button icon)	The Black button was pressed, but it is invalid.	A temporary error. Press the Color button to continue the operation.
Press ▷. (◁: Black button icon)	The Color button was pressed, but it is invalid.	A temporary error. Press the Black button to continue the operation.
There are no photos in memory card.	Supported image files are not in the memory card.	The error message is displayed for a while, then disappears.
The value exceeds the number of copies you can print.	During selecting images or specifying the number of copies, the total print quantity exceeds the prescribed value of 999.	After the error message is displayed for a while, the last operation before the error is cancelled, and the total print quantity returns to the value before the error.
Memory card is not set. Insert the card after checking the direction.	No memory card is inserted in the slot.	Set a memory card.
DPOF information is not saved in the memory card.	DPOF print was selected in the menu, but no DPOF files are contained in the memory card.	The error message is displayed for a while, then the LCD automatically returns to the display before the error occurrence.
The number of copies to print is not set. Input the number of copies.	Multi-photo print was attempted without specifying the print quantity (with the print quantity left "0" (zero)).	The error message is displayed for a while, then disappears. Specify the print quantity.
This layout is available only for A4 or 8.5"x11"(LTR).	In Layout print, "Mixed 1, 2, or 3" which is available only with A4 or LTR size paper is selected, but the paper size is not set to A4 or LTR.	The error message is displayed for a while, then the LCD automatically returns to the display before the error occurrence.
Settings cannot be changed when printing stickers.	With Sticker print selected, the Settings button was pressed.	The error message is displayed for a while, then the LCD automatically returns to the display before the error occurrence.

Change the setting after removing the card.	With a memory card inserted in the slot, change of the Read/Write attribute was attempted.	The error message is displayed for a while, then the LCD automatically returns to the display before the error occurrence.
The card is currently write-enabled. Set to read-only mode before performing operation.	With the memory card set to the Read/write mode, Card Direct printing operation was attempted from the menu.	The error message is displayed for a while, then the LCD automatically returns to the display before the error occurrence.
The paper size is not correct. Check the page size you have set.	Non-supported size of paper for PictBridge Camera Direct printing is selected.	Cancel printing on the digital camera.
Failed to scan Photo Index Sheet. Check the orientation, position and marking. <See manual>	The machine failed in scanning the Photo Index Sheet.	Press the OK button to clear the error. The LCD automatically returns to the display before the error occurrence.
Photo scan error. Photo size is too large. Leave at least 10mm between photos.	In cropping multiple photos at the same time, since the space between the photos were not sufficient, the photos were considered as a single JPEG file, and the file became too large.	Press the OK button to clear the error. The LCD automatically returns to the display before the error occurrence.

2-5. Warnings

Warning	Message on the LCD	Solution
Low ink	The following ink is low. Continue? (Icon of each ink tank) Yes No In Camera Direct Printing, only "Yes" can be selected.	- Select Yes , and press the OK button. => Printing starts, and it is indicated on the LCD. - Select No , and press the OK button. => Printing is cancelled, and the LCD returns to the display immediately before printing was attempted.
Print head temperature rise	If the print head temperature does not fall, the error code "5200" is displayed, indicating the print head temperature rise error.	When the print head temperature falls, the error is automatically cleared. Note: If the print head temperature exceeds the specified limit when the scanning unit (printer cover) is opened, the carriage does not move to the ink tank replacement position.
Protection of excess rise of the print head temperature	If the print head temperature does not fall, the error code "5200" is displayed, indicating the print head temperature rise error.	If the print head temperature exceeds the specified limit, an intermission is inserted during printing.
Restrictions on paper	The current paper cannot be set. Change the size and type.	Re-select the supported paper type and size.
Recommendation of the print head alignment (only on arrival of the machine)	Head alignment required. Load paper and press [OK]. Yes No	- Select Yes , and press the OK button. => Automatic print head alignment is performed. - Select No , and press the OK button. => The procedures on arrival of the machine are finished.
USB cable not connected	Connect USB cable and turn on the PC.	Connect the USB cable.
Cancellation of trimming	Reset trimming effect? Yes No	With a trimmed image present, when printing on a DVD or CD is attempted, the message is displayed. - Select Yes , and press the OK button. => The trimming is cancelled, and printing on a DVD or CD can be performed. - Select No , and press the OK button. => The LCD returns to the display immediately before the message was displayed.
Cancellation of image select information	Reset the selected photo information? Yes No	When one or more images are selected in Multi-photo print or Layout print, and if a user tries to display the menu or sub-menu, the message is displayed. - Select Yes , and press the OK button. => The image selection is cancelled, and the menu or sub-menu is displayed. - Select No , and press the OK button. => The LCD returns to the display immediately before the message was displayed.

2-6. Troubleshooting by Symptom

	Symptom	Solution
Faulty operation	The power does not turn on. The power turns off immediately after power-on.	<ul style="list-style-type: none"> - Confirm the connection of <ul style="list-style-type: none"> - the power cord, and - between the logic board and the power supply unit. - Replace the <ul style="list-style-type: none"> - power supply unit, or - logic board.
	A strange noise occurs.	<ul style="list-style-type: none"> - Remove foreign material. - Attach a removed part if any. - Check the operation of the moving parts (such as purge unit, carriage unit, and paper feeding mechanism) - Replace a faulty part, if any.
	Nothing is displayed on the LCD.	<ul style="list-style-type: none"> - Confirm the connection between the operation panel, the scanning unit, and the logic board. - Replace the <ul style="list-style-type: none"> - LCD, or - logic board.
	A portion of the LCD is not displayed.	<ul style="list-style-type: none"> - Perform the button and LCD test in the service mode, and confirm that the LCD is displayed without any segments missing. - Confirm the connection between the operation panel, the scanning unit, and the logic board. - Replace the <ul style="list-style-type: none"> - LCD, or - logic board.
	Paper feed problems (multi-feeding, skewed feeding, no feeding).	<ul style="list-style-type: none"> - Examine the inside to confirm that no parts are damaged, and the rollers are clean. - Remove foreign material. - Adjust the paper guide properly. - Confirm the connection of each harness and the logic board. - Replace the <ul style="list-style-type: none"> - sheet feeder unit, - cassette, or - logic board.
	Carriage movement problems (contact to other parts, strange noise).	<ul style="list-style-type: none"> - Confirm that the carriage timing slit strip film is free from damage or grease. - Clean the carriage timing slit strip film (with ethanol and lint-free paper). - Replace the <ul style="list-style-type: none"> - carriage timing slit strip film, or - carriage unit.
	Faulty scanning (no scanning, strange noise).	<ul style="list-style-type: none"> - Confirm the connection between the scanning unit and the logic board. - Replace the <ul style="list-style-type: none"> - scanning unit, or - logic board.
	No paper feeding from the ADF (no operation of the ADF motor).	<ul style="list-style-type: none"> - Confirm the connection <ul style="list-style-type: none"> - between the ADF motor and the ADF PWB, and - between the ADF PWB and the logic board. - Replace the <ul style="list-style-type: none"> - document feed unit, or - logic board.
Unsatisfactory print quality	No printing, or no color ejected.	<ul style="list-style-type: none"> - Replace the <ul style="list-style-type: none"> - ink tank, - print head*1, or - logic board. - Remove foreign material from the purge unit caps, if any. - Replace the purge unit.
	Printing is faint, or white lines appear on printouts even after print head cleaning. Line(s) not included in the print data appears on printouts.	<ul style="list-style-type: none"> - Remove and re-install the print head. - Replace the <ul style="list-style-type: none"> - ink tank, - print head*1, - purge unit, or - logic board.
	Paper gets smeared.	<ul style="list-style-type: none"> - Feed several sheets of paper.

		<ul style="list-style-type: none"> - Perform bottom plate cleaning. - Clean the paper path with cotton swab or cloth. - Clean the ASF sub-rollers.
	A part of a line is missing on printouts.	<ul style="list-style-type: none"> - Replace the <ul style="list-style-type: none"> - ink tank, or - print head*1.
	Color hue is incorrect.	<ul style="list-style-type: none"> - Replace the <ul style="list-style-type: none"> - ink tank, or - print head*1. - Perform print head alignment.
	Printing is incorrect.	Replace the logic board.
	No ejection of black ink.	<ul style="list-style-type: none"> - Replace the <ul style="list-style-type: none"> - ink tank, or - print head*1. - Remove foreign material from the purge unit caps, if any. - Replace the purge unit.
	Graphic or text is enlarged on printouts.	<p>When enlarged in the carriage movement direction:</p> <ul style="list-style-type: none"> - Clean grease or oil off the timing slit strip film - Replace the <ul style="list-style-type: none"> - timing slit strip film, - carriage unit, or - logic board. <p>When enlarged in the paper feed direction:</p> <ul style="list-style-type: none"> - Clean grease or oil off the timing slit disk film - Replace the <ul style="list-style-type: none"> - timing slit disk film, - timing sensor unit, or - logic board.
Faulty scanning	No scanning.	<ul style="list-style-type: none"> - Confirm the connection between the scanning unit and the logic board. - Replace the <ul style="list-style-type: none"> - scanning unit, or - logic board.
	Streaks or smears on the scanned image.	<ul style="list-style-type: none"> - Clean the platen glass and the ADF. - Confirm the connection between the scanning unit and the logic board. - Replace the <ul style="list-style-type: none"> - scanning unit, - logic board, or - sponge sheet.
	No paper feeding from the ADF (no operation of the ADF motor).	<ul style="list-style-type: none"> - Confirm the connection <ul style="list-style-type: none"> - between the ADF motor and the ADF PWB, and - between the ADF PWB and the logic board. - Replace the <ul style="list-style-type: none"> - document feed unit, or - logic board.
	Document slipping over the roller (copied image enlarged), or document not separated.	<ul style="list-style-type: none"> - Clean the friction tab, document feed roller, and separation roller. - Replace the document feed unit.

*1: Replace the print head only after the print head deep cleaning is performed 2 times, and when the problem persists.

2-7. Fax Communication Troubleshooting

(1) Identification of a trouble

A fax machine transmits image data to a receiver through a telephone line. A trouble in any of the transmitter, receiver, and telephone line can prevent the machine from transmitting image data properly.

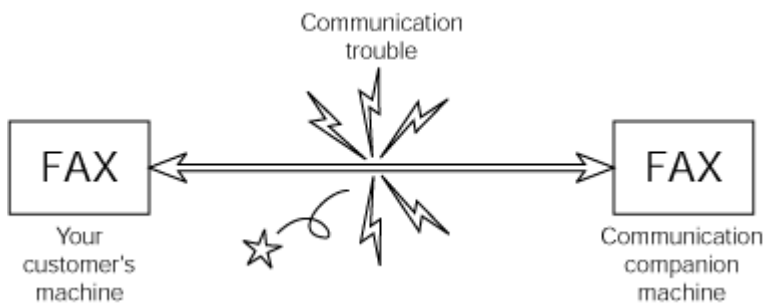

For the best solution to your fax trouble, follow the flowchart below to determine whether it is a communication trouble or not.

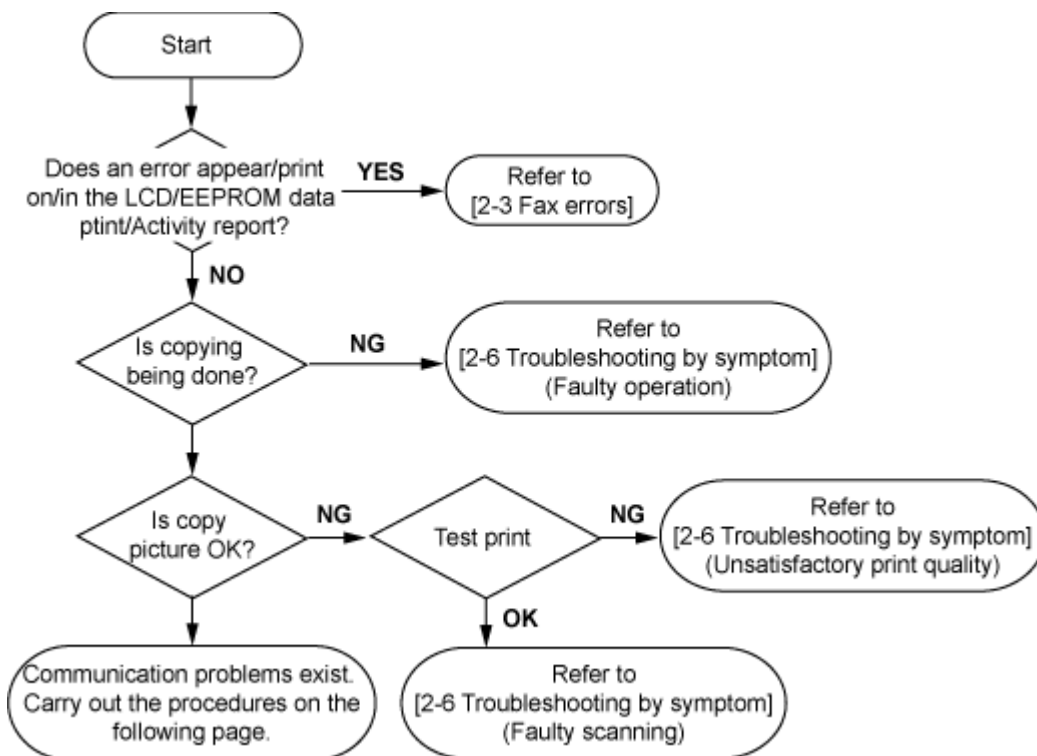

(2) Handling of a communication trouble

Follow the procedure below to handle communication troubles.

1) Investigate the condition in which the trouble occurred.

- a. User operation at trouble occurrence
 - Number of sheets of the document
 - Transmission mode
 - Timing when the error occurred (e.g. before or after transmission)
 - Other settings (e. g. such as automatic dialing)
- b. Sample print of a faulty fax reception
- c. Message on the LCD at trouble occurrence
- d. Activity report at trouble occurrence
- e. User name, telephone number, fax number, and model name
- f. The other party's user name, telephone number, fax number, model name, and service engineer name
- g. Frequency and error type of the trouble
- h. The other party's fax condition
 - Number of sheets transmitted
 - Communication mode (automatic or manual)
 - Whether an error occurred or not
 - Reception condition, etc.

Memo: The number of sheets / times of communication and error code can be confirmed in EEPROM information print.

2) Conduct the communication test, by following the flowchart below.

- Perform the operations using the actual line several times each, and record the phenomenon.
- If a communication trouble occurs between a Canon machine and a non-Canon machine, follow the flowchart for the communication test with a non-Canon machine.

3) Handle the problem based on the investigation and test results.

Memo: If a trouble occurs in communication with a non-Canon machine, and if a Canon machine operates properly without any problems, it is recommended to let the user understand that the non-Canon machine needs to be examined accordingly. Since the cause of the trouble may exist in communication ability of the machine, contact a relevant service contact point of a non-Canon machine. In such a case, the information obtained in step 1) will be a help for quick solution to the problem.

<Communication test between Canon machines>

Conduct the 3-point communication shown in the diagram.

Test flowchart of communication test between Canon machines:

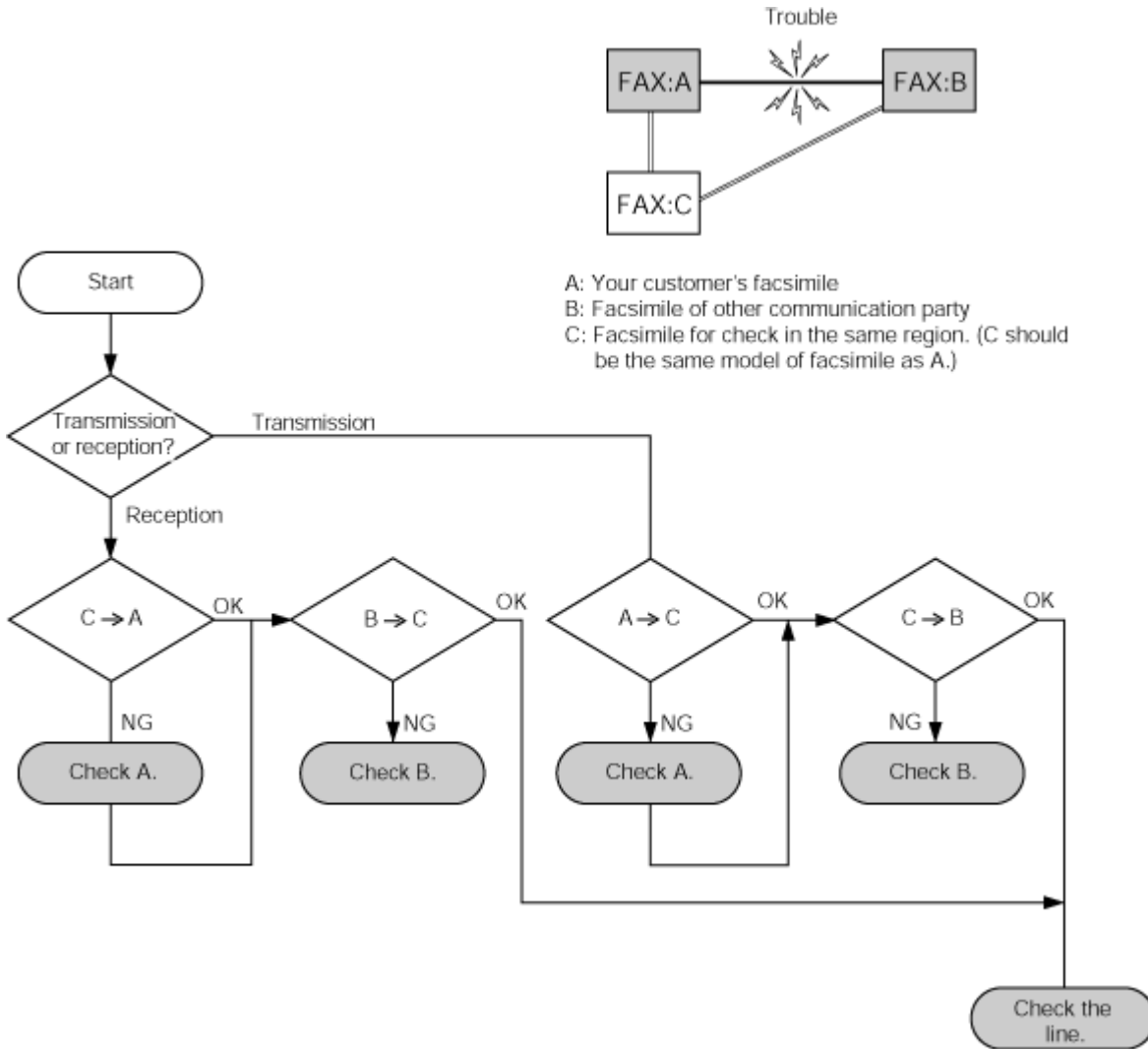

<Communication test with a non-Canon machine>

Ask a non-Canon machine user to request servicing, and conduct the 4-point communication test shown below.

Test flowchart of communication test with a non-Canon machine:

3. REPAIR

3-1. Notes on Service Part Replacement (and Disassembling / Reassembling)

Service part	Notes on replacement*1	Adjustment / settings	Operation check
Logic board ass'y QM2-3659	<ul style="list-style-type: none"> - Before removal of the logic board ass'y, remove the power cord, and allow for approx. 1 minute (for discharge of capacitor's accumulated charges), to prevent damages to the logic board ass'y. - Before replacement, check the waste ink amount (by service test print or EEPROM information print). [See 3-4. Verification Items, (1) Service test print, or (2) EEPROM information print, for details.] 	<p>After replacement:</p> <ol style="list-style-type: none"> 1. Initialize the EEPROM. 2. Set the destination in the EEPROM. 3. Reset the waste ink counter. 4. Correct the CD / DVD and automatic print head alignment sensors. 5. Check the ink system function. 6. Adjust the line feeding. [See 3-3. Adjustment / Settings, (6) Service mode, for details of 1 to 6] 7. Perform the print head alignment in the user mode. 	<ul style="list-style-type: none"> - EEPROM information print - Service test print - Printing via USB connection - Copy - Direct printing from a digital camera - Fax transmission and reception
Absorber kit QY5-0153		<p>After replacement:</p> <ol style="list-style-type: none"> 1. Reset the waste ink counter. [See 3.3. Adjustment / Settings, (6) Service mode.] 	<ul style="list-style-type: none"> - Service test print - EEPROM information print
Carriage unit QM2-3025		<p>At replacement:</p> <ol style="list-style-type: none"> 1. Apply grease to the sliding portions. [See 3-3. Adjustment / Settings, (2) Grease application.] <p>After replacement:</p> <ol style="list-style-type: none"> 1. Correct the CD / DVD and automatic print head alignment sensors. [See 3.3. Adjustment / Settings, (6) Service mode.] 2. Check the ink system function. [See 3.3. Adjustment / Settings, (6) Service mode.] 3. Perform the print head alignment in the user mode. 	<ul style="list-style-type: none"> - Service test print (Confirm CD / DVD and automatic print head alignment sensor correction, and ink system function.)
Paper feed motor QK1-1502	<ul style="list-style-type: none"> - The red screws securing the paper feed motor are allowed to be loosened. (DO NOT loosen any other red screws.) 	<p>At replacement:</p> <ol style="list-style-type: none"> 1. Adjust the paper feed motor. [See 3-3. Adjustment / Settings, (1) Paper feed motor adjustment.] 	
Platen unit QM2-3565		<p>After replacement:</p> <ol style="list-style-type: none"> 1. Check the ink system function. [See 3.3. Adjustment / Settings, (6) Service mode.] 	<ul style="list-style-type: none"> - Service test print
PR lift shaft ass'y QL2-0936		<p>At replacement:</p> <ol style="list-style-type: none"> 1. Apply grease to the sliding portions. [See 3.3. Adjustment / Settings, (2) Grease application.] 	<ul style="list-style-type: none"> - Service test print
Carriage lift base unit QM2-2232		<p>At replacement:</p> <ol style="list-style-type: none"> 1. Apply grease to the sliding portions. [See 3.3. Adjustment / Settings, (2) Grease application.] 	
Timing slit strip film QC1-6526	<ul style="list-style-type: none"> - Upon contact with the film, wipe the film with ethanol. - Confirm no grease is on the film. (Wipe off any grease thoroughly with ethanol.) - Do not bend the film 	<p>After replacement:</p> <ol style="list-style-type: none"> 1. Perform the print head alignment in the user mode. 	<ul style="list-style-type: none"> - Service test print
Timing slit disk film QC1-6229			
Print head QY6-0061		<p>After replacement:</p> <ol style="list-style-type: none"> 1. Perform the print head alignment in the user mode. 	<ul style="list-style-type: none"> - Service test print

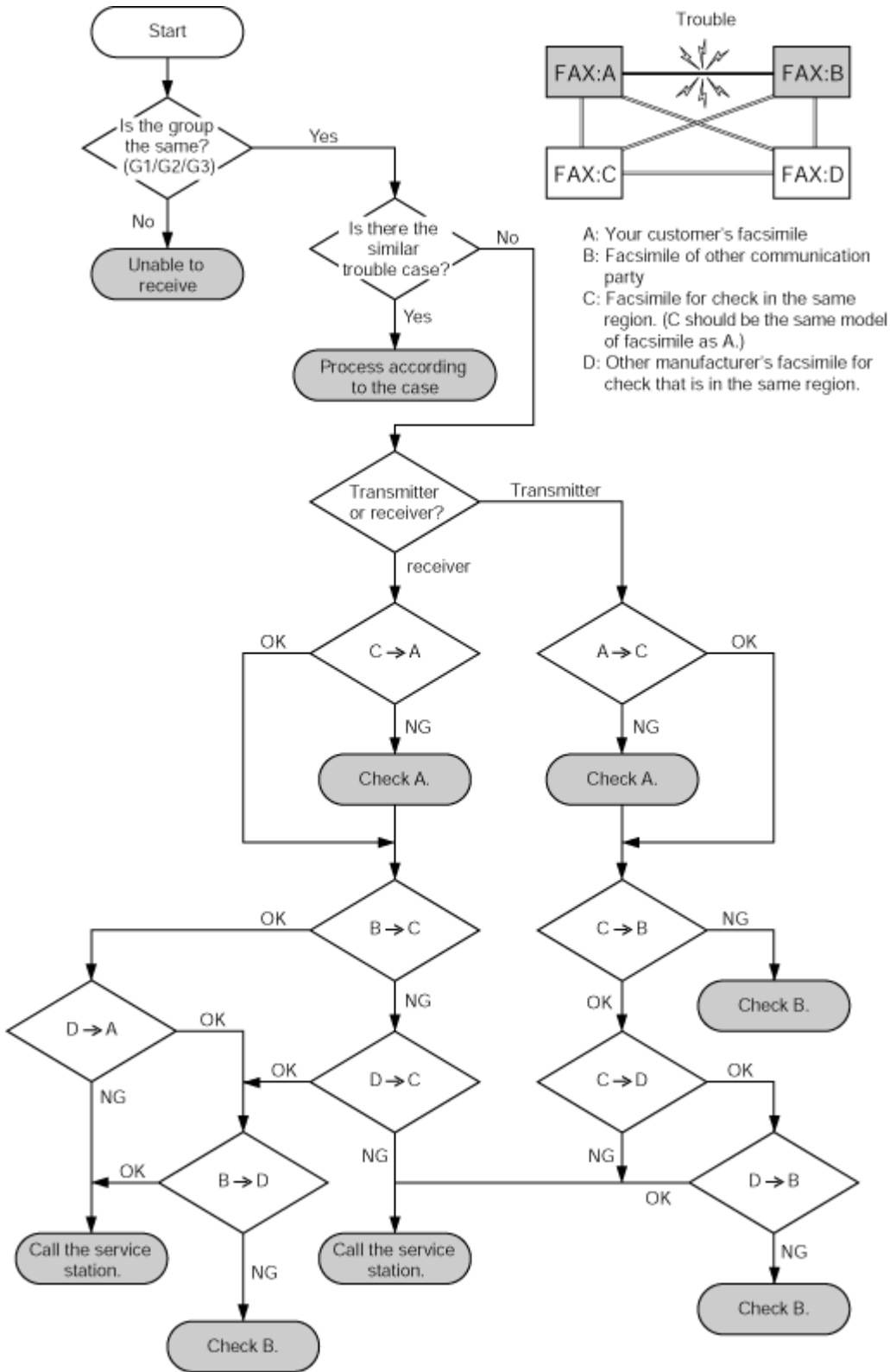

[To the table of contents](#)

[To the top](#)

← <Part 1: 2. LIST OF ERROR DISPLAY / INDICATION> →

*1: General notes:

- Make sure that the flexible cables and wires in the harness are in the proper position and connected correctly.
[See 3-2. Special Notes on Repair Servicing, for details.]
- Do not drop the ferrite core, which may cause damage.
- Protect electrical parts from damage due to static electricity.
- Before removing a unit, after removing the power cord, allow the machine to sit for approx. 1 minute (for capacitor discharging to protect the logic board ass'y from damages).
- Do not touch the timing slit strip film and timing slit disk film. No grease or abrasion is allowed.
- Protect the units from soiled with ink.
- Protect the housing from scratches.
- Exercise caution with the red screws, as follows:
 - i. The red screws of the paper feed motor may be loosened only at replacement of the paper feed motor unit (DO NOT loosen them in other cases).
 - ii. DO NOT loosen the red screws on both sides of the main chassis, securing the carriage shaft positioning (they are not adjustable in servicing)

To the table of contents

To the top

 **<Part 1: 3. REPAIR; 3-1. Notes on Service Part Replacement>** 

3-2. Special Notes on Repair Servicing

If there is a power failure or if you disconnect the power cord, the date/time settings as well as all documents stored in memory will be lost. User data and speed dialing settings are retained.

(1) Power supply unit removal / reassembly

Removal:

- Remove the screw.
- While releasing the 2 hooks outwards, slide the power supply unit toward you.

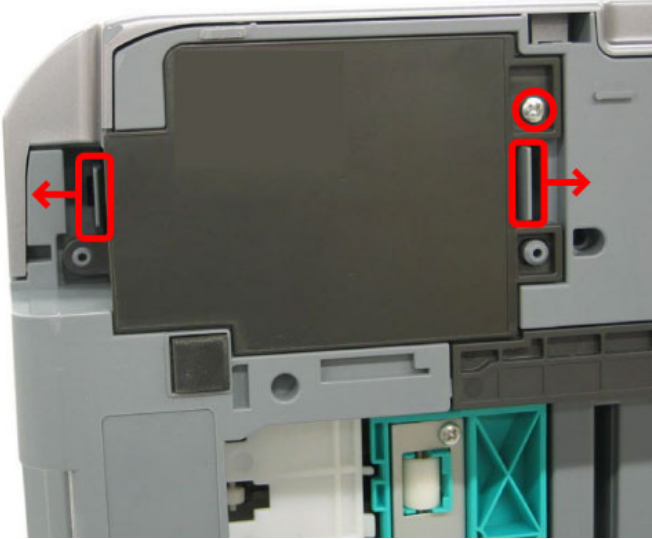

- Manually pull the arrester ground wire off the unit.

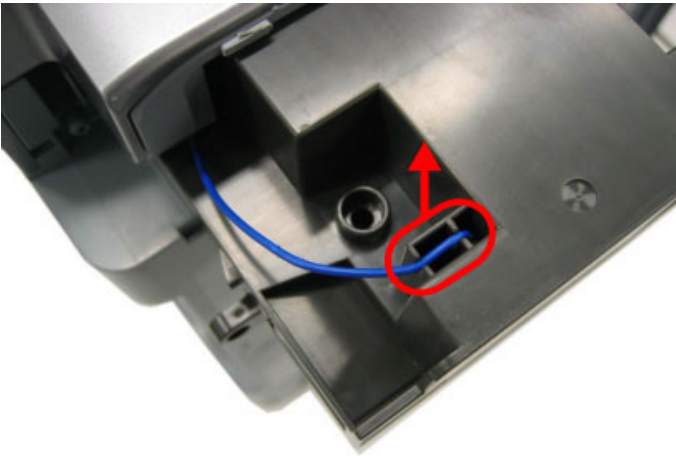

- Disconnect the 2 connectors.

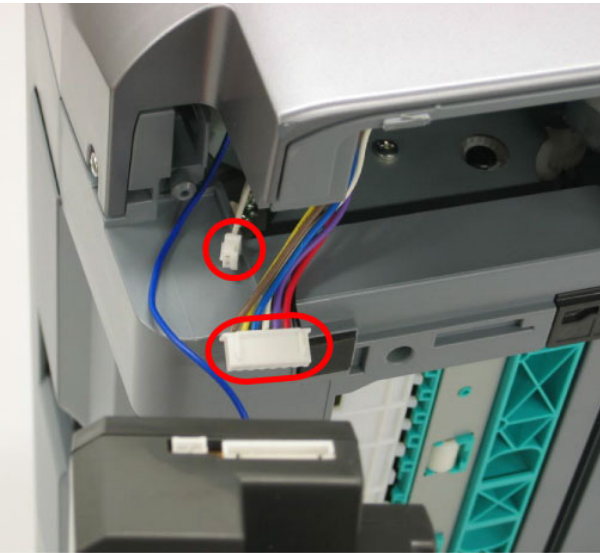

Reassembly:

- Connect the 2 connectors.



- Connect the arrester ground wire.

- Align the ground wire in the groove at 2 locations.

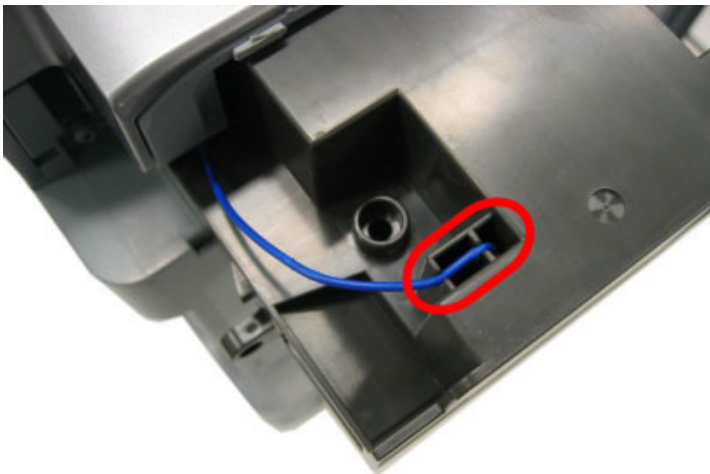

(2) Cassette, front door (paper output tray), and door damper removal

- Pull out the cassette and remove it from the machine.
- Warp the front door up a little and push its right side downward to remove it from the bottom case.
- When removing the front door, remove the door damper from the hole of the bottom case, as shown in the photo.

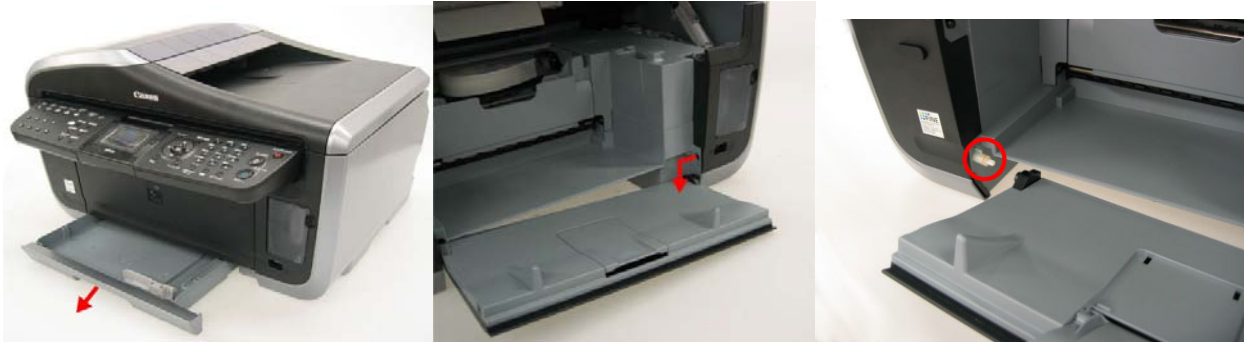

(3) Emblem removal

- Push the point indicated by the arrow in the photo to remove from the double-sided adhesive tape.



(4) Side cover (right and left) removal

- Remove the 4 screws from the rear of the machine, 1 screw from left front, and 1 screw from the right front.

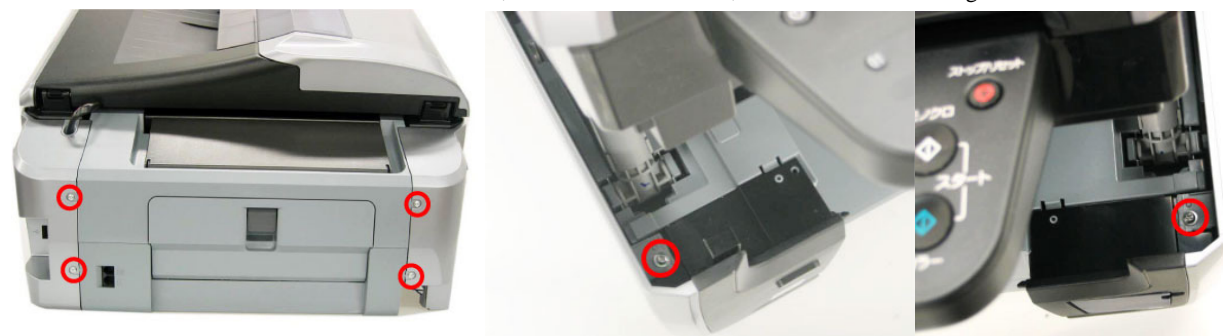

- Using a flat-blade screwdriver, push the hooks downward to release them.

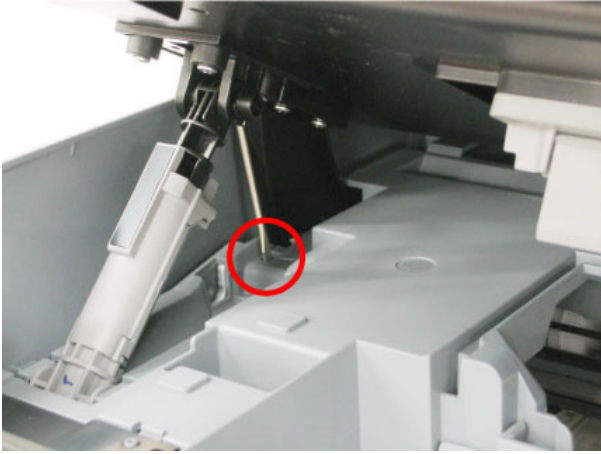

Left hook



Right hook



Left side cover

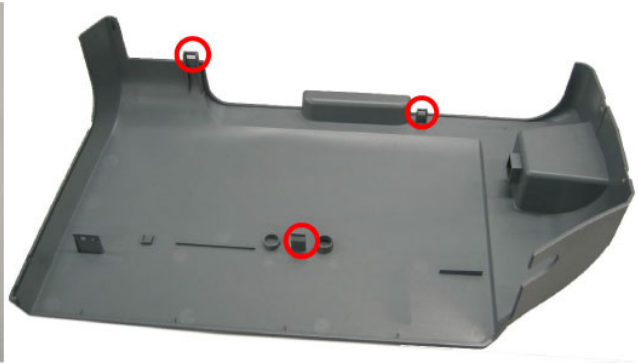

Right side cover

(5) Front cover (right and left) removal

- While pushing the hook with a flat-blade screwdriver, pull the front cover toward you to remove it.



Left front cover

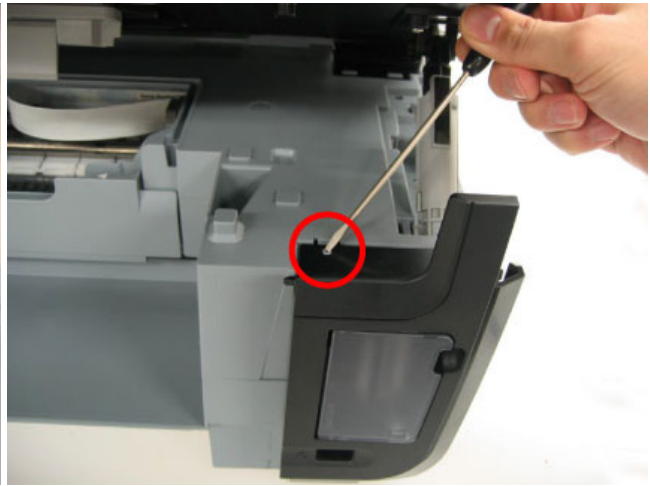

Right front cover

(6) DF front cover removal

- Remove the screw. Release the hook while pushing it in the direction indicated by the arrow in the photo.

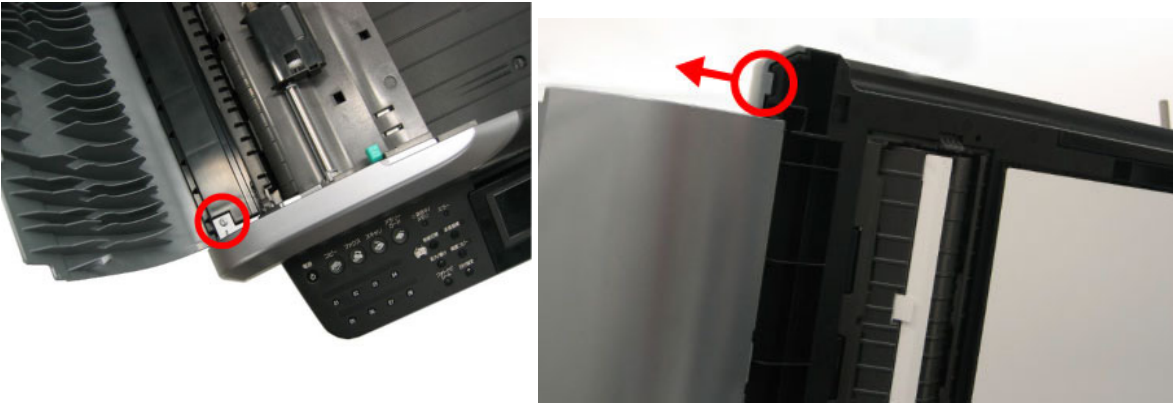

(7) DF rear cover removal

- Remove the screw. Release the hook while pushing it in the direction indicated by the arrow in the photo.

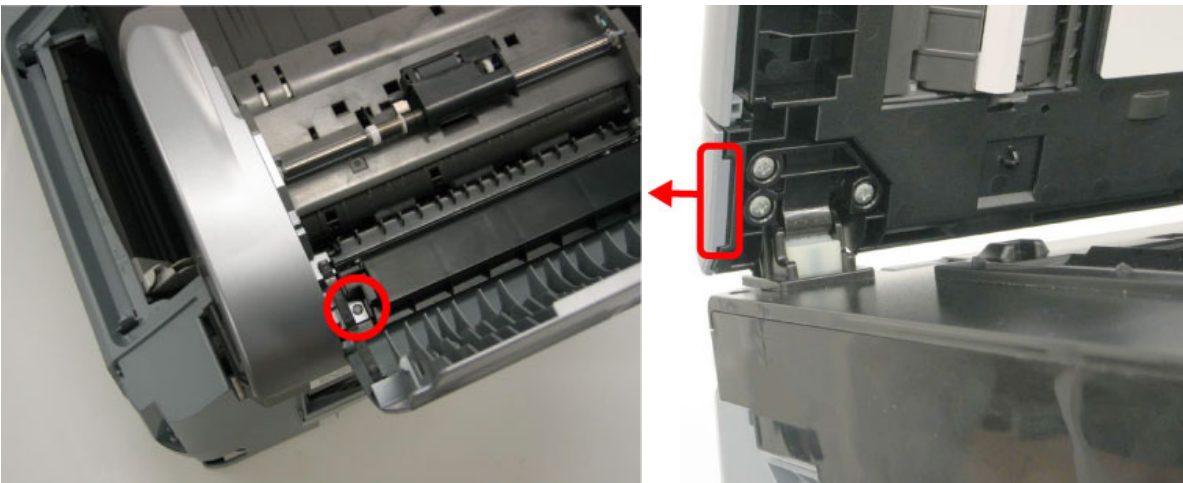

- Slide the stop arm in the direction indicated by the arrow and remove the DF rear cover.



(8) Stop arm removal

- Rotate the arm 90 degrees clockwise, pull it toward you to remove it.



(9) DF grip cover and DF right cover removal

- Remove the screws.

A: DF grip cover screws

B: DF right cover screws

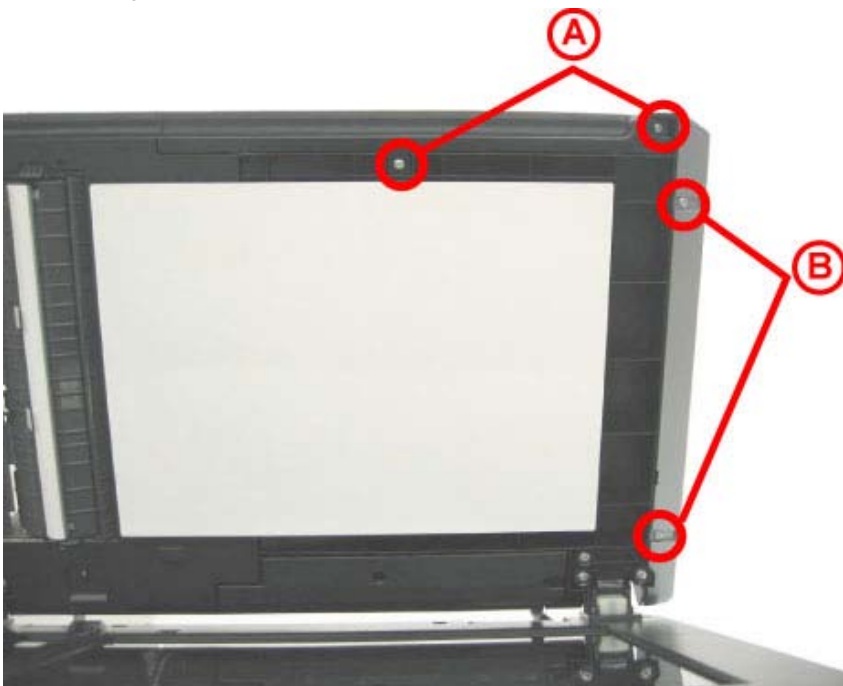

(10) Document feed unit removal

- Remove the 5 screws and 1 connector.

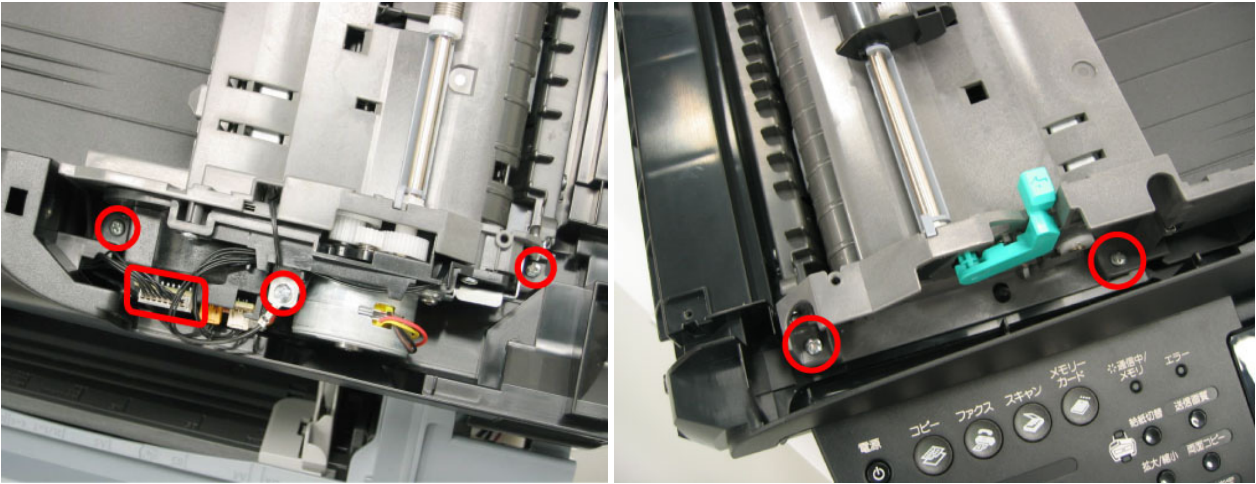

(11) Separation tab, document feed roller, and separation roller cleaning

- Wipe them with a dry and soft clean cloth.

1. Document feed roller
2. Separation roller
3. Separation tab

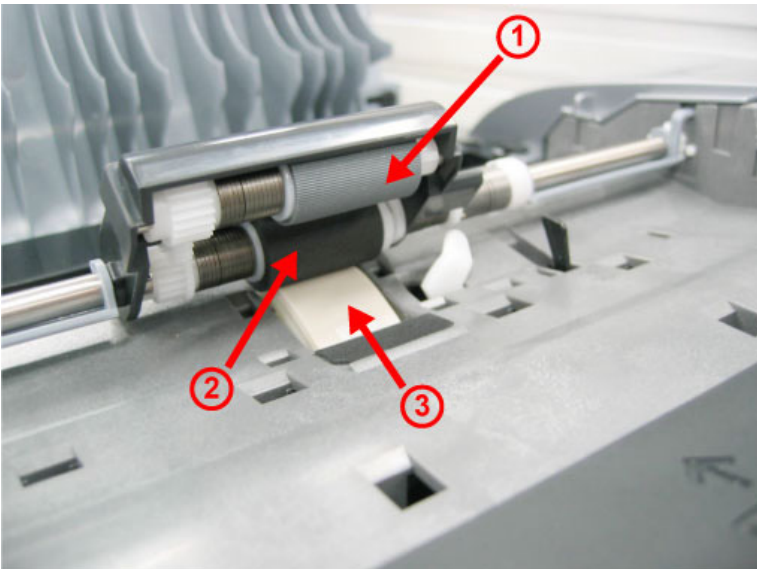

(12) DF cable cover removal

- Remove the 2 screws.

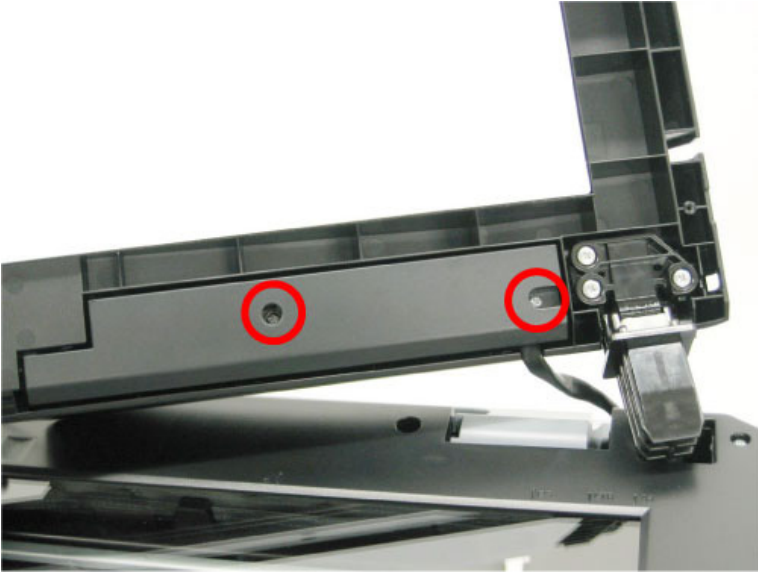

Cable position:



(13) ADF hinge removal

- Remove the 3 screws.



(14) Operation panel (right and left) removal

- Release 6 hooks each from the right and left operation panels.

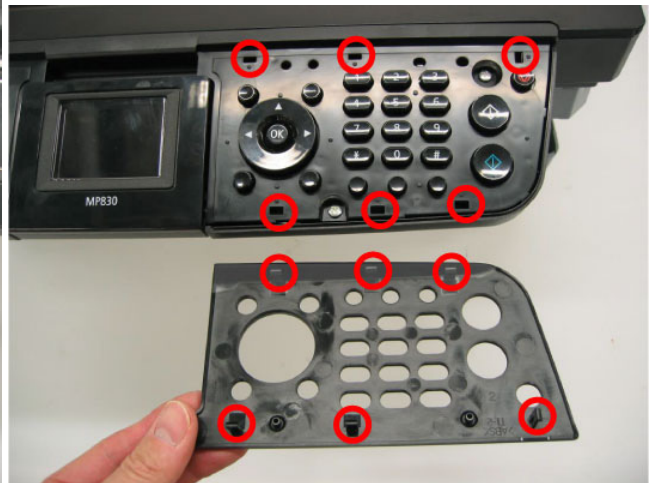
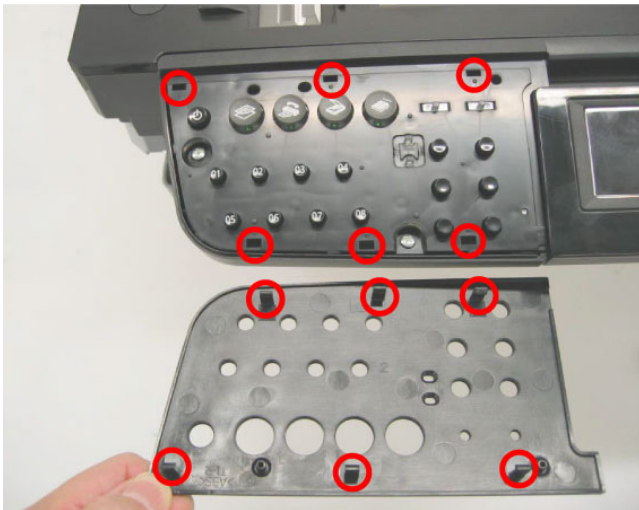

Left

Right

(15) LCD upper cover removal

- Push the front end of the LCD upper cover upward with your fingers and remove it.

- 4 hooks need to be released.

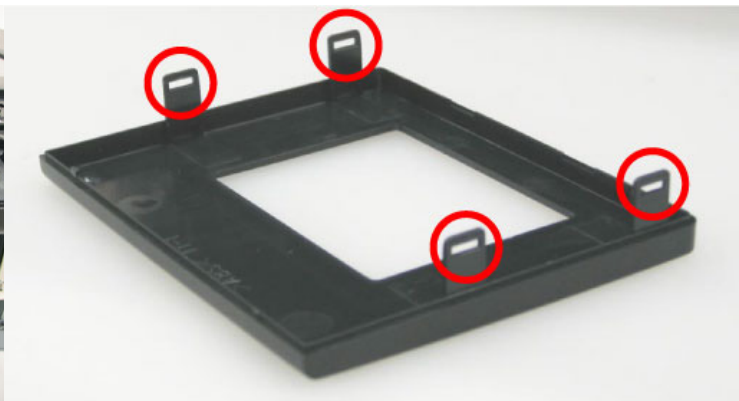

(16) Operation panel unit removal

- Remove the 4 screws.
- Remove the flat cable.

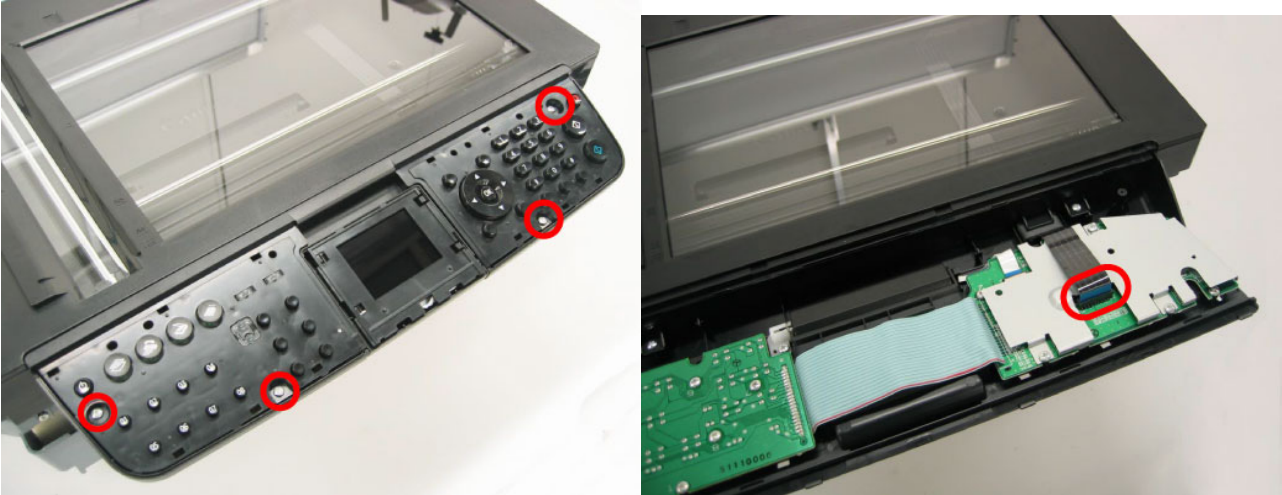

(17) LCD unit removal

- Remove the screw and disconnect the flat cable.

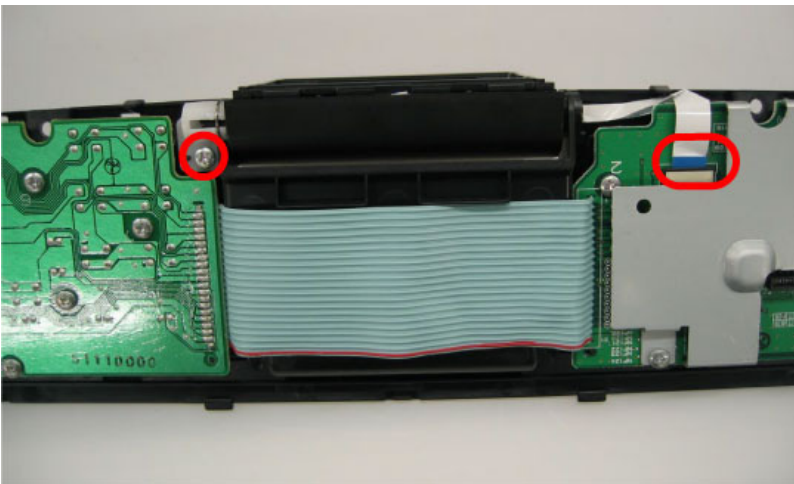

(18) Logic board ass'y wiring

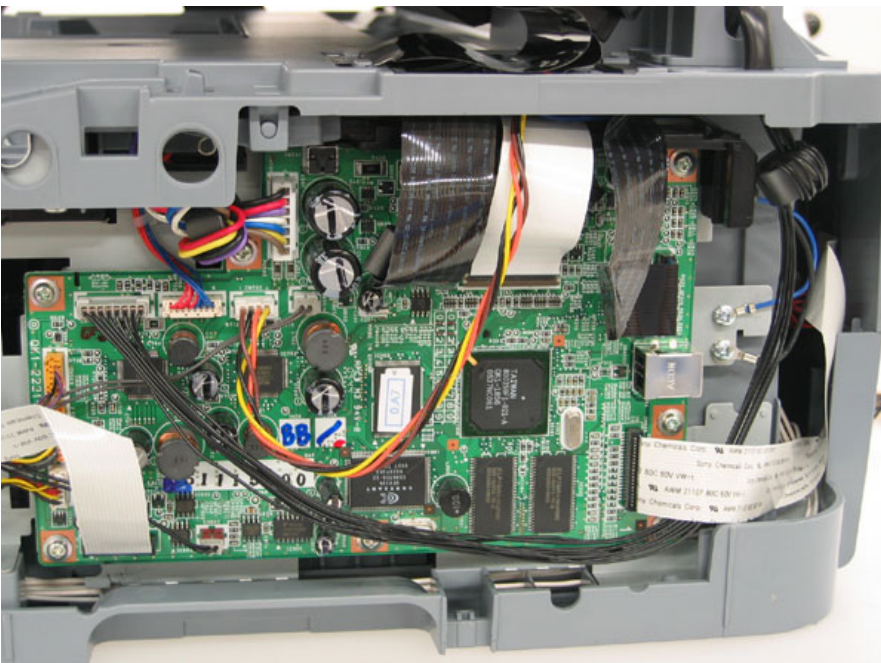

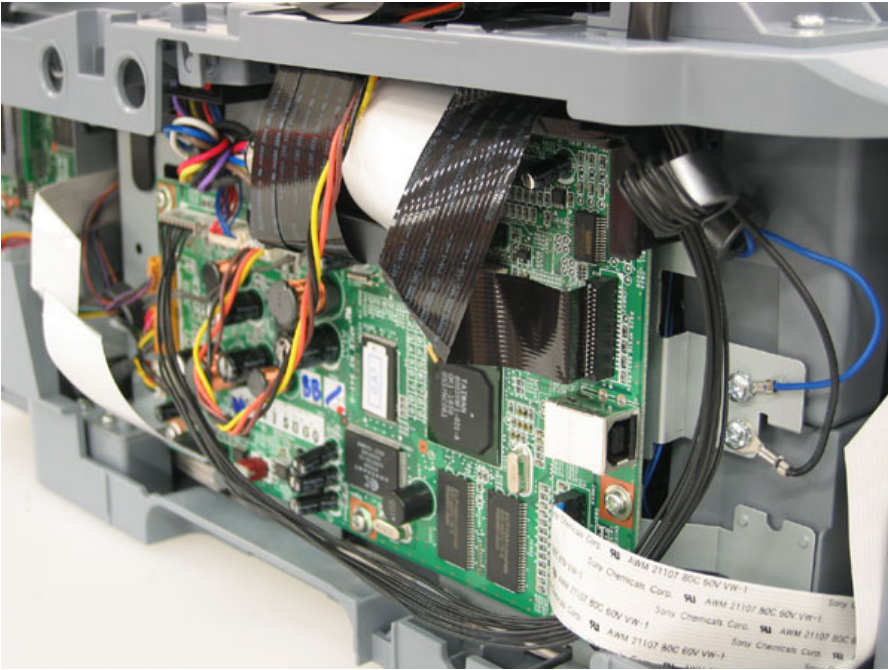

(19) Scanner stop arm removal

- Shift the both left and right stopper outward, then lift the Scanner Stop Arm.

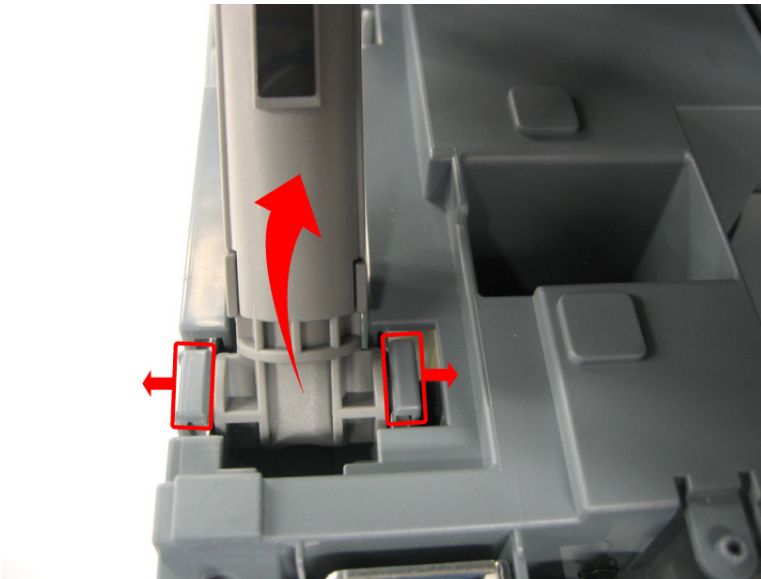

(20) Scanner stopper removal

- While holding the stopper perpendicular to the scanner unit, slide the stopper in the direction indicated by the arrow and remove it from the scanner unit.

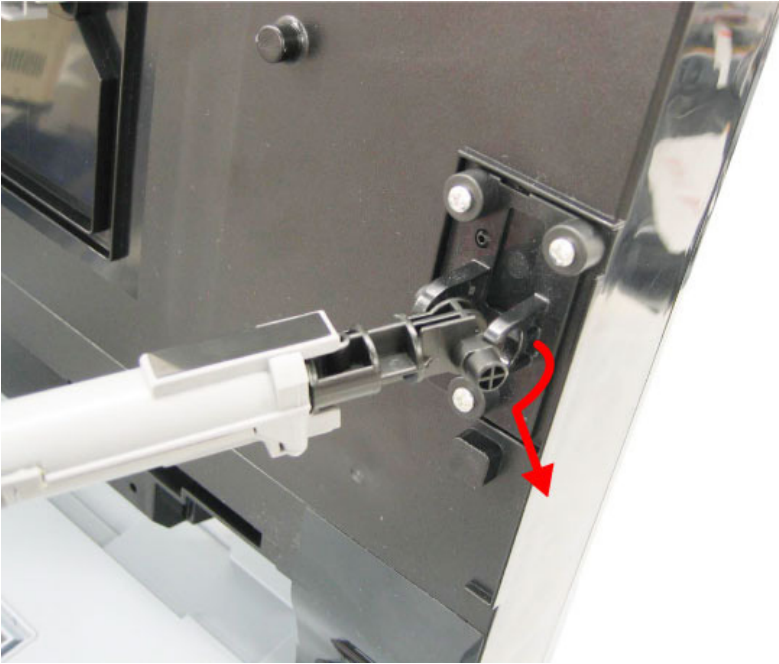

(21) Cable holder sheet position

- The cable holder sheet is attached to the prescribed location with double-sided adhesive tape.



(22) Scanner unit removal

- On the logic board, remove the flat cable from CN602, and remove the core.
- On the logic board, remove the flat cables from CN801 and CN802, then remove 2 screws.
- On the logic board, remove the harness from CN702.
- Remove the ground wire and core.



- Hold the scanner unit upright and lift the left stopper in the direction indicated by the arrow 1 in the photo.

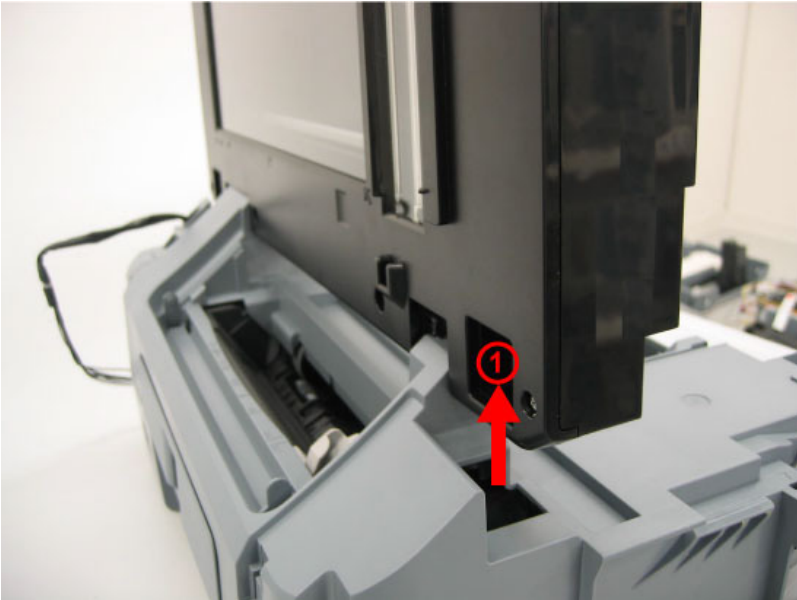

- Slide the left of the scanner unit in the direction indicated by the arrow 2 in the photo, then slide the scanner unit in the direction of the arrow 3 and remove it.

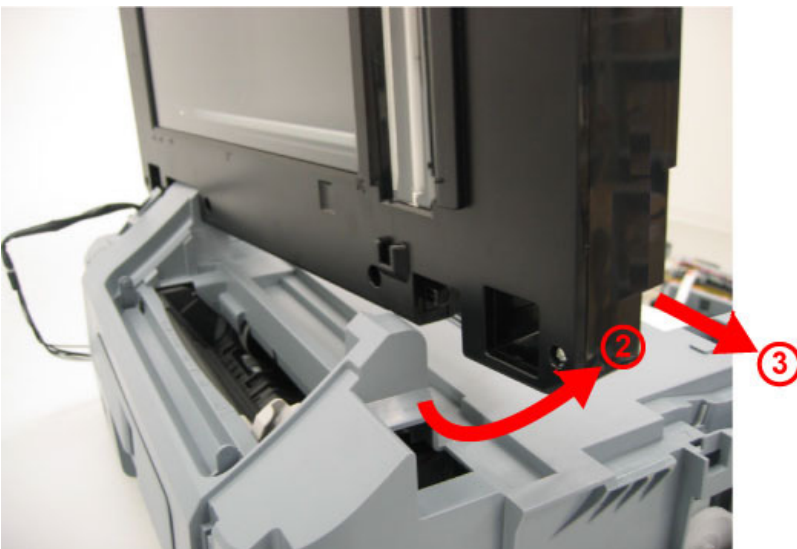

(23) Main case unit removal

- Remove the 4 screws.
- Disconnect the solenoid connector, and lift the main case unit.

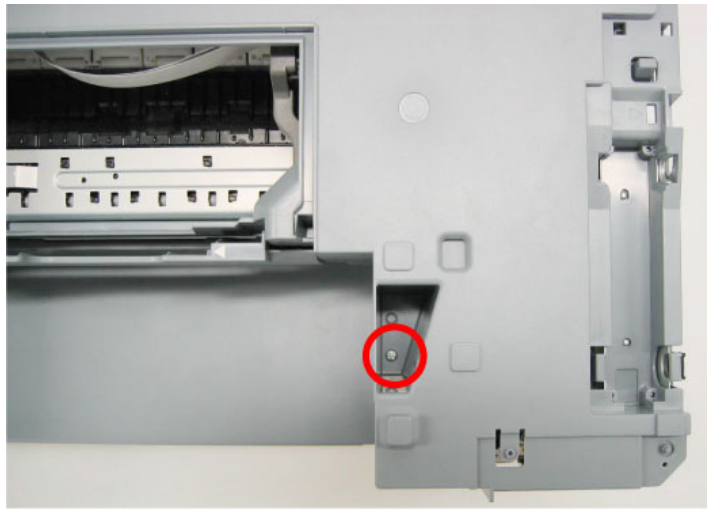
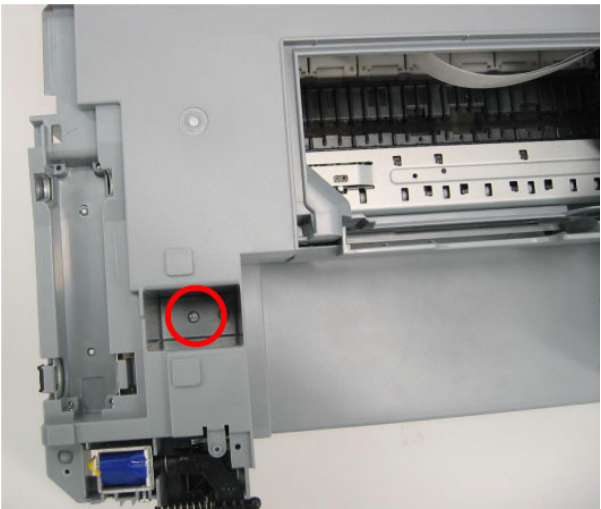

(24) Base case and printer unit wiring

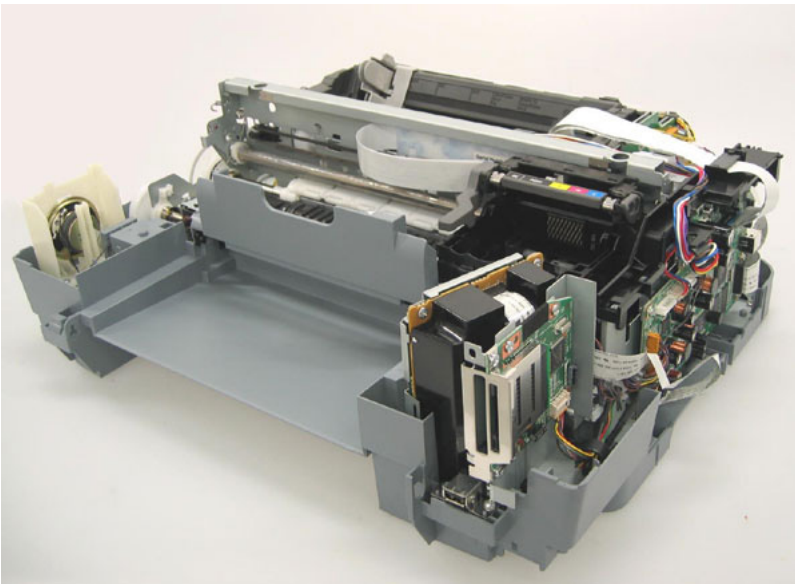

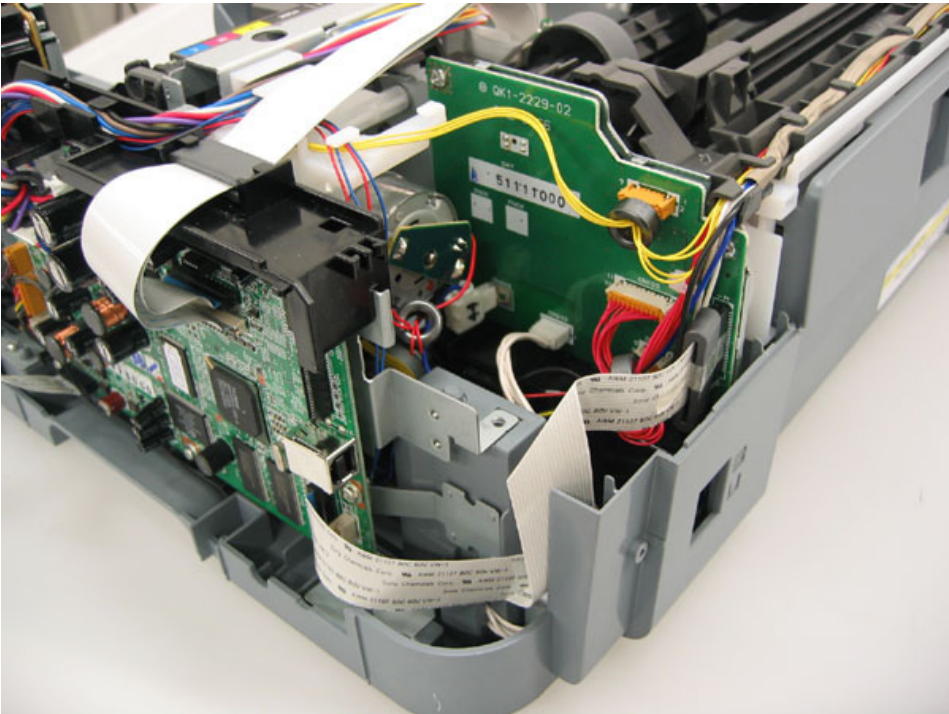
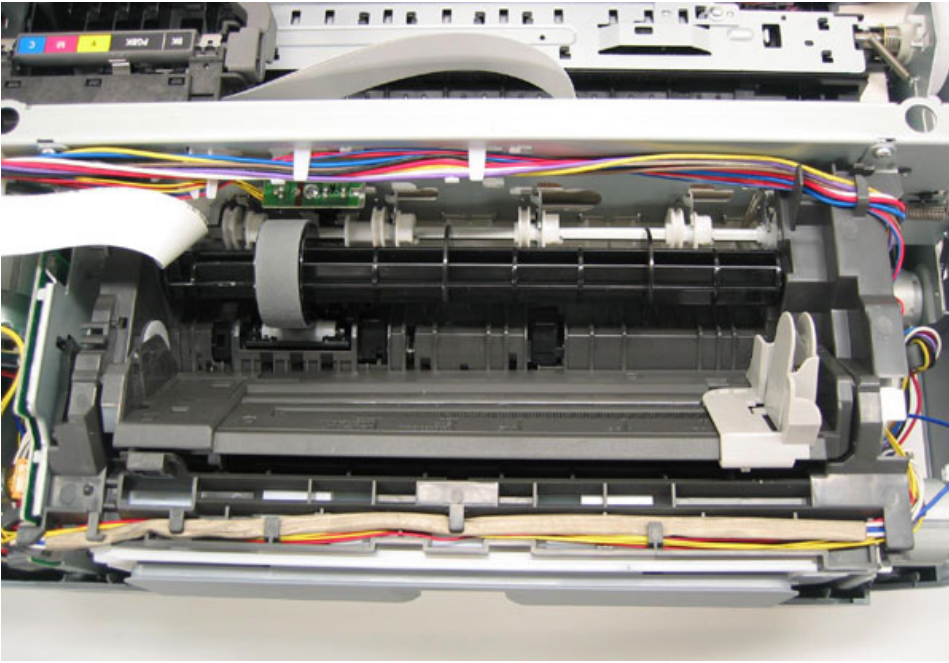

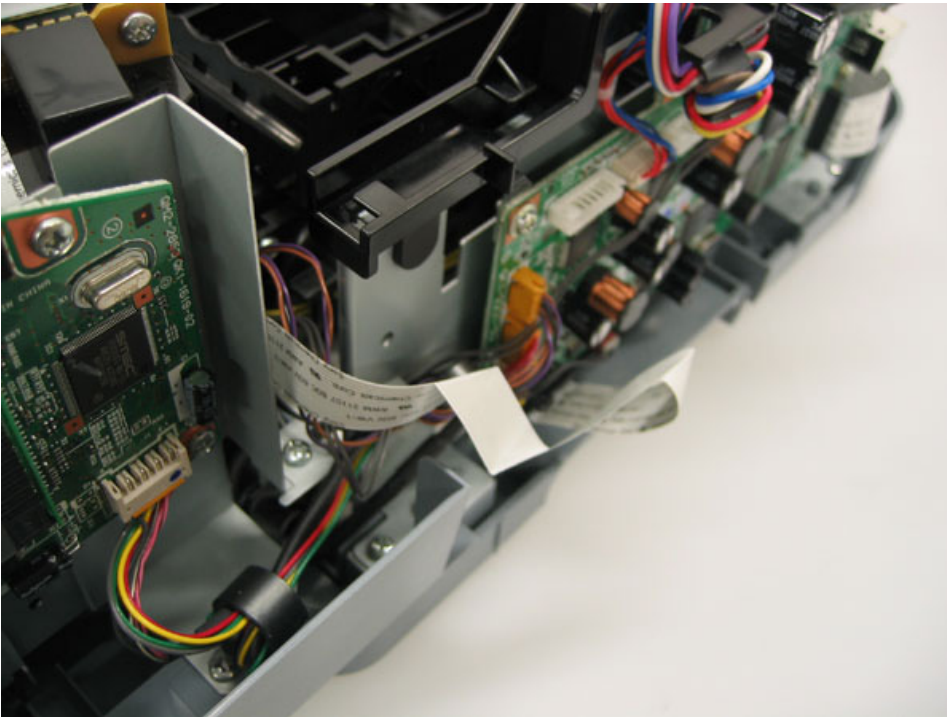
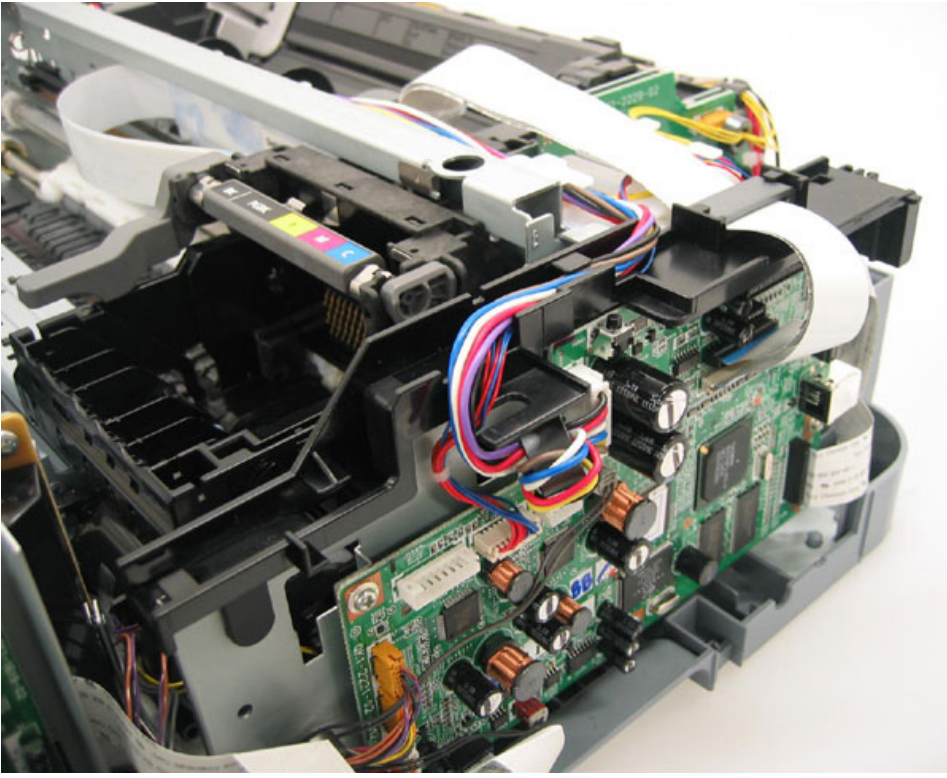

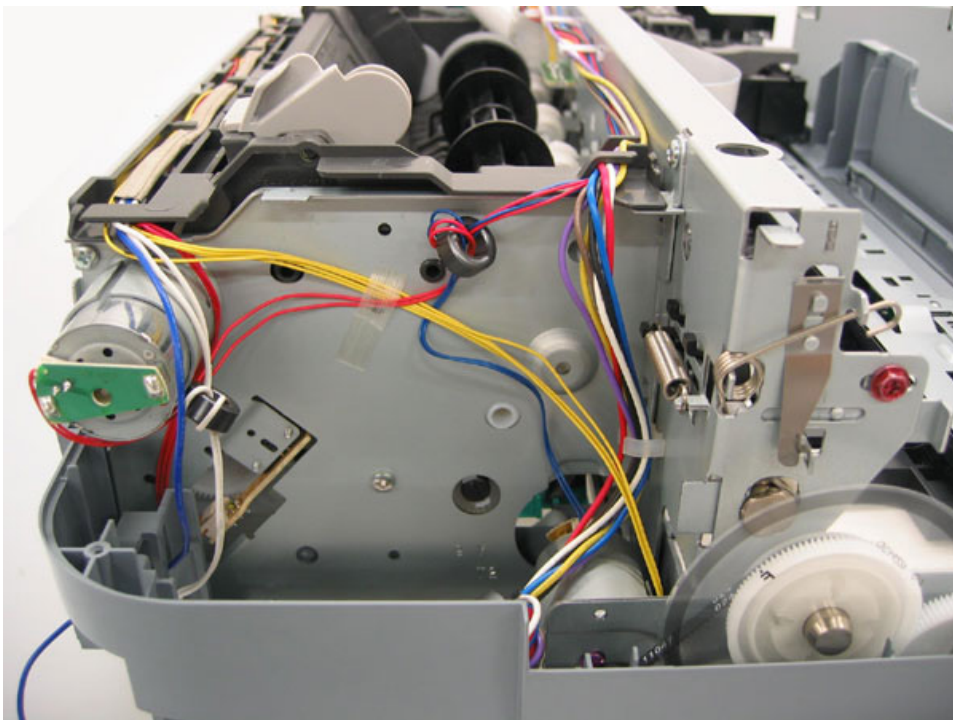
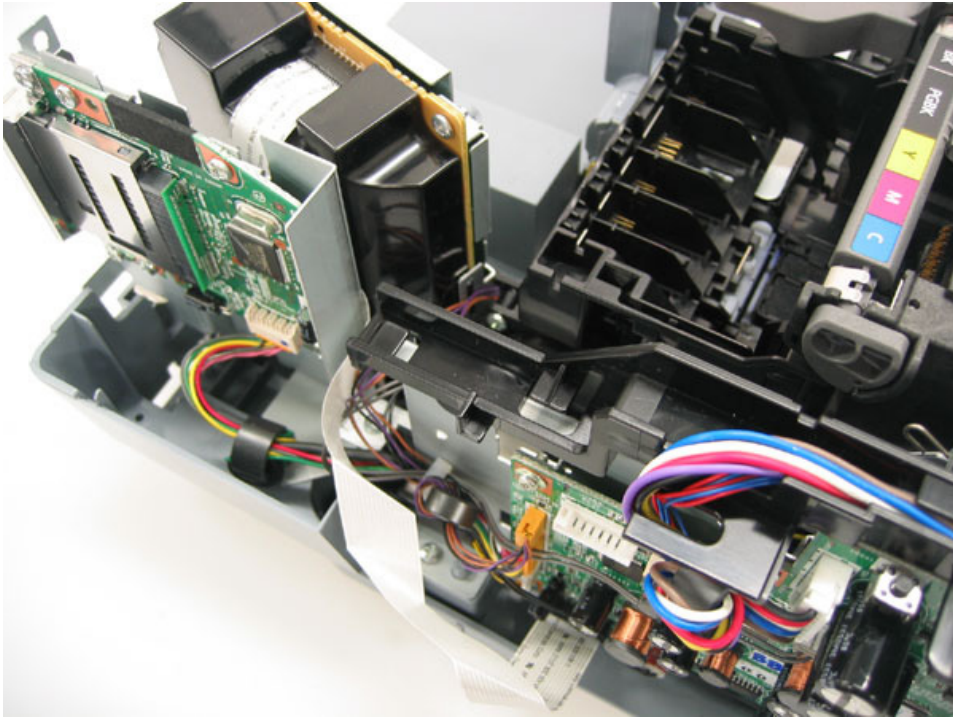

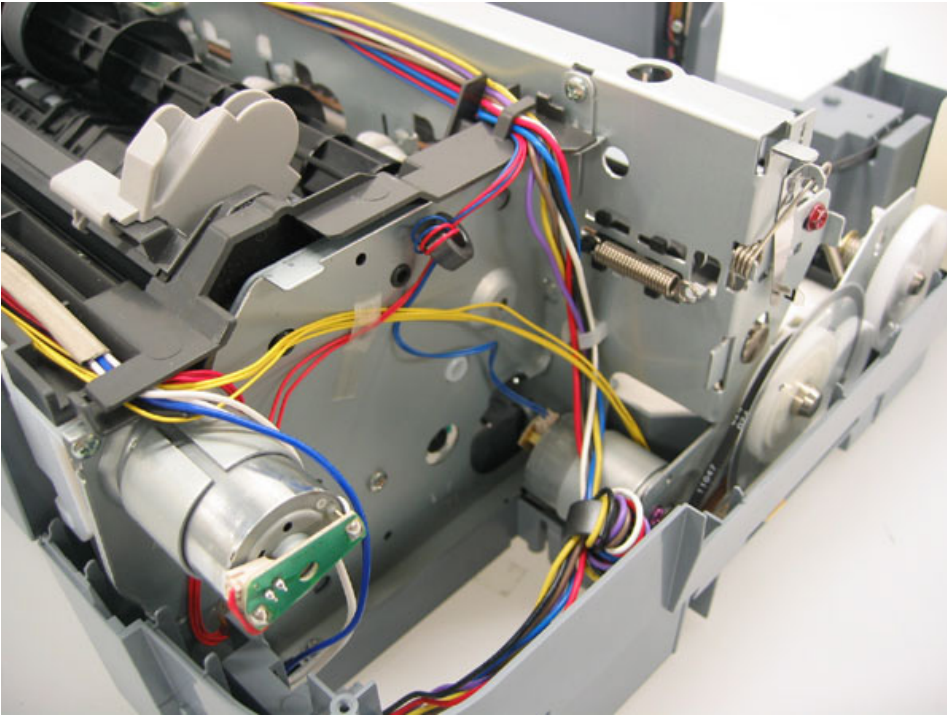

(25) Logic board ass'y removal

- Remove all the flat cables and harnesses from the logic board.
- Remove the 7 screws.

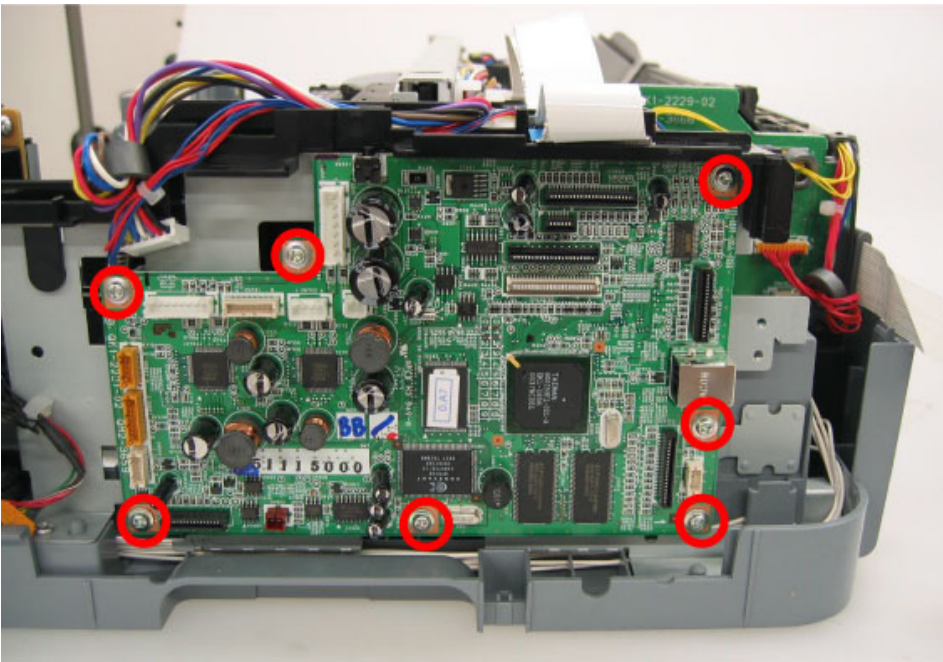

(26) Printer unit removal

- Remove the 4 screws, and lift the printer unit to remove it.

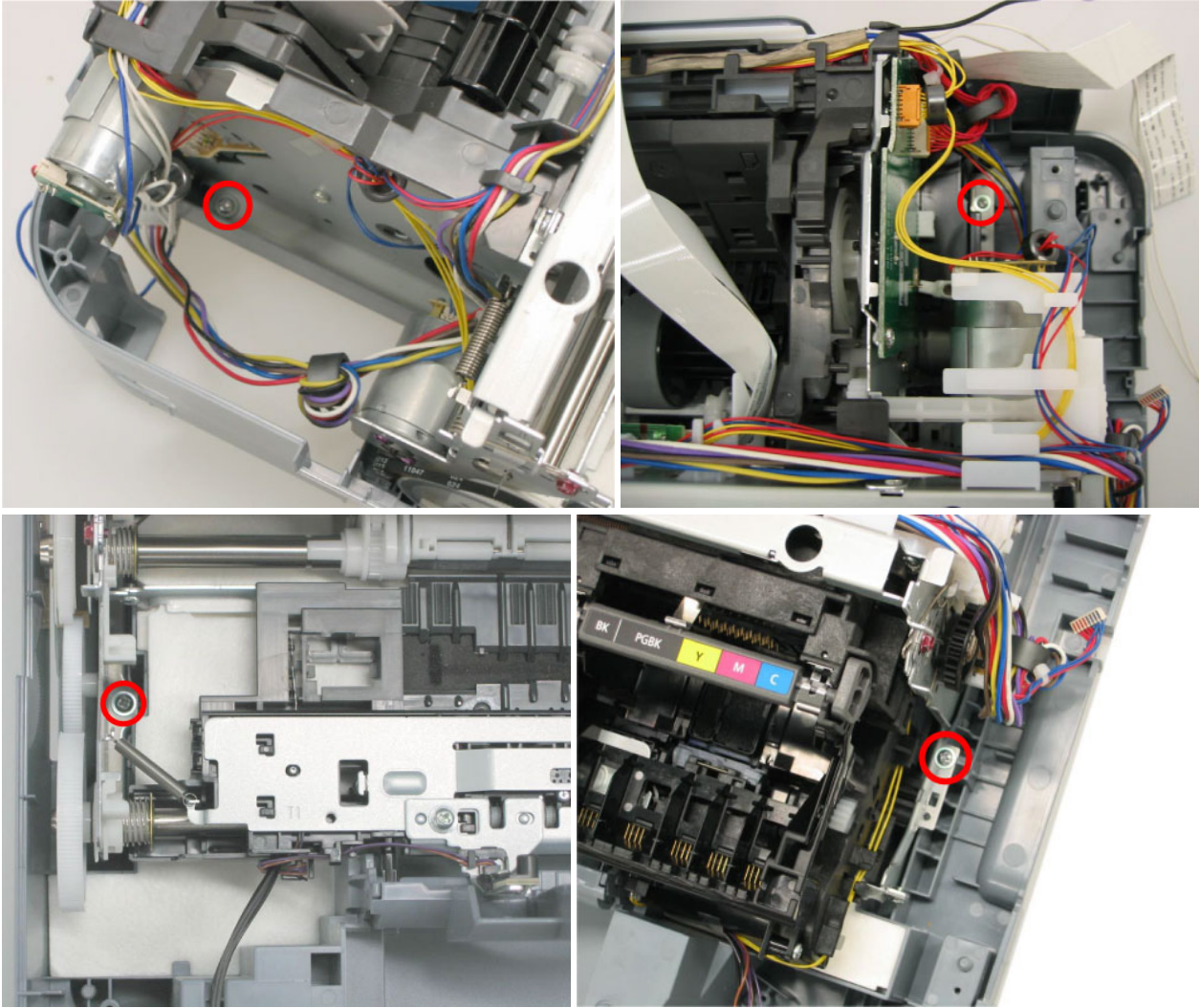

[To the table of contents](#)

[To the top](#)

[←](#) <Part 1: 3. REPAIR; 3-2. Special Notes on Repair Servicing> [→](#)

3-3. Adjustment / Settings

(1) Paper feed motor adjustment

Perform the following adjustments when the paper feed motor unit is replaced:

- 1) When attaching the motor, fasten the screws so that the belt is properly stretched (in the direction indicated by the blue arrow in the figure below).
- 2) After replacement, be sure to perform the service test print, and confirm that no strange noise or faulty print operation (due to dislocation of the belt or gear, or out-of-phase motor, etc.) occurs

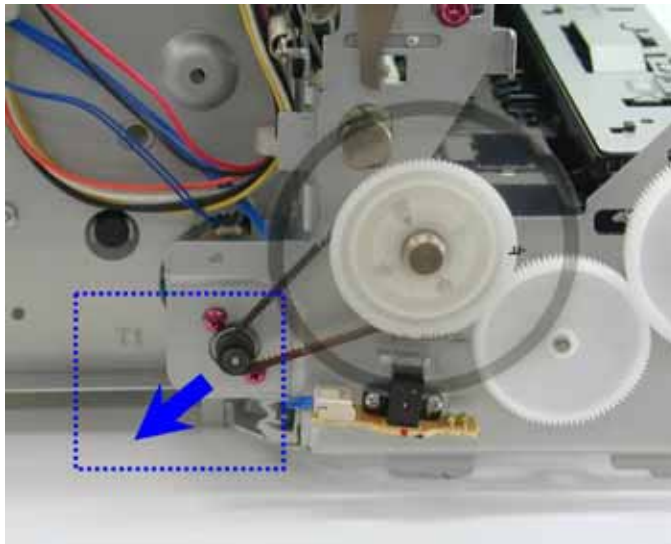

Note: The red screws securing the paper feed motor may be loosened only at replacement of the paper feed motor unit. DO NOT loosen them in other cases.

(2) Grease application

1) Machine unit

No	Part name		Where to apply grease/ oil	Grease/ oil name	Grease/ oil amount	Number of rps*	Number of locations to apply grease/ oil
1	Chassis ass'y	①	Entire surface the carriage slider contacts	Floil KG107A	27 to 54 mg	3	1
2	Chassis ass'y	②	PR lift shaft cam contact portion (at 3 locations)	Floil KG107A	9 to 18 mg	1	3
3	Adjust plate L	③	Carriage shaft cam L sliding portion	Floil KG107A	18to 36 mg	2	1
4	Chassis ass'y	④	Carriage shaft sliding portion on the left side of the chassis (at 2 locations)	Floil KG107A	9 to 18 mg	1	2
5	Chassis ass'y	⑤	Carriage shaft sliding portion on the right side of the chassis (at 2 locations)	Floil KG107A	9 to 18 mg	1	2
6	Carriage shaft	⑥	Entire surface of the carriage shaft where the carriage unit slides	Floil KG107A	200 to 400 mg		1
7	Carriage shaft spring L	⑦	Carriage shaft sliding portion (to the end of spring)	Floil KG107A	9 to 18 mg	1	1
8	Adjust plate R	⑧	Carriage shaft cam R sliding portion	Floil KG107A	18 to 36 mg	2	1
9	Carriage shaft	⑨	Carriage shaft surface where the carriage sliders (and where machine-application of the grease	Floil KG107A	9 to 18 mg	1	1

is not feasible)

*1 drop = 9 to 18 mg

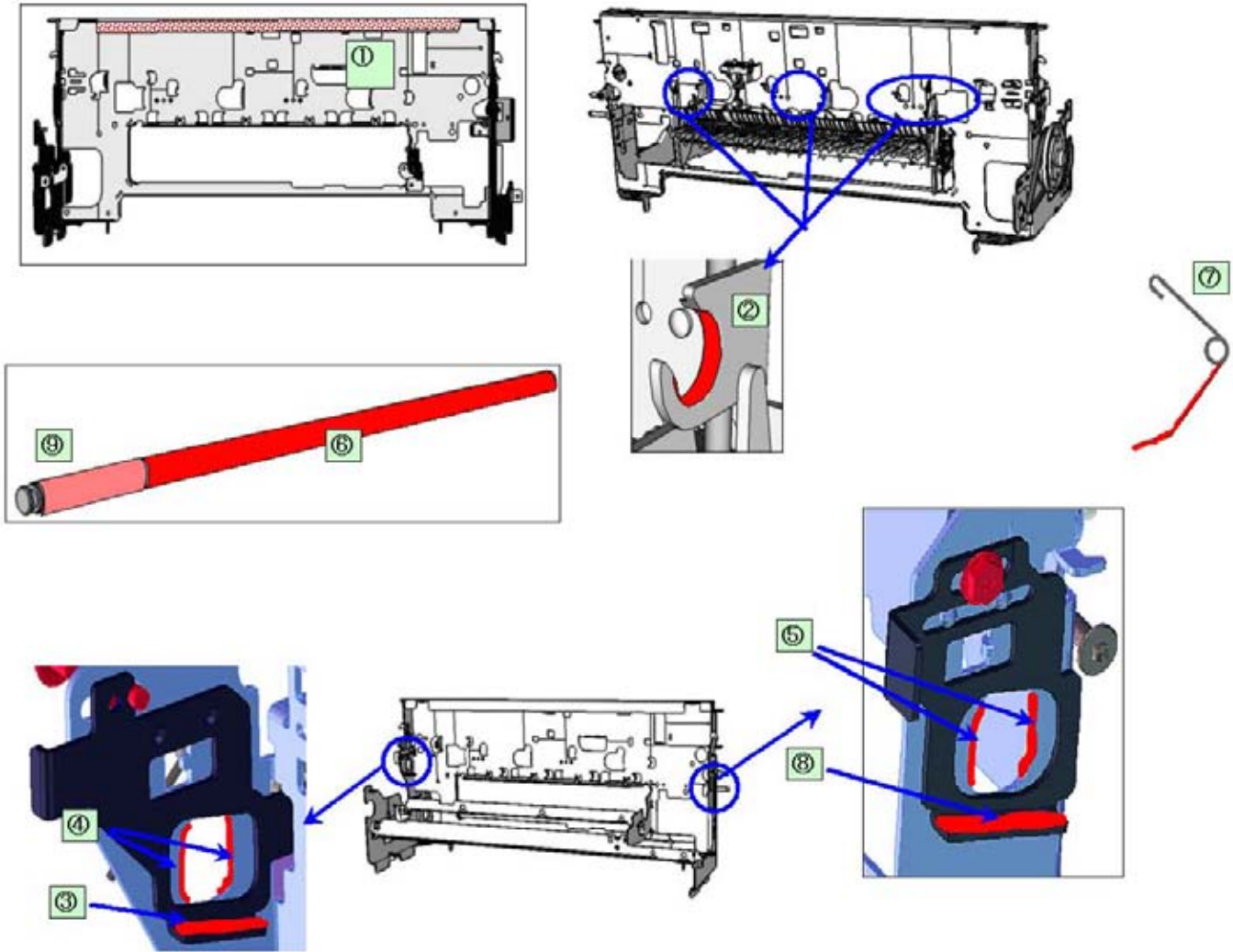

2) CL base / CL gear

No	Part name	Where to apply grease/ oil	Grease/ oil name	Grease/ oil amount	Number of drops*	Number of locations to apply grease/ oil
10	CL input gear	10 Joint of the CL gear base	Floil KG107A	9 to 18 mg	1	1
11	CL gear base	11 Outer surface of the CL idler gear cylinder	Floil KG107A	9 to 18 mg	1	1

*1 drop = 9 to 18 mg

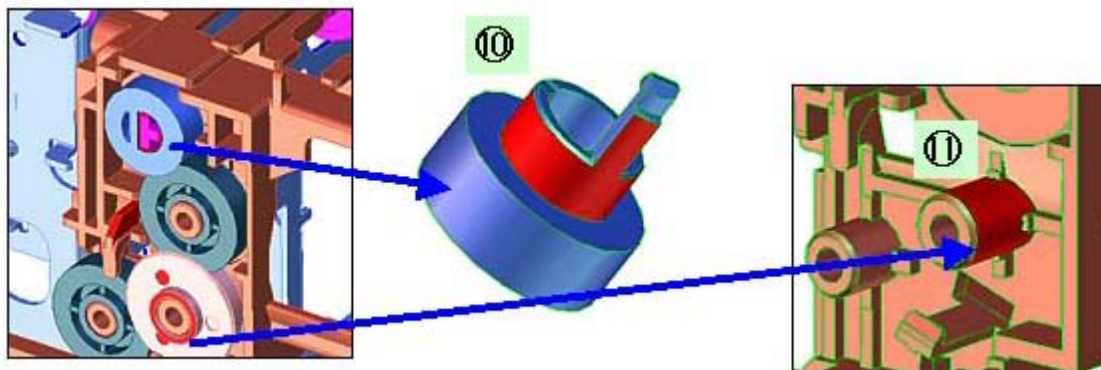

3) PR shaft / LF roller bushing

No	Part name	Where to apply grease/ oil	Grease/ oil name	Grease/ oil amount	Number of drops*	Number of locations to apply grease/ oil
12	LF roller ass'y	⑫ LF roller bushing l spriong contact	Floil KG107A	4.5 to 9 mg	1/2	1
13	PR shaft ass'y	⑬ PR spring sliding portion (at 4 locations)	Floil KG107A	9 to 18 mg	1	4
14	PR shaft ass'y	⑭ PR holder contact (at 4 locations)	Floil KG107A	13.5 to 27 mg	1.5	4

*1 drop = 9 to 18 mg

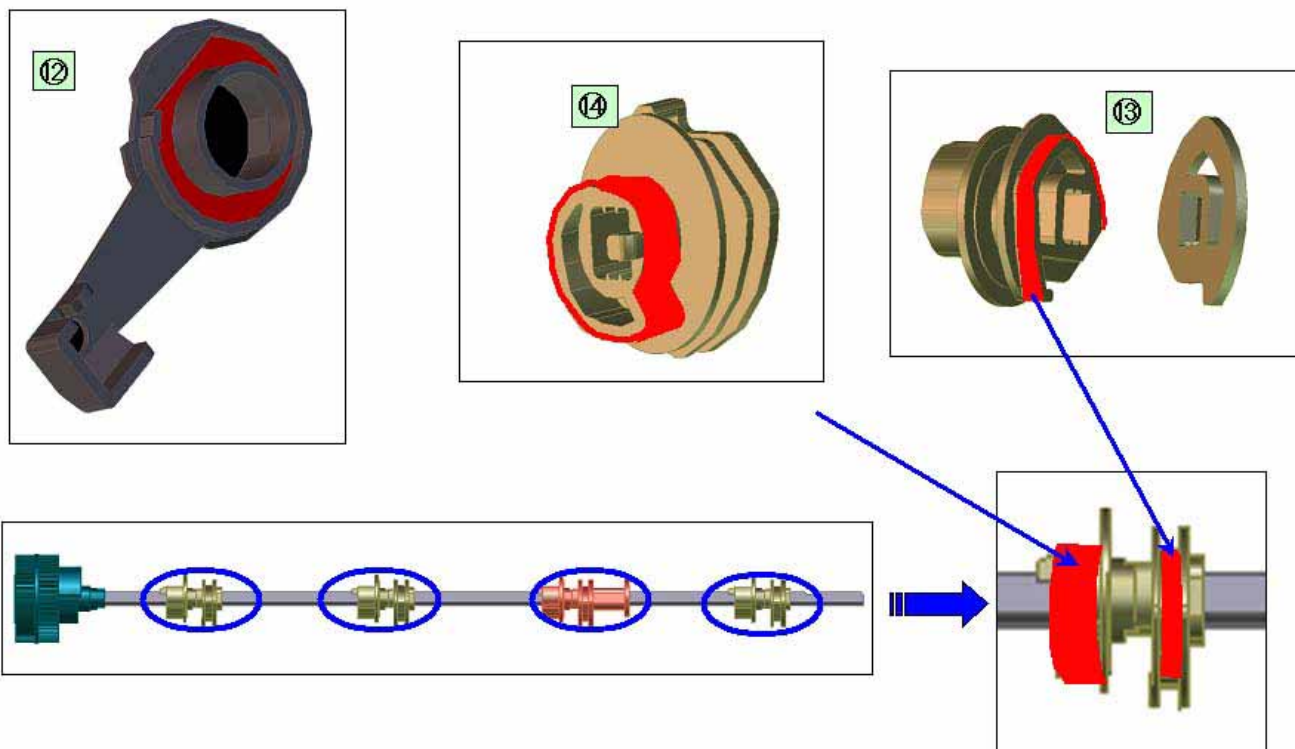

4) Open button

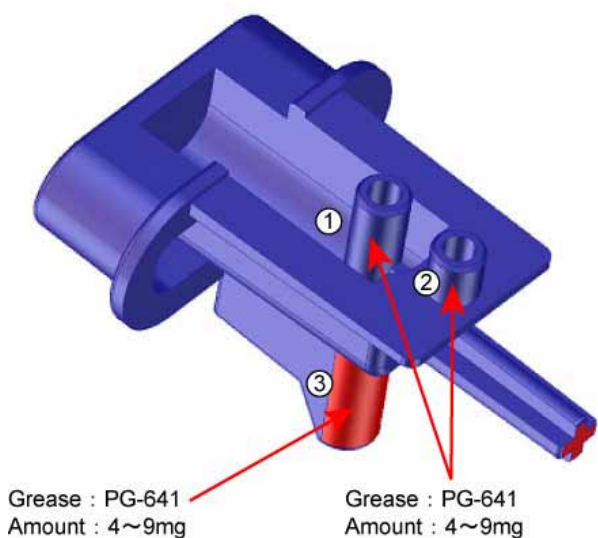

[To the table of contents](#)

[To the top](#)

← <Part 1: 3. REPAIR, 3-3 (1) to (2)> →

(3) Waste ink counter setting

Before replacement of the logic board ass'y, check the waste ink amount. After the logic board ass'y is replaced, set the waste ink amount to the replaced logic board ass'y.

In addition, according to the waste ink amount, replace the waste ink absorber (ink absorber kit). When the waste ink absorber is replaced, reset the waste ink counter (to "0%").

How to check the waste ink amount:

See 3-4. Verification Items, (1) Service test print, or (2) EEPROM information print.

How to set the waste ink amount:

See 3-3. Adjustment / Settings, (6) Service mode, "Waste ink amount setting procedures."

(4) White sponge sheet attachment

Position one of the corners of the white sponge sheet at the scanning reference point on the platen glass (back left where the blue lines cross in the photo below). Peel off the cover sheet from the double-sided adhesive tape, and slowly close the document cover with the sponge frame on. The sponge sheet will attach to the sponge frame.

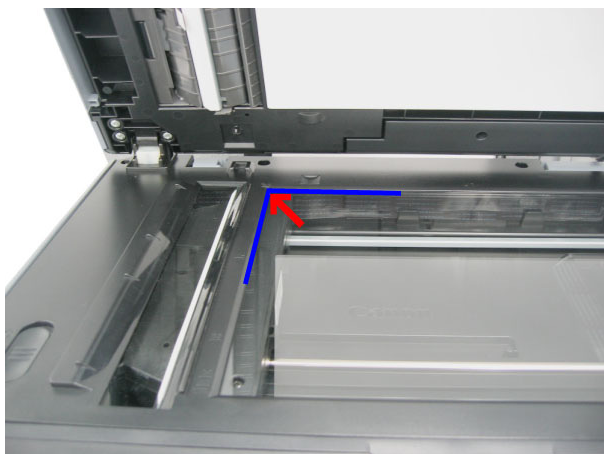

Open the document cover to confirm the following:

- No extension of the sponge edges over the mold part of the document cover.
- No gap between the platen glass reference edges and the corresponding sponge edges.

(5) User mode

Function	Procedures	Remarks
Print head manual cleaning	See "Standalone machine operation" below, or perform from the MP driver Maintenance tab.	
Print head deep cleaning	See "Standalone machine operation" below, or perform from the MP driver Maintenance tab.	
Paper feed roller cleaning	See "Standalone machine operation" below.	
Nozzle check pattern printing	See "Standalone machine operation" below, or perform from the MP driver Maintenance tab.	
Print head alignment (automatic / manual)	See "Standalone machine operation" below, or perform from the MP driver Maintenance tab.	In Custom Settings of the MP driver Maintenance tab, manual print head alignment (by selecting the optimum values) as with the conventional models can be performed.
Bottom plate cleaning	See "Standalone machine operation" below, or perform from the MP driver Maintenance tab.	Cleaning of the platen ribs when the back side of paper gets smeared.
Print head replacement	The print head is replaceable at the same position as for ink tank replacement. (Open the scanning unit. When the carriage stops at the center, the print head can be replaced.)	

<Standalone machine operation>

Turn on the machine. On the operation panel, select **Maintenance/settings**, **Maintenance** or **Device settings**, then a desired function.

Menu	Remarks
Nozzle check (nozzle check pattern print)	Set a sheet of A4 or letter size plain paper in the ASF or cassette (according to the Feed Switch button setting).
Cleaning	
Deep cleaning	
Auto head align (automatic print head alignment)	Set a sheet of A4 or letter size plain paper in the ASF.
Manual head align (manual print head alignment)	Set 2 sheets of A4 or letter size plain paper in the ASF or cassette (according to the Feed Switch button setting).
Roller cleaning	Set 3 or more sheets of A4 or letter size plain paper in the ASF or cassette to be cleaned.
Bottom plate cleaning	Fold a sheet of A4 or letter size plain paper in half, then open it. Set the paper in the ASF with the opened surface facing up.
Prevent paper abrasion (head-to-paper distance setting)	
Adjust contrast	

(6) Service mode

Function	Procedures	Remarks
Service test print - Model name - Destination - ROM version - USB serial number - Waste ink amount - CD / DVD sensor correction value - Ink system function check result - CD / DVD sensor correction result	See "Service mode operation procedures" below.	Set a sheet of A4 or letter size paper. For print sample, see 3-4. Verification Items, (1) Service test print , <Service test print sample>.
EEPROM information print - Model name - Destination - ROM version - Waste ink amount - Print information - Error information	See "Service mode operation procedures" below.	Set a sheet of A4 or letter size paper.
EEPROM initialization	See "Service mode operation procedures" below.	The following items are NOT initialized, and the shipment arrival flag is not on: - USB serial number - Destination settings - Waste ink counter - CD / DVD correction value
Waste ink counter reset	See "Service mode operation procedures" below.	If the waste ink amount is 7% or more, replace the ink absorber kit.

Destination settings	See "Service mode operation procedures" below.	Initialize EEPROM after the destination settings.
LF correction	See "Service mode operation procedures" below.	
Button and LCD test	See "Service mode operation procedures" below.	
Waste ink amount setting	See "Service mode operation procedures" below.	

Note: At the end of the service mode, press the ON/OFF button. The paper lifting plate of the sheet feed unit will be raised.

<Service mode operation procedures>

- 1) With the machine power turned off, while pressing the Stop/Reset button, press and hold the ON/OFF button. (DO NOT release the buttons). The COPY button lights in green to indicate that a function is selectable.
- 2) While holding the ON/OFF button, release the Stop/Reset button. (DO NOT release the ON/OFF button.)
- 3) While holding the ON/OFF button, press the Stop/Reset button 2 times, and then release both the ON/OFF and Stop/Reset buttons. (Each time the Stop/Reset button is pressed, the Alarm LED and COPY button light alternately, Alarm in orange and COPY in green, starting with Alarm LED.)
- 4) When the COPY button lights in green, press the Stop/Reset button the specified number of time(s) according to the function listed in the table below. (Each time the Stop/Reset button is pressed, the Alarm LED and COPY button light alternately, Alarm in orange and COPY in green, starting with Alarm LED.)

Time(s)	LED indication	Function	Remarks
0 times	Green (COPY)	Power off	When the print head is not installed, the carriage returns and locks in the home position capped.
1 time	Orange (Alarm)	Service test print	See 3-4. Verification Items, (1) Service test print.
2 times	Green (COPY)	EEPROM information print	See 3-4. Verification Items, (2) EEPROM information print.
3 times	Orange (Alarm)	EEPROM initialization	
4 times	Green (COPY)	Waste ink counter resetting	
5 times	Orange (Alarm)	Destination settings	See "Destination settings procedures" below.
6 times	Green (COPY)	Print head deep cleaning	Cleaning of both black and color
7 times	Orange (Alarm)	LF correction	See "LF correction procedures" below.
8 times	Green (COPY)	CD / DVD check pattern print	Not used in servicing
9 times	Orange (Alarm)	CD / DVD print position correction (horizontal: X direction)	Not used in servicing.
10 times	Green (COPY)	CD / DVD print position correction (vertical: Y direction)	Not used in servicing.
11 times	Orange (Alarm)	Button and LCD test	See "Button and LCD test procedures" below.
12 times	Green (COPY)	Return to the menu selection	
13 times	Orange (Alarm)	Return to the menu selection	
14 times	Green (COPY)	Left margin correction	Not used in servicing.
15 times	Orange (Alarm)	Waste ink amount setting	See "Waste ink amount setting procedures" below.
16 times or more	Green at even numbers (COPY) Orange at odd numbers (Alarm)	Return to the menu selection	

Note: - If the Stop/Reset button is pressed 16 or more times, the Alarm LED (orange) or COPY button (green) lights steadily without any changes.

- At the end of the service mode, press the ON/OFF button. The paper lifting plate of the sheet feeder unit will be raised.

<Destination settings procedures>

In the destination settings mode, press the Stop/Reset button the specified number of time(s) according to the destination listed in the table below, and press the ON/OFF button.

Time(s)	LED indication	Destination	CD / DVD print
0 times	Green (COPY)	No change of the destination	
1 time	Orange (Alarm)	Japan	Supported
2 times	Green (COPY)	Korea	Not supported
3 times	Orange (Alarm)	US	Not supported
4 times	Green (COPY)	Europe	Supported
5 times	Orange (Alarm)	Australia	Supported
6 times	Green (COPY)	Asia	Supported
7 times	Orange (Alarm)	China	Supported
8 times	Green (COPY)	Taiwan	Supported
9 times or more	Orange (Alarm)	Return to the menu selection	

Note: After setting the destination without logic board replacement, be sure to initialize the EEPROM. Without EEPROM initialization, the destination settings may not be valid.

Confirm the model name and destination in service test print or EEPROM information print.

[See 3-4. Verification Items, (1) Service test print, or (2) EEPROM information print.]

<LF correction procedures>

After replacement of the feed roller ass'y or logic board ass'y in repair servicing or in refurbishment operation, adjust the line feeding.

- 1) In the LF correction mode, press the Stop/Reset button the specified number of times according to the paper to be used in LF correction listed in the table below, then press the ON/OFF button.

Time(s)	Paper type	Paper name
1 time	High Resolution Paper	Canon HR-101
2 times	Plain paper	Canon PB PAPER GF-500 (64 g/m ²), Canon Office Planner
3 times		HP BrightWhite (90 g/m ²), Canon Office (80 g/m ²)
4 times		Canon Extra, STEINBEIS Vision Classic White

Note:

- The High Resolution Paper is the most desirable for LF correction printing (Canon HR-101 is used at the production site), but 6 kinds of plain paper listed in the table above can also be used in LF correction. If plain paper other than the above is used, select any one of the paper types in this step, then select Pattern No. 0 (zero) in the step 3) below.
- Each time the Stop/Reset button is pressed, the Alarm LED and the COPY button light alternately, Alarm in orange and COPY in green.
- If the Stop/Reset button is NOT pressed, and only the ON/OFF button is pressed, the machine remains in the LF correction mode.
- If the Stop/Reset button is pressed 5 times or more, then the ON/OFF button is pressed, the machine returns to the service mode menu selection.

2) The LF correction pattern for the selected paper is printed.

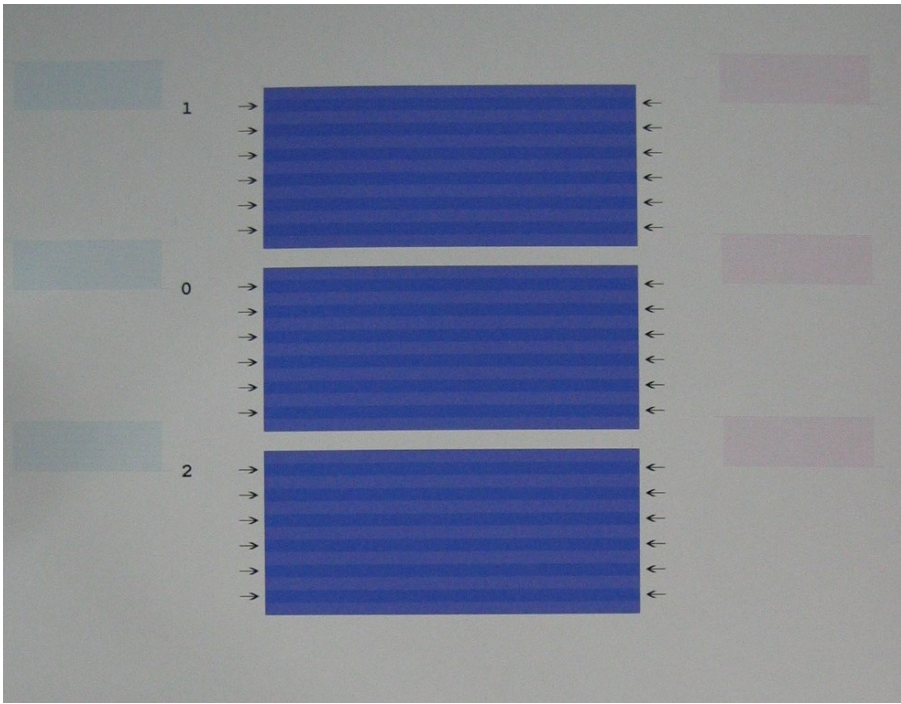

3) In the printout, select the Pattern No. in which streaks or lines (white or black) are the least noticeable, press the Stop/Reset button the same number of time(s) as the selected Pattern No., then press the ON/OFF button.

Note:

- If plain paper other than the 6 kinds specified in the table in step 1) is used, select the Pattern No. 0 (zero), leave the Stop/Reset button untouched, and press the ON/OFF button.
- Each time the Stop/Reset button is pressed, the Alarm LED and the COPY button light alternately, Alarm in orange and COPY in green.
- If the Stop/Reset button is pressed 3 times or more, then the ON/OFF button is pressed, the machine returns to the service mode menu selection.

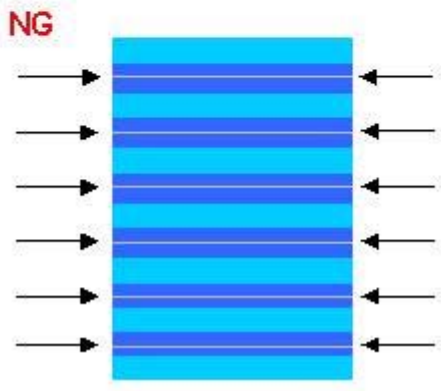
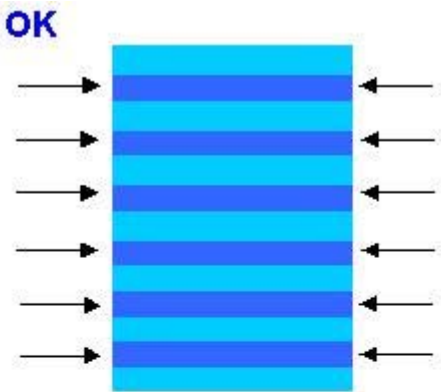

4) The LF correction value is written to the EEPROM, and the machine returns to the service mode menu selection.

Note: The LF correction value (0, 1, or 2) can be confirmed in EEPROM information print.

<Waste ink amount setting procedures>

Set the waste ink amount data to a replaced new EEPROM after the logic board is replaced in servicing.

- 1) Before replacement of the logic board ass'y, check the waste ink amount in EEPROM information print. [See 3-4. Verification Items, (2) EEPROM information print.]
- 2) In the waste ink amount setting mode, press the Stop/Reset button the specified number of time(s) according to the waste ink absorber whose value should be transferred to the replaced new EEPROM. (Only the main waste ink absorber for the MP830)

Time(s)	Waste ink absorber	Remarks
0 times	Main waste ink absorber	
1 time	Platen waste ink absorber	Not valid for the MP830
2 times	Both the main and platen waste ink absorbers	Only the main waste ink absorber is valid for the MP830
3 times or more	Not valid	Press the ON/OFF button to return to the waste ink amount setting mode.

3) Press the ON/OFF button to proceed to the next step.

4) The waste ink amount can be set in 10% increments by pressing the Stop/Reset button. Press the Stop/Reset button the appropriate number of time(s) to select the value which is closest to the actual waste ink amount.

Time(s)	Waste ink amount value to be set (%)
0 times	0%
1 time	10%
2 times	20%
3 times	30%
4 times	40%
5 times	50%
6 times	60%
7 times	70%
8 times	80%
9 times	90%
10 times or more	Not valid. Press the ON/OFF button to return to the waste ink amount setting mode.

- 5) Press the ON/OFF button to set the selected value to the EEPROM. Print EEPROM information to confirm that the value is properly set to the EEPROM.

<Button and LCD test procedures>

Confirm the operation after replacement of the operation panel unit or LCD unit.

- 1) In the button and LCD test mode, press the Stop/Reset button. The LCD turns blue, waiting for a button to be pressed.



- 2) Press each button on the left half of the operation panel (total 19 buttons).

The LCD is divided into segments, representing each button. The color of a segment corresponding to the pressed button changes to red. Each time a button is pressed, the COPY button and Alarm LED lights alternately, COPY in green and Alarm in orange. When all the 19 buttons are pressed, the entire LCD changes to a full light blue screen.



- 3) Press each button on the right half of the operation panel (total 27 buttons).

The LCD is divided into segments, representing each button. The color of a segment corresponding to the pressed button changes to red. Each time a button is pressed, the COPY button and Alarm LED lights alternately, COPY in green and Alarm in orange. When all the 27 buttons are pressed, the entire LCD changes to a full red screen, and no further pressing of the button is accepted.



- 4) Open the scanning unit (printer cover) to display the color pattern. Only the ON/OFF button is enabled.
If there is any button left un-pressed (a blue segment remained in step 3) above), even the Stop/Reset button is not accepted.



- 5) Press the ON/OFF button to return to the service mode menu selection.

[To the table of contents](#)

[To the top](#)

[←](#) <Part 1: 3. REPAIR; 3-3. Adjustment / Settings (3) to (6)> [→](#)

3-4. Verification Items

(1) Service test print

<EEPROM information contents>

On the service test print (sample below), confirm the EEPROM information as shown below. (The information is given in the upper portion of the printout.)

MP830: Model name

JPN: Destination

M = x.xx: ROM version

C = x.xx: Not used in servicing

USB (xxxxxx): USB serial number

FA = xx xx xx: Reserved for plant use

D = xxx.x: Waste ink amount (%)

CDR (+xxxxx, +yyyyy): CD / DVD sensor position correction value

LF = x: LF correction value (0 to 2)

AB (K = OK Y = ...): Ink system function check result

<Print check items>

On the service test print (sample below), confirm the following items:

- Check 1, top of form accuracy: The lines shall not extend off the paper.
- Check 2, EEPROM information
- Check 3, nozzle check pattern: Ink shall be ejected from all nozzles.
- Check 4, check pattern for irregular line feeding: There shall be no remarkable streaks or unevenness.
- Check 5, check pattern for uneven printing due to line feeding: There shall be no remarkable streaks.
- Check 6, check pattern for uneven printing due to carriage movement (9600 dpi mode): There shall be no remarkable unevenness.
- Check 7, check pattern for uneven printing due to carriage movement (standard mode): There shall be no remarkable unevenness.
- Check 8, CD / DVD sensor and automatic print head alignment sensor correction: The results shall be OK.

<Service test print sample>

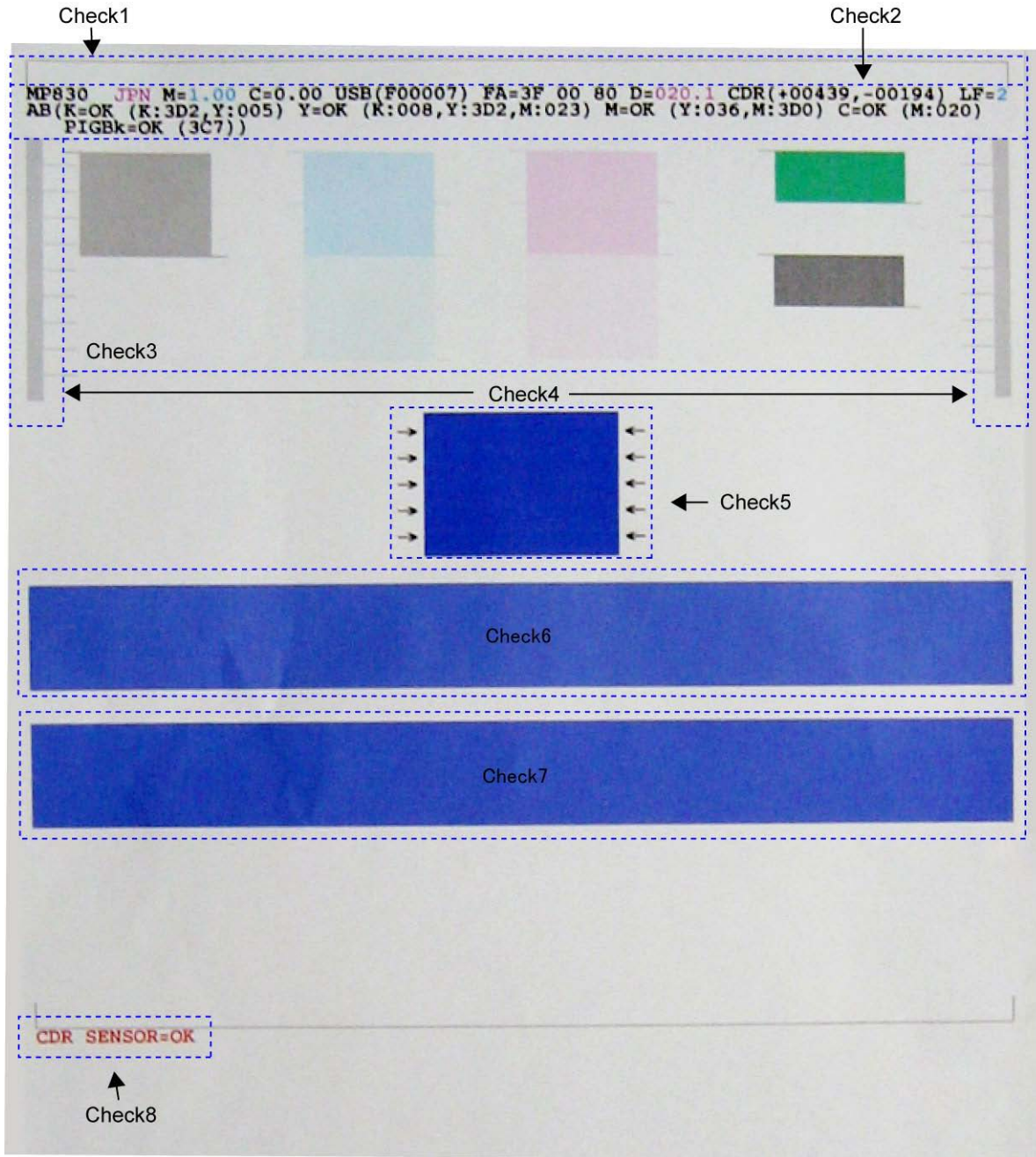

(2) EEPROM information print

<How to read EEPROM information print>

Print sample:

1: MP830 2: JPN 3: V1.00 4: IF(USB2=1) 5: D=020.1 6: ST=2006/01/28-18:30
7: ER(ER0=1300 ER1=5100) 8: LPT=2006/05/01-12:09
9: PC(M=002 R=000 T=001 D=009 C=000)
10: CLT(BK=2006/01/28-18:38 CL=2006/01/28-18:38)
11: CH=00002 12: CT(PBK=012 BK=015 Y=013 M=001 C=001) 13: IS(PBK=2 BK=0 Y=2 M=0 C=0)
14: P_ON(S=00009) 15: A_REG=1 16: M_REG=0
17: UR(A(BKoe)=-01 B(Coe)=-02 C(Moe)=000 D(SCoe)=+01 E(SMoe)=+01 F(PBKoe)=000
G(CLbi)=000 H(SCLbi)=+01 I(C-SC)=-01 J(M-SM)=000 K(BK-CL)=+01
L(BKbiPP)=000 M(CLbiPP)=000 N(SCLbiPP)=000 O(NZctr)=000 P(NZedge)=000

18: WP=0024 19: CDIN(LG=001 PB=000 OPB=000) 20: MSD(002)
 21: TPAGE=00162 (TTL=00162 FAX=00000 COPY=00000)
 22: PAGE(All=00142 PP=00140 HR+MP=00000 PR+SP+SG=00002 GP=00000 PC=00000 EV=00000)
 23: UCPAGE(All=00020 PP=00013 HR+MP=00000 PR+SP+SG=00007 GP=00000 PC=00000 EV=00000)
 24: BPPAGE(All=00000 BSSP=00000 PC=00000)
 25: CDPAGE(All=00000) 26: EDGE=00009 27: L=00008 28: CDR=00000
 29: CDRP=(+00498, -00220) 30: CDRS=(130) 31: LF=1 32: LM=(ASF_R:00 UT_F:00 UT_R:00)
 <Direct>
 33: LG=01 Japanese 34: SC=000 35: Seal=000 36: CDI=007 37: CDP=002
 38: CDD-PR(L=000 2L=000 PC=000 A4=000) 39: CDD-SP(L=000 2L=000 PC=000 A4=000)
 40: CDD-MP(L=000 2L=000 PC=000 A4=000) 41: DCD-PP(L=000 2L=000 PC=000 A4=000)
 42: DCD-FPP(L=000 2L=000 PC=000 A4=000) 43: DCD-MPP(L=000 2L=000 PC=000 A4=000)
 <Scanner>
 44: SC=00005
 45: SC-dpi(75=00000 150=00000 300=00005 600=00000 1200=00000 2400=00000 4800=00000)
 46: SG(GY=00003 CL=00002)
 <Copy>
 47: MCASF(PP=00000 SP+PR+GP=00000 OTH=00000)
 48: MCUT(PP=00000 SP+PR+GP=00000 OTH=00000)
 49: CCASF(PP=00000 HR+MP=00000 PR+SP+SG=00000 GP=00000 PC=00000)
 50: CCUT(PP=00000 HR+MP=00000 PR+SP+SG=00000 GP=00000 PC=00000)
 <FAX>
 51: TX=00002 (Bk=00002 Cl=00000) 52: SIZE(A4=00002)
 53: RX=00001 54: SIZE(A4=00001)
 55: FXSP= 03 00 00 00 00 00 00 00 00 00 00 00 00 00 00 00
 00 00 00 00 00 00 00 00
 56: Head TempBK=38.5 57: Head TempC=34.5 58: Env Temp=33.5 59: FF(80 00 3F)

HDEEPROM

60: V0001 61: SN=0000-969F
 62: LN(00000 00000 00000 00003 00013 00017 00015) 63: ID=09
 64: IL(PBK=000 BK=000 Y=000 M=000 M2=000 C=000 C2=000)
 65: <SCAN ERROR HISTORY>
 5020 0000
 66: <FAX USER ERROR HISTORY>
 0018 0000
 67: <FAX SERVICE ERROR HISTORY>
 1765 0000

Printed items:

1. Model name
2. Destination
3. ROM version
4. Connected I/F (USB2)
5. Waste ink amount (%)
6. Installation date & time
7. Operator call/service call error record
8. Last printing date & time
9. Purging count (manual/deep cleaning/timer/dot count/ink tank and print head replacement)
10. Cleaning date & time (BK/CL)
11. Print head replacement count
12. Ink tank replacement count (PBK/BK/Y/M/C)
13. Ink status (PBK/BK/Y/M/C)
14. Power-on count (soft)
15. Automatic print head alignment by user
16. Manual print head alignment by user
17. User print head alignment values (Bkoe/Coe/Moe/SCoe/SMoe/PBKoe/CLbi/SCLbi/C-SC/M-SM/BK-CL/BKbiPP/CLbiPP/SCLbiPP/NZctr/NZedge)
18. Wiping count
19. Camera Direct Print-supported device connection record (LG = Legacy, PB = Canon PictBridge-supported camera, OPB = Other PictBridge-supported camera)
20. Longest period where printing stops (days)
21. Total print pages (total, fax, copy pages)
22. ASF feed pages (total, plain paper, High Resolution Paper & Matte Photo Paper, Photo Paper Pro & Photo Paper Plus Glossy & Photo Paper Plus Semi-gloss, Glossy Photo Paper, postcard, Envelope)
23. U-turn cassette feed pages (total, plain paper, High Resolution Paper & Matte Photo Paper, Photo Paper Pro & Photo Paper Plus Glossy & Photo Paper Plus Semi-gloss, Glossy Photo Paper, postcard, envelope)
24. Auto duplex print pages (total, Photo Paper Plus Double Sided, postcard)

25. Camera Direct print pages (total) 26. Borderless print pages (total) 27. 4x6 print pages 28. Number of CDs and DVDs printed
29. CD / DVD print position adjustment value 30. CD / DVD sensor correction value 31. LF correction 32. Left margin correction value
(ASF back side, U-turn front side, U-turn back side), not used in servicing the MP830

<Direct>

33. Language 34. Business card & Credit card sized paper pages fed 35. Sticker sheets fed 36. Memory card use count 37. Total Card
Direct print pages

38. Card Direct print pages: Photo Paper Pro (4 x 6, 5 x 7, Japanese post card, A4/Letter)

39. Card Direct print pages: Photo Paper Plus Glossy (4 x 6, 5 x 7, Japanese post card, A4/Letter)

40. Card Direct print pages: Matte Photo Paper (4 x 6, 5 x 7, Japanese post card, A4/Letter)

41. Camera Direct print pages: Photo Paper (4 x 6, 5 x 7, Japanese post card, A4/Letter)

42. Camera Direct print pages: Fast Photo Paper (4 x 6, 5 x 7, Japanese post card, A4/Letter)

43. Camera Direct print pages: Matte Photo Paper (4 x 6, 5 x 7, Japanese post card, A4/Letter)

<Scanner>

44. Total scan count

45. Scan count by scanning resolution (75, 150, 300, 600, 1200, 2400, 4800 dpi)

46. Scan count by scanning gradation (grayscale, color)

<Copy>

47. Monochrome copy pages fed via the ASF (plain paper, Photo Paper Plus Glossy & Photo Paper Pro & Glossy Photo Paper, other)

48. Monochrome copy pages fed via the U-turn cassette (plain paper, Photo Paper Plus Glossy & Photo Paper Pro & Glossy Photo Paper,
other)

49. Color copy pages fed via the ASF (plain paper, High Resolution Paper & Matte Photo Paper, Photo Paper Pro & Photo Paper Plus Glossy
& Photo Paper Plus Semi-gloss, Glossy Photo Paper, postcard)

50. Color copy pages fed via the U-turn cassette (plain paper, High Resolution Paper & Matte Photo Paper, Photo Paper Pro & Photo Paper
Plus Glossy & Photo Paper Plus Semi-gloss, Glossy Photo Paper, postcard)

<Fax>

51. Transmission count (monochrome, color) 52. Transmitted pages

53. Reception count 54. Received pages

55. Communication speed

1st line: 33.6/31.2/28.8/26.4/24.0/21.6/19.2/16.8/14.4/12.0/9.6/7.2/4.8/2.4 kbps

2nd line: TC14400/TC12000/TC9600/TC7200/9600/7200/4800/2400 bps

The number of communication pages at each communication speed is indicated in hex.

56. Print head temperature (BK) 57. Print head temperature (CL) 58. Inside temperature 59. Line inspection information (not used in
servicing)

HDEEPROM

60. Version 61. Serial number

62. Lot number 63. Print head ID

64. Ink ejection level (PBK, BK, Y, M, M2, C, C2)

<Scan error history>

65. The last 2 errors (including user errors and copy scan errors. Even if the same errors occur, they are recorded individually.)

<Fax user error history>

66. The last 2 errors

<Fax service error history>

67. The last 2 errors

(3) Fax report

<User report output>

The user report can be output manually by user operation, or automatically via the user data settings.

1) Reports manually output by user operation

Report	Operation
One-touch speed dialing list	Press the FAX button, then Menu button. Using the right or left cursor button, select Print report/list , and the item desired, then press the OK button.
Coded speed dialing list	
Group dialing list	
User's data list	
Activity report	
Memory list	

2) Reports automatically output

- Multi activity report: Automatically output at the end of broadcast.

3) Reports automatically output via the user data settings

- Transmission report
- Reception report
- Activity report

Memo: The current ROM version (e.g. 1.01) is printed in the upper left of the user's data list. In troubleshooting, check the ROM version.

Note: If the machine is turned off by removing the power cord with image data remained in the memory, the image data will be erased. However, the memory clear list will not be printed at next power-on.

<Service report output>

The service data setting status, communication report, and error information report can be output via the service data settings.

1) Reports for service use

Report	Operation
System data list	In the user mode, press and hold the Stop/Reset button until the Alarm LED blinks 13 times in orange, then release the button.
Transmission report (with service error code and dump list)	In service data #1 SSSW SW01, set bit 0 and bit 1 to "1." The service error code and dump list will be added to the transmission report. For details, see <How to set SSSW> below.
Reception report (with service error code and dump list)	In service data #1 SSSW SW01, set bit 0 and bit 1 to "1." The service error code and dump list will be added to the reception report. For details, see <How to set SSSW> below.

<How to set SSSW>

- 1) In the user mode, press and hold the Stop/Reset button until the Alarm LED blinks 12 times in orange, then release the button.
- 2) "SERVICE MODE SERVICE MODE #1 BIT SWITCH" is displayed on the LCD to indicate the machine is in the SSSW mode.
- 3) Press the OK button. "SW#01 00000000" will additionally be displayed on the LCD.
- 4) Using the right or left cursor button, set bit 2 (the rightmost digit (LSB)) and bit 1 (the second digit from the right) to "1."
- 5) Press the OK button.
- 6) Press the Stop/Reset button.
- 7) Press the ON/OFF button to turn off the machine.

2006 01/06 18:05 FAX

001

1.01

*** SYSTEM DATA LIST ***

#1 BIT SW

SW01 --- 00000000	SW05 --- 00101010	SW09 --- 00000000	SW13 --- 00000000
SW02 --- 00000000	SW06 --- 00000000	SW10 --- 00000000	SW14 --- 00110000
SW03 --- 00000000	SW07 --- 00000000	SW11 --- 10000011	
SW04 --- 00000100	SW08 --- 00000000	SW12 --- 00000000	

#2 NUMERIC PARAM.

01: 0	11: 60	21: 200	31: 0	41: 120
02: 10	12: 100	22: 2	32: 10	42: 350
03: 10	13: 150	23: 44	33: 25	43: 0
04: 10	14: 100	24: 10	34: 2	44: 0
05: 15	15: 4	25: 58	35: 2	45: 0
06: 12	16: 100	26: 60	36: 10	46: 0
07: 5500	17: 0	27: 44	37: 1	47: 0
08: 3500	18: 200	28: 8	38: 45	48: 0
09: 1300	19: 100	29: 6	39: 60	49: 0
10: 600	20: 0	30: 0	40: 30	50: 0

#3 FAX TYPE

TYPE --- JAPAN

#4 NCU

1. TONE/PULSE	2. DIAL TONE 1	3. DIAL TONE 2	4. BUSY TONE
		--- 01000000	--- 10000000
01: --- 34	01: --- 350	01: --- 350	01: --- 0
02: --- 650	02: --- 10	02: --- 130	02: --- 40
03: --- 90	03: --- 100	03: --- 10	03: --- 80
04: --- 180	04: --- 3	04: --- 0	04: --- 40
05: --- 7	05: --- 12	05: --- 0	05: --- 80
06: --- 9	06: --- 7	06: --- 5	06: --- 1
	07: --- 21	07: --- 3	07: --- 3
	08: --- 6	08: --- 0	08: --- 3
5. REORDER TONE	6. AUTO RX	7. CNG DETECT	
--- 10000000			
01: --- 0	01: --- 15	01: --- 40	
02: --- 35	02: --- 60	02: --- 60	
03: --- 60	03: --- 65	03: --- 80	
04: --- 40	04: --- 120	04: --- 40	
05: --- 65	05: --- 1100	05: --- 64	
06: --- 1	06: --- 0	06: --- 5	
07: --- 4	07: --- 2	07: --- 2	
08: --- 3	08: --- 10	08: --- 70	
	09: --- 20		

01/24/2006 08:58 FAX

001

```

*****
***  ERROR TX REPORT  ***
*****

INCOMPLETE TRANSMISSION

*1 TX/RX NO          0003
*2 DESTINATION NUMBER          04
*3 DESTINATION ID
*4 ST. TIME          01/24 08:57
*5 TIME USE          00'41
*6 PAGES SENT        0
*7 RESULT            NG          ##765
    
```

```

START TIME          01/24 08:57
OTHER PARTY          04
MAKER CODE          00000000
RCV V.8 FRAME      EO 81 85 D4 90 7E 00 00
SYMBOL RATE        3429
DATA RATE          33.6
TX LVL REDUCTION    0
ERR ABCODE          92
ERR SECTXB         8A
ERR SECRXB         80
    
```

```

Rx : (bit 1) 0000100 01110111 00010101 00100011 00000001 00001001 00000001 (bit56)
      (bit57) 00000001 00011000 00000000 00000000 00000000 (bit96)
Tx : (bit 1) 00000000 01000000 00011111 00100010 00000000 00000000 00000000 (bit56)
    
```

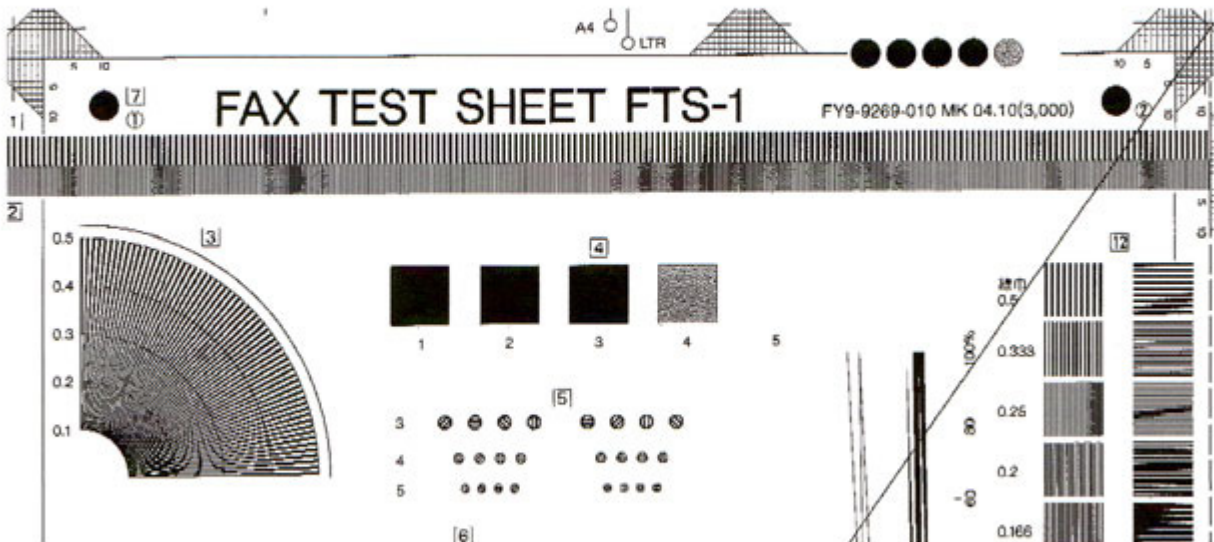

Rx : CSI DIS	CFR
Tx :	TSI DCS PIX-336 PPS-EOP PPS-EOP PPS-EOP DCN



*1: Transaction number (4 digits)

- *2: The number sent from the other party or dialed on the machine (the last 20 digits)
- *3: ID sent from the other party, when the other party is a Canon fax
- *4: Communication start date and time (in 24-hour display)
- *5: Communication duration (in minutes and seconds)
- *6: The number of pages completely transmitted
- *7: "NG" and service error code

[To the table of contents](#)

 [<Part 1: 3. REPAIR; 3-4. Verification Items>](#) 

[To the top](#)

4. MACHINE TRANSPORTATION

This section describes the procedures for transporting the machine for returning after repair, etc.

- 1) In the service mode, press the ON/OFF button to finish the mode, and confirm that the paper lifting plate of the sheet feed unit is raised.
- 2) Keep the print head and ink tanks installed in the carriage.
[See Caution 1 below.]
- 3) Turn off the machine to securely lock the carriage in the home position. (When the machine is turned off, the carriage is automatically locked in place.)
[See Caution 2 below.]
- 4) Slide the scanner lock switch to lock the scanner.



Caution:

- (1) If the print head is removed from the machine and left alone by itself, ink (the pigment-based black ink in particular) is likely to dry.
For this reason, keep the print head installed in the machine even during transportation.
- (2) Securely lock the carriage in the home position, to prevent the carriage from moving and applying stress to the carriage flexible cable, or causing ink leakage, during transportation.

Memo:

If the print head must be removed from the machine and transported alone, attach the protective cap (used when the packing was opened) to the print head (to protect the print head face from damage due to shocks).

[To the table of contents](#)

[To the top](#)

[←](#) <Part 1: 4. MACHINE TRANSPORTATION> [→](#)

Part 2

TECHNICAL REFERENCE



1. NEW TECHNOLOGIES

(1) Ink tank system (PGI-5, CLI-8)

An LED is installed in each ink tank.

By the LED indication, wrong installation of the ink tanks will be prevented, and the remaining ink level can be visually recognized with the ink tanks seated in the carriage.

The pigment-based black ink (PGI-5BK) with higher resistance against bleeding or marker pens increases weather resistance of photo quality prints.

The combination of the pigment-based black ink and the dye-based inks (CLI-8 series) makes the ink system strong in both photo and text printing.

(2) Super-photo quality printing

By the FINE technologies, 1 pl of ultra-fine ink droplet is adopted. The MP830 provides excellent super-photo print quality without graininess at the maximum resolution of 9,600 dpi x 2,400 dpi*1, which is equal to that of a 6-color machine.

*1: Printing at the minimum distance of 1/9600 inch between the dots.

(3) High-speed print and copy

Print speed:

Approx. 36 sec. in 4" x 6" borderless printing (standard mode, Photo Paper Plus Glossy, full page, SCID No.2)

For reference, 30 ppm in monochrome printing and 24 ppm in color printing

Copy speed:

29 cpm in monochrome copy and 24 cpm in color copy

(4) New functionality in Direct Printing (same as the MP800's)

- Plain paper is now usable in Camera Direct Printing from a digital camera or digital video camera, if both support PictBridge.

- File numbers and shooting information can be printed on the images.

- Optimization of photos taken by a mobile phone:

Minimizes jaggies in printing a low-resolution photo taken by a mobile phone.

- Writing to a memory card:

The memory card can be set to the Read-only or Read/Write mode.

- Slide show:

To the **Single-photo print** menu, the slide show function has been added to display photos from the memory card one by one automatically.

- Red eye correction:

Selects red area from an image, and detects and corrects the red eye automatically.

- Face brightener:

Perceives a person's face automatically and adjusts its brightness.

- Index printing:

Printing like a 35 mm negative film is possible.

(5) Sophisticated and smooth design

Sophisticated and classy ADF-integrated all-in-one design.

(6) USB 2.0 Hi-Speed supported

The printer supports USB 2.0 Hi-Speed, enabling high speed data transfer in use with the computer.

(7) High-definition 2.5 color STN LCD

The color tilt LCD offers higher visibility (176 x 132 pixels, approx. 65,000 colors).

(8) 2,400 x 4,800 dpi high-resolution CCD scanner

(9) ADF (Automatic Document Feeder)

Up to 35 sheets can be set, and automatic duplex printing is available.

(10) Fax

- 100 coded speed dials
- 250 page reception in the memory (based on the Canon standard transmission chart)
- Super G3 high speed fax

[To the table of contents](#)

[To the top](#)

 <Part 2: 1. NEW TECHNOLOGIES> 

2. CLEANING MODE AND AMOUNT OF INK PURGED

To prevent printing problems due to bubbles, dust, or ink clogging, print head cleaning is performed before the start of printing (when the cleaning flag is on), except in the following cases:

- Cleaning on arrival: Performed when the scanning unit (printer cover) is closed.
- Manual cleaning / deep cleaning: Performed manually.

<Cleaning mode list>

Black: Pigment-based black

Color: Dye-based black, cyan, magenta, yellow

Condition	Details	Amount of ink used (g) (in the normal temperature/humidity environment)	Est. required time (sec.) (not including the time of opening the caps)
On arrival of the machine (All in sequence)	First to third cleaning after shipped from the plant*1.	0.57 (Black) 2.25 (Color)	100
Dot count cleaning (Black)	When the specified number of dots are printed since the previous Black cleaning.	0.20 (Black)	35 (Black)
Timer cleaning - 0*2 (Black only)	If 24 to 60 hours have elapsed since the previous Black cleaning till the start of the next printing.	0.20 (Black)	35 (Black)
Timer cleaning - 1 (Black only)	If 60 to 96 hours have elapsed since the previous Black cleaning till the start of the next printing.		
Timer cleaning - 2 (Black only)	If 96 to 120 hours have elapsed since the previous Black cleaning till the start of the next printing.		
Timer cleaning - 3*3 (Black/Color)	If 120 to 336 hours have elapsed since the previous Black/Color cleaning till the start of the next printing.	0.20 (Black) 0.66 (Color)	35 (Black) 40 (Color)
Timer cleaning - 4 (All in sequence)	If 336 to 504 hours have elapsed since the previous Black/Color cleaning till the start of the next printing.	0.57 (Black) 1.06 (Color)	80
Timer cleaning - 5 (All in sequence)	If 504 to 720 hours have elapsed since the previous Black/Color cleaning till the start of the next printing.		80
Timer cleaning - 6 (All in sequence)	If 720 to 1,080 hours have elapsed since the previous Black/Color cleaning till the start of the next printing.		80
Timer cleaning - 7 (All in sequence)	If 1,080 to 2,160 hours have elapsed since the previous Black/Color cleaning till the start of the next printing.	1.27 (Black) 1.06 (Color)	85
Timer cleaning - 8 (All in sequence)	If 2,160 to 4,320 hours have elapsed since the previous Black/Color cleaning till the start of the next printing.	1.95 (Black) 1.06 (Color)	90
Timer cleaning - 9 (All in sequence)	If 4,320 to 8,640 hours have elapsed since the previous Black/Color cleaning till the start of the next printing.	1.95 (Black) 1.06 (Color)	90
Timer cleaning - 10 (All in sequence)	If 8,640 or longer hours have elapsed since the previous Black/Color cleaning till the start of the next printing.		90
At print head replacement (All in sequence)	When the print head is removed and installed.	0.57 (Black) 2.25 (Color)	100
At ink tank replacement*4 (Black/Color/All in sequence)	When an ink tank is replaced (without the print head removal or re-installation)	0.38 (Black) 1.06 (Color)	80 (All in sequence) 40 (Black) 65 (Color)
Manual cleaning (Black/Color/All at the	- Via the operation panel (All at the same time only) - Via the MP driver (Selectable from Black, Color,	0.20 (Black) 0.65 (Color)	45 (All at the same time)

same time)	or All at the same time)		35 (Black) 40 (Color)
Deep cleaning (Black/Color/All at the same time)	Via the MP driver (Selectable from Black, Color, or All at the same time)	1.95 (Black) 1.06 (Color)	90 (All at the same time) 45 (Black) 65 (Color)
If the print head has not been capped before power-on (All in sequence)		0.38 (Black) 1.06 (Color)	80 (All in sequence)

*1: The counter for the on-arrival cleaning is checked at opening and closing of the scanning unit (the first opening and closing only), before start of printing, at dot-count cleaning (at paper ejection), and at manual cleaning, and the on-arrival cleaning is performed according to the counter value. After each on-arrival cleaning, the counter value is reduced by 1.

When the counter value is 3, 2, or 1: On-arrival cleaning is performed.

When the counter value is 0: On-arrival cleaning is not performed.

*2: When 24 to 60 hours have elapsed since the previous Black cleaning, timer cleaning - 0 is performed. However, this cleaning will be conducted up to 5 times from the printer installation, and no further timer cleaning - 0 will be performed.

*3: The period of time since the previous cleaning is counted by Black and Color separately. For this reason, the cleaning mode may differ according to Black or Color.

*4: When only the black ink tank is replaced, Black cleaning is performed. One of the color ink tanks is replaced, Color cleaning is performed. Both the black and color ink tanks are replaced, All-at-the-same-time cleaning is performed.

[To the table of contents](#)

[To the top](#)

 [<Part 2: 2. CLEANING MODE AND AMOUNT OF INK PURGED>](#) 

3. PRINT MODE

	Default setting
	Selectable in the printer driver Main tab
	Selectable after clicking Custom in the Main tab

Ink used PigBk: PGI-5BK
 C: CLI-8C(small droplet)
 M: CLI-8M(small droplet)
 Y: CLI-8Y
 k: CLI-8BK
 c: CLI-8C(small droplet)
 m: CLI-8M(small droplet)

Print control Bi: Bi-directional
 Uni: Uni-directional

3-1. Normal Color Printing via Computer

		MP driver Custom setting				
Paper type (Canon specialty paper)	Item	5 Fast	4	3	2	1 Fine
Plain paper	Print quality Resolution HxV (dpi) Print control Ink used	Custom 300X300 1 pass, Bi PigBk/C/M/Y	Fast 300X300 1 pass, Bi PigBk/C/M/Y	Standard 1200X1200 1 pass, Bi PigBk/C/M/Y	High 1200X2400 4 passes, Bi PigBk/C/M/Y/c/m	
Photo Paper Pro (PR-101)	Print quality Resolution HxV (dpi) Print control Ink used			Standard 1200X2400 4 passes, Bi C/M/Y/c/m/k	High 1200X2400 6 passes, Bi C/M/Y/c/m/k	Custom 9600X2400 16 passes, Bi C/M/Y/c/m/k
Photo Paper Plus Glossy Photo Paper Plus Semi- gloss (PP-101/SG-101)	Print quality Resolution HxV (dpi) Print control Ink used		Fast 1200X2400 3 passes, Bi C/M/Y/c/m/k	Standard 1200X2400 4 passes, Bi C/M/Y/c/m/k	High 1200X2400 6 passes, Uni C/M/Y/c/m/k	
Photo Paper Plus Double Sided (PP-101D)	Print quality Resolution HxV (dpi) Print control Ink used			Standard 1200X2400 4 passes, Bi C/M/Y/c/m/k	High 1200X2400 6 passes, Bi C/M/Y/c/m/k	
Matte Photo Paper (MP-101)	Print quality Resolution HxV (dpi) Print control Ink used			Standard 1200X2400 4 passes, Bi C/M/Y/c/m/k	High 1200X2400 6 passes, Bi C/M/Y/c/m/k	
Glossy Photo Paper (GP-401/501)	Print quality Resolution HxV (dpi) Print control Ink used			Standard 1200X2400 4 passes, Bi C/M/Y/c/m/k	High 1200X2400 6 passes, Bi C/M/Y/c/m/k	
High Resolution Paper (HR-101)	Print quality Resolution HxV (dpi) Print control Ink used			Standard 1200X2400 4 passes, Bi C/M/Y/c/m/k	High 1200X2400 6 passes, Bi C/M/Y/c/m/k	
Envelope	Print quality Resolution HxV (dpi) Print control Ink used			Standard 1200X1200 2 passes, Bi PigBk/C/M/Y/k	High 1200X1200 4 passes, Bi PigBk/C/M/Y/k	
CD-R/DVD (recommended)	Print quality Resolution HxV (dpi) Print control Ink used			Fast 1200X2400 4 passes, Bi C/M/Y/c/m/k	Standard 1200X2400 6 passes, Bi C/M/Y/c/m/k	High 1200X1200 8 passes, Bi C/M/Y/c/m/k
CD-R/DVD (others)	Print quality Resolution HxV (dpi)			Fast 1200X2400	Standard 1200X2400	High 1200X2400

	Print control Ink used			4 passes, Bi C/M/Y/c/m/k	6 passes, Bi C/M/Y/c/m/k	8 passes, Bi C/M/Y/c/m/k
T-Shirt transfer (TR-301)	Print quality Resolution HxV (dpi) Print control Ink used			High 1200X1200 6 passes, Bi C/M/Y/k		
Transparency (CF-102)	Print quality Resolution HxV (dpi) Print control Ink used			Standard 1200X1200 4 passes, Bi PigBk/C/M/Y/k	High 1200X1200 6 passes, Bi PigBk/C/M/Y/k	
Other Photo Paper	Print quality Resolution HxV (dpi) Print control Ink used			Standard 1200X2400 8 passes, Bi C/M/Y/c/m/k		

3-2. Normal Grayscale Printing via Computer

		MP driver Custom setting				
Paper type (Canon specialty paper)	Item	5 Fast	4	3	2	1 Fine
Plain paper	Print quality Resolution HxV (dpi) Print control Ink used	Custom 300X300 1 pass, Bi PigBk	Fast 300X300 1 pass, Bi PigBk	Standard 600X600 1 pass, Bi PigBk	High 600x600 4 passes, Bi PigBk	
Envelope	Print quality Resolution HxV (dpi) Print control Ink used			Standard 600X600 2 pass-Uni PigBk	High 600X600 4 pass-Uni PigBk	

3-3. Borderless Printing via Computer

		MP driver Custom setting				
Paper type (Canon specialty paper)	Item	5 Fast	4	3	2	1 Fine
Plain paper	Print quality Resolution HxV (dpi) Print control Ink used			Standard 1200X1200 2 passes, Bi C/M/Y/k		
Photo Paper Pro (PR-101)	Print quality Resolution HxV (dpi) Print control Ink used			Standard 1200X2400 4 passes, Bi C/M/Y/c/m/k	High 1200X2400 6 passes, Bi C/M/Y/c/m/k	Custom 9600X2400 16 passes, Bi C/M/Y/c/m/k
Photo Paper Plus Glossy Photo Paper Plus Semi-gloss (PP-101/SG-101)	Print quality Resolution HxV (dpi) Print control Ink used		Fast 1200X2400 3 passes, Bi C/M/Y/c/m/k	Standard 1200X2400 4 passes, Bi C/M/Y/c/m/k	High 1200X2400 6 passes, Bi C/M/Y/c/m/k	
Glossy Photo Paper (GP-401/501)	Print quality Resolution HxV (dpi) Print control Ink used			Standard 1200X2400 4 passes, Bi C/M/Y/c/m/k	High 1200X2400 6 passes, Bi C/M/Y/c/m/k	
Matte Photo Paper (MP-101)	Print quality Resolution HxV (dpi) Print control Ink used			Standard 1200X2400 4 passes, Bi C/M/Y/c/m/k	High 1200X2400 6 passes, Bi C/M/Y/c/m/k	
Other Photo Paper	Print quality Resolution HxV (dpi) Print control Ink used			Standard 1200X2400 8 passes, Bi C/M/Y/c/m/k		

3-4. Duplex Printing via Computer

		MP driver Custom setting				
Paper type (Canon specialty paper)	Item	5 Fast	4	3	2	1 Fine
Plain paper	Print quality Resolution HxV (dpi) Print control Ink used	Custom 300X300 1 pass, Bi PigBk./C/M/Y	Fast 300x300 1 pass, Bi PigBk/C/M/Y	Standard 1200X1200 1 pass, Bi PigBk/C/M/Y	High 1200X2400 4 passes, Bi PigBk/C/M/Y/c/m	
Plain paper, borderless printing	Print quality Resolution HxV (dpi) Print control Ink used			Standard 1200X1200 2 passes, Bi C/M/Y/k		
Photo Paper Plus Glossy Double Sided (PP-101D)	Print quality Resolution HxV (dpi) Print control Ink used			Standard 1200X2400 4 passes, Bi C/M/Y/c/m/k	High 1200X2400 6 passes, Bi C/M/Y/c/m/k	

3-5. Camera Direct Printing

		MP driver Custom setting					
Paper type (Canon specialty paper)	Item	5 Fast	4	3	2	1 Fine	Camera Direct print
Plain paper, Camera Direct printing	Print quality Resolution HxV (dpi) Print control Ink used						1200X1200 4 passes, Bi PigBk/C/M/Y

Photo Paper Pro (PR-101)	Print quality Resolution HxV (dpi) Print control Ink used					1200X2400 6 passes, Bi C/M/Y/c/m/k		
Photo Paper Plus Glossy Photo Paper Plus Semi-gloss (PP-101/SG-101)	Print quality Resolution HxV (dpi) Print control Ink used					1200X2400 6 passes, Bi C/M/Y/c/m/k		

3-6. Card Direct Printing

		MP driver Custom setting					
Paper type (Canon specialty paper)	Item	5 Fast	4	3	2	1 Fine	Special mode
Plain paper	Print quality Resolution HxV (dpi) Print control Ink used				Standard 1200X2400 4 passes, Bi PigBk/C/M/Y/k		High 1200X2400 6 passes, Bi PigBk/C/M/Y/c/m
Glossy Photo Paper (GP-401/501)	Print quality Resolution HxV (dpi) Print control Ink used			Standard 1200X2400 4 passes, Bi C/M/Y/c/m/k	High 1200X2400 6 passes, Bi C/M/Y/c/m/k		
Photo Paper Pro (PR-101)	Print quality Resolution HxV (dpi) Print control Ink used			Standard 1200X2400 4 passes, Bi C/M/Y/c/m/k	High 1200X2400 6 passes, Bi C/M/Y/c/m/k		
Matte Photo Paper (MP-101)	Print quality Resolution HxV (dpi) Print control Ink used			Standard 1200X2400 4 passes, Bi C/M/Y/c/m/k	High 1200X2400 6 passes, Bi C/M/Y/c/m/k		
Photo Paper Plus Glossy Photo Paper Plus Semi-gloss (PP-101/SG-101)	Print quality Resolution HxV (dpi) Print control Ink used			Standard 1200X2400 4 passes, Bi C/M/Y/c/m/k	High 1200X2400 6 passes, Bi C/M/Y/c/m/k		
CD-R/DVD (recommended)	Print quality Resolution HxV (dpi) Print control Ink used				Standard 1200X2400 6 passes, Bi C/M/Y/c/m/k		
CD-R/DVD (others)	Print quality Resolution HxV (dpi) Print control Ink used			Fast 1200X2400 4 passes, Bi C/M/Y/c/m/k			

3-7. Copying

		MP driver Custom setting					
Paper type (Canon specialty paper)	Item	5 Fast	4	3	2	1 Fine	Special mode
Plain paper	Print quality Resolution HxV (dpi)	Fast 300X300		Standard 600X600	High 600X600		
Single sided Black	Print control Ink used	1 pass, Bi PigBk		1 pass, Bi PigBk	4 passes, Bi PigBk		
Plain paper	Print quality	Fast		Standard	High		

Single sided Color	Resolution HxV (dpi) Print control Ink used	300X300 1 pass, Bi PigBk/C/M/Y		1200X1200 1 pass, Bi PigBk/C/M/Y	1200X2400 4 passes, Bi PigBk/C/M/Y/c/m		
Glossy Photo Paper (GP-401/501) Single sided Black/Color	Print quality Resolution HxV (dpi) Print control Ink used			Standard 1200X2400 4 passes, Bi C/M/Y/c/m/k	High 1200X2400 6 passes, Bi C/M/Y/c/m/k		
Photo Paper Pro (PR-101) Single sided Black/Color	Print quality Resolution HxV (dpi) Print control Ink used			Standard 1200X2400 4 passes, Bi C/M/Y/c/m/k			High 1200X2400 6 passes, Bi C/M/Y/c/m/k
Matte Photo Paper (MP-101) Single sided Black/Color	Print quality Resolution HxV (dpi) Print control Ink used			Standard 1200X2400 4 passes, Bi C/M/Y/c/m/k	High 1200X2400 6 passes, Bi C/M/Y/c/m/k		
Photo Paper Plus Glossy Photo Paper Plus Semi-gloss (PP-101/SG-101) Single sided Black/Color	Print quality Resolution HxV (dpi) Print control Ink used			Standard 1200X2400 4 passes, Bi C/M/Y/c/m/k	High 1200X2400 6 passes, Bi C/M/Y/c/m/k		
CD-R/DVD (recommended) Single sided Black/Color	Print quality Resolution HxV (dpi) Print control Ink used				Standard 1200X2400 6 passes, Bi C/M/Y/c/m/k		
CD-R/DVD (others) Single sided Black/Color	Print quality Resolution HxV (dpi) Print control Ink used			Fast 1200X2400 4 passes, Bi C/M/Y/c/m/k			
Plain paper Double Sided Black/Color/Photo	Print quality Resolution HxV (dpi) Print control Ink used	Fast 300X300 1 pass, Bi PigBk/C/M/Y		Standard 1200X2400 1 pass, Bi PigBk/C/M/Y	High 1200X2400 6 passes, Bi PigBk/C/M/Y/c/m		

[To the table of contents](#)

[To the top](#)



4. FAQ (Problems Specific to the MP830 and Corrective Actions)

No.	*	Function	Phenomenon	Condition	Cause	Corrective action	Possible call or complaint
1	B	Print results	Skewed paper feeding	<ul style="list-style-type: none"> - Paper feeding from the cassette - Photo Paper Plus Double Sided - 5 x 7 size 	Due to its mechanism, contact of the PF pinch rollers to the 5 x 7 size paper is uneven, which is likely to cause skewed paper feeding.	Change the paper feeding method from the cassette to the auto sheet feeder.	<ul style="list-style-type: none"> - Paper feeds at an angle. - A margin appears on printouts.
2	B	Paper feed	Improper paper feeding: <ul style="list-style-type: none"> - Multi-feeding - Skewed paper feeding - Paper jam 	<ul style="list-style-type: none"> - Paper feeding from the ASF - Plain paper - Highest print speed (Custom setting to 5) - In the high temperature and high humidity environment - In the low temperature and low humidity environment - With the maximum amount of paper set (13 mm) 	In the high temperature and high humidity environment, paper becomes wavy; in the low temperature and low humidity environment, paper curls significantly. When the maximum amount of paper is set in the ASF, and if the paper-return tab fits in a wave or curl of the paper, the tab slips and does not catch paper properly, causing paper feed problems.	<ul style="list-style-type: none"> - Reduce the amount of paper set in the ASF to half (approx. 5 mm high). 	<ul style="list-style-type: none"> - Multiple sheets of paper feed at the same time. - Paper feeds at an angle. - A paper jam occurs.
3	C	Print results	Skewed paper feeding (at the level of +/- 1%)	<ul style="list-style-type: none"> - Paper feeding from the ASF - Credit Card size 	Since coaxial tolerance between the pinch roller and the LF roller, which determines the paper feed alignment, is 0.2mm, skewed paper feeding can occur. However, according to the field data of current models, the skewness level caused by the coaxial tolerance of 0.2mm is within the criteria of +/- 1%, thus the phenomenon is left as is.	<ul style="list-style-type: none"> - Align the paper guide to the paper edge tighter than usual. 	<ul style="list-style-type: none"> - Paper feeds at an angle. - A margin appears on printouts.
4	A	Print results	Soiling on the back side of paper (lines or streaks parallel to the paper feed direction)	<ul style="list-style-type: none"> - After continuous borderless printing of small sized paper (such as 4 x 6), when a larger sized paper (such as A4) is printed. - With Photo Paper Plus Double Sided or postcards, the phenomenon is likely to be noticeable and to be complained of by users, as printing is performed on both sides of such paper. 	In borderless printing, printing is performed to the size slightly larger than the paper size, and ink off the paper is absorbed by the platen's ink absorber. Absorbed ink may attach to the platen rib(s) after several dozen sheets are printed, causing soiling at the leading edge of paper or on the back side of paper.	<ol style="list-style-type: none"> 1. Perform Bottom plate cleaning (from the MP driver or via the operation panel) up to 3 times*¹. 2. If soiling on the paper still remains after 3 times of Bottom plate cleaning, wipe the platen rib(s) and their surroundings with a cotton swab. 	<ul style="list-style-type: none"> - Paper gets smeared. - The back side of paper gets smeared.
			Soiling on paper in automatic duplex printing (lines or streaks perpendicular to the paper feed direction)	<ul style="list-style-type: none"> - Automatic duplex printing (Photo Paper Plus Double Sided, postcards, plain paper) 	On the rib(s) inside the sheet feed unit used for duplex printing, ink mist may accumulate, smearing paper.	<p>Temporary operational solution:</p> Cancel automatic duplex printing, and manually print each side of paper.	<ul style="list-style-type: none"> - Paper gets smeared. - The back side of paper gets smeared. - Even after Bottom plate cleaning was performed, and the platen ribs were cleaned with cotton swab, paper gets smeared.

5	B	Print results				<p>2. If soiling on the paper still remains after 3 times of Bottom plate cleaning, wipe the platen rib(s) and their surroundings with a cotton swab.</p> <p>If the phenomenon persists after conducting 1 and 2, servicing is required.</p> <p>Service: Wipe any soiling or dirt off from the sheet feed unit and the bottom case unit ribs*2.</p>	
6	C	Print results	Scratches on paper	<ul style="list-style-type: none"> - PP-101D, PP-101, PR-101, SG-101, etc. - Paper feeding from the cassette 	Scratches on the PF return lever due to paper feeding from the cassette, and duplex printing path.	<ul style="list-style-type: none"> - Change the paper feeding method from the cassette to the auto sheet feeder. - If automatic duplex printing is performed, cancel it, and, by setting only a single sheet of paper in the auto sheet feeder, manually print each side of paper. 	<ul style="list-style-type: none"> - Paper is scratched. - Marks appear on printed paper.
				<ul style="list-style-type: none"> - PP-101D, PP-101, PR-101, SG-101, etc. - Paper feeding from the ASF - Multiple number of sheets loaded 	When multiple sheets of paper are set, the back side of paper being picked up scratches the front side of paper beneath (especially where the paper feed rollers contact when picking up the paper).	Set only a single sheet of paper in the auto sheet feeder.	
7	C	Print results	Soiling on paper	The machine has been used for a long period of time with the ASF cover closed before printing is performed using the ASF.	<p>Due to ink mist attached to the ASF sub-pick-up rollers.</p> <p>If printing is done from the cassette with the ASF cover closed, ink mist is kept inside the machine, attaching to the ASF sub-pick-up rollers.</p> <p>Since the sub-rollers usually do not contact the paper, ink mist can easily accumulate, especially during printing on small-sized paper which never contacts the sub-rollers.</p>	Clean the ASF sub-rollers (see *3 for details).	
8	B	Print results	Skewed paper feeding	<ul style="list-style-type: none"> - SG-101 - Paper feeding from the ASF - 10 sheets (max.) set in the ASF 	When 10 sheets of paper are set in the ASF, and if they warp significantly, the warping portions of paper get over the cover guide, not being aligned along the guide properly.	<ul style="list-style-type: none"> - Straighten the paper. - Set 5 or less sheets of paper in the ASF. 	<ul style="list-style-type: none"> - Paper feeds at an angle. - A margin appears on printouts.
9	B	Print results	Uneven printing at the trailing edge of paper	- In the low temperature and low humidity environment	Due to decrease of the friction coefficient and inaccurate print head alignment.	<ul style="list-style-type: none"> - Perform Manual print head alignment. - Perform Bottom plate cleaning. 	<ul style="list-style-type: none"> - Uneven printing at the bottom of the paper.
			Print smeared	- When the inner cover is	When printing on paper	Close the inner cover	- Printing gets

10	B	Print results		not completely closed. - High-density image printing	is done with the inner cover open, the print immediately after ink is ejected on paper is scratched by the bottom of the inner cover, resulting in smeared print.	completely.	smeared.
11	A	Image scanning	Spots on a scanned image	- Glossy photo (original) - In the high humidity environment	When a glossy photo is strongly pressed on the platen glass, the photo will stick to the glass, and the stuck points are scanned as spots.	- Do not strongly press the photo on the platen glass. - Clean the platen glass (to eliminate any moisture).	- Spots appear on the scanned image, though there is no such spots on the original document.
12	C	Display on the LCD	Improper trimming in Layout print (orientation difference of an image between the LCD and a printout)	- Card Direct printing - Photos taken with a DoCoMo mobile phone	For photos in general, both the thumbnail and the original image are in landscape. However, when original images are in portrait while thumbnails are in landscape, the trimming frame shifts from the correct position in some instances.	The phenomenon is left as is.	- Print result differs from what is displayed on the LCD.
13	A	Fax reception	Fax received in the memory	- Improper machine settings - Improper machine condition at reception of a fax	Ink is out.	Replace the empty ink tank.	- Fax cannot be received. - Fax is not printed.
					The paper size is not set properly.	Set the paper size properly. (A4, LTR, and LGL size paper can be used only for the ASF.)	
					The selected paper type is not supported for fax reception.	Select plain paper.	
					No paper.	Set paper, and press the OK button.	
					PGI-5BK (pigment-based ink) is getting low.	To print the received fax, press the Menu button in the FAX mode, select FAX SETTING, MEMORY REFERENCE, and PRINT DOCUMENT. Or replace PGI-5BK.	
14	A	Fax reception	Fax received in the memory	At reception of a fax, the machine is in a mode other than the FAX mode.	The machine is in the COPY, SCAN, or MEMORY CARD mode at reception of a fax.	- Approx. 3 minutes after the end of operation being performed at fax reception, the machine automatically changes to the FAX mode and prints the received fax from the memory. After the fax is printed, the machine remains in the FAX mode (not returns to the mode before the FAX mode.) - To print the fax immediately after reception, press the FAX button.	- Fax cannot be received. - Fax is not printed.
			Fax received in the memory	Pressing of the Stop/Reset button to clear an error.	An error (such as "no paper" error) at reception of the fax is cleared by pressing the Stop/Reset button.	When an error is cleared by the Stop/Reset button, the fax received in the memory remains in the memory, and is not printed automatically.	- Fax is not printed.

15	A	Fax reception				To print it, perform either of the following: - Press the FAX button when the machine is in the FAX standby mode. - Press another mode button, then the FAX button.	
16	A	Fax reception	Color fax not received	Dye-based color ink (CLI-8 series) is getting low.	Dye-based color ink (CLI-8 series) is getting low.	To print the received fax, press the Menu button in the FAX mode, select FAX SETTING, MEMORY REFERENCE, and PRINT DOCUMENT. Or replace the applicable ink tank.	- Color fax cannot be received. - Color fax is received in the memory.

*1: Change the paper in each Bottom plate cleaning. The cleaning can end when paper does not get any soiling.

*2: Locations to clean in servicing when soiling on paper in automatic duplex printing persists:

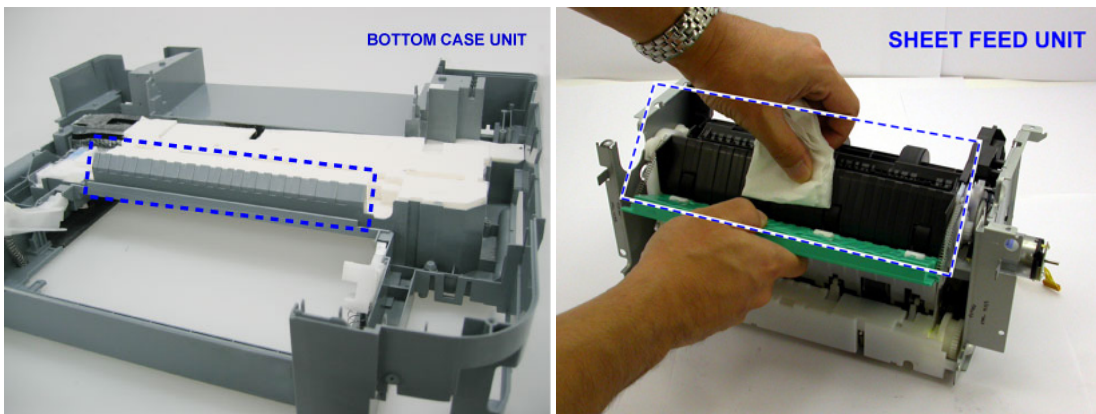

*3: How to make and set the ASF sub-roller cleaning sheet:

- 1) Fold a sheet of plain paper lengthwise in half.
- 2) Fold the paper at approx. 60 mm from the end, and fold the folded end in half backward, as shown below.

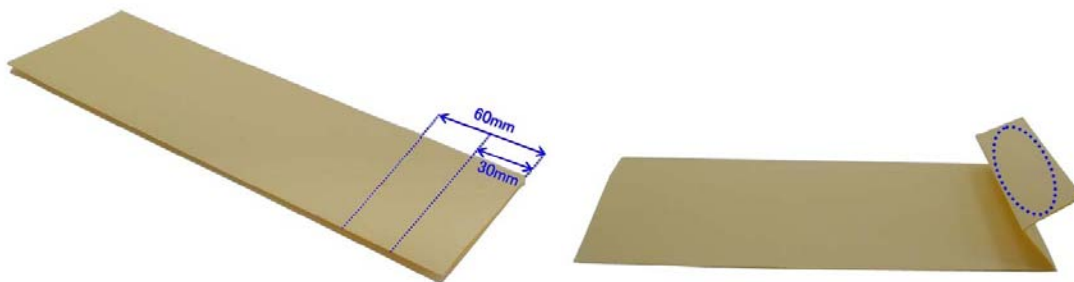

- 3) Moisten the folded end portion (indicated by the blue circle in the figure above) using a wipe, and set the paper in the ASF so that the moistened edge of the paper contacts the 2 sub-rollers. Then, fold the other end of the paper along the ASF cover edge to hook the paper to the ASF cover, as shown below.



- 4) With the machine turned on in the user mode, set the paper source to the ASF and press the Menu button. Select Maintenance / Settings, Maintenance, then Roller cleaning.
- 5) The paper wipes off ink from the sub-rollers.

* Occurrence level:

- A: The symptom is likely to occur frequently. (Caution required)
- B: The symptom may occur under certain conditions, but likeliness is assumed very low in practical usage.
- C: The symptom is unlikely to be recognized by the user, and no practical issues are assumed.

[To the table of contents](#)

[To the top](#)

[← <Part 2: 4. FAQ> →](#)

Part 3

APPENDIX



3. PIXMA MP830 SPECIFICATIONS

<Machine>

Type	Desktop serial color inkjet printer																		
Paper feeding method	Auto sheet feed (ASF, cassette, automatic duplex printing, CD / DVD printing*1)																		
Resolution	9,600 x 2,400dpi (Max.)																		
Throughput (target value)	- 4 x 6, borderless printing: Approx. 36 sec. (standard mode, PP-101, Full Page SCID No. 2) - Camera Direct printing: Approx. 57 sec. (4 x 6, borderless, PP-101, default settings) For reference: <table border="0" style="width: 100%; margin-top: 5px;"> <tr> <td></td> <td style="text-align: center;">Fast</td> <td style="text-align: center;">Standard</td> <td colspan="2"></td> </tr> <tr> <td>Black (Fine Black)</td> <td style="text-align: center;">30ppm</td> <td style="text-align: center;">15.0ppm</td> <td colspan="2"></td> </tr> <tr> <td>Color (Fine Color)</td> <td style="text-align: center;">24ppm</td> <td style="text-align: center;">11.7ppm</td> <td colspan="2"></td> </tr> </table>					Fast	Standard			Black (Fine Black)	30ppm	15.0ppm			Color (Fine Color)	24ppm	11.7ppm		
	Fast	Standard																	
Black (Fine Black)	30ppm	15.0ppm																	
Color (Fine Color)	24ppm	11.7ppm																	
Printing direction	Bi-directional, uni-directional																		
Print width	Max. 203.2mm (215.9mm in borderless printing)																		
Interface	- USB 2.0 Hi-Speed (for a computer) - Direct print port (for a digital camera)																		
ASF stacking capacity	Plain paper: Max. 13mm (Approx. 150 sheets of 64g/m ² paper)																		
Cassette stacking capacity	Plain paper: Max. 13mm (Approx. 150 sheets of 64g/m ² paper) (Photo Stickers and Credit Card size not supported)																		
Paper weight	64 to 105g/m ² (plain paper)																		
Detection functions	Scanning unit open, Presence of print head / ink tanks, Opening / Closing of inner cover, Remaining ink amount (optical / dot count), Printing position, Paper presence, Paper end sensor, Waste ink amount, Internal temperature, Pick-up roller, Paper feed roller position, Carriage position, Head-to-paper distance, Supported camera direct printing device, Presence of CD / DVD*1, Presence of memory card, Presence of document in the ADF, ADF paper end sensor, Scanner home position																		
Acoustic noise	- Highest print quality settings: Approx. 34.7dB (print from a computer) / 41.3dB (copy) - Quiet mode: Approx. 33.4dB																		
Environmental requirements	During operation Non operation	Temperature Humidity Temperature Humidity	5C to 35C (41F to 95F) 10%RH to 90%RH (no condensation) 0C to 40C (32F to 104F) 5%RH to 95%RH (no condensation)																
Power supply	Power supply voltage, frequency	Power consumption (copy)	Standby	Power-off															
	AC 100 to 240V, 50/60Hz	Approx.25W	Approx. 4.0W	Approx. 1.0W															
External dimensions	- With the paper support, output tray, and document tray retracted: Approx. 500 (W) x 487 (D) x 292 (H)mm - With the paper support, output tray, and document tray extended: Approx. 500 (W) x 594 (D) x 334 (H)mm																		
Weight	Approx. 14.7kg, not including print head and optional units																		
Related standards (Machine, Adapter)	Electromagnetic radiance: VCCI, FCC, IC, CE Mark, A-Tick, CCC (EMC), Gost-R, SASO Electrical safety: UL, C-UL, CB Report, CE Mark, GS, Gost-R, SASO, CCC, SPRING Environmental regulations: RoHS (EU), WEEE (EU), Korea Package Recycle Law, Green Point (Germany), Energy Star, Eco Mark, Law on Promoting Green Purchasing PTT: JATE, FCC Part 68, IC CS-03, CRT21, etc.																		
Serial number location	On the chassis (on the right of the carriage in the print head replacement position, visible when the scanning unit is open)																		
Remaining ink amount detection	Available (automatic detection by optical method and dot count, enabled at default)																		
Paper type detection	Not available																		
Print head alignment	Available (automatic or manual alignment via the driver Maintenance tab, or via the operation panel button in Direct Printing, automatic alignment at default)																		

*1: Only for CD / DVD printing supported regions

<ADF>

ADF capacity	A4 or LTR: Max. 35 sheets (75 g/m ² paper), up to 5 mm high LGL: Max. 30 sheets (75 g/m ² paper), up to 4 mm high Other sizes: Max. 1 sheet
--------------	---

<Scanner>

Type	Flat bed scanner and ADF
Sensor type	CCD (Charge Coupled Device): 2,400 dpi / 600 dpi dual
Optical resolution	2,400 x 4,800 dpi (max.)
Scanning resolution (software interpolation)	19,200 x 19,200 dpi (max.)
Gradation (input / output)	Grayscale: 48 bit / 8 bit Color: 48 bit / 24 bit
Document size	Platen glass: A4 / LTR (Max.) ADF: LGL (Max.)
Scanner driver	TWAIN-compliant, WIA (Windows XP only)

<Copy>

Copy quality	3 levels (Fast, Standard, High)
Intensity	9 levels (automatic intensity adjustment available)
Enlargement / reduction ratio	25 to 400%
Copy speed	Fast Monochrome (Fine BK) 29cpm Color (Fine CL) 24cpm Conditions: The duration from ejection of the first page to ejection of the 11th page in continuous copy is converted into cpm.
Document size	A4 / LTR (max.)
Enlargement / reduction	Preset ratio: max. (400%), 4x6 -> 8.5x11 (212%), 5x7 -> 8.5x11 (170%), A5 -> A4 (141%), B5 -> A4 (115%), 100%, A4 -> 8.5x11 (95%), A4 -> B5 (86%), A4 -> A5 (70%), min. (25%) Zoom: 25 to 400% (in increments of 1%)
Number of continuous copies	Monochrome / color: 1 to 99 copies

<Direct printing>

Memory card drive	Supported memory card	Compact Flash TYPE I/II (3.3V), Microdrive, SmartMedia Card (3.3V only), Memory Stick, Memory Stick PRO, SD Card, MultiMedia Card, xD-Picture Card* ¹ , miniSD memory card* ¹ , Memory Stick Duo* ¹ , Memory Stick PRO Duo* ¹ * ¹ : Adapter required.
Storage function	Operation	Via the machine buttons.
	Condition	Before changing the settings, the memory card must be removed.
	Function	Read / Write
	Operation panel	2.5 color STN LCD, 46 buttons, 8 LEDs
	File format	JPEG (DCF, CIFF, Exif 2.21 or prior, JFIF), DPOF compliant
	Print quality	Standard, High
	Image correction function	Red eye correction, VIVID, Photo Optimizer PRO, Noise reduction, Face brightener, Image optimizer
	Image adjustment function	Brightness, contrast, color hue (skin tones)

Card Direct Printing	Image processing function	Sepia, Simulate illustration, No effects
	Image retrieval function	Available (date)
	DPOF	Ver. 1.00 compliant Index printing, printing of an image the specified number of copies, printing of the specified image(s), printing with the shooting date
	Print layout	Single-photo/multi-photo/all-photo printing: 1 photo per page (borderless/with borders, only with borders for plain paper)
		Index printing: 6, 24, 35, 80 photos per page
		Layout printing: 2, 4, 8 photos per page (borderless/with borders) Half (borderless/with borders, with/without lines) Album (4 photos per page, right/left) Mix 3 types (for A4/LTR)
		Sticker printing: 16 stickers
Information print	Exif information print	
Throughput	64.87 seconds, with the following conditions and settings: - A photo from a 5 mega-pixel digital camera - 4 x 6 borderless - Photo Paper Plus Glossy - Standard print quality - Process from pressing the printing start button to ejecting paper	
Camera Direct Printing (PictBridge)	Supported paper size	- Default (selections based on the printer settings) - 10 x 15 cm / 4" x 6" Photo Paper Pro, Photo Paper Plus Glossy, Photo Paper Plus Semi-gloss, Glossy Photo Paper, Photo Stickers*2 - 13 x 18 cm / 5" x 7" Photo Paper Plus Glossy*3 - A4 / LTR Photo Paper Pro, Photo Paper Plus Glossy, Photo Paper Plus Semi-gloss, Glossy Photo Paper, plain paper - 5.4 x 8.6 cm / Credit Card Glossy Photo Paper *2: Canon-brand sticker. Printing on Photo Stickers is available only when the Layout function on the camera has a 16-up option. *3: Available only with a Canon PictBridge camera.
	Supported paper type	- Default (selections based on the printer settings) - Photo: Photo Paper Plus Glossy, Glossy Photo Paper - Fast Photo: Photo Paper Pro - Plain paper: A4 / LTR plain paper
	Print layout	- 1 photo per page (borderless/with borders) - 16 photos per page*4 - 35 photos per page*5 *4: Layout compatible with Canon-brand sticker above. *5: Selected photos are printed in 35 mm film style layout. This print setting is available only with certain Canon PictBridge devices. The shooting information (Exif data) can be printed on photos in list format, or in the margins of specified photos.
	Trimming	- Default: OFF (no trimming) - ON (follows the camera settings) / OFF
	Image optimization	Default (selections based on the printer settings), ON, OFF, VIVID*6, Noise reduction*6, Face brightener*6

		*6: Available only with a Canon PictBridge camera.
	Information print	Date, file number
	Throughput	64.38 sec., with the following conditions and settings: - A photo from a 5 mega-pixel digital camera - 4" x 6" borderless - Photo Paper Plus Glossy - Standard print quality - Process from pressing the printing start button to ejecting paper
Camera Direct Printing (Canon Bubble Jet Direct)	Supported paper	- Card #1 (4" x 6" / 101.6 x 152.4 mm) Photo Paper Pro - Card #2 (4" x 6" / 101.6 x 152.4 mm) Photo Paper Plus Glossy, Photo Paper Plus Semi-gloss, Glossy Photo Paper - Card #3 (5" x 7" / 127.0 x 177.8 mm) Photo Paper Plus Glossy - A4 / LTR Photo Paper Pro, Photo Paper Plus Glossy, Photo Paper Plus Semi-gloss, Glossy Photo Paper
	Print layout	- 1 photo per page (borderless/with borders) - Index print (6 to 80 photos per page)
	Effect	Exif print
	DPOF print	Ver. 1.00 compliant Index printing, printing of an image the specified number of copies, printing of the specified image(s), printing with the shooting date

<Fax>

Applicable line	Public Switched Telephone Network (PSTN)
Type	Super G3 compliant desktop color fax
Data compressing system	MH, MR, MMR, JPEG
Gradation	Monochrome: 256 gradations Color: 24 bit, full color (each color 8 bit)
Modem type	Fax modem
Modem speed	33600 / 14400 / 9600 / 7200 / 4800 / 2400 bps Automatic fallback
Transmission speed	- Black & white: Approx. 3 sec. per page at 33.6 kbps, ECM-MMR, transmitting from memory (Canon fax standard chart No.1, standard mode) - Color: Approx. 1 minute and 20 sec. page at 33.6 kbps, ECM-JPEG, transmitting from memory (Canon color fax test sheet)
Scanning image processing	- GENESIS, UHQ (Ultra High Quality) - Halftones: 64 levels of gray - Density adjustment: 3 levels
Memory	Transmission and reception: Approx. 250 pages (Canon fax standard chart, standard mode)
Fax resolution	- Black & white <Standard>: 8 pels per mm x 3.85 lines per mm - Black & white <Fine>, <Photo>: 8 pels per mm x 7.71 lines per mm - Color: 200 x 200 dpi
Error correction	ECM (Error Correction Mode)
Recording paper	- Size: A4, LTR, LGL* (* ASF only) - Type: Plain paper

Recording width	203.2 mm (A4, LTR)
Scanning width	208 mm (A4), 214 mm (LTR)
Dialing	<ul style="list-style-type: none"> - Automatic dialing - One-touch speed dialing (8 destinations) - Coded speed dialing (100 destinations) - Group dialing (up to 107 destinations in one group) - Manual redialing (via the Redial/Pause button)
Networking	<ul style="list-style-type: none"> - Sequential broadcasting (109 destinations) - Automatic reception - Automatic fax / telephone switchover - DRPD (Distinctive Ring Pattern Detection) (USA only) - Remote reception by telephone (Default ID: 25) - Non-ring reception - ECM deactivation - Activity report (after every 20 transactions) - Non-delivery report - TTI (Transmit Terminal Identification), etc.

<Telephone>

Connection	Telephone / answering machine (CNG detecting signal) / data modem
------------	---

<Computer fax>

Type	Fax modem (Windows only)
Destination	1 destination, monochrome transmission only
Control command	Original

<Print head>

Type	Single head with 5 removable ink tanks (each color)
Print head	Pigment-based BK: 512 nozzles, 600 dpi, 30 pl Dye-based BK / C / M / Y: 512 x 6 nozzles, 1,200 dpi, 1 pl / 5 pl (C / M), 5 pl (BK / Y)
Ink color	Pigment-based black Dye-based black, cyan, magenta, yellow
Ink tank	PGI-5BK (pigment-based), CLI-8BK / C / M / Y (dye-based)
Weight (Net)	Print head, approx. 60g
Supply method	As a service part (not including ink tanks)
Part number	QY6-0061-000

<Supported ink tanks>

Model name and destination		Pigment-based ink		Dye-based ink							
		PGI-5BK	BCI-9BK	CLI-8BK	CLI-8C	CLI-8M	CLI-8Y	BCI-7eBK	BCI-7eC	BCI-7eM	BCI-7eY
PIXMA MP830	Other than Japan	O	X	O	O	O	O	X	X	X	X
PIXUS MP830	Japan	X	O	X	X	X	X	O	O	O	O

O: Usable

X: Not usable

Note: The ink tanks for the Japanese models are not compatible with those for the non-Japanese models. Be sure to use the appropriate ink tanks in servicing.

[To the table of contents](#)

[To the top](#)

 **<Part 3: 3. PIXMA MP830 SPECIFICATIONS>**