

Canon

EOS
REBEL T3i
EOS 600D



Canon

EOS
REBEL T3i

EOS 600D

INSTRUCTION MANUAL



The “Software Start Guide” and “Quick Reference Guide” are provided at end of this manual.

E

INSTRUCTION
MANUAL

Introduction

The EOS REBEL T3i/EOS 600D is a high-performance, digital single-lens reflex camera featuring a fine-detail CMOS sensor with approx. 18.0 effective megapixels, DIGIC 4, high-precision and high-speed 9-point AF, approx. 3.7 fps continuous shooting, Live View shooting, and Full High-Definition (Full HD) movie shooting.

The camera is highly responsive for shooting at anytime, provides many functions fitted for advanced shooting, and offers many other features.

Refer to This Manual while Using the Camera to Further Familiarize Yourself with the Camera

With a digital camera, you can immediately view the image you have captured. While reading this manual, take a few test shots and see how they come out. You can then better understand the camera.

To avoid botched pictures and accidents, first read the “Safety Warnings” (p.297, 298) and “Handling Precautions” (p.14, 15).

Testing the Camera Before Use and Liability

After shooting, playback and check whether the images have been properly recorded. If the camera or memory card is faulty and the images cannot be recorded or downloaded to a computer, Canon cannot be held liable for any loss or inconvenience caused.

Copyrights

Copyright laws in your country may prohibit the use of your recorded images or copyrighted music and images with music in the memory card for anything other than private enjoyment. Also be aware that certain public performances, exhibitions, etc., may prohibit photography even for private enjoyment.



This camera is compatible with SD memory cards, SDHC memory cards, and SDXC memory cards. This manual will refer to all these cards as just “card.”

*** The camera does not come with a card for recording images.**
Please purchase it separately.

Item Check List

Before starting, check that all the following items have been included with your camera. If anything is missing, contact your dealer.



Camera
(with eyecup and body cap)



**Battery Pack
LP-E8**
(with protective cover)



**Battery Charger
LC-E8/LC-E8E***



**Wide Strap
EW-100DB III**



Interface cable

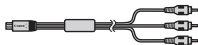

**Stereo AV Cable
AVC-DC400ST**



**EOS DIGITAL
Solution Disk**
(Software CD-ROM)



**Software
Instruction
Manual**
(CD-ROM)



**Camera
Instruction Manual**
(this booklet)

* Battery Charger LC-E8 or LC-E8E is provided. (The LC-E8E comes with a power cord.)

- If you purchased a Lens Kit, check that the lens is included.
- Depending on the Lens Kit type, the lens instruction manual might also be included.
- Be careful not to lose any of the above items.







Software Instruction Manual

The software Instruction Manuals are included in the CD-ROM as PDF files. See page 304 for instructions to look up manuals in the Software Instruction Manual.

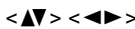





Conventions Used in this Manual

Icons in this Manual

-  : Indicates the Main Dial.
-  : Indicates the <⬆> cross keys.
-  : Indicates the setting button.
- , , ,  : Indicates that the respective function remains active for 4 sec., 6 sec., 10 sec., or 16 sec. respectively after you let go of the button.

* In this manual, the icons and markings indicating the camera's buttons, dials, and settings correspond to the icons and markings on the camera and on the LCD monitor.

- MENU** : Indicates a function which can be changed by pressing the <MENU> button and changing the setting.
- ★ : If shown on the upper right of the page, it indicates that the function is available only in the Creative Zone modes (p.22).
- (p.**): Reference page numbers for more information.
-  : Tip or advice for better shooting.
-  : Problem-solving advice.
-  : Warning to prevent shooting problems.
-  : Supplemental information.

Basic Assumptions

- All operations explained in this manual assume that the power switch has already been set to <ON> (p.32).
- It is assumed that all the menu settings and Custom Functions are set to the default.
- For explanatory purposes, the instructions show the camera attached with an EF-S18-55mm f/3.5-5.6 IS II lens.

Chapters

For first-time DSLR users, Chapters 1 and 2 explain the camera's basic operations and shooting procedures.

	Introduction	2
1	Getting Started	25
2	Basic Shooting and Image Playback	49
3	Creative Shooting	73
4	Advanced Shooting	93
5	Shooting with the LCD Monitor (Live View Shooting)	123
6	Shooting Movies	141
7	Handy Features	165
8	Wireless Flash Photography	189
9	Image Playback	201
10	Post-Processing Images	229
11	Printing Images	235
12	Customizing the Camera	249
13	Reference	259
14	Software Start Guide	301
15	Quick Reference Guide and Instruction Manual Index	305



Contents at a Glance

Shooting

- **Shoot automatically** → **p.49 - 63** (Basic Zone modes)
- **Shoot continuously** → **p.88** (📷 Continuous shooting)
- **Take a picture of yourself in a group** → **p.89** (🕒 Self-timer)
- **Freeze the action** → **p.94** (Tv Shutter-priority AE)
- **Blur the action**
- **Blur the background** → **p.56** (CA Creative Auto)
- **Keep the background in sharp focus** **p.96** (Av Aperture-priority AE)
- **Adjust the image brightness (exposure)** → **p.103** (Exposure compensation)
- **Shoot in low light** → **p.50, 90** (⚡ Flash photography)
p.79 (ISO speed setting)
- **Shoot without flash** → **p.55** (🚫 Flash Off)
p.58, 64 (☀️ Flash Off)
- **Photograph fireworks at night** → **p.100** (Bulb exposure)
- **Shoot while viewing the LCD monitor** → **p.124** (📺 Live View shooting)
- **Shoot movies** → **p.141** (🎬 Movie shooting)

Image Quality

- **Shoot with image effects matching the subject** → **p.81** (Selecting a Picture Style)
- **Make a large-size print of the picture** → **p.76** (▲L, ■L, RAW)





-
- **Take many pictures** → **p.76** (▲ S1, ▲ S1, S2, S3)

Focusing

-
- **Change the point of focus** → **p.85** (☒ AF point selection)
 - **Shoot a moving subject** → **p.62, 84** (AI Servo AF)

Playback

-
- **View the images with the camera** → **p.71** (▶ Playback)
 - **Search for pictures quickly** → **p.202** (☒ Index display)
→ **p.203** (📄 Image browsing)
 - **Rate images** → **p.206** (Ratings)
 - **Prevent important images from accidental deletion** → **p.222** (☒ Image protect)
 - **Delete unnecessary images** → **p.224** (🗑 Delete)
 - **Auto play images and movies** → **p.215** (Slide show)
 - **View the images or movies on a TV set** → **p.218** (Video OUT)
 - **Set the LCD monitor brightness** → **p.167** (LCD monitor brightness)

Printing

-
- **Print pictures easily** → **p.235** (Direct printing)



Index to Features

Power

- **Battery**
 - Charging → p.26
 - Installing/Removing → p.28
 - Battery check → p.33
- **Power outlet** → p.260
- **Auto power off** → p.32

Card

- **Inserting/Removing** → p.29
- **Format** → p.45
- **Release shutter without card** → p.166

Lens

- **Attaching/Detaching** → p.36
- **Zoom** → p.37
- **Image Stabilizer** → p.38

Basic Settings

- **Dioptic adjustment** → p.39
- **Language** → p.35
- **Date/Time** → p.34
- **Beeper** → p.166
- **Using the LCD monitor** → p.31
- **LCD Off/On** → p.179
- **LCD brightness adjustment** → p.167

Recording Images

- **Create/select a folder** → p.168
- **File No.** → p.170

Image Quality

- **Image-recording quality** → p.76
- **Picture Style** → p.81
- **White balance** → p.117
- **Color space** → p.121
- **Image enhancement features**
 - Auto Lighting Optimizer → p.109
 - Lens peripheral illumination correction → p.110
 - Noise reduction for long exposures → p.253
 - Noise reduction for high ISO speeds → p.254
 - Highlight tone priority → p.254

AF

- **AF mode** → p.83
- **AF point selection** → p.85
- **Manual focusing** → p.87

Drive

- **Drive modes** → p.20
- **Continuous shooting** → p.88
- **Self-timer** → p.89
- **Maximum burst** → p.77

Shooting

- **ISO speed** → p.79
- **Feature guide** → p.48
- **Quick Control** → p.41
- **Creative Auto** → p.56
- **Program AE** → p.74
- **Shutter-priority AE** → p.94
- **Aperture-priority AE** → p.96
- **Manual exposure** → p.99
- **Bulb** → p.100

- **Mirror lockup** → p.122
- **Automatic Depth-of-field AE** → p.101
- **Metering mode** → p.102
- **Remote control** → p.261

Exposure Adjustments

- **Exposure compensation** → p.103
- **AEB** → p.105
- **AE lock** → p.107

Flash

- **Built-in flash** → p.90
 - Flash exposure compensation → p.104
 - FE lock → p.108
- **External flash** → p.263
- **Flash control** → p.180
 - Wireless flash → p.189

Live View Shooting

- **Live View shooting** → p.123
- **Focusing** → p.131
- **Aspect ratio** → p.129
- **Grid display** → p.129
- **Quick Control** → p.128

Shooting Movies

- **Movie shooting** → p.141
- **Quick Control** → p.149
- **Sound recording** → p.160
- **Grid display** → p.161
- **Video snapshot** → p.153
- **Movie digital zoom** → p.152
- **Manual exposure** → p.144

Image Playback

- **Image review time** → p.166
- **Single image display** → p.71
 - Shooting information display → p.226
- **Index display** → p.202
- **Image browsing (Jump display)** → p.203
- **Magnify** → p.204
- **Rotate** → p.205
- **Ratings** → p.206
- **Movie playback** → p.212
 - Editing out movie's first/last scene → p.214
- **Slide show** → p.215
- **Viewing images on TV** → p.218
- **Protect** → p.222
- **Erase** → p.224
- **Quick Control** → p.208

Image Editing

- **Creative filters** → p.230
- **Resize** → p.233

Printing

- **PictBridge** → p.235
- **Print Order (DPOF)** → p.245













Customization

- **Custom Functions (C.Fn)** → p.250
- **My Menu** → p.258

Software

- **Install** → p.303
- **Software Instruction Manual** → p.304

Contents

Introduction	2
Item Check List.....	3
Conventions Used in this Manual	4
Chapters	5
Contents at a Glance.....	6
Index to Features	8
Handling Precautions	14
Quick Start Guide.....	16
Nomenclature	18
1 Getting Started	25
Charging the Battery	26
Installing and Removing the Battery.....	28
Installing and Removing the Card	29
Using the LCD Monitor	31
Turning on the Power	32
Setting the Date and Time.....	34
Selecting the Interface Language.....	35
Attaching and Detaching a Lens	36
About the Lens Image Stabilizer.....	38
Basic Operation.....	39
 Quick Control for Shooting Functions	41
 Menu Operations.....	43
Formatting the Card.....	45
Switching the LCD Monitor Display	47
Feature Guide	48
2 Basic Shooting and Image Playback	49
 Fully Automatic Shooting (Scene Intelligent Auto).....	50
 Full Auto (Scene Intelligent Auto) Techniques.....	53
 Disabling Flash.....	55
 Creative Auto Shooting	56
 Shooting Portraits.....	59
 Shooting Landscapes.....	60
 Shooting Close-ups	61
 Shooting Moving Subjects.....	62
 Shooting Portraits at Night	63
 Quick Control	64
Shoot by Ambience Selection.....	65
Shoot by Lighting or Scene Type	68
 Image Playback.....	71

3 Creative Shooting 73

P : Program AE	74
Setting the Image-recording Quality	76
ISO: Changing the ISO Speed	79
Selecting the Subject's Optimal Image Characteristics (Picture Style)	81
AF : Changing the Autofocus Mode (AF Mode)	83
Selecting the AF Point	85
Subjects Difficult to Focus	87
MF : Manual Focusing	87
Continuous Shooting	88
Using the Self-timer	89
Using the Built-in Flash	90





4 Advanced Shooting 93

Tv : Action Shots	94
Av : Changing the Depth of Field	96
Depth of Field Preview	98
M : Manual Exposure	99
A-DEP : Automatic Depth-of-Field AE	101
Changing the Metering Mode	102
Av Setting Exposure Compensation	103
Auto Exposure Bracketing (AEB)	105
Locking the Exposure (AE Lock)	107
Locking the Flash Exposure (FE Lock)	108
Correcting the Brightness and Contrast Automatically (Auto Lighting Optimizer)	109
Correcting the Image's Dark Corners	110
Customizing Image Characteristics (Picture Style)	112
Registering Preferred Image Characteristics (Picture Style)	115
WB : Matching the Light Source (White Balance)	117
Adjusting the Color Tone for the Light Source	119
Setting the Color Reproduction Range (Color Space)	121
Mirror Lock-up to Reduce Camera Shake	122

5 Shooting with the LCD Monitor (Live View Shooting) 123

Shooting with the LCD Monitor	124
Shooting Function Settings	128
Menu Function Settings	129
Changing the Autofocus Mode	131
MF : Focusing Manually	138

6	Shooting Movies	141
	▶ Shooting Movies.....	142
	Shooting Function Settings	149
	Setting the Movie-recording Size.....	150
	Using Movie Digital Zoom.....	152
	Taking Video Snapshots	153
	Menu Function Settings.....	157
7	Handy Features	165
	Handy Features.....	166
	Silencing the Beeper	166
	Card Reminder	166
	Setting the Image Review Time	166
	Setting the Auto Power-off Time.....	167
	Adjusting the LCD Monitor Brightness	167
	Creating and Selecting a Folder.....	168
	File Numbering Methods	170
	Setting Copyright Information.....	172
	Auto Rotation of Vertical Images	174
	INFO. Checking Camera Settings	175
	Reverting the Camera to the Default Settings.....	176
	Turning the LCD Monitor Off/On.....	179
	Changing the Shooting Settings Screen Color.....	179
	Setting the Flash	180
	▶ Automatic Sensor Cleaning.....	184
	Appending Dust Delete Data	185
	Manual Sensor Cleaning	187
8	Wireless Flash Photography	189
	Using Wireless Flash.....	190
	Easy Wireless Flash Shooting.....	191
	Custom Wireless Flash Shooting	194
	Other Settings	198
9	Image Playback	201
	🔍🔍 Searching for Images Quickly.....	202
	🔍/🔍 Magnified View	204
	🔄 Rotating the Image.....	205
	Setting Ratings	206
	🔍 Quick Control During Playback.....	208
	▶ Enjoying Movies	210

 Playing Movies	212
 Editing a Movie's First and Last Scenes	214
Slide Show (Auto Playback)	215
Viewing the Images on TV	218
 Protecting Images	222
 Erasing Images	224
INFO. Shooting Information Display	226

10 Post-Processing Images 229

 Creative Filters	230
 Resize	233

11 Printing Images 235

Preparing to Print	236
 Printing	238
Trimming the Image	243
 Digital Print Order Format (DPOF)	245
 Direct Printing with DPOF	248

12 Customizing the Camera 249

Setting Custom Functions	250
Custom Function Settings	252
Registering My Menu	258

13 Reference 259

Using a Household Power Outlet	260
Remote Control Shooting	261
External Speedlites	263
Using Eye-Fi Cards	265
Function Availability Table According to Shooting Modes	268
Menu Settings	270
System Map	276
Troubleshooting Guide	278
Error Codes	287
Specifications	288
Safety Warnings	297

14 Software Start Guide 301

Software Start Guide	302
----------------------------	-----

15 Quick Reference Guide and Instruction Manual Index 305

Quick Reference Guide	306
Index	318

Handling Precautions

Camera Care

- This camera is a precision instrument. Do not drop it or subject it to physical shock.
- The camera is not waterproof and cannot be used underwater. If you accidentally drop the camera into water, promptly consult your nearest Canon Service Center. Wipe off any water droplets with a dry cloth. If the camera has been exposed to salty air, wipe it with a well-wrung wet cloth.
- Never leave the camera near anything having a strong magnetic field such as a magnet or electric motor. Also avoid using or leaving the camera near anything emitting strong radio waves such as a large antenna. Strong magnetic fields can cause camera misoperation or destroy image data.
- Do not leave the camera in excessive heat such as in a car in direct sunlight. High temperatures can cause the camera to malfunction.
- The camera contains precision electronic circuitry. Never attempt to disassemble the camera yourself.
- Use a blower to blow away dust on the lens, viewfinder, reflex mirror, and focusing screen. Do not use cleaners that contain organic solvents to clean the camera body or lens. For stubborn dirt, take the camera to the nearest Canon Service Center.
- Do not touch the camera's electrical contacts with your fingers. This is to prevent the contacts from corroding. Corroded contacts can cause camera misoperation.
- If the camera is suddenly brought in from the cold into a warm room, condensation may form on the camera and internal parts. To prevent condensation, first put the camera in a sealed plastic bag and let it adjust to the warmer temperature before taking it out of the bag.
- If condensation forms on the camera, do not use the camera. This is to avoid damaging the camera. If there is condensation, remove the lens, card and battery from the camera, and wait until the condensation has evaporated before using the camera.
- If the camera will not be used for an extended period, remove the battery and store the camera in a cool, dry, well-ventilated location. Even while the camera is in storage, press the shutter button a few times once in a while to check that the camera is still working.
- Avoid storing the camera where there are corrosive chemicals such as a darkroom or chemical lab.
- If the camera has not been used for an extended period, test all its functions before using it. If you have not used the camera for some time or if there is an important shoot coming up, have the camera checked by your Canon dealer or check the camera yourself and make sure it is working properly.

LCD Monitor

- Although the LCD monitor is manufactured with very high precision technology with over 99.99% effective pixels, there might be a few dead pixels among the remaining 0.01% or less pixels. Dead pixels displaying only black or red, etc., are not a malfunction. They do not affect the images recorded.
- If the LCD monitor is left on for a prolonged period, screen burn-in may occur where you see remnants of what was displayed. However, this is only temporary and will disappear when the camera is left unused for a few days.
- In low or high temperatures, the LCD monitor display may seem slow or it might look black. It will return to normal at room temperature.

Cards

To protect the card and its recorded data, note the following:

- Do not drop, bend, or wet the card. Do not subject it to excessive force, physical shock, or vibration.
- Do not touch the card's electronic contacts with your fingers or anything metallic.
- Do not store or use the card near anything having a strong magnetic field such as a TV set, speakers, or magnet. Also avoid places prone to having static electricity.
- Do not leave the card in direct sunlight or near a heat source.
- Store the card in a case.
- Do not store the card in hot, dusty, or humid locations.

Lens

After detaching the lens from the camera, attach the lens caps or put down the lens with the rear end up to avoid scratching the lens surface and electrical contacts.

Cautions During Prolonged Use

If you use continuous shooting, Live View shooting, or movie shooting for a prolonged period, the camera may become hot. Although this is not a malfunction, holding the hot camera for a long period can cause slight skin burns.



About smudges adhering to the front of the sensor

Besides dust entering the camera from outside, in rare cases lubricant from the camera's internal parts may adhere to the front of the sensor. In case visible spots still remain after the automatic sensor cleaning, having the sensor cleaned by a Canon Service Center is recommended.

Quick Start Guide

1

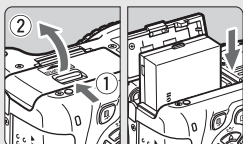

Insert the battery. (p.28)

- To charge the battery, see page 26.

2

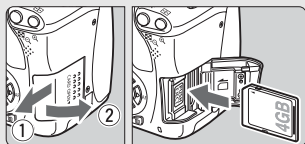

Insert a card. (p.29)

- With the card's label facing toward the camera back, insert it into the slot.

3

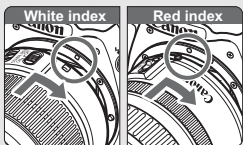

Attach the lens. (p.36)

- Align the lens' white or red index with the camera's index in the matching color.

4

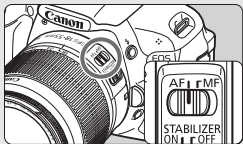

Set the lens focus mode switch to <AF>. (p.36)

5

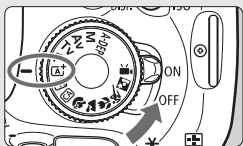

Set the power switch to <ON>, and set the Mode Dial to <AI+> (Scene Intelligent Auto). (p.50)

- All the necessary camera settings will be set automatically.

6

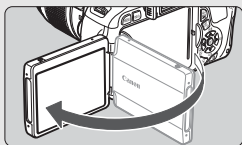
**Flip out the LCD monitor.** (p.31)

- When the LCD monitor displays the date/time setting screen, see page 34.

7

**Focus the subject.** (p.40)

- Look through the viewfinder and aim the viewfinder center over the subject.
- Press the shutter button halfway, and the camera will focus the subject.
- If necessary, the built-in flash will pop-up automatically.

8

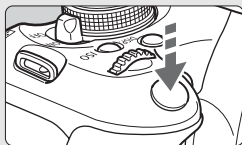
**Take the picture.** (p.40)

- Press the shutter button completely to take the picture.

9

**Review the picture.** (p.166)

- The captured image will be displayed for approx. 2 sec. on the LCD monitor.
- To display the image again, press the <▶> button (p.71).
- To shoot while looking at the LCD monitor, see “Live View Shooting” (p.123).
- To view the images captured so far, see “Image Playback” (p.71).
- To delete an image, see “Erasing Images” (p.224).

Nomenclature

The names in bold indicate the parts mentioned up until the “Basic Shooting and Image Playback” section.

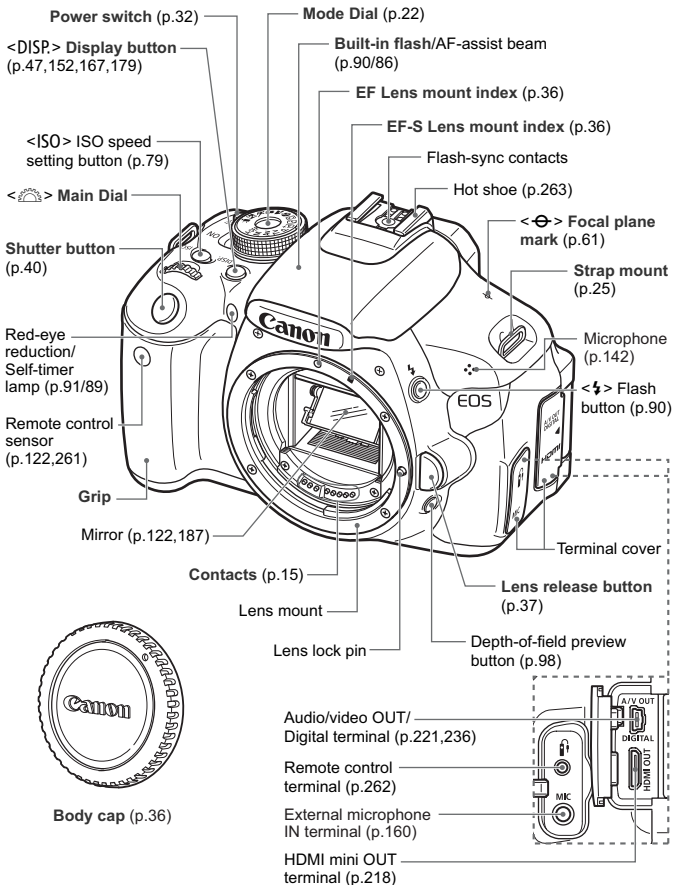

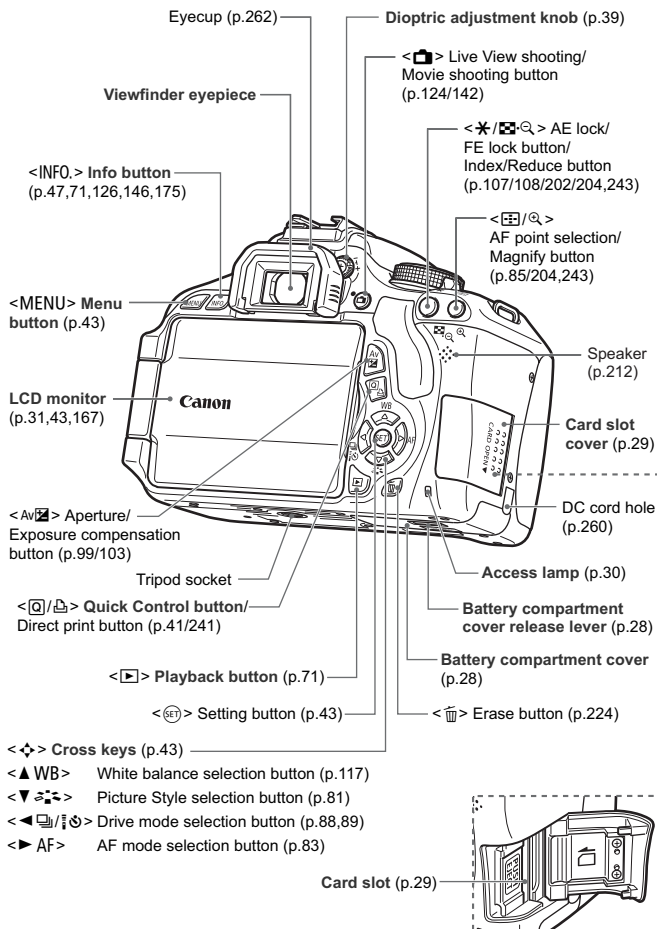

Shooting Settings Display (in Creative Zone modes, p.22)

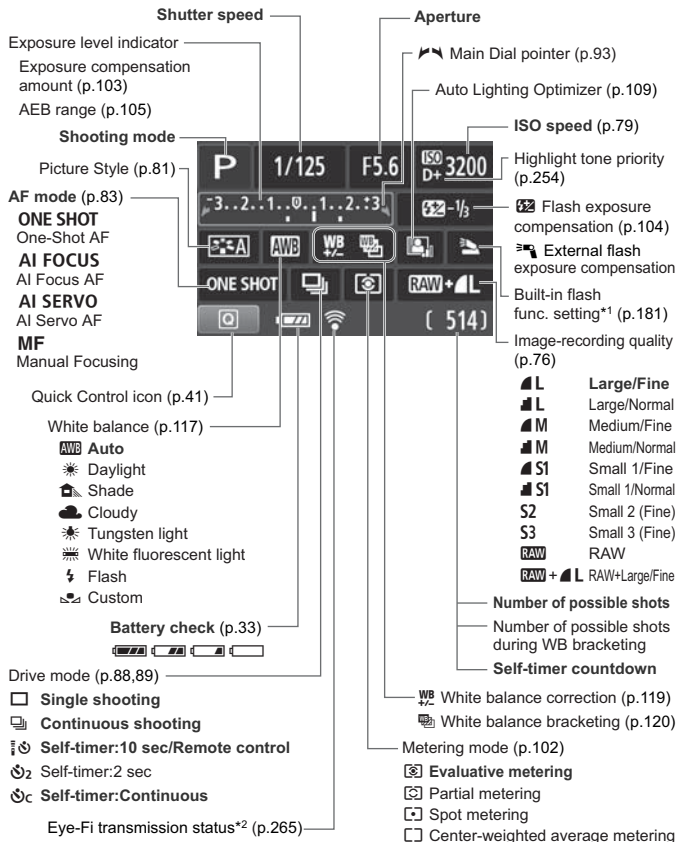

*1: Displayed when the built-in flash is popped up.

*2: Displayed if an Eye-Fi card is used.

The display will show only the settings currently applied.

Viewfinder Information

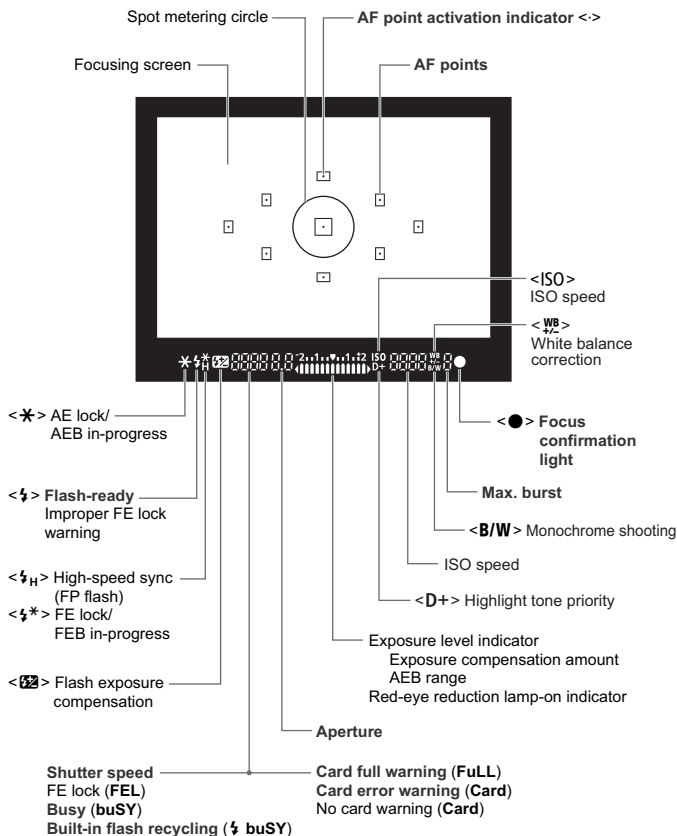

The display will show only the settings currently applied.

Mode Dial

The Mode Dial includes the Basic Zone modes, Creative Zone modes, and the Movie shooting mode.

Creative Zone

These modes give you more control for shooting various subjects.

- P** : Program AE (p.74)
- Tv** : Shutter-priority AE (p.94)
- Av** : Aperture-priority AE (p.96)
- M** : Manual exposure (p.99)
- A-DEP**: Automatic depth-of-field AE (p.101)

Basic Zone

All you do is press the shutter button. The camera sets everything to suit the subject.

- A+** : **Scene Intelligent Auto** (p.50)
- [Flash Off]** : **Flash Off** (p.55)
- CA** : **Creative Auto** (p.56)

Image Zone

- [Portrait]** : **Portrait** (p.59)
- [Landscape]** : **Landscape** (p.60)
- [Close-up]** : **Close-up** (p.61)
- [Sports]** : **Sports** (p.62)
- [Night Portrait]** : **Night Portrait** (p.63)

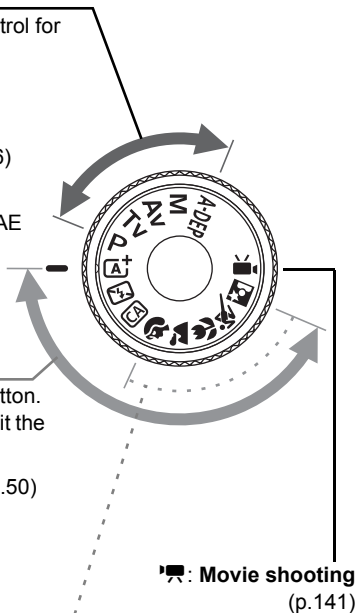

Lens

Lens without a distance scale

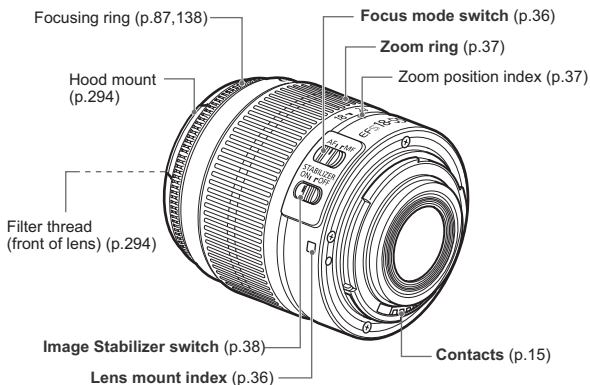

Lens with a distance scale

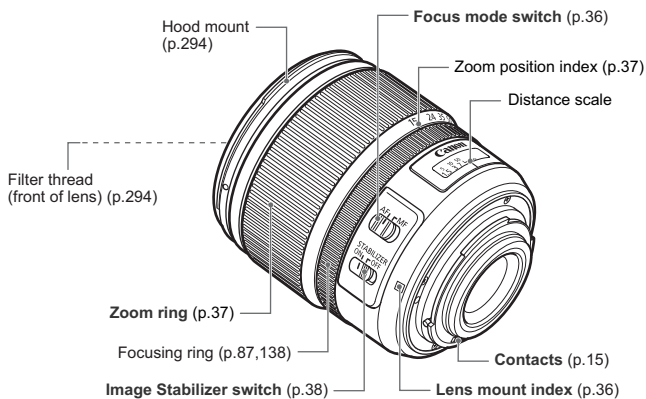

Battery Charger LC-E8

Charger for Battery Pack LP-E8 (p.26).

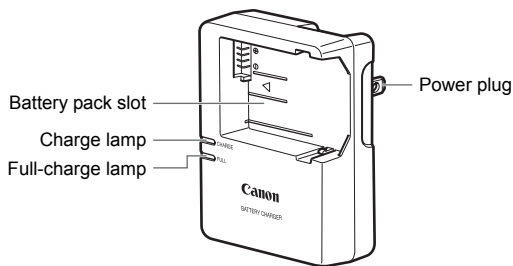

Battery Charger LC-E8E

Charger for Battery Pack LP-E8 (p.26).

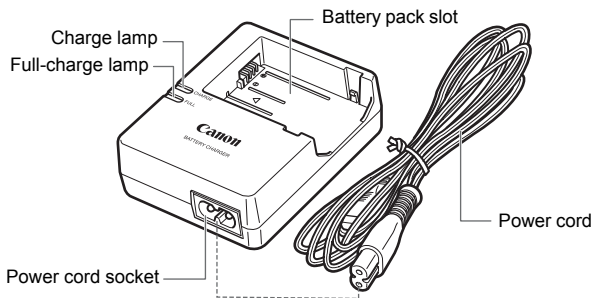

1

Getting Started

This chapter explains preparatory steps before you start shooting and basic camera operations.

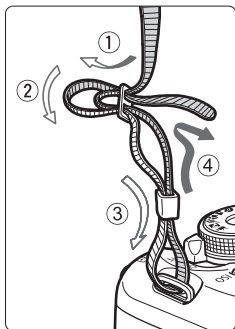

Attaching the Strap

Pass the end of the strap through the camera's strap mount eyelet from the bottom. Then pass it through the strap's buckle as shown in the illustration. Pull the strap to take up any slack and make sure the strap will not loosen from the buckle.

- The eyepiece cover is also attached to the strap (p.262).

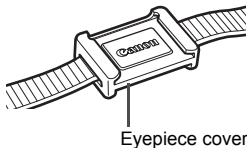

Charging the Battery

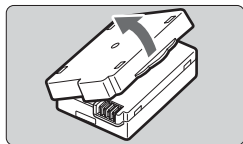

- 1 Remove the protective cover.**
- Detach the protective cover provided with the battery.

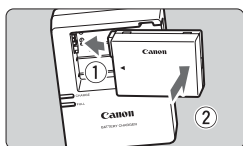

- 2 Attach the battery.**
- As shown in the illustration, attach the battery securely to the charger.
 - To detach the battery, follow the above procedure in reverse.

LC-E8

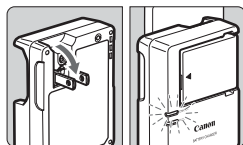

- 3 Recharge the battery.**
For LC-E8

- As shown by the arrow, flip out the battery charger's prongs and insert the prongs into a power outlet.

LC-E8E

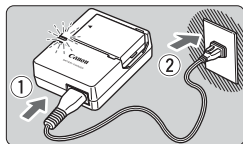

For LC-E8E

- Connect the power cord to the charger and insert the plug into the power outlet.
 - ▶ Recharging starts automatically and the charge lamp turns orange.
 - ▶ When the battery is fully recharged, the full-charge lamp will turn green.
- It takes approx. 2 hours to fully recharge a completely exhausted battery at 23°C / 73°F. The time required to recharge the battery depends on the ambient temperature and the battery's charge level.
 - For safety reasons, recharging in low temperatures (6°C - 10°C / 43°F - 50°F) will take a longer time (up to 4 hours).



Tips for Using the Battery and Charger

- **Upon purchase, the battery is not fully charged.**
Recharge the battery before using.
 - **Recharge the battery on the day before or on the day it is to be used.**
Even during storage, a charged battery will gradually drain and lose its power.
 - **After recharging the battery, detach it and unplug the charger from the power outlet.**
 - **When not using the camera, remove the battery.**
If the battery is left in the camera for a prolonged period, a small amount of power current is released, resulting in excess discharge and shorter battery life. Store the battery with the protective cover (provided) attached. Storing the battery after it is fully charged can lower the battery's performance.
 - **The battery charger can also be used in foreign countries.**
The battery charger is compatible with a 100 V AC to 240 V AC 50/60 Hz power source. If necessary, attach a commercially-available plug adapter for the respective country or region. Do not attach any portable voltage transformer to the battery charger. Doing so can damage the battery charger.
 - **If the battery becomes exhausted quickly even after being fully charged, the battery has reached the end of its service life.**
Purchase a new battery.
-
- After disconnecting the charger's power plug, do not touch the prongs for at least 3 sec.
 - Do not charge any battery other than a Battery Pack LP-E8.
 - The Battery Pack LP-E8 is dedicated to Canon products only. Using it with an incompatible battery charger or product may result in malfunction or accidents for which Canon cannot be held liable.

Installing and Removing the Battery

Installing the Battery

Load a fully charged Battery Pack LP-E8 into the camera.

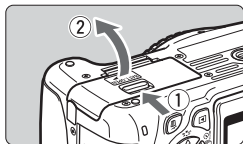

1 Open the cover.

- Slide the lever as shown by the arrows and open the cover.

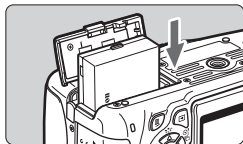

2 Insert the battery.

- Insert the end with the battery contacts.
- Insert the battery until it locks in place.

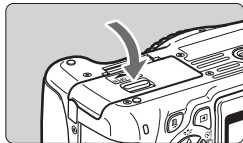

3 Close the cover.

- Press the cover until it snaps shut.

Removing the Battery

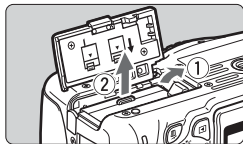

Open the cover and remove the battery.

- Press the battery release lever as shown by the arrow and remove the battery.
- To prevent short circuiting of the battery contacts, be sure to attach the protective cover (provided, p.26) to the battery.

ⓘ After opening the battery compartment cover, be careful not to swing it back further. Otherwise, the hinge might break.

Installing and Removing the Card

The card (sold separately) can be an SD, SDHC, or SDXC memory card. The captured images are recorded onto the card.

- **Make sure the card's write-protect switch is set upward to enable writing/erasing.**

Installing the Card

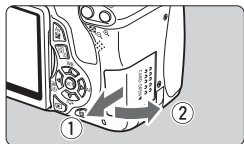

1 Open the cover.

- Slide the cover as shown by the arrows to open it.

Write-protect switch

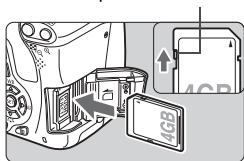

2 Insert the card.

- As shown by the illustration, face the card's label side toward you and insert it until it clicks in place.

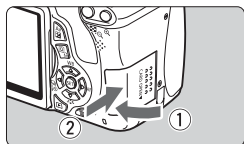

3 Close the cover.

- Close the cover and slide it in the direction shown by the arrows until it snaps shut.
- When you set the power switch to <ON>, the number of possible shots (p.33) will be displayed on the LCD monitor.



Possible shots



- The number of possible shots depends on the remaining capacity of the card, image-recording quality, ISO speed, etc.
- Setting [Release shutter without card] to [Disable] will prevent you from forgetting to insert a card (p.166).

Removing the Card

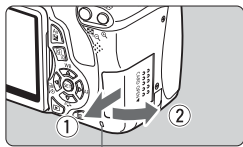

Access lamp

1 Open the cover.

- Set the power switch to <OFF>.
- **Make sure the access lamp is off, then open the cover.**
- If “Recording ...” is displayed, close the cover.

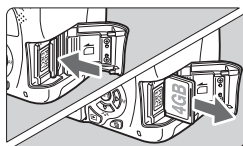

2 Remove the card.

- Gently push in the card, then let go. The card will stick out.
- Pull the card straight out, then close the cover.

- **When the access lamp is lit or blinking, it indicates that images are being written to or read by the card, being erased, or data is being transferred. Do not open the card slot cover during this time. Also, never do any of the following while the access lamp is lit or blinking. Otherwise, it can damage the image data, card, or camera.**
 - Removing the card.
 - Removing the battery.
 - Shaking or banging the camera around.
- If the card already contains recorded images, the image number might not start from 0001 (p.170).
- Do not touch the card's contacts with your fingers or metal objects.
- If a card-related error message is displayed on the LCD monitor, remove and reinsert the card. If the error persists, use a different card. If you can transfer all the images on the card to a computer, transfer all the images and then format the card with the camera (p.45). The card may then return to normal.

Using the LCD Monitor

After you flip out the LCD monitor, you can set menu functions, use Live View shooting, shoot movies, and playback images and movies. You can change the direction and angle of the LCD monitor.

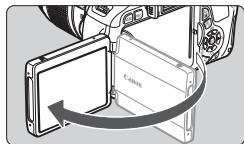

1 Flip out the LCD monitor.

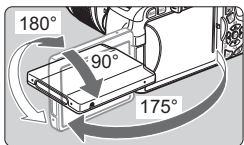

2 Rotate the LCD monitor.

- When the LCD monitor is swung out, you can rotate it up or down or face it forward toward the subject.
- The indicated angle is only approximate.

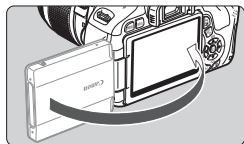

3 Face it toward you.

- Normally, face the LCD monitor toward you.



Be careful not to force and break the hinge when rotating the LCD monitor.



- When not using the camera, close the LCD monitor back with the screen facing inward. This will protect the screen.
- During Live View shooting or movie shooting, facing the LCD monitor toward the subject will display a mirror image on the screen.
- Depending on the angle of the LCD monitor, the display may turn off right before the LCD monitor is closed.

Turning on the Power

If you turn on the power switch and the date/time setting screen appears, see page 34 to set the date/time.

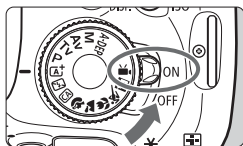

- <ON> : The camera turns on.
- <OFF> : The camera is turned off and does not operate. Set to this position when not using the camera.

About the Automatic Self-Cleaning Sensor

- Whenever you set the power switch to <ON> or <OFF>, the sensor cleaning will be executed automatically. During the sensor cleaning, the LCD monitor will display <☐>. Even during the sensor cleaning, you can still shoot by pressing the shutter button halfway (p.40) to stop the sensor cleaning and take a picture.
- If you repeatedly turn the power switch <ON>/<OFF> at a short interval, the <☐> icon might not be displayed. This is normal and not a problem.

MENU About Auto Power Off





- To save battery power, the camera turns off automatically after about 30 seconds of non-operation. To turn on the camera again, just press the shutter button halfway (p.40).
- You can change the auto power-off time with [**☑** Auto power off] (p.167).

 If you set the power switch to <OFF> while an image is being recorded to the card, [**Recording ...**] will be displayed and the power will turn off after the card finishes recording the image.

Checking the Battery Level

When the power switch is set to <ON>, the battery level will be indicated in one of four levels:



-  : Battery level is OK.
-  : Battery level is low, but still enough for now.
-  : Battery will be exhausted soon. (Blinks)
-  : Battery must be recharged.

Battery Life

Temperature	At 23°C / 73°F	At 0°C / 32°F
No Flash	Approx. 550 shots	Approx. 470 shots
50% Flash Use	Approx. 440 shots	Approx. 400 shots

- The figures above are based on a fully-charged Battery Pack LP-E8, no Live View shooting, and CIPA (Camera & Imaging Products Association) testing standards.
- The Battery Grip BG-E8 approximately doubles the number of possible shots with two LP-E8 batteries installed. With size-AA/LR6 alkaline batteries, the number of possible shots at 23°C / 73°F is approx. 470 shots without flash use and approx. 270 shots with 50% flash use.



- The number of possible shots will decrease with any of the following operations:
 - Pressing the shutter button halfway for a prolonged period.
 - Often activating only the AF without taking a picture.
 - Using the LCD monitor often.
 - Using the lens Image Stabilizer.
- The lens operation is powered by the camera's battery. Depending on the lens used, the number of possible shots may be lower.
- For the number of possible shots with Live View shooting, see page 125.

MENU Setting the Date and Time

When you turn on the power for the first time or if the date/time has been reset, the Date/Time setting screen will appear. Follow steps 3 and 4 to set the date/time. **Note that the date/time appended to recorded images will be based on this date/time setting. Be sure to set the correct date/time.**

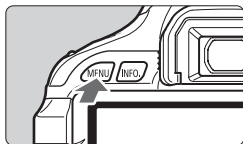

1 Display the menu screen.

- Press the <MENU> button to display the menu screen.



2 Under the [☺] tab, select [Date/Time].

- Press the <◀▶> key to select the [☺] tab.
- Press the <▲▼> key to select [Date/Time], then press <SET>.

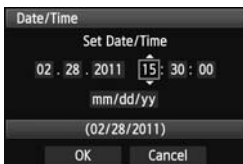

3 Set the date and time.

- Press the <◀▶> key to select the date or time number.
- Press <SET> so <☑> is displayed.
- Press the <▲▼> key to set the number, then press <SET>. (Returns to □.)

4 Exit the setting.

- Press the <◀▶> key to select [OK], then press <SET>.
- ▶ The date/time will be set.

! If you store the camera without the battery or if the camera's battery becomes exhausted, the date/time might be reset. If this happens, set the date/time again.

i The date/time set will start from when you press <SET> in step 4.

MENU Selecting the Interface Language

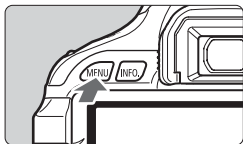

1 Display the menu screen.

- Press the <MENU> button to display the menu screen.

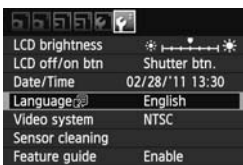

2 Under the [Language] tab, select [Language].

- Press the <◀▶> key to select the [Language] tab.
- Press the <▲▼> key to select [Language] (the fourth item from the top), then press <SET>.



3 Set the desired language.

- Press the <◆> key to select the language, then press <SET>.
- ▶ The interface language will change.

English	Norsk	Română
Deutsch	Svenska	Türkçe
Français	Español	العربية
Nederlands	Ελληνικά	ภาษาไทย
Dansk	Русский	简体中文
Português	Polski	繁體中文
Suomi	Čeština	한국어
Italiano	Magyar	日本語
Українська		

Attaching and Detaching a Lens

Attaching a Lens

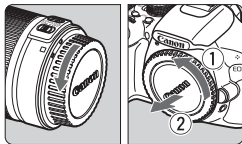

1 Remove the caps.

- Remove the rear lens cap and the body cap by turning them as shown by the arrows.

White index

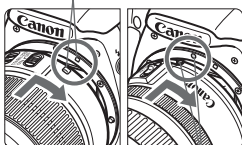

2 Attach the lens.

- Align the lens' red or white index with the camera's index matching the same color. Turn the lens as shown by the arrow until it snaps in place.

Red index

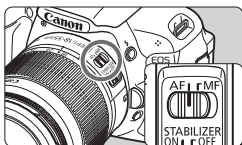

3 On the lens, set the focus mode switch to <AF> (autofocus).

- If it is set to <MF> (manual focus), autofocus will not operate.

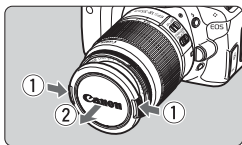

4 Remove the front lens cap.

Minimizing Dust

- When changing lenses, do it in a place with minimal dust.
- When storing the camera without a lens attached, be sure to attach the body cap to the camera.
- Remove dust on the body cap before attaching it.

About Zooming

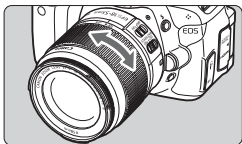

To zoom, turn the zoom ring on the lens with your fingers.

If you want to zoom, do it before focusing. Turning the zoom ring after achieving focus may throw off the focus slightly.

Detaching the Lens

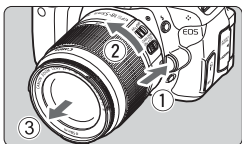

While pressing the lens release button, turn the lens as shown by the arrow.

- Turn the lens until it stops, then detach it.
- Attach the rear lens cap to the detached lens.



- Do not look at the sun directly through any lens. Doing so may cause loss of vision.
- If the front part (focusing ring) of the lens rotates during autofocus, do not touch the rotating part.



Image Conversion Factor

Since the image sensor size is smaller than the 35mm film format, it will look like the lens focal length is increased by approx. 1.6x.

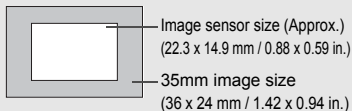

About the Lens Image Stabilizer

When you use the IS lens' built-in Image Stabilizer, camera shake is corrected to obtain a sharper shot. The procedure explained here is based on the EF-S18-55mm f/3.5-5.6 IS II lens as an example.

* IS stands for Image Stabilizer.

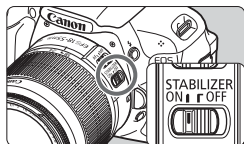

- 1 Set the IS switch to <ON>.**
 - Set also the camera's power switch to <ON>.
- 2 Press the shutter button halfway.**
 - ▶ The Image Stabilizer will operate.
- 3 Take the picture.**
 - When the picture looks steady in the viewfinder, press the shutter button completely to take the picture.

- ⚠ The Image Stabilizer may not be effective if the subject moves at the time of exposure.
- The Image Stabilizer may not be effective for excessive shaking such as on a rocking boat.

- 📄 The Image Stabilizer can operate with the focus mode switch set to either <AF> or <MF>.
- If the camera is mounted on a tripod, you can save battery power by switching the IS switch to <OFF>.
- The Image Stabilizer is effective even when the camera is mounted on a monopod.
- Some IS lenses enable you to switch the IS mode manually to suit the shooting conditions. However, the following lenses switch the IS mode automatically:
 - EF-S18-55mm f/3.5-5.6 IS II
 - EF-S18-135mm f/3.5-5.6 IS
 - EF-S15-85mm f/3.5-5.6 IS USM
 - EF-S18-200mm f/3.5-5.6 IS

Basic Operation

Adjusting the Viewfinder Clarity

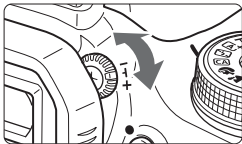

Turn the dioptic adjustment knob.

- Turn the knob left or right until the nine AF points in the viewfinder look sharp.



If the camera's dioptic adjustment still cannot provide a sharp viewfinder image, using Dioptic Adjustment Lens E (10 types, sold separately) is recommended.

Holding the Camera

To obtain sharp images, hold the camera still to minimize camera shake.

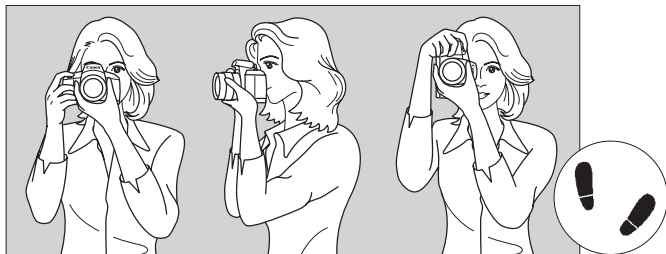

Horizontal shooting

Vertical shooting

1. Wrap your right hand around the camera grip firmly.
2. Hold the lens bottom with your left hand.
3. Press the shutter button lightly with your right hand's index finger.
4. Press your arms and elbows lightly against the front of your body.
5. To maintain a stable stance, place one foot in front of the other.
6. Press the camera against your face and look through the viewfinder.



To shoot while looking at the LCD monitor, see page 123.

Shutter Button

The shutter button has two steps. You can press the shutter button halfway. Then you can further press the shutter button completely.

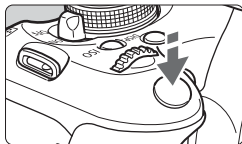

Pressing halfway

This activates autofocus and the automatic exposure system that sets the shutter speed and aperture.

The exposure setting (shutter speed and aperture) is displayed in the viewfinder (4).

While you press the shutter button halfway, the LCD monitor will turn off (p.179).

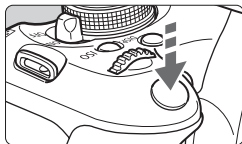

Pressing completely

This releases the shutter and takes the picture.

Preventing Camera Shake

Hand-held camera movement during the moment of exposure is called camera shake. It can cause blurred pictures. To prevent camera shake, note the following:

- Hold and steady the camera as shown on the previous page.
- Press the shutter button halfway to autofocus, then slowly press the shutter button completely.



- If you press the shutter button completely without pressing it halfway first or if you press the shutter button halfway and then press it completely immediately, the camera will take a moment before it takes the picture.
- Even during the menu display, image playback, and image recording, you can instantly go back to shooting-ready by pressing the shutter button halfway.

Q Quick Control for Shooting Functions

You can directly select and set the shooting functions displayed on the LCD monitor. This is called the Quick Control screen.



1 Press the <Q> button.

- ▶ The Quick Control screen will appear (10).

2 Set the desired function.

- Press the <◇> key to select the function to be set.
- ▶ The selected function and Feature guide (p.48) will appear.
- Turn the <WHEEL> dial to change the setting.

Basic Zone modes



Creative Zone modes



3 Take the picture.

- Press the shutter button completely to take the picture.
- ▶ The captured image will be displayed.



For the functions settable in Basic Zone modes and the setting procedure, see page 64.

Settable Functions on Quick Control Screen

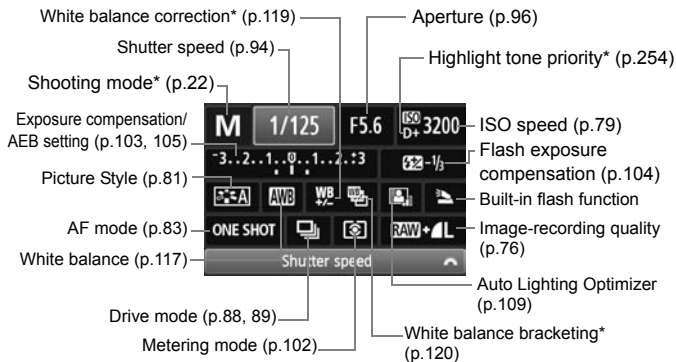

Asterisked functions cannot be set with the Quick Control screen.

Function Setting Screen

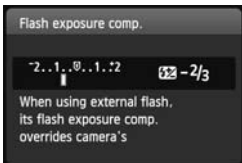

- Select the desired function and press <SET>. The function's setting screen will appear.
- Press the <◀▶> key or turn the <⚙> dial to change the setting. There are also functions to be set with the <INFO.> button.
- Press <SET> to finalize the setting and to return to the Quick Control screen.

MENU Menu Operations

With menus, you can set various functions such as the image-recording quality, date/time, etc. While looking at the LCD monitor, use the <MENU> button, <◀▶> cross keys, and <SET> button on the camera back to operate the menus.

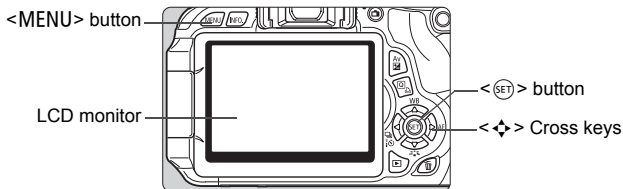

Menu Screen

In the Basic Zone, Movie shooting mode, and Creative Zone, the tabs and menu options displayed will be different.

Basic Zone modes

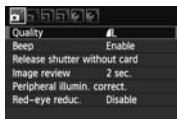

Movie shooting mode

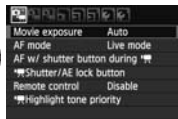

Creative Zone modes

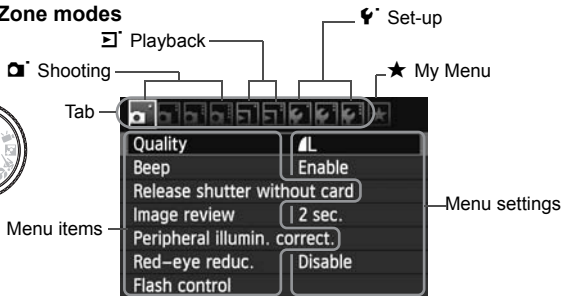

Menu Setting Procedure

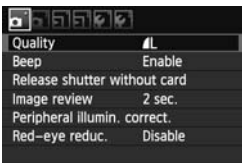

1 Display the menu screen.

- Press the <MENU> button to display the menu screen.

2 Select a tab.

- Press the <◀▶> key to select a menu tab.

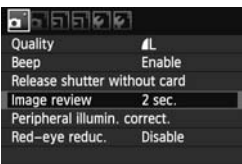

3 Select the desired item.

- Press the <▲▼> key to select the item, then press <SET>.

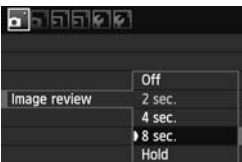

4 Select the setting.

- Press the <▲▼> or <◀▶> key to select the desired setting. (Some settings require you to press either the <▲▼> or <◀▶> key to select it.)
- The current setting is indicated in blue.

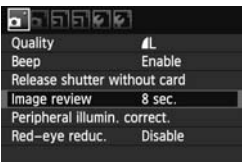

5 Set the desired setting.

- Press <SET> to set it.

6 Exit the setting.

- Press the <MENU> button to return to the shooting settings display.

- In step 2, you can also turn the <☀> dial to select a menu tab.
- The explanation of menu functions hereinafter assumes that you have pressed the <MENU> button to display the menu screen.
- For details about each menu item, see page 270.

MENU Formatting the Card

If the card is new or was previously formatted by another camera or computer, format the card with the camera.

- !** When the card is formatted, all images and data in the card will be erased. Even protected images will be erased, so make sure there is nothing you need to keep. If necessary, transfer the images to a computer, etc., before formatting the card.



1 Select [Format].

- Under the [] tab, select [Format], then press <SET>.



2 Format the card.

- Select [OK], then press <SET>.
- ▶ The card will be formatted.
- ▶ When the formatting is completed, the menu will reappear.
- For low-level formatting, press the < > button to checkmark [Low level format] with <✓>, then select [OK].





Execute [Format] in the following cases:

- The card is new.
- The card was formatted by a different camera or a computer.
- The card is full with images or data.
- A card-related error is displayed (p.287).

About Low-level Formatting

- Do low-level formatting if the card's recording or reading speed seems slow or if you want to totally erase all data in the card.
- Since low-level formatting will erase all recordable sectors in the card, the formatting will take slightly longer than normal formatting.
- You can stop the low-level formatting by selecting [**Cancel**]. Even in this case, normal formatting will have been completed and you can use the card as usual.



- When the card is formatted or data is erased, only the file management information is changed. The actual data is not completely erased. Be aware of this when selling or discarding the card. When discarding the card, execute low-level formatting or destroy the card physically to prevent the data from being leaked.
- **Before using a new Eye-Fi card, the software in the card must be installed in your computer. Then format the card with the camera.**



- The card capacity displayed on the card format screen might be smaller than the capacity indicated on the card.
- This device incorporates exFAT technology licensed from Microsoft.

Switching the LCD Monitor Display

The LCD monitor can display the shooting settings screen, menu screen, captured images, etc.

Shooting Settings

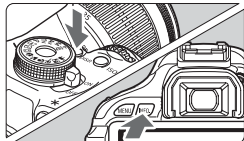

- When you turn on the power switch, the shooting settings will be displayed.
- **When you press the shutter button halfway, the display will turn off. And when you let go of the shutter button, the display will turn on.**
- **You can also turn off the display by pressing the <DISP.> button.** Press the button again to turn on the display.
- Pressing the <INFO.> button toggles between the shooting settings screen (p.20) and camera settings screen (p.175).

Menu Functions

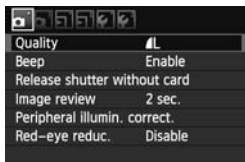

- Appears when you press the <MENU> button. Press the button again to return to the shooting settings screen.

Captured Image



- Appears when you press the <▶> button. Press the button again to return to the shooting settings screen.



- You can set [**🔊 LCD off/on btn**] so that the shooting settings display does not keep turning off and on (p.179).
- Even when the menu screen or captured image is displayed, pressing the shutter button will enable you to shoot immediately.

Feature Guide

The Feature guide is a simple description of the respective function or option. It is displayed when you change the shooting mode or use the Quick Control screen to set a shooting function, Live View shooting, movie shooting, or playback. When you select a function or option on the Quick Control screen, the Feature guide description is displayed. The Feature guide turns off when you further proceed with any operation.

● Shooting mode (Sample)



● Quick Control (Sample)



Shooting function



Live View shooting



Playback

MENU Disabling the Feature Guide

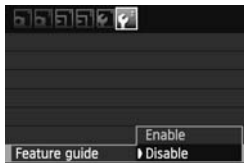

Select [Feature guide].

- Under the [**Feature guide**] tab, select [**Feature guide**], then press **<SET>**. Select [**Disable**], then press **<SET>**.

2

Basic Shooting and Image Playback

This chapter explains how to use the Basic Zone modes on the Mode Dial for best results and how to playback images.

With Basic Zone modes, all you do is point and shoot and the camera sets everything automatically (p.64, 268). Also, to prevent botched pictures due to mistaken operations, major shooting settings cannot be changed in fully-automatic modes.

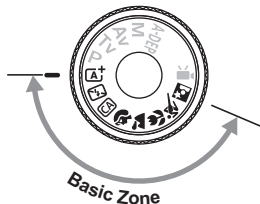

About the Auto Lighting Optimizer

In Basic Zone modes, the Auto Lighting Optimizer (p.109) will adjust the image automatically to obtain the optimum brightness and contrast. It is also enabled by default in Creative Zone modes.

[A⁺] Fully Automatic Shooting (Scene Intelligent Auto) ■

The camera analyzes the scene and sets the optimum settings automatically. It is a fully-automatic mode. Even with moving subjects, the camera will automatically continue to focus the subject (p.53).



AF point

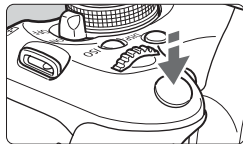
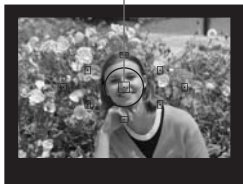

Focus confirmation light

1 Set the Mode Dial to **[A⁺]**.

2 Aim any AF point over the subject.

- All the AF points will be used to focus, and generally the closest object will be focused.
- Aiming the center AF point over the subject will make focusing easier.

3 Focus the subject.

- Press the shutter button halfway, and the lens focusing ring will rotate to focus.
- ▶ The dot inside the AF point achieving focus flashes briefly in red. At the same time, the beeper will sound and the focus confirmation light **[●]** in the viewfinder will light.
- ▶ If necessary, the built-in flash will pop-up automatically.



4 Take the picture.

- Press the shutter button completely to take the picture.
- ▶ The captured image will be displayed for approx. 2 sec. on the LCD monitor.
- If the built-in flash has popped up, you can push it back down with your fingers.



The **<A+>** mode makes the colors look more impressive in nature, outdoor, and sunset scenes. If the desired color tone is not obtained, use a Creative Zone mode and select a suitable Picture Style (p.81).



FAQ

- **The focus confirmation light **<●>** blinks and focus is not achieved.**
Aim the AF point over an area having good contrast, then press the shutter button halfway (p.40). If you are too close to the subject, move away and try again.
- **Sometimes multiple AF points flash simultaneously.**
This indicates that focus has been achieved at all those AF points. When the AF point covering the desired subject flashes, take the picture.
- **The beeper continues to beep softly. (The focus confirmation light **<●>** does not light.)**
It indicates that the camera is focusing continuously on a moving subject. (The focus confirmation light **<●>** does not light.) You can take sharp pictures of a moving subject.
- **Pressing the shutter button halfway does not focus the subject.**
If the focus mode switch on the lens is set to **<MF>** (Manual Focus), set it to **<AF>** (Auto Focus).

- **Although it is daylight, the flash popped up.**

For a backlit subject, the flash may pop up to help lighten the subject's dark areas.

- **In low light, the built-in flash fired a series of flashes.**

Pressing the shutter button halfway may trigger the built-in flash to fire a series of flashes to assist autofocusing. This is called AF-assist beam. Its effective range is about 4 meters/13.1 feet.

- **Although flash was used, the picture came out dark.**

The subject was too far away. The subject should be within 5 meters/16.4 feet from the camera.

- **When flash was used, the bottom part of the picture came out unnaturally dark.**

The subject was too close to the camera, and a shadow was created by the lens barrel. The subject should be at least 1 meter/3.3 feet away from the camera. If a hood has been attached to the lens, remove it before taking the flash picture.

[A⁺] Full Auto (Scene Intelligent Auto) Techniques

Recomposing the Shot



Depending on the scene, position the subject toward the left or right to create a balanced background and good perspective.

In the <[A⁺]> (Scene Intelligent Auto) mode, while you press the shutter button halfway to focus a still subject, the focus will be locked. You can then recompose the shot and press the shutter button completely to take the picture. This is called “focus lock”. Focus lock is also possible in other Basic Zone modes (except <[S]> Sports).

Shooting a Moving Subject



In the <[A⁺]> (Scene Intelligent Auto) mode, if the subject moves (distance to camera changes) during or after you focus, AI Servo AF will take effect to focus the subject continuously. As long as you keep aiming the AF point on the subject while pressing the shutter button halfway, the focusing will be continuous. When you want to take the picture, press the shutter button completely.

Live View Shooting

Live View shooting allows you to shoot while looking at the image on the LCD monitor. For details, see page 123.



1 Display the Live View image on the LCD monitor.

- Press the  button.
- ▶ The Live View image will appear on the LCD monitor.



2 Focus the subject.

- Aim the center AF point  on the subject.
- Press the shutter button halfway to focus.
- ▶ When focus is achieved, the AF point will turn green and the beeper will sound.

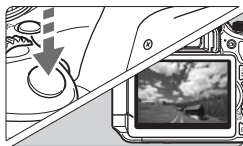

3 Take the picture.

- Press the shutter button completely.
- ▶ The picture will be taken and the captured image is displayed on the LCD monitor.
- ▶ After the image review ends, the camera will return to Live View shooting automatically.
- Press the  button to exit Live View shooting.

You can also rotate the LCD monitor in different directions (p.31).



Normal angle



Low angle



High angle

Disabling Flash

In places where flash photography is prohibited, use the  (Flash Off) mode. This mode is also effective for capturing the particular ambience of a scene, such as candlelight scenes.

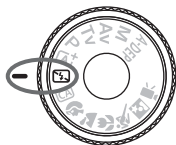

Shooting Tips

- **Prevent camera shake if the numeric display in the viewfinder blinks.**

Under low light when camera shake is prone to occur, the viewfinder's shutter speed display will blink. Hold the camera steady or use a tripod. When using a zoom lens, use the wide-angle end to reduce blur caused by camera shake.

- **Taking portraits without flash.**

In low-light conditions, tell the subject to keep still until the picture is taken. If the person moves during the exposure, he or she might look blurred in the picture.

CA Creative Auto Shooting

Unlike the <A+> Scene Intelligent Auto mode where the camera sets everything, the <CA> Creative Auto mode enables you to easily change the depth of field, drive mode, and flash firing.

You can also choose the ambience you want to convey in your images. The default settings are the same as the <A+> mode.

* CA stands for Creative Auto.



1 Set the Mode Dial to <CA>.

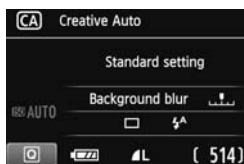

2 Press the <Q> button. (10)

▶ The Quick Control screen will appear.



3 Set the desired function.

- Press the <▲▼> key to select a function.
- ▶ The selected function and Feature guide (p.48) will be displayed.
- For details on setting each function, see pages 57-58.

4 Take the picture.

- Press the shutter button completely to take the picture.

 If you change the shooting mode or turn the power switch to <OFF>, the functions you have set on this screen will revert to their default setting. However, the self-timer and remote control settings will be retained.

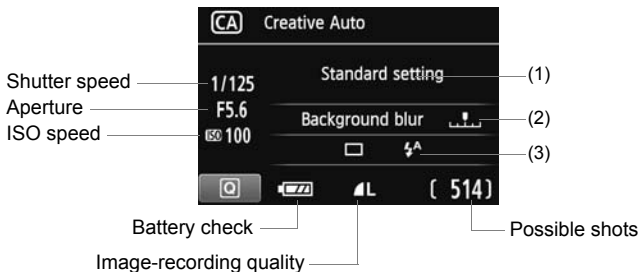

Pressing the **<Q>** button enables you to set the following:

(1) Shoot by ambience selection

You can set the ambience you want to convey in your images. Press the **<◀▶>** key or turn the **<⚙>** dial to select the desired ambience. You can also select it from a list by pressing **<SET>**. For details, see page 65.

(2) Blurring/sharpening the background



If you move the index mark toward the left, the background will look more blurred. If you move it toward the right, the background will look more in focus. If you want to blur the background, see “Shooting Portraits” on page 59. Press the **<◀▶>** key or turn the **<⚙>** dial to adjust it as desired.

Depending on the lens and shooting conditions, the background might not look so blurred. This function cannot be set (grayed out) while the built-in flash is raised in the **<⚡^>** or **<⚡>** mode. If flash is used, this setting will not be applied.

(3) Drive mode/Flash firing

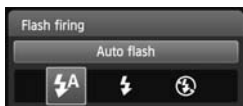
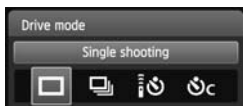

When you press <SET>, the drive mode or flash firing setting screen will appear. Set as desired, then press <SET> to finalize the setting and return to the Quick Control screen.

Drive mode: Press the <◀▶> key or turn the <⚙> dial to set it as desired.

<□> **Single shooting** : Shoot one image at a time.

<□|> **Continuous shooting:**

While you hold down the shutter button completely, shots will be taken continuously. You can shoot up to about 3.7 shots per sec.

<⏱> **Self-timer:10sec/Remote control** :

The picture is taken 10 seconds after you press the shutter button. A remote control can also be used.

<⚡C> **Self-timer:Continuous** :

Press the <▲▼> key to set the number of multiple shots (2 to 10) to be taken with the self-timer. 10 seconds after you press the shutter button, the set number of multiple shots will be taken.

Flash firing: Press the <◀▶> key or turn the <⚙> dial to set it as desired.

<⚡A> **Auto flash** : The flash fires automatically when necessary.

<⚡> **Flash on** : The flash fires at all times.

<⚡/> **Flash off** : The flash is disabled.

- When using <⏱> or <⚡C>, see the notes on page 89.
- When using <⚡/>, see "Disabling Flash" on page 55.

Shooting Portraits

The <Portrait> mode blurs the background to make the human subject stand out. It also makes skin tones and the hair look softer.

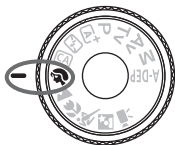

Shooting Tips

- **The further the distance between the subject and background, the better.**

The further the distance between the subject and background, the more blurred the background will look. The subject will also stand out better in front of a plain, dark background.

- **Use a telephoto lens.**

If you have a zoom lens, use the telephoto end to fill the frame with the subject from the waist up. Move in closer if necessary.

- **Focus the face.**

Check that the AF point covering the face flashes in red.



- If you hold down the shutter button, you can shoot continuously to obtain different poses and facial expressions. (max. approx. 3.7 shots/sec.)
- If necessary, the built-in flash will pop up automatically.

Shooting Landscapes

Use the <  > (Landscape) mode for wide scenery, night scenes, or to have everything in focus from near to far. For vivid blues and greens, and very sharp and crisp images.

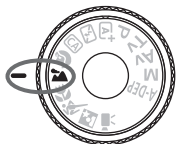



Shooting Tips

- **With a zoom lens, use the wide-angle end.**

When using the wide-angle end of a zoom lens, objects near and far will be in focus better than at the telephoto end. It also adds breadth to landscapes.

- **Shooting night scenes.**

Since the built-in flash will be disabled, this mode <  > is also good for night scenes. Use a tripod to prevent camera shake.

If you want to photograph a person against a night scene, set the Mode Dial to <  > (Night Portrait) and use a tripod (p.63).



Shooting Close-ups

When you want to photograph flowers or small things up close, use the  (Close-up) mode. To make small things appear much larger, use a macro lens (sold separately).

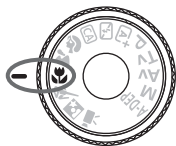



Shooting Tips

- **Use a simple background.**

A simple background makes the flower, etc., stand out better.

- **Move to the subject as close as possible.**

Check the lens for its minimum focusing distance. Some lenses have indications such as  **0.25m/0.8ft**. The lens minimum focusing distance is measured from the  (focal plane) mark on the top left of the camera to the subject. If you are too close to the subject, the focus confirmation light  will blink.

Under low light, the built-in flash will fire. If you are too close to the subject and the bottom of the picture looks dark, move away from the subject.

- **With a zoom lens, use the telephoto end.**

If you have a zoom lens, using the telephoto end will make the subject look larger.

Shooting Moving Subjects

To photograph a moving subject, whether it is a child running or a moving vehicle, use the  (Sports) mode.

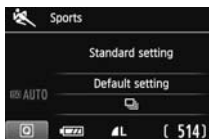
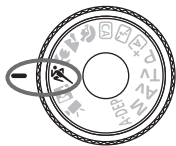

Shooting Tips

- **Use a telephoto lens.**

Using a telephoto lens is recommended so you can shoot from afar.

- **Use the center AF point to focus.**

Aim the center AF point over the subject, then press the shutter button halfway to autofocus. During autofocusing, the beeper will continue beeping softly. If focus cannot be achieved, the focus confirmation light  will blink.

When you want to take the picture, press the shutter button completely. If you hold down the shutter button, continuous shooting (max. approx. 3.7 shots per sec.) and autofocusing will take effect.



 Under low light when camera shake is prone to occur, the viewfinder's shutter speed display on the bottom left will blink. Hold the camera steady and shoot.

Shooting Portraits at Night

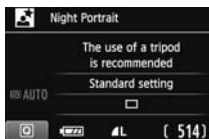
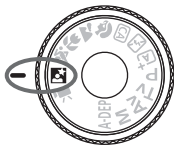
To shoot someone at night and obtain a natural-looking exposure in the background, use the  (Night Portrait) mode.



Shooting Tips

- **Use a wide-angle lens and a tripod.**
When using a zoom lens, use the wide-angle end to obtain a wide night view. Also, use a tripod to prevent camera shake.
- **Keep the person within 5 meters/16.4 feet from the camera.**
Under low light, the built-in flash will fire automatically to obtain a good exposure of the person. The maximum effective distance of the built-in flash is 5 meters/16.4 feet from the camera.
- **Shoot also with  (Scene Intelligent Auto).**
Since camera shake is prone to occur with night shots, shooting also with  (Scene Intelligent Auto) is recommended.



- Tell the subject to keep still even after the flash fires.
- If you use the self-timer together with flash, the self-timer lamp will light briefly after the picture is taken.

Q Quick Control

Example: Portrait mode

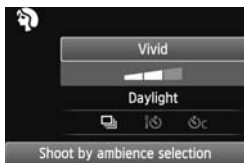

In Basic Zone modes when the shooting settings screen is displayed, you can press the <Q> button to display the Quick Control screen. The table below indicates the functions that can be set with the Quick Control screen in each Basic Zone mode.

1 Set the Mode Dial to a Basic Zone mode.

2 Press the <Q> button. (☺10)

- ▶ The Quick Control screen will appear.

3 Set the function.

- Press the <▲▼> key to select a function. (Step not necessary in the A^+ / M mode.)
- ▶ The selected function and Feature guide (p.48) will be displayed.
- Press the <◀▶> key or turn the <☺> dial to change the setting.

Settable Functions in Basic Zone Modes

●: Set automatically ○: User selectable □: Not selectable

Function		A^+ (p.50)	M (p.55)	CA (p.56)	P (p.59)	S (p.60)	L (p.61)	A (p.62)	M (p.63)
Drive mode	□: Single shooting	○	○	○	□	○	○	□	○
	M : Continuous shooting	□	□	○	○	□	□	○	□
	Self-timer								
	☺ : 10 sec./Remote control	○	○	○	○	○	○	○	○
	☺c : Continuous shooting after 10 sec.*	○	○	○	○	○	○	○	○
Flash firing	Automatic firing	●	□	○	●	□	●	□	●
	Flash on (Fires at all times)	□	□	○	□	□	□	□	□
	Flash off	□	●	○	□	●	□	●	□
Shoot by ambience selection (p.65)		□	□	○	○	○	○	○	○
Shoot by lighting or scene type (p.68)		□	□	□	○	○	○	○	□
Blurring/sharpening the background (p.57)		□	□	○	□	□	□	□	□

* Use the <▲▼> key to set the number of continuous shots.

Shoot by Ambience Selection

Except in the <A+> (Scene Intelligent Auto) and <Flash Off> Basic Zone modes, you can select the ambience for shooting.

Ambience	A+	Flash Off	CA	Portrait	Movie	Flower	Hand	Scene	Ambience Effect
(1) Standard setting			○	○	○	○	○	○	No setting
(2) Vivid			○	○	○	○	○	○	Low / Standard / Strong
(3) Soft			○	○	○	○	○	○	Low / Standard / Strong
(4) Warm			○	○	○	○	○	○	Low / Standard / Strong
(5) Intense			○	○	○	○	○	○	Low / Standard / Strong
(6) Cool			○	○	○	○	○	○	Low / Standard / Strong
(7) Brighter			○	○	○	○	○	○	Low / Medium / High
(8) Darker			○	○	○	○	○	○	Low / Medium / High
(9) Monochrome			○	○	○	○	○	○	Blue / B/W / Sepia

1 Set the Mode Dial to any of the following modes: <CA>, <Portrait>, <Movie>, <Flower>, <Hand> or <Scene>.



2 Display the Live View image.

- With the Live View image displayed, you can see the ambience effect.
- Press the <Live View> button to switch to Live View shooting.



3 On the Quick Control screen, select the desired ambience.

- Press the <Q> button (1/10).
- Press the <▲▼> key to select [Standard setting]. [Shoot by ambience selection] will appear on the screen's bottom.
- Press the <◀▶> key or turn the <Ambience Dial> to select the desired ambience.
- ▶ The LCD monitor will show how the image will look with the selected ambience.



4 Set the ambience effect.

- Press the <▲▼> key to select the effect bar so that **[Effect]** appears at the bottom.
- Press the <◀▶> key or turn the <☀> dial to select the desired effect.

5 Take the picture.

- To shoot while the Live View image is displayed, press the shutter button.
- To return to viewfinder shooting, press the <📷> button to exit Live View shooting. Then press the shutter button completely to take the picture.
- If you change the shooting mode or set the power switch to <OFF>, the setting will revert back to **[Standard setting]**.

- The Live View image shown with the ambience setting applied will not look exactly the same as the actual photo.
- Using flash may minimize the ambience effect.
- In bright outdoors, the Live View image you see on the screen might not have exactly the same brightness or ambience as the actual photo. Set **[📷 LCD brightness]** to 4 and look at the Live View image while the screen is unaffected by stray light.

- If you don't want the Live View image to be displayed when setting functions, press the <📷> button after step 1. When you press the <📷> button, the Quick Control screen is displayed and you can set **[Shoot by ambience selection]** and **[Shoot by lighting or scene]**, then shoot with the viewfinder.

Ambience Settings

(1) **Standard setting**

Standard image characteristics for the respective shooting mode. Note that <👤> has image characteristics geared for portraits and <🏞️> is geared for landscapes. Each ambience is a modification of the respective shooting mode's image characteristics.

(2) **Vivid**

The subject will look sharp and vivid. It makes the photo look more impressive than with [**Standard setting**].

(3) **Soft**

The subject will look softer and more dainty. Good for portraits, pets, flowers, etc.

(4) **Warm**

The subject will look softer with warmer colors. Good for portraits, pets, and other subjects to which you want to give a warm look.

(5) **Intense**

While the overall brightness is slightly lowered, the subject is emphasized for a more intense feeling. Makes the human or living subject stand out more.

(6) **Cool**

The overall brightness is slightly lowered with a cooler color cast. A subject in the shade will look more calm and impressive.

(7) **Brighter**

The picture will look brighter.

(8) **Darker**

The picture will look darker.

(9) **Monochrome**

The picture will be monochrome. You can select the monochrome color to be black and white, sepia, or blue. When [**Monochrome**] is selected, <B/W> will appear in the viewfinder.

Shoot by Lighting or Scene Type

In the <👤> (Portrait), <🏞️> (Landscape), <🌸> (Close-up), and <🏊> (Sports) Basic Zone modes, you can shoot while the settings match the lighting or scene type. Normally, [Default setting] is adequate, but if the settings match the lighting condition or scene, the picture will look more accurate to your eye.

For Live View shooting, if you set both [Shoot by lighting or scene type] and [Shoot by ambience selection] (p.65), you should first set [Shoot by lighting or scene type]. This will make it easier to see the resulting effect on the LCD monitor.

Lighting or scene								
(1) Default setting				○	○	○	○	
(2) Daylight				○	○	○	○	
(3) Shade				○	○	○	○	
(4) Cloudy				○	○	○	○	
(5) Tungsten light				○		○	○	
(6) Fluorescent light				○		○	○	
(7) Sunset				○	○	○	○	

1 Set the Mode Dial to any of the following modes: <👤>, <🏞️>, <🌸>, or <🏊>.

2 Display the Live View image.

- With the Live View image displayed, you can see the resulting effect.
- Press the <📷> button to switch to Live View shooting.





3 On the Quick Control screen, select the lighting or scene type.

- Press the <Q> button (☺10).
- Press the <▲> key to select [**Default setting**] (shown in the sample screen). [**Shoot by lighting or scene type**] will appear on the screen's bottom.
- Press the <◀▶> key or turn the <☺> dial to select the desired lighting or scene type.
 - ▶ The LCD monitor will show how the image will look with the selected lighting or scene type.

4 Take the picture.

- To shoot while the Live View image is displayed, press the shutter button.
- To return to viewfinder shooting, press the <📷> button to exit Live View shooting. Then press the shutter button completely to take the picture.
- If you change the shooting mode or set the power switch to <OFF>, the setting will revert back to [**Default setting**].



- If you use flash, the setting will switch to [**Default setting**]. (However, the shooting information will display the lighting or scene type that was set.)
- If you want to set this together with [**Shoot by ambience selection**], set the [**Shoot by lighting or scene type**] which best matches the ambience you have set. In the case of [**Sunset**] for example, warm colors will become prominent so the ambience you set might not work well.



If you don't want the Live View image to be displayed when setting functions, press the <Q> button after step 1. Pressing the <Q> button will display the Quick Control screen. You can then set [**Shoot by lighting or scene type**] and shoot with the viewfinder.

Lighting or Scene Type Settings

(1) **Default setting**

The default setting.

(2) **Daylight**

For subjects under sunlight. Gives more natural-looking blue skies and greenery and reproduces light-colored flowers better.

(3) **Shade**

For subjects in the shade. Suitable for skin tones, which may look too bluish, and for light-colored flowers.

(4) **Cloudy**

For subjects under overcast skies. Makes skin tones and landscapes, which may otherwise look dull on a cloudy day, look warmer. Also effective for light-colored flowers.

(5) **Tungsten light**

For subjects lit under tungsten lighting. Reduces the reddish-orange color cast caused by tungsten lighting.

(6) **Fluorescent light**

For subjects under fluorescent lighting. Suited for all types of fluorescent lighting.

(7) **Sunset**

Suitable when you want to capture the sunset's impressive colors.

▶ Image Playback

The easiest way to playback images is explained below. For more details on the playback procedure, see page 201.



1 Playback the image.

- When you press the <▶> button, the last image captured will be displayed.



2 Select an image.

- To view images starting with the last image, press the <◀> key. To view images starting with the first (oldest) image, press the <▶> key.
- Each time you press the <INFO.> button, the display format will change.



No information



With basic information

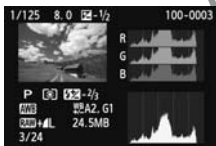

Histogram



Shooting information display

3 Exit the image playback.

- Press the <▶> button to exit the image playback and return to the shooting settings display.



3

Creative Shooting

In the Basic Zone modes, to prevent spoiled shots, most functions are set automatically and cannot be changed. In the <P> (Program AE) mode, you can set various functions and be more creative.

- In the <P> mode, the camera sets the shutter speed and aperture automatically to obtain a standard exposure.
- The difference between the Basic Zone modes and <P> is explained on page 268.
- The functions explained in this chapter can also be used in the <Tv>, <Av>, and <M> modes explained in Chapter 4.
- The ☆ mark shown on the right of the page title indicates that the function is available only in Creative Zone modes (p.22).

* <P> stands for Program.

* AE stands for Auto Exposure.

P: Program AE

The camera automatically sets the shutter speed and aperture to suit the subject's brightness. This is called Program AE.



1 Set the Mode Dial to <P>.



2 Focus the subject.

- Look through the viewfinder and aim the selected AF point over the subject. Then press the shutter button halfway.
- ▶ The dot inside the AF point achieving focus lights briefly in red, and the focus confirmation light <●> in the viewfinder's bottom right lights (with One Shot AF).
- ▶ The shutter speed and aperture will be set automatically and displayed in the viewfinder.



3 Check the display.

- A standard exposure will be obtained as long as the shutter speed and aperture display do not blink.

4 Take the picture.

- Compose the shot and press the shutter button completely.



Shooting Tips

● Change the ISO speed or use the built-in flash.

To match the subject and ambient lighting level, you can change the ISO speed (p.79) or use the built-in flash (p.90). In the <P> mode, the built-in flash will not fire automatically. So under low light, press the <⚡> (Flash) button to raise the built-in flash.

● The program can be shifted. (Program shift)

After pressing the shutter button halfway, turn the <☀> dial to change the shutter speed and aperture setting combination (program). Program shift is canceled automatically after the picture is taken. Program shift is not possible with flash.



- If the "30"" shutter speed and the maximum aperture blink, it indicates underexposure. Increase the ISO speed or use flash.
- If the "4000" shutter speed and the minimum aperture blink, it indicates overexposure. Decrease the ISO speed.



Differences Between <P> and <A+> (Scene Intelligent Auto)

With <A+>, many functions such the AF mode, drive mode, and built-in flash are set automatically to prevent spoiled shots. The functions you can set are limited. With <P>, only the shutter speed and aperture are set automatically. You can freely set the AF mode, drive mode, built-in flash, and other functions (p.268).

MENU Setting the Image-recording Quality

You can select the pixel count and the image quality. Ten image-recording quality settings are provided: **L**, **L**, **M**, **M**, **S1**, **S1**, **S2**, **S3**, **RAW**, **RAW**+**L**.

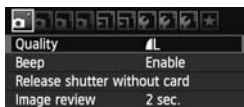

1 Select [Quality].

- Under the [Q] tab, select [Quality], then press <SET>.
- ▶ [Quality] will appear.

Pixel count

Possible shots



2 Select the image-recording quality.

- The respective quality's pixel count and number of possible shots will be displayed to help you select the desired quality. Then press <SET>.

Guide to Image-recording Quality Settings (Approx.)

Quality		Pixels Recorded (megapixels)	File Size (MB)	Possible Shots	Maximum Burst
L	High quality	Approx. 17.9 (18M)	6.4	570	34
			3.2	1120	1120
M	Medium quality	Approx. 8.0 (8M)	3.4	1070	1070
			1.7	2100	2100
S1	Low quality	Approx. 4.5 (4.5M)	2.2	1670	1670
			1.1	3180	3180
S2	Low quality	Approx. 2.5 (2.5M)	1.3	2780	2780
S3			Approx. 0.35 (0.35M)	0.3	10780
RAW	High quality	Approx. 17.9 (18M)	24.5	150	6
RAW + L			24.5+6.4	110	3

* Figures for the file size, number of possible shots, and maximum burst are based on Canon's 4GB test card and testing standards (3:2 aspect ratio, ISO 100, and Standard Picture Style). **These figures will vary depending on the subject, card brand, aspect ratio, ISO speed, Picture Style, Custom Functions, and other settings.**

FAQ

- I want to select the image-recording quality matching the paper size for printing.

Paper size

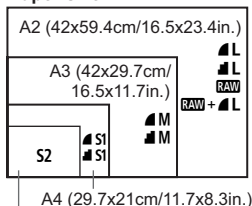

12.7x8.9cm/5.0x3.5in.

Refer to the diagram on the left when choosing the image-recording quality. If you want to crop the image, selecting a higher quality (more pixels) such as **L**, **L**, **RAW**, or **RAW + L** is recommended. **S2** is suitable for playing the images on a digital photo frame. **S3** is suitable for emailing the image or using it on a Web site.

- What's the difference between **L** and **L**?

It indicates a different image quality due to a different compression rate. Even with the same number of pixels, the **L** image has higher image quality. If **L** is selected, the image quality will be slightly lower, but more images can be saved to the card. Both **S2** and **S3** have **L** (Fine) quality.

- I could take more shots than the number of possible shots indicated.

Depending on the shooting conditions, you may be able to take more shots than was indicated. It might also be fewer than indicated. The number of possible shots displayed is only approximate.

- Does the camera display the maximum burst?

The maximum burst is displayed in the viewfinder's right side. Since it is only a single-digit indicator **0 - 9**, any number higher than 9 will be displayed only as "9." Note that this number will also be displayed even when no card is installed in the camera. Be careful not to shoot without a card in the camera.

- When should I use **RAW**?

RAW images require processing with your computer. For details, see "About **RAW**" and "About **RAW + L**" on the next page.

About RAW

RAW is the raw image data before it is made into L or other images. Although RAW images require software like Digital Photo Professional (provided, p.302) so they can be displayed on the computer, they also offer flexibility for image adjustments possible only with RAW. RAW is effective when you want to precisely adjust the image yourself or shoot an important subject.

About RAW + L

RAW + L records both a RAW and L image with a single shot. The two images are saved to the card simultaneously. The two images will be saved in the same folder with the same file numbers (file extension .JPG for JPEG and .CR2 for RAW). L images can be viewed or printed even with a computer which does not have the software provided with the camera installed.

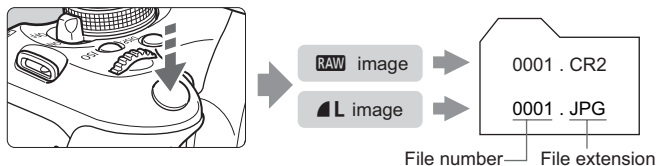

 Commercially-available software might not be able to display RAW images. Using the provided software is recommended.

ISO: Changing the ISO Speed ☆

Set the ISO speed (image sensor's sensitivity to light) to suit the ambient light level. In Basic Zone modes, the ISO speed is set automatically (p.80).

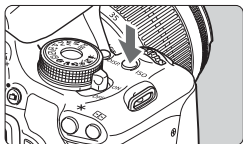

- 1 Press the <ISO> button. (ⓘ6)
▶ [ISO speed] will appear.

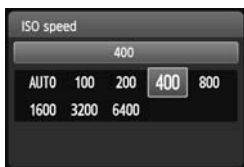

- 2 Set the ISO speed.
 - Press the <◀▶> key or turn the <⚙> dial to select the desired ISO speed, then press <ⓘ6>.
 - You can also set the ISO speed in the viewfinder while turning the <⚙> dial.
 - With [AUTO] selected, the ISO speed will be set automatically (p.80).

ISO Speed Guide

ISO Speed	Shooting Situation (No flash)	Flash Range
100 - 400	Sunny outdoors	The higher the ISO speed, the farther the flash range will extend (p.90).
400 - 1600	Overcast skies or evening time	
1600 - 6400, H	Dark indoors or night	

* High ISO speeds will result in grainier images.

Under [☛: Custom Functions (C.Fn)], if [2: ISO expansion] is set to [1: On], "H" (equivalent to ISO 12800) can also be set (p.252).

- Under [☛: Custom Functions (C.Fn)], if [6: Highlight tone priority] is set to [1: Enable], ISO 100 and "H" (equivalent to ISO 12800) cannot be selected (p.254).
- Shooting in high temperatures may result in images that look grainier. Long exposures can also cause irregular colors in the image.
- When you shoot at high ISO speeds, noise (banding, dots of light, etc.) may become noticeable.

ISO [AUTO]

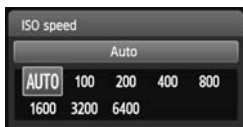

If the ISO speed is set to [AUTO], the actual ISO speed to be set will be displayed when you press the shutter button halfway. As indicated below, the ISO speed will be set automatically to suit the shooting mode.

Shooting Mode	ISO Speed Setting
	Automatically set within ISO 100 - 3200
P/Tv/Av/M*1/A-DEP	Automatically set within ISO 100 - 6400 ^{*2}
	Fixed at ISO 100
With flash	Fixed at ISO 400 ^{*3*4}

*1: Fixed at ISO 400 for bulb exposures.

*2: Depends on the maximum ISO speed limit set.

*3: If fill flash results in overexposure, ISO 100 or a higher ISO speed will be set.

*4: If bounce flash is used with an external Speedlite in a Basic Zone (except mode, <P> or <A-DEP> mode, ISO 400 - 1600 (or up to the maximum limit) will be set automatically.

- When [AUTO] is set, the ISO speed is indicated in whole-stop increments. However, the ISO speed is actually set in finer increments. Therefore, in the image's shooting information (p.226), you may find an ISO speed like 125 or 640 displayed as the ISO speed.
- In the mode, the ISO speed shown in the table is actually used even if ISO 100 is not displayed.

MENU Setting the Maximum ISO Speed for ISO Auto [☆]

For ISO Auto, you can set the maximum ISO speed limit within ISO 400 - 6400.



Under the tab, select [ISO Auto], then press <SET>. Select the ISO speed, then press <SET>.

Selecting the Subject's Optimal Image Characteristics ☆

By selecting a Picture Style, you can obtain image characteristics matching your photographic expression or the subject.

In Basic Zone modes, you cannot select the Picture Style.



1 Press the <▼ > button.

- ▶ [Picture Style] will appear.



2 Select a Picture Style.

- Press the <◀▶> key or turn the < > dial to select a Picture Style, then press <SET>.

Picture Style Characteristics

Auto

The color tone will be adjusted to suit the scene. The colors will look vivid, especially for blue skies, greenery, and sunsets in nature, outdoor, and sunset scenes.



If the desired color tone is not obtained, use another Picture Style.

Standard

The image looks vivid, sharp, and crisp. This is a general-purpose Picture Style suitable for most scenes.

Portrait

For nice skin tones. The image looks softer. Good for close-up portraits.

By changing the [Color tone] (p.113), you can adjust the skin tone.

Landscape

For vivid blues and greens, and very sharp and crisp images.
Effective for impressive landscapes.

Neutral

This Picture Style is for users who prefer to process images with their computer. For natural colors and subdued images.

Faithful

This Picture Style is for users who prefer to process images with their computer. When the subject is captured under a color temperature of 5200K, the color is adjusted colorimetrically to match the subject's color. The image looks dull and subdued.

Monochrome

Creates black-and-white images.



Other than with **RAW**, the black-and-white image cannot be reverted to color. If you want to later shoot pictures in color, make sure the **[Monochrome]** setting has been canceled. When **[Monochrome]** is set, **<B/W>** will appear in the viewfinder.

User Def. 1-3

You can register a basic style such as **[Portrait]**, **[Landscape]**, a Picture Style file, etc., and adjust it as desired (p.115). Any User Defined Picture Style which has not been set will have the same default settings as the **[Auto]** Picture Style.

AF: Changing the Autofocus Mode ☆

You can select the AF (autofocus) mode to suit the shooting conditions or subject. In Basic Zone modes, the most suitable AF mode is set automatically.

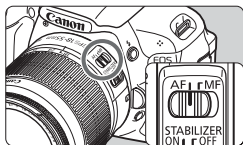

- 1 On the lens, set the focus mode switch to <AF>.



- 2 Press the <▶ AF> button.
▶ [AF mode] will appear.

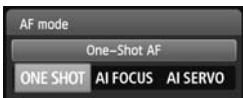

- 3 Select the AF mode.

- Press the <◀▶> key or turn the <⚙> dial to select the desired AF mode, then press <Ⓢ>.

- 4 Focus the subject.

- Aim the AF point over the subject and press the shutter button halfway. The camera will then autofocus in the selected AF mode.

One-Shot AF for Still Subjects

Suited for still subjects. When you press the shutter button halfway, the camera will focus only once.

- When focus is achieved, the dot inside the AF point achieving focus lights briefly in red, and the focus confirmation light <●> in the viewfinder will also light.
- With evaluative metering (p.102), the exposure setting will be set at the same time focus is achieved.
- While you hold down the shutter button halfway, the focus will be locked. You can then recompose the shot if desired.

- 
- If focus cannot be achieved, the focus confirmation light <●> in the viewfinder will blink. If this occurs, a picture cannot be taken even if the shutter button is pressed completely. Recompose the picture and try to focus again. Or see “Subjects Difficult to Focus” (p.87).
 - If [Beep] is set to [Disable], the beeper will not sound when focus is achieved.

AI Servo AF for Moving Subjects

This AF mode is for moving subjects when the focusing distance keeps changing. While you hold down the shutter button halfway, the subject will be focused continuously.

- The exposure is set at the moment the picture is taken.
- When the AF point selection (p.85) is automatic, the camera first uses the center AF point to focus. During autofocusing, if the subject moves away from the center AF point, focus tracking continues as long as the subject is covered by another AF point.



With AI Servo AF, the beeper will not sound even when focus is achieved. Also, the focus confirmation light <●> in the viewfinder will not light.

AI Focus AF for Automatic Switching of AF Mode

AI Focus AF switches the AF mode from One-Shot AF to AI Servo AF automatically if the still subject starts moving.

- After the subject is focused in One-Shot AF mode, if the subject starts moving, the camera will detect the movement and change the AF mode automatically to AI Servo AF.



When focus is achieved in the AI Focus AF mode with the Servo mode active, the beeper will sound continuously softly. However, the focus confirmation light <●> in the viewfinder will not light.

Selecting the AF Point ☆

In Basic Zone modes, the camera will normally focus the closest subject automatically. Therefore, it might not always focus your target subject. In the <P>, <Tv>, <Av>, and <M> modes, you can select the AF point and use it to focus the target subject.



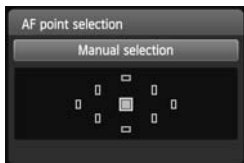

1 Press the < > button. (06)

- ▶ The selected AF point will be displayed on the LCD monitor and in the viewfinder.



2 Select the AF point.

- Press the < > key to select the AF point.
- While looking at the viewfinder, you can select the AF point by turning the < > dial until the desired AF point lights in red.
- When all the AF points light up, automatic AF point selection will be set. The AF point will be selected automatically to focus the subject.
- Pressing < > toggles the AF point selection between the center AF point and automatic AF point selection.

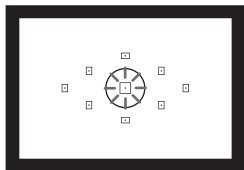

3 Focus the subject.

- Aim the selected AF point over the subject and press the shutter button halfway to focus.

Shooting Tips

- **When shooting a portrait up close, use One-Shot AF and focus the eyes.**

If you focus the eyes first, you can then recompose and the face will remain sharp.

- **If it is difficult to focus, select and use the center AF point.**

The center AF point is the most sensitive among the nine AF points.

- **To make it easier to focus a moving subject, set the camera to automatic AF point selection and AI Servo AF (p.84).**

The center AF point will first be used to focus the subject. During autofocusing, if the subject moves away from the center AF point, focus tracking continues as long as the subject is covered by another AF point.

AF-Assist Beam with the Built-in Flash

Under low-light conditions, when you press the shutter button halfway, the built-in flash fires a brief burst of flashes. It illuminates the subject to enable easier autofocusing.



- The AF-assist beam will not be fired in the following shooting modes: $\langle \text{[A]} \rangle$, $\langle \text{[M]} \rangle$ and $\langle \text{[S]} \rangle$.
- The AF-assist beam cannot be emitted in the AI Servo AF mode.
- The effective range of the AF-assist beam emitted by the built-in flash is about 4 meters/13.1 feet.
- In Creative Zone modes when you raise the built-in flash with the $\langle \text{[L]} \rangle$ button (p.90), the AF-assist beam will be fired when necessary.



If you use an Extender (sold separately) and the maximum aperture becomes smaller than f/5.6, AF shooting will not be possible (except in [Live mode] and [Live mode] during Live View shooting). For details, see the Extender's instruction manual.

Subjects Difficult to Focus

Autofocus can fail to achieve focus (viewfinder's focus confirmation light <●> blinks) with certain subjects such as the following:

- Very low-contrast subjects.
(Example: Blue sky, solid-color walls, etc.)
- Subjects in very low light
- Extremely backlit or reflective subjects
(Example: Car with a highly reflective body, etc.)
- Near and far subjects covered by an AF point
(Example: Animal in a cage, etc.)
- Repetitive patterns
(Example: Skyscraper windows, computer keyboards, etc.)

In such cases, do one of the following:

- (1) With One-Shot AF, focus an object at the same distance as the subject and lock the focus before recomposing (p.53).
- (2) Set the lens focus mode switch to <MF> and focus manually.

 For conditions where AF can fail to achieve focus with [Live mode]/[Live mode] during Live View shooting, see page 134.

MF: Manual Focusing

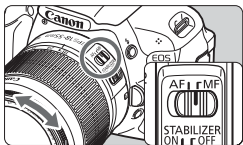

Focusing ring

- 1 Set the lens focus mode switch to <MF>.
- 2 Focus the subject.
 - Focus by turning the lens focusing ring until the subject looks sharp in the viewfinder.

 If you hold down the shutter button halfway during manual focusing, the AF point achieving focus will light in red briefly, the beeper will sound, and the focus confirmation light <●> in the viewfinder will light.



Continuous Shooting ☆

You can shoot up to about 3.7 shots per sec. This is effective for shooting a child running toward you or capturing different facial expressions.



1 Press the <<   >> button.

2 Select < >.

- Press the <◀▶> key or turn the < > dial to select continuous shooting < >, then press <SET>.

3 Take the picture.

- The camera shoots continuously while you hold down the shutter button completely.

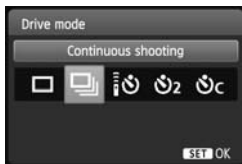

Shooting Tips

- **Also set the AF mode (p.83) matching the subject.**

- **For a moving subject**

When AI Servo AF is set, focusing will be continuous during continuous shooting.

- **For still subjects**

When One-Shot AF is set, the camera will focus only once during continuous shooting.

- **Flash can also be used.**

Since the flash will require recycling time, the continuous shooting speed will be slower.

- Under [ Custom Functions (C.Fn)], if [5: High ISO speed noise reduction] (p.254) is set to [2: Strong], the maximum continuous shooting burst will greatly decrease.
- In AI Servo AF mode, the continuous shooting speed may become slightly slower depending on the subject and the lens used.
- The continuous shooting speed might also decrease indoors and under low light.

Using the Self-timer

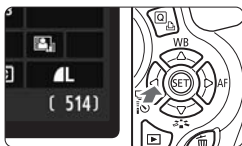

1 Press the **<◀ [] [] [] ▶>** button.

2 Select the self-timer.

- Press the **<◀▶>** key or turn the **< [] >** dial to select the desired self-timer, then press **<SET>**.

[] [] : 10-sec. self-timer

The remote control can also be used. (p.261)

[] [] : 2-sec. self-timer* (p.122)

[] [] : 10-sec. self-timer plus continuous shots

[] [] Press the **<▲▼>** key to set the number of continuous shots (2 to 10) to be taken with the self-timer.

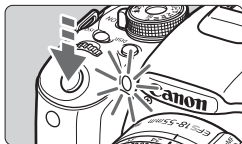
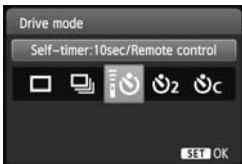

3 Take the picture.

- Look through the viewfinder, focus the subject, then press the shutter button completely.
- ▶ You can check the self-timer operation with the self-timer lamp, beeper, and countdown display (in seconds) on the LCD monitor.

▶ Two seconds before the picture is taken, the self-timer lamp will stay on and the beeper will sound faster.



With **< [] >**, the interval between the multiple shots may be prolonged depending on the shooting functions settings such as the image-recording quality or flash.



- After taking self-timer shots, you should check the image for proper focus and exposure (p.71).
- If you will not look through the viewfinder when you press the shutter button, attach the eyepiece cover (p.262). If stray light enters the viewfinder when the picture is taken, it may throw off the exposure.
- When using the self-timer to shoot only yourself, use focus lock (p.53) on an object at about the same distance as where you will stand.
- To cancel the self-timer after it starts, press the **<◀ [] [] [] ▶>** button. To cancel the self-timer during Live View shooting, set the power switch to **<OFF>**.

⚡ Using the Built-in Flash

In indoors, low light, or backlit conditions in daylight, just raise the built-in flash and press the shutter button to take flash pictures. In the <P> mode, the shutter speed (1/60 sec. - 1/200 sec.) will be set automatically to prevent camera shake.

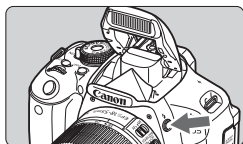

1 Press the <⚡> button.

- In Creative Zone modes, you can press the <⚡> button anytime to take flash pictures.
- While the flash is recycling, “⚡buSY” is displayed in the viewfinder, and [BUSY⚡] is displayed on the LCD monitor.



2 Press the shutter button halfway.

- In the bottom left of the viewfinder, check that the <⚡> icon is lit.

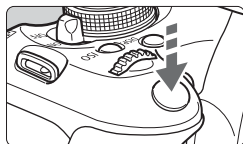

3 Take the picture.

- When focus is achieved and you press the shutter button completely, the flash will fire for the picture.

Effective Flash Range

[Approx. in meters/feet]

ISO speed (p.79)	EF-S18-55mm f/3.5-5.6 IS II EF-S18-135mm f/3.5-5.6 IS	
	Wide Angle	Telephoto
100	1 - 3.7 / 3.3 - 12.1	1 - 2.3 / 3.3 - 7.5
200	1 - 5.3 / 3.3 - 17.4	1 - 3.3 / 3.3 - 10.8
400/AUTO*	1 - 7.4 / 3.3 - 24.3	1 - 4.6 / 3.3 - 15.1
800	1 - 10.5 / 3.3 - 34.4	1 - 6.6 / 3.3 - 21.7
1600	1 - 14.9 / 3.3 - 48.9	1 - 9.3 / 3.3 - 30.5
3200	1 - 21.0 / 3.3 - 68.9	1 - 13.1 / 3.3 - 43.0
6400	1 - 29.7 / 3.3 - 97.4	1 - 18.6 / 3.3 - 61.0
H: 12800	1 - 42.0 / 3.3 - 137.8	1 - 26.3 / 3.3 - 86.3

* For fill flash, the ISO speed might be set lower than ISO 400.

Shooting Tips

- **If the subject is far away, increase the ISO speed** (p.79).
By increasing the ISO speed, you can extend the flash range.
- **In bright light, decrease the ISO speed.**
If the exposure setting in the viewfinder blinks, decrease the ISO speed.
- **Detach the lens hood and keep at least 1 meter/3.3 feet away from the subject.**
If the lens has a hood attached or you are too close to the subject, the bottom of the picture might look dark due to the obstructed flash. For important shots, check the image on the LCD monitor to make sure the flash exposure looks natural (not dark at the bottom).

MENU Red-eye Reduction

Using the red-eye reduction lamp before taking a flash picture can reduce red eye. Red-eye reduction will work in any shooting mode except , , , or .



- Under the [] tab, select [**Red-eye reduc.**], then press . Select [**Enable**], then press .
- For flash photography, when you press the shutter button halfway, the red-eye reduction lamp will light. Then when you press the shutter button completely, the picture will be taken.



- The red-eye reduction feature is most effective when the subject looks at the red-eye reduction lamp, when the room is well lit, or when you are close to the subject.
- When you press the shutter button halfway, the scale display on the bottom of the viewfinder will shrink and turn off. For best results, take the picture after this scale display turns off.
- The effectiveness of red-eye reduction varies depending on the subject.





4



Advanced Shooting

This chapter builds on Chapter 3 and introduces more ways to shoot creatively.

- The first half of this chapter explains how to use the <Tv>, <Av>, <M>, and <A-DEP> modes on the Mode Dial.
- All the functions explained in Chapter 3 can also be used in the <Tv>, <Av>, and <M> modes.
- To see which functions can be used in each shooting mode, see page 268.
- The ☆ mark shown on the right of the page title indicates that the function is available only in Creative Zone modes (p.22).

About the Main Dial Pointer



The pointer icon < > displayed together with the shutter speed, aperture setting, or exposure compensation amount indicates that you can turn the < > dial to adjust the respective setting.

Tv: Action Shots

You can either freeze the action or create motion blur with the **<Tv>** (Shutter-priority AE) mode on the Mode Dial.

* **<Tv>** stands for Time value.



Blurred motion
(Slow shutter speed: 1/30 sec.)



Frozen action
(Fast shutter speed: 1/2000 sec.)



1 Set the Mode Dial to **<Tv>**.

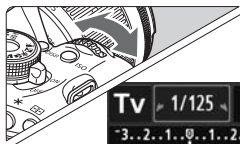

2 Set the desired shutter speed.

- See “Shooting Tips” for advice on setting the shutter speed.
- Turning the  dial to the right sets a faster shutter speed, and turning it to the left sets a slower one.



3 Take the picture.

- When you focus and press the shutter button completely, the picture will be taken at the selected shutter speed.



Shutter Speed Display

The LCD monitor displays the shutter speed as a fraction. However, the viewfinder displays only the denominator. Also, “0”5” indicates 0.5 sec. and “15”” is 15 sec.

Shooting Tips

- **To freeze the action or moving subject.**
Use a fast shutter speed such as 1/4000 sec. to 1/500 sec.
- **To blur a running child or animal giving the impression of fast movement.**
Use a medium shutter speed such as 1/250 sec. to 1/30 sec. Follow the moving subject through the viewfinder and press the shutter button to take the picture. If you use a telephoto lens, hold it steady to prevent camera shake.
- **How to blur a flowing river or water fountain.**
Use a slow shutter speed of 1/30 sec. or slower. Use a tripod to prevent hand-held camera shake.
- **Set the aperture so that the shutter speed display does not blink.**

If you press the shutter button halfway and change the shutter speed while the aperture is displayed, the aperture display will also change to maintain the same exposure (amount of light reaching the image sensor). If you exceed the adjustable aperture range, the aperture display will blink to indicate that the standard exposure cannot be obtained.

If the exposure will be too dark, the maximum aperture (smallest number) will blink. If this happens, turn the  dial to the left to set a slower shutter speed or increase the ISO speed.

If the exposure will be too bright, the minimum aperture (highest number) will blink. If this happens, turn the  dial to the right to set a faster shutter speed or decrease the ISO speed.

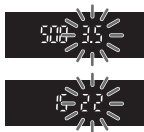

Using the Built-in Flash

To obtain a correct flash exposure, the flash output will be set automatically (autoflash exposure) to match the automatically-set aperture. The flash sync speed can be set from 1/200 sec. to 30 sec.

Av: Changing the Depth of Field

To blur the background or to make everything near and far look sharp, set the Mode Dial to <Av> (Aperture-priority AE) to adjust the depth of field (range of acceptable focus).

* <Av> stands for Aperture value which is the size of the diaphragm hole inside the lens.



Blurred background
(With a low aperture f/number: f/5.6)



Sharp foreground and background
(With a high aperture f/number: f/32)

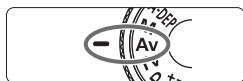

1 Set the Mode Dial to <Av>.

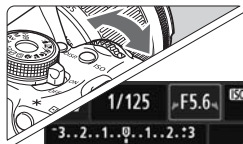

2 Set the desired aperture.

- The higher the f/number, the wider the depth of field where sharper focus is obtained in both the foreground and background.
- Turning the <Aperture> dial to the right will set a higher f/number (smaller aperture opening), and turning it to the left will set a lower f/number (larger aperture opening).



3 Take the picture.

- Focus and press the shutter button completely. The picture will be taken with the selected aperture.



Aperture Display

The higher the f/number, the smaller the aperture opening will be. The apertures displayed will differ depending on the lens. If no lens is attached to the camera, "00" will be displayed for the aperture.

 **Shooting Tips**

- **When using an aperture with a high f/number, note that camera shake can occur in low light scenes.**

A higher aperture f/number will make the shutter speed slower. Under low light, the shutter speed can be as long as 30 sec. In such cases, increase the ISO speed and hold the camera steady or use a tripod.

- **The depth of field depends not only on the aperture, but also on the lens and on the subject distance.**

Since wide-angle lenses have a wide depth of field (range of acceptable focus in front of and behind the point of focus), you need not set a high aperture f/number to obtain a sharp picture from the foreground to the background. On the other hand, a telephoto lens has a narrow depth of field.

And the closer the subject, the narrower the depth of field. A farther subject will have a wider depth of field.

- **Set the aperture so that the shutter speed display does not blink.**

If you press the shutter button halfway and change the aperture while the shutter speed is displayed, the shutter speed display will also change to maintain the same exposure (amount of light reaching the image sensor). If you exceed the adjustable shutter speed range, the shutter speed display will blink to indicate that the standard exposure cannot be obtained.

If the picture will be too dark, the “30” (30 sec.) shutter speed display will blink. If this happens, turn the  dial to the left to set a lower aperture f/number or increase the ISO speed.

If the picture will be too bright, the “4000” (1/4000 sec.) shutter speed display will blink. If this happens, turn the  dial to the right to set a higher aperture f/number or decrease the ISO speed.

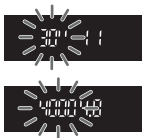

⚡ Using the Built-in Flash

To obtain a correct flash exposure, the flash output will be set automatically to match the set aperture (autoflash exposure). The shutter speed will be set automatically between 1/200 sec. - 30 sec. to suit the scene's brightness.

In low light, the main subject is exposed with the automatic flash, and the background is exposed with a slow shutter speed set automatically. Both the subject and background look properly exposed (automatic slow-speed flash sync). If you are handholding the camera, keep it steady to prevent camera shake. Using a tripod is recommended.

If you do not want a slow shutter speed to be used, set **[3: Flash sync. speed in Av mode]** to **[1: 1/200-1/60 sec. auto]** or **[2: 1/200 sec. (fixed)]** in **[F: Custom Functions (C.Fn)]** (p.252).

Depth of Field Preview ☆

The aperture opening (diaphragm) changes only at the moment when the picture is taken. Otherwise, the aperture remains fully open. Therefore, when you look at the scene through the viewfinder or LCD monitor, the depth of field will look narrow.

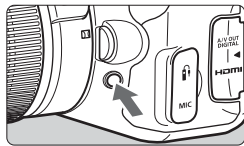

When you press the depth-of-field preview button, you can see the actual depth of field before you shoot.

 While looking at the Live View image (p.124) and holding down the depth-of-field preview button, you can change the aperture and see how the depth of field changes.

M: Manual Exposure

You can set both the shutter speed and aperture manually as desired. While referring to the exposure level indicator in the viewfinder, you can set the exposure as desired. This method is called manual exposure.



* <M> stands for Manual.

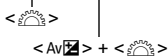
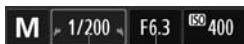

1 Set the Mode Dial to <M>.



2 Set the shutter speed and aperture.

- To set the shutter speed, turn the <  > dial.
- To set the aperture, hold down the < Av  > button and turn the <  > dial.

Standard exposure index







Exposure level mark

3 Focus the subject.

- Press the shutter button halfway.
- ▶ The exposure setting will be displayed in the viewfinder.
- The exposure level mark <  > indicates how far the current exposure level is from the standard exposure level.

4 Set the exposure and take the picture.

- Set the shutter speed and aperture as desired.
- If the exposure set exceeds ± 2 stops from the standard exposure, the end of the exposure level indicator will display <  > or <  > in the viewfinder. (On the LCD monitor, if the exposure level exceeds ± 3 stops, the <  > icon will blink at where < -3 > or < +3 > is displayed.)

 If [ Auto Lighting Optimizer] (p.109) is set to any setting other than [Disable], the image may still look bright even if a darker exposure has been set.

⚡ Using the Built-in Flash

To obtain a correct flash exposure, the flash output will be set automatically (autoflash exposure) to match the manually-set aperture. The flash sync speed can be set from 1/200 sec. to 30 sec. and bulb.

BULB: Bulb Exposures

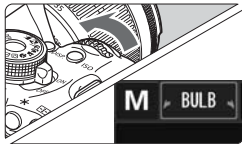

A bulb exposure keeps the shutter open for as long as you hold down the shutter button. It can be used to photograph fireworks, etc.

In step 2 on the preceding page, turn the <⚙> dial to the left to set <BULB>.

The elapsed exposure time will be displayed on the LCD monitor.

- ⚠ During the bulb exposure, do not point the lens toward the sun. The sun's heat can damage the camera's internal components.
- Since bulb exposures produce more noise than usual, the image might look a little grainy.
- You can reduce the noise due to long exposures by setting [4: Long exp. noise reduction] to [1: Auto] or [2: On] in the [⚡: Custom Functions (C.Fn)] (p.253).

- 📷 ● For bulb exposures, using a tripod and Remote Switch (sold separately, p.262) is recommended.
- You can also use a remote controller (sold separately, p.261) for bulb exposures. When you press the remote controller's transmit button, the bulb exposure will start immediately or 2 sec. later. Press the button again to stop the bulb exposure.

A-DEP: Automatic Depth-of-Field AE

Objects in the foreground and background will be in focus automatically. All the AF points will function to detect the subject, and the aperture required to attain the necessary depth of field will be set automatically.

* <A-DEP> stands for Auto-Depth of field. This mode sets the depth of field automatically.



1 Set the Mode Dial to <A-DEP>.

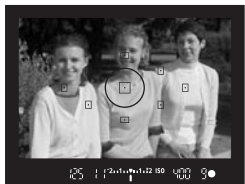

2 Focus the subject.

- Aim the AF points over the subjects and press the shutter button halfway (ⓘ4).
- All the subjects covered by the AF points flashing in red will be in focus.
- If focus is not achieved, the picture cannot be taken.

3 Take the picture.



FAQ

- **The aperture display in the viewfinder blinks.**
The exposure is correct, but the desired depth of field cannot be obtained. Either use a wide-angle lens or move farther away from the subjects.
- **The shutter speed display in the viewfinder blinks.**
If the “30” shutter speed blinks, it means that the subject is too dark. Increase the ISO speed. If the “4000” shutter speed blinks, it means that the subject is too bright. Decrease the ISO speed.
- **A slow shutter speed has been set.**
Use a tripod to steady the camera.
- **I want to use flash.**
Flash can be used, however, the result will be the same as using the <P> mode with flash. The desired depth of field will not be obtained.



Changing the Metering Mode ☆

Four methods (metering modes) to measure the subject's brightness are provided. Normally, evaluative metering is recommended.

In Basic Zone modes, evaluative metering is set automatically.



1 Select [Metering mode].

- Under the [] tab, select [Metering mode], then press <>.



2 Set the metering mode.

- Select the desired metering mode, then press <>.

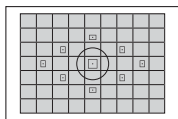

Evaluative metering

This is an all-around metering mode suited for portraits and even backlit subjects. The camera sets the exposure automatically to suit the scene.

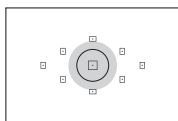

Partial metering

Effective when the background is much brighter than the subject due to backlighting, etc. The gray area in the left figure is where the brightness is metered to obtain the standard exposure.

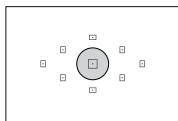



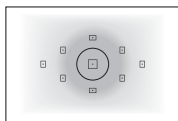

Spot metering

This is for metering a specific part of the subject or scene. The gray area in the left figure is where the brightness is metered to obtain the standard exposure. This metering mode is for advanced users.



Center-weighted average metering

The brightness is metered at the center and then averaged for the entire scene. This metering mode is for advanced users.

 With , the exposure setting will be locked when you press the shutter button halfway and focus is achieved. With , , and , the exposure setting is set at the moment of exposure. (The exposure setting is not locked when you press the shutter button halfway.)

Setting Exposure Compensation [☆]

Av Setting Exposure Compensation

Set exposure compensation if the exposure (without flash) does not come out as desired. This feature can be used in Creative Zone modes (except <M>). You can set the exposure compensation up to ± 5 stops in 1/3-stop increments.

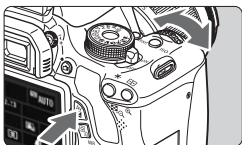



Increased exposure for a brighter image





Decreased exposure for a darker image



Making it brighter:

Hold down the <Av  > button and turn the < > dial to the right. (Increased exposure)

Making it darker:

Hold down the <Av  > button and turn the < > dial to the left. (Decreased exposure)

- ▶ As shown in the figure, the exposure level is displayed on the LCD monitor and in the viewfinder.
- **After taking the picture, cancel the exposure compensation by setting it back to 0.**





Dark exposure



Increased exposure for a brighter image



- The exposure compensation amount displayed in the viewfinder goes up to only ± 2 stops. If the exposure compensation amount exceeds ± 2 stops, the end of the exposure level indicator will display <◀> or <▶>.
- The exposure compensation can also be set with [ **Expo. comp./AEB**] (p.105). If you will set exposure compensation exceeding ± 2 stops, you should use [ **Expo. comp./AEB**] to set it.

Flash Exposure Compensation

Set flash exposure compensation if the flash exposure of the subject does not come out as desired. You can set the flash exposure compensation up to ± 2 stops in 1/3-stop increments.



1 Press the **<Q>** button. (p.10)

- ▶ The Quick Control screen will appear (p.41).



2 Select [].

- Press the **<+>** key to select [*].
- ▶ [**Flash exposure comp.**] will be displayed at the bottom.



3 Set the flash exposure compensation amount.

- To make the flash exposure brighter, turn the **<+>** dial to the right.
To make it darker, turn the **<+>** dial to the left. (Decreased exposure)
- ▶ When you press the shutter button halfway, the **<+>** icon will appear in the viewfinder.
- **After taking the picture, cancel the flash exposure compensation by setting it back to 0.**

 If [**Auto Lighting Optimizer**] (p.109) is set to any setting other than [**Disable**], the image may look bright even if a decreased exposure compensation or decreased flash exposure compensation has been set.

 You can also set flash exposure compensation with [**Built-in flash func. setting**] in [**Flash control**] (p.181).

MENU Auto Exposure Bracketing ☆

This feature takes exposure compensation a step further by varying the exposure automatically (up to ± 2 stops in 1/3-stop increments) with three shots as shown below. You can then choose the best exposure. This is called AEB (Auto Exposure Bracketing).



Standard exposure



Darker exposure
(Decreased exposure)



Brighter exposure
(Increased exposure)



1 Select [Expo. comp./AEB].

- Under the [] tab, select [Expo. comp./AEB], then press <SET>.

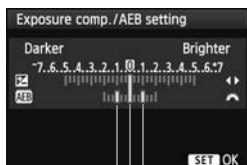

2 Set the AEB amount.

- Turn the < > dial to set the AEB amount.
- Press the < > key to set the exposure compensation amount. If AEB is combined with exposure compensation, AEB will be applied centering on the exposure compensation amount.
- Press <SET> to set it.
- When you press the <MENU> button to exit the menu, the AEB level will be displayed on the LCD monitor.

AEB amount



3 Take the picture.

- Focus and press the shutter button completely. The three bracketed shots will be taken in this sequence: Standard exposure, decreased exposure, and increased exposure.

Canceling AEB

- Follow steps 1 and 2 to turn off the AEB amount display.
- The AEB setting will also be canceled automatically if the power switch is set to <OFF>, flash recycling is completed, etc.



Shooting Tips

● Using AEB with continuous shooting:

If <[]> continuous shooting (p.88) has been set and you press the shutter button completely, the three bracketed shots will be taken continuously in this sequence: Standard exposure, decreased exposure, and increased exposure.

● Using AEB with <[]> single shooting.

Press the shutter button three times to take the three bracketed shots. The three bracketed shots will be exposed in the following sequence: Standard exposure, decreased exposure, and increased exposure.

● Using AEB with the self-timer or remote control (sold separately).

With the self-timer or remote control (<[]> or <[]>), you can take three continuous shots after a 10-sec. or 2-sec. delay. With <[]> (p.89) set, the number of continuous shots will be three times the number set.

- Neither flash nor bulb exposures can be used with AEB.
- If [] Auto Lighting Optimizer (p.109) is set to any setting other than [Disable], the AEB's effect might be minimal.

✳ Locking the Exposure ☆

You can lock the exposure when the area of focus is to be different from the exposure metering area or when you want to take multiple shots at the same exposure setting. Press the <✳> button to lock the exposure, then recompose and take the shot. This is called AE lock. It is effective for backlit subjects.

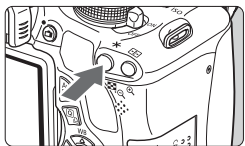

1 Focus the subject.

- Press the shutter button halfway.
- ▶ The exposure setting will be displayed.

2 Press the <✳> button. (☉4)

- ▶ The <✳> icon lights in the viewfinder to indicate that the exposure setting is locked (AE lock).
- Each time you press the <✳> button, it locks the current autoexposure setting.





3 Recompose and take the picture.

- If you want to maintain the AE lock while taking more shots, hold down the <✳> button and press the shutter button to take another shot.



AE Lock Effects

Metering Mode (p.102)	AF Point Selection Method (p.85)	
	Automatic Selection	Manual Selection
 *	AE lock is applied at the AF point that achieved focus.	AE lock is applied at the selected AF point.
	AE lock is applied at the center AF point.	

* When the lens' focus mode switch is set to <MF>, AE lock is applied at the center AF point.

✳ Locking the Flash Exposure ☆

If the subject is on the side of the frame and you use flash, the subject may turn out to be too bright or dark depending on the background, etc. This is when you should use FE lock. After setting the proper flash exposure for the subject, you can recompose (put the subject toward the side) and shoot. This feature can also be used with a Canon EX-series Speedlite.

* FE stands for Flash Exposure.

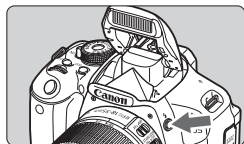

1 Press the $\langle \text{lightning bolt} \rangle$ button.

- ▶ The built-in flash will rise.
- Press the shutter button halfway and look in the viewfinder to check that the $\langle \text{lightning bolt} \rangle$ icon is lit.



Spot metering circle

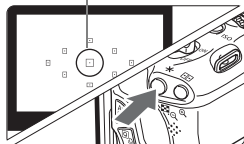

2 Focus the subject.

3 Press the $\langle \text{star} \rangle$ button. (☉16)

- Aim the spot-metering circle over the subject, then press the $\langle \text{star} \rangle$ button.
- ▶ The flash will fire a preflash and the required flash output is calculated and retained in memory.
- ▶ In the viewfinder, “FEL” is displayed for a moment and $\langle \text{lightning bolt} \text{ star} \rangle$ will light.
- Each time you press the $\langle \text{star} \rangle$ button, a preflash is fired and the required flash output is calculated and retained in memory.



4 Take the picture.

- Compose the shot and press the shutter button completely.
- ▶ The flash is fired when the picture is taken.



⚠ If the subject is too far away and beyond the effective range of the flash, the $\langle \text{lightning bolt} \rangle$ icon will blink. Get closer to the subject and repeat steps 2 to 4.

MENU Correcting the Brightness and Contrast Automatically ☆

If the image comes out dark or the contrast is low, the brightness and contrast can be corrected automatically. This feature is called Auto Lighting Optimizer. The default setting is [**Standard**]. With JPEG images, the correction is done when the image is captured. For RAW images, it can be corrected with Digital Photo Professional (provided software, p.302).



1 Select [**Auto Lighting Optimizer**].

- Under the [**Auto**] tab, select [**Auto Lighting Optimizer**], then press <SET>.



2 Select the setting.

- Select the desired setting, then press <SET>.

3 Take the picture.

- The image will be recorded with the brightness and contrast corrected if necessary.



Without correction



With correction



- Under [**Custom Functions (C.Fn)**], if [**6: Highlight tone priority**] is set to [**1: Enable**], the Auto Lighting Optimizer will be set automatically to [**Disable**] and you cannot change this setting.
- Depending on the shooting conditions, noise might increase.
- If a setting other than [**Disable**] is set and you use exposure compensation, flash exposure compensation, or manual exposure to darken the exposure, the image might still come out bright. If you want a darker exposure, set [**Auto Lighting Optimizer**] to [**Disable**] first.



In Basic Zone modes, [**Standard**] is set automatically.

MENU Correcting the Image's Dark Corners ■

Due to the lens characteristics, the four corners of the picture might look darker. This phenomenon is called lens light fall-off or drop in peripheral illumination and can be corrected automatically. The default setting is **[Enable]**. With JPEG images, the correction is done when the image is captured. For RAW images, it can be corrected with Digital Photo Professional (provided software, p.302).

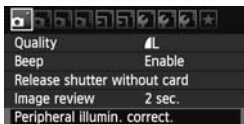

1 Select **[Peripheral illumin. correct.]**.

- Under the [] tab, select **[Peripheral illumin. correct.]**, then press <SET>.

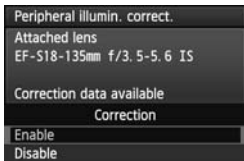

2 Select the setting.

- On the screen, check that **[Correction data available]** is displayed for the attached lens.
- If **[Correction data not available]** is displayed, see “About the Lens Correction Data” on the next page.
- Select **[Enable]**, then press <SET>.

3 Take the picture.

- The image will be recorded with the corrected peripheral illumination.



Correction disabled



Correction enabled

About the Lens Correction Data

The camera already contains lens peripheral illumination correction data for approx. 25 lenses. In step 2, if you select **[Enable]**, the peripheral light correction will be applied automatically for any lens whose correction data has been registered in the camera.

With EOS Utility (provided software, p.302), you can check which lenses have their correction data registered in the camera. You can also register the correction data for unregistered lenses. For details, see the Software Instruction Manual (CD-ROM) for EOS Utility (p.304).



- For JPEG images already captured, lens peripheral illumination correction cannot be applied.
- Depending on shooting conditions, noise might appear on the image periphery.
- When using a non-Canon lens, setting the correction to **[Disable]** is recommended, even if **[Correction data available]** is displayed.



- Lens peripheral light correction is also applied when an Extender is attached.
- If the correction data for the attached lens has not been registered to the camera, the result will be the same as when the correction is set to **[Disable]**.
- The correction amount applied will be slightly lower than the maximum correction amount settable with Digital Photo Professional (provided software).
- If the lens does not have distance information, the correction amount will be lower.
- The higher the ISO speed, the lower the correction amount will be.

Customizing Image Characteristics ☆

You can customize a Picture Style by adjusting individual parameters like **[Sharpness]** and **[Contrast]**. To see the resulting effects, take test shots. To customize **[Monochrome]**, see page 114.

1 Press the **<V [INFO] >** button.



2 Select a Picture Style.

- Select a Picture Style, then press the **<INFO>** button.
- ▶ The Detail set. screen will appear.

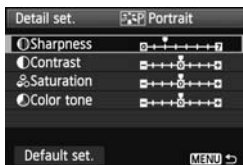

3 Select a parameter.

- Select a parameter such as **[Sharpness]**, then press **<SET>**.



4 Set the parameter.

- Press the **<◀▶>** key to adjust the parameter as desired, then press **<SET>**.
- Press the **<MENU>** button to save the adjusted parameters. The Picture Style selection screen will reappear.
- ▶ Any parameter settings different from the default will be displayed in blue.



Parameter Settings and Effects

Sharpness

Adjusts the sharpness of the image.

To make it less sharp, set it toward the **0** end. The closer it is to **0**, the softer the image will look.

To make it sharper, set it toward the **7** end. The closer it is to **7**, the sharper the image will look.

Contrast

Adjusts the image contrast and the vividness of colors.

To decrease the contrast, set it toward the minus end. The closer it is to **-**, the blander the image will look.

To increase the contrast, set it toward the plus end. The closer it is to **+**, the crisper the image will look.

Saturation

The image's color saturation can be adjusted.

To decrease the color saturation, set it toward the minus end. The closer it is to **-**, the more diluted the colors will look.

To increase the color saturation, set it toward the plus end. The closer it is to **+**, the bolder the colors will look.

Color tone

The skin tones can be adjusted.

To make the skin tone redder, set it toward the minus end. The closer it is to **-**, the redder the skin tone will look.

To make the skin tone less red, set it toward the plus end. The closer it is to **+**, the more yellow the skin tone will look.



- By selecting [**Default set.**] in step 3, you can revert the respective Picture Style to its default parameter settings.
- To shoot with the Picture Style you modified, follow step 2 on page 81 to select the modified Picture Style and then shoot.

Monochrome Adjustment

For Monochrome, you can also set **[Filter effect]** and **[Toning effect]** in addition to **[Sharpness]** and **[Contrast]** explained on the preceding page.

Filter Effect

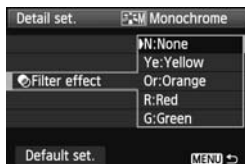

With a filter effect applied to a monochrome image, you can make white clouds or green trees stand out more.

Filter	Sample Effects
N: None	Normal black-and-white image with no filter effects.
Ye: Yellow	The blue sky will look more natural, and the white clouds will look crisper.
Or: Orange	The blue sky will look slightly darker. The sunset will look more brilliant.
R: Red	The blue sky will look quite dark. Fall leaves will look crisper and brighter.
G: Green	Skin tones and lips will look fine. Tree leaves will look crisper and brighter.

Increasing the **[Contrast]** will make the filter effect more pronounced.

Toning Effect

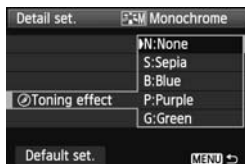

By applying a toning effect, you can create a monochrome image in that color. It can make the image look more impressive.

The following can be selected: **[N:None]**, **[S:Sepia]**, **[B:Blue]**, **[P:Purple]** or **[G:Green]**.

Registering Preferred Image Characteristics ☆

You can select a base Picture Style such as [Portrait] or [Landscape], adjust its parameters as desired and register it under [User Def. 1], [User Def. 2], or [User Def. 3].

You can create Picture Styles whose parameter settings such as sharpness and contrast are different. You can also adjust the parameters of a Picture Style which has been registered to the camera with EOS Utility (provided software, p.302).

1 Press the <▼ > button.



2 Select [User Def.].

- Select [User Def. *], then press the <INFO.> button.
- ▶ The Detail set. screen will appear.



3 Press <SET>.

- With [Picture Style] selected, press <SET>.



4 Select the base Picture Style.

- Press the <▲▼> key to select the base Picture Style, then press <SET>.
- To adjust the parameters of a Picture Style which has been registered to the camera with EOS Utility (provided software), select the Picture Style here.



5 Select a parameter.

- Select a parameter such as **[Sharpness]**, then press < **SET** >.

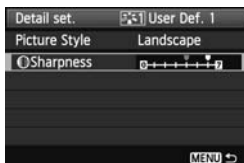

6 Set the parameter.

- Press the < **◀▶** > key to adjust the parameter as desired, then press < **SET** >.
For details, see “Customizing Image Characteristics” on pages 112-114.
- Press the < **MENU** > button to register the modified Picture Style. The Picture Style selection screen will then reappear.
- ▶ The base Picture Style will be indicated on the right of **[User Def. *]**.

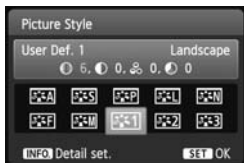

- If a Picture Style has already been registered under **[User Def. *]**, changing the base Picture Style in step 4 will nullify the parameter settings of the registered Picture Style.
- If you execute **[Clear all camera settings]** (p.176), all the **[User Def. *]** settings will revert to the default. Any Picture Style registered via EOS Utility (provided software) will have only its modified parameters reverted to the default setting.

 To shoot with a registered Picture Style, follow step 2 on page 81 to select **[User Def. *]** and then shoot.

WB: Matching the Light Source ☆

The function adjusting the color tone so that white objects look white in the picture is called white balance (WB). Normally, the <AWB> (Auto) setting will obtain the correct white balance. If natural-looking colors cannot be obtained with <AWB>, you can select the white balance to match the light source or set it manually by shooting a white object.



1 Press the <▲ WB> button.

▶ [White balance] will appear.

2 Select the white balance.

- Press the <◀▶> key or turn the <☀> dial to select the desired white balance, then press <SET>.
- The “Approx. ****K” (K: Kelvin) displayed for the following white balance settings <☀>, <🏠>, <☁>, <🌧> or <🌞> is the respective color temperature.

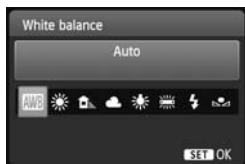

📷 Custom White Balance

Custom white balance enables you to manually set the white balance for a specific light source for better accuracy. Do this procedure under the actual light source to be used.

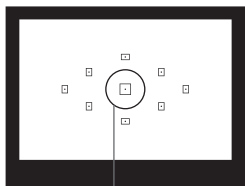

Spot metering circle

1 Photograph a white object.

- The plain, white object should fill the spot metering circle.
- Focus manually and set the standard exposure for the white object.
- You can set any white balance.



2 Select [Custom White Balance].

- Under the [WB] tab, select [**Custom White Balance**], then press <SET>.
- ▶ The custom white balance selection screen will appear.

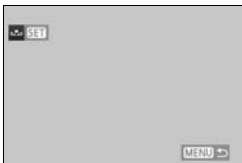

3 Import the white balance data.

- Select the image that was captured in step 1, then press <SET>.
- ▶ On the dialog screen which appears, select [OK] and the data will be imported.
- When the menu reappears, press the <MENU> button to exit the menu.

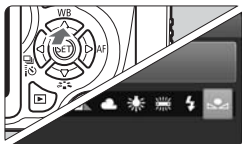

4 Select the custom white balance.

- Press the <▲ WB> button.
- Select [WB], then press <SET>.

- If the exposure obtained in step 1 is way off, a correct white balance might not be obtained.
- An image captured while the Picture Style was set to [**Monochrome**] (p.82) or an image processed with a Creative filter cannot be selected in step 3.

- Instead of a white object, an 18% gray card (commercially available) can produce a more accurate white balance.
- The personal white balance registered with EOS Utility (provided software, p.302) will be registered under <[WB]>. If you do step 3, the data for the registered personal white balance will be erased.

WB $\frac{+}{-}$ Adjusting the Color Tone for the Light Source ☆

You can correct the white balance that has been set. This adjustment will have the same effect as using a commercially-available color temperature conversion filter or color compensating filter. Each color can be corrected to one of nine levels.

This is for advanced users who are familiar with using color temperature conversion or color compensating filters.

White Balance Correction



1 Select [WB Shift/BKT].

- Under the [$\frac{+}{-}$] tab, select [**WB Shift/BKT**], then press <SET>.
- ▶ The WB correction/WB bracketing screen will appear.

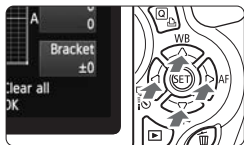

2 Set the white balance correction.

- Press the <◊> key to move the “■” mark to the desired position.
- B is for blue, A is amber, M is magenta, and G is green. The color in the respective direction will be corrected.
- On the upper right, “Shift” indicates the direction and correction amount.
- Pressing the <INFO.> button will cancel all the [**WB Shift/BKT**] settings.
- Press <SET> to exit the setting and return to the menu.

Sample setting: A2, G1

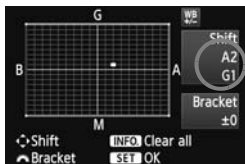

- During the white balance correction, <WB $\frac{+}{-}$ > will be displayed in the viewfinder and on the LCD monitor.
- One level of the blue/amber correction is equivalent to 5 mireds of a color temperature conversion filter. (Mired: Measuring unit indicating the density of a color temperature conversion filter.)

White Balance Auto Bracketing

With just one shot, three images having a different color balance can be recorded simultaneously. Based on the color temperature of the current white balance setting, the image will be bracketed with a blue/amber bias or magenta/green bias. This is called white balance bracketing (WB-BKT). White balance bracketing is possible up to ± 3 levels in single-level increments.

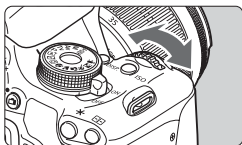

B/A bias ± 3 levels

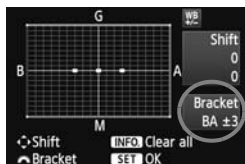

Set the white balance bracketing amount.

- In step 2 for white balance correction, when you turn the <WB> dial, the “■” mark on the screen will change to “■■■” (3 points). Turning the dial to the right sets the B/A bracketing, and turning it to the left sets the M/G bracketing.
- ▶ On the right, “Bracket” indicates the bracketing direction and correction amount.
- Pressing the <INFO.> button will cancel all the [WB Shift/BKT] settings.
- Press <SET> to exit the setting and return to the menu.

Bracketing Sequence

The images will be bracketed in the following sequence: 1. Standard white balance, 2. Blue (B) bias, and 3. Amber (A) bias, or 1. Standard white balance, 2. Magenta (M) bias, and 3. Green (G) bias.

⚠ During WB bracketing, the maximum burst for continuous shooting will be lower and the number of possible shots will also decrease to one-third the normal number.

- You can also set white balance correction and AEB (p.105) together with white balance bracketing. If you set AEB in combination with white balance bracketing, a total of nine images will be recorded for a single shot.
- Since three images are recorded for one shot, the card will take longer to record the shot.
- “BKT” stands for Bracketing.

MENU Setting the Color Reproduction Range ☆

The range of reproducible colors is called the color space. With this camera, you can set the color space to sRGB or Adobe RGB for captured images. For normal shooting, sRGB is recommended. In Basic Zone modes, sRGB is set automatically.

1 Select [Color space].

- Under the [M] tab, select [Color space], then press <SET>.

2 Set the desired color space.

- Select [sRGB] or [Adobe RGB], then press <SET>.

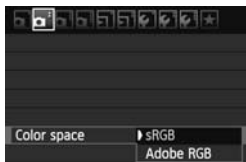

About Adobe RGB

This color space is mainly used for commercial printing and other industrial uses. This setting is not recommended if you do not know about image processing, Adobe RGB, and Design rule for Camera File System 2.0 (Exif 2.21).

The image will look very subdued in a sRGB personal computer environment and with printers not compatible with Design rule for Camera File System 2.0 (Exif 2.21). Post-processing of the image with software will therefore be required.



- If the image is captured with the color space set to Adobe RGB, the file name will start with “_MG_” (first character is an underscore).
- The ICC profile is not appended. See explanations about the ICC profile in the Software Instruction Manual (p.304) in the CD-ROM.

Mirror Lock-up to Reduce Camera Shake ☆ ■

The camera's mechanical shake caused by the reflex mirror action can blur images taken with a super telephoto lens or close-up (macro) lens. In such cases, mirror lockup is effective.

Mirror lockup is enabled by setting [8: Mirror lockup] to [1: Enable] in the [☛: Custom Functions (C.Fn)] (p.255).

1 Focus the subject, then press the shutter button completely.

- ▶ The mirror will swing up.

2 Press the shutter button completely again.

- ▶ The picture is taken and the mirror goes back down.
- After taking the picture, set [8: Mirror lockup] to [0: Disable].



Shooting Tips

● Using the self-timer <☛> <☛2> with mirror lockup.

When you press the shutter button completely, the mirror locks up, then the picture is taken 10 sec. or 2 sec. later.

● Remote control shooting.

Since you do not touch the camera when the picture is taken, remote control shooting together with mirror lockup can further prevent camera shake (p.261). With Remote Controller RC-6 (sold separately) set to a 2-sec. delay, press the transmit button and the mirror will lockup before the picture is taken 2 sec. later.



- In very bright light such as at the beach or a ski slope on a sunny day, take the picture promptly after mirror lockup.
- Do not point the camera toward the sun. The sun's heat can damage the camera's internal components.
- If you use the self-timer and mirror lockup in combination with a bulb exposure, keep pressing the shutter button completely (self-timer delay time + bulb exposure time). If you let go of the shutter button during the self-timer countdown, there will be a shutter-release sound, but no picture will be taken.



- Even if <☛> (Continuous shooting) has been set, single shooting will take effect.
- If 30 seconds elapse after the mirror has locked up, it will go back down automatically. Pressing the shutter button completely again locks up the mirror again.

5

Shooting with the LCD Monitor (Live View Shooting)

You can shoot while viewing the image on the camera's LCD monitor. This is called "Live View shooting".

Live View shooting is effective for still subjects which do not move.

If you handhold the camera and shoot while viewing the LCD monitor, camera shake can cause blurred images. Using a tripod is recommended.



About Remote Live View Shooting

With EOS Utility (provided software, p.302) installed in your computer, you can connect the camera to the computer and shoot remotely while viewing the computer screen. For details, see the Software Instruction Manual (p.304) in the CD-ROM.

Shooting with the LCD Monitor



1 Display the Live View image.

- Press the **<LIVE VIEW>** button.
- ▶ The Live View image will appear on the LCD monitor.
- The Live View image will closely reflect the brightness level of the actual image you capture.



2 Focus the subject.

- When you press the shutter button halfway, the camera will focus with the current AF mode (p.131-137).

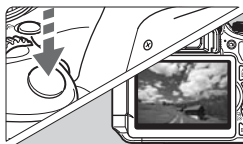

3 Take the picture.

- Press the shutter button completely.
- ▶ The picture will be taken and the captured image is displayed on the LCD monitor.
- ▶ After the image review ends, the camera will return to Live View shooting automatically.
- Press the **<LIVE VIEW>** button to exit Live View shooting.

- The image's field of view is approx. 99% (when the image-recording quality is set to JPEG **L**).
- The metering mode will be fixed to evaluative metering for Live View shooting.
- In Creative Zone modes, you can check the depth of field by pressing the depth-of-field preview button.
- During continuous shooting, the exposure set for the first shot will also be applied to subsequent shots.
- Using **<A-DEP>** will be the same as using **<P>**.
- You can also use a remote controller (sold separately, p.261) for Live View shooting.

Enabling Live View Shooting

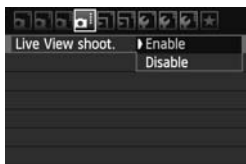

Set [**Live View shoot.**] to [**Enable**].

In Basic Zone modes, [**Live View shoot.**] will be displayed under [**☑**], and in Creative Zone modes, it will be displayed under [**☑**].

Battery Life with Live View Shooting [Approx. number of shots]

Temperature	Shooting Conditions	
	No Flash	50% Flash Use
At 23°C / 73°F	200	180
At 0°C / 32°F	170	150

- The figures above are based on a fully-charged Battery Pack LP-E8 and CIPA (Camera & Imaging Products Association) testing standards.
- With a fully-charged Battery Pack LP-E8, continuous Live View shooting is possible as for approx. 1 hr. 30 min. at 23°C / 73°F.



- During Live View shooting, do not point the lens toward the sun. The sun's heat can damage the camera's internal components.
- **Cautions for using Live View shooting are on pages 139-140.**



- When flash is used, there will be two shutter sounds, but only one shot will be taken.
- If the camera is not operated for a prolonged period, the power will turn off automatically as set with [**☑ Auto power off**] (p.167). If [**☑ Auto power off**] is set to [**Off**], the Live View function will terminate automatically after 30 min. (camera power remains on).
- With the AV cable (provided) or HDMI cable (sold separately), you can display the Live View image on a TV (p.218, 221).

About the Information Display

- Each time you press the <INFO.> button, the information display will change.

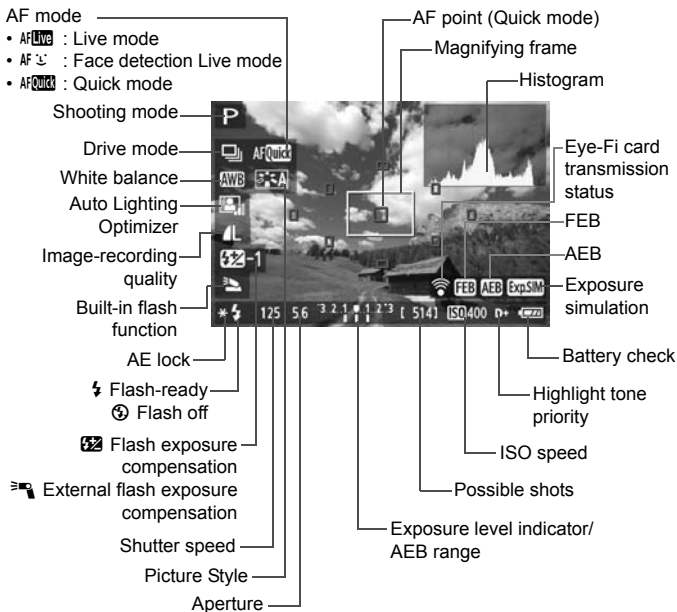

- When <Exp.SIM> is displayed in white, it indicates that the Live View image brightness is close to what the captured image will look like.
- If <Exp.SIM> is blinking, it indicates that the Live View image is not being displayed at the suitable brightness due to low- or bright-light conditions. However, the actual image recorded will reflect the exposure setting.
- If flash is used or bulb is set, the <Exp.SIM> icon and histogram will be grayed out (for your reference). The histogram might not be properly displayed in low- or bright-light conditions.

Final Image Simulation

The final image simulation reflects the effects of the Picture Style, white balance, etc., in the Live View image so you can see what the captured image will look like.

During shooting, the Live View image will automatically reflect the function settings listed below.

Final image simulation during Live View shooting

- Picture Style
 - * All parameters such as sharpness, contrast, color saturation, and color tone will be reflected.
- White balance
- White balance correction
- Shoot by ambience selection
- Shoot by lighting or scene type
- Exposure
- Depth of field (With depth-of-field preview button ON)
- Auto Lighting Optimizer
- Peripheral illumination correction
- Highlight tone priority
- Aspect ratio (Image area confirmation)

Shooting Function Settings

Function settings particular to Live View shooting are explained here.

Quick Control

While the image is displayed on the LCD monitor in Creative Zone modes, pressing the <Q> button will enable you to set the AF mode, drive mode, white balance, Picture Style, Auto Lighting Optimizer, image-recording quality, and built-in flash settings. In Basic Zone modes, you can set the AF mode and the settings shown in the table on page 64.



1 Press the <Q> button.

- ▶ The functions settable with Quick Control will appear on the left of the screen.
- If the AF mode is <AFQuick>, the AF points will also be displayed. You can also select the AF point.

2 Select a function and set it.

- Press the <▲▼> key to select a function.
- ▶ The selected function and Feature guide (p.48) will appear.
- Press the <◀▶> key or turn the <DISP/AF-ON> dial to change the setting. Pressing <SET> will display the respective function's setting screen.



 In Creative Zone modes, you can set the ISO speed by pressing the <ISO> button.

Menu Function Settings



Live View shoot.	Enable
AF mode	Live mode
Grid display	Off
Aspect ratio	3:2
Metering timer	16 sec.

The menu options below are displayed.

In Basic Zone modes, the Live View menu options will be displayed under [], and in Creative Zone modes, they will be displayed under [].



- **Live View shooting**

You can set Live View shooting to [Enable] or [Disable].

- **AF mode**

You can select [Live mode] (p.131), [ Live mode] (p.132), or [Quick mode] (p.136).

- **Grid display**

With [Grid 1 ] or [Grid 2 ], you can display grid lines. It can help you level the camera vertically or horizontally.

- **Aspect ratio** [☆]

The image's aspect ratio can be set to [3:2], [4:3], [16:9], or [1:1]. The following aspect ratios will be indicated with lines on the Live View image: [4:3] [16:9] [1:1].

JPEG images will be saved with the set aspect ratio.

RAW images will always be saved with the [3:2] aspect ratio. Since the aspect ratio information is appended to the RAW image, the image will be generated in the respective aspect ratio when you process the RAW image with the provided software. In the case of the [4:3], [16:9], and [1:1] aspect ratios, the aspect-ratio lines will appear during image playback, but the lines are not actually drawn on the image.







The settings for these menu options will apply only to Live View shooting. They do not take effect during viewfinder shooting.

Quality	Aspect Ratio and Pixel Count			
	3:2	4:3	16:9	1:1
L	5184x3456 (18.0 megapixels)	4608x3456 (16.0 megapixels)	5184x2912* (15.1 megapixels)	3456x3456 (11.9 megapixels)
RAW				
M	3456x2304 (8.0 megapixels)	3072x2304 (7.0 megapixels)	3456x1944 (6.7 megapixels)	2304x2304 (5.3 megapixels)
S1	2592x1728 (4.5 megapixels)	2304x1728 (4.0 megapixels)	2592x1456* (3.8 megapixels)	1728x1728 (3.0 megapixels)
S2	1920x1280 (2.5 megapixels)	1696x1280* (2.2 megapixels)	1920x1080 (2.1 megapixels)	1280x1280 (1.6 megapixels)
S3	720x480 (350,000 pixels)	640x480 (310,000 pixels)	720x400* (290,000 pixels)	480x480 (230,000 pixels)

- Asterisked image-recording qualities do not exactly match the set aspect ratio.
- The image area displayed for asterisked image-recording qualities is slightly larger than the recorded area. Check the captured images on the LCD monitor when shooting.
- If you use a different camera to directly print images shot with this camera in the 1:1 aspect ratio, the images might not be correctly printed.

● Metering timer[☆]

You can change how long the exposure setting is displayed (AE lock time). This option is not displayed in Basic Zone modes. (Metering timer is fixed at 16 sec.)

 If you select [ **Dust Delete Data**], [ **Sensor cleaning**], [ **Clear settings**], or [ **Firmware Ver.**], the Live View shooting will terminate.

Changing the Autofocus Mode

Selecting the AF Mode

The AF modes available are [**Live mode**], [**Live mode**] (face detection, p.132), and [**Quick mode**] (p.136).

If you want to achieve precise focus, set the lens focus mode switch to <MF>, magnify the image, and focus manually (p.138).

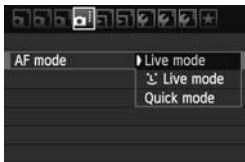

Select the AF mode.

- Under the [**AF**] tab, select [**AF mode**] ([**AF**] tab in Basic Zone modes).
- Select the desired AF mode, then press <SET>.
- While the Live View image is displayed, you can press the <Q> button to select the AF mode on the Quick Control screen (p.128).

Live Mode: AF Live

The image sensor is used to focus. Although AF is possible with the Live View image displayed, **the AF operation will take longer than with the Quick mode**. Also, achieving focus may be more difficult than with the Quick mode.



1 Display the Live View image.

- Press the <CAM> button.
- ▶ The Live View image will appear on the LCD monitor.
- ▶ The AF point <□> will appear.

2 Move the AF point.

- Press the <◇> key to move the AF point to where you want to focus (it cannot go to the edges of the picture).
- To return the AF point to the center, press the <SET> or <W> button.

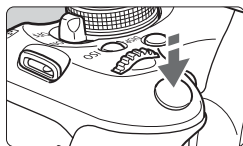

3 Focus the subject.

- Aim the AF point over the subject and press the shutter button halfway.
- ▶ When focus is achieved, the AF point will turn green and the beeper will sound.
- ▶ If focus is not achieved, the AF point will turn orange.



4 Take the picture.

- Check the focus and exposure, then press the shutter button completely to take the picture (p.124).

☺ (Face detection) Live Mode: AF ☺

With the same AF method as the Live mode, human faces are detected and focused. Have the target person face the camera.



1 Display the Live View image.

- Press the <📷> button.
- ▶ The Live View image will appear on the LCD monitor.
- When a face is detected, the <☺> frame will appear over the face to be focused.
- If multiple faces are detected, <☺☺> will be displayed. Press the <◀▶> key to move the <☺> frame over the desired target face.

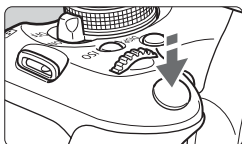

2 Focus the subject.

- Press the shutter button halfway and the camera will focus the face covered by the <[]> frame.
- ▶ When focus is achieved, the AF point will turn green and the beeper will sound.
- ▶ If focus is not achieved, the AF point will turn orange.
- If a face cannot be detected, the AF point <[]> will be displayed and AF will be executed at the center.



3 Take the picture.

- Check the focus and exposure, then press the shutter button completely to take the picture (p.124).





- If the focus is way off, face detection will not be possible. If the lens enables manual focusing even while the lens focus mode switch is set to <AF>, turn the focusing ring to attain rough focus. The face will then be detected and <[]> will be displayed.
- An object other than a human face might be detected as a face.
- Face detection will not work if the face is very small or large in the picture, too bright or too dark, tilted horizontally or diagonally, or partially hidden.
- The <[]> focusing frame might cover only part of the face.





- When you press the <[SET]> or <[AF-ON]> button, the AF mode will switch to the Live mode (p.131). You can press the <[L]> key to move the AF point. Press the <[SET]> or <[AF-ON]> button again to return to the <[L]> (face detection) Live mode.
- Since AF is not possible with a face detected near the edge of the picture, the <[]> will be grayed out. Then if you press the shutter button halfway, the center AF point <[]> will be used to focus.

Live Mode and (Face Detection) Live Mode Notes

AF operation

- Focusing will take slightly longer.
- Even when focus has been achieved, pressing the shutter button halfway will focus again.
- The image brightness may change during and after the AF operation.
- If the light source changes while the Live View image is displayed, the screen might flicker and focusing may be difficult. If this happens, stop the Live View shooting and autofocus under the actual light source first.
- If you press the  button in the Live mode, the image will be magnified at the AF point. If focusing is difficult in the magnified view, return to the normal view and autofocus. Note that the AF speed may differ between the normal and magnified views.
- If you autofocus in the Live mode's normal view and then magnify the image, the focus might be off.
- In the  Live mode, pressing the  button will not magnify the image.



- In the Live mode or  (face detection) Live mode, if you shoot a peripheral subject and it is slightly out of focus, aim the center AF point over the subject to focus, then take the picture.
- The AF-assist beam will not be emitted. However, if an EX-series Speedlite (sold separately) equipped with a LED light is used, the LED light will turn on for AF-assist when necessary in the Live mode and  (face detection) Live mode.

Shooting conditions which can make focusing difficult:

- Low-contrast subjects such as the blue sky and solid-color, flat surfaces.
- Subjects in low light.
- Stripes and other patterns where there is contrast only in the horizontal direction.
- Under a light source whose brightness, color, or pattern keeps changing.
- Night scenes or points of light.
- Under fluorescent lighting or when the image flickers.
- Extremely small subjects.
- Subjects at the edge of the picture.
- Subjects strongly reflecting light.
- The AF point covers both a near and faraway subject (such as an animal in a cage).
- Subjects which keep moving within the AF point and cannot keep still due to camera shake or subject blur.
- A subject approaching or moving away from the camera.
- Autofocusing while the subject is way out of focus.
- Soft focus effect is applied with a soft focus lens.
- A special effects filter is used.

Quick Mode: AFQuick

The dedicated AF sensor is used to focus in One-Shot AF mode (p.83), using the same AF method as with viewfinder shooting.

Although you can focus the target area quickly, **the Live View image will be interrupted momentarily during the AF operation.**



Magnifying frame





1 Display the Live View image.

- Press the <  > button.
- ▶ The Live View image will appear on the LCD monitor.
- The small boxes on the screen are the AF points, and the larger box is the magnifying frame.



Quick mode

2 Select the AF point. ☆

- Press the <  > button ( 10) to display the Quick Control screen.
- ▶ The settable functions will be displayed on the left of the screen.
- Press the <  > key to make the AF point selectable.
- Turn the <  > dial to select the AF point.



Manual selection

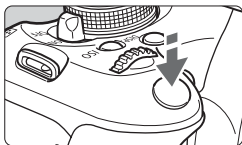

3 Focus the subject.

- Aim the AF point over the subject and press the shutter button halfway.
- ▶ The Live View image will turn off, the reflex mirror will go back down, and AF will be executed.
- ▶ When focus is achieved, the AF point which achieved focus will turn green and the Live View image will reappear.
- ▶ If focus is not achieved, the AF point will turn orange and blink.



4 Take the picture.

- Check the focus and exposure, then press the shutter button completely to take the picture (p.124).



You cannot take a picture during autofocus. Take the picture while the Live View image is displayed.

MF: Focusing Manually

You can magnify the image and focus precisely manually.

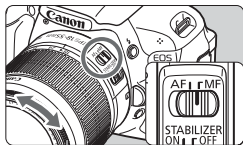

1 Set the lens focus mode switch to <MF>.

- Turn the lens focusing ring to focus roughly.



Magnifying frame

2 Move the magnifying frame.

- Press the <⬆> key to move the magnifying frame to the position where you want to focus.
- To return the magnifying frame to the center, press the <SET> or <⌫> button.

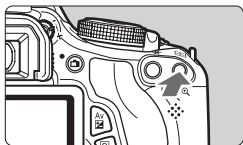

3 Magnify the image.

- Press the <Q> button.
- ▶ The area within the magnifying frame will be magnified.
- Each time you press the <Q> button, the view will change as follows:

→ 5x → 10x → Normal view →



AE lock

Magnified area position

Magnification

4 Focus manually.

- While looking at the magnified image, turn the lens focusing ring to focus.
- After achieving focus, press the <Q> button to return to the normal view.

5 Take the picture.

- Check the focus and exposure, then press the shutter button to take the picture (p.124).



Live View Shooting Cautions

White and Red Internal Temperature Warning Icons

- If the camera's internal temperature increases due to prolonged Live View shooting or a high ambient temperature, a white icon will appear. If you continue shooting while this icon is displayed, the image quality of still photos may deteriorate. You should stop the Live View shooting and allow the camera to cool down before shooting again.
- If the camera's internal temperature further increases while the white icon is displayed, a red icon will start blinking. This blinking icon is a warning that the Live View shooting will soon be terminated automatically. If this happens, you will not be able to shoot again until the camera's internal temperature decreases. Turn off the power and let the camera rest for a while.
- Shooting with the Live View function at a high temperature for a prolonged period will cause the and icons to appear earlier. When not shooting, turn off the camera.

Live View Image Cautions

- Under low- or bright-light conditions, the Live View image might not reflect the brightness of the captured image.
- If the light source within the image changes, the screen might flicker. If this happens, stop the Live View shooting and resume shooting under the actual light source to be used.
- If you point the camera in a different direction, it might throw off the Live View image's correct brightness momentarily. Wait until the brightness level stabilizes before shooting.
- If there is a very bright light source in the picture, such as the sun, the bright area might appear black on the LCD monitor. However, the actual captured image will correctly show the bright area.
- In low light, if you set the [ LCD brightness] to a bright setting, chrominance noise may appear in the Live View image. However, the chrominance noise will not be recorded in the captured image.
- When you magnify the image, the image sharpness may look more pronounced than it really is.

Live View Shooting Cautions

Shooting Result Cautions

- When you shoot continuously with the Live View function for a long period, the camera's internal temperature may increase and it can degrade image quality. Terminate Live View shooting when not shooting images.
- Before taking a long exposure, stop Live View shooting temporarily and wait several minutes before shooting. This is to prevent image degradation.
- Live View shooting in high temperatures and at high ISO speeds may cause noise or irregular colors.
- When you shoot at high ISO speeds, noise (banding, dots of light, etc.) may become noticeable.
- If you take the picture during magnified view, the exposure might not come out as desired. Return to the normal view before taking the picture. During the magnified view, the shutter speed and aperture will be displayed in orange. Even if you take the picture during magnified view, the image will be captured in the normal view.
- If [**Auto Lighting Optimizer**] (p.109) is not set to [**Disable**], the image may look bright even if a decreased exposure compensation or decreased flash exposure compensation has been set.
- If you use a TS-E lens to shift the lens vertically or use an Extension Tube, the standard exposure might not be obtained or an irregular exposure may result.

Custom Function Cautions

- During Live View shooting, certain Custom Function settings will not take effect (p.251).

Lens and Flash Cautions

- The focus preset feature on super telephoto lenses cannot be used.
- FE lock is not possible when the built-in flash or an external Speedlite is used. Modeling flash will not work with an external Speedlite.

6

Shooting Movies

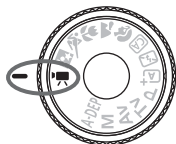

Set the Mode Dial to <[Movie Camera Icon]> to shoot movies. The movie recording format will be MOV.

Cards which can record movies

When shooting movies, use a large-capacity SD card rated SD Speed Class 6 “CLASS 6” or higher.

If you use a slow-writing card when shooting movies, the movie might not be recorded properly. And if you playback a movie on a card having a slow reading speed, the movie might not playback properly.

To check the card's read/write speed, refer to the card manufacturer's Web site.



About Full HD 1080

Full HD 1080 indicates compatibility with High-Definition featuring 1080 vertical pixels (scanning lines).



Shooting Movies

Connecting the camera to a TV set is recommended to playback the movies shot (p.218, 221).

Autoexposure Shooting



1 Set the Mode Dial to <Movie Mode>.

- ▶ The reflex mirror will make a sound, then the image will appear on the LCD monitor.

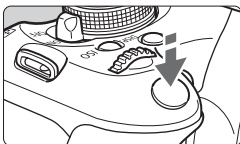

2 Focus the subject.

- Before shooting a movie, autofocus or manual focus (p.131-138).
- When you press the shutter button halfway, the camera will focus with the current AF mode.



3 Shoot the movie.

- Press the <Movie Mode> button to start shooting a movie. To stop movie shooting, press <Movie Mode> again.
- ▶ While the movie is being shot, the “●” mark will be displayed on the upper right of the screen.

Recording movie



Microphone



- During movie shooting, do not point the lens toward the sun. The sun's heat can damage the camera's internal components.
- **Cautions for movie shooting are on pages 163 and 164.**
- **If necessary, also read the Live View shooting cautions on pages 139 and 140.**



- The ISO speed, shutter speed, and aperture are set automatically.
- AE lock is possible by pressing the < * > button (p.107). To cancel AE lock during movie shooting, press the < [] > button.
- By holding down the < Av [] > button and turning the < [] > dial, you can set the exposure compensation.
- Pressing the shutter button halfway displays the shutter speed, aperture, and ISO speed (p.146) on the screen's bottom. This is the exposure setting for taking a still photo.
- On the shooting information display (p.227), if you playback a movie shot with autoexposure, the shutter speed and aperture will not be displayed. The image information (Exif) will record the settings used at the start of the movie shooting.

Using an EX-series Speedlite (Sold Separately) Equipped with a LED Light

This camera is compatible with the function turning on the LED light automatically in low-light conditions during autoexposure shooting. **For details, see the EX-series Speedlite's instruction manual.**

Manual Exposure Shooting

You can manually set the shutter speed, aperture, and ISO speed for movie shooting. Using manual exposure to shoot movies is for advanced users.



1 Set the Mode Dial to <M>.

- ▶ The reflex mirror will make a sound, then the image will appear on the LCD monitor.



2 Select [Movie exposure].

- Press the <MENU> button and under the [M] tab, select [Movie exposure], then press <SET>.



3 Select [Manual].

- Select [Manual], then press <SET>.



4 Set the shutter speed and aperture.

- To set the shutter speed, turn the <G> dial. The settable shutter speeds depend on the frame rate <F>.

 - 1/60 / 1/50 : 1/4000 sec. - 1/60 sec.
 - 1/30 / 1/25 / 1/24 : 1/4000 sec. - 1/30 sec.

- To set the aperture, hold down the <Av> button and turn the <G> dial.

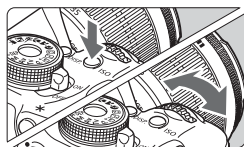

5 Set the ISO speed.

- Press the <ISO> button and press the <L/R> key or turn the <G> dial to select the ISO speed.

 - [AUTO] setting : ISO 100 - 6400
 - Manual ISO setting : ISO 100 - 6400

6 Focus and shoot the movie.

- The procedure is the same as steps 2 and 3 for “Autoexposure Shooting” (p.142).



- AE lock and exposure compensation cannot be set.
- Changing the shutter speed or aperture during movie shooting is not recommended since the changes in the exposure will be recorded.
- If you use a lens whose maximum aperture changes while you zoom, you should not zoom while shooting a movie. Changes in the exposure may be recorded.
- If you shoot a movie under fluorescent lighting, the movie image might flicker.



- With ISO Auto, the standard movie exposure will usually be obtained even if the light level changes.
- When shooting a movie of a moving subject, a shutter speed of 1/30 sec. to 1/125 sec. is recommended. The faster the shutter speed, the less smooth the subject's movement will look.

About the Information Display

- Each time you press the <INFO.> button, the information display will change.

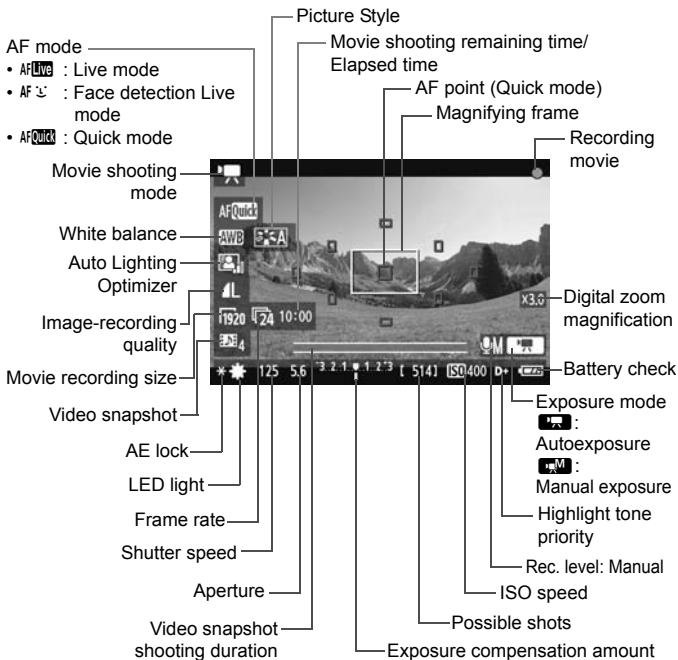

* When an Eye-Fi card has been inserted in the camera, the Eye-Fi transmission status (p.265) will be displayed.

- If there is no card in the camera, the movie shooting remaining time will be displayed in red.
- When movie shooting starts, the movie shooting remaining time will change to the elapsed time.



Notes for Both Autoexposure and Manual Exposure Shooting

- A movie file is recorded each time you shoot a movie.
- The image's field of view is approx. 99%.
- The sound will be recorded by the camera's built-in monaural microphone (p.142).
- Stereo sound recording is possible by connecting an external microphone (commercially available) equipped with a stereo mini plug (3.5mm dia.) to the camera's external microphone IN terminal (p.18).
- Movie-related settings are under the [], [], and [] menu tabs (p.157).
- With a fully-charged Battery Pack LP-E8, the total shooting time will be as follows: At 23°C/73°F: Approx. 1 hr. 40 min., At 0°C/32°F: Approx. 1 hr. 20 min.

Final Image Simulation

The final image simulation reflects the effects of the Picture Style, white balance, etc., in the movie image so you can see what the captured movie will look like.

During movie shooting, the movie image will automatically reflect the settings listed below.

Final image simulation for movie shooting

- Picture Style
 - * All parameters such as sharpness, contrast, color saturation, and color tone will be reflected.
- White balance
- Exposure
- Depth of field
- Auto Lighting Optimizer
- Peripheral illumination correction
- Highlight tone priority

Shooting Still Photos

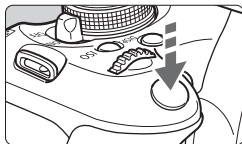

While shooting a movie, you can also take a still photo by pressing the shutter button completely.

Shooting Stills in the <Movie> Mode

- If you take a still photo during movie shooting, the movie will record a still moment lasting approx. 1 sec.
- The captured still photo will be recorded to the card, and the movie shooting will resume automatically when the Live View image is displayed.
- The movie and still photo will be recorded as separate files on the card.
- Functions particular to still shooting are shown below. Other functions will be the same as for movie shooting.

Function	Settings
Image-recording quality	As set in [Quality]. When the movie-recording size is [1920x1080] or [1280x720], the aspect ratio will be 16:9. When the size is [640x480], the aspect ratio will be 4:3.
Exposure setting	<ul style="list-style-type: none"> • Autoexposure shooting: Shutter speed and aperture automatically set (displayed when pressing the shutter button halfway). • Manual exposure shooting: Shutter speed and aperture manually set.
AEB	Canceled
Drive mode	Single shooting (Self-timer not possible)
Flash	Flash off

Shooting Function Settings

Function settings particular to movie shooting are explained here.

Q Quick Control

While the image is displayed on the LCD monitor, you can press the <Q> button to set the AF mode, white balance, Picture Style, Auto Lighting Optimizer, image-recording quality (for still photos), movie-recording size, movie digital zoom, and video snapshots.



1 Press the <Q> button. (10)

- ▶ The functions settable with Quick Control will appear on the left of the screen.
- If the AF mode is <AFQuick>, the AF point will also be displayed.

2 Select a function and set it.

- Press the <▲▼> key to select a function.
- ▶ The selected function and Feature guide (p.48) will appear.
- Press the <◀▶> key or turn the <DIAL> dial to change the setting. Pressing <SET> will display the respective function's setting screen.

 The image-recording quality setting will be reflected in all shooting modes.

MENU Setting the Movie-recording Size

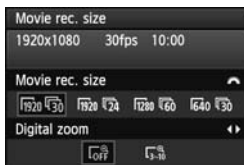

Under the [CAMERA] tab, [Movie rec. size] enables you to select the movie's image size [****x****] and frame rate [FPS] (frames recorded per second). The FPS (frame rate) switches automatically depending on the [VIDEO SYSTEM] setting.

● Image size

- [1920x1080] : Full High-Definition (Full HD) recording quality.
- [1280x720] : High-Definition (HD) recording quality.
- [640x480] : Standard-definition recording quality. The aspect ratio will be 4:3.







● Frame rate (fps: frames per second)

- [FPS] [FPS] : For areas where the TV format is NTSC (North America, Japan, Korea, Mexico, etc.).
- [FPS] [FPS] : For areas where the TV format is PAL (Europe, Russia, China, Australia, etc.).
- [FPS] : Mainly for motion pictures.

 When [1920x1080] is set as movie recording size, you can use the digital zoom. For the setting procedure, see page 152.

Total Movie Recording Time and File Size Per Minute

Due to limitations of the file system, movie shooting will stop automatically if the file size of a single movie clip reaches 4GB. To resume movie shooting, press the <  > button. (A new movie file starts being recorded.)

Movie-recording Size		Total Recording Time (approx.)			File Size (approx.)
		4GB Card	8GB Card	16GB Card	
[1920x1080]		11 min.	22 min.	44 min.	330 MB/min.
					
					
[1280x720]		11 min.	22 min.	44 min.	330 MB/min.
					
[640x480]		46 min.	1 hr. 32 min.	3 hr. 4 min.	82.5 MB/min.
					



- An increase of the camera's internal temperature may cause movie shooting to stop before the maximum recording time shown in the table above (p.163).
- The maximum recording time of one movie clip is 29 min. 59 sec. Depending on the subject and the increase in the camera's internal temperature, the movie shooting might stop sooner than 29 min. 59 sec.



With ZoomBrowser EX/ImageBrowser (provided software, p.302), you can extract still photos from a movie. The still image quality will be as follows: Approx. 2.1 megapixels at [1920x1080], approx. 920,000 pixels at [1280x720], and approx. 310,000 pixels at [640x480].

MENU Using Movie Digital Zoom

When the image size is set to [1920x1080] (Full HD), you can shoot with an approx. 3x to 10x digital zoom.

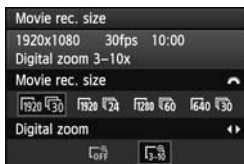

1 Select [1920x1080].

- Under the [] tab, set [Movie rec. size] to [1920x1080] by turning the < > dial.

2 Set the digital zoom.

- Press the < > key to select [3-10], then press <SET>.
- Press the <MENU> button to exit the menu and return to movie shooting.

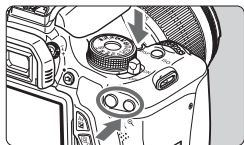

3 Use digital zoom.

- While holding down the <DISP> button, press the <Q> (zoom in) or <Q-Q> (zoom out) button.
- In step 2, you can cancel digital zoom by selecting [OFF].

- Using a tripod is recommended to prevent camera shake.
- The image cannot be magnified for focusing.
- Even if the AF mode has been set to [Quick mode], it will switch automatically to [Live mode] during movie shooting. Also, in [Live mode], the AF point is displayed larger than with other recording sizes.
- Since the image is processed digitally when using the digital zoom, the higher the zoom magnification, the rougher it will look.
- If you use digital zoom, noise and light spots may be more visible.
- Focusing may be difficult if the AF point covers both a near and far subject.
- Still photo shooting is not possible.

MENU Taking Video Snapshots

You can easily create a short movie with the video snapshot function. A video snapshot is a short movie clip lasting 2 sec., 4 sec., or 8 sec. A collection of video snapshots is called a video snapshot album and can be saved to the card as a single movie file. By changing the scene or angle in each video snapshot, you can create dynamic short movies. A video snapshot album can also be played together with background music (p.156, 213).

Video Snapshot Album Concept

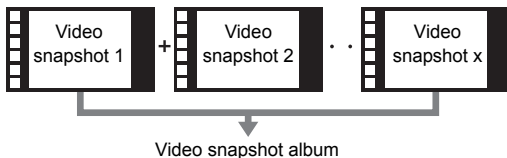

Setting the Video Snapshot Shooting Duration

In step 2 below, you can select [2 sec. movie] for example, and each video snapshot you shoot will be 2 sec. long.



1 Select [Video snapshot].

- Under the [CAM] tab, select [Video snapshot].

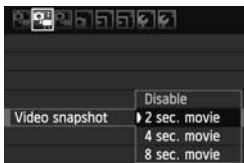

2 Select the [Video snapshot] shooting duration.

- Press the <▲▼> key to select the video snapshot shooting duration, then press <SET>.
- Press the <MENU> button to exit the menu and return to movie shooting,

Creating a Video Snapshot Album



Shooting duration

3 Shoot the first video snapshot.

- Press the <[CAM] > button to shoot.
- ▶ The blue bars indicating the shooting duration will gradually decrease. After the set shooting duration elapses, the shooting stops automatically.
- ▶ After the LCD monitor turns off and the access lamp stops blinking, the confirmation screen will appear.

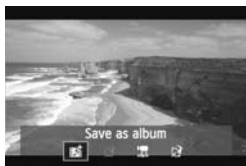

4 Save as a video snapshot album.

- Press the <[LEFT] > key to select [Folder icon] **Save as album**], then press <[SET] >.
- ▶ The movie clip will be saved as the video snapshot album's first video snapshot.



5 Continue to shoot more video snapshots.







- Repeat step 3 to shoot the next video snapshot.
- Press the <[LEFT] > key to select [Folder icon] **Add to album**], then press <[SET] >.
- To create another video snapshot album, select [Folder icon] **Save as a new album**].













6 Quit the video snapshot shooting.

- Set [Video snapshot] to [Disable]. **To return to normal movie shooting, be sure to set [Disable].**
- Press the <[MENU] > button to exit the menu and return to normal movie shooting.

Options in Steps 4 and 5

Option	Description
 Save as album (Step 4)	The movie clip will be saved as the video snapshot album's first video snapshot.
 Add to album (Step 5)	The video snapshot just recorded will be added to the album recorded immediately before.
 Save as a new album (Step 5)	A new video snapshot album is created and the movie clip is saved as the first video snapshot. The new album will be a different file from the previously recorded album.
 Playback video snapshot (Steps 4 and 5)	The video snapshot just recorded will be played. For playback operations, see the table below.
 Do not save to album (Step 4)  Delete without saving to album (Step 5)	If you want to delete the video snapshot you just recorded and not save it to the album, select [OK].

[Playback video snapshot] Operations

Operation	Playback Description
 Exit	Returns to the previous screen.
 Play	By pressing <SET>, you can play or pause the just-recorded video snapshot.
 First frame	Displays the first scene of the album's first video snapshot.
 Skip backward*	Each time you press <SET>, the video snapshot skips back by a few seconds.
 Previous frame	Each time you press <SET>, a single previous frame is displayed. If you hold down <SET>, it will rewind the movie.
 Next frame	Each time you press <SET>, the movie will play frame-by-frame. If you hold down <SET>, it will fast forward the movie.
 Skip forward*	Each time you press <SET>, the video snapshot skips forward by a few seconds.
 Last frame	Displays the last scene of the album's last video snapshot.
	Playback position
mm' ss"	Playback time (minutes:seconds)
 Volume	You can adjust the built-in speaker's (p.210) sound volume by turning the <DIAL> dial.

* With [Skip backward/Skip forward], the skipping duration will correspond to the number of seconds set under [Video snapshot] (approx. 2 sec., 4 sec., or 8 sec.).

- You can add to an album only video snapshots having the same duration (approx. 2 sec., 4 sec., or 8 sec. each). If you stop shooting a video snapshot before the set shooting duration elapses, the video snapshot will be added to the preceding album. And a new album will be created for subsequent video snapshots.
- Note that if you do any of the following while shooting video snapshots, a new album will be created for subsequent video snapshots.
 - Changing the [Movie rec. size] (p.150).
 - Changing the [Video snapshot] shooting duration (p.153).
 - Changing the [Sound rec.] setting from [Auto/Manual] to [Disable] or from [Disable] to [Auto/Manual] (p.160).
 - Opening/closing the card slot cover or battery compartment cover.
 - Interrupting the use of AC Adapter Kit ACK-E8 (sold separately).
 - Updating the firmware.
- You cannot change the order of the video snapshots in an album or add more video snapshots to the album later.
- You cannot take still photos while shooting a video snapshot.
- The shooting duration of a video snapshot is only approximate. Depending on the frame rate, the shooting duration displayed during playback might not be exact.

Playing an Album

You can playback a completed album in the same way as a normal movie. For details, see pages 212 and 217.



- Press the <▶> button.
- Press the <◀▶> key to select an album, then press <SET>.
- Movies shot as a video snapshot will have an <▶▶SET> icon on the screen's upper left.

- Music recorded on the memory card must be used only for private enjoyment. Do not violate the rights of the copyright holder.
- To play background music, you must first copy the background music from the EOS DIGITAL Solution Disk (provided) to the card. For the copying procedure, see the Software Instruction Manual in the CD-ROM.

Provided Software Usable with Albums

- **EOS Utility:** By copying background music to the card, you can play background music together with the playback of albums, normal movies, and slide shows on the camera.
- **ZoomBrowser EX/ImageBrowser:** The edition of albums is possible.

MENU Menu Function Settings

The menu options displayed under the [M], [M], and [M] tabs are explained below.

[M] tab



- **Movie exposure**

Normally, set this to **[Auto]**.

Setting it to **[Manual]** enables you to manually set the ISO speed, shutter speed, and aperture for movie shooting (p.144).

- **AF mode**

The AF modes will be the same as described on pages 131-137.

You can select **[Live mode]**, **[Live mode]**, or **[Quick mode]**. Note that continuous focusing of a moving subject is not possible.

- **AF with shutter button during [M] (movie recording)**

When **[Enable]** is set, AF is possible during movie shooting.

However, continuous autofocusing is not possible. If you autofocus during movie shooting, you might momentarily throw the focus way off or change the exposure. The movie will also record the lens operation noise.

If the AF mode is set to **[Quick mode]**, AF will be executed in **[Live mode]**.



- The settings under the [M]/[M]/[M] menu tabs will take effect only in the <[M]> mode. They will not be applied in shooting modes other than the <[M]> mode.
- The AF mode setting will also be applied to Live View shooting.

- **Shutter/AE lock button**

You can change the function assigned to the shutter button's halfway position and to the AE lock button.

- **AF/AE lock:**

Normal function. Press the shutter button halfway to execute AF. Press the <✳> button for AE lock.

- **AE lock/AF:**

Press the shutter button halfway for AE lock. For AF, press the <✳> button. Convenient when you want to focus and meter at different parts of the picture.

- **AF/AF lock, no AE lock:**

Press the shutter button halfway to execute AF. While holding down the <✳> button, press the shutter button to take a still photo without executing AF. Convenient when you do not want to autofocus when taking a still photo during movie shooting. AE lock is not possible.

- **AE/AF, no AE lock:**

Press the shutter button halfway for metering. For AF, press the <✳> button. AE lock is not possible.

- **Remote control**

You can use the Remote Controller RC-6 (sold separately, p.261) to start and stop the movie shooting. Set the release mode switch to <2>, then press the transmit button. If the switch is set to <●> (immediate shooting), still photo shooting will take effect.

- **Highlight tone priority**

If **[Enable]** is set, highlight detail will be improved. The dynamic range is expanded from the standard 18% gray to bright highlights. The gradation between the grays and highlights becomes smoother. The settable ISO speed range will be ISO 200-6400. The Auto Lighting Optimizer will also be set automatically to **[Disable]** and cannot be changed.

[] tab

Movie rec. size	1920x1080 30
Sound recording	Auto
Metering timer	16 sec.
Grid display	Off
Video snapshot	Disable

● Sound recording

Sound recording	
Sound rec.	Auto
Rec. level	
Wind filter	Disable
-dB	40 12 0
L	-----
R	-----
	MENU ⇌

Level meter

Normally, the built-in microphone will record monaural sound. Stereo sound recording is possible by connecting an external microphone equipped with a stereo mini plug (3.5mm dia.) to the camera's external microphone IN terminal (p.18). When an external microphone is connected, sound recording will switch automatically to the external microphone.

[Sound rec.] options

- [Auto] : The sound recording level will be adjusted automatically. Auto level control will operate automatically in response to the sound level.
- [Manual] : For advanced users. You can adjust the sound recording level to one of 64 levels. Select [Rec. level] and look at the level meter while pressing the <◀▶> key to adjust the sound recording level. While looking at the peak hold indicator (approx. 3 sec.), adjust so that the level meter sometimes lights up the "12" (-12 dB) mark on the right for the loudest sounds. If it exceeds "0," the sound will be distorted.
- [Disable] : Sound will not be recorded.

[Wind filter]

When **[Enable]** is set, outdoor wind noise entering the microphone will be reduced. Note that some low-tone noise might also be reduced. When shooting in places where there is no wind, set this to **[Disable]** for a more natural sound recording.



- The sound volume balance between L (left) and R (right) cannot be adjusted.
- The 48 kHz sampling frequency will be 16-bit recordings for both L and R.

● Metering timer

You can change how long the exposure setting is displayed (AE lock time).

● Grid display

With **[Grid 1 \equiv]** or **[Grid 2 \equiv]**, you can display grid lines. It can help you level the camera vertically or horizontally.

● Video snapshot

For video snapshots, you can set the shooting duration for a single video snapshot to approx. 2 sec., 4 sec., or 8 sec. For details, see page 153.



The Metering timer and Grid display settings will also be reflected in Live View shooting.



[] tab

- **Exposure compensation**

Although exposure compensation can be set up to ± 5 stops, exposure compensation for movies is restricted only up to ± 3 stops. For still photos, exposure compensation may extend up to ± 5 stops.

- **Auto Lighting Optimizer**

The Auto Lighting Optimizer can be set as explained on page 109. It will be applied to both movie shooting and still photos taken during movie shooting.

Under the [] tab, if [ **Highlight tone priority**] is set to [**Enable**], the Auto Lighting Optimizer will be set automatically to [**Disable**] and cannot be changed.

- **Custom White Balance**

As explained on page 117, the image for custom white balance can be selected.

- **Picture Style**

The Picture Style can be set as explained on page 81. It will be applied to both movie shooting and still photos taken during movie shooting.



White <🔥> and Red <🔥> Internal Temperature Warning Icons

- If the camera's internal temperature increases due to prolonged movie shooting or a high ambient temperature, a white <🔥> icon will appear. Even if you shoot a movie while this icon is displayed, the movie's image quality will not be affected. However, if you shoot still photos, the image quality of the still photos may deteriorate. You should stop shooting still photos and allow the camera to cool down.
- If the camera's internal temperature further increases while the white <🔥> icon is displayed, a red <🔥> icon may start blinking. This blinking icon is a warning that movie shooting will soon be terminated automatically. If this happens, you will not be able to shoot again until the camera's internal temperature decreases. Turn off the power and let the camera rest for a while.
- Movie shooting at a high temperature for a prolonged period will cause the <🔥> and <🔥> icons to appear sooner. When not shooting, turn off the camera.



Movie Shooting Cautions

Recording and Image Quality

- If the attached lens has an Image Stabilizer, the Image Stabilizer will operate at all times even if you do not press the shutter button halfway. The Image Stabilizer will thereby consume battery power and may shorten the total movie shooting time or decrease the number of possible shots. If you use a tripod or if the Image Stabilizer is not necessary, you should set the IS switch to <OFF>.
- The camera's built-in microphone will also record camera operation noise. Using a commercially-available external microphone can prevent (or reduce) these noises from being recorded.
- Do not connect anything other than an external microphone to the camera's external microphone IN terminal.
- If movie shooting is not possible due to insufficient remaining capacity of the card, the movie recording size and movie shooting remaining time (p.146) will be displayed in red.

Movie Shooting Cautions

Recording and Image Quality

- If you use a card having a slow writing speed, a five-level indicator might appear on the right of the screen during movie shooting. It indicates how much data has not yet been written to the card (remaining capacity of the internal buffer memory). The slower the card, the faster the indicator will climb upward. If the indicator becomes full, movie shooting will stop automatically.

If the card has a fast writing speed, the indicator will either not appear or the level (if displayed) will hardly go upward.

First, shoot a few test movies to see if the card can write fast enough.

If you take still photos during movie shooting, the movie shooting might stop. Setting a low image-recording quality for still images might resolve this problem.



Indicator

Playback and TV connection

- If the brightness changes during autoexposure movie shooting, that part might look momentarily still when you playback the movie. In such cases, shoot movies with manual exposure.
- If you connect the camera to a TV set with an HDMI cable (p.218) and shoot a movie in [1920x1080] or [1280x720], the movie being shot will be displayed at a small size on the TV. However, the actual movie will be properly recorded at the movie recording size that was set.
- If you connect the camera to a TV set (p.218, 221) and shoot a movie, the TV will not output any sound during the shooting. However, the sound will be properly recorded.

7

Handy Features

- Silencing the Beeper (p.166)
- Card Reminder (p.166)
- Setting the Image Review Time (p.166)
- Setting the Auto Power-off Time (p.167)
- Adjusting the LCD Monitor Brightness (p.167)
- Creating and Selecting a Folder (p.168)
- File Numbering Methods (p.170)
- Setting Copyright Information (p.172)
- Auto Rotation of Vertical Images (p.174)
- Checking Camera Settings (p.175)
- Reverting the Camera to the Default Settings (p.176)
- Turning the LCD Monitor Off/On (p.179)
- Changing the Shooting Settings Screen Color (p.179)
- Setting the Flash (p.180)
- Automatic Sensor Cleaning (p.184)
- Appending Dust Delete Data (p.185)
- Manual Sensor Cleaning (p.187)

Handy Features

MENU Silencing the Beeper

You can prevent the beeper from sounding when focus is achieved or during self-timer operation.



Under the [] tab, select **[Beep]**, then press <SET>. Select **[Disable]**, then press <SET>.

MENU Card Reminder

This prevents shooting if there is no card in the camera.

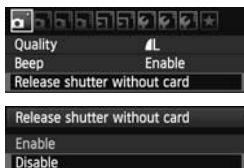

Under the [] tab, select **[Release shutter without card]**, then press <SET>. Select **[Disable]**, then press <SET>.

If there is no card installed and you press the shutter button, “**Card**” will be displayed in the viewfinder, and you cannot release the shutter.

MENU Setting the Image Review Time

You can set how long the image is displayed on the LCD monitor immediately after capture. If **[Off]** is set, the image will not be displayed immediately after image capture. If **[Hold]** is set, the image review will be displayed up until the **[Auto power off]** time.

During image review, if you operate any camera controls such as pressing the shutter button halfway, the image review will end.

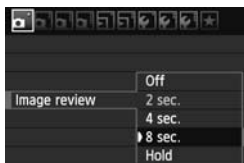

Under the [] tab, select **[Image review]**, then press <SET>. Select the desired setting, then press <SET>.

MENU Setting the Auto Power-off Time

To save battery power, the camera turns off automatically after the set time of idle operation elapses. You can set this auto power-off time. When the camera has turned off due to auto power off, you can wake it up by pressing the shutter button halfway or pressing any of the following buttons: <MENU>, <DISP.>, <▶>, <📷> etc.

If [Off] has been set, either turn off the camera yourself or press the <DISP.> button to turn off the LCD monitor to save battery power.

Even if [Off] has been set and the camera is not used for 30 min., the LCD monitor will turn off automatically. To turn on the LCD monitor again, press the <DISP.> button.



Under the [**☺**] tab, select [**Auto power off**], then press <SET>. Select the desired setting, then press <SET>.

MENU Adjusting the LCD Monitor Brightness

You can adjust the brightness of the LCD monitor to make it easier to read.



Under the [**☺**] tab, select [**LCD brightness**], then press <SET>. With the adjustment screen displayed, press the <◀▶> key to adjust the brightness, then press <SET>.



When checking the exposure of an image, set the LCD monitor brightness to 4 and prevent the ambient light from affecting the reviewed image.

MENU Creating and Selecting a Folder

You can freely create and select the folder where the captured images are to be saved.

This is optional since a folder will be created automatically for saving captured images.

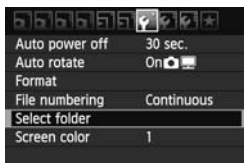
Create a Folder**1 Select [Select folder].**

- Under the [**Y**] tab, select [**Select folder**], then press <SET>.

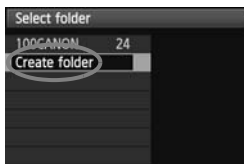
**2 Select [Create folder].**

- Select [**Create folder**], then press <SET>.

**3 Create a new folder.**

- Select [**OK**], then press <SET>.
- ▶ A new folder with a higher one-up folder number is created.

Selecting a Folder

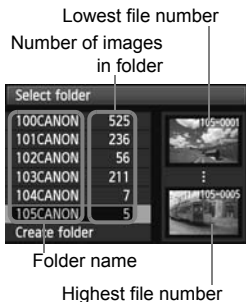

- With the folder selection screen displayed, select a folder and press $\langle \text{SET} \rangle$.
- ▶ The folder where the captured images will be saved is selected.
- Subsequent captured images will be recorded into the selected folder.

About Folders

As with “100CANON” for example, the folder name starts with three digits (folder number) followed by five alphanumeric characters. A folder can contain up to 9999 images (file No. 0001 - 9999). When a folder becomes full, a new folder with a higher one-up folder number is created automatically. Also, if manual reset (p.171) is executed, a new folder will be created automatically. Folders numbered from 100 to 999 can be created.

Creating Folders with a Personal Computer

With the card open on the screen, create a new folder named “DCIM”. Open the DCIM folder and create as many folders as necessary to save and organize your images. The folder name must follow the “100ABC_D” format where the first three digits is 100 - 999 followed by five alphanumeric characters. The five characters can be a combination of upper- or lower-case letters from A to Z, numerals, and an underscore “_”. There can be no space in the folder name. Also, folder names cannot have the same three-digit number such as “100ABC_D” and “100W_XYZ” even if the letters are different.

MENU File Numbering Methods

The image files will be numbered from 0001 to 9999 in the order the images are taken, then saved in a folder. You can change how the file number is assigned.

The file number will appear on your computer in this format:

IMG_0001.JPG

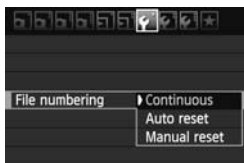

Under the [**F**] tab, select [**File numbering**], then press <SET>. The available settings are described below. Select one, then press <SET>.

- **[Continuous]: The file numbering continues in sequence even after you replace the card or create a folder.**

Even after you replace the card or create a new folder, the file numbering continues in sequence up to 9999. This is convenient when you want to save images numbered anywhere between 0001 to 9999 in multiple cards or folders into one folder in your personal computer.

If the replacement card or existing folder already contains images recorded previously, the file numbering of the new images might continue from the file numbering of the existing images in the card or folder. If you want to use continuous file numbering, you should use a newly-formatted card each time.

File numbering after replacing the card

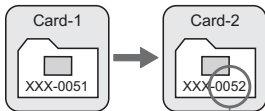

Next sequential file number

File numbering after creating a folder

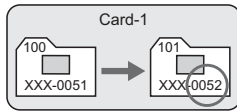

- **[Auto reset]: The file numbering is reset to 0001 whenever you replace the card or create a folder.**

Whenever the card is replaced or a new folder created, the file numbering starts from 0001. This is convenient if you want to organize images according to cards or folders.

If the replacement card or existing folder already contains images recorded previously, the file numbering of the new images might continue from the file numbering of the existing images in the card or folder. If you want to save images with the file numbering starting from 0001, use a newly formatted card each time.

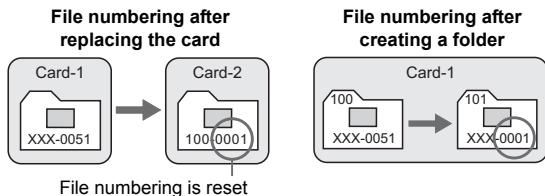

- **[Manual reset]: To reset the file numbering to 0001 manually or to start from file number 0001 in a new folder.**

When you reset the file numbering manually, a new folder is created automatically and the file numbering of images saved to that folder starts from 0001.

This is convenient if you want to use different folders for the images taken yesterday and the ones taken today, for example.

After the manual reset, the file numbering returns to continuous or auto reset. (There will be no Manual reset confirmation screen.)



If the file number in folder No. 999 reaches 9999, shooting will not be possible even if the card still has storage capacity. The LCD monitor will display a message telling you to replace the card. Replace it with a new card.



For both JPEG and RAW images, the file name will start with "IMG_". Movie file names will start with "MVI_". The extension will be ".JPG" for JPEG images, ".CR2" for RAW images, and ".MOV" for movies.

MENU Setting Copyright Information ☆

When you set the copyright information, it will be appended to the image as Exif information.

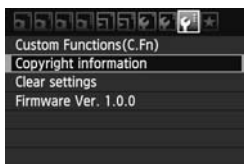
**1** Select [Copyright information].

- Under the [☺:] tab, select [Copyright information], then press <SET>.

**2** Select the option to be set.

- Select [Enter author's name] or [Enter copyright details], then press <SET>.
- ▶ The text entry screen will appear.
- Select [Display copyright info.] to check the copyright information currently set.
- Select [Delete copyright information] to delete the copyright information currently set.

**3** Enter text.

- Refer to “Text Entry Procedure” on the next page and enter the copyright information.
- Enter up to 63 alphanumeric characters and symbols.

4 Exit the setting.

- After entering the text, press the <MENU> button to exit.

Text Entry Procedure



- **Changing the entry area:**
Press the <Q> button to toggle between the top and bottom entry areas.
- **Moving the cursor:**
Press the <◀▶> key to move the cursor.
- **Entering text:**
In the bottom area, press the <◆> key or turn the <⚙> dial to select a character, then press <SET> to enter it.
- **Deleting a character:**
Press the <🗑> button to delete one character.
- **Exiting:**
After entering the text, press the <MENU> button to finalize the text entry and return to the screen in step 2.
- **Canceling the text entry:**
To cancel the text entry, press the <INFO.> button and the screen in step 2 will reappear.





You can also set or check the copyright information with EOS Utility (provided software, p.302).

MENU Auto Rotation of Vertical Images

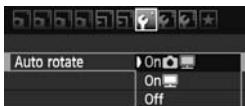



Vertical images are rotated automatically so they are displayed vertically on the camera's LCD monitor and on the personal computer instead of horizontally. The setting of this feature can be changed.



Under the [F] tab, select **[Auto rotate]**, then press <SET>. The available settings are described below. Select one, then press <SET>.

- **[On  **] : The vertical image is automatically rotated during playback on both the camera's LCD monitor and on the computer.
- **[On **] : The vertical image is automatically rotated only on the computer.
- **[Off]** : The vertical image is not automatically rotated.

? FAQ

- **The vertical image is not rotated during the image review immediately after it is captured.**
Press the <▶> button and the image playback will display the rotated image.
- **[On  **] is set, but the image does not rotate during playback.
Auto rotate will not work with vertical images captured while **[Auto rotate]** was set to **[Off]**. If the vertical image is taken while the camera is pointed up or down, the image might not be rotated automatically for playback. In such a case, see "Rotating the Image" on page 205.
- **On the camera's LCD monitor, I want to rotate an image captured when [On **] had been set.
Set **[On  **], then playback the image. It will be rotated.
- **The vertical image does not rotate on the computer screen.**
The software used is not compatible with image rotation. Use the software provided with the camera instead.

INFO. Checking Camera Settings

While the shooting settings (p.47) are displayed, press the <INFO.> button to display the camera's major function settings.



Settings display

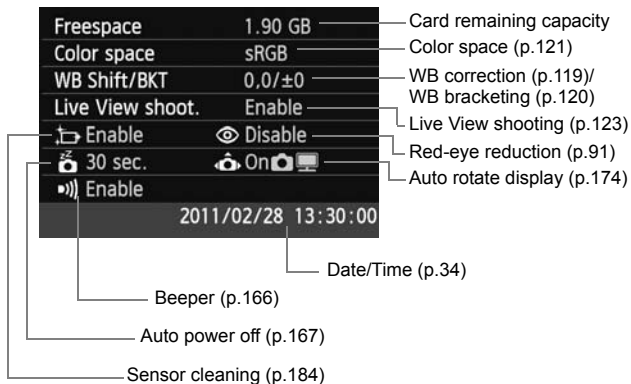

MENU Reverting the Camera to the Default Settings ☆

The camera's shooting settings and menu settings can be reverted to the default. This option is available in Creative Zone modes.

**1** Select [Clear settings].

- Under the [Fn] tab, select [Clear settings], then press <SET>.

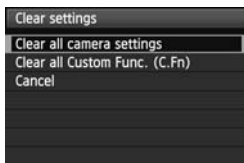
**2** Select [Clear all camera settings].

- Select [Clear all camera settings], then press <SET>.

**3** Select [OK].

- Select [OK], then press <SET>.
- ▶ Setting [Clear all camera settings] will reset the camera to the default settings on the next page.

? FAQ● **Clearing all camera settings:**

After the procedure above, select [Clear all Custom Func. (C.Fn)] in [Fn: Clear settings] to clear all the Custom Function settings (p.250).

Shooting Settings









AF mode	One-Shot AF
AF point selection	Automatic selection
Drive mode	 (Single shooting)
Metering mode	 (Evaluative metering)
ISO speed	AUTO (Auto)
ISO Auto	Max.: 3200
Exposure compensation/AEB	Canceled
Built-in flash func. setting	NormalFiring
Flash exposure compensation	0 (Zero)
Custom Functions	Unchanged

Image-recording Settings

Quality	 L
Picture Style	Auto
Auto Lighting Optimizer	Standard
Peripheral illumination correction	Enable/Correction data retained
Color space	sRGB
White balance	 (Auto)
Custom white balance	Canceled
WB correction	Canceled
WB-BKT	Canceled
File numbering	Continuous
Auto cleaning	Enable
Dust Delete Data	Erased

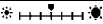

Camera Settings

Auto power off	30 sec.
Beep	Enable
Release shutter without card	Enable
Image review	2 sec.
Histogram	Brightness
Image jump w/ 	 (10 images)
Auto rotate	On  
LCD brightness	
LCD off/on button	Shutter button
Date/Time	Unchanged
Language	Unchanged
Video system	Unchanged
Feature guide	Enable
Copyright information	Unchanged
Bass boost	Disable
Control over HDMI	Disable
Eye-Fi transmission	Disable
My Menu settings	Unchanged

Live View Shooting Settings

Live View shooting	Enable
AF mode	Live mode
Grid display	Off
Aspect ratio	3:2
Metering timer	16 sec.

Movie Shooting Settings

Movie exposure	Auto
AF mode	Live mode
AF w/ shutter button during 	Disable
 Shutter/AE lock button	AF/AE lock
Remote control	Disable
 Highlight tone priority	Disable
Movie recording size	1920x1080
Sound recording	Auto
Metering timer	16 sec.
Grid display	Off
Video snapshot	Disable
Exposure compensation	Canceled
Auto Lighting Optimizer	Standard
Custom white balance	Canceled
Picture Style	Auto

MENU Turning the LCD Monitor Off/On

The shooting settings display (p.47) can be turned on or off by pressing the shutter button halfway.



Under the [**Y**] tab, select [**LCD off/on btn**], then press <SET>. The available settings are described below. Select one, then press <SET>.

- **[Shutter btn.]** : When you press the shutter button halfway, the display will turn off. And when you let go of the shutter button, the display will turn on.
- **[Shutter/DISP]**: When you press the shutter button halfway, the display will turn off. And when you let go of the shutter button, the display will remain off. To turn on the display, press the <DISP.> button.
- **[Remains on]** : Display remains on even when you press the shutter button halfway. To turn off display, press the <DISP.> button.

MENU Changing the Shooting Settings Screen Color

You can change the background color of the shooting settings screen.

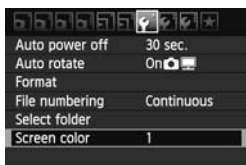

Under the [**Y**] tab, select [**Screen color**], then press <SET>. Select the desired color, then press <SET>.

When you exit the menu, the selected color will be displayed for the shooting settings screen.



MENU Setting the Flash ☆

The built-in flash and external Speedlite settings can be set with the camera's menu. You can use the camera's menu to set the external Speedlite function settings only if the attached **EX-series Speedlite is compatible with this function.**

The setting procedure is the same as setting a camera menu function.

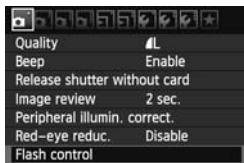

Select [Flash control].

- Under the [] tab, select [Flash control], then press <SET>.
- ▶ The flash control screen will appear.

[Flash firing]

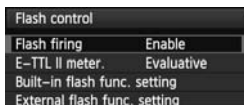

- Normally, set this to [Enable].
- If [Disable] is set, neither the built-in flash nor the external Speedlite will fire. This is useful when you only want to use the flash's AF-assist beam.

E-TTL II Metering Modes

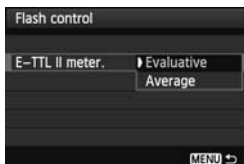

- For normal flash exposures, set this to [Evaluative].
- [Average] is for advanced users. As with an external Speedlite, the metering area is averaged. Flash exposure compensation may be necessary.

Even if [Flash firing] has been set to [Disable], if focus is difficult to achieve in low light, the built-in flash may still fire a series of flashes (AF-assist beam, p.86).

[Built-in flash func. setting] and [External flash func. setting]

With **[Built-in flash func. setting]** and **[External flash func. setting]**, you can set the functions listed in the table below. The functions displayed under **[External flash func. setting]** will vary depending on the Speedlite model.

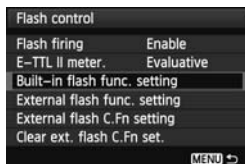

- Select **[Built-in flash func. setting]** or **[External flash func. setting]**.
- ▶ The flash functions will be displayed. The functions not dimmed can be selected and set.

[Built-in flash func. setting] and [External flash func. setting] Settable Functions

Function	[Built-in flash func. setting]			[External flash func. setting]	Page
	Normal Firing	Easy Wireless (p.191)	Custom Wireless (p.194)		
Flash mode			○	○	182
Shutter sync.	○			○	182
FEB*				○	
Wireless flash			○	○	189
Channel		○	○	○	191
Flash group			○		195
Flash exposure compensation	○	○	○	○	104
Zoom*				○	

* For **[FEB]** (Flash exposure bracketing) and **[Zoom]**, refer to the Speedlite's instruction manual.

● **Shutter sync.**

Normally, set this to [**1st curtain**] so that the flash fires immediately after the exposure starts.

If [**2nd curtain**] is set, the flash will fire right before the exposure ends. When this is combined with a slow sync speed, you can create a trail of light such as from car headlights at night. With 2nd-curtain sync, a preflash is fired when you press the shutter button completely. This is to determine the exposure. Then immediately before the exposure ends, the real flash is fired. Therefore, two flashes will be fired. However, with shutter speeds faster than 1/30 sec., 1st curtain sync will automatically take effect.

If an external Speedlite is attached, you can also set [**Hi-speed**] (⚡_H). For details, see the Speedlite's instruction manual.

● **Wireless flash**

See "Wireless Flash Photography" on page 189.

● **Flash exposure compensation**

See "⚡ Flash Exposure Compensation" on page 104.

● **Flash mode**

You can select the flash mode to suit your desired flash shooting.

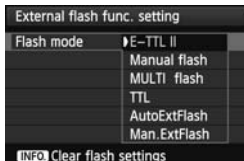
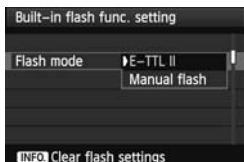

- [**E-TTL II**] is the standard mode of EX-series Speedlites for automatic flash shooting.
- [**Manual flash**] is for advanced users who want to set the [**Flash output**] (1/1 to 1/128) themselves.
- Regarding other flash modes, refer to your Speedlite's instruction manual.

● Clear flash settings

With the [**Built-in flash func. setting**] or [**External flash func. setting**] screen displayed, press the <INFO.> button to display the screen to clear the flash settings. **When you select [OK], the settings for the flash will be cleared.**

Setting the External Speedlite Custom Functions

The Custom Functions displayed under [**External flash C.Fn setting**] will vary depending on the Speedlite model.

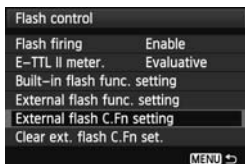

1 Display the Custom Function.

- With the camera ready to shoot with an external Speedlite, select [**External flash C.Fn setting**], then press < (SET) >.

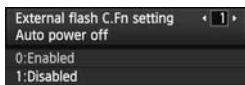

2 Set the Custom Function.

- Press the <◀▶> key to select the function number, then set the function. The procedure is the same as setting the camera's Custom Functions (p.250).
- To clear all the Custom Function settings, select [**Clear ext. flash C.Fn set.**] in step 1.

Automatic Sensor Cleaning

Whenever you set the power switch to <ON> or <OFF>, the Self Cleaning Sensor Unit operates to automatically shake off the dust on the front of the sensor. Normally, you need not pay attention to this operation. However, you can execute the sensor cleaning at anytime as well as disable it.

Cleaning the Sensor Now



1 Select [Sensor cleaning].

- Under the [] tab, select [**Sensor cleaning**], then press <SET>.

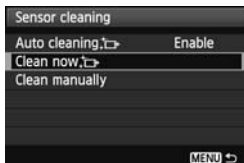

2 Select [Clean now].

- Select [**Clean now **], then press <SET>.
- Select [**OK**] on the dialog screen, then press <SET>.
- ▶ The screen will indicate that the sensor is being cleaned. Although there will be a shutter sound, a picture is not taken.



- For best results, do the sensor cleaning while the camera bottom is placed on a table or other flat surface.
- Even if you repeat the sensor cleaning, the result will not improve that much. Right after the sensor cleaning is finished, the [**Clean now **] option will remain disabled temporarily.

Disabling Automatic Sensor Cleaning

- In step 2, select [**Auto cleaning **] and set it to [**Disable**].
- ▶ The sensor cleaning will no longer be executed when you set the power switch to <ON> or <OFF>.

MENU Appending Dust Delete Data ☆

Normally, the Self Cleaning Sensor Unit will eliminate most of the dust that might be visible on captured images. However, in case visible dust still remains, you can append the Dust Delete Data to the image for erasing the dust spots later. The Dust Delete Data is used by Digital Photo Professional (provided software, p.302) to erase the dust spots automatically.

Preparation

- Get a solid-white object (paper, etc.).
- Set the lens focal length to 50mm or longer.
- Set the lens focus mode switch to <MF> and set the focus to infinity (∞). If the lens has no distance scale, look at the front of the lens and turn the focusing ring clockwise all the way.

Obtain the Dust Delete Data

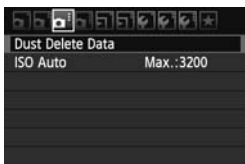

1 Select [Dust Delete Data].

- Under the [M:] tab, select [Dust Delete Data], then press <SET>.



2 Select [OK].

- Select [OK] and press <SET>. After the automatic self-cleaning of the sensor is performed, a message will appear. Although there will be a shutter sound, a picture is not taken.

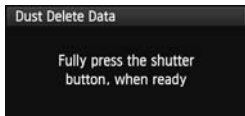
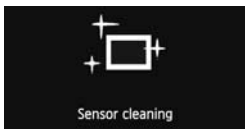

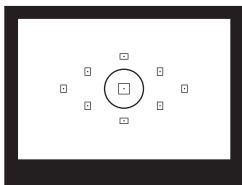

3 Photograph a solid-white object.

- At a distance of 20 cm - 30 cm (0.7 ft. - 1.0 ft.), fill the viewfinder with a patternless, solid-white object and take a picture.
- ▶ The picture will be taken in aperture-priority AE mode at an aperture of f/22.
- Since the image will not be saved, the data can still be obtained even if there is no card in the camera.
- ▶ When the picture is taken, the camera will start collecting the Dust Delete Data. When the Dust Delete Data is obtained, a message will appear. Select **[OK]**, and the menu will reappear.
- If the data was not obtained successfully, a message to that effect will appear. Follow the "Preparation" procedure on the preceding page, then select **[OK]**. Take the picture again.



About the Dust Delete Data

After the Dust Delete Data is obtained, it is appended to all the JPEG and RAW images captured thereafter. Before an important shoot, you should update the Dust Delete Data by obtaining it again.

For details about using Digital Photo Professional (provided software, p.302) to erase dust spots, see the Software Instruction Manual (p.304) in the Software Instruction Manual CD-ROM.

The Dust Delete Data appended to the image is so small that it hardly affects the image file size.

! Be sure to use a solid-white object such as a new sheet of white paper. If the paper has any pattern or design, it may be recognized as dust data and affect the accuracy of the dust deletion with the software.

MENU Manual Sensor Cleaning [☆]

Dust which could not be removed by the automatic sensor cleaning can be removed manually with a blower, etc.

The surface of the image sensor is extremely delicate. If the sensor needs to be cleaned directly, having it done by a Canon Service Center is recommended.

Before cleaning the sensor, detach the lens from the camera.



1 Select [Sensor cleaning].

- Under the [**☛**] tab, select [**Sensor cleaning**], then press <SET>.

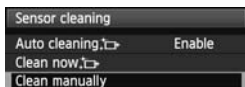

2 Select [Clean manually].

- Select [**Clean manually**], then press <SET>.



3 Select [OK].

- Select [**OK**], then press <SET>.
- ▶ In a moment, the reflex mirror will lockup and the shutter will open.

4 Clean the sensor.

5 End the cleaning.

- Set the power switch to <OFF>.



- For the power source, using AC Adapter Kit ACK-E8 (sold separately) is recommended.
- If you use a battery, make sure it is fully recharged. If the battery grip with size-AA/LR6 batteries is attached, manual sensor cleaning will not be possible.

- **While cleaning the sensor, never do any of the following. If the power is cut off, the shutter will close and the shutter curtains and image sensor might get damaged.**
 - **Setting the power switch to <OFF>.**
 - **Opening the battery compartment cover.**
 - **Opening the card slot cover.**
- The surface of the image sensor is extremely delicate. Clean the sensor with care.
- Use a plain blower without any brush attached. A brush can scratch the sensor.
- Do not insert the blower tip inside the camera beyond the lens mount. If the power is turned off, the shutter will close and the shutter curtains or reflex mirror might get damaged.
- Never use canned air or gas to clean the sensor. The blowing force can damage the sensor or the spray gas can freeze on the sensor.
- If the battery level becomes low while you clean the sensor, the beeper will sound as a warning. Stop cleaning the sensor.
- If a smudge that cannot be removed with a blower remains, having the sensor cleaned by a Canon Service Center is recommended.

8

Wireless Flash Photography

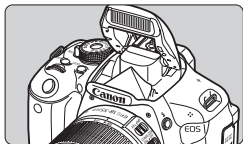

You can use the built-in flash for wireless flash shooting.

The camera's built-in flash can work as a master unit with Canon Speedlites having a wireless slave feature and wirelessly trigger the Speedlite(s) to fire.

Canceling the slave unit's auto power off

To cancel the slave unit's auto power off, press the camera's **<★>** button. If you are using manual flash firing, press the slave unit's test firing (PILOT) button to cancel the auto power off.



Be sure to also read the explanations about wireless flash photography in the Speedlite's instruction manual.

Using Wireless Flash ☆

Slave Unit Settings and Position

Regarding your Speedlite (slave unit), refer to its instruction manual and set it as follows. The settings other than the below for the slave unit's control are all set with the camera. Different types of Canon Speedlite slave units can be used and controlled together.

- (1) Set the Speedlite as a slave unit.
- (2) Set the Speedlite's transmission channel to the same one as the camera's.*1
- (3) If you want to set the flash ratio (p.196), set the slave unit ID.
- (4) Position the camera and slave unit(s) within the range shown below.
- (5) Face the slave unit's wireless sensor toward the camera.*2

Wireless flash set-up example

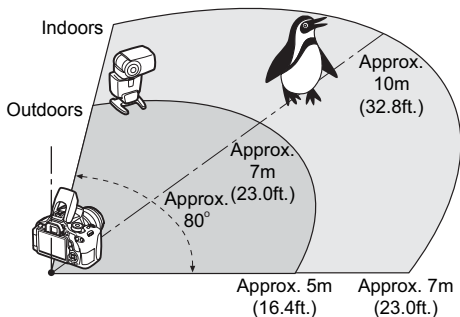

*1: If the Speedlite does not have a transmission channel setting function, the camera can work with any channel.

*2: In small rooms, the slave unit may work even if its wireless sensor does not face the camera. The camera's wireless signals can bounce off the walls and be received by the slave unit. With EX-series Speedlite having a fixed flash head and wireless sensor, make sure it fires, then take the picture.

Easy Wireless Flash Shooting

An easy, basic, and fully-automatic wireless flash shooting is explained below.

Fully Automatic Shooting with One External Speedlite

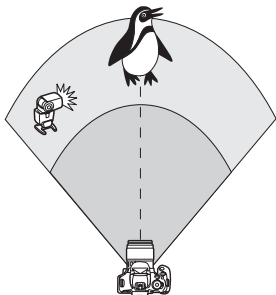

Steps 1 to 4 and 6 apply to all wireless flash shooting. Therefore, these steps are omitted in the other wireless flash setups explained on the pages hereafter.

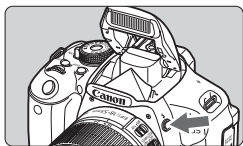

1 Press the $\langle \text{lightning bolt} \rangle$ button to raise the built-in flash.

- For wireless flash shooting, be sure to raise the built-in flash.

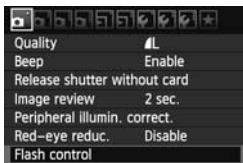

2 Select [Flash control].

- Under the [lightning bolt] tab, select [Flash control], then press $\langle \text{SET} \rangle$.

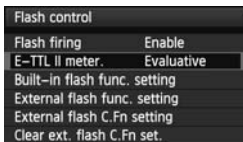

3 Select [Evaluative].

- For [E-TTL II meter.], select [Evaluative], then press $\langle \text{SET} \rangle$.

Flash control	
Flash firing	Enable
E-TTL II meter.	Evaluative
Built-in flash func. setting	
External flash func. setting	
External flash C.Fn setting	

4 Select [Built-in flash func. setting].

- Select [**Built-in flash func. setting**], then press <SET>.

Built-in flash func. setting	
Built-in flash	EasyWireless
Flash mode	E-TTL II
Shutter sync.	1st curtain
Wireless func.	* $\frac{1}{2}$
Channel	1 ch

5 Select [EasyWireless].

- For [**Built-in flash**], select [**EasyWireless**], then press <SET>.

Built-in flash func. setting	
Flash mode	E-TTL II
Shutter sync.	1st curtain
Wireless func.	* $\frac{1}{2}$
Channel	1 ch
Firing group	* $\frac{1}{2}$ All

6 Set [Channel].

- Set the channel (1-4) to the same one as the slave unit.

7 Take the picture.

- As with normal flash shooting, you can set the camera and take the picture in the same way.

Built-in flash func. setting	
Built-in flash	NormalFiring
Flash mode	E-TTL II
Shutter sync.	1st curtain
$\frac{1}{2}$ exp. comp.	-2..1..0..1..2
INFO Clear flash settings	

8 Exit the wireless flash shooting.

- For [**Built-in flash func. setting**], select [**NormalFiring**].



- Setting [**E-TTL II meter.**] to [**Evaluative**] is recommended.
- With [**EasyWireless**], even if you disable the built-in flash from firing, it will still fire to control the slave unit. Depending on shooting conditions, the flash fired to control the slave unit may appear in the picture.
- Firing a test flash is not possible with the slave unit.

Fully-automatic Shooting with Multiple External Speedlites

You can have multiple slave units fire as if they were a single Speedlite. Convenient when you need a large flash output.

Built-in flash func. setting	
Built-in flash	EasyWireless
Flash mode	E-TTL II
Shutter sync.	1st curtain
Wireless func.	☞☞
Channel	1 ch
Firing group	☞☞All
INFO Clear flash settings	

Basic settings:

Flash mode : E-TTL II

E-TTL II meter. : Evaluative

Built-in flash : EasyWireless

Channel : (Same as slave units)

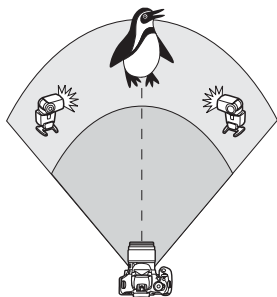

All the slave units will fire at the same output and be controlled to obtain a standard exposure.

No matter what the slave ID is (A, B, or C), all the slave units will fire as one group.

Flash Exposure Compensation

If the flash exposure looks too dark or too bright, you can set flash exposure compensation to adjust the slave units' flash output.

Built-in flash func. setting	
Flash mode	E-TTL II
Shutter sync.	1st curtain
Wireless func.	☞☞
Channel	1 ch
Firing group	☞☞All
exp. comp.	-2..1..0..1..2
INFO Clear flash settings	

- Select [**Flash exposure compensation**], then press <SET>.
- If the flash exposure is too dark, press the <▶> key to increase the flash exposure and make it brighter. If the flash exposure is too bright, press the <◀> key to decrease the flash exposure and make it darker.



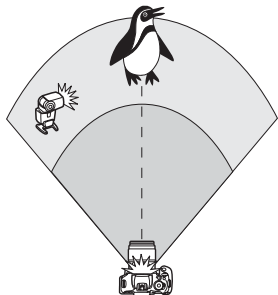

Custom Wireless Flash Shooting

Fully-automatic Shooting with One External Speedlite and Built-in Flash



This describes fully-automatic wireless flash shooting with one external Speedlite and the built-in flash.

You can change the flash ratio between the external Speedlite and built-in flash to adjust how the shadows look on the subject.

On the menu screens, the  and  icons refer to the external Speedlite, and the  and  icons refer to the built-in flash.

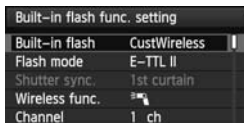

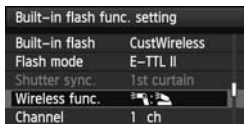

1 Select [CustWireless].

- Follow step 5 on page 192 to select [CustWireless], then press .



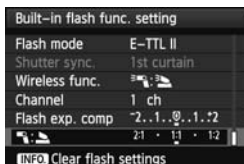

2 Select [Wireless func.].

- For [Wireless func.], select [ : ], then press .



3 Set the desired flash ratio and take the picture.

- Select [ : ] and set the flash ratio within 8:1 to 1:1. Setting a flash ratio to the right of 1:1 (up to 1:8) is not possible.
- If the built-in flash output is not enough, set a higher ISO speed (p.79).

 The 8:1 to 1:1 flash ratio is equivalent to 3:1 to 1:1 stops (1/2-stop increments).

Fully-automatic Shooting with Multiple External Speedlites

Multiple Speedlite slave units can be treated as one flash unit or separated into slave groups whose flash ratio can be set.

The basic settings are shown below. By changing the **[Firing group]** setting, you can shoot with various wireless flash setups with multiple Speedlites.

Built-in flash func. setting	
Built-in flash	CustWireless
Flash mode	E-TTL II
Shutter sync.	1st curtain
Wireless func.	
Channel	1 ch
Firing group	
INFO Clear flash settings	

Basic settings:

Flash mode : E-TTL II

E-TTL II meter. : Evaluative

Wireless func. :

Channel : (Same as slave units)

[All] Using multiple slave Speedlites as one flash unit

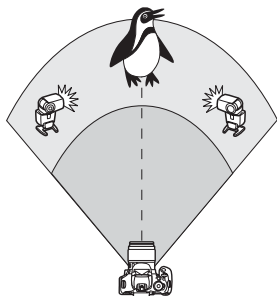

Convenient when you need a large flash output. All the slave Speedlites will fire at the same output and be controlled to obtain a standard exposure.

No matter what the slave ID is (A, B, or C), all the slave units will fire as one group.

Built-in flash func. setting	
Flash mode	E-TTL II
Shutter sync.	1st curtain
Wireless func.	
Channel	1 ch
Firing group	
exp. comp.	-2..1..0..1..2
INFO Clear flash settings	

Set **[Firing group]** to **[All]**, then take the picture.

[(A:B)] Multiple slave units in multiple groups

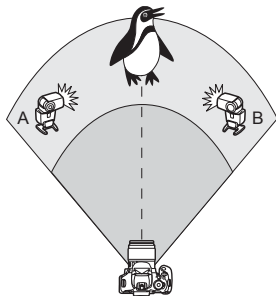

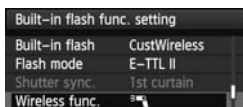

Divide the slave units into groups A and B, and change the flash ratio to obtain the desired lighting effect.

Refer to your Speedlite's instruction manual to set one slave unit's slave ID to A (Group A) and the other slave unit's ID to B (Group B) and position them as shown in the illustration.



1 Select [**Wireless func.**].

- Follow step 2 on page 194 to select [], then press <[]>.

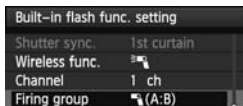

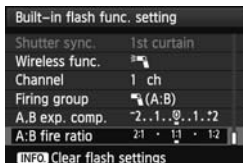

2 Set [**Firing group**] to [(A:B)].



3 Set the desired flash ratio and take the picture.

- Select [**A:B fire ratio**] and set the flash ratio.

 If [**Firing group**] is set to [ (A:B)], group C will not fire.

 The 8:1 to 1:1 to 1:8 flash ratio is equivalent to 3:1 to 1:1 to 1:3 stops (1/2-stop increments).

Fully-automatic Shooting with the Built-in Flash and Multiple External Speedlites

The built-in flash can also be added to wireless flash shooting explained on pages 195-196.

The basic settings are shown below. By changing the **[Firing group]** setting, you can shoot with various wireless flash setups of multiple Speedlites complemented with the built-in flash.

Built-in flash func. setting	
Built-in flash	CustWireless
Flash mode	E-TTL II
Shutter sync.	1st curtain
Wireless func.	[Flash] + [Wireless]
Channel	1 ch
exp. comp.	-2..1..0..1..2
[INFO] Clear flash settings	

1 Basic settings:

Flash mode : E-TTL II

E-TTL II meter. : Evaluative

Wireless func. : [Flash] + [Wireless]

Channel : (Same as slave units)

Built-in flash func. setting	
Shutter sync.	1st curtain
Wireless func.	[Flash] + [Wireless]
Channel	1 ch
exp. comp.	-2..1..0..1..2
Firing group	[All and]
exp. comp.	-2..1..0..1..2
[INFO] Clear flash settings	

2 Select [Firing group].

- Select the firing group, then set the flash ratio, flash exposure compensation, and other necessary settings before shooting.

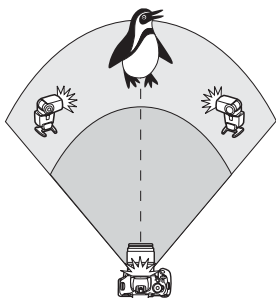

[Flash] All and [Wireless]

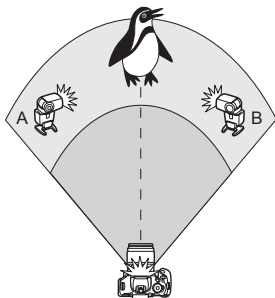

[Flash] (A:B) [Wireless]

Other Settings

Flash Exposure Compensation

When **[Flash mode]** is set to **[E-TTL II]**, flash exposure compensation can be set. The flash exposure compensation settings (see below) which can be set will differ depending on the **[Wireless func.]** and **[Firing group]** settings.

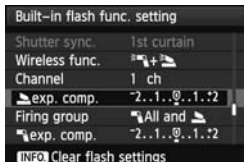

[Flash exp. comp]

- The flash exposure compensation is applied to the built-in flash and all external Speedlites.

[exp. comp.]

- The flash exposure compensation is applied to the built-in flash.

[exp. comp.]

- The flash exposure compensation is applied to all external Speedlites.

[A,B exp. comp.]

- The flash exposure compensation is applied to both groups A and B.

FE Lock

If **[Flash mode]** is set to **[E-TTL II]**, you can press the **< * >** button to perform FE lock.

Setting the Flash Output Manually for Wireless Flash

When **[Flash mode]** is set to **[Manual flash]**, the flash output can be set manually. The flash output settings (**[Flash output]**, **[Group A output]**, etc.) that can be set will differ depending on the **[Wireless func.]** setting (see below).

Built-in flash func. setting	
Built-in flash	CustWireless
Flash mode	Manual flash
Shutter sync.	1st curtain
Wireless func.	
Channel	1 ch
Firing group	All
INFO Clear flash settings	

[Wireless func.:]

- **[Firing group: All]**: The manual flash output setting will be applied to all the external Speedlites.
- **[Firing group: (A:B)]**: You can set the flash output separately for slave groups A and B.

[Wireless func.: +]

- **[Firing group: All and]**: The flash output can be set separately for the external Speedlite(s) and built-in flash.
- **[Firing group: (A:B)]**: You can set the flash output separately for slave groups A and B. You can also set the flash output for the built-in flash.



9

Image Playback

This chapter explains features related to viewing photos and movies, going into more detail than in Chapter 2 “Basic Shooting and Image Playback.” Here you will find explanations about how to playback and erase photos and movies with the camera and viewing them on a TV set.

About images taken with another camera:

The camera might not be able to properly display images captured with a different camera or edited with a computer or whose file name was changed.

▶ Searching for Images Quickly

▣ Display Multiple Images on One Screen (Index display)

Search for images quickly with the index display showing four or nine images on one screen.



1 Playback the image.

- When you press the <▶> button, the last image captured will be displayed.



2 Switch to the index display.

- Press the <▣◻> button.
- ▶ The 4-image index display will appear. The currently-selected image will be highlighted in a blue frame.
- Press the <▣◻> button again to switch to the 9-image index display.
- Pressing the <◻> button will switch the display between 9 images, 4 images and one image displayed.



3 Select an image.



- Press the <◀▶> key to move the blue frame to select an image.
- Turning the <⚙> dial will display the next screen or previous image.
- Press <SET> and the selected image will be displayed as a single image.

Jump through Images (Jump display)

With the single image display, you can turn the < > dial to jump through the images forward or back according to the jump method that was set.





1 Select [Image jump w/].

- Under the [] tab, select [Image jump w/, then press < >.



2 Select the jump method.

- Press the < > key to select the jump method, then press < >.

: Display images one by one

: Jump 10 images

: Jump 100 images

: Display by date

: Display by folder

: Display movies only

: Display stills only

: Display by image rating (p.206)

Turn the < > dial to select the rating.



Jump method

Playback position

3 Browse by jumping.

- Press the < > button to playback images.
- On the single-image display, turn the < > dial.





- To search images according to the shooting date, select [Date].
- To search images according to folder, select [Folder].
- If the card contains both [Movies] and [Stills], select either one to display only movies or stills.
- If no images match the selected [Rating], browsing through the images with < > is not possible.

Magnified View

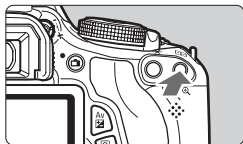
You can magnify a shot image by 1.5x to 10x on the LCD monitor.



1 Magnify the image.



- During image playback, press the  button.
- ▶ The image will be magnified.
- If you hold down the  button, the image will be magnified until it reaches the maximum magnification.
- Press the  button to reduce the magnification. If you hold down the button, the magnification will be reduced to the single image display.



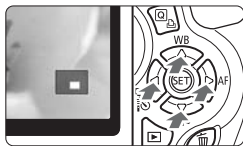

Magnified area position

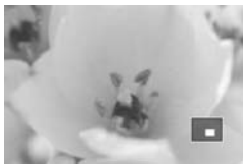

2 Scroll around the image.

- Use the  key to scroll around the magnified image.
- To exit the magnified display, press the  button and the single image display will return.





-  ● You can turn the  dial to view another image while the magnification is maintained.
- The image cannot be magnified during the image review immediately after shooting.
- A movie cannot be magnified.

Rotating the Image

You can rotate the displayed image to the desired orientation.



1 Select [Rotate].

- Under the [] tab, select [**Rotate**], then press < >.



2 Select an image.







- Press the < > key to select the image to be rotated.
- You can also select an image on the index display (p.202).



3 Rotate the image.

- Each time you press < >, the image will rotate clockwise as follows: 90° → 270° → 0°
- To rotate another image, repeat steps 2 and 3.
- To exit and return to the menu, press the <MENU> button.



- If you have set [ **Auto rotate**] to [**On**  ] (p.174) before taking vertical shots, you need not rotate the image as described above.
- If the rotated image is not displayed in the rotated orientation during image playback, set [ **Auto rotate**] to [**On**  ].
- A movie cannot be rotated.

MENU Setting Ratings

You can rate images and movies with one of five rating marks: [★]/[★ ★]/[★ ★ ★]/[★ ★ ★ ★]/[★ ★ ★ ★ ★].



1 Select [Rating].

- Under the [Rating] tab, select [Rating], then press <SET>.



2 Select an image or movie.

- Press the <◀▶> key to select an image or movie to be rated.
- You can display three images by pressing the <☒·Q> button. To return to the single-image display, press the <Q> button.





3 Rate the image or movie.

- Press the <▲▼> key to select a rating.
- ▶ The total number of images and movies rated will be counted for each rating.
- To rate another image or movie, repeat steps 2 and 3.
- To exit and return to the menu, press the <MENU> button.











The total number of a rating can be displayed up to 999. If there are 1,000 or more images for a rating, [###] will be displayed.

Taking advantage of ratings

- With [ **Image jump w** ], you can display only the rated images and movies.
- With [ **Slide show**], you can playback only the rated images and movies.
- With Digital Photo Professional (provided software, p.302), you can select only the rated images and movies.
- With Windows Vista and Windows 7, you can see the rating with the file information display or the provided image viewer.

Quick Control During Playback

During playback, you can press the  button to set any of the following: [ **Protect images**], [ Rotate], [ **Rating**], [ Creative filters], [ Resize (JPEG images only)], and [ **Image jump w/** ]. **For movies, only the functions in bold above can be set.**







1 Press the button.

- During image playback, press the  button.
- ▶ The functions settable with Quick Control will appear on the left of the screen.











2 Select a function and set it.



- Press the  key to select a function.
- ▶ The name and current setting of the selected function are displayed at the bottom.
- Set it by pressing the  key.
- For Creative filters and Resize, press  and set the function. For details, see page 230 for Creative filters and page 233 for Resize. To cancel, press the .

3 Exit the setting.

- Press the  button to turn off the Quick Control icons and function settings.

 To rotate an image, set [ **Auto rotate**] to [ On ]. If [ **Auto rotate**] is set to [ On ] or [ Off], the [ **Rotate**] setting will be recorded to the image, but the camera will not rotate the image for display.



- Pressing the <> button during the index display will switch to the single-image display and the Quick Control icons will appear. Pressing the <> button again will return to the index display.
- For images taken with another camera, selectable functions may be limited.

Enjoying Movies

Basically, you can playback movies in the following three ways:

Playback on a TV set (p.218, 221)



Use the provided AV cable or an HDMI Cable HTC-100 (sold separately) to connect the camera to a TV set. Then you can playback the captured movies and still photos on the TV.

If you have a High-Definition TV set and connect your camera with an HDMI cable, you can watch Full High-Definition (Full HD: 1920x1080) and High-Definition (HD: 1280x720) movies with higher image quality.

- Movies on a card can be played only by devices compatible with MOV files.
- Since hard disk recorders do not have an HDMI IN terminal, the camera cannot be connected to a hard disk recorder with an HDMI cable.
- Even if the camera is connected to a hard disk recorder with a USB cable, movies and still photos cannot be played nor saved.

Playback on the Camera's LCD Monitor (p.212-217)

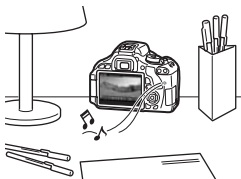

You can playback movies on the camera's LCD monitor. You can also edit out the movie's first and last scenes, and playback the images and movies in the card in an automatic slide show.

- A movie edited with a personal computer cannot be rewritten to the card and played back with the camera. However, video snapshot albums edited with ZoomBrowser EX/ImageBrowser (provided software) can be played on the camera.

Playback and Editing with a Personal Computer

(See the PDF file instruction manual for ZoomBrowser EX/ImageBrowser, p.304)



The movie files recorded in the card can be transferred to a personal computer and played or edited with ZoomBrowser EX/ImageBrowser (provided software, p.302).

You can also extract a single frame from a movie and save it as a still photo.

- To have the movie playback smoothly on a personal computer, use a high-performance personal computer. Regarding the computer hardware requirements for ZoomBrowser EX/ImageBrowser, see the PDF file instruction manual.
- If you want to use commercially-available software to playback or edit the movies, be sure it is compatible with MOV files. For details on commercially-available software, inquire the software maker.

▶▶ Playing Movies



1 Playback the image.

- Press the <▶> button to display images.



2 Select a movie.

- Press the <◀▶> key to select a movie.
- On the single-image display, the <▶▶ SET > icon displayed on the upper left indicates a movie. If the movie is a video snapshot, <▶▶ SET > will be displayed.
- You can press the <INFO.> button to switch the shooting information display (p.227).
- On the index display, the perforation on the left edge of the image indicates a movie. **As movies cannot be played on the index display, press <SET> to switch to the single-image display.**



3 On the single-image display, press <SET>.

- ▶ The movie playback panel will appear on the bottom.



4 Playback the movie.

- Select [▶] (Play), then press <SET>.
- ▶ The movie will start playing.
- You can pause the movie playback by pressing <SET>.
- During movie playback, you can turn the <🔊> dial to adjust the built-in speaker's sound volume.
- For more details on the playback procedure, see the next page.

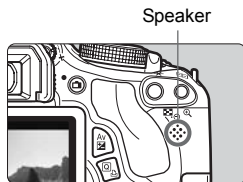

Function	Playback Description
Exit	Returns to the single-image display.
Play	Pressing <SET> toggles between play and stop.
Slow motion	Adjust the slow motion speed by pressing the <◀▶> key. The slow-motion speed is indicated on the upper right.
First frame	Displays the movie's first frame.
Previous frame	Each time you press <SET>, a single previous frame is displayed. If you hold down <SET>, it will rewind the movie.
Next frame	Each time you press <SET>, the movie will play frame-by-frame. If you hold down <SET>, it will fast forward the movie.
Last frame	Displays the movie's last frame.
Edit	Displays the editing screen (p.214).
Background music*	Playback a movie with the selected background music (p.217).
	Playback position
mm' ss"	Playback time (minutes:seconds)
Volume	You can adjust the built-in speaker's (p.212) sound volume by turning the <◀☀▶> dial.

* When a background music is set, the movie's sound will not be played.

MENU Bass Boost

This makes low-pitched bass tones easier to hear. This function takes effect only when playing back sound with the camera's built-in speaker.

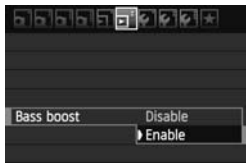

- Set [**Bass boost**] to [**Enable**].



If the sound crackles, you should set [**Bass boost**] to [**Disable**].



- With a fully-charged Battery Pack LP-E8, the continuous playback time will be approx. 2 hr. 30 min. at 23°C/73°F.
- If you took a still photo while you shot the movie, the still photo will be displayed for approx. 1 sec. during the movie playback.

✂ Editing a Movie's First and Last Scenes ■

You can edit out the first and last scenes of a movie in 1-sec. increments.



1 On the movie playback screen, select [✂].

- ▶ The editing screen will be displayed.



2 Specify the part to be edited out.

- Select either [✂] (Cut beginning) or [✂] (Cut end), then press <SET>.
- Press the <◀▶> key to see the previous or next frames. Holding it down will fast forward the frames.
- After deciding which part to edit out, press <SET>. The portion highlighted in blue on the top of the screen is what will remain.



3 Check the edited movie.

- Select [▶] and press <SET> to playback the portion highlighted in blue.
- To change the editing, go back to step 2.
- To cancel the editing, select [↶] and press <SET>.



4 Save the movie.

- Select [↵], then press <SET>.
- ▶ The save screen will appear.
- To save it as a new movie, select [New file]. To save it and overwrite the original movie file, select [Overwrite]. Then press <SET>.



- Since the editing is done in 1-sec. increments (position indicated by [✂]), the exact position where the movie is edited may differ slightly from the position you specified.
- If the card does not have enough room, [New file] will not be selectable.
- More movie editing functions are available with ZoomBrowser EX/ImageBrowser (provided software, p.302).

MENU Slide Show (Auto Playback)

You can playback the images in the card as an automatic slide show.



1 Select [Slide show].

- Under the [] tab, select [Slide show], then press <SET>.

Number of images to be played



2 Select the images to be played.

- Press the <▲> key to select the desired option, then press <SET>.

[All images/Movies/Stills]

- Press the <▲> key to select one of the following: [] All images/ [] Movies/ [] Stills]. Then press <SET>.



[Date/Folder/Rating]

- Press the <▲> key to select one of the following: [] Date/ [] Folder/ [] Rating].
- When <INFO. []> is highlighted, press the <INFO.> button.
- Press the <▲> key to select the desired option, then press <SET>.

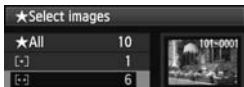

Item	Playback Description
[] All images	All the still photos and movies in the card will be played back.
[] Date	Still photos and movies taken on the selected shooting date will be played back.
[] Folder	Still photos and movies in the selected folder will be played back.
[] Movies	Only the movies in the card will be played back.
[] Stills	Only the still photos in the card will be played back.
★ Rating	Only the still photos and movies with the selected rating will be played back.



3 Set [Set up] as desired.

- Press the <▲▼> key to select [Set up], then press <SET>.
- Set the [Display time] (still photos), [Repeat], [Transition effect], and [Background music].
- The background music selection procedure is explained on the next page.
- After selecting the settings, press the <MENU> button.

[Display time]



[Repeat]



[Transition effect]

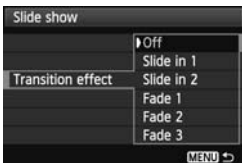

[Background music]

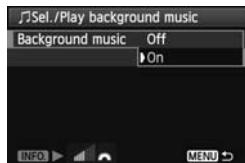



4 Start the slide show.

- Press the <▲▼> key to select [Start], then press <SET>.
- ▶ After [Loading image...] is displayed, the slide show will start.

5 Quit the slide show.

- To quit the slide show and return to the setting screen, press the <MENU> button.

Selecting the Background Music



- Set [Background music] to [On], then press <SET>.
- Press the <▲▼> key to select the desired background music then press <SET>. You can also select multiple background musics.

- To hear a sample of a background music, press the <INFO.> button. Press the <▲▼> key to listen to another background music. To stop listening to the background music, press the <INFO.> button again. Adjust the sound volume by turning the <🔊> dial.
- After selecting the setting, press the <MENU> button.



- To pause the slide show, press <SET>. During pause, [||] will be displayed on the upper left of the image. Press <SET> again to resume the slide show.
- During auto playback, you can press the <INFO.> button to change the still photo display format (p.71).
- During movie playback, you can adjust the sound volume by turning the <🔊> dial.
- During pause, you can press the <◀▶> key to view another image.
- During the slide show, auto power off will not take effect.
- The display time may vary depending on the image.
- To view the slide show on a TV set, see pages 218.
- Upon purchase, the camera is not set for selecting the background music. You must first use EOS Utility (provided software) to copy the background music to the card. For details, see the EOS Utility Instruction Manual in the CD-ROM.

Viewing the Images on TV

You can view the still photos and movies on a TV set.

- Adjust the movie's sound volume with the TV set. The sound volume cannot be adjusted with the camera.
- Before connecting or disconnecting the cable between the camera and television, turn off the camera and TV set.
- Depending on the TV set, part of the image displayed might be cut off.

Viewing on HD (High-Definition) TV Sets

HDMI Cable HTC-100 (sold separately) is required.

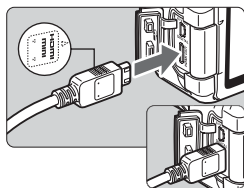

1 Connect the HDMI cable to the camera.

- With the plug's <▲HDMI MINI> logo facing the front of the camera, insert it into the <HDMI OUT> terminal.

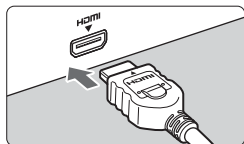

2 Connect the HDMI cable to the TV set.

- Connect the HDMI cable to the TV's HDMI IN port.

3 Turn on the TV and switch the TV's video input to select the connected port.

4 Set the camera's power switch to <ON>.

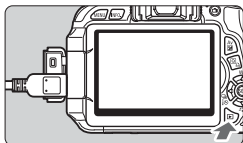

5 Press the <▶> button.

- ▶ The image will appear on the TV screen (Nothing will be displayed on the camera's LCD monitor).
- The images will automatically be displayed at the TV's optimum resolution.
- By pressing the <INFO.> button, you can change the display format.
- To playback movies, see page 212.



- Do not connect any other device's output to the camera's <HDMI OUT > terminal. Doing so may cause a malfunction.
- Certain TVs might not be able to playback the captured images. In such a case, use the provided AV cable to connect to the TV.
- The camera's <A/V OUT > terminal and <HDMI OUT > terminal cannot be used at the same time.

Using HDMI CEC TV Sets

If the TV set connected to the camera with an HDMI cable is compatible with HDMI CEC*, you can use the TV set's remote control for playback operations.

* An HDMI-standard function enabling HDMI devices to control each other so that you can control them with one remote control unit.



1 Set [Ctrl over HDMI] to [Enable].

- Under the [Σ] tab, select [Ctrl over HDMI], then press <SET>.
- Select [Enable], then press <SET>.

2 Connect the camera to a TV set.

- Use an HDMI cable to connect the camera to the TV.
- ▶ The TV's input will switch automatically to the HDMI port connected to the camera.

3 Press the camera's <▶> button.

- ▶ An image will appear on the TV screen and you can use the TV's remote control to playback images.

4 Select an image or movie.

- Point the remote control toward the TV set and press the ←/→ button to select an image.

Still photo playback menu



Movie playback menu



- : Return
- : 9-image index
- : Play movie
- : Slide show
- INFO.** : Disp. shooting info
- : Rotate

5 Press the remote control's Enter button.

- ▶ The menu appears and you can do the playback operations shown on the left.
- Press the ←/→ button to select the desired option, then press the Enter button. For a slide show, press the remote control's ↑/↓ button to select an option, then press the Enter button.
- If you select [**Return**] and press the Enter button, the menu will disappear and you can use the ←/→ button to select an image.

- Some TV sets require you to first enable the HDMI CEC connection. For details, see the TV set's instruction manual.
- Certain TV sets, even those compatible with HDMI CEC, may not operate properly. In such a case, disconnect the HDMI cable, set [**Ctrl over HDMI**] to [**Disable**], and use the camera to control the playback operation.

Viewing on Non-HD (High-Definition) TV Sets

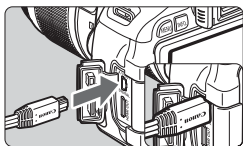

1 Connect the provided AV cable to the camera.

- With the plug's <Canon> logo facing the back of the camera, insert it into the < A/V OUT > terminal.

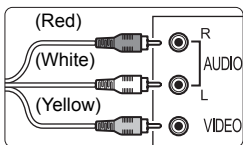

2 Connect the AV cable to the TV set.

- Connect the AV cable to the TV's video IN terminal and audio IN terminal.

3 Turn on the TV and switch the TV's video input to select the connected port.

4 Set the camera's power switch to <ON>.

5 Press the <▶> button.

- ▶ The image will appear on the TV screen (Nothing will be displayed on the camera's LCD monitor).
- To playback movies, see page 212.

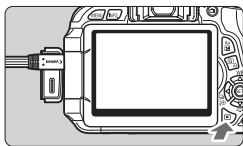

- Do not use any AV cable other than the one provided. Images might not be displayed if you use a different cable.
- If the video system format does not match the TV's, the images will not be displayed properly. Set the proper video system format with [**Ⓜ**: Video system].

Protecting Images

Protecting an image prevents it from being erased accidentally.

MENU Protecting a Single Image



1 Select [Protect images].

- Under the [] tab, select [Protect images], then press <SET>.
- ▶ The protect setting screen will appear.





2 Select [Select images].

- Select [Select images], then press <SET>.

Image protect icon



3 Protect the image.

- Press the <◀▶> key to select the image to be protected, then press <SET>.
- ▶ When an image is protected, the <> icon will appear on the top of the screen.
- To cancel the image protection, press <SET> again. The <> icon will disappear.
- To protect another image, repeat step 3.
- To exit the image protection, press the <MENU> button. The menu will reappear.

MENU Protecting All Images in a Folder or Card

You can protect all the images in a folder or card at one time.



When you select [**All images in folder**] or [**All images on card**] in [**Protect images**], all the images in the folder or card will be protected.

To cancel the image protection, select [**Unprotect all images in folder**] or [**Unprotect all images on card**].

 **If you format the card (p.45), the protected images will also be erased.**



- Movies can also be protected.
- Once an image is protected, it cannot be erased by the camera's erase function. To erase a protected image, you must first cancel the protection.
- If you erase all the images (p.225), only the protected images will remain. This is convenient when you want to erase unnecessary images all at once.

Erasing Images

You can either select and erase images one by one or erase them in one batch. Protected images (p.222) will not be erased.

- 1 **Once an image is erased, it cannot be recovered. Make sure you no longer need the image before erasing it. To prevent important images from being erased accidentally, protect them. Erasing a **RAW** + **L** image will erase both the **RAW** and **L** images.**

Erasing a Single Image



- 1 **Playback the image to be erased.**

- 2 **Press the  button.**

- ▶ The erase dialog will appear at the bottom of the screen.



- 3 **Erase the images.**

- Select [**Erase**], then press **<SET>**. The image displayed will be erased.

MENU Checkmarking Images to be Erased in a Batch

By checkmarking the images to be erased, you can erase multiple images at one time.

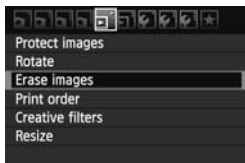

- 1 **Select [**Erase images**].**

- Under the [**Erase images**] tab, select [**Erase images**], then press **<SET>**.

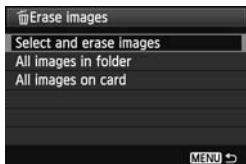

2 Select [Select and erase images].

- Select [Select and erase images], then press <SET>.
- ▶ The images will be displayed.
- To display the three-image display, press the <[OK]·Q> button. To return to the single-image display, press the <Q> button.



3 Select the images to be erased.

- Press the <◀▶> key to select the image to be erased, then press the <▲▼> key.
- ▶ A <✓> checkmark will be displayed on the upper left.
- To select other images to be erased, repeat step 3.



4 Erase the images.

- Press the <[trash]> button.
- Select [OK], then press <SET>.
- ▶ The selected images will be erased.

MENU Erasing All Images in a Folder or Card

You can erase all the images in a folder or card at one time. When [Erase images] is set to [All images in folder] or [All images on card], all the images in the folder or card will be erased.

 To also erase protected images, format the card (p.45).

INFO. Shooting Information Display

Sample Image Taken in a Creative Zone Mode

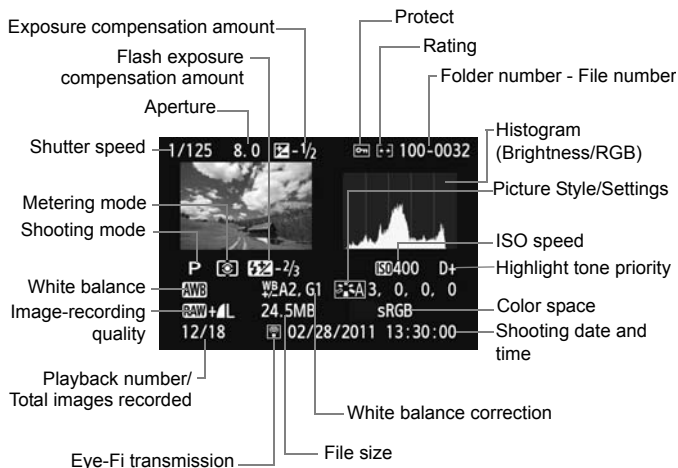

* With **RAW** + **L** images, the **RAW** file size is displayed.

* For still photos taken in movie shooting mode, **<M>** will be displayed.

* If a Creative filter or Resize has been applied to the image, the **<RAW +>** icon will change to **<RF>**.

* Photos taken with flash without any flash exposure compensation are marked with the **<F>** icon. Photos taken with flash exposure compensation are marked with the **<F2>** icon.

Sample Image Taken in a Basic Zone Mode

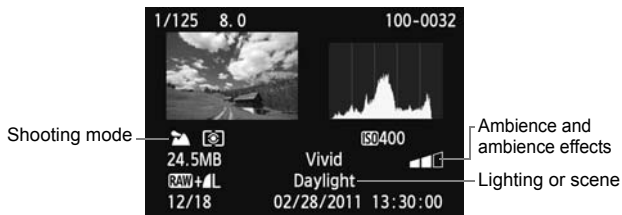

* For images taken in Basic Zone modes, the information displayed differ depending on the shooting mode.

* Photos taken in the <CA> mode will show [Background blur].

Sample Movie Taken in Movie Mode

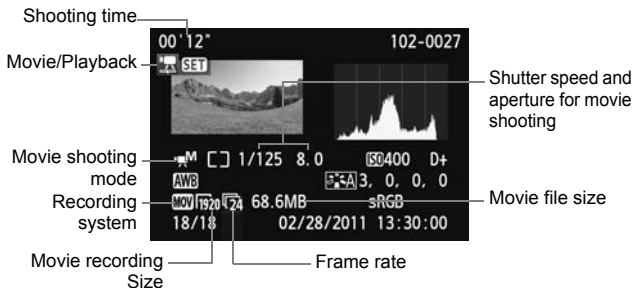

* If manual exposure was used, the shutter speed, aperture, and ISO speed (when set manually) will be displayed.

* The <M> icon will be displayed for a video snapshot.

- **About the Highlight Alert**

When the shooting information is displayed, any overexposed areas of the image will blink. To obtain more image detail in the overexposed areas, set the exposure compensation to a negative amount and shoot again.

- **About the Histogram**

The brightness histogram shows the exposure level distribution and overall brightness. The RGB histogram is for checking the color saturation and gradation. The display can be switched with [**☐** Histogram].

[Brightness] Display

This histogram is a graph showing the distribution of the image's brightness level. The horizontal axis indicates the brightness level (darker on the left and brighter on the right), while the vertical axis indicates how many pixels exist for each brightness level. The more pixels there are toward the left, the darker the image. And the more pixels there are toward the right, the brighter the image. If there are too many pixels on the left, the shadow detail will be lost. And if there are too many pixels on the right, the highlight detail will be lost. The gradation in-between will be reproduced. By checking the image and its brightness histogram, you can see the exposure level inclination and the overall gradation.

Sample Histograms



Dark image



Normal brightness



Bright image

[RGB] Display

This histogram is a graph showing the distribution of each primary color's brightness level in the image (RGB or red, green, and blue). The horizontal axis indicates the color's brightness level (darker on the left and brighter on the right), while the vertical axis indicates how many pixels exist for each color brightness level. The more pixels there are toward the left, the darker and less prominent the color. And the more pixels there are toward the right, the brighter and denser the color. If there are too many pixels on the left, the respective color information will be lacking. And if there are too many pixels on the right, the color will be too saturated with no detail. By checking the image's RGB histogram, you can see the color's saturation and gradation condition and white balance inclination.

10

Post-Processing Images

After shooting, you can apply Creative filters or resize the images (downsize the pixel count).

- It may not be possible to process images shot with a different camera.
- Post-processing images as described in this chapter cannot be done while the camera is connected to a personal computer via the <**DIGITAL**> terminal.

Creative Filters

You can apply the following Creative filters to an image and save it as a new image: Grainy B/W, Soft focus, Fish-eye effect, Toy camera effect, and Miniature effect.





1 Select [Creative filters].

- Under the [] tab, select [Creative filters], then press <SET>.
- ▶ The images will be displayed.



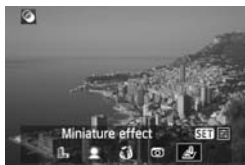

2 Select an image.

- Select the image you want to apply a filter to.
- By pressing the <- > button, you can switch to the index display and select an image.







3 Select a filter.

- When you press <SET>, the Creative filters will be displayed.
- For details on Creative filter characteristics, see page 232.
- Press the <- > key to select a filter, then press <SET>.
- ▶ The image applied with the respective filter will be displayed.



4 Adjust the filter effect.

- Press the <- > key to adjust the filter effect, then press <SET>.
- For the Miniature effect, press the <- > key and select the image area (within the white frame) where you want the image to look sharp. Then press <SET>.

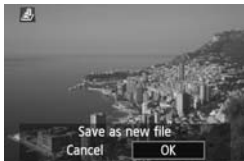

5 Save the image.

- Select **[OK]** to save the image.
- Note the destination folder and image file number, then select **[OK]**.
- To apply a filter to another image, repeat steps 2 to 5.
- To exit and return to the menu, press the **<MENU>** button.



With **RAW** or **RAW + L** images, the **RAW** image will be applied with the Creative filter and saved as a JPEG image. If an aspect ratio has been set for Live View shooting and a Creative filter is applied to the **RAW** image, the image will be saved in the aspect ratio that was set.

Creative Filter Features

-  **Grainy B/W**

Makes the image grainy and black and white. By adjusting the contrast, you can change the black-and-white effect.

-  **Soft focus**

Gives the image a soft look. By adjusting the blur, you can change the degree of softness.

-  **Fish-eye effect**

Gives the effect of a fish-eye lens. The image will have a barrel-type distortion.

Depending on the level of this filter effect, the area trimmed along the periphery of the image changes. Also, since this filter effect will magnify the image center, the apparent resolution at the center may degrade depending on the number of recorded pixels. So in step 4, set the filter effect while checking the resulting image.

-  **Toy camera effect**

Gives a color cast typical of toy cameras and darkens the image's four corners. By adjusting the color tone, you can change the color cast.

-  **Miniature effect**

Creates a diorama effect. You can change where the image looks sharp. In step 4, you can press the <INFO.> button to change the orientation (vertical/horizontal) of the white frame that shows where you want the image to look sharp.

Resize

You can resize an image to make the pixel count lower and save it as a new image. Resizing an image is possible only with JPEG **L/M/S1/S2** images. JPEG **S3** and RAW images cannot be resized.

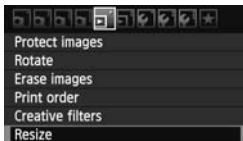

1 Select [Resize].

- Under the [] tab, select [**Resize**], then press <SET>.
- ▶ The images will be displayed.



2 Select an image.

- Select the image you want to resize.
- By pressing the <-Q> button, you can switch to the index display and select an image.



Target sizes

3 Select the desired image size.

- Press <SET> to display the image sizes.
- Press the <◀▶> key to select the desired image size, then press <SET>.



4 Save the image.

- Select [**OK**] to save the image.
- Note the destination folder and image file number, then select [**OK**].
- To resize another image, repeat steps 2 to 4.
- To exit and return to the menu, press the <MENU> button.

Resize Options According to Original Image Size

Original Image Size	Available Resize Settings			
	M	S1	S2	S3
L	<input type="radio"/>	<input type="radio"/>	<input type="radio"/>	<input type="radio"/>
M		<input type="radio"/>	<input type="radio"/>	<input type="radio"/>
S1			<input type="radio"/>	<input type="radio"/>
S2				<input type="radio"/>
S3				

About Image Sizes

Images such as the **[8.0M 3456x2304]** image size displayed in step 3 (p.233) have a 3:2 aspect ratio. The image size according to aspect ratios is shown in the table below. The asterisked image-recording quality figures do not exactly match the aspect ratio. The image will be slightly cropped.

Quality	Aspect Ratio and Pixel Count (Approx.)			
	3:2	4:3	16:9	1:1
M	3456x2304 (8.0 megapixels)	3072x2304 (7.0 megapixels)	3456x1944 (6.7 megapixels)	2304x2304 (5.3 megapixels)
S1	2592x1728 (4.5 megapixels)	2304x1728 (4.0 megapixels)	2592x1456* (3.8 megapixels)	1728x1728 (3.0 megapixels)
S2	1920x1280 (2.5 megapixels)	1696x1280* (2.2 megapixels)	1920x1080 (2.1 megapixels)	1280x1280 (1.6 megapixels)
S3	720x480 (350,000 pixels)	640x480 (310,000 pixels)	720x400* (290,000 pixels)	480x480 (230,000 pixels)

11

Printing Images

- **Printing** (p.236)
You can connect the camera directly to a printer and print out the images in the card. The camera is compatible with “PictBridge” which is the standard for direct printing.
- **Digital Print Order Format (DPOF)** (p.245)
DPOF (Digital Print Order Format) enables you to print images recorded in the card according to your printing instructions such as the image selection, quantity to print, etc. You can print multiple images in one batch or give the print order to a photofinisher.

Preparing to Print

The direct printing procedure is done entirely with the camera while you look at the LCD monitor.

Connecting the Camera to a Printer

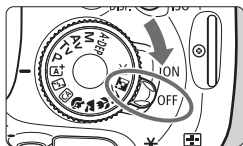

- 1 Set the camera's power switch to <OFF>.

- 2 Set up the printer.

- For details, see the printer's instruction manual.

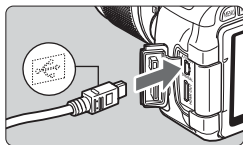

- 3 Connecting the camera to the printer.

- Use the interface cable provided with the camera.
- Connect the cable to the camera's <DIGITAL> terminal with the cable plug's <↔> icon facing the front of the camera.
- To connect to the printer, refer to the printer's instruction manual.

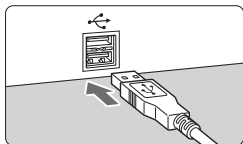

- 4 Turn on the printer.

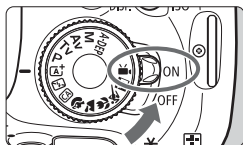

- 5 Set the camera's power switch to <ON>.

- ▶ Some printers may make a beeping sound.

PictBridge



6 Playback the image.

- Press the <▶> button.
- ▶ The image will appear, and the <PictBridge icon> will appear on the upper left to indicate that the camera is connected to a printer.



- Movies cannot be printed.
- The camera cannot be used with printers compatible only with CP Direct or Bubble Jet Direct.
- Do not use any interface cable other than the one provided.
- If there is a long beeping sound in step 5, it indicates a problem with the printer. Resolve the problem displayed by the error message (p.244).



- You can also print RAW images taken with this camera.
- If you use a battery pack to power the camera, make sure it is fully charged. With a fully-charged battery, printing up to about 4 hours is possible.
- Before disconnecting the cable, first turn off the camera and printer. Hold the plug (not the cord) to pull out the cable.
- For direct printing, using AC Adapter Kit ACK-E8 (sold separately) to power the camera is recommended.

Printing

The screen display and setting options will differ depending on the printer. Some settings might not be available. For details, see the printer's instruction manual.



1 Select the image to be printed.

- Check that the icon is displayed on the upper left of the LCD monitor.
- Press the key to select the image to be printed.

2 Press .

- ▶ The print setting screen will appear.

Print setting screen

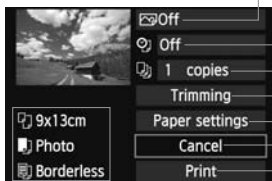

— Sets the printing effects (p.240).

— Sets the date or file number imprinting to on or off.

— Sets the quantity to be printed.

— Sets the trimming (cropping) (p.243).

— Sets the paper size, type, and layout.

— Returns to the screen in step 1.

— Starts the printing.

The paper size, type, and layout you have set are displayed.

* Depending on the printer, certain settings such as the date and file number imprinting and trimming might not be selectable.

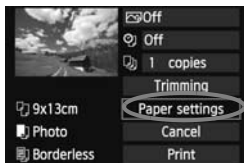

3 Select [Paper settings].

- Select [Paper settings], then press .
- ▶ The paper settings screen will appear.

Setting the Paper Size



- Select the size of the paper loaded in the printer, then press **<SET>**.
- ▶ The paper type screen will appear.

Setting the Paper Type



- Select the type of the paper loaded in the printer, then press **<SET>**.
- ▶ The page layout screen will appear.

Setting the Page Layout



- Select the page layout, then press **<SET>**.
- ▶ The print setting screen will reappear.

Bordered	The print will have white borders along the edges.
Borderless	The print will have no borders. If your printer cannot print borderless prints, the print will have borders.
Bordered [i]	The shooting information* ¹ will be imprinted on the border on 9x13cm and larger prints.
xx-up	Option to print 2, 4, 8, 9, 16, or 20 images on one sheet.
20-up [i] 35-up [i]	Twenty or 35 images will be printed as thumbnails on A4 or Letter size paper* ² . • [20-up [i]] will have the shooting information* ¹ imprinted.
Default	The page layout will vary depending on the printer model or its settings.

*1: From the Exif data, the camera name, lens name, shooting mode, shutter speed, aperture, exposure compensation amount, ISO speed, white balance, etc., will be imprinted.

*2: After ordering the prints with "Digital Print Order Format (DPOF)" (p.245), you should print by following "Direct Printing with DPOF" (p.248).

If the image's aspect ratio is different from the printing paper's aspect ratio, the image may be cropped significantly if you print it as a borderless print. If the image is cropped, it may look more grainy on the paper due to the fewer number of pixels.

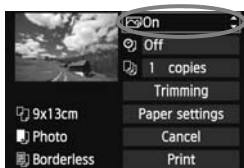

4 Set the printing effects.

- Set as necessary. If you need not set any printing effects, go to step 5.
- **What is displayed on the screen differs depending on the printer.**
- Select the option on the upper right (circled in the screenshot), then press **< (SET) >**.
- Select the desired printing effect, then press **< (SET) >**.
- If the **< [INFO] >** icon is displayed brightly next to **< INFO >**, you can also adjust the printing effect (p.242).

Printing Effect	Description
On	The image will be printed according to the printer's standard colors. The image's Exif data is used to make automatic corrections.
Off	No automatic correction will be applied.
VIVID	The image will be printed with higher saturation to produce more vivid blues and greens.
NR	Image noise is reduced before printing.
B/W B/W	Prints in black-and-white with true blacks.
B/W Cool tone	Prints in black-and-white with cool, bluish blacks.
B/W Warm tone	Prints in black-and-white with warm, yellowish blacks.
Natural	Prints the image in the actual colors and contrast. No automatic color adjustments are applied.
Natural M	The printing characteristics are the same as the "Natural" setting. However, this setting enables finer printing adjustments than with "Natural."
Default	The printing will differ depending on the printer. For details, see the printer's instruction manual.

* When you change the printing effects, it is reflected in the image displayed on the upper left. Note that the printed image might look slightly different from the displayed image which is only an approximation. This also applies to [Brightness] and [Adjust levels] on page 242.



5 Set the date and file number imprinting.

- Set as necessary.
- Select <☺>, then press <SET>.
- Set as desired, then press <SET>.

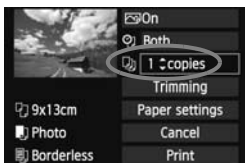

6 Set the number of copies.

- Set as necessary.
- Select <☺>, then press <SET>.
- Set the number of copies, then press <SET>.

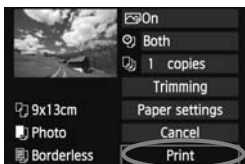

7 Start printing.

- Select [Print], then press <SET>.



- With Easy printing, you can print another image using the same settings. Just select the image and press the <☺> button. With Easy printing, the number of copies will always be 1. (You cannot set the number of copies.) Also, any trimming (p.243) will not be applied.
- The [Default] setting for printing effects and other options are the printer's own default settings as set by the printer's manufacturer. See the printer's instruction manual to find out what the [Default] settings are.
- Depending on the image's file size and image-recording quality, it may take some time for the printing to start after you select [Print].
- If image tilt correction (p.243) has been applied, it may take longer to print the image.
- To stop the printing, press <SET> while [Stop] is displayed, then select [OK].
- If you execute [Clear all camera settings] (p.176), all the settings will revert to the default.

Adjustment of Printing Effects

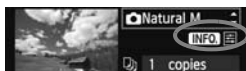

In step 4 on page 240, select the printing effect. When the <INFO.> icon is displayed brightly next to <INFO.>, you can press the <INFO.> button to adjust the printing effect. What can be adjusted or what is displayed will depend on the selection made in step 4.

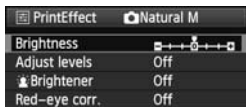

● Brightness

The image brightness can be adjusted.

● Adjust levels

When you select [**Manual**], you can change the histogram's distribution and adjust the image's brightness and contrast.

With the Adjust levels screen displayed, press the <INFO.> button to change the position of the <↑>. Press the <◀▶> key to freely adjust the shadow level (0-127) or highlight level (128-255).



● Brightener

Effective in backlit conditions which can make the subject's face look dark. When [**On**] is set, the face will be brightened for printing.

● Red-eye corr.

Effective in flash images where the subject has red eye. When [**On**] is set, the red eye will be corrected for printing.

- The [**Brightener**] and [**Red-eye corr.**] effects will not show on the screen.
- When you select [**Detail set.**], you can adjust the [**Contrast**], [**Saturation**], [**Color tone**], and [**Color balance**]. To adjust the [**Color balance**], use the <◀▶> keys. B is for blue, A is amber, M is magenta, and G is green. The color in the respective direction will be corrected.
- If you select [**Clear all**], all the printing effect settings will be reverted to the default.

Trimming the Image



You can crop the image and print only the trimmed portion as if the image was recomposed. **Do the trimming right before printing.** If you set the trimming and then set the print settings, you may have to set the trimming again.

1 On the print setting screen, select [Trimming].

2 Set the trimming frame size, position, and aspect ratio.

- The image area within the trimming frame will be printed. The trimming frame's aspect ratio can be changed with [Paper settings].

Changing the trimming frame size

When you press the $\langle \text{Q} \rangle$ or $\langle \text{Q} \cdot \text{Q} \rangle$ button, the size of the trimming frame will change. The smaller the trimming frame, the larger the image magnification will be for printing.

Moving the trimming frame

Press the $\langle \text{D} \rangle$ key to move the frame over the image vertically or horizontally. Move the trimming frame until it covers the desired image area.

Rotating the frame

Pressing the $\langle \text{INFO} \rangle$ button will toggle the trimming frame between the vertical and horizontal orientations. This enables you to create a vertical-oriented print from a horizontal image.

Image tilt correction

By turning the $\langle \text{DIAL} \rangle$ dial, you can adjust the image tilt angle up to ± 10 degrees in 0.5-degree increments. When you adjust the image tilt, the $\langle \text{DIAL} \rangle$ icon on the screen will turn blue.

3 Press $\langle \text{SET} \rangle$ to exit the trimming.

- ▶ The print setting screen will reappear.
- You can check the trimmed image area on the upper left of the print setting screen.

- Depending on the printer, the trimmed image area might not be printed as you specified.
- The smaller you make the trimming frame, the grainier the picture will look in the print.
- While trimming the image, look at the camera's LCD monitor. If you look at the image on a TV screen, the trimming frame might not be displayed accurately.



Handling Printer Errors

If you resolve a printer error (no ink, no paper, etc.) and select **[Continue]** to resume printing but it does not resume, operate the buttons on the printer to resume printing. For details on resuming the printing, see the printer's instruction manual.

Error Messages

If a problem occurs during printing, an error message will appear on the camera's LCD monitor. Press **<SET>** to stop printing. After fixing the problem, resume printing. For details on how to fix a printing problem, refer to the printer's instruction manual.

Paper Error

Check whether the paper is properly loaded in the printer.

Ink Error

Check the printer's ink level, and check the waste ink tank.

Hardware Error

Check for any printer problems other than paper and ink problems.

File Error

The selected image cannot be printed via PictBridge. Images taken with a different camera or images edited with a computer might not be printable.

Digital Print Order Format (DPOF)

You can set the print type, date imprinting, and file No. imprinting. The print settings will be applied to all print-ordered images. (They cannot be set individually for each image.)

Setting the Printing Options



1 Select [Print order].

- Under the [Print] tab, select [Print order], then press <SET>.

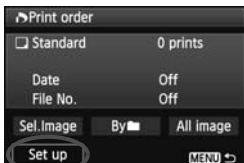

2 Select [Set up].

- Select [Set up], then press <SET>.

3 Set the option as desired.

- Set the [Print type], [Date], and [File No.].
- Select the option to be set, then press <SET>. Select the desired setting, then press <SET>.

[Print type]

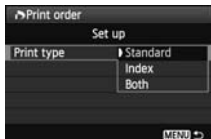

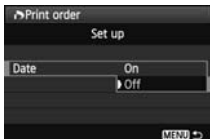

[Date]

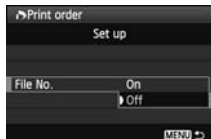

[File No.]



Print type		Standard	Prints one image on one sheet.
		Index	Multiple thumbnail images are printed on one sheet.
		Both	Prints both the standard and index prints.
Date	On	[On] imprints the recorded date on the print.	
	Off		
File number	On	[On] imprints the file No. on the print.	
	Off		

4 Exit the setting.

- Press the <MENU> button.
- ▶ The print order screen will reappear.
- Next, select [**Sel.Image**], [**By** ], or [**All image**] to order the images to be printed.



- Even if [**Date**] and [**File No.**] are set to [**On**], the date or file No. might not be imprinted depending on the print type setting and printer model.
- When printing with DPOF, you must use the card whose print order specifications have been set. It will not work if you just extract images from the card and try to print them.
- Certain DPOF-compatible printers and photofinishers might not be able to print the images as you specified. If this happens with your printer, refer to the printer's instruction manual. Or check with your photofinisher about compatibility when ordering prints.
- Do not insert into the camera a card whose print order was set by a different camera and then try to specify a print order. The print order may not work or may be overwritten. Also, depending on the image type, the print order may not be possible.

- RAW images and movies cannot be print ordered. You can print RAW images through direct printing (p.236).
- With [**Index**] prints, both the [**Date**] and [**File No.**] cannot be set to [**On**] at the same time.

Print Ordering

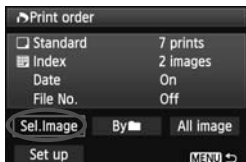
● Sel.Image



Select and order images one by one. To display the three-image display, press the <  > button. To return to the single-image display, press the <  > button.

After completing the print order, press the <MENU> button to save the print order to the card.



Quantity

Total images selected

[Standard] [Both]

Press the <▲▼> key to set the number of copies to be printed for the displayed image.



Check mark

Index icon

[Index]

Press the <▲▼> key to checkmark the box <  > and the image will be included in the index print.

● By

Select [**Mark all in folder**] and select the folder. A print order for one copy of all the images in the folder will be placed. If you select [**Clear all in folder**] and select the folder, the print order for that folder will all be canceled.

● All image

If you select [**Mark all on card**], one copy of all the images in the card will be set for printing. If you select [**Clear all on card**], the print order will be cleared for all the images in the card.



- Note that RAW images and movies will not be included in the print order even if you set “By ” or “All image.”
- When using a PictBridge printer, print no more than 400 images for one print order. If you specify more than this, all the images might not be printed.

Direct Printing with DPOF



With a PictBridge printer, you can easily print images with DPOF.

1 Prepare to print.

- See page 236. Follow the “Connecting the Camera to a Printer” procedure up to step 5.

2 Under the [] tab, select [Print order].

3 Select [Print].

- [Print] will be displayed only if the camera is connected to a printer and printing is possible.

4 Set the [Paper settings] (p.238).

- Set the printing effects (p.240) if necessary.

5 Select [OK].

- Before printing, be sure to set the paper size.
- Certain printers cannot imprint the file No.
- If [**Bordered**] is set, certain printers might imprint the date on the border.
- Depending on the printer, the date might look light if it is imprinted on a bright background or on the border.

- Under [**Adjust levels**], [**Manual**] cannot be selected.
- If you stopped the printing and want to resume printing the remaining images, select [**Resume**]. Note that printing will not resume if you stop the printing and any of the following occurs:
 - Before resuming the printing, you changed the print order or deleted print-ordered images.
 - When you set the index, you changed the paper setting before resuming the printing.
 - When you paused the printing, the card's remaining capacity was low.
- If a problem occurs during printing, see page 244.

12

Customizing the Camera

You can customize various camera features to suit your picture-taking preferences with Custom Functions. Custom Functions can be set and used only in Creative Zone modes.

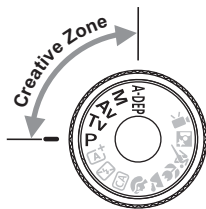

MENU Setting Custom Functions ☆

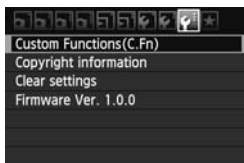

1 Select [Custom Functions (C.Fn)].

- Under the [**☛**] tab, select [**Custom Functions (C.Fn)**], then press <SET>.

Custom Function No.

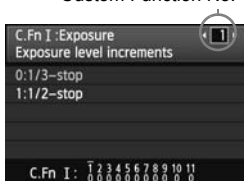

2 Select the Custom Function No.

- Press the <◀▶> key to select the Custom Function No., then press <SET>.

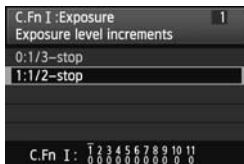

3 Change the setting as desired.

- Press the <▲▼> key to select the setting (number), then press <SET>.
- Repeat steps 2 and 3 if you want to set other Custom Functions.
- At the bottom of the screen, the current Custom Function settings are indicated below the respective function numbers.

4 Exit the setting.

- Press the <MENU> button.
- ▶ The screen for step 1 will reappear.

Clearing All Custom Functions

Under [**☛** **Clear settings**], select [**Clear all Custom Func. (C.Fn)**] to clear all the Custom Function settings (p.176).

Custom Functions

C.Fn I: Exposure

			 LV shooting
1	Exposure level increments	p.252	<input type="radio"/>
2	ISO expansion		<input type="radio"/>
3	Flash sync. speed in Av mode		<input type="radio"/>

C.Fn II: Image

4	Long exposure noise reduction	p.253	<input type="radio"/>
5	High ISO speed noise reduction	p.254	<input type="radio"/>
6	Highlight tone priority		<input type="radio"/>

C.Fn III: Autofocus/Drive

7	AF-assist beam firing	p.255	<input type="radio"/> (With AF-Quick*)
8	Mirror lockup		<input type="radio"/>

* If you use an EX-series Speedlite (sold separately) equipped with a LED light, the LED light will turn on for AF-assist even in the AF-Live and AF- modes.

C.Fn IV: Operation/Others

9	Shutter/AE lock button	p.256	<input type="radio"/>
10	Assign SET button		<input type="radio"/> (Except 3)
11	LCD display when power ON	p.257	<input type="radio"/>



The shaded Custom Functions do not take effect during Live View (LV) shooting. (Settings are disabled.)

MENU Custom Function Settings ☆

Custom Functions are organized into four groups based on the function type: C.Fn I: Exposure, C.Fn II: Image, C.Fn III: Autofocus/Drive, C.Fn IV: Operation/Others.

C.Fn I: Exposure

C.Fn-1 Exposure level increments

0: 1/3-stop

1: 1/2-stop

Sets 1/2-stop increments for the shutter speed, aperture, exposure compensation, AEB, flash exposure compensation, etc. Effective when you prefer to control the exposure in less fine increments than 1/3-stop increments.

 With setting 1, the exposure level will be displayed in the viewfinder and on the LCD monitor as shown below.



C.Fn-2 ISO expansion

0: Off

1: On

For the ISO speed, "H" (equivalent to ISO 12800) will be selectable. Note that if [C.Fn-6: Highlight tone priority] has been set to [1: Enable], "H" cannot be set.

C.Fn-3 Flash sync. speed in Av (Aperture-priority AE) mode

When you use flash in the aperture-priority AE mode (Av), you can set the flash sync speed.

0: Auto

The flash sync speed is set automatically within a range of 1/200 sec. to 30 sec. to suit the scene's brightness. With an external Speedlite, high-speed sync is also possible.

1: 1/200-1/60 sec. auto

Prevents a slow shutter speed from being set in low-light conditions. It is effective for preventing subject blur and camera shake. However, while the subject will be properly exposed with the flash, the background may come out dark.

2: 1/200 sec. (fixed)

The flash-sync speed is fixed to 1/200 sec. This more effectively prevents subject blur and camera shake than with setting 1. However, the background may come out darker than with setting 1.



When 1 or 2 is set, high-speed sync cannot be used with an external Speedlite.

C.Fn II: Image**C.Fn-4 Long exposure noise reduction****0: Off****1: Auto**

For 1 sec. or longer exposures, noise reduction is performed automatically if noise typical of long exposures is detected. This **[Auto]** setting is effective in most cases.

2: On

Noise reduction is performed for all exposures of 1 sec. or longer. The **[On]** setting may be effective for noise that cannot be detected or reduced with the **[Auto]** setting.



- With settings 1 and 2, after the picture is taken, the noise reduction process may take the same amount of time as the exposure. You cannot take another picture until the noise reduction process is completed.
- At ISO 1600 and higher, noise might be more pronounced with setting 2 than with setting 0 or 1.
- With setting 1 or 2, if a long exposure is shot with the Live View image displayed, **"BUSY"** will be displayed during the noise reduction process. The Live View display will not appear until the noise reduction is completed. (You cannot take another picture.)

C.Fn-5 High ISO speed noise reduction

Reduces the noise generated in the image. Although noise reduction is applied at all ISO speeds, it is particularly effective at high ISO speeds. At low ISO speeds, the noise in the shadow areas is further reduced. Change the setting to suit the noise level.

0: Standard

1: Low

2: Strong

3: Disable

-  ● With setting 2, the maximum burst for continuous shooting will greatly decrease.
- If you playback a **RAW** or **RAW + L** image with the camera or print an image directly, the effect of the high ISO speed noise reduction may look minimal. You can check the noise reduction effect or print noise-reduced images with Digital Photo Professional (provided software, p.302).

C.Fn-6 Highlight tone priority

0: Disable

1: Enable

Improves the highlight detail. The dynamic range is expanded from the standard 18% gray to bright highlights. The gradation between the grays and highlights becomes smoother.

-  ● With setting 1, the Auto Lighting Optimizer (p.109) is automatically set to **[Disable]** and the setting cannot be changed.
- With setting 1, noise may become slightly more pronounced than with setting 0.

-  With setting 1, the settable range will be ISO 200 - 6400. Also, the **<D+>** icon will be displayed on the LCD monitor and in the viewfinder when highlight tone priority is enabled.

C.Fn III: Autofocus/Drive

C.Fn-7 AF-assist beam firing

The AF-assist beam can be emitted by the camera's built-in flash or by an external, EOS-dedicated Speedlite.

0: Enable

If necessary, the AF-assist beam will be emitted by the built-in flash or external Speedlite.

1: Disable

The AF-assist beam is not emitted.

2: Enable external flash only

If an external Speedlite is attached, it will emit the AF-assist beam when necessary. The camera's built-in flash will not fire the AF-assist beam.

3: IR AF assist beam only

Among external Speedlites, only those which have an infrared AF-assist beam will be able to emit the beam. This prevents any Speedlite which uses a series of small flashes (like the built-in flash) from firing the AF-assist beam.

With an EX-series Speedlite equipped with a LED light, the LED light will not automatically turn on for AF-assist.



If the external Speedlite's **[AF-assist beam firing]** Custom Function is set to **[Disabled]**, the Speedlite will not emit the AF-assist beam even if the camera's C.Fn-7 is set to 0, 2, or 3.

C.Fn-8 Mirror lockup

0: Disable

1: Enable

Prevents mechanical vibrations in the camera caused by the reflex mirror action which can disturb shooting with super telephoto lenses or close-up (macro) shooting. See page 122 for the mirror lockup procedure.

C.Fn IV: Operation/Others

C.Fn-9 Shutter/AE lock button

0: AF/AE lock

1: AE lock/AF

Convenient when you want to focus and meter separately. Press the <★> button to autofocus, and press the shutter button halfway to apply AE lock.

2: AF/AF lock, no AE lock

In the AI Servo AF mode, you can press the <★> button to stop the AF operation momentarily. This prevents the AF from being thrown off by any obstacle passing between the camera and subject. The exposure is set at the moment the picture is taken.

3: AE/AF, no AE lock

This is useful for subjects which keep moving and stopping repeatedly. In the AI Servo AF mode, you can press the <★> button to start or stop the AI Servo AF operation. The exposure is set at the moment the picture is taken. Thus, the optimum focusing and exposure will always be achieved as you wait for the decisive moment.

C.Fn-10 Assign SET button

You can assign a frequently-used function to <SET>. Press <SET> when the camera is ready to shoot.

0: Normal (disabled)

1: Image quality

Press <SET> to display the image-recording quality setting screen on the LCD monitor. Select the desired image-recording quality, then press <SET>.

2: Flash exposure compensation

When you press <SET>, the flash exposure compensation setting screen will appear. Set the flash exposure compensation, then press <SET>.

3: LCD monitor On/Off

Assigns the same function as the <DISP.> button.

4: Menu display

Press <SET> to display the menu screen.

5: ISO speed

The ISO speed setting screen will appear. Press the <◀▶> key or turn the <ISO> dial to change the ISO speed. You can also refer to the viewfinder to set the ISO speed.

C.Fn-11 LCD display when power ON**0: Display on**

When the power switch is turned on, the shooting settings will be displayed (p.47).

1: Previous display status

If you pressed the <DISP.> button and turned off the camera while the LCD monitor was off, the shooting settings will not be displayed when you turn on the camera again. This helps to save battery power. The menu screens and image playback will still be displayed when used.

If you pressed the <DISP.> button to display the shooting settings and then turn off the camera, the shooting settings will be displayed when you turn on the camera again.

MENU Registering My Menu ☆

Under the My Menu tab, you can register up to six menu options and Custom Functions whose settings you change frequently.

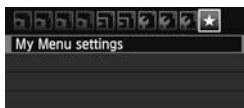

- 1 **Select [My Menu settings].**
 - Under the [★] tab, select [My Menu settings], then press <SET>.

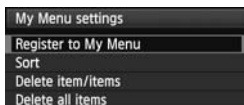

- 2 **Select [Register to My Menu].**
 - Select [Register to My Menu], then press <SET>.

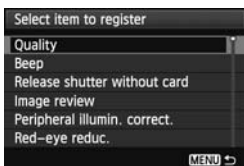

- 3 **Register the desired items.**
 - Select the item to be registered, then press <SET>.
 - On the confirmation dialog, select [OK] and press <SET> to register the item.
 - You can register up to six items.
 - To return to the screen in step 2, press the <MENU> button.

About My Menu settings

- **Sort**

You can change the order of the registered items in My Menu. Select [Sort] and select the item whose order you want to change. Then press <SET>. With [◆] displayed, press the <▲▼> key to change the order, then press <SET>.
- **Delete item/items and Delete all items**

You can delete any of the registered items. [Delete item/items] deletes one item at a time, and [Delete all items] deletes all items.
- **Display from My Menu**

When [Enable] is set, the [★] tab will be displayed first when you display the menu screen.

13

Reference

This chapter provides reference information for camera features, system accessories, etc.

Using a Household Power Outlet

With AC Adapter Kit ACK-E8 (sold separately), you can connect the camera to a household power outlet and not worry about the remaining battery level.

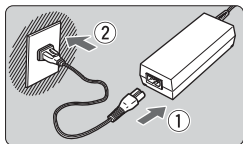

1 Connect the power cord.

- Connect the power cord as shown in the illustration.
- After using the camera, unplug the power plug from the power outlet.

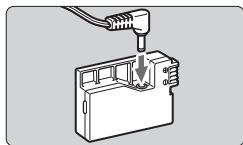

2 Connect the DC Coupler.

- Connect the cord's plug to the DC Coupler.

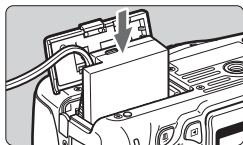

3 Insert the DC Coupler.

- Open the cover and insert the DC Coupler until it locks in place.

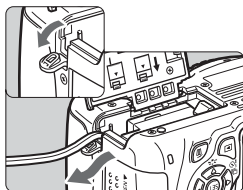

4 Push in the DC cord.

- Open the DC cord hole cover and install the cord as shown.
- Close the cover.

 Do not connect or disconnect the power cord while the camera's power switch is set to <ON>.

Remote Control Shooting

Remote Controller RC-6 (Sold separately)

This remote controller enables you to take pictures wirelessly up to about 5 meters/16.4 feet from the camera. You can either shoot immediately or use a 2-sec. delay.

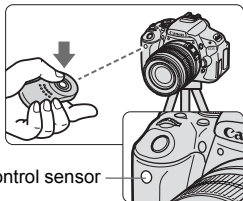

- Set the self-timer to $\langle \text{self-timer icon} \rangle$ (p.89).
- Point the remote controller toward the camera's remote control sensor and press the transmit button.
- ▶ The camera will autofocus.
- ▶ When focus is achieved, the self-timer lamp will light and the picture will be taken.



Camera misoperation may occur near certain types of fluorescent lights. During wireless remote control shooting, try to keep the camera away from fluorescent light sources.



- Remote Controller RC-1/RC-5 (sold separately) can also be used.
- The Remote Controller can also be used for shooting movies (p.159). Remote Controller RC-5 cannot be used to take still photos in the movie shooting mode.

Remote Switch RS-60E3 (Sold separately)

Remote Switch RS-60E3 (sold separately) comes with an approx. 60 cm/2.0 ft cord. When connected to the camera's remote control terminal, Remote Switch RS-60E3 can be used to press the shutter button halfway and completely.

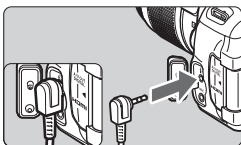

Using the Eyepiece Cover

When you use the self-timer, bulb, or Remote Switch and do not look through the viewfinder, stray light entering the viewfinder can cause the image to look dark. To prevent this, use the eyepiece cover (p.25) attached to the camera strap.

During Live View shooting and movie shooting, attaching the eyepiece cover is unnecessary.

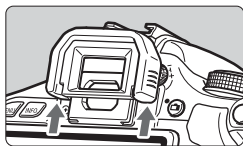

1 Remove the eyecup.

- Push the bottom of the eyecup to remove.

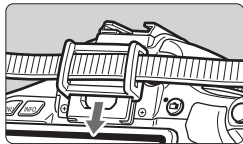

2 Attach the eyepiece cover.

- Slide the eyepiece cover down into the eyepiece groove to attach it.
- After taking the picture, detach the eyepiece cover and attach the eyecup by sliding it down the eyepiece groove.

External Speedlites

EOS-dedicated, EX-series Speedlites

Basically operates like a built-in flash for easy operation.

When an EX-series Speedlite (sold separately) is attached to the camera, almost all the autoflash control is done by the camera. In other words, it is like a high-output flash attached externally in place of the built-in flash.

For detailed instructions, see the EX-series Speedlite's instruction manual. This camera is a Type-A camera that can use all the features of EX-series Speedlites.





Shoe-mount Speedlites



Macro Lites



- With an EX-series Speedlite not compatible with flash function settings (p.181), only [ **exp. comp**] and [**E-TTL II meter.**] can be set for [**External flash func. setting**]. (Certain EX-series Speedlites also enable [**Shutter sync.**] to be set.)
- If flash exposure compensation is set with the external Speedlite, the flash exposure compensation icon displayed on the camera's LCD monitor will change from  to .
- If the Speedlite's Custom Function has the flash metering mode set to TTL autoflash, the flash will fire at full output only.

Canon Speedlites other than the EX-series

- **With an EZ/E/EG/ML/TL-series Speedlite set in TTL or A-TTL autoflash mode, the flash can be fired at full output only.** Set the camera's shooting mode to <M> (manual exposure) or <Av> (aperture-priority AE) and adjust the aperture setting before shooting.
- If you are using a Speedlite which has manual flash mode, shoot in the manual flash mode.

Using Non-Canon Flash Units

Sync Speed

The camera can synchronize with compact, non-Canon flash units at 1/200 sec. or slower shutter speeds. Use a sync speed slower than 1/200 sec.

Be sure to test the flash unit beforehand to make sure it synchronizes properly with the camera.

Cautions for Live View shooting

A non-Canon flash will not fire during Live View shooting.

- If the camera is used with a flash unit or flash accessory dedicated to another camera brand, the camera may not operate properly and malfunction may result.
- Do not attach a high-voltage flash unit on the camera's hot shoe. It might not fire.

Using Eye-Fi Cards

With a commercially-available Eye-Fi card already set up, you can automatically transfer captured images to a personal computer or upload them to an online service via a wireless LAN.

The image transfer is a function of the Eye-Fi card. For instructions on how to set up and use the Eye-Fi card or to troubleshoot any image transfer problems, refer to the Eye-Fi card's instruction manual or inquire the card's manufacturer.

⚠ The camera is not guaranteed to support Eye-Fi card functions (including wireless transfer). In case of an issue with an Eye-Fi card, please check with the card manufacturer. Also note that approval is required to use Eye-Fi cards in many countries or regions. Without approval, use of the card is not permitted. If it is unclear whether the card has been approved for use in your area, please check with the card manufacturer.

1 Insert an Eye-Fi card. (p.29)

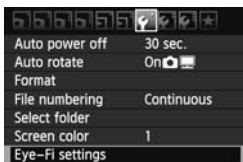

2 Select [Eye-Fi settings].

- Under the [**Eye-Fi**] tab, select [**Eye-Fi settings**], then press **<SET>**.
- This menu is displayed only when an Eye-Fi card has been inserted into the camera.



3 Enable the Eye-Fi transmission.

- Press **<SET>**, set [**Eye-Fi trans.**] to [**Enable**], then press **<SET>**.
- If you set [**Disable**], automatic transmission will not occur even with the Eye-Fi card inserted (Transmission status icon ).

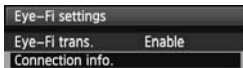

4 Display the connection information.

- Select [**Connection info.**], then press **<SET>**.



5 Check the [Access point SSID:].

- Check that an access point is displayed for [Access point SSID:].
- You can also check the Eye-Fi card's MAC address and firmware version.
- Press the <MENU> button three times to exit the menu.

6 Take the picture.

- ▶ The picture is transferred and the <Wi-Fi icon> switches from gray (Not connected) to one of the icons below.
- For transferred images, [Image icon] is displayed in the shooting information display (p.226).



Transmission status icon

- (Gray) **Not connected** : No connection with access point.
- (Blinking) **Connecting** : Connecting with access point.
- (Displayed) **Connected** : Connection to access point established.
- (↑) **Transferring** : Image transfer to access point in progress.

 **Cautions for Using Eye-Fi Cards**

- If “” is displayed, an error occurred while retrieving the card information. Turn the camera's power switch off and on again.
- Even if [**Eye-Fi trans.**] is set to [**Disable**], it may still transmit a signal. In hospitals, airports, and other places where wireless transmissions are prohibited, remove the Eye-Fi card from the camera.
- If the image transfer does not function, check the Eye-Fi card and personal computer settings. For details, see the card's instruction manual.
- Depending on the wireless LAN's connection conditions, the image transfer may take longer or it might be interrupted.
- Because of the transmission function, the Eye-Fi card may become hot.
- The battery power will be consumed faster.
- During the image transfer, auto power off will not take effect.

Function Availability Table According to Shooting Modes

● : Set automatically ○ : User selectable □ : Not selectable

Mode Dial		Basic Zone							Creative Zone					🗨️		
		A+ ⁺	📷	CA	🌀	🏠	🌿	🚫	📷	P	Tv	Av	M	A-DEP	🗨️	📷 ^{*1}
All recording quality settings selectable		○	○	○	○	○	○	○	○	○	○	○	○	○		○
ISO speed	Auto / ISO Auto	●	●	●	●	●	●	●	○	○	○	○	○		○	
	Manual								○	○	○	○	○		○ ^{*2}	
	Settable maximum ISO speed limit								○	○	○	○	○			
Picture Style	Automatic setting	📷	📷	📷	📷	📷	📷	📷								
	Manual selection								○	○	○	○	○		○	
Shoot by ambience selection				○	○	○	○	○								
Shoot by lighting or scene type					○	○	○	○								
White balance	Auto	●	●	●	●	●	●	●	○	○	○	○	○		○	
	Preset								○	○	○	○	○		○	
	Custom								○	○	○	○	○		○	
	Correction / Bracketing								○	○	○	○	○			
Auto Lighting Optimizer		●	●	●	●	●	●	●	○	○	○	○	○		○	
Lens peripheral illumination correction		○	○	○	○	○	○	○	○	○	○	○	○		○	
Long exposure noise reduction																
High ISO speed noise reduction		●	●	●	●	●	●	●	○	○	○	○	○			
Highlight tone priority									○	○	○	○	○		○	
Color space	sRGB	●	●	●	●	●	●	●	○	○	○	○	○			
	Adobe RGB								○	○	○	○	○			
Focusing	One-Shot AF				●	●	●		○	○	○	○	○		AF Live	
	AI Servo AF							●	○	○	○	○	○		AF	
	AI Focus AF	●	●	●					○	○	○	○	○		AFQuick ^{*3}	
	AF point selection	●	●	●	●	●	●	●	○	○	○	○	○		AFQuick	
	AF-assist beam	●		●	●		●	^{*4}	●	○	○	○	○			
	Manual (MF)	○	○	○	○	○	○	○	○	○	○	○	○		○	

*1 : The 📷 icon indicates still photo shooting in the movie shooting mode.

*2 : For manual exposures only.

*3 : If used during movie shooting, it will switch to <AF Live>.

*4 : If the AF mode is <AFQuick> during Live View shooting, the external Speedlite will emit the AF-assist beam when necessary.

Mode Dial		Basic Zone								Creative Zone					ⓘ	
		A ⁺	Ⓜ	CA	👤	🏠	🌿	🔪	📷	P	Tv	Av	M	A-DEP	📷	📷 ^{*1}
Metering mode	Evaluative	●	●	●	●	●	●	●	○	○	○	○	○			
	Metering mode selection								○	○	○	○	○			
Exposure	Program shift								○							
	Exposure compensation								○	○	○		○		○ ^{*6}	
	AEB								○	○	○	○	○			
	AE lock								○	○	○		○		○ ^{*6}	
	Depth-of-field preview								○	○	○	○	○			
Drive	Single shooting	○	○	○		○	○		○	○	○	○	○		●	
	Continuous shooting			○	○			○		○	○	○	○			
	🕒 (10 sec.)	○	○	○	○	○	○	○	○	○	○	○	○			
	🕒 (2 sec.)								○	○	○	○	○			
	🕒 (Continuous)	○	○	○	○	○	○	○	○	○	○	○	○			
Built-in flash	Fires automatically	●		○	●		●									
	Flash on			○					○	○	○	○	○			
	Flash off		●	○		●		●		○	○	○	○		●	
	Red-eye reduction	○		○	○		○		○	○	○	○	○			
	FE lock								○	○	○	○	○			
	Flash exposure compensation								○	○	○	○	○			
	Wireless control								○	○	○	○	○			
External flash	Function setting								○	○	○	○	○			
	Custom Function setting								○	○	○	○	○			
Live View shooting		○	○	○	○	○	○	○	○	○	○	○	○			
Aspect ratio ^{*5}									○	○	○	○	○			
Quick Control		○	○	○	○	○	○	○	○	○	○	○	○		○	
Feature guide		○	○	○	○	○	○	○	○	○	○	○	○		○	

*5 : Settable only for Live View shooting.

*6 : Settable only for auto exposures.

MENU Menu Settings

For Viewfinder Shooting and Live View Shooting

Shooting 1 (Red)

Page

Quality	L / L / M / M / S1 / S1 / S2 / S3 / RAW + L / RAW	76
Beep	Enable / Disable	166
Release shutter without card	Enable / Disable	166
Image review	Off / 2 sec. / 4 sec. / 8 sec. / Hold	166
Peripheral illumination correction	Enable / Disable	110
Red-eye reduction	Disable / Enable	91
Flash control	Flash firing / E-TTL II metering mode / Built-in flash function setting / External flash function setting / External flash C.Fn setting / Clear external flash C.Fn setting	180

Shooting 2 (Red)

Exposure compensation/AEB	1/3-stop or 1/2-stop increments, ± 5 stops (AEB: ± 2 stops)	105
Auto Lighting Optimizer	Disable / Low / Standard / Strong	109
Metering mode	Evaluative metering / Partial metering / Spot metering / Center-weighted average metering	102
Custom White Balance	Manual setting of white balance	117
WB Shift/BKT	WB correction: White balance correction	119
	BKT setting: White balance bracketing	120
Color space	sRGB / Adobe RGB	121
Picture Style	Auto / Standard / Portrait /	81
	Landscape / Neutral / Faithful /	112
	Monochrome / User Def. 1, 2, 3	115



- The Shooting 2, Shooting 3, Set-up 3, and My Menu screens (tabs) are not displayed in Basic Zone modes.
- The Shooting 4 tab is displayed in Basic Zone modes as the Shooting 2 tab.
- Shaded menu options are not displayed in Basic Zone modes.

Shooting 3 (Red)

Page

Dust Delete Data	Obtains data to be used to erase dust spots	185
ISO Auto	Max.: 400 / Max.: 800 / Max.: 1600 / Max.: 3200 / Max.: 6400	80







Shooting 4 (Red)

Live View shooting	Enable / Disable	125
AF mode	Live mode /  Live mode / Quick mode	131
Grid display	Off / Grid 1  / Grid 2 	129
Aspect ratio	3:2 / 4:3 / 16:9 / 1:1	129
Metering timer	4 sec. / 16 sec. / 30 sec. / 1 min. / 10 min. / 30 min.	130

Playback 1 (Blue)

Protect images	Select images / All images in folder / Unprotect all images in folder / All images on card / Unprotect all images on card	222
Rotate	Rotate vertical images	205
Erase images	Select and erase images / All images in folder / All images on card	224
Print order	Specify images to be printed (DPOF)	245
Creative filters	Grainy B/W / Soft focus / Fish-eye effect / Toy camera effect / Miniature effect	230
Resize	Downsize the image's pixel count	233

Playback 2 (Blue)

Histogram	Brightness / RGB	228
Image jump w/ 	1 image / 10 images / 100 images / Date / Folder / Movies / Stills / Rating	203
Slide show	Playback description / Display time / Repeat / Transition effect / Background music	215
Rating	[OFF] / [] / [] / [] / [] / []	206
Bass boost	Disable / Enable	213
Control over HDMI	Disable / Enable	219

🔧 Set-up 1 (Yellow)

Page

Auto power off	30 sec. / 1 min. / 2 min. / 4 min. / 8 min. / 15 min. / Off	167
Auto rotate	On / On / Off	174
Format	Initialize and erase data on the card	45
File numbering	Continuous / Auto reset / Manual reset	170
Select folder	Create and select a folder	168
Screen color	Select the shooting settings screen color	179
Eye-Fi settings*	Eye-Fi transmission: Disable / Enable Connection information	265

* Displayed only when an Eye-Fi card is used.

🔧 Set-up 2 (Yellow)

LCD brightness	Seven brightness levels provided	167
LCD off/on button	Shutter button / Shutter/DISP / Remains on	179
Date/Time	Set the date (year, month, day) and time (hour, min., sec.)	34
Language 	Select the interface language	35
Video system	NTSC / PAL	221
Sensor cleaning	Auto cleaning: Enable / Disable	184
	Clean now	
	Clean manually	187
Feature guide	Enable / Disable	48

🔧 Set-up 3 (Yellow)

Custom Functions (C.Fn)	Customize camera functions as desired	250
Copyright information	Display copyright information / Enter author's name / Enter copyright details / Delete copyright information	172
Clear settings	Clear all camera settings / Clear all Custom Func. (C.Fn)	176
Firmware Ver.	For updating the firmware	-





★ My Menu (Green)

My Menu settings	Register frequently-used menu items and Custom Functions	258
-------------------------	--	-----









For Movie Shooting

Movie 1 (Red)

Page









Movie exposure	Auto / Manual	157
AF mode	Live mode /  Live mode / Quick mode	157
AF with shutter button during 	Disable / Enable	157
 Shutter/AE lock button	AF/AE lock / AE lock/AF / AF/AF lock, no AE lock / AE/AF, no AE lock	158
Remote control	Disable / Enable	159
 Highlight tone priority	Disable / Enable	159

Movie 2 (Red)











Movie recording size	Movie recording size: 1920x1080 ( /  / ) / 1280x720 ( / ) / 640x480 ( / )	150
	Digital zoom: OFF / 3x - 10x	152
Sound recording	Sound recording: Auto / Manual / Disable Recording level Wind filter: Disable / Enable	160
Metering timer	4 sec. / 16 sec. / 30 sec. / 1 min. / 10 min. / 30 min.	161
Grid display	Off / Grid 1  / Grid 2 	161
Video snapshot	Disable / 2 sec. movie / 4 sec. movie / 8 sec. movie	153

 **Movie 3 (Red)**

Page

Exposure compensation	1/3-stop increments, ±5 stops	162
Auto Lighting Optimizer	Disable / Low / Standard / Strong	162
Custom White Balance	Manual setting of white balance	162
Picture Style	 Auto /  Standard /  Portrait /  Landscape /  Neutral /  Faithful /  Monochrome /  User Def. 1, 2, 3	162

 **Shooting 1 (Red)**

Quality	 L /  L+ /  M /  M+ /  S1 /  S1+ /  S2 /  S3 /  RAW+ /  RAW	76
Beep	Enable / Disable	166
Release shutter without card	Enable / Disable	166
Image review	Off / 2 sec. / 4 sec. / 8 sec. / Hold	166
Peripheral illumination correction	Enable / Disable	110

 **Playback 1 (Blue)**



Protect images	Select images / All images in folder / Unprotect all images in folder / All images on card / Unprotect all images on card	222
Rotate	Rotate vertical images	205
Erase images	Select and erase images / All images in folder / All images on card	224
Print order	Specify images to be printed (DPOF)	245
Creative filters	Grainy B/W / Soft focus / Fish-eye effect / Toy camera effect / Miniature effect	230
Resize	Downsize the image's pixel count	233

Playback 2 (Blue)

Page

Histogram	Brightness / RGB	228
Image jump w/ 	1 image / 10 images / 100 images / Date / Folder / Movies / Stills / Rating	203
Slide show	Playback description / Display time / Repeat / Transition effect / Background music	215
Rating	[OFF] / [★] / [★★] / [★★★] / [★★★★] / [★★★★★]	206
Bass boost	Disable / Enable	213
Control over HDMI	Disable / Enable	219

Set-up 1 (Yellow)



Auto power off	30 sec. / 1 min. / 2 min. / 4 min. / 8 min. / 15 min. / Off	167
Auto rotate	On   / On  / Off	174
Format	Initialize and erase data on the card	45
File numbering	Continuous / Auto reset / Manual reset	170
Select folder	Create and select a folder	168
Eye-Fi settings*	Eye-Fi transmission: Disable / Enable Connection information	265

* Displayed only when an Eye-Fi card is used.

Set-up 2 (Yellow)

LCD brightness	Seven brightness levels provided	167
Date/Time	Set the date (year, month, day) and time (hour, min., sec.)	34
Language 	Select the interface language	35
Video system	NTSC / PAL	221
Feature guide	Enable / Disable	48



- The menu tabs and options displayed will differ for viewfinder shooting, Live View shooting, and movie shooting.
- The  Movie 1,  Movie 2, and  Movie 3 screens (tabs) are displayed only in the movie shooting mode.

System Map

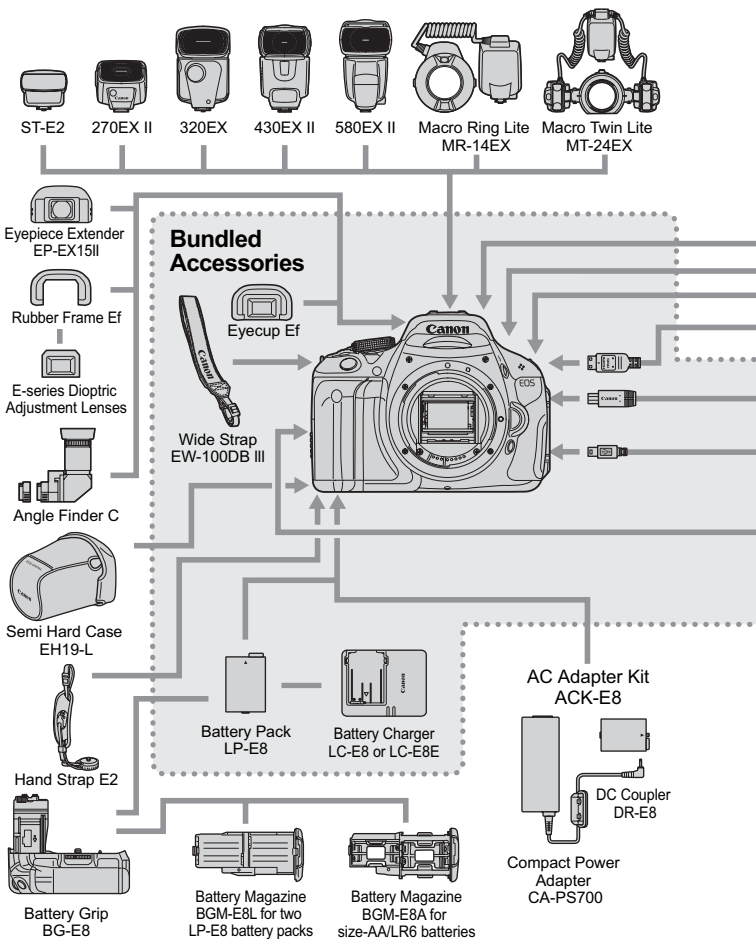

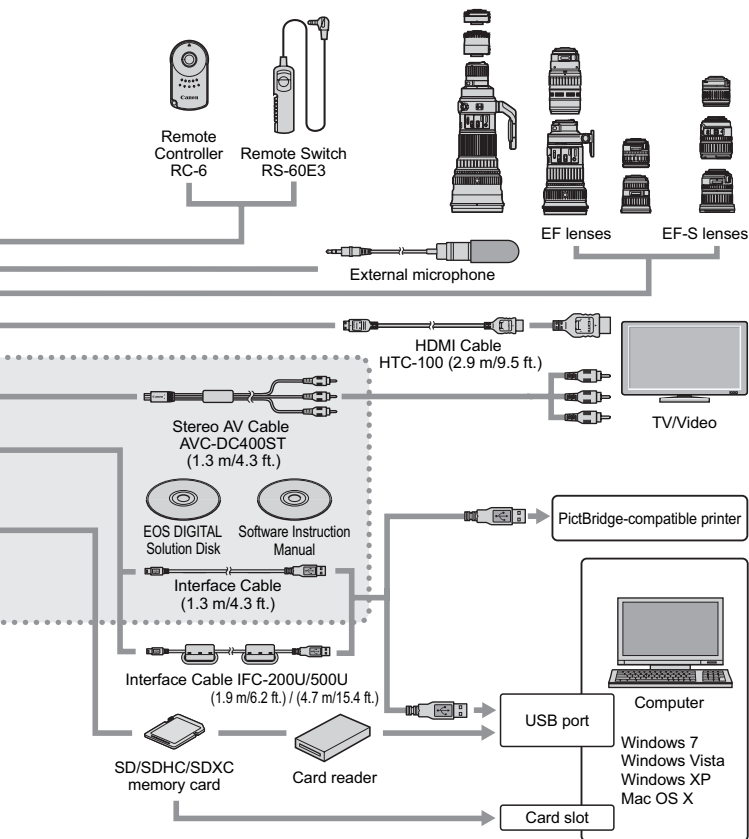

* The length of all cables is approx. **m/**ft

Troubleshooting Guide

If a problem occurs with the camera, first refer to this Troubleshooting Guide. If this Troubleshooting Guide does not resolve the problem, contact your dealer or nearest Canon Service Center.

Power-Related Problems

The battery pack does not recharge.

- Do not recharge any battery pack other than a genuine Canon Battery Pack LP-E8.

The battery charger's lamp blinks.

- If there is a problem with the battery charger, the protective circuit will stop the charging operation and the charge lamp will blink in orange. If this happens, disconnect the charger's power plug from the power outlet and remove the battery pack. Attach the battery pack to the charger again and wait a while before connecting the charger to a power outlet again.

The camera does not operate even when the power switch is set to <ON>.

- The battery is not properly installed in the camera (p.28).
- Make sure the battery compartment cover is closed (p.28).
- Make sure the card slot cover is closed (p.29).
- Recharge the battery (p.26).
- Press the <DISP.> button (p.47).



The access lamp still blinks even when the power switch is set to <OFF>.

- If the power is turned off while an image is being recorded to the card, the access lamp will still continue to light/blink for a few seconds. When the image recording is completed, the power will turn off automatically.

The battery becomes exhausted quickly.

- Use a fully-charged battery pack (p.26).
- The rechargeable battery pack performance will degrade over repeated use. Purchase a new one.
- If you use Live View shooting or shoot movies for a prolonged period (p.123, 141), the number of possible shots will decrease.
- If you hold down the shutter button for a long time or often use only the AF without taking pictures, the number of possible shots will decrease.
- If you often use the LCD monitor, the number of possible shots will decrease.
- If you use the lens Image Stabilizer, the number of possible shots will decrease.

The camera turns off by itself.

- Auto power off is in effect. If you do not want auto power off to take effect, set [ **Auto power off**] to [**Off**] (p.167).
- Even if [ **Auto power off**] has been set to [**Off**], the LCD monitor will still turn off after the camera is idle for 30 min. Press the <DISP.> button to turn on the LCD monitor.

Shooting-Related Problems

No images can be shot nor recorded.

- The card is not properly inserted (p.29).
- If the card is full, replace the card or delete unnecessary images to make room (p.29, 224).
- If you try to focus in the One-Shot AF mode while the focus confirmation light <●> in the viewfinder blinks, a picture cannot be taken. Press the shutter button halfway again to focus, or focus manually (p.40, 87).
- Slide the card's write-protect switch to the Write/Erase setting (p.29).

The card cannot be used.

- If a card error message is displayed, see page 30 or 287.

The file numbering does not start from 0001.

- If the card already contains recorded images, the image number might not start from 0001 (p.170).

The image is out of focus.

- Set the lens focus mode switch to **<AF>** (p.36).
- To prevent camera shake, press the shutter button gently (p.39, 40).
- If the lens has an Image Stabilizer, set the IS switch to **<ON>**.
- In low light, the shutter speed may become slow. Use a faster shutter speed (p.94), set a higher ISO speed (p.79), use flash (p.90), or use a tripod.

Horizontal stripes appear, or the exposure or color tone look strange.

- Horizontal stripes or irregular exposures can be caused by fluorescent light, LED bulbs, or other artificial lighting during viewfinder or Live View shooting. Also, the exposure or color tone might not come out right. A slow shutter speed may solve the problem.

The maximum burst during continuous shooting is lower.

- Under [**F**: **Custom Functions (C.Fn)**], set [**5: High ISO speed noise reduction**] to [**Standard**], [**Low**], or [**Disable**]. If it is set to [**Strong**], the maximum burst during continuous shooting will greatly decrease (p.254).
- If you shoot something that has fine detail (field of grass, etc.), the file size will be larger and the actual maximum burst might be lower than the number mentioned on page 76.

ISO 100 cannot be set.

- Under [**F**: **Custom Functions (C.Fn)**], if [**6: Highlight tone priority**] is set to [**1: Enable**], ISO 100 cannot be set. If [**0: Disable**] is set, ISO 100 can be set (p.254). This also applies to movie shooting (p.159).

The Auto Lighting Optimizer cannot be set.

- Under [**F**: **Custom Functions (C.Fn)**], if [**6: Highlight tone priority**] is set to [**1: Enable**], the Auto Lighting Optimizer cannot be set. If [**0: Disable**] is set, the Auto Lighting Optimizer can be set (p.254). This also applies to movie shooting (p.162).

ISO speed [H] (ISO 12800) cannot be set.

- Under [**F**: **Custom Functions (C.Fn)**], if [**6: Highlight tone priority**] is set to [**1: Enable**], the [**H**] ISO speed cannot be selected even when [**2: ISO expansion**] has been set to [**1: Enable**]. If [**0: Disable**] is set, [**H**] can be set (p.252).

When I use the <Av> mode with flash, the shutter speed becomes slow.

- If you shoot at night when the background is dark, the shutter speed becomes slow automatically (slow-sync shooting) so that both the subject and background are properly exposed. If you do not want a slow shutter speed to be set, set [3: Flash sync. speed in Av mode] in [Fn: Custom Functions (C.Fn)] to 1 or 2 (p.252).

The built-in flash pops up by itself.

- In the [A+], [M], [S], and [B] modes, the built-in flash will pop-up automatically when flash is necessary.

The built-in flash does not fire.

- If you shoot continuously with the built-in flash at short intervals, the flash might stop operating to protect the flash unit.

I cannot set flash exposure compensation with [External flash func. setting].

- If flash exposure compensation has been set on an external Speedlite, [Flash exp. comp] (p.182) cannot be set in the [External flash func. setting] screen. Also, if you set flash exposure compensation with the camera and then set flash exposure compensation with the external Speedlite, the Speedlite's flash exposure compensation setting will override the camera's. When the Speedlite's flash exposure compensation is canceled (set to 0), flash exposure compensation can be set with the camera.

High-speed sync cannot be set in the <Av> mode.

- Under [Fn: Custom Functions (C.Fn)], set [3: Flash sync. speed in Av mode] to [0: Auto] (p.252).

The camera makes a noise when it is shaken.

- The built-in flash's pop-up mechanism moves slightly. This is normal.

The shutter makes two shooting sounds during Live View shooting.

- If you use flash, the shutter will make two sounds each time you shoot (p.125).

During Live View and movie shooting, a white or red <H> icon is displayed.

- It indicates that the camera's internal temperature is high. If the white icon is displayed, the still photo's image quality might deteriorate. If the red <H> icon is displayed, it indicates that the Live View or movie shooting will soon be terminated automatically (p.139, 163).

Movie shooting terminates by itself.

- If the card's writing speed is slow, movie shooting may stop automatically. Use an SD Speed Class 6 "CLASS 6" or faster card. To find out the card's read/write speed, see the card manufacturer's Web site, etc.
- The movie shooting will be terminated automatically if the file size reaches 4 GB or if the movie length reaches 29 min. 59 sec.

The image flickers or horizontal stripes appear during movie shooting.

- Flickering, horizontal stripes (noise), or irregular exposures can be caused by fluorescent light, LED bulbs, or other artificial lighting during movie shooting. Also, changes in the exposure (brightness) or color tone might also be recorded. With manual exposures, a slow shutter speed may solve the problem.

Playback Problems

The LCD monitor does not display a clear image.

- If the LCD monitor is dirty, use a soft cloth to clean it.
- In low or high temperatures, the LCD monitor display may seem slow or might look black. It will return to normal at room temperature.

Part of the image blinks in black.

- It is the highlight alert (p.228). Overexposed highlight areas with a loss of highlight detail will blink.

The image cannot be erased.

- If the image has been protected, it cannot be erased (p.222).

The movie cannot play.

- Movies edited with a personal computer using the provided ZoomBrowser EX/ImageBrowser (p.302) or other software cannot be played with the camera. However, video snapshot albums edited with ZoomBrowser EX/ImageBrowser can be played on the camera.

When the movie is played, camera operation noise can be heard.

- If you operate the camera's dials or lens during movie shooting, the operation noise will also be recorded. Use an external microphone (commercially available) (p.160).

The movie has still moments.

- During autoexposure movie shooting, if there is a drastic change in the exposure level, the recording will stop momentarily until the brightness stabilizes. If this happens, use manual exposure (p.144).

The subject looks distorted during movie shooting.

- If you move the camera to the left or right quickly (high-speed panning) or shoot a moving subject, the image may look distorted.

No image appears on the TV screen.

- Make sure the AV cable or HDMI cable's plug is inserted all the way in (p.218, 221).
- Set the video OUT system (NTSC/PAL) to the same video system as the TV set (p.221).

My card reader does not recognize the card.

- Depending on the card reader and computer OS used, SDXC cards might not be correctly recognized. In such a case, connect your camera to the computer with the provided interface cable, then transfer the images to your computer using EOS Utility (provided software, p.302).

Display Problems**The menu screen shows few tabs and options.**

- In Basic Zone modes and in movie shooting mode, certain tabs and menu options are not displayed. Set the shooting mode to a Creative Zone mode (p.43).

The file name's first character is an underscore (“_MG_”).

- Set the color space to sRGB. If Adobe RGB is set, the first character will be an underscore (p.121).

The file name starts with “MVI_”.

- It is a movie file (p.171).

The shooting date and time displayed is incorrect.

- The correct date and time has not been set (p.34).

The date and time is not in the picture.

- The shooting date and time does not appear in the picture. The date and time is instead recorded in the image data as shooting information. When printing, you can imprint the date and time in the picture by using the date and time recorded in the shooting information (p.241).

[###] is displayed.

- If the card has recorded a number of images greater than the camera can display, [###] will be displayed (p.207).

[Eye-Fi settings] does not appear.

- **[Eye-Fi settings]** will appear only when an Eye-Fi card is inserted into the camera. If the Eye-Fi card has a write-protect tab set to the LOCK position, you will not be able to check the card's connection status or disable Eye-Fi card transmission (p.265).

Printing-Related Problems

There are fewer printing effects than listed in the instruction manual.

- What is displayed on the screen differs depending on the printer. This instruction manual lists all the printing effects available (p.240).

Error Codes

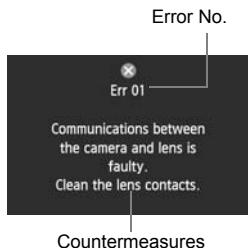

If there is a problem with the camera, an error message will appear. Follow the on-screen instructions.

No.	Error Message & Solution
01	<p>Communications between the camera and lens is faulty. Clean the lens contacts.</p> <p>→ Clean the electrical contacts on the camera and lens and use a Canon lens (p.15, 18).</p>
02	<p>Card cannot be accessed. Reinsert/change card or format card with camera.</p> <p>→ Remove and insert the card again, replace the card, or format the card (p.29, 45).</p>
04	<p>Cannot save images because card is full. Replace card.</p> <p>→ Replace the card, erase unnecessary images, or format the card (p.29, 224, 45).</p>
05	<p>The built-in flash could not be raised. Turn the camera off and on again.</p> <p>→ Operate the power switch (p.32).</p>
06	<p>Sensor cleaning is not possible. Turn the camera off and on again.</p> <p>→ Operate the power switch (p.32).</p>
10, 20, 30, 40, 50, 60, 70, 80	<p>Shooting is not possible due to an error. Turn the camera off and on again or re-install the battery.</p> <p>→ Operate the power switch, remove and install the battery pack again, or use a Canon lens (p.32, 28).</p>

* If the error still persists, write down the error No. and contact your nearest Canon Service Center.

Specifications

• Type

Type:	Digital, single-lens reflex, AF/AE camera with built-in flash
Recording media:	SD memory card, SDHC memory card, SDXC memory card
Image sensor size:	Approx. 22.3 x 14.9 mm
Compatible lenses:	Canon EF lenses (including EF-S lenses) (35mm-equivalent focal length is approx. 1.6 times the lens focal length)
Lens mount:	Canon EF mount

• Image Sensor

Type:	CMOS sensor
Effective pixels:	Approx. 18.00 megapixels
Aspect ratio:	3:2
Dust delete feature:	Auto, Manual, Dust Delete Data appending

• Recording System

Recording format:	Design rule for Camera File System 2.0
Image type:	JPEG, RAW (14-bit Canon original) RAW+JPEG Large simultaneous recording possible
Recorded pixels:	L (Large) : Approx. 17.90 megapixels (5184 x 3456) M (Medium) : Approx. 8.00 megapixels (3456 x 2304) S1 (Small 1) : Approx. 4.50 megapixels (2592 x 1728) S2 (Small 2) : Approx. 2.50 megapixels (1920 x 1280) S3 (Small 3) : Approx. 350,000 pixels (720 x 480) RAW : Approx. 17.90 megapixels (5184 x 3456)

• Image Processing During Shooting

Picture Style:	Auto, Standard, Portrait, Landscape, Neutral, Faithful, Monochrome, User Def. 1 - 3
Basic+:	Shoot by ambient selection, Shoot by lighting or scene type
White balance:	Auto, Preset (Daylight, Shade, Cloudy, Tungsten light, White fluorescent light, Flash), Custom White balance correction and white balance bracketing features provided * Flash color temperature information communication provided
Noise reduction:	Applicable to long exposures and high ISO speed shots
Automatic image brightness correction:	Auto Lighting Optimizer
Highlight tone priority:	Provided
Lens peripheral illumination correction:	Provided

• Viewfinder

Type:	Eye-level pentamirror
Coverage:	Vertical/Horizontal approx. 95% (with Eye point approx. 19 mm)
Magnification:	Approx. 0.85x (-1 m ⁻¹ with 50mm lens at infinity)
Eye point:	Approx. 19 mm (From eyepiece lens center at -1 m ⁻¹)
Built-in dioptic adjustment:	Approx. -3.0 - +1.0 m ⁻¹ (dpt)
Focusing screen:	Fixed, Precision Matte
Mirror:	Quick-return type
Depth-of-field preview:	Provided

• Autofocus

Type:	TTL secondary image-registration, phase detection
AF points:	9 AF points
Metering range:	EV -0.5 - 18 (at 23°C/73°F, ISO 100)
Focus modes:	One-Shot AF, AI Servo AF, AI Focus AF, Manual focusing (MF)
AF-assist beam:	Small series of flashes fired by built-in flash

• Exposure Control

Metering modes:	63-zone TTL full-aperture metering <ul style="list-style-type: none"> • Evaluative metering (linked to all AF points) • Partial metering (approx. 9% of viewfinder at center) • Spot metering (approx. 4% of viewfinder at center) • Center-weighted average metering
Metering range:	EV 1 - 20 (at 23°C/73°F with EF50mm f/1.4 USM lens, ISO 100)
Exposure control:	Program AE (Scene Intelligent Auto, Flash Off, Creative Auto, Portrait, Landscape, Close-up, Sports, Night Portrait, Program), shutter-priority AE, aperture-priority AE, manual exposure, automatic depth-of-field AE
ISO speed: (Recommended exposure index)	Basic Zone modes: ISO 100 - 3200 set automatically Creative Zone modes : ISO 100 - 6400 set manually (whole-stop increments), ISO 100 - 6400 set automatically, maximum ISO speed settable for ISO Auto, or ISO expansion to "H" (equivalent to ISO 12800)
Exposure compensation:	Manual: ±5 stops in 1/3- or 1/2-stop increments AEB: ±2 stops in 1/3- or 1/2-stop increments (Can be combined with manual exposure compensation)
AE lock:	Auto: Applied in One-Shot AF mode with evaluative metering when focus is achieved Manual: By AE lock button

• Shutter

Type:	Electronically-controlled, focal-plane shutter
Shutter speeds:	1/4000 sec. to 1/60 sec. (Scene Intelligent Auto mode), X-sync at 1/200 sec. 1/4000 sec. to 30 sec., bulb (Total shutter speed range. Available range varies by shooting mode.)

• Flash

Built-in flash:	Retractable, auto pop-up flash Guide No.: Approx. 13/43 (ISO 100, in meters/feet) Flash coverage: Approx. 17mm lens angle of view Recycling time approx. 3 sec. Wireless master unit function provided
External flash:	EX-series Speedlite (Flash functions settable with the camera)
Flash metering:	E-TTL II autoflash
Flash exposure compensation:	±2 stops in 1/3- or 1/2-stop increments
FE lock:	Provided
PC terminal:	None

• Drive System

Drive mode:	Single shooting, continuous shooting, self-timer with 10-sec. or 2-sec. delay and 10-sec. delay with continuous shooting
Continuous shooting speed:	Max. approx. 3.7 shots/sec.
Max. burst:	JPEG Large/Fine: Approx. 34 shots RAW: Approx. 6 shots RAW+JPEG Large/Fine: Approx. 3 shots * Figures are based on Canon's testing standards (ISO 100 and "Standard" Picture Style) using a 4GB card.

• Live View Shooting

Aspect ratio settings:	3:2, 4:3, 16:9, 1:1
Focusing:	Live mode, Face detection Live mode (Contrast detection), Quick mode (Phase-difference detection) Manual focusing (Approx. 5x / 10x magnification possible)
Metering modes:	Evaluative metering with the image sensor
Metering range:	EV 0 - 20 (at 23°C/73°F with EF50mm f/1.4 USM lens, ISO 100)
Grid display:	Two types

• Movie Shooting

Movie compression:	MPEG-4 AVC/H.264 Variable (average) bit rate
Audio recording format:	Linear PCM
Recording format:	MOV
Recording size and frame rate:	1920x1080 (Full HD) : 30p/25p/24p 1280x720 (HD) : 60p/50p 640x480 (SD) : 30p/25p * 30p: 29.97 fps, 25p: 25.00 fps, 24p: 23.976 fps, 60p: 59.94 fps, 50p: 50.00 fps
File size:	1920x1080 (30p/25p/24p) : Approx. 330 MB/min. 1280x720 (60p/50p) : Approx. 330 MB/min. 640x480 (30p/25p) : Approx. 82.5 MB/min.
Focusing:	Same as focusing with Live View shooting
Metering modes:	Center-weighted average and evaluative metering with the image sensor * Automatically set by the focusing mode
Metering range:	EV 0 - 20 (at 23°C/73°F with EF50mm f/1.4 USM lens, ISO 100)
Exposure control:	Program AE for movies and manual exposure
Exposure compensation:	±3 stops in 1/3-stop increments (Still photos: ±5 stops)
ISO speed: (Recommended exposure index)	With autoexposure shooting: Automatically set within ISO 100 - 6400 With manual exposure, ISO 100 - 6400 set automatically/ manually
Digital zoom:	Approx. 3x - 10x
Video snapshots:	Settable to 2 sec./4 sec./8 sec.
Sound recording:	Built-in monaural microphone External stereo microphone terminal provided Sound recording level adjustable, wind filter provided
Grid display:	Two types

• LCD Monitor

Type:	TFT color liquid-crystal monitor
Monitor size and dots:	Wide, 3.0-in. (3:2) with approx. 1.04 million dots
Angle adjustment:	Possible
Brightness adjustment:	Manual (7 levels)
Interface languages:	25
Feature guide:	Displayable

• Playback

Image display formats: Single image, Single image + Info (Basic info, shooting info, histogram), 4-image index, 9-image index, image rotate possible

Zoom magnification: Approx. 1.5x - 10x

Image browsing methods: Single image, jump by 10 or 100 images, by shooting date, by folder, by movies, by stills, by rating

Highlight alert: Overexposed highlights blink

Movie playback: Enabled (LCD monitor, video/audio OUT, HDMI OUT)
Built-in speaker

Slide show: All images, by date, by folder, movies, stills, or by rating
Five transition effects selectable

Background music: Selectable for slide shows and movie playback

Bass boost: Provided

• Post-Processing of Images

Creative filters: Grainy B/W, Soft focus, Fish-eye effect, Toy camera effect, Miniature effect

Resize: Possible

• Direct Printing

Compatible printers: PictBridge-compatible printers

Printable images: JPEG and RAW images

Print ordering: DPOF Version 1.1 compatible

• Custom Functions

Custom Functions: 11

My Menu registration: Possible

Copyright information: Entry and inclusion possible

• Interface

Audio/video OUT/

Digital terminal: Analog video (Compatible with NTSC/PAL)/stereo audio output
For personal computer communication and direct printing
(Hi-Speed USB equivalent)

HDMI mini OUT terminal: Type C (Auto switching of resolution), CEC-compatible

External microphone

IN terminal: 3.5mm dia. stereo mini-jack

Remote control terminal: For Remote Switch RS-60E3

Wireless remote control: Remote Controller RC-6

Eye-Fi card: Compatible

• Power

Battery:	Battery Pack LP-E8 (Quantity 1) * AC power can be supplied via AC Adapter Kit ACK-E8 * With Battery Grip BG-E8 attached, size-AA/LR6 batteries can be used
Battery life: (Based on CIPA testing standards)	With viewfinder shooting: Approx. 440 shots at 23°C/73°F, approx. 400 shots at 0°C/32°F With Live View shooting: Approx. 180 shots at 23°C/73°F, approx. 150 shots at 0°C/32°F
Movie shooting time	Approx. 1 hr. 40 min. at 23°C/73°F Approx. 1 hr. 20 min. at 0°C/32°F (With a fully-charged Battery Pack LP-E8)

• Dimensions and Weight

Dimensions (W x H x D):	Approx. 133.1 x 99.5 x 79.7 mm / 5.2 x 3.9 x 3.1 in.
Weight:	Approx. 570 g / 20.1 oz. (CIPA Guidelines), Approx. 515 g / 18.2 oz. (Body only)

• Operation Environment

Working temperature range:	0°C - 40°C / 32°F - 104°F
Working humidity:	85% or less

• Battery Pack LP-E8

Type:	Rechargeable lithium-ion battery
Rated voltage:	7.2 V DC
Battery capacity:	1120 mAh
Working temperature range:	During charging: 6°C - 40°C / 43°F - 104°F During shooting: 0°C - 40°C / 32°F - 104°F
Working humidity:	85% or less
Dimensions (W x H x D):	Approx. 37.1 x 15.4 x 55.2 mm / 1.5 x 0.6 x 2.2 in.
Weight:	Approx. 52 g / 1.8 oz.

• Battery Charger LC-E8

Compatible battery:	Battery Pack LP-E8
Recharging time:	Approx. 2 hours (at 23°C/73°F)
Rated input:	100 - 240 V AC (50/60 Hz)
Rated output:	8.4 V DC / 720 mA
Working temperature range:	6°C - 40°C / 43°F - 104°F
Working humidity:	85% or less
Dimensions (W x H x D):	Approx. 69 x 28 x 87.5 mm / 2.7 x 1.1 x 3.4 in.
Weight:	Approx. 82 g / 2.9 oz.

• **Battery Charger LC-E8E**

Compatible battery:	Battery Pack LP-E8
Recharging time:	Approx. 2 hours (at 23°C/73°F)
Rated input:	100 - 240 V AC (50/60 Hz)
Rated output:	8.4 V DC / 720 mA
Working temperature range:	6°C - 40°C / 43°F - 104°F
Working humidity:	85% or less
Dimensions (W x H x D):	Approx. 69 x 28 x 87.5 mm / 2.7 x 1.1 x 3.4 in.
Weight:	Approx. 82 g / 2.9 oz.

• **EF-S18-55mm f/3.5-5.6 IS II**

Angle of view:	Diagonal extent: 74°20' - 27°50' Horizontal extent: 64°30' - 23°20' Vertical extent: 45°30' - 15°40'
Lens construction:	11 elements in 9 groups
Minimum aperture:	f/22 - 36
Closest focusing distance:	0.25 m / 0.82 ft. (From image sensor plane)
Max. magnification:	0.34x (at 55 mm)
Field of view:	207 x 134 - 67 x 45 mm / 8.1 x 5.3 - 2.6 x 1.8 in. (at 0.25 m / 0.82 ft.)
Image Stabilizer:	Lens shift type
Filter size:	58 mm
Lens cap:	E-58
Max. diameter x length:	Approx. 68.5 x 70 mm / 2.7 x 2.8 in.
Weight:	Approx. 200 g / 7.1 oz.
Hood:	EW-60C (sold separately)
Case:	LP814 (sold separately)

• **EF-S18-55mm f/3.5-5.6 IS III**

Angle of view:	Diagonal extent: 74°20' - 27°50' Horizontal extent: 64°30' - 23°20' Vertical extent: 45°30' - 15°40'
Lens construction:	11 elements in 9 groups
Minimum aperture:	f/22 - 36
Closest focusing distance:	0.25 m / 0.82 ft. (From image sensor plane)
Max. magnification:	0.34x (at 55mm)
Field of view:	207 x 134 - 67 x 45 mm / 8.1 x 5.3 - 2.6 x 1.8 in. (at 0.25 m / 0.82 ft.)
Filter size:	58 mm
Lens cap:	E-58
Max. diameter x length:	Approx. 68.5 x 70.0 mm / 2.7 x 2.8 in.

Weight:	Approx. 195 g / 6.9 oz.
Hood:	EW-60C (sold separately)
Case:	LP814 (sold separately)

• EF-S18-135mm f/3.5-5.6 IS

Angle of view:	Diagonal extent: 74°20' - 11°30' Horizontal extent: 64°30' - 9°30' Vertical extent: 45°30' - 6°20'
Lens construction:	16 elements in 12 groups
Minimum aperture:	f/22 - 36
Closest focusing distance*:	At 18mm focal length: 0.49 m / 1.61 ft. (327 x 503 mm / 12.9 x 19.8 in. field of view) At 135mm focal length: 0.45 m / 1.48 ft. (75 x 112 mm / 3.0 x 4.4 in. field of view) * Distance from image sensor plane
Max. magnification:	0.21x (at 135mm)
Image Stabilizer:	Lens shift type
Filter size:	67 mm
Lens cap:	E-67U
Max. diameter x length:	Approx. 75.4 x 101 mm / 3.0 x 4.0 in.
Weight:	Approx. 455 g / 16.0 oz.
Hood:	EW-73B (sold separately)
Case:	LP1116 (sold separately)

- All the data above is based on Canon's testing standards and CIPA (Camera & Imaging Products Association) testing standards and guidelines.
- Dimensions, maximum diameter, length and weight listed above are based on CIPA Guidelines (except weight for camera body only).
- Product specifications and the exterior are subject to change without notice.
- If a problem occurs with a non-Canon lens attached to the camera, consult the respective lens maker.

Trademarks

- Adobe is a trademark of Adobe Systems Incorporated.
- Windows is a trademark or registered trademark of Microsoft Corporation in the United States and other countries.
- Macintosh and Mac OS are trademarks or registered trademarks of Apple Inc. in the United States and other countries.
- SDXC logo is a trademark of SD-3C, LLC.
- HDMI, HDMI logo, and High-Definition Multimedia Interface are a trademark or registered trademark of HDMI Licensing LLC.
- All other corporate and product names and trademarks mentioned in this manual are the property of their respective owners.

About MPEG-4 Licensing

"This product is licensed under AT&T patents for the MPEG-4 standard and may be used for encoding MPEG-4 compliant video and/or decoding MPEG-4 compliant video that was encoded only (1) for a personal and non-commercial purpose or (2) by a video provider licensed under the AT&T patents to provide MPEG-4 compliant video. No license is granted or implied for any other use for MPEG-4 standard."

* Notice displayed in English as required.

Use of genuine Canon accessories is recommended

This product is designed to achieve excellent performance when used with genuine Canon accessories. Canon shall not be liable for any damage to this product and/or accidents such as fire, etc., caused by the malfunction of non-genuine Canon accessories (e.g., a leakage and/or explosion of a battery pack). Please note that this warranty does not apply to repairs arising out of the malfunction of non-genuine Canon accessories, although you may request such repairs on a chargeable basis.

Safety Warnings

Follow these safeguards and use the equipment properly to prevent injury, death, and material damage.

Preventing Serious Injury or Death

- To prevent fire, excessive heat, chemical leakage, and explosions, follow the safeguards below:
 - Do not use any batteries, power sources, and accessories not specified in this booklet. Do not use any home-made or modified batteries.
 - Do not short-circuit, disassemble, or modify the battery pack or back-up battery. Do not apply heat or apply solder to the battery pack or back-up battery. Do not expose the battery pack or back-up battery to fire or water. And do not subject the battery pack or back-up battery to strong physical shock.
 - Do not install the battery pack or back-up battery in reversed polarity (+ -). Do not mix new and old or different types of batteries.
 - Do not recharge the battery pack outside the allowable ambient temperature range of 0°C - 40°C (32°F - 104°F). Also, do not exceed the recharging time.
 - Do not insert any foreign metallic objects into the electrical contacts of the camera, accessories, connecting cables, etc.
- Keep the back-up battery away from children. If a child swallows the battery, consult a physician immediately. (Battery chemicals may harm the stomach and intestines.)
- When disposing of a battery pack or back-up battery, insulate the electrical contacts with tape to prevent contact with other metallic objects or batteries. This is to prevent fire or an explosion.
- If excessive heat, smoke, or fumes are emitted during battery pack recharging, immediately unplug the battery charger from the power outlet to stop the recharging and prevent a fire.
- If the battery pack or back-up battery leaks, changes color, deforms, or emits smoke or fumes, remove it immediately. Be careful not to get burned in the process.
- Prevent any battery leakage from contacting your eyes, skin, and clothing. It can cause blindness or skin problems. If the battery leakage contacts your eyes, skin, or clothing, flush the affected area with lots of clean water without rubbing it. See a physician immediately.
- During the recharging, keep the equipment away from the reach of children. The cord can accidentally choke the child or give an electrical shock.
- Do not leave any cords near a heat source. It can deform the cord or melt the insulation and cause a fire or electrical shock.
- Do not fire the flash at someone driving a car. It may cause an accident.
- Do not fire the flash near a person's eyes. It may impair the person's vision. When using flash to photograph an infant, keep at least 1 meter away.
- Before storing the camera or accessory when not in use, remove the battery pack and disconnect the power plug. This is to prevent electrical shock, heat generation, and fire.
- Do not use the equipment where there is flammable gas. This is to prevent an explosion or fire.

-
- If you drop the equipment and the casing breaks open to expose the internal parts, do not touch the internal parts due to the possibility of electrical shock.
 - Do not disassemble or modify the equipment. High-voltage internal parts can cause electrical shock.
 - Do not look at the sun or an extremely bright light source through the camera or lens. Doing so may damage your vision.
 - Keep the camera from the reach of small children. The neck strap can accidentally choke the child.
 - Do not store the equipment in dusty or humid places. This is to prevent fire and electrical shock.
 - Before using the camera inside an airplane or hospital, check if it is allowed. Electromagnetic waves emitted by the camera may interfere with the plane's instruments or the hospital's medical equipment.
 - To prevent fire and electrical shock, follow the safeguards below:
 - Always insert the power plug all the way in.
 - Do not handle a power plug with wet hands.
 - When unplugging a power plug, grasp and pull the plug instead of the cord.
 - Do not scratch, cut, or excessively bend the cord or put a heavy object on the cord. Also do not twist or tie the cords.
 - Do not connect too many power plugs to the same power outlet.
 - Do not use a cord whose insulation has been damaged.
 - Occasionally unplug the power plug and use a dry cloth to clean off the dust around the power outlet. If the surrounding is dusty, humid, or oily, the dust on the power outlet may become moist and short-circuit the outlet to cause a fire.
-

Preventing Injury or Equipment Damage

- Do not leave equipment inside a car under the hot sun or near a heat source. The equipment may become hot and cause skin burns.
 - Do not carry the camera around while it is attached to a tripod. Doing so may cause injury. Also make sure the tripod is sturdy enough to support the camera and lens.
 - Do not leave a lens or lens-attached camera under the sun without the lens cap attached. Otherwise, the lens may concentrate the sun's rays and cause a fire.
 - Do not cover or wrap the battery-recharging apparatus with a cloth. Doing so may trap heat within and cause the casing to deform or catch fire.
 - If you drop the camera in water or if water or metal fragments enter inside the camera, promptly remove the battery pack and back-up battery. This is to prevent fire and electrical shock.
 - Do not use or leave the battery pack or back-up battery in a hot environment. Doing so may cause battery leakage or a shorter battery life. The battery pack or back-up battery can also become hot and cause skin burns.
 - Do not use paint thinner, benzene, or other organic solvents to clean the equipment. Doing so may cause fire or a health hazard.
-

If the product does not work properly or requires repair, contact your dealer or your nearest Canon Service Center.

14

Software Start Guide

This chapter gives an overview of the software in the EOS DIGITAL Solution Disk (CD-ROM) provided with the camera and explains how to install the software in a personal computer. It also explains how to view the pdf files in the Software Instruction Manual CD-ROM.



EOS DIGITAL Solution Disk
(Software)



Software Instruction Manual

Software Start Guide



EOS DIGITAL Solution Disk

This disk contains various software for EOS DIGITAL cameras.

EOS Utility

With the camera connected to a personal computer, EOS Utility enables you to transfer still photos and movies shot with the camera to the computer. You can also use the personal computer to set various camera settings and shoot remotely with the computer connected to the camera. Also, you can copy background music tracks, such as EOS Sample Music*, to the card.

- * Five original background music tracks provided by Canon. Use EOS Utility to copy the background music tracks to the card, and you can play the background music during playback of video snapshot albums, movies, and slide shows with the camera.

Digital Photo Professional

This software is recommended for users who mainly shoot RAW images. You can view, edit, process, and print RAW images at high speed. You can also edit JPEG images while retaining the original images.

ZoomBrowser EX (Win) / ImageBrowser (Mac)

This software is recommended for users who mainly shoot JPEG images. You can easily view, edit, organize, and print JPEG images. You can also play and edit movies (MOV files) and video snapshot albums and extract still photos from movies.

Picture Style Editor

You can edit Picture Styles and create and save original Picture Style files. This software is aimed at advanced users who are experienced in processing images.

Installing the Software

- Do not connect the camera to your computer before you install the software. The software will not be installed correctly.
- Even if a previous version of the software is installed, install the software by following the steps below (the newer version will overwrite the previous version).

1 Insert EOS DIGITAL Solution Disk (CD-ROM).

- For Macintosh, double-click to open the CD-ROM icon displayed on the desktop, then double-click on **[Canon EOS Digital Installer]**.

2 Click **[Easy Installation]** and follow the on-screen instructions to install.

- For Macintosh, click **[Install]**.



3 Click **[Restart]** and remove the CD-ROM after the computer restarts.

- When the computer has restarted, the installation is complete.



Software Instruction Manual

Contains the Software Instruction Manuals.

Copying and Viewing the Instruction Manual PDFs







- 1** Insert the [Software INSTRUCTION MANUAL] CD-ROM into your computer.
- 2** Double-click the CD-ROM icon.
 - For Windows, the icon is displayed in [(My) Computer].
 - For Macintosh, the icon is displayed on the desktop.
- 3** Copy the [English] folder to your computer.
 - Instruction Manual PDFs with the names below are copied.

	Windows	Macintosh
EOS Utility	EUx.xW_E_xx	EUx.xM_E_xx
Digital Photo Professional	DPPx.xW_E_xx	DPPx.xM_E_xx
ZoomBrowser EX / ImageBrowser	ZBx.xW_E_xx	IBx.xM_E_xx
Picture Style Editor	PSEx.xW_E_xx	PSEx.xM_E_xx

- 4** Double-click the copied PDF file.
 - Adobe Reader (Version 6.0 or later) must be installed in your computer.
 - Adobe Reader can be downloaded free from the Internet.

15

Quick Reference Guide and Instruction Manual Index

Menu Operations - - - - -	p.306
Image-recording Quality - - - - -	p.307
 Picture Style- - - - -	p.307
 Quick Control Screen - - - - -	p.308
Nomenclature - - - - -	p.309
Basic Zone Modes - - - - -	p.311
 Using the Built-in Flash- - - - -	p.311
Creative Zone Modes - - - - -	p.312
P : Program AE - - - - -	p.312
Tv : Shutter-priority AE - - - - -	p.312
Av : Aperture-priority AE- - - - -	p.312
AF: AF Mode- - - - -	p.313
 AF Point - - - - -	p.313
ISO: ISO Speed - - - - -	p.314
 Drive Mode - - - - -	p.314
 Live View Shooting- - - - -	p.315
 Shooting Movies - - - - -	p.316
Image Playback- - - - -	p.317

Quick Reference Guide

Menu Operations

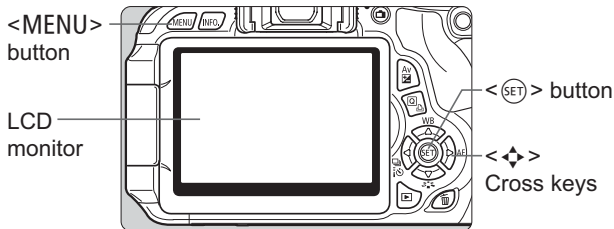

1. Press the <MENU> button to display the menu.
2. Press the <◀▶> key to select a tab, then press the <▲▼> key to select the desired item.
3. Press <SET> to display the setting.
4. After setting the item, press <SET>.

Basic Zone Modes



Movie Shooting Mode



Creative Zone Modes

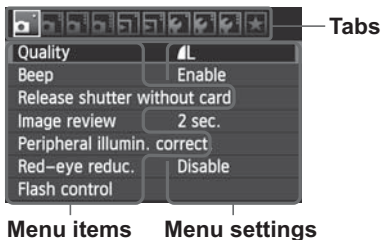
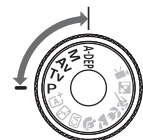
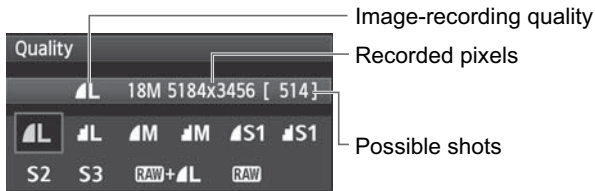

Image-recording Quality

- Select [**Q** Quality], then press <SET>.
- Press the <◀▶> key to select the quality, then press <SET>.



Picture Style ☆



- Press the <Picture Style icon> button.
- Press the <◀▶> key to select the Picture Style, then press <SET>.

Style	Description
Auto	Color tones optimized for the particular scene.
Standard	Vivid colors and sharp images.
Portrait	Nice skin tones and slightly sharp images.
Landscape	Vivid blue skies and greenery and very sharp images.
Monochrome	Black-and-white images.

- For <Neutral icon> (Neutral) and <Faithful icon> (Faithful), see page 82.

Q Quick Control



- Press the <Q> button.
- ▶ The Quick Control screen will appear.

Basic Zone Modes

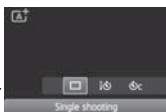

Creative Zone Modes

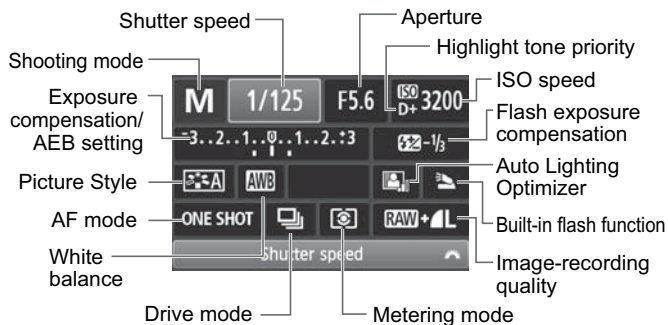
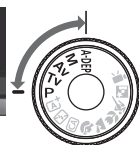

- In Basic Zone modes, the settable functions differ depending on the shooting mode.
- Press the <Q> key to select a function, then turn the <Q> dial to set it.

Nomenclature

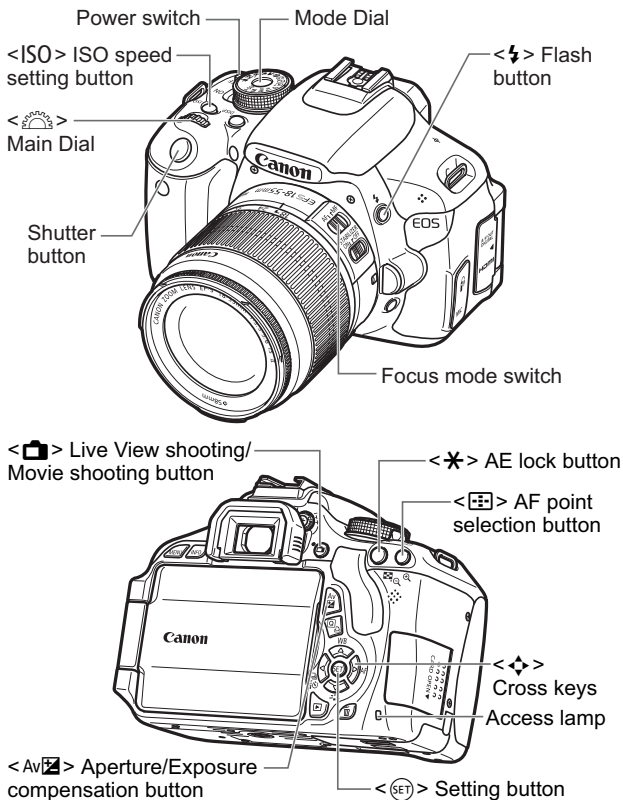

Shooting Settings Display

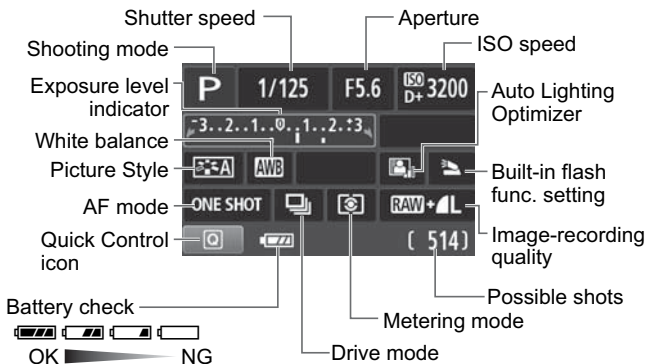

Viewfinder Information

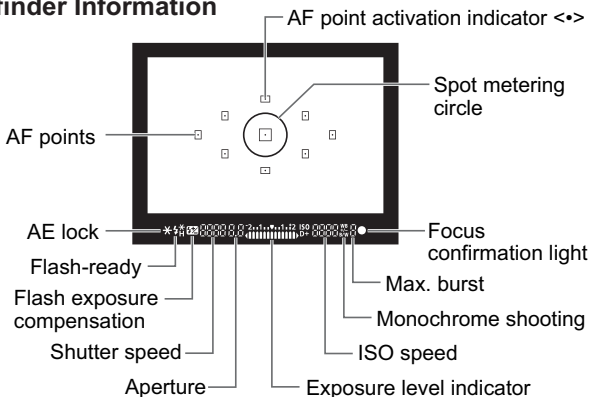

Basic Zone Modes



All the settings necessary for shooting are set automatically. You just press the shutter button, and the camera does the rest.

Scene Intelligent Auto

Flash Off

Creative Auto

Portrait

Landscape

Close-up

Sports

Night Portrait

- Pressing the button will display the Quick Control screen. In the ///// shooting mode, press the key to select the function, then press the key or turn the dial to set it as desired.

Using the Built-in Flash

Basic Zone Modes

If necessary, the built-in flash will pop-up automatically in low-light or backlit conditions (except in the modes).

Creative Zone Modes

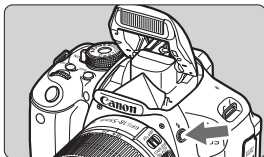

- Press the button to raise the built-in flash, then shoot.

Creative Zone Modes



You can change the camera settings as desired to shoot in various ways.

P: Program AE

The camera automatically sets the shutter speed and aperture in the same way as the <A+> mode.

- Set the Mode Dial to <P>.

Tv: Shutter-priority AE



- Set the Mode Dial to <Tv>.
- Turn the <Shutter Speed> dial to set the desired shutter speed, then focus the subject.
- ▶ The aperture will be set automatically.
- If the aperture display blinks, turn the <Aperture> dial until it stops blinking.

Av: Aperture-priority AE



- Set the Mode Dial to <Av>.
- Turn the <Aperture> dial to set the desired aperture, then focus the subject.
- ▶ The shutter speed will be set automatically.
- If the shutter speed display blinks, turn the <Shutter Speed> dial until it stops blinking.

AF: AF Mode ☆

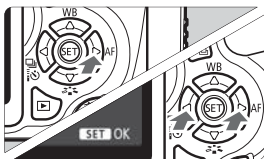

- Set the lens focus mode switch to <AF>.
- Press the <▶ AF> button.
- Press the <◀▶> key or turn the <☀> dial to select the AF mode, then press <SET>.

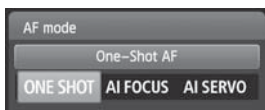

ONE SHOT (One-Shot AF):

For still subjects

AI FOCUS (AI Focus AF):

Switches the AF mode automatically

AI SERVO (AI Servo AF):

For moving subjects

AF Point ☆

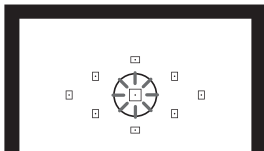
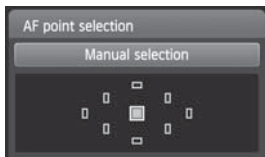

- Press the <☒> button.
- Press the <◀◆> key to select the AF point.
- While looking through the viewfinder, you can select the AF point by turning the <☀> dial until the desired AF point flashes in red.
- Pressing <SET> toggles the AF point selection between the center AF point and automatic AF point selection.

ISO: ISO Speed ☆

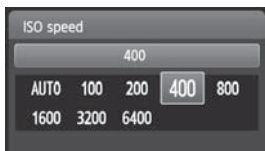
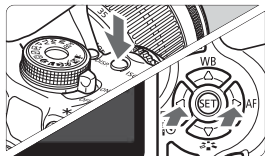

- Press the <ISO> button.
- Press the <◀▶> key or turn the <⚙> dial to select the ISO speed, then press <SET>.
- When [AUTO] is selected, the ISO speed is set automatically. When you press the shutter button halfway, the ISO speed setting will be displayed.

Drive Mode ☆

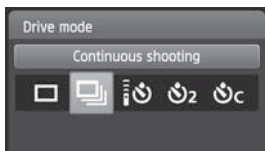
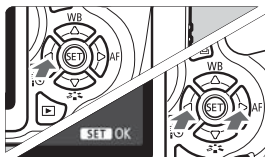

- Press the <◀[Drive Mode]▶> button.
- Press the <◀▶> key or turn the <⚙> dial to select the drive mode, then press <SET>.

□ : **Single shooting**

☰ : **Continuous shooting**

⏱ : **Self-timer:10 sec/Remote control***

⏱₂ : **Self-timer:2 sec**

⏱_C : **Self-timer:Continuous***

* The <⏱> and <⏱_C> drive modes can be selected in all shooting modes (except <[Movie]>).

Live View Shooting





- Press the  button to display the Live View image.

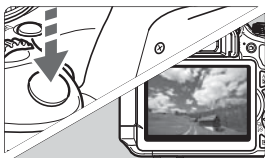

- Press the shutter button halfway to focus.



- Press the shutter button completely to take the picture.

- Live View shooting settings will appear under the  menu tab in Basic Zone modes and under the  menu tab in Creative Zone modes.
- **Battery Life with Live View Shooting**

Temperature	No Flash	50% Flash Use
At 23°C / 73°F	Approx. 200 shots	Approx. 180 shots

Shooting Movies





- Set the Mode Dial to <  >.



- Press the shutter button halfway to focus.



- Press the <  > button to start shooting a movie.
- To stop movie shooting, press the <  > button again.

Recording movie

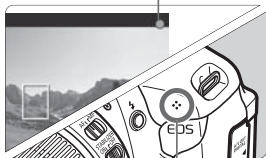

Microphone

Image Playback

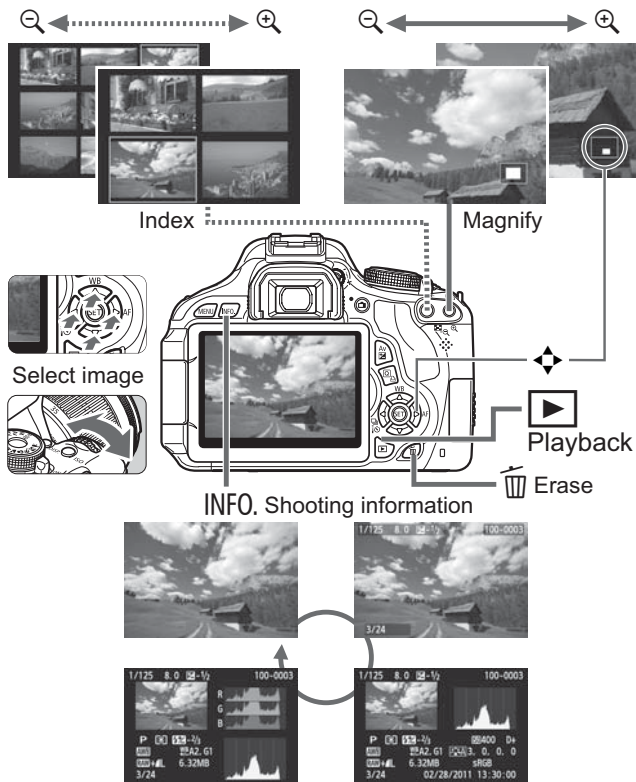

Index

10-sec. or 2-sec. delay	89
1280x720	150
1920x1080	150
1st-curtain sync.....	182
2nd-curtain sync	182
4- or 9-image index display.....	202
640x480	150
9-point AF auto selection	85

A

AC Adapter Kit	260
Access lamp	30
Accessories	3
A-DEP (Automatic Depth-of-Field AE).....	101
Adobe RGB.....	121
AE lock.....	107
AEB.....	105, 252
AF (Focusing)	83, 85
AF point	85
AI FOCUS (AI Focus AF).....	84
AI SERVO (AI Servo AF)	84
AI Servo AF	53, 84
Aperture-priority AE	96
Aspect ratio.....	234
Audio/video OUT	210, 221
Auto Lighting Optimizer	49, 109
Auto playback	215
Auto power off.....	32, 167
Auto reset	171
Auto rotate of vertical images	174
Autofocus.....	83, 85
Automatic selection of AF point	85
Av (Aperture-priority AE).....	96
A/V OUT	210, 221

B

B/W (Monochrome).....	82, 114
-----------------------	---------

Background music.....	217
Basic Zone modes	22
Bass boost	213
Battery	26, 28, 33
Battery check	33
Battery Grip	33, 276
Beeper.....	166
Black-and-white image.....	65, 82, 114
Bracketing	105, 120
Brightness (exposure)	103
Adjust (exposure compensation)	103
Auto exposure bracketing (AEB)	105, 252
Autoexposure lock (AE lock)....	107
Measurement method (Metering mode)	102
Built-in flash.....	90
BULB (Bulb exposure)	100

C

 (Creative Auto).....	56
Cable.....	3, 218, 221, 236, 277
Camera	
Camera shake	122
Clear camera settings.....	176
Holding the camera.....	39
Settings display.....	175
Camera shake.....	38, 39
Card	15, 29, 45
Card reminder.....	166
Eye-Fi	265
Format	45
Problem	30, 46
SD speed class.....	141
SDHC/SDXC.....	29
Write-protect	29
Center-weighted average metering	102
Charger	24, 26

- Cleaning (Image sensor)..... 184, 187
 Clear camera settings 176
 Close-ups 61
 Color space
 (color reproduction range)..... 121
 Color temperature 117
 Color tone 113
 Continuous 170
 Continuous shooting 88
 Contrast 113
 Copyright information 172
 Creative Auto 56
 Creative filters 230
 ☆ icon 4
 Creative Zone modes 22
 Custom Functions 250
 Custom WB 117
- D**
- Date/Time 34
 DC coupler 260
 Depth-of-field preview 98
 Dial 18, 93
 Digital terminal 221, 236
 Dioptic adjustment 39
 Direct printing 235
 DPOF 245
 Drive mode 20, 58, 88
 Dust Delete Data 185
- E**
- Erase (image) 224
 Error codes 287
 Evaluative metering 102
 Exposure compensation 103
 Exposure level increments 252
 Extension 171
 External Speedlite 263
- Eyecup 262
 Eye-Fi card 265
 Eyepiece cover 25, 262
- F**
- Faithful 82
 FE lock 108
 Feature guide 48
 FEB 181
 File name 170
 File size 76, 151, 226
 Filter effect 114, 230
 Final image simulation 127, 147
 Fine (Image-recording quality) 76
 Firmware Ver. 272
 Fish-eye effect 232
- Flash
- Built-in flash 90
 - Custom Functions 183
 - Effective range 90
 - External Speedlite 263
 - FE lock 108
 - Flash control 180
 - Flash exposure compensation 104
 - Flash off 55, 58, 64
 - Flash-sync speed 252, 264
 - Manual flash 182, 199
 - Red-eye reduction 91
 - Shutter sync.
 - (1st/2nd curtain) 182
 - Wireless 189
- Flash exposure compensation 104
 Flash mode 182
 Flash-sync contacts 18
 Focus confirmation light 50
 Focus lock 53
 Focus mode switch 36, 87, 138

Focusing	
AF mode.....	83
AF point selection.....	85
AF-assist beam	86, 255
Beeper.....	166
Difficult-to-focus subjects....	87, 135
Manual focusing	87, 138
Out of focus	38, 39, 87, 135
Recompose	53
Folder Create/Select.....	168
Format	45
Format (card initialization)	45
Frame rate	150
Full Auto (Scene Intelligent Auto) ...	50
Full High-Definition	
(Full HD)	150, 210
Function availability table.....	268

G

Grainy B/W	232
Grid display.....	129, 161

H

HDMI.....	210, 218
HDMI CEC	219
High ISO speed noise reduction ...	254
High-Definition (HD).....	150, 210
Highlight alert.....	228
Highlight tone priority	159, 254
Histogram (Brightness/RGB)	228
Hot shoe	263
Household power	260

I

ICC profile	121
Image	
Auto playback	215
Auto rotate	174
Erase	224
Highlight alert.....	228
Histogram	228
Image characteristics	
(Picture Style)	81, 112, 115
Index	202
Jump display	
(Image browsing).....	203
Magnified view	204
Manual rotate	205
No.	170
Playback	71, 201
Protect	222
Review time	166
Shooting information	226
Transfer.....	265
View on TV	210, 218
Image area	37
Image dust prevention..	184, 185, 187
Image review time	166
Image Stabilizer (lens).....	38
Image Zone	22
Image-recording quality.....	76
Index display	202
ISO speed	
Auto	80
ISO expansion	252
Maximum ISO speed with	
ISO Auto	80

J

JPEG.....	76
Jump display	203

- L**
- Landscape 60, 82
 - Language selection 35
 - Large (Image-recording quality) 76
 - LCD monitor 15
 - Brightness adjustment 167
 - Image playback 71, 201
 - Menu screen 43, 270
 - Screen color 179
 - Shooting settings display 20, 47
 - Vari-Angle 31, 54
 - Lens 23, 36
 - Image Stabilizer 38
 - Lock release 37
 - Peripheral illumination correction 110
 - Live View shooting 54, 123
 - Aspect ratio 129
 - Face detection Live mode (AF) 132
 - Grid display 129
 - Information display 126
 - Live mode (AF) 131
 - Manual focusing 87, 138
 - Metering timer 130
 - Possible shots 125
 - Quick Control 128
 - Quick mode (AF) 136
 - Long exposure noise reduction 253
 - Long exposures 100
 - Low-level format 46
- M**
- M (Manual exposure) 99
 - Macro photography 61
 - Magnified view 138, 204
 - Malfunction 278
 - Manual exposure 99, 144
 - Manual focus (MF) 87, 138
 - Manual reset 171
 - Manual selection (AF) 85
 - Maximum burst 76, 77
 - Medium (Image-recording quality) 76, 234
 - Memory card 15, 29, 45
 - Menu 43
 - My Menu 258
 - Setting procedure 44
 - Settings 270
 - MENU** icon 4
 - Metering mode 102
 - Metering timer 130, 161
 - MF (Manual focusing) 87, 138
 - Microphone 142
 - Miniature effect 232
 - Mirror lockup 122, 255
 - Mode Dial 22
 - Monochrome 65, 82, 114
 - Movie 141
 - AF mode 149, 157
 - Autoexposure 142
 - Editing out first and last scenes 214
 - Enjoying 210
 - File size 151
 - Frame rate 150
 - Grid display 161
 - Information display 146
 - Manual exposure 144
 - Manual focusing 142
 - Metering timer 161
 - Movie digital zoom 152
 - Movie recording size 150
 - Playback 212
 - Quick Control 149
 - Recording time 151
 - Sound recording 160
 - Still photo shooting 148
 - Video snapshots 153
 - Video snapshots album 153
 - View on TV 210, 218

My Menu 258

N

Neutral 82

Night Portrait 63

Night scene 60, 63

No 170

Noise reduction

High ISO speed 254

Long exposures 253

Nomenclature 18

Non-Canon flash units 264

Normal (Image-recording quality) ... 76

NTSC 150, 272

O

ONE SHOT (One-Shot AF) 83

P

P (Program AE) 74

PAL 150, 272

Paper settings (printing) 238

Partial metering 102

Peripheral illumination

correction 110

Personal white balance 118

PictBridge 235

Picture Style 81, 112, 115

Pixels 76

Playback 71, 201

Portrait 59, 81

Possible shots 33, 76, 125

Power

Auto power off 167

Battery check 33

Household power 260

Possible shots 33, 76, 125

Recharge 26

Predictive (AI Servo) 84

Pressing completely 40

Pressing halfway 40

Printing 235

Layout 239

Paper settings 238

Print Order (DPOF) 245

Printing effects 240

Tilt correction 243

Trimming 243

Program AE 74

Program shift 75

Protect (image erase-protection) .. 222

Q

 (Quick Control) 41, 64, 208

Quick mode (AF) 136

R

Rating 206

Rating mark 206

RAW 76, 78

RAW+JPEG 76, 78

Recharge 26

Red-eye reduction 91

Release shutter without card 166

Remote control shooting 261

Remote switch 262

Resize 233

Revert to default settings 176

Rotate (image) 174, 205, 243

S

Safety warnings 297

Saturation 113

SD card 29, 45









SDHC and SDXC cards 29, 45

Self-timer 64, 89

Sensor cleaning 184, 187

Sepia (Monochrome) 65, 114

Sharpness 113

Shoot by ambience selection	65
Shoot by lighting or scene type	68
Shooting information display	226
Shooting mode	22
A-DEP (Automatic Depth-of-Field AE) ..	101
Av (Aperture-priority AE)	96
M (Manual exposure)	99
P (Program AE)	74
Tv (Shutter-priority AE)	94
 (Scene Intelligent Auto)	50
 (Flash Off)	55
 (Creative Auto)	56
 (Portrait)	59
 (Landscape)	60
 (Close-up)	61
 (Sports)	62
 (Night Portrait)	63
 (Movie shooting)	141
Shooting settings display	20, 47
Shutter button	40
Shutter sync	182
Shutter-priority AE	94
Single image display	71
Single shooting	58, 269
Single-point AF	85
Slide show	215
Small (Image-recording quality)	76, 234
Soft focus	232
Software	3, 301
Speaker	212
Sports	62
Spot metering	102
sRGB	121
Stopped-down aperture	98
Strap	25
System map	276

T

Temperature warning	139, 163
Tone priority	159, 254
Toning effect (Monochrome)	114
Toy camera effect	232
Trimming (printing)	243
Tripod socket	19
Tv (Shutter-priority AE)	94

U

USB (Digital) terminal	236
------------------------------	-----

V

Vari-Angle LCD monitor	31, 54
Video snapshot	153
Video snapshot album	153
Video system	150, 221, 272
View on TV	210, 218
Viewfinder	21
Dioptric adjustment	39
Volume (Movie playback)	213

W

WB (White balance)	117
White balance	117
Bracketing	120
Correction	119
Custom	117
Personal	118
Wind filter	161
Wireless flash shooting	189
Custom wireless shooting	194
Easy wireless shooting	191



CANON INC. 30-2, Shimomaruko 3-chome, Ohta-ku, Tokyo 146-8501, Japan

U.S.A. ————— **CANON U.S.A. INC.**

One Canon Plaza, Lake Success, NY 11042-1198, U.S.A.
For all inquiries concerning this product, call toll free in the U.S.
1-800-OK-CANON

CANADA ————— **CANON CANADA INC. HEADQUARTERS**

6390 Dixie Road, Mississauga, Ontario L5T 1P7, Canada

CANON CANADA INC. MONTREAL BRANCH

5990, Côte-de-Liesse, Montréal Québec H4T 1V7, Canada

CANON CANADA INC. CALGARY OFFICE

2828, 16th Street, N.E. Calgary, Alberta T2E 7K7, Canada

For all inquiries concerning this product, call toll free in Canada

1-800-OK-CANON

EUROPE, ————— **CANON EUROPA N.V.**

AFRICA &

Bovenkerkerweg 59-61, 1185 XB Amstelveen, The Netherlands

MIDDLE EAST

CANON FRANCE S.A.S.

17, Quai du Président Paul Doumer, 92414 Courbevoie Cedex, France

CANON UK LTD.

Woodhatch Reigate, Surrey RH2 8BF, United Kingdom

CANON DEUTSCHLAND GmbH

Europark Fichtenhain A10, 47807 Krefeld, Germany

CANON ITALIA S.p.A.

Via Milano 8, 20097 San Donato Milanese, (MI), Italy

CANON Schweiz A.G.

Industriestrasse 12, 8305 Dietlikon, Switzerland

Canon GmbH

Zetschegasse 11, A-1230 Vienna, Austria

CANON España, S.A.

Av. De Europa, 6 Alcobendas 28108 Madrid, Spain

CANON Portugal S.A.

Rua Alfredo da Silva, 14 Alfragide 2610-016 Amadora, Portugal

CENTRAL & ————— **CANON LATIN AMERICA, INC.**

SOUTH AMERICA

703 Waterford Way, Suite 400 Miami, FL 33126, U.S.A.

ASIA ————— **CANON (China) Co., LTD.**

15F Jinbao Building No.89 Jinbao Street, Dongcheng District, Beijing 100005, China

CANON HONGKONG CO., LTD.

19/F., The Metropolis Tower, 10 Metropolis Drive, Hunghom, Kowloon, Hong Kong

CANON SINGAPORE PTE. LTD.

1 HarbourFront Avenue, #04-01 Keppel Bay Tower, Singapore 098632

CANON KOREA CONSUMER IMAGING INC.

Gangnam Finance Center 17F, 737, Yeoksam-Dong, Gangnam-Gu, Seoul, 135-984, Korea

OCEANIA ————— **CANON AUSTRALIA PTY. LTD.**

1 Thomas Holt Drive, North Ryde, Sydney N.S.W. 2113, Australia

CANON NEW ZEALAND LTD.

Akoranga Business Park, Akoranga Drive, Northcote, Auckland, New Zealand

JAPAN ————— **CANON MARKETING JAPAN INC.**

16-6, Kohnan 2-chome, Minato-ku, Tokyo 108-8011, Japan

This Instruction Manual booklet is current as of January 2011. For information on the camera's compatibility with any accessories and lenses introduced after this date, contact any Canon Service Center.