

Canon

DVD Camcorder
Instruction Manual **English**

Caméscope DVD
Manuel d'instruction **Français**

Cámara DVD
Manual de Instrucciones **Español**

DC50/DC220/DC230



PictBridge

Please read also the following instruction manual (electronic version on PDF file). For further details refer to the installation guide.

Veuillez lire aussi le manuel d'instruction suivant (version électronique sur fichier PDF). Pour d'autres détails référez-vous au guide d'installation.

Lea también el siguiente manual de instrucciones (versión electrónica en archivo PDF). Para mayores detalles, refiérase a la guía de instalación.

• **Digital Video Software**



NTSC

Important Usage Instructions

WARNING!



TO REDUCE THE RISK OF FIRE OR ELECTRIC SHOCK, DO NOT EXPOSE THIS PRODUCT TO RAIN OR MOISTURE.

WARNING!



TO REDUCE THE RISK OF ELECTRIC SHOCK AND TO REDUCE ANNOYING INTERFERENCE, USE THE RECOMMENDED ACCESSORIES ONLY.

COPYRIGHT WARNING:

Unauthorized recording of copyrighted materials may infringe on the rights of copyright owners and be contrary to copyright laws.

DVD Camcorder, DC50/DC220/DC230 A systems

This device complies with Part 15 of the FCC Rules. Operation is subject to the following two conditions: (1) This device may not cause harmful interference, and (2) this device must accept any interference received, including interference that may cause undesired operation.

Note: This equipment has been tested and found to comply with the limits for class B digital device, pursuant to Part 15 of the FCC Rules. These limits are designed to provide reasonable protection against harmful interference in a residential installation. This equipment generates, uses and can radiate radio frequency energy and, if not installed and use in accordance with the instructions, may cause harmful interference to radio communications. However, there is no guarantee that interference will not occur in a particular installation. If this equipment does cause harmful interference to radio or television reception, which can be determined by turning the equipment off and on, the user is encouraged to try to correct the interference by one or more of the following measures:

- Reorient or relocate the receiving antenna.
- Increase the separation between the equipment and receiver.
- Connect the equipment into an outlet on a circuit different from that to which the receiver is connected.
- Consult the dealer or an experienced radio/TV technician for help.

The cable with the ferrite core provided with the digital video camcorder must be used with this equipment in order to comply with Class B limits in Subpart B of Part 15 of the FCC rules.

Do not make any changes or modifications to the equipment unless otherwise specified in the manual.

If such changes or modifications should be made, you could be required to stop operation of the equipment.

Canon U.S.A. Inc.

One Canon Plaza, Lake Success, NY 11042, U.S.A.

Tel No. (516)328-5600

CAUTION:

TO PREVENT ELECTRIC SHOCK, MATCH WIDE BLADE OF PLUG TO WIDE SLOT, FULLY INSERT.

Important Warning



The lightning flash with arrowhead symbol, within an equilateral triangle, is intended to alert the user to the presence of uninsulated "dangerous voltage" within the product's enclosure, that may be of sufficient magnitude to constitute a risk of electric shock to persons.

CAUTION:

TO REDUCE THE RISK OF ELECTRIC SHOCK, DO NOT REMOVE COVER (OR BACK). NO USER-SERVICEABLE PARTS INSIDE. REFER SERVICING TO QUALIFIED SERVICE PERSONNEL.



The exclamation point, within an equilateral triangle, is intended to alert the user to the presence of important operating and maintenance (servicing) instructions in the literature accompanying the product.

IMPORTANT SAFETY INSTRUCTIONS

In these safety instructions the word "product" refers to the Canon DVD Camcorder DC50/DC220/DC230 A and all its accessories.

- 1 **Read Instructions** — All the safety and operating instructions should be read before the product is operated.
- 2 **Retain Instructions** — The safety and operating instructions should be retained for future reference.
- 3 **Heed Warnings** — All warnings on the product and in the operating instructions should be adhered to.
- 4 **Follow Instructions** — All operating and maintenance instructions should be followed.
- 5 **Cleaning** — Unplug this product from the wall outlet before cleaning. Do not use liquid or aerosol cleaners. The product should be cleaned only as recommended in this manual.
- 6 **Accessories** — Do not use accessories not recommended in this manual as they may be hazardous.
- 7 **Avoid magnetic or electric fields** — Do not use the camera close to TV transmitters, portable communication devices or other sources of electric or magnetic radiation. They may cause picture interference, or permanently damage the camera.
- 8 **Water and Moisture** — Hazard of electric shock — Do not use this product near water or in rainy/moist situations.
- 9 **Placing or Moving** — Do not place on an unstable cart, stand, tripod, bracket or table. The product may fall, causing serious injury to a child or adult, and serious damage to the product.
A product and cart combination should be moved with care. Quick stops, excessive force, and uneven surfaces may cause the product and cart combination to overturn.



- 10 **Power Sources** — The CA-570 Compact Power Adapter should be operated only from the type of power source indicated on the marking label. If you are not sure of the type of power supply to your home, consult your product dealer or local power company. Regarding other power sources such as battery power, refer to instructions in this manual.
- 11 **Polarization** — The CA-570 Compact Power Adapter is equipped with a polarized 2-prong plug (a plug having one blade wider than the other). The 2-prong polarized plug will fit into the power outlet only one way. This is a safety feature. If you are unable to insert the plug fully into the outlet, try reversing the plug. If the plug still fails to fit, contact your electrician to replace your obsolete outlet. Do not defeat the safety purpose of the polarized plug.
- 12 **Power Cord Protection** — Power cords should be routed so that they are not likely to be walked on or pinched by items placed upon or against them. Pay particular attention to plugs and the point from which the cords exit the product.
- 13 **Outdoor Antenna Grounding** — If an outside antenna is connected to the product, be sure the antenna is grounded so as to provide some protection against voltage surges and built-up static charges. Section 810 of the National Electrical Code, ANSI / NFPA No. 70—1984, provides information with respect to proper grounding of the mast and supporting structure, grounding of the lead-in wire to an antenna discharge unit, size of grounding conductors, location of antenna discharge unit, connection to grounding electrodes, and requirements for the grounding electrode. See figure 1.

Fig. 1 EXAMPLE OF ANTENNA GROUNDING AS PER NATIONAL ELECTRICAL CODE

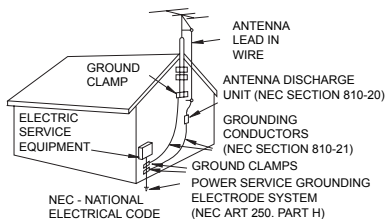

- 14** Lightning — For added protection of this product during a lightning storm, or when it is left unattended and unused for long periods of time, disconnect it from the wall outlet and disconnect the antenna. This will prevent damage to the product due to lightning and power-line surges.
- 15** Overloading — Do not overload wall outlets and extension cords as this can result in a risk of fire or electric shock.
- 16** Objects and Liquid Entry — Never push objects of any kind into this product through openings as they may touch dangerous voltage points or short out parts that could result in a fire or electric shock. Be careful not to spill liquid of any kind onto the product.
- 17** Servicing — Do not attempt to service this product yourself as opening or removing covers may expose you to dangerous voltage or other hazards. Refer all servicing to qualified service personnel.
- 18** Damage Requiring Service — Disconnect this product from the wall outlet and all power sources including battery, and refer servicing to qualified service personnel under the following conditions:
- When the power-supply cord or plug is damaged.
 - If any liquid has been spilled onto, or objects have fallen into, the product.
 - If the product has been exposed to rain or water.
 - If the product does not operate normally even if you follow the operating instructions. Adjust only those controls that are covered by the operation instructions. Improper adjustment of other controls may result in damage and will often require extensive work by a qualified technician to restore the product to its normal operation.
 - If the product has been dropped or the cabinet has been damaged.
 - When the product exhibits a distinct change in performance. This indicates a need for service.
- 19** Replacement Parts — When replacement parts are required, be sure the service technician has used replacement parts that are specified by Canon or that have the same characteristics as the original part. Unauthorized substitutions may result in fire, electric shock or other hazards.
- 20** Safety Check — Upon completion of any service or repairs to this product, ask the service technician to perform safety checks to determine that the product is in safe operating order.

When replacement of the power supply is required, please return it to the responsible nearest Canon Service Center and please replace it with the same type number CA-570.

The Adapter can be used with a power supply between 100 and 240 V AC. For areas where 120 V AC power is not used, you will need a special plug adapter. Contact your nearest Canon Service Center for further information.

This Class B digital apparatus complies with Canadian ICES-003.

How to select a DVD disc

There are many types of DVD discs but this camcorder uses only the following three types of 8 cm mini DVD discs: DVD-R, DVD-R DL and DVD-RW. Note that what you can do with a disc depends on the type of DVD used so select the disc that best fits your purpose.

DVD-R

Best for Compatibility

DVD-Rs can be recorded only once - you cannot edit or delete the recordings. On the other hand, these discs are comparatively cheaper and they can be played back in most common DVD players.

DVD-R DL

Best for Recording Time

Dual-layered discs allow writing up to 80% more data (2.6 GB) on a single recording side. However, DVD-R DLs can only be played back on DVD devices compatible with dual-layered discs. Also, you cannot edit or delete the recordings.

Dual-layered discs have two recording layers. The camcorder will record on Layer 1 and then continue to Layer 2. During the playback of a recording spanning both layers, you may notice a brief stop (about 1 second) at the point where the camcorder switches to the second layer.

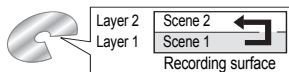

DVD-RW

Best for Reusability

Recordings made on a DVD-RW disc can be edited or deleted. Also, the disc can be initialized¹ allowing you to use the same disc numerous times.

Disc specification on DVD-RWs

DVD-RW discs can be recorded using either one of two disc specifications: VIDEO mode or VR mode. When you first insert a brand new DVD-RW disc, the camcorder will automatically display the initialization screen where you can select the disc specification for the disc.

VIDEO mode: Once finalized², discs recorded in VIDEO mode can be played back in most common DVD players offering the best compatibility. However, recordings cannot be edited (deleted, rearranged, etc.).

VR mode: You can easily edit the recordings. However, discs recorded in VR mode can only be played back with DVD players compatible with DVD-RWs in VR mode.

Note: DVD-R and DVD-R DL discs can only be recorded in VIDEO mode.

Great Advantages of DVDs

Why DVDs are better than tapes

No need to worry about recording over a tape.

When you use a DVD, the camcorder will automatically record on the empty space of the disc. So you don't have to worry about mistakenly recording over a precious memory.

Just select a scene from the index screen.

You don't need to bother running a tape forwards and backwards to find the scene you want to play back. Simply select a scene from the index screen and start the playback in a breeze.

Easily edit your recordings on a computer.

You can transfer your videos and photos from the disc to a computer and easily edit them with editing software. Easily create your own original movies.

Recommended Discs

The camcorder's performance was tested with single-layered discs using the supplied discs and Hitachi-Maxell HG series DVD discs; and with dual-layered discs using Canon DVD-R DL54 discs and Verbatim DVD-R DL discs. For further details, contact directly the manufacturer's customer support center. Note that attempting to record or play with this camcorder DVD discs that were recorded, initialized or finalized with other digital devices can result in permanently losing the recordings.

For the highest compatibility with external DVD devices we recommend using the VIDEO mode.

Available features depend on the DVD disc used

Disc Type	DVD-R	DVD-R DL	DVD-RW	
			VIDEO	VR
Editing scenes with this camcorder (deleting scenes, editing the Playlist) (□□ 68)	—	—	—	●
Deleting a scene or still image immediately after recording it (□□ 69, 73)	—	—	●	●
Initializing the disc in order to use it again for recording (□□ 71)	—	—	●	●
Giving a title to the disc (□□ 72)	●	●	●	●
Finalizing the disc in order to play it with a DVD player (□□ 77)	●	●	●	● ³
Adding recordings to a disc already finalized (□□ 79)	—	—	● ⁴	●
Copying still images between the disc and the memory card (□□ 74)	●	●	●	●
Converting still images into Photomovie scenes (□□ 74)	●	●	●	●
Editing scenes on a computer ⁵ (□□ 83)	●	●	●	●

¹ Disc initialization clears all the recordings on the disc and restores the free space on the disc to its initial value so you can use the same disc again. DVD-R and DVD-R DL discs cannot be initialized.

² Disc finalization is the processing of the free space (the unrecorded area) on the disc in order to make it playable on external DVD devices (□□ 77). To finalize a DVD-R DL disc, the camcorder has to process both layers. Therefore, and depending on the amount of free space on the disc, this process may be lengthy.

³ Playback cannot be guaranteed with all external DVD devices.

⁴ You will need to unfinalize the disc first.

⁵ The MyDVD for Canon software is not included with the **DCP20/DCP30**.

Table of contents

Introduction

How to select a DVD disc	5
--------------------------------	---

About this Manual

About the Joystick and the Joystick Guide	11
About the Power Switch	12
About the Operating Modes	12

Getting to Know the Camcorder

Supplied Accessories	14
DC50 Components Guide	15
DC220/DC230 Components Guide	17
Screen Displays	20

Preparations

Getting Started

Charging the Battery Pack	23
Inserting and Removing a Disc	26
Inserting and Removing a Memory Card	28
Preparing the Camcorder	28
DC50/DC230 The Wireless Controller	29
Adjusting the LCD Screen	30

Using the Menus

Selecting a FUNC. Menu Option	31
Selecting an Option from the Setup Menus	31

First Time Settings

Changing the Language	32
Changing the Time Zone	32
Setting the Date and Time	33

Basic Functions

Recording

Shooting Video	34
Selecting the Aspect Ratio of your Recordings (16:9 Widescreen or 4:3)	35
Taking Photos	36
Selecting the Media for the Photos	37
Zooming	38
Quick Start Function	38

Playback

Playing Back the Video	39
Displaying the Photos	41
Magnifying Photos during Playback	42

Advanced Functions

Menu Options Lists

FUNC. Menu	43
Setup Menus	45
Camera Setup (Digital Zoom, Image Stabilizer, etc.)	45
Disc Operations (Photomovie, Finalize, etc.)	47
Still Image Operations (Card Initialization, Disc-Card Copy, etc.)	48

Display Setup (LCD Brightness, Language, etc.).....	49
System Setup (Volume, Beep, Media Select  , etc.).....	50
Date/Time Setup	51
Line-in Mode.....	51
Recording Programs	
Using the Recording Programs	52
P Flexible Recording: Changing the Aperture and Shutter Speed	53
Special Scene: Recording Programs to Match Special Conditions	54
Adjusting the Picture: Exposure, Focus and Color	
Manual Exposure Adjustment.....	55
Manual Focus Adjustment.....	56
White Balance	57
Image Effects.....	58
Still Image Recording Options	
Selecting the Size and Quality of Still Images	59
Capturing a Still Image while Recording Movies	60
Automatic Focus Priority.....	61
DC50 Light Metering Mode	61
DC50/DC230 Continuous Shooting and Exposure Bracketing.....	62
Other Functions	
On-Screen Displays.....	63
DC50 Flash	64
DC50 Mini Video Light.....	65
Self Timer	66
Digital Effects.....	66
Editing Functions	
Managing Scenes	
Adding Scenes to the Playlist.....	68
Moving Scenes in the Playlist.....	69
Deleting Scenes	69
Dividing a Scene.....	70
Managing the Disc	
Protecting the Disc	71
Initializing the Disc.....	71
Changing the Disc Title	72
Managing Photos	
Erasing Photos	73
Copying Photos	74
Converting Photos into Photomovie Scenes	74
Protecting Photos on the Memory Card	75
Initializing the Memory Card	76
Playing Back the Disc on an External Device	
Finalizing the Disc	77
Playing Back your Disc on a DVD Player or a Computer's DVD Drive	78
Unfinalizing the Disc - Additional Recordings on a Finalized Disc	79

External Connections

Connecting to a TV or VCR

Connection Diagrams	80
Playback on a TV Screen	81
Recording to a VCR or Digital Video Recorder	81
DC50 Video Input Recording	82

Connecting to a Computer

PC Connection Diagrams	83
Transferring Recordings	83
Transferring Recordings Using Windows Explorer	83
DC50 Transferring Recordings Using MyDVD for Canon	84
Transferring Still Images - Direct Transfer	89
Transfer Orders	91

Connecting to a Printer

Printing Still Images - Direct Print	92
Selecting the Print Settings	93
DC50 Trimming Settings	96
Print Orders	96

Additional Information

Trouble?

Troubleshooting	98
List of Messages	102

Do's and Don'ts

Handling Precautions	107
Maintenance/Others	110
Using the Camcorder Abroad	111



General Information

System Diagram	112
Optional Accessories	113
Product Codes	115
Specifications	116
Index	119

About this Manual

Thank you for purchasing the Canon DC50/DC220/DC230. Please read this manual carefully before you use the camcorder and retain it for future reference. Should your camcorder fail to operate correctly, refer to the *Troubleshooting* table (□ 98).

Conventions Used in the Manual

-  **IMPORTANT:** Precautions related to the camcorder's operation.
 -  **NOTES:** Additional topics that complement the basic operating procedures.
 -  **POINTS TO CHECK:** Restrictions that apply if the function described is not available in all operating modes (the operating mode to which the camcorder should be set, the type of disc required, etc.).
 - □: Reference page number.
 - **DC50**: Option or feature that applies or is available only with a specific model.
 - The following terms are used in the manual:
 - “Screen” refers to the LCD and the viewfinder screen.
 - “Scene” refers to one movie unit from the point you press the start/stop button to start recording until you press again to pause the recording.
 - The terms “Photo” and “Still image” are used interchangeably with the same meaning.
 - The photos included in the manual are simulated pictures taken with a still camera.
- Note that unless indicated otherwise, illustrations in this manual refer to the **DC50** model.

Brackets [] and capital letters are used to refer to menu options as they are displayed on screen. Menu options in boldface indicate the default setting (for example **[ON]**, **[OFF]**).

Menu item shown at its default position

Buttons and switches to be operated

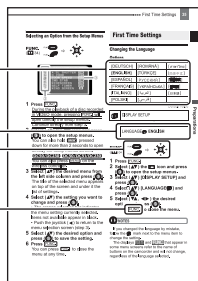

Names of buttons and switches other than the joystick are indicated within a “button” frame (for example **[FUNC.]**).

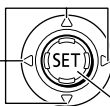

About the Joystick and the Joystick Guide

Push the joystick up, down, left or right (, , , ) to select an item or change settings.





Press the joystick itself () to save the settings or confirm an action. On menu screens, this is indicated by the icon .

The functions assigned to the joystick change according to the operation mode and the camcorder's settings. Press () to display/hide the joystick guide.

In the illustrations of the manual, positions other than those relevant to the function explained are marked with a striped pattern. Depending on the mode and the operation mode, these positions may be empty or show a different icon than the one on the illustration.



When the joystick guide contains multiple 'pages', [NEXT] and the page number icon () will appear at the bottom position. Push the joystick () toward [NEXT] to display the next 'page' of the guide.

About the Power Switch



In addition to turning the camcorder on and off, the power switch also toggles the camcorder's operating mode.



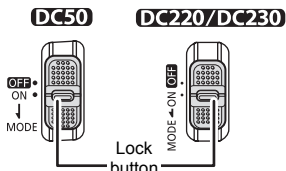











To turn on the camcorder: Hold the lock button pressed down and move the power switch down to ON.





To change the operating mode: From the ON position, slide down the power switch momentarily toward MODE and release it. This action will toggle the operating mode between recording (CAMERA - red indicator) and playback (PLAY - green indicator).



About the Operating Modes

The camcorder's operating mode is determined by the positions of the power switch and the  switch. In the manual,  indicates that a function is available in the operating mode shown and  indicates that the function is not available. When no operating mode icons are given, the function is available in all operating modes.

Operating Mode	Operating Mode Indicator	 /  Switch	Icon Display	Operation	
	CAMERA (Red)			Recording movies on the disc	34
	PLAY (Green)			Playing movies from the disc	39
	CAMERA (Red)		 or 	Recording still images on the memory card or disc	36
	PLAY (Green)		 or 	Viewing still images from the memory card or disc	41

¹ Functions available only for still images recorded on the disc will be marked with  and  and functions available only for still images recorded on the memory card will be marked with  and  instead.







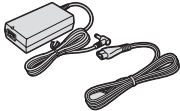

² Depending on whether you choose to save the still images on the disc or the memory card.

Trademark Acknowledgements

- miniSD™ is a trademark of SD Card Association.
- Windows® is a registered trademark of Microsoft Corporation in the United States and/or other countries.
- Macintosh and Mac OS are trademarks of Apple Computer, Inc., registered in the United States and other countries.
-  is a trademark of DVD Format/Logo Licensing Corporation.
- Manufactured under license from Dolby Laboratories.
“Dolby” and the double-D symbol are trademarks of Dolby Laboratories.
- Other names and products not mentioned above may be trademarks or registered trademarks of their respective companies.
- ANY USE OF THIS PRODUCT OTHER THAN CONSUMER PERSONAL USE IN ANY MANNER THAT COMPLIES WITH THE MPEG-2 STANDARD FOR ENCODING VIDEO INFORMATION FOR PACKAGED MEDIA IS EXPRESSLY PROHIBITED WITHOUT A LICENSE UNDER APPLICABLE PATENTS IN THE MPEG-2 PATENT PORTFOLIO, WHICH LICENSE IS AVAILABLE FROM MPEG LA, L.L.C., 250 STEELE STREET, SUITE 300, DENVER, COLORADO 80206.

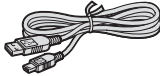

Supplied Accessories

CA-570 Compact Power Adapter (incl. power cord) 	BP-208 Battery Pack 	DC50/DC230 WL-D86 Wireless Controller 	DC50/DC230 Lithium Button Battery CR2025 for Wireless Controller 
STV-250N Stereo Video Cable 	IFC-300PCU USB Cable 	DC50 Blank DVD-R Disc (8 cm Mini DVD) 	DIGITAL VIDEO SOLUTION DISK Software CD-ROM* 
DC50 Roxio MyDVD for Canon Software CD-ROM 			

* Includes the electronic version of the *Digital Video Software* instruction manual on PDF file.

Online product registration for U.S.A. Customers only.

Register your product online at www.registercanon.com

✓ Protect your product

We will keep the model number and date of purchase of your new Canon product on file to help you refer to this information in the event of an insurance claim such as loss or theft.

✓ Receive information on new products and promotions

Upon your request, we will send you information on Canon new products and promotions.

The serial number of this product can be found at the battery attachment unit of the camcorder. Write down the number and other information here and retain this book as a permanent record of your purchase to aid identification in case of theft.

Date of Purchase:

Model Name: DC50/DC220/DC230 A

Purchased From:

Serial No.:

Dealer Address:

Dealer Phone No.:

DC50 Components Guide

Left side view

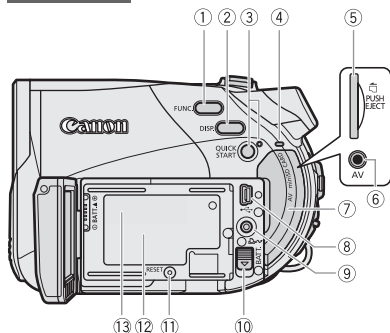

Right Side View

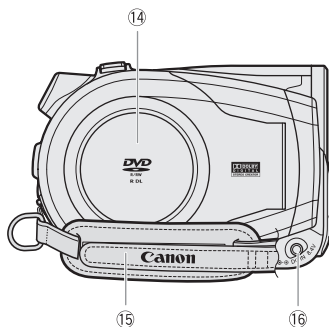

Front view

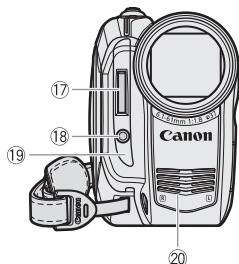

- ① FUNC. button (☐ 31, 43)
- ② DISP. button (☐ 63)
- ③ QUICK START button and standby lamp (☐ 38)
- ④ CARD access indicator (☐ 36)
- ⑤ Memory card slot (☐ 28)
- ⑥ AV terminal (☐ 80)
- ⑦ Memory card slot cover/Terminal cover
- ⑧ USB terminal (☐ 83)
- ⑨ (print/share) button (☐ 87, 89, 93)
- ⑩ BATT. (battery release) switch (☐ 23)
- ⑪ RESET button (☐ 98)
- ⑫ Serial number
- ⑬ Battery attachment unit (☐ 23)
- ⑭ Disc compartment cover (☐ 26)
- ⑮ Grip belt (☐ 28)
- ⑯ DC IN terminal (☐ 23)
- ⑰ Flash (☐ 64)
- ⑱ Mini video light (☐ 65)
- ⑲ Remote sensor (☐ 29)
- ⑳ Stereo microphone

Names of buttons and switches other than the joystick are indicated within a "button" frame (for example).

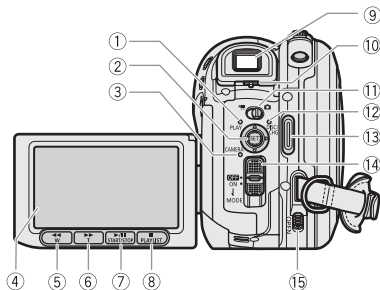
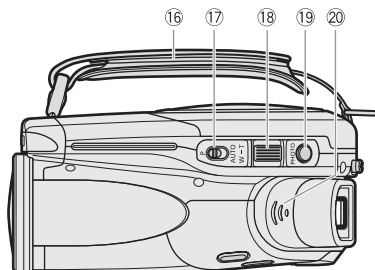
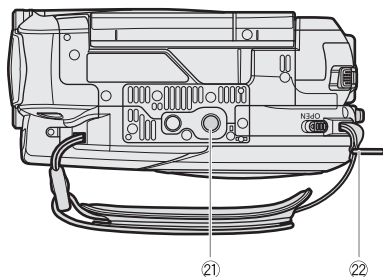
Back view**Top view****Bottom view**

- ① PLAY mode indicator (green) (□ 12)
- ② Joystick (□ 11)
- ③ CAMERA mode indicator (red) (□ 12)
- ④ LCD screen (□ 30)
- ⑤ ◀◀ (fast reverse) button (□ 40) / Zoom out **W** (wide-angle) button (□ 38)
- ⑥ ▶▶ (fast forward) button (□ 40) / Zoom in **T** (telephoto) button (□ 38)
- ⑦ ▶/|| (play/pause) button (□ 39) / START/ STOP button (□ 34)
- ⑧ ■ (stop) button (□ 39) / PLAYLIST button (□ 68)
- ⑨ Viewfinder (□ 28)
- ⑩ Dioptic adjustment lever (□ 28)
- ⑪ (movies/still images) switch (□ 12)
- ⑫ DISC access indicator (□ 34, 36) / CHG (charge) indicator (□ 23)
- ⑬ Start/stop button (□ 34)
- ⑭ Power switch (□ 12)
- ⑮ OPEN (disc cover) switch (□ 26)
- ⑯ Grip belt (□ 28)
- ⑰ Mode switch (□ 52)
- ⑱ Zoom lever (□ 38)
- ⑲ PHOTO button (□ 36)
- ⑳ Speaker (□ 40)
- ㉑ Tripod socket (□ 35)
- ㉒ Strap mount

Names of buttons and switches other than the joystick are indicated within a "button" frame (for example **FUNC.**).

DC220/DC230 Components Guide

Left side view

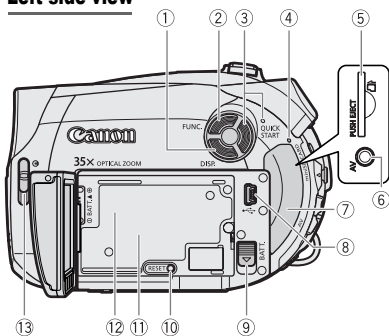

Right Side View

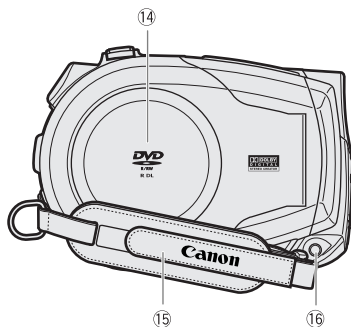

Front view

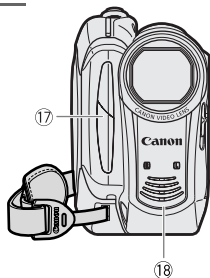

- ① DISP. button (□ 63)
- ② FUNC. button (□ 31, 43)
- ③ QUICK START button and standby lamp (□ 38)
- ④ CARD access indicator (□ 36)
- ⑤ Memory card slot (□ 28)
- ⑥ AV terminal (□ 80)
- ⑦ Memory card slot cover/Terminal cover
- ⑧ USB terminal (□ 83)
- ⑨ BATT. (battery release) switch (□ 23)
- ⑩ RESET button (□ 98)
- ⑪ Serial number
- ⑫ Battery attachment unit (□ 23)
- ⑬ Lens cover switch (□ 34, 36)
(☺ open, ☹ closed)
- ⑭ Disc compartment cover (□ 26)
- ⑮ Grip belt (□ 28)
- ⑯ DC IN terminal (□ 23)
- ⑰ **DC230** Remote sensor (□ 29)
- ⑱ Stereo microphone

Names of buttons and switches other than the joystick are indicated within a "button" frame (for example FUNC.).

Back view

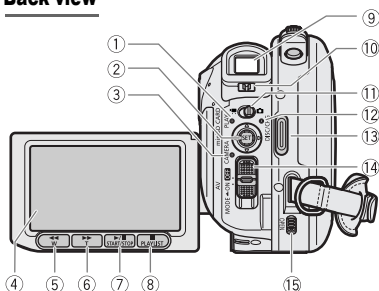

Top view

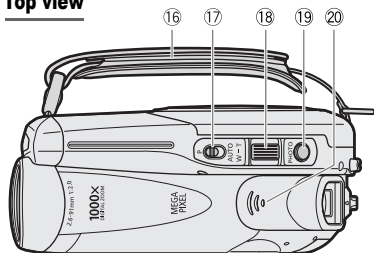

Bottom view

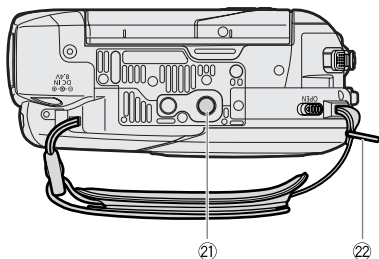

- ① PLAY mode indicator (green) (□ 12)
- ② Joystick (□ 11)
- ③ CAMERA mode indicator (red) (□ 12)
- ④ LCD screen (□ 30)
- ⑤ ◀◀ (fast reverse) button (□ 40) /
Zoom out **W** (wide-angle) button (□ 38)
- ⑥ ▶▶ (fast forward) button (□ 40) /
Zoom in **T** (telephoto) button (□ 38)
- ⑦ ▶/|| (play/pause) button (□ 39) /
START/STOP button (□ 34)
- ⑧ ■ (stop) button (□ 39) /
PLAYLIST button (□ 68)
- ⑨ Viewfinder (□ 28)
- ⑩ Dioptric adjustment lever (□ 28)
- ⑪ **M**/**S** (movies/still images) switch (□ 12)
- ⑫ DISC access indicator (□ 34, 36) /
CHG (charge) indicator (□ 23)
- ⑬ Start/stop button (□ 34)
- ⑭ Power switch (□ 12)
- ⑮ OPEN (disc cover) switch (□ 26)
- ⑯ Grip belt (□ 28)
- ⑰ Mode switch (□ 52)
- ⑱ Zoom lever (□ 38)
- ⑲ PHOTO button (□ 36)
- ⑳ Speaker (□ 40)
- ㉑ Tripod socket (□ 35)
- ㉒ Strap mount

Names of buttons and switches other than the joystick are indicated within a "button" frame (for example **FUNC.**).

DC50/DC230 Wireless Controller WL-D86

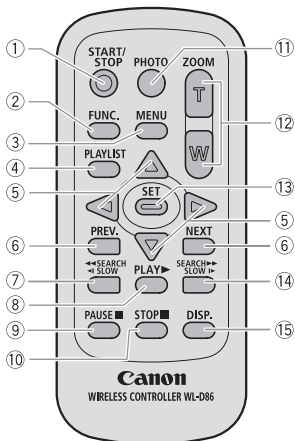







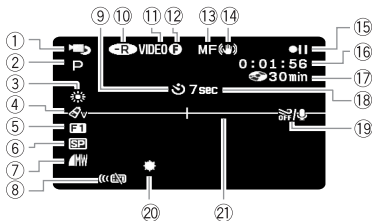







- ① START/STOP button (34)
- ② FUNC. button (31)
- ③ MENU button (31)
- ④ PLAYLIST button (68)
- ⑤ Navigation buttons (▲/▼/◀/▶)
- ⑥ PREV./NEXT buttons:
Scene skip (40)/
Index screen page up/down (39)
- ⑦ Reverse ◀◀ SEARCH button (40) /
Reverse ◀ SLOW button (40)
- ⑧ PLAY ▶▶ button (39)
- ⑨ PAUSE || button (39)
- ⑩ STOP ■ button (39)
- ⑪ PHOTO button (36)
- ⑫ Zoom buttons (38)
- ⑬ SET button
- ⑭ Forward SEARCH ▶▶▶ button (40) /
Forward SLOW ▶▶ button (40)
- ⑮ DISP. (on-screen display) button (63)

Screen Displays









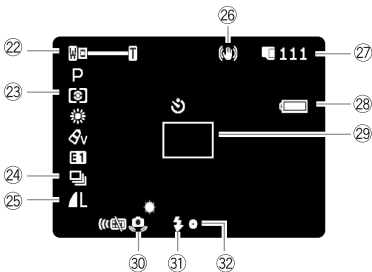









CAMERA Recording Movies



- ① Operating mode ( 12)
- ② Recording program ( 52)
- ③ White balance ( 57)
- ④ Image effect ( 58)
- ⑤ Digital effects ( 66)
- ⑥ Recording mode ( 44)
- ⑦ Still image quality/size (simultaneous recording) ( 60)
- ⑧ Remote sensor off** ( 50)
- ⑨ Self timer ( 66)
- ⑩ Disc type  DVD-R,  DVD-R DL,  DVD-RW ( 5)
- ⑪ Disc specification (VIDEO mode, VR mode) ( 5)

CAMERA Recording Still Images



- ⑫ Finalized disc mark ( 77)
- ⑬ Manual focus ( 56)
- ⑭ Image stabilizer ( 46)
- ⑮ Disc operation
- ⑯ Time code (hours : minutes : seconds)
- ⑰ Remaining recording time on the disc
- ⑱ Recording reminder
- ⑲ Wind screen off ( 47)
- ⑳ Mini video light* ( 65)
- ㉑ Level marker ( 49)
- ㉒ Zoom ( 38), Exposure  ( 55)
- ㉓ Light metering mode* ( 61)
- ㉔ Drive mode** ( 62)
- ㉕ Still image quality/size ( 59)
- ㉖ Image stabilizer (still images)* ( 46)
- ㉗ Number of still images available  on the memory card,  on the disc
- ㉘ Remaining battery charge estimate
- ㉙ AF frame ( 61)
- ㉚ Camcorder shake warning ( 45)
- ㉛ Flash* ( 64)
- ㉜ Autofocus (AF) and exposure (AE) locked ( 36)

* **DC50** only.

** **DC50/DC230** only.

15 Disc operation

- Record, ● ■■ Record pause,
- ▶ Playback, ■■ Playback pause,
- ▶▶ Fast playback,
- ◀◀ Fast reverse playback,
- ▶ Slow playback,
- ◀ Slow reverse playback

17 Remaining recording time

When there is no more disc space available, “END” will be displayed and the recording will stop.

18 Recording reminder

The camcorder counts from 1 to 10 seconds when you start recording. This is helpful to avoid scenes that are too short.

27 Number of still images available on the card/disc

- ⚡ flashing in red: No card
- in green: 6 or more images
- in yellow: 1 to 5 images
- in red: No more images can be recorded

- When viewing the still images, the display will always be in green.
- ⏸ will be displayed instead of □ for still images on the disc.
- Depending on the recording conditions, the number of available still images displayed may not decrease even after a recording has been made, or may decrease by 2 still images at once.

Card/Disc access display

“▶” is displayed next to the number of images available while the camcorder is writing on the memory card or disc.

28 Remaining battery charge estimate



- When “⚡” starts flashing in red replace the battery pack with a fully charged one.
- When you attach an empty battery pack, the power may turn off without displaying “⚡”.
- Depending on the conditions under which the camcorder and the battery pack are used, the actual battery charge may not be indicated accurately.









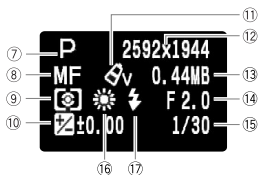
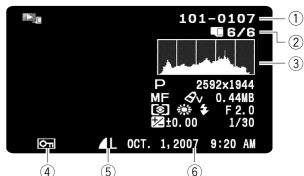







PLAY Playing Movies (During Playback)



- ① Disc operation
- ② Playback time (hours : minutes : seconds)
- ③ Scene number
- ④ Data code ( 64)

PLAY Viewing Still Images



- ① Image number ( 50)
- ② Current image / Total number of images
 recorded on the card,
 recorded on the disc
- ③ Histogram ( 64)
- ④ Image protection mark ( 75)
- ⑤ Still image quality/size ( 59)
- ⑥ Date and time of recording
- ⑦ Recording program ( 52)
- ⑧ Manual focus ( 56)
- ⑨ Light metering mode* ( 61)
- ⑩ Manual exposure ( 55)
- ⑪ Image effect ( 58)
- ⑫ Image size ( 59)
- ⑬ File size
- ⑭ Aperture value ( 53)
- ⑮ Shutter speed ( 53)
- ⑯ White balance ( 57)
- ⑰ Flash* ( 64)

* **DC50** only.

Getting Started

Charging the Battery Pack

The camcorder can be powered with a battery pack or directly using the compact power adapter. Charge the battery pack before use.

DC50

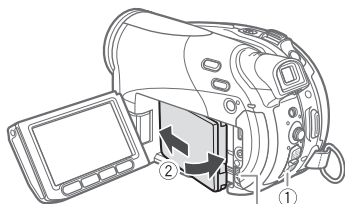

BATT. switch

DC220/DC230

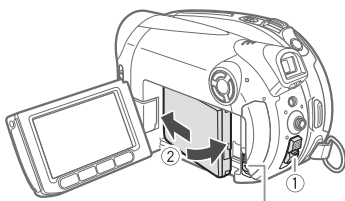

BATT. switch

- 1 Turn off the camcorder.
- 2 Attach the battery pack to the camcorder.
 - Open the LCD panel.
 - Slide in the connector end of the battery in the direction of the arrow and press it gently until it clicks.

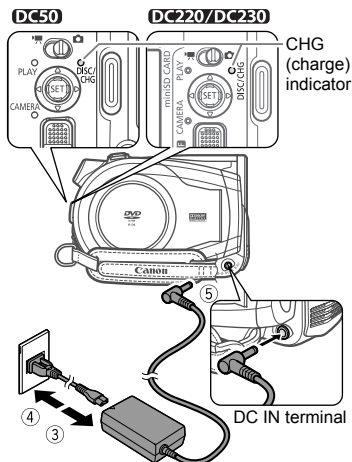

- 3 Connect the power cord to the compact power adapter.
- 4 Plug the power cord into a power outlet.
- 5 Connect the compact power adapter to the camcorder's DC IN terminal.
 - The CHG (charge) indicator starts flashing. The indicator will stay on when the charging is completed.
 - You can also use the compact power adapter without attaching a battery pack.
 - When the compact power adapter is connected, even if a battery is attached its power will not be consumed.

ONCE THE BATTERY IS FULLY CHARGED

- 1 Disconnect the compact power adapter from the camcorder.
- 2 Unplug the power cord from the power outlet and the compact power adapter.

TO REMOVE THE BATTERY PACK

Slide down **BATT.** to release the battery pack, and pull out the battery pack holding it from the ridge on its bottom part.

! IMPORTANT

- Turn off the camcorder before connecting or disconnecting the compact power adapter. After you turn off the power switch to **OFF**, important file allocation data is updated on the disc. Be sure to wait until the LCD display is completely off.
- You may hear some noise from the compact power adapter during use. This is not a malfunction.
- We recommend charging the battery pack in temperatures between 10 °C and 30 °C (50 °F and 86 °F). Outside the temperature range of 0 °C to 40 °C (32 °F to 104 °F), the charging will not start.
- Do not connect to the camcorder's DC IN terminal or to the compact power adapter any electrical equipment that is not expressly recommended for use with this camcorder.
- To prevent equipment breakdowns and excessive heating, do not connect the supplied

compact power adapter to voltage converters for overseas travels or special power sources such as those on aircraft and ships, DC-AC inverters, etc.

i NOTES

- The CHG (charge) indicator also serves as a rough estimate of the battery charge status. Continuously on: Battery fully charged. Flashes approx. twice per second: Battery over 50% charged. Flashes approx. once per second: Battery less than 50% charged.
- The charging time will vary depending on the surrounding temperature and the battery pack's initial charge condition. In cold places, the effective usage time of the battery will decrease.
- We recommend that you prepare battery packs 2 to 3 times longer than you think you might need.
- **U.S.A. and Canada only:** The lithium ion/polymer battery that powers this product is recyclable. Please call 1-800-8-BATTERY for information on how to recycle this battery.



Charging, Recording and Playback Times with the BP-208 Battery Pack

The recording and playback times given in following tables are approximate and vary according to the charging, recording or playback conditions.

DC50

Battery Pack	BP-208			BP-214		
Charging Time	160 min.			245 min.		
Maximum Recording Times	Recording Mode					
	XP	SP	LP	XP	SP	LP
Viewfinder	80 min.	95 min.	100 min.	135 min.	160 min.	165 min.
LCD [NORMAL]	80 min.	90 min.	95 min.	135 min.	155 min.	160 min.
LCD [BRIGHT]	75 min.	90 min.	95 min.	130 min.	150 min.	155 min.
Typical Recording Times*	Recording Mode					
	XP	SP	LP	XP	SP	LP
Viewfinder	50 min.	50 min.	50 min.	85 min.	90 min.	90 min.
LCD [NORMAL]	45 min.	50 min.	50 min.	80 min.	85 min.	90 min.
LCD [BRIGHT]	45 min.	50 min.	50 min.	80 min.	80 min.	85 min.
Playback Times	100 min.	115 min.	125 min.	170 min.	190 min.	210 min.

DC30



Battery Pack	BP-208					
Recording Mode	XP		SP		LP	
Recording Times	Maximum	Typical*	Maximum	Typical*	Maximum	Typical*
Viewfinder	105 min.	60 min.	125 min.	60 min.	135 min.	65 min.
LCD [NORMAL]	105 min.	60 min.	120 min.	60 min.	130 min.	65 min.
LCD [BRIGHT]	100 min.	55 min.	115 min.	60 min.	125 min.	60 min.
Playback Time	135 min.		150 min.		165 min.	
Charging Time	160 min.					

DC20

Battery Pack	BP-208					
Recording Mode	XP		SP		LP	
Recording Times	Maximum	Typical*	Maximum	Typical*	Maximum	Typical*
Viewfinder	115 min.	60 min.	135 min.	65 min.	145 min.	70 min.
LCD [NORMAL]	110 min.	60 min.	125 min.	65 min.	140 min.	65 min.
LCD [BRIGHT]	105 min.	60 min.	120 min.	60 min.	130 min.	65 min.
Playback Time	140 min.		165 min.		175 min.	
Charging Time	160 min.					

* Approximate times for recording with repeated operations such as start/stop, zooming, power on/off.

Inserting and Removing a Disc

Use only 8 cm (3 in.) mini DVD discs marked with the DVD-R  logo (including DVD-R DL) or the DVD-RW  logo. Refer also to *Recommended Discs* (□ 6).

Before inserting the disc be sure to check that the recording surface is clean. If necessary, use a soft lens-cleaning cloth to remove any fingerprints, dirt buildup or smudges from the disc surface.

Inserting the Disc

POINTS TO CHECK



(□ 12)

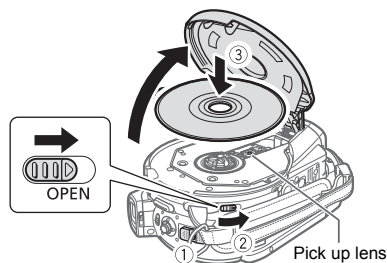

1 Move the power switch to ON to set the camcorder in **CAMERA mode.**

2 Slide **OPEN fully in the direction of the arrow and gently open the disc cover completely until it stops.**

Retract the grip belt under the camcorder so it will not get in the way of the disc cover.

3 Insert the disc and press its center firmly until it clicks in place.

- Insert the disc with the recording side facing down (single sided discs – label side facing out).
- Be careful not to touch the recording surface of the disc or the pick up lens.

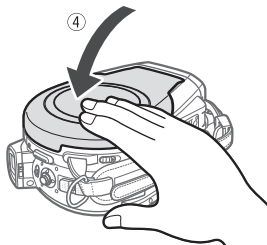





4 Close the disc cover.







Do not force the cover closed if the disc is not correctly inserted and firmly set in place.

WHEN USING DVD-R/DVD-R DL DISCS

You can start recording movies once the record pause  indication appears.

WHEN USING A DVD-RW

You need to initialize new discs before you can start recording. The disc initialization screen will appear when a new DVD-RW is first inserted if the /  switch is set to . The disc initialization screen will not appear when inserting a disc already initialized. In that case, you can start recording once the record pause  indication appears.

- ① Select () the desired disc specification and press (). For a comparison between the [VIDEO] and [VR] specifications, see *How to select a DVD disc* (□ 5).
- ② You will be asked to confirm the disc specification you selected. Select () [YES] and press () to continue, or select [NO] and press () to return and select a different disc specification.
- ③ A confirmation message will appear on the screen. Select () [YES] and press () to start the disc initialization.

- The disc initialization will take approximately one minute. Avoid moving the camcorder while the operation is in progress.
- You can start recording movies once the record pause ●|| indication appears.

i NOTES

The process of recognizing a disc may take a moment. The  display will move while the disc is being read. Wait until the camcorder finishes recognizing the disc before you start recording.

Removing the Disc

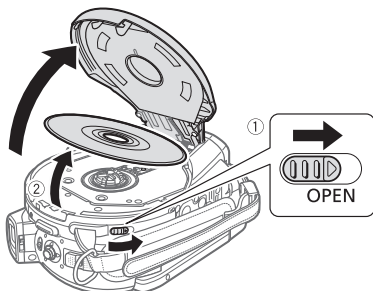

1 Slide **OPEN fully in the direction of the arrow and gently open the disc cover completely until it stops.**

- Do not subject the camcorder to strong impacts while the DISC access indicator is on or flashing.
- Retract the grip belt under the camcorder so it will not get in the way of the disc cover.
- It may take a moment after sliding **OPEN** for the disc cover to open.

2 Grab the edge of the disc and gently pull it out.

Be careful not to touch the recording surface of the disc or the pick up lens.

3 Close the disc cover.

! IMPORTANT

When you slide **OPEN** after making a recording, important file allocation data is updated on the disc before the disc cover opens. While the DISC access indicator is on or flashing do not subject the camcorder to shocks such as forcefully laying it on a table.

Inserting and Removing a Memory Card

Only miniSD cards can be used with this camcorder.

DC50

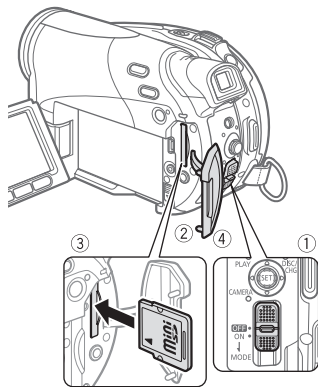

DC220/DC230

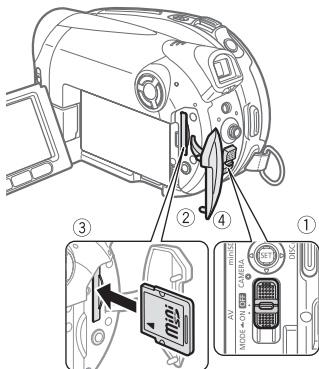

- 1 Turn off the camcorder.
- 2 Open the memory card slot cover.
- 3 Insert the memory card straight all the way into the memory card slot.
- 4 Close the cover.

Do not force the cover closed if the memory card is not correctly inserted.

TO REMOVE THE MEMORY CARD

First push the memory card once to release it, and then pull the card out.

! IMPORTANT

- Make sure to initialize all memory cards before using them with this camcorder (p. 76).
- Memory cards have front and back sides that are not interchangeable. Inserting a memory card facing the wrong direction can cause a malfunction of the camcorder.

i NOTES

You may not be able to use certain types of miniSD cards.

Preparing the Camcorder

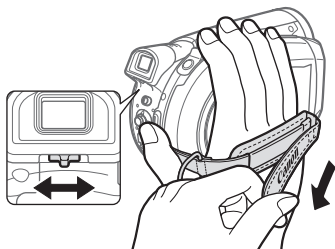

- 1 Turn on the camcorder.
DC50 The lens cover will open automatically.
- 2 **DC220/DC230** Move the lens cover switch down to  to open the lens cover.
- 3 Adjust the viewfinder.
 Keep the LCD panel closed to use the viewfinder and adjust the dioptic adjustment lever as necessary.

4 Fasten the grip belt.

Adjust the grip belt so that you can reach the zoom lever with your index finger, and the start/stop button with your thumb.

DC50/DC230 The Wireless Controller

Inserting the Battery

(Lithium Button Battery CR2025)

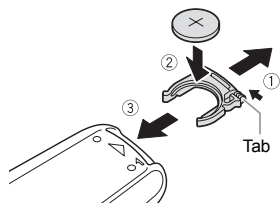

- 1 Press the tab in the direction of the arrow and pull out the battery holder.
- 2 Place the lithium button battery with the + side facing up.
- 3 Insert the battery holder.

Using the Wireless Controller

DC50

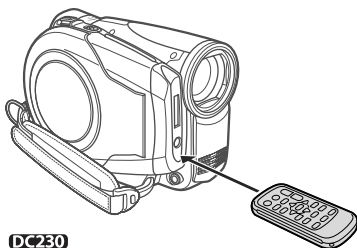

DC230

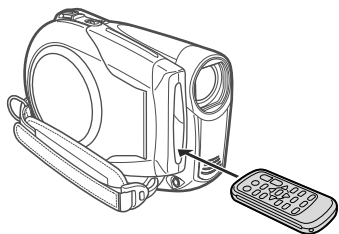

Point the controller at the camcorder's remote sensor when you press the buttons.

i NOTES

- The wireless controller may not work properly when the remote sensor is situated under strong light sources or direct sunlight.
- If the wireless controller does not work, check that [WL.REMOTE] is not set to [OFF (OFF)] (p. 50). Otherwise, replace the battery.

Adjusting the LCD Screen

Rotating the LCD Panel

Open the LCD panel 90 degrees.

- You can rotate the panel 90 degrees downward.
- You can rotate the panel 180 degrees toward the lens (allowing the subject to monitor the LCD screen while you use the viewfinder). Rotating the panel 180 degrees is also useful if you wish to include yourself when recording with the self timer. This is the only case where you can use the viewfinder and the LCD screen simultaneously.

DC50

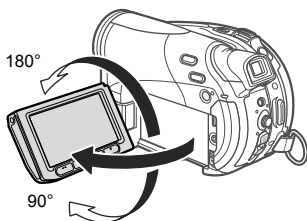

180°

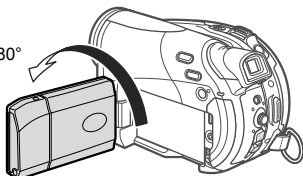

Subject can monitor the LCD screen

DC220/DC230

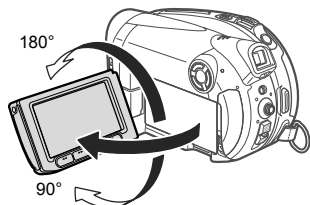

90°

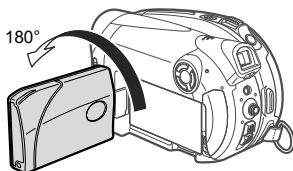

Subject can monitor the LCD screen

LCD Backlight

You can adjust the brightness of the LCD screen to one of two levels.

DC50

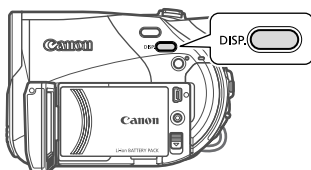

DC220/DC230

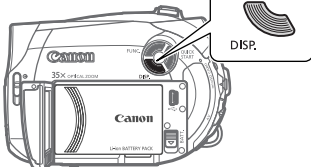

Keep **DISP.** pressed down for more than 2 seconds.

Repeat this action to toggle between the normal and bright settings.

i NOTES

- This setting does not affect the brightness of the recording or the viewfinder screen.
- Using the bright setting will shorten the effective usage time of the battery.

Using the Menus

Many of the camcorder's functions can be adjusted from the menus that open after pressing the FUNC. button (FUNC.).

For details about the available menu options and settings, refer to the *Menu Options Lists* (43).

Selecting an Option from the Setup Menus



Selecting a FUNC. Menu Option

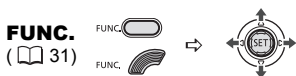

- 1 Press **FUNC.**
- 2 Select (**▲▼**) the icon of the function you want change from the left side column. Menu items not available will appear grayed out.
- 3 Select (**◀▶**) the desired setting from the available options at the bottom bar.
 - The selected option will be highlighted in light blue. Menu items not available will appear grayed out.
 - With some settings, you will need to make further selections (**▲▼**, **◀▶**) and/or press (**SET**). Follow the additional operation guides that will appear on the screen (such as the **SET** icon, small arrows, etc.).
- 4 Press **FUNC.** to save the settings and close the menu. You can press **FUNC.** to close the menu at any time.

- 1 Press **FUNC.** During the playback of a disc recorded in VIDEO mode, pressing **FUNC.** will open directly the setup menus. Continue directly from step 3.
- 2 Select (**▲▼**) the  icon and press (**SET**) to open the setup menus.
 - You can also hold **FUNC.** pressed down for more than 2 seconds to open directly the setup menus screen.**DC50/DC230** You can also press **MENU** on the wireless controller.
 - Push the joystick (**◀**) to return to the menu selection screen (step 3).
- 3 Select (**▲▼**) the desired menu from the left side column and press (**SET**). The title of the selected menu appears on top of the screen and under it the list of settings.
- 4 Select (**▲▼**) the setting you want to change and press (**SET**). The orange selection bar indicates the menu setting currently selected. Items not available appear in black.
- 5 Select (**▲▼**) the desired option and press (**SET**) to save the setting.
- 6 Press **FUNC.** You can press **FUNC.** to close the menu at any time.

First Time Settings

Changing the Language

Options

[DEUTSCH]	[ROMÂNĂ]	[ภาษาไทย]
[ENGLISH]*	[TÜRKÇE]	[简体中文]
[ESPAÑOL]	[РУССКИЙ]	[繁體中文]
[FRANÇAIS]	[УКРАЇНСЬКА]	[한국어]
[ITALIANO]	[العربية]	[日本語]
[POLSKI]	[فارسی]	

* Default value

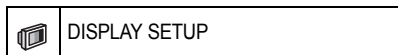

LANGUAGE ENGLISH*



- 1 Press **FUNC.**.
- 2 Select (**▲▼**) the icon and press (**SET**) to open the setup menus.
- 3 Select (**▲▼**) [DISPLAY SETUP] and press (**SET**).
- 4 Select (**▲▼**) [LANGUAGE] and press (**SET**).
- 5 Select (**▼▲**, **◀▶**) the desired option and press (**SET**).
- 6 Press **FUNC.** to close the menu.

NOTES

- If you changed the language by mistake, follow the mark next to the menu item to change the setting.
- The displays **SET** and **FUNC** that appear in some menu screens refer to the name of buttons on the camcorder and will not change, regardless of the language selected.

Changing the Time Zone

* Default value



T.ZONE/DST NEW YORK*





- 1 Press **FUNC.**.
- 2 Select (**▲▼**) the icon and press (**SET**) to open the setup menus.
- 3 Select (**▲▼**) [DATE/TIME SETUP] and press (**SET**).
- 4 Select (**▲▼**) [T.ZONE/DST] and press (**SET**).
The time zone setting appears. The default setting is New York.
- 5 Select (**▲▼**) your time zone and press (**SET**).
To adjust for daylight saving time, select the time zone with the mark next to the area.
- 6 Press **FUNC.** to close the menu.

Time Zones

Once you have set the time zone, date and time, you do not need to reset the clock every time you travel to another time zone. Select the time zone referring to the date and time displayed on the screen.

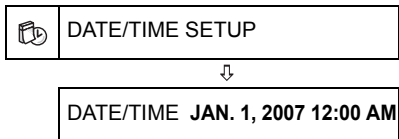
Setting the Date and Time



- 1** Press **[FUNC.]**.
- 2** Select (**▼▲**) the  icon and press (**SET**) to open the setup menus.
- 3** Select (**▼▲**) **[DATE/TIME SETUP]** and press (**SET**).
- 4** Select (**▼▲**) **[DATE/TIME]** and press (**SET**).
The first field of the date will be displayed in orange and indicated with up/down arrows.
- 5** Push the joystick (**▼▲**) to set the date and time and (**◀▶**) to move between the fields of the date and time.
- 6** Press (**SET**) to start the clock.
- 7** Press **[FUNC.]** to close the menu.

IMPORTANT

- When you do not use the camcorder for about 3 months, the built-in rechargeable lithium battery may discharge completely and the date and time setting may be lost. In such case, recharge the built-in lithium battery (📖 109) and set the time zone, date and time again.
- You can also change the date format (📖 51).

Recording

Shooting Video

Before You Begin Recording

Make a test recording first to check if the camcorder operates correctly. Since recordings made on a DVD-R or DVD-R DL disc cannot be deleted, we recommend you use a DVD-RW disc to make the test recordings.



DC50

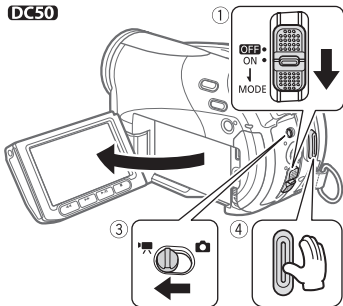

DC220/DC230

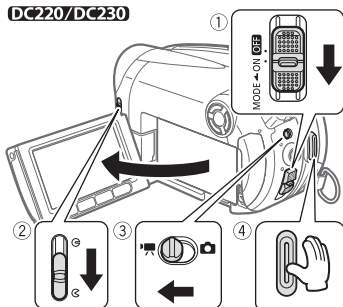

- 1 Move the power switch to ON to set the camcorder in CAMERA mode. The red CAMERA indicator will turn on.

- 2 **DC50** The lens cover will open automatically.
DC220/DC230 Move the lens cover switch down to to open the lens cover.
- 3 Move the switch to the (Movies) position.
- 4 Press to begin recording.
 - The recording starts; press again to pause the recording.
 - The DISC access indicator will flash while recording and will stay on briefly after pausing while the scene is recorded on the disc.

WHEN YOU HAVE FINISHED RECORDING

- 1 Make sure that the DISC access lamp is off.
- 2 Turn off the camcorder.
- 3 Close the lens cover (**DC220/DC230** only) and the LCD panel.
- 4 Remove the disc.

IMPORTANT

Avoid the following actions while the DISC access indicator is on or flashing. Failing to do so may result in permanent data loss.

- Do not subject the camcorder to vibrations or strong impacts.
- Do not open the disc cover and do not remove the disc.
- Do not disconnect the power source or turn off the camcorder.
- Do not change the operating mode.

NOTES

- **About the recording time:** By changing the recording mode you can change the recording time available on the disc (□ 44).
- When recording in bright places it may be difficult to use the LCD screen. In such case, use the viewfinder instead.
- When recording in very loud places (such as fireworks shows or concerts), sound may become distorted or it may not be recorded at the actual levels. This is not a malfunction.

● **About the Power Save mode:** To save power when the camcorder is powered by a battery pack, the camcorder will automatically shut off if left without any operations for 5 minutes (□ 50). To restore the power, slide the power switch toward MODE and release it, or move the power switch to **OFF** and back to ON again.

● **About the LCD and viewfinder screen:** The screens are produced using extremely high-precision manufacturing techniques, with more than 99.99% of the pixels operating to specification. Less than 0.01% of the pixels may occasionally misfire or appear as black, red, blue or green dots. This has no effect on the recorded image and does not constitute a malfunction.

● **When using a tripod:** Do not leave the viewfinder exposed to direct sunlight as it may melt (due to concentration of the light by the lens). Do not use tripods with fastening screws longer than 5.5 mm (0.2 inch). Doing so may damage the camcorder.

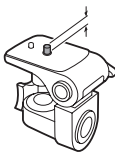

● **When recording movies, try to get a calm, stable picture.**

Excessive camcorder movement while shooting and extensive use of fast zooms and panning can result in fidgety, jittery scenes. In extreme cases, the playback of such scenes may result in visually induced motion sickness. If you experience such a reaction, immediately stop the playback and take a rest break as necessary.

Reviewing the Last Scene Recorded



- 1 If the joystick guide does not appear on screen, press (SET) to display it.
- 2 Push the joystick (◀) toward [CAMERA].
 - If [CAMERA] does not appear on the joystick guide, repeatedly push the joystick (▼) toward [NEXT] to display the joystick guide in the illustration above.

When the mode switch is set to **AUTO**, only one joystick guide will appear.

- The camcorder plays back the last scene (but without sound) and returns to record pause mode.
- While reviewing the scene, select (◀▶) the (↻) icon and press (SET) to return to the recording mode.
- If you are using a DVD-RW disc, you can also delete the scene immediately after recording it. Select (◀▶) the (✂) icon to delete the scene while reviewing it (□ 69).

Selecting the Aspect Ratio of your Recordings (16:9 Widescreen or 4:3)

You can select the aspect ratio of your recording to match your TV. The camcorder uses the full width of the CCD providing high-resolution 16:9 recording.

POINTS TO CHECK



• Default value

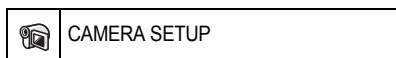

WIDESCREEN **ON** ON*

- 1 Press [FUNC].
- 2 Select (▲▼) the (CAMERA) icon and press (SET) to open the setup menus.
- 3 Select (▲▼) [CAMERA SETUP] and press (SET).
- 4 Select (▲▼) [WIDESCREEN] and press (SET).
- 5 Select (▲▼) a setting option and press (SET).

The default is widescreen (16:9) recordings. Set it to [OFF OFF] to

record movies in the normal (4:3) aspect ratio.

6 Press **[FUNC.]** to close the menu.

i NOTES

- Since the displays on the camcorder have an aspect ratio of 16:9, recordings with a 4:3 aspect ratio will appear in the center of the screen with black sidebars.

- **DC220/DC230** Simultaneous recording of a still image on the memory card cannot be used when recording in widescreen (16:9) mode.

- **DC220/DC230** When recording in widescreen mode, with [IMG STAB] set to [OFF OFF] (□ 46), you can have a wider view angle.

- **Playing back a widescreen recording:** TV sets compatible with the Video ID-1 system will automatically switch to wide (16:9) mode. Otherwise, change the aspect ratio of the TV manually. To play back on a TV with normal aspect ratio (4:3) change the [TV TYPE] setting accordingly (□ 51).

Taking Photos

Before using a memory card for the first time, be sure to initialize it with this camcorder (□ 76).



DC50

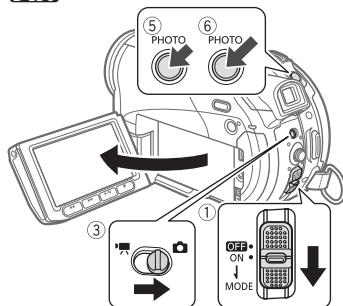

DC220/DC230

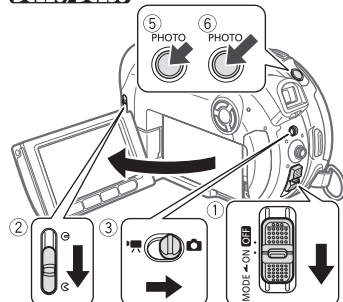



1 Move the power switch to ON to set the camcorder in CAMERA mode.



The red CAMERA indicator will turn on.

2 **DC50** The lens cover will open automatically.

DC220/DC230 Move the lens cover switch down to  to open the lens cover.

- 3 Move the  switch to the  (Still images) position.
- 4 If necessary, change the media for recording the still images.
Refer to *Selecting the Media for the Still Images* (□ 37).
- 5 Press **[PHOTO]** halfway.
 - Once the focus is automatically adjusted,  will turn green and one or more AF frames will appear.
 - **DC50/DC230** When you press **[PHOTO]** on the wireless controller, the still image is recorded immediately.
- 6 Press **[PHOTO]** fully.
The CARD access or DISC access indicator will flash as the still image is being recorded.

! IMPORTANT

Avoid the following actions while the disc/card access display ( or ) appears on screen, and when either the DISC access or CARD access indicator is on or flashing. Failing to do so may result in permanent data loss.

- Do not subject the camcorder to vibrations or strong impacts.
- Do not open the disc cover or the memory card slot cover and do not remove the disc or memory card.
- Do not disconnect the power source or turn off the camcorder.
- Do not change the position of the  switch or the operating mode.













i NOTES





- If the subject is not suitable for autofocus,  turns yellow. Adjust the focus manually (□ 56).
- **DC50** When the subject is too bright, "OVEREXP." starts flashing. In such case, use the optional FS-H37U ND filter.

Selecting the Media for the Photos

You can record still images on the memory card or the disc. The default media for still images is the memory card. As long as you do not change the recording destination, still images will be recorded on the last selected media.



- 1 Press **[FUNC.]**.
(□ 31)
- 2 Select () the  icon and press () to open the setup menus.
- 3 Select () **[SYSTEM SETUP]** and press () .
- 4 Select () **[MEDIA SEL. **] and press () .
- 5 Select () [ **DISC**] or [ **CARD**] and press () to save the setting and close the menu.

When recording, the operating mode symbol will change to  (DISC stills) or  (CARD stills), depending on the media selected. In playback mode, the operating mode symbol will change to  (DISC stills) or  (CARD stills), respectively.

Zooming

POINTS TO CHECK



CAMERA : In addition to the optical zoom, the digital zoom is also available (46).

	DC50	DC220/DC230
Optical zoom	10x	35x
Digital zoom*	200x	1,000x

* **CAMERA** only.

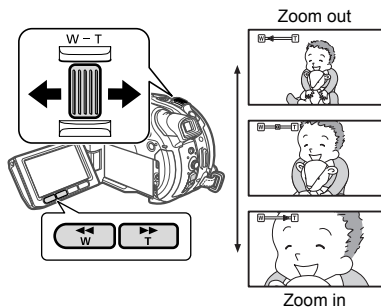

Optical Zoom

Move the zoom lever toward **W** to zoom out (wide-angle). Move it toward **T** to zoom in (telephoto).

You can also change the zoom speed (46). You can select one of three fixed zoom speeds or a variable speed that depends on how you operate the zoom lever: Press gently for a slow zoom; press harder for faster zooms.

NOTES

● **DC50/DC230** You can also use the **T** and **W** buttons on the wireless controller. The zoom speed with the wireless controller will be the same as with the camcorder (when one of the fixed zoom speed levels is selected) or fixed at

[**SPEED 3**] (when [**VARIABLE**] is selected).

- When set to [**VARIABLE**], the zoom speed will be faster in the record pause mode.
- Keep at least 1 m (3.3 ft.) to the subject. At wide-angle, you can focus on a subject as close as 1 cm (0.39 in.).

Quick Start Function

Using the Quick Start function, you'll never have to miss out on those great and fleeting opportunities to take a picture or record video. When you press

[**QUICK START**] instead of turning off the camcorder, you can get it ready to start recording within approx. 1 second.

POINTS TO CHECK



CAMERA : You cannot enter the Quick-Start ready mode while recording.

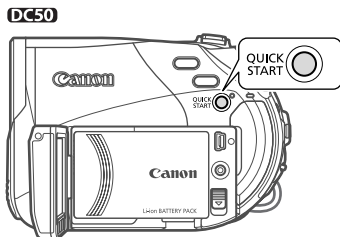

DC220/DC230

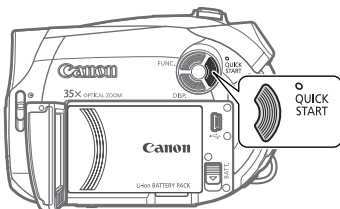

1 Press [**QUICK START**] firmly.

- The standby lamp goes on to signal that the camcorder is Quick-Start ready

- "ready and waiting" to resume recording.
- Sometimes the standby lamp will flash as the camcorder completes some preparations. The camcorder is Quick-Start ready when the lamp stops flashing and stays on.

2 When you wish to resume recording, press QUICK START again.

Within approx. 1 second, the camcorder is ready in record pause mode.

i NOTES

- When you wake up the camcorder from standby mode, the following settings will be changed automatically:
 - Manual focus returns to automatic focus (AF).
 - Manual exposure adjustment returns to automatic exposure.
 - Zoom position returns to full wide angle **W**.
- In standby mode, the camcorder consumes only half the power used in record pause mode. Using this mode you can save energy when using a battery pack.
- The camcorder will shut off if left in the Quick-Start ready mode for 10 minutes, regardless of the [POWER SAVE] setting (50). You can select the length of time until shut-off with the [STANDBY OFF] setting (50). To restore the power if the camcorder shut off, slide the power switch toward MODE and release it, or move the power switch to **OFF** and back to ON again.
- If you perform any of the following actions while in standby mode (while the standby lamp is on), the camcorder will return to record pause mode.
 - Open the disc compartment cover.
 - Slide the power switch toward MODE.
 - Change the position of the **MOVIES/VIDEO** switch.

Playback

Playing Back the Video

POINTS TO CHECK

DC50/DC230 For some operations you can also use the buttons on the wireless controller.



DC50

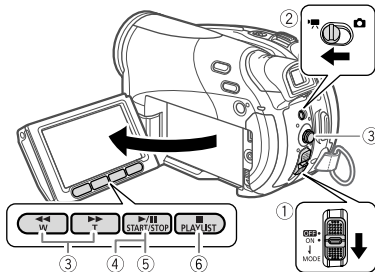

DC220/DC230

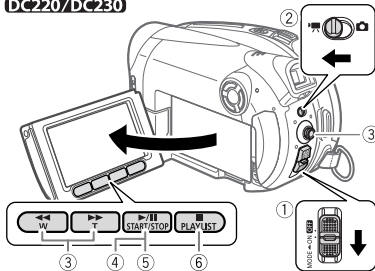

- 1 Move the power switch to ON, then slide it down toward MODE and release it to set the camcorder in PLAY mode.**

The green PLAY indicator will turn on.

- 2 Move the **MOVIES/VIDEO** switch to the **MOVIES** position.**

The scene index screen appears with the selection frame on the first scene.

3 Move (▲▼, ◀▶) the selection frame to the scene you want to play back.

Press ▶▶ or ◀◀ on the camcorder (NEXT or PREV. on the wireless controller) to move to the next/previous index page.

4 Press ▶|| to begin the playback.

The playback will start from the scene selected and continue until the end of the last scene recorded.

DURING PLAYBACK

5 Press ▶|| again to pause the playback.

6 Press ■ to stop the playback and return to the scene index screen.

i NOTES

- During the playback of a DVD-R DL (dual-layered) disc, you might notice a brief stop (approx. 1 second) at the point where the playback switches from Layer 1 to Layer 2.
- You can display the date and time of the recording and other camcorder data registered when the recording was made (□ 63).



TO ADJUST THE VOLUME

The camcorder plays the sound with the built-in speaker. The sound will be muted when you close the LCD panel or connect the stereo video cable to the AV terminal. During the playback of a scene:

1 If the joystick guide does not appear on screen, press (SET) to display it.

2 Push the joystick (▲▼) toward || or || to adjust the volume.

- To turn off the volume completely, keep pressing (▼) until the volume icon changes to .
- You can press (SET) again to hide the joystick guide during playback.

SPECIAL PLAYBACK MODES

● Fast Playback

During normal playback, press ▶▶ or ◀◀ on the camcorder ((SEARCH ▶▶) or ◀◀SEARCH) on the wireless controller*). Repeatedly press the button to increase the playback speed.

Fast playback: 5x → 15x → 25x
the normal speed.

● Slow Playback

During playback pause, press ▶▶ or ◀◀ on the camcorder ((SLOW ▶▶) or ◀◀SLOW) on the wireless controller*). Repeatedly press the button to increase the playback speed.

Slow playback: 1/16 → 1/8 → 1/4
the normal speed.

● Skipping Scenes

During playback, push the joystick (▶) or press NEXT on the wireless controller* to skip to the next scene. Push the joystick (◀) or press PREV. on the wireless controller* to skip to the beginning of the current scene. Push the joystick (◀) twice or press PREV. twice to skip to the previous scene.



Note that you do not have to display the joystick guide above to skip the scene.

* The wireless controller is not included with the **DG20**.

i NOTES

- There is no sound during special playback modes.
- During some special playback modes, you may notice some video problems (blocky video artifacts, banding, etc.) in the playback picture.
- Slow playback is not available with discs initialized in VIDEO mode.

- Depending on the recording, you might occasionally notice a brief stop of the picture or sound at the point where the scene changes.

Displaying the Photos



DC50

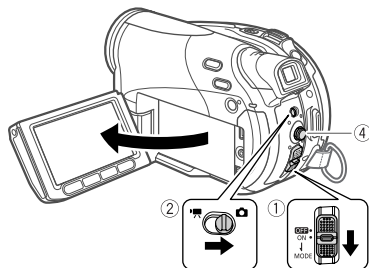

DC220/DC230

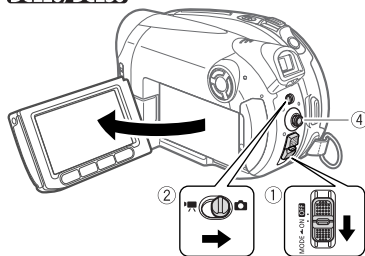

- 1 Move the power switch to ON, then slide it down toward MODE and release it to set the camcorder in PLAY mode.**
The green PLAY indicator will turn on.
- 2 Move the switch to the (Still images) position.**
- 3 If necessary, change the media for the still images.**
Refer to *Selecting the Media for the Photos* (□ 37).

4 Use the joystick (◀▶) to move between images.

! IMPORTANT

- The following may not be displayed correctly.
 - Images not recorded with this camcorder.
 - Images edited on or uploaded from a computer.
 - Images whose file names have been changed.
- Avoid the following actions while the disc/card access display (▶ or ▶) appears on screen, and when either the DISC access or CARD access indicator is on or flashing. Failing to do so may result in permanent data loss.
 - Do not subject the camcorder to vibrations or strong impacts.
 - Do not open the disc cover or the memory card slot cover and do not remove the disc or memory card.
 - Do not disconnect the power source or turn off the camcorder.
 - Do not change the position of the / switch or the operating mode.

Slideshow

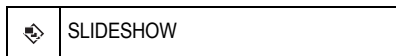

- 1 Press **FUNC.****
(□ 31)
- 2 Select (▲▼) [SLIDESHOW] and press (SET).**
- 3 Select (◀▶) [START] and press (SET).**
 - Images are played back one after another.
 - Press **FUNC.** to stop the slideshow.

Index Screen

- 1 Move the zoom lever toward **W**.**
The still images index screen appears.
- 2 Select (▲▼, ◀▶) an image.**

- Move the green selection frame to the image you want to view.
- If you have a lot of still images, you may find it easier to browse entire index pages instead. Move the zoom lever toward **W** to extend the green selection frame to the whole page, and move (◀▶) between index pages. Move the zoom lever toward **T** to return to moving between single images.

3 Move the zoom lever toward **T**.

The index screen closes and the selected image is displayed.

Image Jump Function

You can also quickly locate a specific image without having to browse all of them one by one.



To RUN THROUGH THE STILL IMAGES

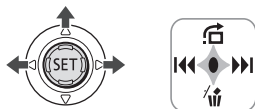

Push the joystick (◀) or (▶) and hold it pressed down to run quickly through the still images.

To SKIP 10 OR 100 STILL IMAGES



- 1 If the joystick guide does not appear on screen, press (SET) to display it.
- 2 Push the joystick (▲) toward .
- 3 Select (▲▼) [ JUMP 10 IMAGES] or [ JUMP 100 IMAGES].
- 4 Jump (◀▶) the number of images selected.

Press (SET) to close the image jump screen and display the image. You can press (SET) again to hide the joystick guide.

Magnifying Photos during Playback

During playback, still images can be magnified up to 5 times.

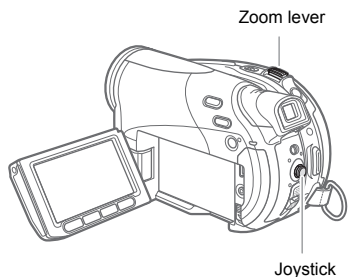

1 Move the zoom lever toward **T**.

- The image is magnified by 2 times and a frame appears indicating the position of the magnified area.
- To further enlarge the image, move the zoom lever toward **T**. To reduce the magnification to less than 2 times, move the zoom lever toward **W**.
-  will appear for images that cannot be enlarged.

2 Select the part of the image to be magnified with the joystick.

- Move (▲▼, ◀▶) the frame to the part of the image you want to see enlarged.
- To cancel the magnification, move the zoom lever toward **W** until the frame disappears.

Menu Options Lists

Menu items not available appear grayed out in the FUNC. menu or in black in the setup menus. For details about how to select an item, refer to *Using the Menus* (□ 31).

FUNC. Menu

Recording programs (□ 52)



Mode switch: P

[P PROGRAM AE],

[Tv SHUTTER-PRIO. AE],

[Av APERTURE-PRIO. AE]*,

Special scene recording programs:

[P] PORTRAIT, [S] SPORTS,

[N] NIGHT, [S] SNOW, [B] BEACH,

[SUNSET], [A] SPOTLIGHT,

[FIREWORKS]

* Available only with the DC50.

DC50 Light metering mode (□ 61)



Mode switch: P

[EVALUATIVE],

[CENT.WEIGHT.AVERAGE],

[SPOT]

White balance (□ 57)



Mode switch: P

[AUTO], [DAYLIGHT],

[SHADE]*, [CLOUDY]*,

[TUNGSTEN],

[FLUORESCENT]*,

[FLUORESCENT H]*, [SET]

* Available only with the DC50.

Image effect (□ 58)



Mode switch: P

[OFF IMAGE EFFECT OFF],
[VIVID], [NEUTRAL],
[LOW SHARPENING]*,
[SOFT SKIN DETAIL],
[CUSTOM]*

* Available only with the DC50.

DC50/DC230 Drive mode (□ 62)



Mode switch: P

[SINGLE], [CONT.SHOOT.],

[HISPEED CONT.SHOOT.],

[AEB]

Digital effects (□ 66)



Mode switch: P

[D.EFFECT OFF], [FADE-T],

[WIPE], [BLK&WHT],

[SEPIA], [ART], [MOSAIC]



Mode switch: P

[D.EFFECT OFF], [BLK&WHT],

[SEPIA]

Recording mode



[**XP** HIGH QUALITY],
 [**SP** STANDARD PLAY], [**LP** LONG PLAY]

The table below gives the approximate recording times with a brand new DVD disc (on a single recording side).

Recording Mode	Disc Type	
	DVD-R, DVD-RW	DVD-R DL
XP	20 min.	36 min.
SP	30 min.	54 min.
LP	60 min.	108 min.

● **Recording in LP mode gives you a longer recording time; however, depending on the condition of the disc (long usage, imperfections, etc.) the picture and sound recorded in LP mode may be distorted. We recommend using the XP or SP mode for important recordings.**

● The camcorder uses a variable bit rate (VBR) when encoding the video data so the actual recording times will vary depending on the content of the scenes.

Still image size/quality

(60)



DC50 Size:

[**L** 2592x1944], [**M** 2048x1536],
 [**S** 640x480]

DC230 Size:

[**L** 1152x864], [**S** 640x480]

DC220 Size:

[**L** 1024x768], [**S** 640x480]

Quality:

[**▲** SUPER FINE], [**▲** FINE],
 [**▲** NORMAL]

Still image simultaneous recording

(60)



DC50

[WIDESCREEN] set to [**ON** ON]:

[**OFF** STILL I.REC OFF],
 [**▲** FINE/1280x720],
 [**▲** NORMAL/1280x720]

[WIDESCREEN] set to [**OFF** OFF]:

[**OFF** STILL I.REC OFF],
 [**▲** FINE/1152x864],
 [**▲** NORMAL/1152x864]

DC230

[**OFF** STILL I.REC OFF],
 [**▲** FINE/1024x768],
 [**▲** NORMAL/1024x768]

DC220

[**OFF** STILL I.REC OFF],
 [**▲** FINE/640x480],
 [**▲** NORMAL/640x480]

ADD TO PLAYLIST

(68)



Disc type: **(RW)** • VR mode
 [ALL SCENES], [ONE SCENE],
 [CANCEL]

Add a scene to the playlist. This option is available only from the original index screen.

MOVE

(69)



Disc type: **(RW)** • VR mode
 Move a scene in the playlist. This option is available only from the playlist index screen.

DIVIDE (☞ 70)



Disc type: **(-RW)** • VR mode
Divide a scene.

DELETE (☞ 69)



Disc type: **(-RW)** • VR mode
Delete a scene.

CONVERT TO SCENE (☞ 74)



Convert a single still image into a 3-second Photomovie scene.

COPY [☞ → ☞] (☞ 74)



Copy a single still image from the memory card to the disc.

COPY [☞ → ☞] (☞ 74)



Copy a single still image from the disc to the memory card.

SLIDESHOW (☞ 41)



[CANCEL], [START]

PROTECT (☞ 75)



Press **(SET)** to enter the image selection screen. From that screen, you can continue to select the still images you want to protect.

PRINT ORDER (☞ 96)



Press **(SET)** to enter the image selection screen. From that screen, you can continue to select the still images for which you want to set print orders.

TRANSFER ORDER (☞ 91)



Press **(SET)** to enter the image selection screen. From that screen, you can continue to select the still images you want to mark with a transfer order.

Setup Menus

CAMERA SETUP

A.SL SHUTTER



Mode switch: **AUTO** or **P** (only in the [P PROGRAM AE] recording program)
[ON] ON, [OFF] OFF

The camcorder automatically uses slow shutter speeds to obtain brighter recordings in places with insufficient lighting.

- The camcorder uses shutter speeds down to 1/30 (1/15 when recording still images).

- **DC50** In **CAMERA** mode, set the flash mode to (flash off).

- If a trailing afterimage appears, set the slow shutter to [**OFF** OFF].

- If (camcorder shake warning) appears, we recommend stabilizing the camcorder, for example, by mounting it on a tripod.

D.ZOOM



DC50

[**OFF** OFF], [**40x** 40X], [**200x** 200X]

DC220/DC230

[**OFF** OFF], [**105x** 105X], [**1000x** 1000X]

Determines the operation of the digital zoom.

- When activated, the camcorder will switch automatically to the digital zoom when you zoom in beyond the optical zoom range.

- With the digital zoom the image is digitally processed, so the image resolution will deteriorate the more you zoom in.

- About the color of the zoom indicator:

Zoom Indicator	Optical Zoom	Digital Zoom	
	White	Light blue	Dark blue
DC50	10x	10x - 40x	40x - 200x
DC220/DC230	35x	35x - 105x	105x - 1000x

- The digital zoom cannot be used with the [NIGHT] recording program.

ZOOM SPEED



[**VAR** VARIABLE], [**>>>** SPEED 3], [**>>** SPEED 2], [**>** SPEED 1]

- When set to [**VAR** VARIABLE] the zoom speed depends on how you operate the zoom lever: Press lightly for a slow zoom; press harder for faster zooms.

- The fastest zoom speed can be achieved with [**VAR** VARIABLE]. Among the fixed zoom speeds, [**>>>** SPEED 3] is the fastest and [**>** SPEED 1] the slowest.

IMG STAB



* **CAMERA** mode : Only with the **DC50**.
Mode switch: **P**

[**ON** ON], [**OFF** OFF]

The image stabilizer compensates for camcorder shake even at full telephoto.

- The image stabilizer is designed to compensate for a normal degree of camcorder shake.

- **DC220/DC230** The image stabilizer may not be effective when recording in dark places using the [NIGHT] recording program.

- **DC220/DC230** The image stabilizer may not be effective when using a slow shutter speed with the [Tv SHUTTER-PRIO. AE] recording program.

- The image stabilizer cannot be turned off when the mode switch is set to **AUTO**.

- We recommend setting the image stabilizer to [**OFF** OFF] when using a tripod.

DC50
AF AST LAMP (☞ 65)



[**A** **AUTO**], [**OFF** **OFF**]

FOCUS PRI. (☞ 61)



Mode switch: **P**

[**ATA** **ON:AiAF**], [**☐** **ON:CENTER**],
[**OFF** **OFF**]

DC50
ND



Mode switch: **P**

[**A** **AUTO**], [**OFF** **OFF**]

Will automatically activate the ND (neutral density) filter in surroundings that are too bright.

- The ND filter cannot be turned off when the mode switch is set to **AUTO**.

REVIEW



[**OFF** **OFF**], [**2sec** **2 sec**],

[**4sec** **4 sec**], [**6sec** **6 sec**],

[**8sec** **8 sec**], [**10sec** **10 sec**]

Selects the time to display a still image after it has been recorded on the memory card.

- You can erase (☞ 73) the still image while you are reviewing it (or immediately after recording it, if set to [**OFF** **OFF**]).
- This menu item will not be available when the drive mode (☞ 62) is set to (continuous shooting), (high-speed continuous shooting) or (auto exposure bracketing).

WIDESCREEN (☞ 35)



[**ON** **ON**], [**OFF** **OFF**]

SELF TIMER (☞ 66)



[**ON** **ON**], [**OFF** **OFF**]

WIND SCREEN



Mode switch: **P**

[**A** **AUTO**], [**OFF** **OFF**]

The camcorder automatically reduces the background sound of wind when recording outdoors.

- The wind screen cannot be turned off when the mode switch is set to **AUTO**.
- Some low-frequency sounds will be suppressed along with the sound of wind. When recording in surroundings unaffected by wind or if you want to record low-frequency sounds, we recommend setting the wind screen to [**OFF** **OFF**].

DISC OPERATIONS

DISC INFO



Displays a screen where you can verify the details regarding the disc.

- The disc information includes the disc title, the disc type (DVD-R, DVD-R DL or DVD-RW), the disc specification (VIDEO mode or VR mode), and icons that indicate if the disc is finalized () or protected ().

DISC INITIALIZE (71)

Disc type: **(-RW)**
[VIDEO], [VR], [CANCEL]

FINALIZE (77)

[NO], [YES]

UNFINALIZE (79)

Disc type: **(-RW)** • VIDEO mode • Finalized
[NO], [YES]

MOVIES ALL DEL (70)

Disc type: **(-RW)** • VR mode
[NO], [YES]

This option is available only in the original index screen.

PLAYLIST ALL DEL (70)

Disc type: **(-RW)** • VR mode
[NO], [YES]

This option is available only in the playlist index screen.

DISC PROTECT (71)

Disc type: **(-RW)** • VR mode
[NO], [YES]

PHOTOMOVIE (75)

[NO], [YES]

DISC TITLE (72)**STILL IMG OPER.****ORD.ALL ERASE** (97)

[NO], [YES]

ORD.ALL ERASE (92)

[NO], [YES]

ERASE ALL IMAGES (73)

[NO], [YES]

CARD INITIALIZE (76)

[INITIALIZE], [COMPL.INIT.], [CANCEL]

ALL COPY [] → [] (74)

[NO], [YES]

ALL COPY [] → [] (74)

[NO], [YES]

DISPLAY SETUP

BRIGHTNESS



Adjusts the brightness of the LCD screen.

- Use the joystick (◀▶) to adjust the brightness to your preference.
- Changing the brightness of the LCD screen does not affect that of the viewfinder or the recordings.

LCD MIRROR



[**ON** ON], [**OFF** OFF]

When the LCD panel is rotated 180 degrees to face the subject, most screen displays will disappear and the image displayed will be as if the subject was looking at a mirror.

TV SCREEN



[**ON** ON], [**OFF** OFF]

When set to [**ON** ON], the camcorder's on-screen displays will appear also on the screen of a connected TV or monitor.

DATA CODE

(64)



[DATE], [TIME], [DATE & TIME],
[CAMERA DATA]

MARKERS



[**OFF** OFF], [LEVEL(WHT)],
[LEVEL(GRY)], [GRID(WHT)],
[GRID(GRY)]

You can display a grid or a horizontal line at the center of the screen. The markers are available in white or gray. Use the markers as a reference to make sure your subject is framed correctly (vertically and/or horizontally).

- Using the markers will not affect the recordings on the disc or memory card.

LANGUAGE

(32)



[DEUTSCH], [**ENGLISH**], [ESPAÑOL],
[FRANÇAIS], [ITALIANO], [POLSKI],
[ROMÂNĂ], [TÜRKÇE], [РУССКИЙ],
[УКРАЇНСЬКА], [العربية], [فارسی],
[ภาษาไทย], [简体中文], [繁體中文], [한국어],
[日本語]

SYSTEM SETUP

MEDIA SEL. (37)



[CARD], [DISC]

DC50/DC230
WL.REMOTE



[**ON ON**], [**OFF OFF**]

Allows the camcorder to be operated with the wireless controller.

VOLUME (40)



BEEP



[**HIGH VOLUME**],
[**LOW VOLUME**], [**OFF OFF**]

A beep will accompany some operations like turning on the camcorder, the self-timer countdown, etc. It also serves as a warning beep under unusual conditions.

POWER SAVE



[**ON ON**], [**OFF OFF**]

In order to save power when the camcorder is powered by a battery pack, it will automatically shut off if left without any operation for 5 minutes.

- Approximately 30 seconds before the camcorder shuts off, the message "⚠️ AUTO POWER OFF" will appear.

- In Quick-Start ready mode, the camcorder will shut off after the time selected for the [STANDBY OFF] setting.

[STANDBY OFF] (38)



[**10min 10 min**], [**20min 20 min**],
[**30min 30 min**]

Select the length of time after which the camcorder will end the Quick-Start ready mode and shut off automatically.

FILE NOS.



[RESET], [CONTINUOUS]

Select the image numbering method to be used on a new memory card or disc.

Images are automatically assigned consecutive image numbers from 0101 to 9900, and stored in folders containing up to 100 images. Folders are numbered from 101 to 998.

[RESET]: Image numbers will restart from 101-0101 every time you insert a new memory card or disc.

[CONTINUOUS]: Image numbers will continue from the number following that of the last image recorded with the camcorder.

- If the recording media you insert already contains an image with a larger number, a new image will be assigned a number one higher than that of the last image on the memory card or disc.

- We recommend using the [CONTINUOUS] setting.

- The setting is common to the memory card and the disc.

TV TYPE



[**4:3** NORMAL TV], [**16:9** WIDE TV]

In order to display the picture in full and in the correct aspect ratio, select the setting according to the type of television to which you will connect the camcorder.

[**4:3** NORMAL TV]: TV sets with 4:3 aspect ratio.

[**16:9** WIDE TV]: TV sets with 16:9 aspect ratio.

● When the TV type is set to [**4:3** NORMAL TV], if you play back a recording made in widescreen (16:9) the picture displayed on the LCD screen will be smaller than the full display area.

FIRMWARE



You can verify the current version of the camcorder's firmware. This menu option is usually grayed out.

DATE/TIME SETUP



T.ZONE/DST ([] 32)

DATE/TIME ([] 33)

DATE FORMAT

[Y.M.D (2007.1.1 AM 12:00)],
[M.D,Y (JAN. 1, 2007 12:00 AM)],
 [D.M.Y (1.JAN.2007 12:00 AM)]

Changes the date format for on-screen displays and for date printing.

DC50

LINE-IN MODE

→ **LINE-IN MODE** ([] 82)



Press (**SET**) to enter the video input screen.

Using the Recording Programs



AUTO

The camcorder adjusts the focus, exposure and other settings automatically, allowing you to just point and shoot.



P : Flexible Recording Programs

[P PROGRAM AE]
(□ 53)

[Tv SHUTTER-PRIO. AE]
(□ 53)

[Av APERTURE-PRIO. AE]*
(□ 53)

Special Scene Recording Programs:

[👤 PORTRAIT]

The camcorder uses a large aperture, achieving a focus on the subject while blurring other distracting details.



[🎿 SNOW]

Use this mode to record in bright ski resorts. It prevents the subject from being underexposed.



[🎤 SPOTLIGHT]

Use this mode to record spotlit scenes.



[🎾 SPORTS]

Use this mode to record sports scenes such as tennis or golf.



[🏖️ BEACH]

Use this mode to record on a sunny beach. It prevents the subject from being underexposed.



[🎆 FIREWORKS]

Use this mode to record fireworks.



[🌙 NIGHT]

Use this mode to record in dimly lit places.



[🌅 SUNSET]

Use this mode to record sunsets in vibrant colors.



* Available only with the
DC50.

P Flexible Recording: Changing the Aperture and Shutter Speed

Use the automatic exposure (AE) program or give priority to the exposure value or the shutter speed.



POINTS TO CHECK



(12)

Mode switch: P



Options

• Default value

[P PROGRAM AE]*

The camcorder automatically adjusts the aperture and shutter speed to obtain the optimal exposure for the subject.

[Tv SHUTTER-PRIO.AE]

Set the shutter speed value. The camcorder automatically sets the appropriate aperture value. Use a high shutter speed to record fast moving subjects or a slow shutter speed to add a certain motion blur, emphasizing the feel of movement.

[DC50] [Av APERTURE-PRIO.AE]

Set the aperture value. The camcorder automatically sets the appropriate shutter speed. Use low aperture values (larger lens opening) to softly blur the background in a portrait or high aperture values (smaller lens opening) to get a wider depth of field, giving a sharp focus all throughout a landscape.

FUNC.
(31)

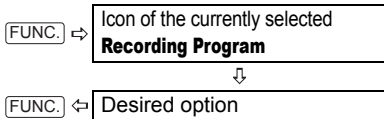

TO SET THE SHUTTER SPEED OR APERTURE VALUE

When you select [Tv SHUTTER-PRIO.AE] or [Av APERTURE-PRIO.AE], a numeric value will appear next to the recording program icon.

1 If the joystick guide appears on the screen, press (SET) to hide it.

When the numeric value can be adjusted, small arrows will appear next to the number.

2 Adjust (▲▼) the numeric value (shutter speed or aperture value).

The number displayed will flash if the aperture or shutter speed is not appropriate for the recording conditions. In such case, select a different value.

i NOTES

- Do not change the position of the mode switch while recording, as the brightness of the image may change abruptly.
- [Tv SHUTTER-PRIO.AE]
 - If you use a slow shutter speed in dark places, you can obtain a brighter image, but the image quality may be lower, and the autofocus may not work well.
 - The image may flicker when recording with high shutter speeds.
 - **Recording movies under fluorescent lights:** If the screen starts to flicker, select [Tv SHUTTER-PRIO.AE] and set the shutter speed to 1/100.

Shutter speed guidelines

	1/8, 1/15, 1/30
	1/2, 1/4, 1/8, 1/15, 1/30
For recording subjects in dark places.	
	1/60
	1/60
For general recordings.	
	1/100
	1/100
For recording indoor sports scenes.	
	1/250, 1/500, 1/1000
	1/250, 1/500, 1/720*
For recording from within a car or train, or for recording moving subjects such as roller coasters.	
* DC50 only.	

Note that on screen only the denominator is displayed – “Tv 250” indicates a shutter speed of 1/250 second, etc.

DC50 Available Aperture Values

The actual range of values available for selection will vary depending on the initial zoom position.

	[1.8], [2.0], [2.4], [2.8], [3.4], [4.0], [4.8], [5.6], [6.7], [8.0]
	[2.8], [3.4], [4.0], [4.8], [5.6], [6.7], [8.0]

Special Scene: Recording Programs to Match Special Conditions

Recording in a very bright ski resort or capturing the full colors of a sunset or a fireworks display becomes as easy as selecting a special scene recording program.

POINTS TO CHECK



Mode switch: **P**



FUNC. →

Icon of the currently selected **Recording Program**



Last icon on the right (icon of the currently selected **Special Scene**)



FUNC. ←

Desired option

NOTES

- Do not change the position of the mode switch while recording, as the brightness of the image may change abruptly.
- [] PORTRAIT]/[] SPORTS]/[] BEACH]/[] SNOW]
 - The picture may not appear smooth during playback.
- [] PORTRAIT]
 - The blur effect of the background increases the more you zoom in (**T**).
- [] NIGHT]
 - Moving subjects may leave a trailing afterimage.
 - Picture quality may not be as good as in other modes.

- White points may appear on the screen.
- Autofocus may not work as well as in other modes. In such case, adjust the focus manually.

● [SNOW]/[BEACH]

- The subject may become overexposed on cloudy days or in shaded places. Check the image on the screen.

● [FIREWORKS]

- To avoid camcorder shake, we recommend using a tripod. Make sure to use a tripod especially in [CAMERA] , as the shutter speed slows down.

Adjusting the Picture: Exposure, Focus and Color

Manual Exposure Adjustment

At times, backlit subjects may appear too dark (underexposed) or subjects under very strong lights may appear too bright or glaring (overexposed). To correct this, you can manually adjust the exposure.





POINTS TO CHECK

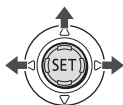

(12)

Mode switch: **P** (except for the [FIREWORKS] recording program).



- 1 If the joystick guide does not appear on screen, press (SET) to display it.**
- 2 Push the joystick (▲) toward [EXP].**
 - If [EXP] does not appear on the joystick guide, repeatedly push the joystick (▼) toward [NEXT] to display the joystick guide in the illustration above.
 - The exposure adjustment indicator  and the neutral value "±0" appear on the screen.
 - If you operate the zoom during exposure lock, the brightness of the image may change.
- 3 Adjust (◀▶) the brightness of the image as required.**
 - The adjustment range and the length of the exposure adjustment indicator will vary depending on the brightness of the picture at the time you locked the exposure.
 - Pushing the joystick (▲) toward [EXP] again will cancel the exposure lock and return the camcorder to automatic exposure.

Manual Focus Adjustment

Autofocus may not work well on the following subjects. In such case, focus manually.

Reflective surfaces



Subjects with low contrast or without vertical lines



Fast Moving Subjects



Through wet windows



Night Scenes



POINTS TO CHECK



Adjust the zoom before you start the procedure.

Mode switch: **P**

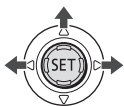

1 If the joystick guide does not appear on screen, press (SET) to display it.

2 Push the joystick (▲) toward [FOCUS].

- If [FOCUS] does not appear on the joystick guide, repeatedly push the joystick (▼) toward [NEXT] to display the joystick guide in the illustration above.
- "MF" appears.

3 Adjust (◀▶) the focus as required until the image appears focused.

- Push the joystick (▶) toward ▲ for a farther focal distance or push it (◀) toward ♀ for a closer focal distance.
- Pushing the joystick (▲) toward [FOCUS] again will return the camcorder to autofocus.

NOTES

- The camcorder will automatically return to autofocus when you set the mode switch to **AUTO**.
- Readjust the focus when you have turned off the camcorder.

Infinity Focus

Use this function when you wish to focus on faraway subjects such as mountains or fireworks.

POINTS TO CHECK



Adjust the zoom before you start the procedure.

Mode switch: **P**

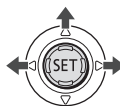

1 If the joystick guide does not appear on screen, press (SET) to display it.

2 Keep the joystick pushed (▲) toward [FOCUS] for more than 2 seconds.

- ∞ appears.
- Pushing the joystick (▲) toward [FOCUS] again will return the camcorder to autofocus.

NOTES

If you operate the zoom or the joystick (◀▶) during infinity focus, ∞ changes to "MF" and the camcorder returns to manual focusing mode.

White Balance

The white balance function helps you accurately reproduce colors under different lighting conditions so that white objects will always look truly white in your recordings.

POINTS TO CHECK



Mode switch: P

Options

* Default value

[AUTO]*
Settings are automatically set by the camcorder. Use this setting for outdoor scenes.
[DAYLIGHT]
For recording outdoors on a bright day.
DC50 [SHADE]
For recording in shaded places.
DC50 [CLOUDY]
For recording on a cloudy day.
[TUNGSTEN]
For recording under tungsten and tungsten type (3-wavelength) fluorescent lighting.
DC50 [FLUORESCENT]
For recording under warm white, cool white or warm white type (3-wavelength) fluorescent lighting.
DC50 [FLUORESCENT H]
For recording under daylight or daylight type (3-wavelength) fluorescent lighting.
[SET]
Use the custom white balance setting to make white subjects appear white under colored lighting.

FUNC.
(31)

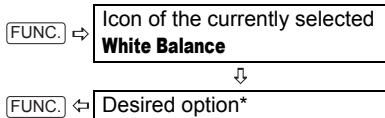

* When you select [SET], do not press [FUNC.] and continue instead with the procedure below.

TO SET THE CUSTOM WHITE BALANCE

- 1 Point the camcorder at a white object, zoom in until it fills the whole screen and press (SET).**
When the adjustment is completed, [] stops flashing and stays on. The camcorder retains the custom setting even if you turn off the camcorder.
- 2 Press [FUNC.] to save the setting and close the menu.**

NOTES

- Depending on the type of fluorescent light, optimal color balance may not be obtained with [FLUORESCENT] or [FLUORESCENT H]. If the color looks unnatural, adjust it using [AUTO] or [SET].
- **When you have set the custom white balance:**
 - Depending on the light source, [] may keep flashing. The result will still be better than with [AUTO].
 - Reset the white balance when the lighting condition changes.
 - Turn off the digital zoom.
- The camcorder retains the custom white balance setting even if you turn it off.
- Custom white balance may provide better results in the following cases:
 - Changing lighting conditions
 - Close-ups
 - Subjects in a single color (sky, sea or forest)
 - Under mercury lamps and certain types of fluorescent lights

Image Effects

You can use the image effects to change the color saturation and contrast to record images with special color effects.

POINTS TO CHECK

CAMERA **CAMERA** | **PLAY** **PLAY** (12)

Mode switch: **P**

Options

* Default value

[OFF IMAGE EFFECT OFF]*
Records with no image enhancing effects.
[VIVID]
Emphasizes the contrast and color saturation.
[NEUTRAL]
Tones down the contrast and color saturation.
DC50 [s LOW SHARPENING]
Records subjects with softened outlines.
[sD SOFT SKIN DETAIL]
Softens the details in the skin tone area for a more complimentary appearance. To obtain the best effect, use this setting when recording a person in close-up. Note that areas similar to the skin color may lack in detail.
DC50 [C CUSTOM]
Allows you to adjust the brightness, contrast, sharpness, and color depth of the image.
[COL.DEPTH]: (–) Shallower colors, (+) Richer color tonality
[BRIGHTN.]: (–) Darker picture, (+) Brighter picture
[CONTRAST]: (–) Flatter picture, (+) More defined light and shade
[SHARPNESS]: (–) Vaguer outlines, (+) Sharper outlines

FUNC.

(31)



FUNC. → Icon of the currently selected **Image Effect**



FUNC. ← Desired option*

* When you select [C CUSTOM], do not press FUNC. and continue instead with the procedure below.

DC50 To SET THE CUSTOM IMAGE EFFECT

- 1 Press (SET) and select (▲▼) the custom setting options.
- 2 Adjust (◀▶) each setting as desired and then press (SET).
- 3 Press FUNC. to save the setting and close the menu.

Still Image Recording Options



(12)

Selecting the Size and Quality of Still Images

Still images are recorded on the memory card or the disc using the JPEG (Joint Photographic Experts Group) compression. As a general rule select a larger image size for higher quality.

Options

Image size options vary depending on the model. The following tables summarize the approximate numbers of still images that can be recorded on different medias by image size/quality.

Approximate number of still images on a memory card

Memory Card	32 MB			128 MB			512 MB		
Image Quality ¹ → Image Size ↓									
L 2592x1944 ²	5	10	25	35	55	105	145	215	435
L 1152x864 ³	40	65	130	185	280	545	735	1,115	2,155
L 1024x768 ⁴	55	80	165	235	345	695	940	1,370	2,745
M1 2048x1536 ²	10	20	40	55	85	175	235	350	700
S 640x480	140	200	365	585	850	1,530	2,320	3,355	6,040

Approximate number of still images on a disc

Disc Type/ Disc Specification	DVD-R or DVD-RW VIDEO mode			DVD-R DL VIDEO mode			DVD-RW VR mode		
Image Quality ¹ → Image Size ↓									
L 2592x1944 ²	415	625	1,245	755	1,220	2,265	420	635	1,265
L 1152x864 ³	2,100	3,185	6,150	3,815	5,795	9,999	2,135	3,240	6,255
L 1024x768 ⁴	2,690	3,910	7,830	4,890	7,115	9,999	2,735	3,980	7,965
M1 2048x1536 ²	670	1,000	2,000	1,220	1,820	3,640	680	1,015	2,035
S 640x480	6,625	9,570	9,999	9,999	9,999	9,999	6,740	9,735	17,525 ⁵

¹ : [SUPER FINE], : [FINE], : [NORMAL]

² DC50 only. ³ DC230 only. ⁴ DC220 only.

⁵ This is the number of images that can be recorded on the disc. However, the maximum number of remaining still images displayed on the screen will be 9999.

* Default value with the **DC450**

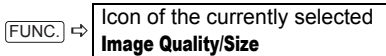
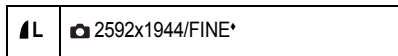

Desired image size*

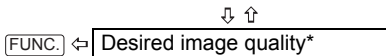
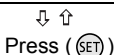

* The number displayed on the right corner indicates the approximate number of images that can be recorded with the current quality/size setting.

i NOTES

- Depending on the number of images on the memory card or disc (Windows: more than 1,800 images; Macintosh: more than 1,000 images), you may not be able to download images to a computer. Try using a card reader to download the still images recorded on the memory card.
- Connection to a PictBridge compatible printer will not work when the memory card contains more than 1,800 images. For best performance, we recommend keeping the number of images on the memory card under 100.

Capturing a Still Image while Recording Movies

While you are recording a movie on the disc you can simultaneously capture the same picture as a still image on the memory card. The size of the still image cannot be changed but the image quality can be selected.



* Default value

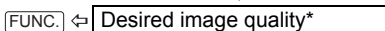
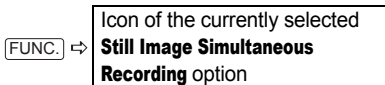
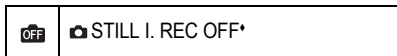

* The number displayed on the right corner indicates the approximate number of images that can be recorded with the current quality/size setting.

TO CAPTURE THE STILL IMAGE

While you are recording a movie, press **PHOTO**.

The still image is recorded on the memory card while the screen continues to show the video recording.

i NOTES

- The still image cannot be recorded simultaneously on the disc.
- The still image cannot be recorded on the memory card while a digital effect is activated.
- **DC220/DC230** The still image also cannot be recorded on the memory card while recording in widescreen mode.
- To record still images we recommend using the **CAMERA** mode, which offers the best quality for still images.

Automatic Focus Priority

When the focus priority is activated, the camcorder records a still image only after the focus has been adjusted automatically.

POINTS TO CHECK



Mode switch at **AUTO**:

The focus priority cannot be turned off.

Mode switch at **P**:

You can turn off the focus priority and you can also select the AF (autofocus) frame to be used.

Options

* Default value

<p>[ON:AIAF]* (Mode switch: P*, AUTO)</p> <p>Depending on the shooting conditions, one or more AF frames out of the nine frames available are automatically selected and the focus is fixed on them.</p>
<p>[ON:CENTER] (Mode switch: P*)</p> <p>The focus is automatically fixed to the center AF frame. This is convenient for making sure the focus is exactly where you want it. In this mode, a single focusing frame appears in the center of the screen.</p>
<p>[OFF]</p> <p>Select this option if you wish to record a still image as soon as you press [PHOTO].</p>

* Except for the **[FIREWORKS]** recording program.

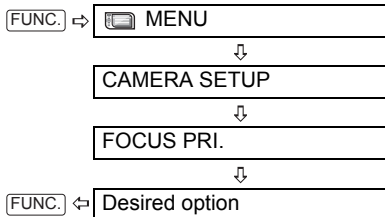

NOTES

In the **[FIREWORKS]** recording program the focus priority is automatically set to **[OFF]**.

DC50 Light Metering Mode

The camcorder measures the light reflected from the subject in order to calculate the optimal exposure settings. Depending on the subject, you may want to change the way the light is measured and evaluated.

POINTS TO CHECK



Mode switch: **P**

Options

* Default value

<p>[EVALUATIVE]*</p> <p>Appropriate for standard shooting conditions, including backlit scenes. The camcorder divides the picture into several areas and the light is measured in all of them to achieve the optimal exposure for the subject.</p>
<p>[CENT.WEIGHT.AVERAGE]</p> <p>Averages the light metered from the entire screen, giving more weight to the subject in the center.</p>

[SPOT]

Meters only the area within the spot AE point frame. Use this setting to adjust the exposure to match the subject in the center of the screen.

FUNC.
(31)



FUNC.

Icon of the currently selected
Light Metering Mode

FUNC.

Desired option

DC50/DC230 Continuous Shooting and Exposure Bracketing

Take a series of pictures of a moving subject or record the same picture in 3 levels of exposure in order to choose later the picture you like the best.

POINTS TO CHECK



Mode switch: **P** (except for the [FIREWORKS] recording program).

Maximum number of continuous shots at one time:

DC50

Number of frames (shots) per second		Maximum number of continuous shots	
Normal speed	2 frames	L 2592x1944	30 images
High speed	3 frames	M1 2048x1536	45 images
Using the flash	1.9 frames	S 640x480	60 images

DC230

Number of frames (shots) per second		Maximum number of continuous shots	
Normal speed	3 frames	L 1152x864	20 images
High speed	5 frames	S 640x480	60 images

These figures are approximate and vary with the recording conditions and subjects. The actual number of frames per second will be lower when "🌀" (camcorder shake warning) is displayed on the screen.

Options

* Default value

[<input type="checkbox"/> SINGLE]*
Records a single still image.
[CONT.SHOOT.] (Continuous Shooting), [HISPEED CONT.SHOOT.] (High-Speed Continuous Shooting)
Captures a series of still images as long as you hold [PHOTO] pressed down. For the number of frames per second, refer to the table below.
[AEB] (Auto Exposure Bracketing)
The camcorder records a still image in three different exposures (dark, normal, light in 1/2 EV steps), allowing you to choose the shot you like the best.

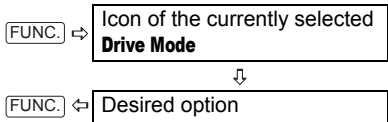

**CONTINUOUS SHOOTING/
HIGH-SPEED CONTINUOUS SHOOTING**

- 1 Press [PHOTO] halfway to activate the autofocus.
- 2 Press [PHOTO] fully and hold it pressed down.

A series of still images will be recorded as long as you hold the button pressed.

AUTO EXPOSURE BRACKETING

Press [PHOTO], first halfway to activate the autofocus and then fully to record the still images.

Three still images in different exposures will be recorded on the memory card.

Other Functions

On-Screen Displays

The camcorder keeps a data code containing the date and time and other camera data (shutter speed, exposure, etc.) registered at the time of recording. You can select the data to be displayed.

Turning the On-Screen Displays On/Off

DC50

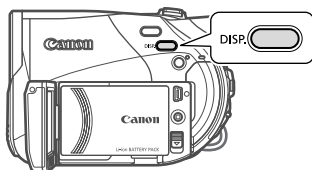

DC20/DC30

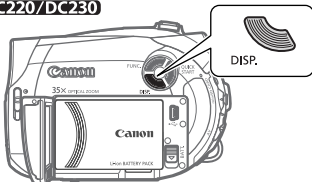

Repeatedly press [DISP.] to turn the on-screen displays on/off in the following sequence:



- All displays on
- All displays off¹



- All displays on
- Data code² only
- All displays off



- All displays on (including the histogram³)
- Regular displays only
- All displays off

- However, the level marker, the disc type icon and the ● and ●|| icons will still appear on the screen.
- Data code: Time, date and camera data at the time of recording. The contents to be displayed can be selected as explained in the following section.
- Histogram display: For still images you can display the complete camera data registered at the time of recording. For details on how to read the histogram display, refer to the following section.

Selecting the Data Code

You can select the data code to be displayed when playing back movies.



Options

* Default value

[DATE], [TIME]
Displays the date or time when the scene or still image was recorded.
[DATE & TIME]*
Displays both the date and time of the recording.
[CAMERA DATA]
Displays the aperture (f-stop) and shutter speed used when recording the image.

FUNC.

(31)

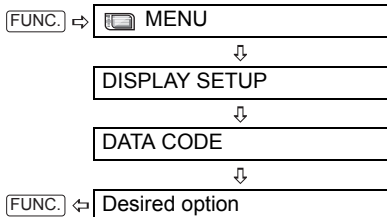

Reading the Histogram Display

When viewing still images you can display the histogram and the icons of all the functions used at the time of recording. Use the histogram as a reference to verify the correct exposure of the still image.

The area to the right of the histogram represents highlights and the left side represents shadows. A still image whose histogram skews to the right is relatively bright; while one whose histogram peaks to the left, is relatively dark.

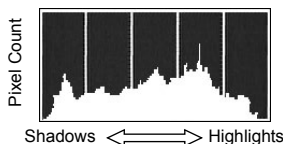

NOTES

The histogram will appear also after recording a still image, while reviewing it within the time set for the [REVIEW] option (or immediately after recording it, if [REVIEW] is set to [OFF OFF]).

Flash

You can use the built-in flash for recording still images in dark places. The flash features the red-eye reduction function.

POINTS TO CHECK



(12)

Select a recording program other than [FIREWORKS] .

Options

• Default value

⚡^A (auto)*
The flash fires automatically according to the brightness of the subject.
👁️ (red-eye reduction, auto)
The flash fires automatically according to the brightness of the subject. The assist lamp lights up to reduce the red-eye effect.
⚡ (flash on)
The flash always fires.
🚫 (flash off)
The flash does not fire.



1 If the joystick guide does not appear on screen, press (SET) to display it.

2 Push the joystick (◀) toward ⚡.

If ⚡ does not appear on the joystick guide, repeatedly push the joystick (▼) toward [NEXT] to display the joystick guide in the illustration above. When the mode switch is set to **AUTO**, only one joystick guide will appear.

- Repeatedly push the joystick (◀) toward ⚡ to cycle between the flash modes.

• The display ⚡^A disappears after 4 seconds.

3 Press [PHOTO], first halfway to activate the autofocus and then fully to record the still image.

i NOTES

- The practical range of the flash is approx. 1 to 2 m (3.3 to 6.6 ft.). The range depends on the recording conditions.
- The range of the flash decreases in continuous shooting mode.
- For the red-eye reduction to be effective, the subject needs to look at the assist lamp. The

degree of reduction depends on the distance and on each individual.

- The flash will not fire in the following cases:
 - When you manually adjust the exposure in ⚡^A (auto) or 👁️ (red-eye reduction) mode.
 - During auto exposure bracketing.
 - In the [FIREWORKS] recording program.

• The flash mode cannot be selected when the exposure is locked.

• **DC50** We recommend not using the flash while the optional Wide-converter is attached; its shadow can appear on the screen.

• **About the AF-Assist Lamp:** While you press [PHOTO] halfway, if the subject is too dark the assist lamp may light up briefly in order to enable the camcorder to focus more accurately (AF-assist lamp). You can also set [AF AST LAMP] to [OFF OFF] so the assist lamp does not light up.

- The camcorder may not be able to focus even if the AF-assist lamp is on.

- The brightness of the AF-assist lamp could be an inconvenience. Consider turning it off in public places such as restaurants or theaters.

DC50 Mini Video Light

You can turn on the mini video light (assist lamp) at any time regardless of the recording program.



1 If the joystick guide does not appear on screen, press (SET) to display it.

2 Push the joystick (▶) toward ⚡.

- If ⚙️ does not appear on the joystick guide, repeatedly push the joystick (▼) toward [NEXT] to display the joystick guide in the illustration above. When the mode switch is set to **AUTO**, only one joystick guide will appear.
- ⚙️ appears on the screen.

- Push the joystick (▶) toward  again to turn the mini video light off.

NOTES

DC50 We recommend not using the mini video light while the optional Wide-converter is attached; its shadow can appear on the screen.

Self Timer

POINTS TO CHECK



CAMERA  : Set the camcorder in record pause mode.

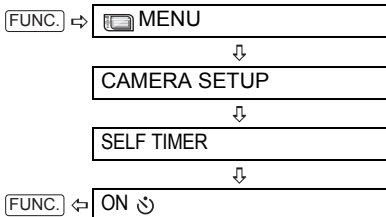

 appears.

CAMERA  :
Press **[Start/Stop]**.

The camcorder starts recording after a 10-second countdown*. The countdown appears on the screen.

CAMERA  :

Press **[PHOTO]**, first halfway to activate the autofocus and then fully to record the still image.

The camcorder will record the still image after a 10-second countdown*. The countdown appears on the screen.

* **DC50/DC20** 2 seconds when using the wireless controller.

NOTES

Once the countdown has begun, you can press **[Start/Stop]** (when recording movies) or press **[PHOTO]** fully (when recording still images) to cancel the self timer. The self timer will also be canceled if you turn off the camcorder.

Digital Effects

POINTS TO CHECK



Mode switch: **P**

CAMERA  : **[E1]** BLK&WHT], **[E2]** SEPIA] only.

Options

* Default value

[E0] D.EFFECT OFF]*
Select this setting when you do not intend to use the digital effects.
[E1] FADE-T] (fade trigger), [E2] WIPE]
Select one of the faders to begin or end a scene with a fade from or to a black screen.
[E1] BLK&WHT]
Records images in black and white.
[E2] SEPIA]
Records images in sepia tones for an "old" look.
[E3] ART], [E4] MOSAIC]
Select one of the other digital effects to add flavor to your recordings.

NOTES

- When you apply a fader, not only the picture but also the sound will fade in or out. When you apply an effect, the sound will be recorded normally.
- The camcorder retains the setting last used even if you turn off the digital effects or change the recording program.

Setting

FUNC.
(31)



FUNC.

Icon of the currently selected
Digital Effect



FUNC.**

Desired fader/effect*

- * You can preview the effect on the screen.
** The icon of the selected effect appears.

Applying



- 1 If the joystick guide does not appear on screen, press (SET) to display it.**
- 2 Push the joystick (▲) toward [NEXT].**
 - If [NEXT] does not appear on the joystick guide, repeatedly push the joystick (▼) toward [NEXT] to display the joystick guide in the illustration above.
 - The icon of the selected effect turns green.
 - Push the joystick (▲) toward [NEXT] again to deactivate the fader/effect.

To FADE IN

Push the joystick (▲) toward [RECORD] in record pause mode (● ||), then press [Start/Stop] to start recording with a fade in.

To FADE OUT

Push the joystick (▲) toward [RECORD] while recording (●), then press [Start/Stop] to fade out and pause the recording.

To ACTIVATE AN EFFECT

[CAMERA] (●) : Push the joystick (▲) toward [RECORD] while recording or in record pause mode.

[CAMERA] (●) : Push the joystick (▲) toward [RECORD] and then press [PHOTO] to record the still image.

Managing Scenes

Creating a Playlist

Create a playlist to easily edit your movies. Include in your playlist only the scenes you prefer or change the order in which they will be played back, without affecting your original recordings. After you add scenes to the playlist you will have two types of index screens:

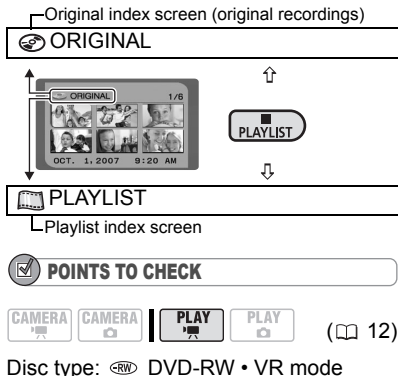

Disc type: DVD-RW • VR mode

Adding Scenes to the Playlist

Options

[ALL SCENES]

Adds all scenes in the original index screen to the playlist.

[ONE SCENE]

Adds only the selected scene to the playlist.

[CANCEL]

Returns to the original index screen.

From the original index screen, select (▲▼, ◀▶) the scene to add to the playlist. To add all scenes, there is no need to select any particular scene.

FUNC. (31)

FUNC.

FUNC.



FUNC. → ADD TO PLAYLIST

Desired option

YES

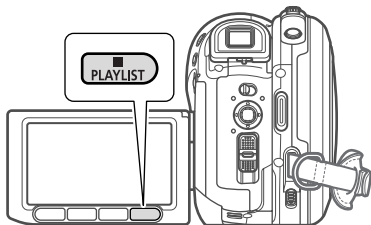

When the operation is completed "ADDED TO PLAYLIST" will be displayed. Press [PLAYLIST] to check the scenes in the playlist index screen.

Moving Scenes in the Playlist

From the original index screen, press [PLAYLIST]. From the playlist index screen, select (▲▼, ◀▶) the scene to move.

FUNC. ([31])

FUNC. → MOVE

↓

Move (▲▼, ◀▶) the orange marker to the new position of the scene and press (SET).

↓

YES

Deleting Scenes

You can delete those scenes that you are not interested in keeping. Remember that when you delete scenes in the playlist, you do not affect your original recordings; However, when you delete an original recording, it will be deleted also from the playlist.

IMPORTANT

- Be careful when deleting original recordings. Once deleted, an original scene cannot be recovered.
- Do not change the position of the power switch or the [CAMERA] switch while the scene is being deleted.

NOTES

- Scenes cannot be deleted when the disc is protected ([71]).
- You may not be able to delete scenes shorter than 5 seconds.

Deleting a Single Scene

POINTS TO CHECK



Disc type: (RW) DVD-RW • VR mode

From the original index screen, select (▲▼, ◀▶) the scene to delete. To delete a scene only in the playlist, press [PLAYLIST] first, and then select the scene.

FUNC. ([31])

FUNC. → DELETE

↓

YES

Deleting a Scene Just After Recording

POINTS TO CHECK



Disc type: (RW) DVD-RW • VIDEO or VR mode



Immediately after recording a scene:

- 1 If the joystick guide does not appear on screen, press (SET) to display it.**
- 2 Push the joystick (◀) toward [G].**
If [G] does not appear on the joystick guide, repeatedly push the joystick (▼) toward [NEXT] to display the joystick guide in the illustration above. When the mode switch is set to **AUTO**, only one joystick guide will appear.
- 3 While reviewing the scene, select (◀▶) and press (SET).**

4 Select (◀▶) [YES] and press (SET).

i NOTES

You will not be able to delete the last scene if after the scene was recorded you changed the operating mode, turned off the camcorder or removed the disc.

Deleting All Scenes

✓ POINTS TO CHECK



Disc type: (DVD) DVD-RW • VR mode

To delete all the scenes from the original index screen, follow the procedure below. This will delete also the whole playlist. If you only want to delete all the scenes from the playlist (without affecting the original recordings), press [PLAYLIST] first and then continue as follows.

FUNC. (31)



FUNC. → MENU



DISC OPERATIONS



MOVIES ALL DEL*



FUNC. ← YES

* When you are deleting the playlist, this menu option will be replaced by [PLAYLIST ALL DEL].

Dividing a Scene

You can divide your recordings in order to leave only the best parts and later cut out the rest. Remember that when you divide scenes in the playlist, you do not affect your original recordings.

i NOTES

Photomovie scenes (74) and very short scenes (1 second or less) cannot be divided.

✓ POINTS TO CHECK



Disc type: (DVD) DVD-RW • VR mode

From the original index screen, select (▲▼, ◀▶) the scene to divide. To divide a scene only in the playlist, press [PLAYLIST] first, and then select the scene.

FUNC. (31)



FUNC. → DIVIDE



Playback of the scene begins. Press (SET) at the point where you want to divide the scene.*



↔ DIVIDE



YES

* You can use the following icons and the special playback modes (40) to bring the scene to a precise point.

⏮/⏭: Skip to the beginning of the current/next scene.

◀/▶: One frame reverse/advance.

Managing the Disc

Protecting the Disc

You can protect the whole disc to prevent the accidental erasure of important recordings. Follow the same procedure to remove the protection of a protected disc.

IMPORTANT

Initializing the disc (p. 71) will permanently erase all recordings, even if the disc is protected.

POINTS TO CHECK



Disc type: DVD-RW • VR mode

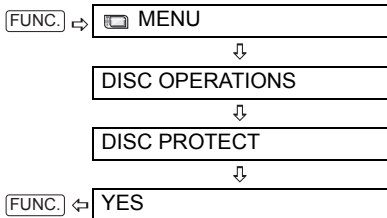

Initializing the Disc

You need to initialize a DVD-RW disc when first inserting it into the camcorder and you may have to initialize a disc if you get the message "UNABLE TO RECOGNIZE THE RECORDING MODE OF THE DISC". You can also choose to initialize the disc if you wish to erase all the recordings on the disc or in order to change the disc specification.

IMPORTANT

- Initializing the disc will permanently erase all recordings, even if the disc is protected. The lost original recordings cannot be recovered.
- Initialize all DVD-RW discs before using them with this camcorder.

POINTS TO CHECK



Disc type: DVD-RW • VIDEO or VR mode

Options

[VIDEO] mode
Most DVD players will play the disc, but except for the disc title, the recordings cannot be edited with the camcorder.
[VR] mode
You will have the option to edit the recordings with the camcorder, but the disc can only be played in VR mode-compatible DVD players and computer DVD drives.



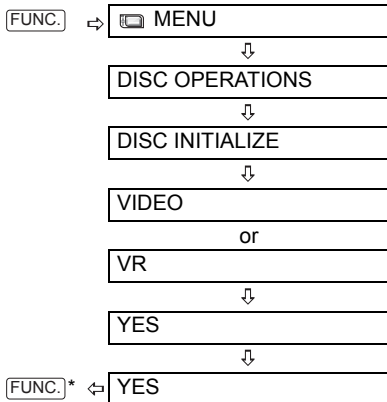

* Close the menu only after the screen display returns to the [DISC OPERATIONS] menu.

Changing the Disc Title

Before you finalize your disc*, you can give it a title. The disc title will be displayed on the index screen when playing the finalized disc in most DVD players.

* You can change the title of DVD-RW discs recorded in VR mode also after having finalized them.

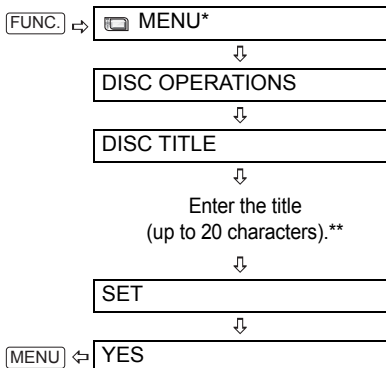
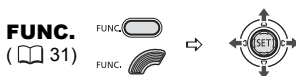

* Only when using a DVD-RW recorded in VR mode. With discs recorded in VIDEO mode, pressing [FUNC.] will open the menu directly on the setup menu screen.

**Select one character at a time and press (SET) to add it to the title. Select [BACKSPACE] and press (SET) to delete the character to the left of the cursor's position.

Managing Photos

Erasing Photos

You can erase still images recorded on the memory card or on the disc (DVD-RW only).

IMPORTANT

Be careful when erasing images. Erased images cannot be recovered.

NOTES

Protected images on the memory card and images on a protected disc cannot be erased.

Erasing a Single Image

POINTS TO CHECK



Disc type: DVD-RW • VR mode



- 1 If the joystick guide does not appear on screen, press (SET) to display it.
- 2 Push the joystick (▼) toward .
- 3 Select (◀▶) [ERASE] and press (SET).

Erasing a Single Image Just After Recording

You can erase the still image recorded last while reviewing it within the time set for the [REVIEW] option (or immediately after recording it, if [REVIEW] is set to [OFF OFF]).

POINTS TO CHECK



Disc type: DVD-RW • VIDEO or VR mode



While reviewing the image immediately after recording:

- 1 Push the joystick (▼) toward .
- 2 Select (◀▶) [ERASE] and press (SET).

Erasing All Images

The following procedure will erase all the non-protected still images from the currently selected media (will not erase images with the mark).

POINTS TO CHECK



Disc type: DVD-RW • VR mode

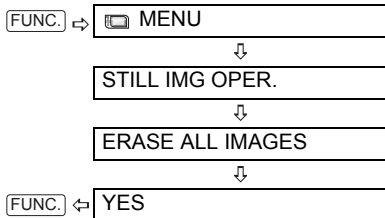

Copying Photos

You can copy still images recorded on the memory card to the disc (for example, to add them to a Photomovie scene (□ 74)), or from the disc to the memory card (for example, to set print orders for a DPOF compatible printer (□ 96)).

Copying a Single Image

POINTS TO CHECK



Select as the media for the still images, the media from where you want to copy images.

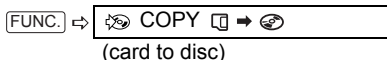

or

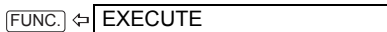
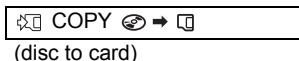

Copying All Images

POINTS TO CHECK



Select as the media for the still images, the media from where you want to copy images.

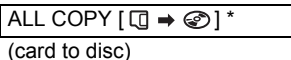
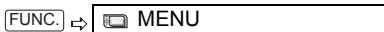

or

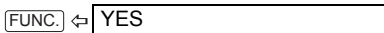
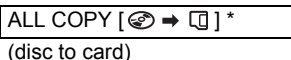

* The total size of all image files on the source media and the space available on the destination media will be displayed.

NOTES

- Still images not recorded with this camera may not be copied correctly.
- When there is not enough available space on the destination media, the operation will be terminated without copying all the image files.
- The copy operation may take a moment to complete depending on the number and total size of the image files.

Converting Photos into Photomovie Scenes

Still images are recorded using JPEG compression, but a DVD player only recognizes the MPEG standard. Thus, to play back your still images with your DVD player, first you need to create a Photomovie scene – a slide show of all still images on the disc, where each image will be displayed for approx. 3 seconds.

Converting a Single Image



Select (◀▶) the still image you want to convert to a Photomovie scene.

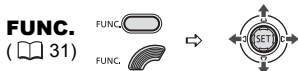

FUNC. → CONVERT TO SCENE

FUNC. ← EXECUTE

Converting All Images



If you want to include in your Photomovie scene still images recorded on the memory card, copy them to the disc in advance (74).



FUNC. → MENU

↓
DISC OPERATIONS

↓
PHOTOMOVIE

FUNC. ← YES



- If the disc becomes full while creating a Photomovie scene, the operation will be canceled.
- This function does not affect the original still images.

- **DIGITAL** To create a Photomovie scene that includes still images with a 16:9 aspect ratio (MW 1280x720), we recommend you set [TV TYPE] to [**TV** NORMAL TV] beforehand.
- If you create Photomovie scenes on a DVD-RW initialized in VR mode, you will not be able to transfer any recordings to the computer using MyDVD for Canon.

Protecting Photos on the Memory Card

You can protect still images recorded on the memory card from accidental erasure.

! IMPORTANT

Initializing the memory card (76) will permanently erase all recorded still images, even the protected ones.



FUNC. → ON PROTECT

↓
Press (SET)

[ON PROTECT]: The image selection screen appears.

FROM THE IMAGE SELECTION SCREEN

- 1 Select (◀▶) the still image you want to protect.
- 2 Press (SET) to protect the still image.

ON appears on the bottom bar and the image cannot be erased. Press (SET) again to cancel the image protection.

- 3 Repeat steps 1-2 to protect additional images or press FUNC. twice to close the menu.

Initializing the Memory Card

Initialize memory cards when you use them with this camcorder for the first time. You may also have to initialize a card if you get the "CARD ERROR" message or you may choose to do so to erase all data recorded on it.

The regular initialization option [INITIALIZE] will clear the file allocation table but will not physically erase the stored data. If you need to completely erase all the data, select instead the complete initialization option [COMPL.INIT.].

! IMPORTANT

Initializing the memory card will erase all still images, even the protected ones. The original still images cannot be recovered.



(12)

FUNC.
(31)

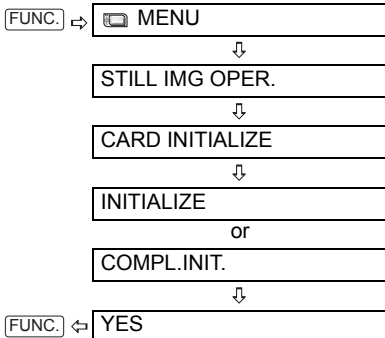

* Press (SET) to cancel the complete initialization while it is in progress. All the image files will be erased and the memory card can be used without any problem.

Finalizing the Disc

To play the disc you recorded on a DVD player, a computer's DVD drive or other digital device, you need to finalize it first. You do not need to finalize the disc to play back your recordings with the camcorder connected to the TV.

To view your still images on a DVD player you will need to convert them to Photomovie scenes beforehand (□ 74).

! IMPORTANT

● **Be sure to finalize the disc in normal room temperatures. If the procedure was not completed correctly due to high temperature, let the camcorder cool off before resuming operation.**

● **Place the camcorder on a table or other stable surface before starting the procedure. Subjecting the camcorder even to slight impacts (for example to place it on a table or to disconnect the AV cable) after the finalization process started may result in permanent data loss.**

- Always power the camcorder using the compact power adapter. The operation cannot be started if the camcorder is powered only with the battery pack.
- Avoid the following actions while the operation is in progress. Failing to do so can interrupt the process and result in permanent data loss.
 - Do not move the camcorder.
 - Do not disconnect the compact power adapter.
- Depending on the type of disc and the disc specification, after finalizing the disc you may not be able to initialize the disc, edit your recordings or add new recordings to the disc.
- Do not finalize with this camcorder discs that were not recorded using it.

i NOTES

The time required to complete the operation will vary depending on the recording conditions and the remaining free space on the disc.

Restrictions after Disc Finalization

	Additional Recordings	Edit Recordings	Initializing the Disc	Unfinalizing the Disc
DVD-R/DVD-R DL in VIDEO mode	—	—	—	—
DVD-RW in VIDEO mode	●*	—	●	●
DVD-RW in VR mode	●	●	●	—

* You will need to unfinalize the disc first.

Finalizing the Disc

The length of the finalization process depends on the scenes recorded and the remaining free space on the disc.

POINTS TO CHECK



Power the camcorder using the compact power adapter.

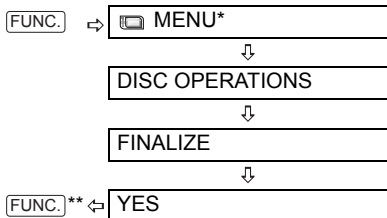

* Only when using a DVD-RW recorded in VR mode. With discs recorded in VIDEO mode, pressing [FUNC.] will open the menu directly on the setup menu screen.

**During the disc finalization a progress bar is displayed. Close the menu only after the screen display returns to the [DISC OPERATIONS] menu.

Playing Back your Disc on a DVD Player or a Computer's DVD Drive

After finalizing the disc you can play it on DVD players compatible with the type of disc you used (DVD-R, DVD-R DL or DVD-RW). For details about disc compatibility refer to the instruction manual of the DVD player or DVD drive.

ON A DVD PLAYER

- 1 Turn on the TV and DVD player.
- 2 Insert a finalized disc in the DVD player.
- 3 Select the scene you want to play from the index screen.

ON A COMPUTER'S DVD DRIVE

- 1 Insert a finalized disc in the DVD drive.
- 2 Run the DVD playback software.
 - Refer also to the instruction manual and help modules of your DVD playback software.
 - To view still images recorded on the disc, close first any DVD playback software that may be running.

NOTES

- DVD-RW discs recorded in VR mode can only be played on VR mode-compatible DVD players.
- Depending on your DVD device you may not be able to play the disc.
- The resolution of Photomovie scenes will be lower than that of the original still images.
- In order to play the disc on a computer you need to have DVD playback software installed and running. Also, in order to play back a DVD-R DL you must have a DVD drive capable of reading dual-layered DVD discs.

Unfinalizing the Disc - Additional Recordings on a Finalized Disc

Unfinalize a disc to allow recording additional movies on the disc even after it was finalized.

IMPORTANT

- Be sure to unfinalize the disc in normal room temperatures. If the procedure was not completed correctly due to high temperature, let the camcorder cool off before resuming operation.
- Place the camcorder on a table or other stable surface before starting the procedure. Subjecting the camcorder even to slight impacts (for example to place it on a table or to disconnect the AV cable) after the unfinalization process started may result in permanent data loss.
- Always power the camcorder using the compact power adapter. The operation cannot be started if the camcorder is powered only with the battery pack.
- Avoid the following actions while the operation is in progress. Failing to do so can interrupt the process and result in permanent data loss.
 - Do not move the camcorder.
 - Do not disconnect the compact power adapter.
- Only discs that were finalized using this camcorder can be unfinalized with it.

Discs that Can be Unfinalized

DVD-R/DVD-R DL in VIDEO mode	—
DVD-RW in VIDEO mode	●
DVD-RW in VR mode	— You can record additional scenes even without unfinalizing the disc

POINTS TO CHECK



Power the camcorder using the compact power adapter.

Disc type: ◀RW DVD-RW • VIDEO mode

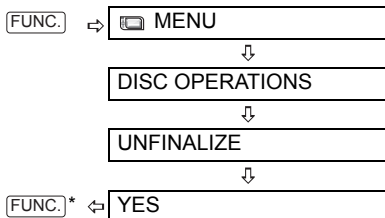

* During the disc unfinalization a progress bar is displayed. Close the menu only after the screen display returns to the [DISC OPERATIONS] menu.

Connecting to a TV or VCR

Connection Diagrams

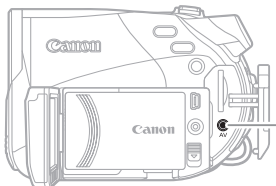

Open the terminal cover to access



AV

AV Terminal

Sound from the built-in speaker will be muted while the STV-250N stereo video cable is connected to the camcorder.

Terminal on the Camcorder	Connecting Cable	Terminal on the Connected Device
<p>1 Output connection (Signal Flow →) to a TV or VCR with AV Terminals.</p> <p>DC50 Input connection (Signal Flow ←) from a TV, VCR or other analog video source with AV Terminals.</p>	<p>STV-250N Stereo Video Cable (Supplied)</p>	

Playback on a TV Screen

POINTS TO CHECK



Before connecting the camcorder, select the [TV TYPE] setting according to the TV set to which you will connect the camcorder - [WIDE TV]: TV sets with 16:9 aspect ratio or [NORMAL TV]: TV sets with 4:3 aspect ratio (□ 51).

Connecting

Connect the camcorder to the TV following the connection diagram shown in the previous section *Connection Diagrams* (□ 80).

Playback

1 Turn on the camcorder and the connected TV or VCR.

On a TV: Select as the video input the same terminal to which you connected the camcorder. On a VCR: Set the input selector to the external video input (usually labeled LINE IN).

2 Start the playback of the movies (□ 39) or still images (□ 41).

NOTES

- Turn off all the devices before starting the connections.
- Sound from the built-in speaker will be muted while the STV-250N Stereo Video Cable is connected to the camcorder.
- We recommend powering the camcorder using the compact power adapter.

Recording to a VCR or Digital Video Recorder

You can copy your recordings by connecting the camcorder to a VCR or a digital video device.



Connecting

Connect the camcorder to the VCR following the connection diagram shown in the previous section *Connection Diagrams* (□ 80).

Recording

- 1 **Connected device: Load a blank cassette or disc and set the device to record pause mode.**
- 2 **This camcorder: Locate the scene you wish to copy and pause playback shortly before the scene.**
- 3 **This camcorder: Resume the movie playback.**
- 4 **Connected device: Begin recording when the scene you wish to copy appears. Stop recording when copying is complete.**
- 5 **This camcorder: Stop playback.**

NOTES

- We recommend powering the camcorder using the compact power adapter.
- By default, the on-screen displays will be embedded in the output video signal, but you can change the displays by repeatedly pressing [DISP.] (□ 63).

DC50 Video Input Recording

You can input video from an analog video source (VCR, TV, etc.) and record it on the disc in the camcorder.



Connecting

Connect the camcorder to the analog input source following the connection diagram shown in the previous section *Connection Diagrams* (book 80).

Recording

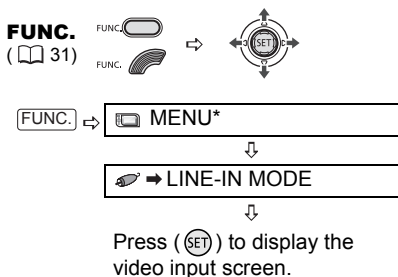

* Only when using a DVD-RW recorded in VR mode. With discs recorded in VIDEO mode, pressing [FUNC.] will open the menu directly on the setup menu screen.



FROM THE VIDEO INPUT SCREEN

The following icons are displayed at the bottom of the video input screen:

⏮): Adjust the speaker volume (will not affect the recording).

[XP]/[SP]/[LP]: Select the recording mode.

⏸/⏹): Start recording/pause the recording.

⏹): Terminate the video input and return to [PLAY] mode.

- This camcorder:** Change the recording settings as necessary.
- Connected device:** Load the recorded cassette or disc and start playback.
- This camcorder:** Select (⏮) the [●] icon. When the scene you wish to record appears, press (SET). Recording starts.
- This camcorder:** To pause the recording, select (⏮) [●] and press (SET). In record pause mode, select (⏮) [●] and press (SET) to resume recording.

TO STOP RECORDING

- This camcorder:** In record pause mode, select (⏮) ⏹ and press (SET).
- Connected device:** Stop the playback.

! IMPORTANT

- Video input that includes copyright signals (for example, digital content designated as "copy once" or copy protected) cannot be recorded. The video input will be recorded normally until the point a copyright signal is detected.
- Depending on the analog signal sent from the connected device the input image may be distorted or not be displayed at all (for example, video input that includes anomalous signals such as ghost signals).

i NOTES



We recommend powering the camcorder with the compact power adapter.

Connecting to a Computer

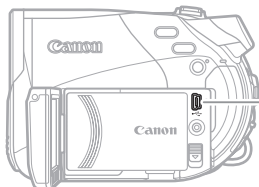
PC Connection Diagrams

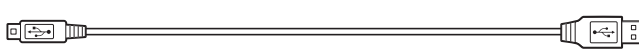

	<p>USB Terminal Open the LCD panel to access.</p>
---	--

Terminal on the Camcorder	Connecting Cable	Terminal on the Connected Device
<p>1 Output connection (Signal Flow →) to a PC or PictBridge compatible printer with an USB port.</p>		
	 USB Cable (Supplied)	

Transferring Recordings

Windows users only:

You can transfer recordings (movies and still images) from the disc to a computer simply by connecting the camcorder with the USB cable.

DC50 You can also install the supplied software MyDVD for Canon to transfer your recordings to the computer and easily edit them.

Transferring Recordings Using Windows Explorer



POINTS TO CHECK

When transferring recordings from the disc to a computer, the type of disc you can use depends on the operating system installed on your computer.

Operating System (Preinstalled)	Can Transfer Recordings from...
Windows 2000, Windows Me, Windows XP	Discs recorded in VIDEO mode* (all disc types)
Windows XP SP2	All disc types VIDEO or VR mode

* **DC50** After installing MyDVD for Canon, you will be able to transfer recordings also from DVD-RW discs recorded in VR mode.

1 Turn on the camcorder and set it to  mode.

2 Insert a finalized disc into the camcorder.

3 Connect the camcorder to the computer using the USB cable. Refer to *PC Connection Diagrams* ( 83).

4 Windows XP: From the Start menu, select "My Computer".

Windows 2000/Windows Me: Double-click on the desktop's "My Computer" icon.

5 The camcorder will appear as an additional drive. Right-click on the drive icon that corresponds to the camcorder and select "Open".

6 Select the files you want to transfer and drag and drop them to the destination folder on your computer using Windows Explorer.



Refer also to the computer's instruction manual.

Transferring Recordings Using MyDVD for Canon

With the MyDVD for Canon software you can transfer your recordings to a computer and easily edit them. Please note that with MyDVD for Canon you can read 8 cm DVD-R DL discs, but the software does not support writing on dual-layered discs (neither with an external DL drive nor with the camcorder itself). For further details about using MyDVD for Canon, refer also to the software's tutorial and help modules.

MyDVD for Canon

One-touch dubbing (Windows XP only)

Insert a blank DVD-R/-RW in your computer's DVD drive (with writing capabilities), connect the camcorder and with only pressing  (print/share button), create a copy of your DVD you can instantly share ( 87).

Transfer recordings to your computer

You can transfer your recordings to edit them on your computer ( 88).

Create a backup disc of your DVD

Transfer your recordings to the computer and even if your computer does not have a DVD drive with writing capabilities, use your camcorder itself to create a copy of your DVD ( 88)

- North America

Web Based Service: <http://support.roxio.com>

Phone assistance: 866-279-7694 (toll free) or 905-482-5555 (Canada only), 9:00 A.M. to 6:00 P.M., U.S Pacific Time - excluding Weekend and Holidays

- Europe

Web Based Service:

Germany

<http://www.roxio.com/en/support/de/emc/index.jhtml>

France

<http://www.roxio.com/en/support/fr/emc/index.jhtml>

U.K

<http://www.roxio.com/en/support/uk/>

Phone assistance: Germany 0900-1735096; France 0892-460909; U.K 0906-7320288,

1:00 P.M. to 10:00 P.M., GMT - excluding Weekend and Holidays

- China/Taiwan

Web Based Service:

<http://www.sonictaiwan.com/support/techsupport.aspx>

sonicsupport@gil.com.tw

Phone assistance: 02-2658-8765 (Taiwan)

System Requirements

- Operating System:

Microsoft Windows 2000, Windows Me, Windows XP

- Minimum Hardware:

Pentium III 1 GHz or higher (1.5 GHz or greater, recommended)

128 MB RAM (256 MB or greater, recommended)

10 GB hard drive space (20 GB or greater, recommended)

Video adapter and display supporting at least 1024 x 768 resolution, 16 bit color

- Software Requirements:

Microsoft Windows Media Player 9 or later

- Internet connection (for user registration).

! IMPORTANT

- **After installing MyDVD for Canon you will need an Internet connection to complete the user registration. Without completing the online user registration, you will not be able to use any of the software's functions.**

- **For support concerning MyDVD for Canon:**

Canon Inc. and the Canon related customer support centers do not provide support concerning MyDVD for Canon. For any questions or technical issues regarding the software, its installation and operation, please contact directly Sonic Solutions customer support representatives or access online the Internet pages listed in the information box above.

- Operation may not work correctly depending on the specifications and settings of your computer.

Installing MyDVD for Canon

- 1 Turn on the computer and start up Windows.
- 2 Insert the Roxio MyDVD for Canon Software CD-ROM into the computer's CD or DVD drive.
 - The Setup Wizard will launch automatically.
 - If you do not have Windows Media Player 9 or later installed, click "OK" on the setup window that appears and install the latest version of Windows Media Player following the instructions on the screen.
 - If the Setup Wizard does not start automatically:
 - ① Windows 2000/Me: Double-click on the desktop's "My Computer" icon.
Windows XP: Form the Start menu, select "My Computer".
 - ② Right-click on the CD-ROM or DVD drive where you inserted the software disc and select "Open".
 - ③ Double-click on the "SETUP.EXE" file. (Note that depending on the computer's settings the ".EXE" suffix may not be displayed).
- 3 In the Setup Wizard screen click "Next".
- 4 Read the license agreement. If you agree, select "I accept the terms in the License Agreement" and click "Next".
- 5 Enter the user information and click "Next".

The serial number will already be filled in.
- 6 Click on the "Typical" installation. You can also select "Custom" to select the programs installed and the installation folder, or "Complete" to install all the program's features.

- 7 Click "Install" to begin the installation.
- 8 When the "Setup Wizard Completed" screen appears, click "Finish".
- 9 Read the latest "Readme" file and click "Yes" to restart the computer.

Completing the User Registration

- 1 After the computer has restarted, remove the Roxio MyDVD for Canon Software CD-ROM from the drive and double-click on the desktop's "MyDVD" icon .
- 2 Connect to the Internet to complete the user registration online.

Without completing the online user registration you will not be able to use any of the software's functions.
- 3 Click "Next" to start the registration.
- 4 Enter the user information and select your country/region from the selection box.
- 5 Click on "Privacy Policy" to read the terms. If you agree to the terms, check the box "I have read and agree to the terms of the Privacy Policy" and click "Register Now".

After the user registration is completed automatically, the initial screen of MyDVD for Canon will be displayed.

NOTES

Depending on the speed of your Internet connection, the user registration may take some time.

If you cannot connect to the Internet the user registration will not be completed. Without completing the online user registration you will not be able to use any of the software's functions.

Connecting the Camcorder

You need to install the software and register online only the first time you connect the camcorder to the computer. From the second time on, just connect the camcorder to the computer.

- 1 **Connect the compact power adapter to the camcorder.**
- 2 **Turn on the camcorder and set it to  mode.**
- 3 **Connect the camcorder to the computer using the USB cable. Refer to *PC Connection Diagrams* (□ 83).**

! IMPORTANT

- During the following operations, even if you connect the camcorder to the computer it will not be recognized.
 - Deleting all scenes
 - Protecting the disc
 - Setting the disc title
 - Initializing the disc
 - Finalizing or Unfinalizing the disc
- Check the orientation of the USB cable and make sure you connect it properly.
- If you use discs other than the recommended DVD discs you may get an error message on the computer indicating that the disc cannot be read or that the camcorder is not ready.

i NOTES

DVD copies and DVD backup discs created with MyDVD for Canon cannot be unfinalized using the camcorder.

One-Touch Dubbing (Windows XP only)

✓ POINTS TO CHECK

- This function requires a computer equipped with a DVD drive with writing capabilities.
 - If MyDVD for Canon is running, close the program first.
- 1 **Insert the finalized disc you wish to copy into the camcorder.**

2 Insert a brand new DVD-R or DVD-RW disc into the computer's DVD drive.

- The  button will light up in blue.
- To make a copy of a disc recorded in VR mode, be certain to insert a DVD-RW disc into the computer's DVD drive.

3 Press .





- The  button will flash while the copying is in progress, and will go off once the copy is completed.
- The copied disc will be finalized and automatically ejected from the drive.

! IMPORTANT

- DVD-R/RW discs can be copied to 12 cm or 8 cm DVD-R/RW discs. DVD-R DL discs can only be copied to 12 cm DVD-R/RW discs.
- If you did not complete the online user registration beforehand, you will not be able to use One-Touch Dubbing.
- Operation may not work properly if you connect more than one Canon camcorder to the computer at the same time.

i NOTES

- **If the operation is interrupted:** "OPERATION CANCELED" will be displayed on the camcorder's screen. The message disappears when you remove the disc or run MyDVD for Canon.
- When the DISC access indicator is on or flashing do not perform the following actions. Doing so may result in permanent data loss.
 - Do not subject the camcorder to vibrations or strong impacts.
 - Do not open the disc cover and do not remove the disc.
 - Do not disconnect the USB cable.
 - Do not turn off the camcorder or the computer.
 - Do not change the position of the  switch or the operating mode.
- You need to have DVD playback software installed in your computer in order to play the disc.

- We recommend powering the camcorder using the compact power adapter while it is connected to the computer.
- Refer also to the computer's instruction manual.
- For further details about restrictions when using MyDVD for Canon, refer also to the "README" section in the software's help modules.
- Photomovie scenes created on a disc initialized in VIDEO mode cannot be transferred to the computer using MyDVD for Canon.
- If you create Photomovie scenes on a DVD-RW initialized in VR mode, you will not be able to transfer any recordings to the computer using MyDVD for Canon.
- Depending on the number and length of the scenes recorded, the One-Touch Dubbing may take some time.
- In the following cases, the  button will not light up in step 2 and you cannot use the One-Touch Dubbing function:
 - The online user registration was not completed correctly.
 - MyDVD for Canon is still running.
 - A finalized disc is not inserted in the camcorder.
 - A brand new disc is not inserted in the computer's DVD drive.
 - The disc in the camcorder is a DVD-RW recorded in VR mode but the disc in the computer's DVD drive is a DVD-R disc.
 - The disc in the computer's DVD-drive is a DVD-R DL disc.
- If none of the previous applies but the  button still does not light up, look for the  icon in the computer's desktop toolbar. If  does not appear, disconnect the USB cable from both, the camcorder and the computer. Restart the computer and turn the camcorder off and then on again. Then, connect the camcorder to the computer again.

Transferring Recordings to the Computer

- 1 Insert the source disc into the camcorder.**
You can use any disc regardless of whether it is finalized or not.
- 2 Run MyDVD for Canon.**

- 3 Click on the "DVD-Video" option in the New Project tab.**
- 4 Check that the DISC access lamp is not on or flashing and click on the "Open Disc" icon.**
- 5 Click on the "Import" button.**
Thumbnails of the imported scenes and still images will be displayed in the video project screen.
- 6 Click "OK".**
- 7 To save the project, click on "Save Project" from the Project Tasks palette.**
The scenes and still images displayed in the main screen will be saved.

IMPORTANT

- Photomovie scenes created on a disc initialized in VIDEO mode cannot be transferred to the computer using MyDVD for Canon.
- If you create Photomovie scenes on a DVD-RW initialized in VR mode, you will not be able to transfer any recordings to the computer using MyDVD for Canon.

Creating Backup Copies of your DVD

- 1 Insert a finalized disc into the camcorder.**
- 2 Run MyDVD for Canon.**
- 3 Click on the "Make a Backup DVD" option in the New Project tab.**
- 4 Select the camcorder as the "Device to read from".**
- 5 Select the computer's DVD drive (with writing capabilities) as the "Device to write to".**
If your computer is not equipped with a DVD drive with writing capabilities, select the camcorder also as the "Device to write to".
- 6 Check that the DISC access lamp is not on or flashing and click on the "Copy" button.**
- 7 Follow the indications on the screen.**

If you selected the camcorder itself as the “Device to write to”, after the camcorder finishes reading the original disc, remove it and insert a brand new DVD-R or DVD-RW disc into the camcorder.

8 When the “Your disc was created successfully” screen appears, click “OK”.

The copied disc will be finalized and automatically ejected from the drive.

IMPORTANT

- To make a copy of a disc recorded in VR mode, be certain to insert a DVD-RW disc into the computer’s DVD drive.
- The software does not support writing on DVD-R DL discs.
- Always use a brand new disc as the target disc in the computer’s DVD drive or the camcorder.
- If you are using a computer’s DVD drive to make the backup copy you can also use a fully erased DVD-RW disc. To fully erase a DVD-RW disc you will need DVD authoring software.
- When you are using a DVD-RW disc as the source disc, if the tray of a DVD drive other than that selected in step 5 opens when you need to insert the target disc, some recordings on the source disc may be lost. Click on “Cancel” and restart the computer.

Transferring Still Images - Direct Transfer

With the supplied USB cable and Digital Video Software you can transfer still images to a computer. With the **DC50** you can do so simply by pressing .

Preparations

The first time you connect the camcorder to the computer, you need to install the software and set the auto-launch setting. From the second time on, you will only

need to connect the camcorder to the computer to transfer images.

1 Install the supplied Digital Video Software.

Refer to the installation guide (separate leaflet included with the CD-ROM).

2 Set the camcorder to  mode.

3 Connect the camcorder to the computer using the USB cable.

See *Connecting the Camcorder to a Computer* in the *Digital Video Software* instruction manual (electronic version on PDF file).

4 Set the auto-launch setting.

- See *Starting CameraWindow* (Windows) or *Auto-downloading* (Macintosh) in the *Digital Video Software* instruction manual (electronic version on PDF file).
- The direct transfer menu appears on the camcorder screen and the  button lights up.

IMPORTANT

- Correct performance cannot be guaranteed for discs recorded on another digital device and inserted in this camcorder.
- When the DISC or CARD access indicator is on or flashing do not perform the following actions. Doing so may result in permanent data loss.
 - Do not subject the camcorder to vibrations or strong impacts.
 - Do not open the disc cover/memory card slot cover and do not remove the disc or memory card.
 - Do not disconnect the USB cable.
 - Do not turn off the camcorder or the computer.
 - Do not change the position of the  switch or the operating mode.
- Operation may not work correctly depending on the software and the specifications/settings of your computer.
- If you wish to use the image files on your computer, make copies of them first, and use the copied file, retaining the original.

● During the following operations, even if you connect the camcorder to the computer it will not be recognized.

- Protecting the disc
- Initializing the disc
- Finalizing or Unfinalizing the disc
- Erasing all still images from the disc or card
- Copying still images between the disc and card
- Erasing all transfer orders
- Erasing all print orders

i NOTES

● We recommend powering the camcorder using the compact power adapter while it is connected to the computer.

● Refer also to the computer's instruction manual.

● Users of Windows XP and Mac OS X:

Your camcorder is equipped with the standard Picture Transfer Protocol (PTP) allowing you to download still images (JPEG only) by simply connecting the camcorder to a computer via USB cable without installing the software from the DIGITAL VIDEO SOLUTION DISK.

Transferring Images

[ALL IMAGES]
Transfers all images to the computer.
[NEW IMAGES]
Transfers only those images that have not yet been transferred to the computer.
[TRANSFER ORDERS]
Transfers images with transfer orders to the computer. Transfer orders (91) are only available for images recorded on the memory card.
[SELECT & TRANSFER]
Allows you to select the still image you want to transfer to the computer.
[WALLPAPER]
Allows you to select the still image you want to transfer and set it as your computer's desktop background.

DC50

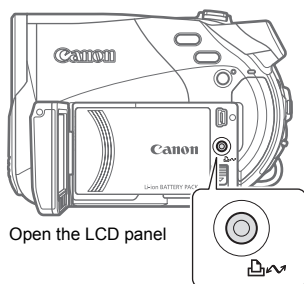

Open the LCD panel

(print/share) button

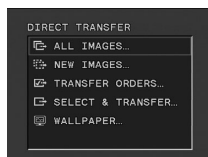

AUTOMATIC TRANSFER OPTIONS

When you select [ALL IMAGES], [NEW IMAGES] or [TRANSFER ORDERS], all the relevant still images will be transferred to the computer in one batch and their thumbnails will be displayed on the computer.

DC50

Select (▲▼) a transfer option and press .

DC220/DC230

1 Select (▲▼) a transfer option and press (SET).

2 In the confirmation screen, select (◀▶) [OK] and press (SET).

DC50/DC220/DC230

- The camcorder returns to the transfer menu once the transfer is complete.
- To cancel the transfer, select (◀▶) [CANCEL] and press (SET) or press **[FUNC.]**.

MANUAL TRANSFER OPTIONS

When you select [SELECT & TRANSFER] or [WALLPAPER] you can select the images you want to transfer one by one.

DC50

- 1 Select (▲▼) a transfer option and press [ENTER].
- 2 Select (◀▶) the image you want to transfer and press [ENTER].
The [ENTER] button will flash while the images are being transferred.

DC220/DC230

- 1 Select (▲▼) a transfer option and press (SET).
- 2 Select (◀▶) the image you want to transfer and press (SET).

DC50/DC220/DC230

- [SELECT & TRANSFER]: The selected image is transferred and displayed on the computer. To continue transferring, select (◀▶) another image.
- [WALLPAPER]: The selected image is transferred to the computer and displayed as the desktop's background.
- Press [FUNC.] to return to the transfer menu.

NOTES

- **DC50** You can press (SET) to transfer the images, instead of [ENTER]. The operation is identical to that described for the **DC220/DC230**.
- When the camcorder is connected to the computer and the image selection screen is displayed, press [FUNC.] to return to the transfer menu.
- Even when still images recorded on the disc are correctly transferred to the computer, they will still be marked as images not yet transferred ("NEW IMAGES").

Transfer Orders

From the still images on the memory card, you can mark in advance the images you want to transfer to the computer as transfer orders. You can set transfer orders for up to 998 still images.

Selecting Still Images to Transfer (Transfer Order)

Do not connect the USB cable to the camcorder while setting the transfer orders.

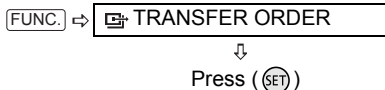

[FUNC.] : The image selection screen appears.

FROM THE IMAGE SELECTION SCREEN

- 1 Select (◀▶) the still image you want to mark with a transfer order.
- 2 Press (SET) to set the transfer order. A checkmark ✓ appears in the box next to the transfer order symbol [SELECT & TRANSFER]. Press (SET) again to cancel the transfer order.
- 3 Repeat steps 1-2 to mark additional images with transfer orders or press [FUNC.] twice to close the menu.

Erasing All Transfer Orders

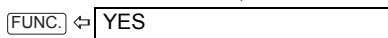
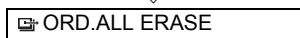
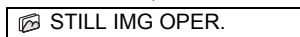
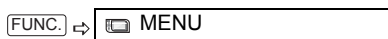

Connecting to a Printer

Printing Still Images - Direct Print

The camcorder can be connected to any PictBridge compatible printer. From the still images on the memory card, you can mark in advance the images you want to print and set the desired number of copies as a print order (12 96).

Canon printers: SELPHY printers of the CP, DS and ES series and PIXMA printers marked with the PictBridge logo.



Connecting the Camcorder to the Printer



- 1 Insert the memory card or disc containing the still images you want to print.
- 2 Turn on the printer.
- 3 Select as the media for the still images, the media from where you want to print the images.
- 4 Connect the camcorder to the printer using the supplied USB cable. Refer to *PC Connection Diagrams* (83).
 - appears and changes to .
 - **DC50** The (print/share) button lights up and the current print settings will be displayed for approx. 6 seconds.

IMPORTANT

- If continues to flash (for more than 1 minute) or if does not appear, the camcorder is not correctly connected to the printer. In such case, disconnect the USB cable and turn off the camcorder and the printer. After a short while, turn them on again, set the camcorder to **PLAY** mode and restore the connection.

- During the following operations, even if you connect a printer to the camcorder it will not be recognized.

- Deleting all scenes
- Protecting the disc
- Setting the disc title
- Initializing the disc
- Finalizing or Unfinalizing the disc
- Erasing all still images from the disc or card
- Copying still images between the disc and card
- Erasing all transfer orders
- Erasing all print orders

- Correct performance cannot be guaranteed when printing images from a disc recorded on another digital device and inserted in this camcorder.

NOTES

- will appear for images that cannot be printed.
- We recommend powering the camcorder using the compact power adapter.
- Refer also to the printer's instruction manual.

DC50 Printing with the (Print/Share) Button

You can print a still image without changing the settings simply by pressing .



1 Select (◀▶) the still image you wish to print.

2 Press .

- Printing starts. The button flashes and stays on when the printing is completed.
- To continue printing, select (◀▶) another still image.



Selecting the Print Settings

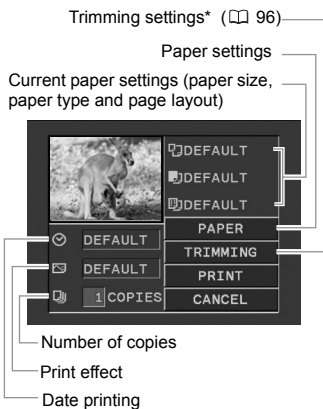

You can select the number of copies and other settings for printing. The setting options vary depending on your printer model.



* **DC50** only. This button does not appear on the print settings screen of the **DC220/DC230**.

Options



[PAPER]
[] PAPER SIZE Available paper sizes vary depending on the printer model.
[] PAPER TYPE Select [PHOTO], [FAST PHOTO] or [DEFAULT].
[] PAGE LAYOUT Select [DEFAULT] or one of the following available page layouts. [BORDERED]: Prints the whole image area almost exactly as the recorded still image. [BORDERLESS]: Enlarges the center portion of the still image to fit the width/height ratio of the selected paper size. The top, bottom and sides of the still image may be slightly trimmed out. [2-UP], [4-UP], [8-UP], [9-UP], [16-UP]: Prints multiple small copies of the same still image on one sheet of paper.

[] (Date print) Select [ON], [OFF] or [DEFAULT].
[] (Print Effect) The print effect can be used with printers compatible with the Image Optimize function to achieve higher quality prints. Select [ON], [OFF] or [DEFAULT]. Canon PIXMA/SELPHY DS printers: You can also select [VIVID], [NR] and [VIVID+NR].
[] (Number of Copies) Select 1-99 copies.

NOTES

Print setting options and [DEFAULT] settings vary depending on the printer model. For details, refer to the printer's instruction manual.

Printing Multiple Images on the Same Sheet

When using Canon printers you can print the same still image multiple times on the same sheet of paper. Use the following table as a guideline for the recommended [] PAGE LAYOUT settings depending on the [] PAPER SIZE setting.

[] PAPER SIZE → Canon Printer ↓	[CREDITCARD]	[9 x 13 cm]	[10 x 14.8 cm]	[A4]
PIXMA SELPHY DS	-	-	2-, 4-, 9- or [16-UP] ¹	[4-UP]
SELPHY CP	2-, 4- or [8-UP] ²	2- or [4-UP]	2- or [4-UP]	-
SELPHY ES	2-, 4- or [8-UP] ³	2- or [4-UP]	2- or [4-UP]	-

¹ You can also use the special sticker sheets.

² When you use the wide-sized photo paper with the [DEFAULT] setting, you can also use [2-UP] or [4-UP].

³ With the [8-UP] setting, you can also use the special sticker sheets.

Printing after Changing the Print Settings



- 1** If the joystick guide does not appear on screen, press (SET) to display it.
- 2** Push the joystick (▼) toward .
 - The print settings menu appears.
 - Depending on the printer, the message "BUSY" may appear before the camcorder displays the print settings menu.
- 3** In the print settings menu, select (▲▼, ◀▶) the setting you want to change and press (SET).
- 4** Select (▲▼) the desired setting option and press (SET).
- 5** Select (▲▼, ◀▶) [PRINT] and press (SET).
 - Printing starts. The print settings menu disappears when the printing is completed.
 - To continue printing, select another still image.

TO CANCEL THE PRINTING

Press (SET) while printing. A confirmation dialog appears. Select [OK] and press (SET). With Canon's PictBridge compatible printers, the printing will stop immediately (even if not completed) and the paper will be fed through.

PRINTING ERRORS

If an error occurs during the printing process, an error message appears (105).

- Canon's PictBridge compatible printers:
Resolve the error. When printing does not resume automatically, select [CONTINUE] and press (SET). If [CONTINUE] cannot be selected, select [STOP], press (SET) and retry printing. Refer also to the printer's instruction manual for details.

- If the error still persists and printing does not restart, disconnect the USB cable and turn off the camcorder and the printer. After a short while, turn them on again, set the camcorder to mode and restore the connection.

WHEN YOU HAVE FINISHED PRINTING

Disconnect the cable from the camcorder and printer and turn off the camcorder.

! IMPORTANT

- The following still images may not be correctly printed with a PictBridge compatible printer.
 - Images created or changed on a computer and transferred to the memory card.
 - Images recorded with the camcorder but edited on a computer.
 - Images whose file names were changed.
 - Images copied from the memory card to the disc.
 - Images not recorded with this camcorder.
- Observe the following precautions during printing:
 - Do not turn off the camcorder or the printer.
 - Do not change the position of the switch.
 - Do not disconnect the USB cable.
 - Do not remove the disc or memory card.
- If the message "BUSY" does not disappear, disconnect the USB cable and restore the connection after a short while.

DC50 Trimming Settings

Set the paper size and page layout before changing the trimming settings.

- 1 In the print settings menu (☰ 93), select (▲▼, ◀▶) [TRIMMING] and press (SET).

The trimming frame appears.



- 2 Change the size of the trimming frame.

- Move the zoom lever toward **T** to shrink the frame, and toward **W** to enlarge it. Press (SET) to change the orientation of the frame (portrait/landscape).
- To cancel the trimming settings, move the zoom lever toward **W** until the trimming frame disappears.



- 3 Move (▲▼, ◀▶) the trimming frame.

- 4 After setting the trimming frame, press (FUNC.) to return to the print menu.

NOTES

- About the color of the trimming frame:
 - White: No trimming settings.
 - Green: Recommended trimming size. (The trimming frame may not appear in green depending on the image size, paper size or borders settings.)

- The trimming setting applies only to one image.
- The trimming setting is canceled in the following cases:
 - When you turn off the camcorder.
 - When you disconnect the USB cable.
 - When you expand the trimming frame beyond its maximum size.
 - When you change the [PAPER SIZE] setting.
- You may not be able to set the trimming settings for a still image not recorded with this camcorder.

Print Orders

From the still images on the memory card, you can mark in advance the images you want to print and set the desired number of copies as a print order. These print order settings are compatible with the Digital Print Order Format (DPOF) standards and can be used for printing on DPOF compatible printers (☰ 92). Up to 998 still images can be selected.

Selecting Still Images for Printing (Print Order)



POINTS TO CHECK

Do not connect the USB cable to the camcorder while setting the print orders.



(☰ 12)

FUNC.
(☰ 31)

FUNC.



FUNC.

FUNC. →

PRINT ORDER



Press (SET)

: The image selection screen appears.

FROM THE IMAGE SELECTION SCREEN

- 1 Select (◀▶) the still image you want to mark with a print order.
- 2 Press (SET) to set the print order.
The number of copies appears in orange in the box next to the print order symbol.
- 3 Set (▲▼) the number of copies desired and press (SET).
To cancel the print order, set (▲▼) the number of copies to 0.
- 4 Repeat steps 1-3 to mark additional images with print orders or press (FUNC.) twice to close the menu.

- 2 Press (FUNC.), select (▲▼) the icon and press (SET) to open the setup menus.
- 3 Select (▲▼) [⇒ PRINT] and press (SET).
 - The print settings menu appears.
 - The error message “SET PRINT ORDER” appears if you connect a printer with direct print function and select [⇒ PRINT] without having set any print orders beforehand.
- 4 Select (▲▼, ▶) [PRINT] and press (SET).
Printing starts. The print settings menu disappears when the printing is completed.

Erasing All Print Orders



FUNC.
(31)

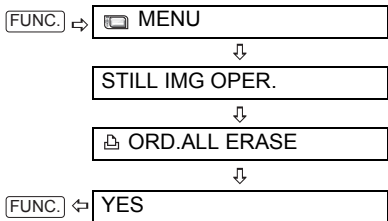

i NOTES

- Depending on the connected printer, you can change some print settings before step 4 (93).
- **Cancel Printing/Printing Errors** (95).
- **Restarting Printing:** Open the print menu as explained in steps 1-3 above. In the print settings menu, select [RESUME] and press (SET). The remaining images will be printed. Printing cannot be restarted when the print order settings have been changed or if you deleted a still image with print order settings.

Printing the Still Images Marked with Print Orders



FUNC.
(31)



- 1 Connect the camcorder to the printer using the supplied USB cable. Refer to *PC Connection Diagrams* (83).

Troubleshooting

If you have a problem with your camcorder, refer to this checklist. Consult your dealer or a Canon Service Center if the problem persists.

Power Source

Problem	Solution	
<ul style="list-style-type: none"> Camcorder will not turn on. The camcorder switches off by itself. The disc compartment cover will not open. LCD/viewfinder switches on and off. 	Battery pack is exhausted. Replace or charge the battery pack.	23
	Attach the battery pack correctly.	
The charge indicator flashes rapidly (approx. twice per second)	Charging has stopped because the compact power adapter or the battery pack is faulty.	—
<ul style="list-style-type: none"> Battery pack will not charge. The charge indicator flashes in an irregular manner. 	Charge the battery pack in temperatures between 0 °C and 40 °C (32 °F and 104 °F).	—
	Battery packs become hot with use and may not charge. When the battery pack is outside the charging temperature range, the CHG (charge) indicator will flash irregularly. The charging will start once the battery pack temperature is below 40 °C (104 °F).	—
	The battery pack is damaged. Use a different battery pack.	—

Recording/Playback

Problem	Solution	
Buttons will not work.	Turn on the camcorder.	—
	Load a disc.	26
Abnormal characters appear on the screen. The camcorder does not operate properly.	Disconnect the power source and reconnect it after a short time. If the problem still persists, disconnect the power source and press the RESET button with a pointed item. Pressing the RESET button resets all settings.	—
"⊘" flashes on the screen.	Load a disc.	26
"⊞" flashes on the screen.	Battery pack is exhausted. Replace or charge the battery pack.	23
DC50/DC20 The wireless controller will not work.	Set [WL.REMOTE] to [ON].	50
	The battery of the wireless controller is exhausted. Replace the battery.	29
Video noise appears on screen.	When using the camcorder in a room where a plasma TV is located, keep a distance between the camcorder and the plasma TV.	—
Video noise appears on the TV screen.	When using the camcorder close to devices that emit strong electromagnetic fields (plasma TVs, cellular phones, etc.), keep a distance between the camcorder and these devices.	—



Problem	Solution	
Even without a disc loaded, when closing the disc compartment cover a motor sound can be heard.	The camcorder is checking if a disc is loaded or not. This is not a malfunction.	–
The disc cannot be ejected.	Turn off the camcorder, disconnect the compact power adapter and remove the battery pack. Restore the power supply and try again.	–
	The camcorder has exceeded its operational temperature. Turn off the camcorder and let it cool down before resuming use.	
The disc cannot be recognized.	The disc is dirty. Clean the disc with a soft lens-cleaning cloth. If the problem persists replace the disc.	108
	The disc is not correctly loaded. Check the disc.	26
	Verify that the camcorder supports the type of DVD disc you inserted.	5
The camcorder vibrates.	Depending on the condition of the disc, the camcorder might vibrate occasionally. This is not a malfunction.	–
<ul style="list-style-type: none"> The disc's rotation can be faintly heard. Occasionally the operation sound can be heard. 	The disc is activated from time to time. This is not a malfunction.	–
After using the camcorder for a long time, " " lights up in red.	This is not a malfunction. Turn the camcorder off and let it cool for a while before resuming operation.	–
DC50 " " flashes red on the screen.	The camcorder malfunctions. Consult a Canon Service Center.	–



Recording

Problem	Solution	
Image will not appear on the screen.	Set the camcorder to CAMERA .	34
"SET THE TIME ZONE, DATE AND TIME" appears on the screen.	Set the time zone, date and time.	32
	Recharge the built-in lithium battery and set the time zone, date and time.	109
Pressing the start/stop button will not start recording.	Set the camcorder to CAMERA .	34
	Load a recommended disc.	6
	The disc is full (" END" flashes on the screen). Delete some recordings (DVD-RW in VR mode) to free some space or replace the disc.	26 69
	The camcorder has exceeded its operational temperature. Turn off the camcorder and let it cool down before resuming use.	–
	Remove the disc protection.	71
	Unfinalize the disc (DVD-RW in VIDEO mode).	79
Even after stopping recording, the disc access indicator does not go off.	The scene or still image is being recorded on the disc. This is not a malfunction.	34 36

Problem	Solution	
The point where the start/stop button was pressed does not match the beginning/end of the recording.	There is a slight interval between pressing the start/stop button and the actual start of the recording on the disc. This is not a malfunction.	–
The recording suddenly stops shortly after starting recording.	The disc is dirty. Clean the disc with a soft lens-cleaning cloth. If the problem persists replace the disc.	108
	The camcorder has exceeded its operational temperature. Turn off the camcorder and let it cool down before resuming use.	–
Camcorder will not focus.	Autofocus does not work on that subject. Focus manually.	56
	Adjust the viewfinder with the dioptic adjustment lever.	28
	Lens is dirty. Clean the lens with a soft lens-cleaning cloth. Never use tissue paper to clean the lens.	110
Sound is distorted.	When recording near loud sounds (such as fireworks or concerts), sound may become distorted. This is not a malfunction.	–
A vertical light bar appears on the screen.	Bright light in a dark scene may cause a vertical light bar (smear) to appear. This is not a malfunction.	–
Viewfinder picture is blurred.	Adjust the viewfinder with the dioptic adjustment lever.	28

Playback/Editing

Problem	Solution	
Pressing the playback button does not start playback.	Load a disc.	26
	Set the camcorder to  .	39
	You may not be able to play with this camcorder, discs recorded or edited with other DVD recorders or computer DVD drives.	–
	If using a single-sided disc, check that the disc is inserted with the label side facing up.	26
	The camcorder has exceeded its operational temperature. Turn off the camcorder and let it cool down before resuming use.	–
<ul style="list-style-type: none"> • During playback there is video noise and the sound is distorted. • The disc cannot be read. 	The disc is dirty. Clean the disc with a soft lens-cleaning cloth.	108
	You may not be able to play with the camcorder discs recorded or edited with other DVD recorders or computer DVD drives.	–
Cannot add scenes to the playlist.	The disc is full ("END" flashes on the screen). Delete some recordings to free some space.	69
	You cannot add more than 999 scenes to the playlist.	–
	Remove the disc protection.	71
Cannot divide the scene.	You cannot edit or delete scenes on a disc that was protected in another digital device.	–
	You cannot divide the scene if there are already 999 scenes on the disc.	–
	You cannot divide the scene if it is too short (1 second or less).	–



Problem	Solution	
Cannot edit the disc title.	You cannot add a title to a DVD-R/DVD-R DL disc after it was finalized.	77
	Unfinalize the disc first (DVD-RW in VIDEO mode).	79
	You may not be able to edit the title if you entered it with another digital device.	–
	Remove the disc protection.	71
Cannot create a Photomovie scene.	The disc is full ("END" flashes on the screen). Delete some recordings (DVD-RW in VR mode) to free some space.	69
Cannot edit or delete scenes.	Remove the disc protection.	71
	You cannot edit or delete scenes on a disc that was protected with another digital device.	–
	Scenes cannot be deleted in a DVD-R/DVD-R DL disc or a DVD-RW disc recorded in VIDEO mode.	–
Cannot finalize the disc.	You cannot finalize a disc (DVD-R/DVD-R DL or DVD-RW) recorded in VIDEO mode if it contains only still images. Record at least one scene before finalizing the disc.	34 77
	The camcorder has exceeded its operational temperature. Turn off the camcorder and let it cool down before resuming use.	–
No sound from the built-in speaker.	Open the LCD panel.	–
	Speaker volume is turned off. Adjust the volume with the joystick and joystick guide in  mode.	40

Playing Back the Disc in an External DVD Device



External DVD device refers to DVD players, DVD recorders, computer's DVD drives and other digital devices.

Problem	Solution	
There is a brief stop between scenes.	Depending on the DVD player, there might be a very short stop between scenes during playback.	–
Disc is running, but image will not appear on the TV screen.	The video input on the TV is not set to the video terminal to which you connected the camcorder. Select the correct video input.	80
	You attempted to play back or dub an incompatible disc. Stop playback/dubbing.	–
The disc cannot be recognized by the device. Or, even though the disc is read, cannot play back the disc or the picture is distorted.	The disc is dirty. Clean the disc with a soft lens-cleaning cloth.	108
	The disc has not been finalized.	77
	DVD-RW discs in VR mode can only be played back with VR mode-compatible DVD players. Refer to the instruction manual of your DVD device.	–
Cannot edit my recordings or add recordings to the disc with the DVD device.	It may not be possible to edit or add recordings with an external DVD recorder on a disc recorded with this camcorder.	–
When writing on a disc in this camcorder recordings transferred from a computer, an error message appears.	The camcorder has exceeded its operational temperature. Turn off the camcorder and let it cool down before resuming use.	–



Memory Card Operation

Problem	Solution	
Memory card cannot be inserted.	Memory card was not facing the correct direction. Turn the memory card over and reinsert it.	28
Memory card cannot be recorded.	Memory card is full. Erase still images to free some space or replace the memory card.	73
	Memory card was not initialized. Initialize the memory card.	76
	The folder and file numbers have reached their maximum value. Set [FILE NOS.] to [RESET] and insert a new memory card.	50
Memory card cannot be played back.	Insert a memory card.	28
	Set the camcorder to  .	41
	Make sure the memory card is selected as the media for still images.	37
Image cannot be erased.	Image is protected. Cancel the protection.	75
"  " flashes in red.	Card error occurred. Turn off the camcorder. Remove and reinsert the memory card. Initialize the memory card if flashing persists.	76

Printing

Problem	Solution	
The printer is not operating even though the camcorder and printer are correctly connected.	Disconnect the USB cable and turn off the camcorder and the printer. After a short while, turn them on again, set the camcorder to  mode and restore the connection.	–

List of Messages

Message	Explanation	
SET THE TIME ZONE, DATE AND TIME	You have not set the time zone, date and time. This message appears each time you turn the power on until you set the time zone, date and time.	32
CHANGE THE BATTERY PACK	Battery pack is exhausted. Replace or charge the battery pack.	23
CANNOT ENTER THE  STANDBY MODE NOW	The camcorder cannot enter the Quick Start standby mode while the disc is being recognized after first inserting it or if the remaining battery charge is too low.	38
UNABLE TO RECOGNIZE THE RECORDING MODE OF THE DISC	The disc may not be recognized by this camcorder if it was initialized with a different device.	–
	You inserted a disc recorded in a different Television System (PAL or SECAM).	–

Message	Explanation	
<ul style="list-style-type: none"> TEMPERATURE TOO HIGH CANNOT RECORD TEMPERATURE TOO HIGH CANNOT REMOVE DISC 	The camcorder has exceeded its operational temperature. Disconnect the compact power adapter and remove the battery and let the camcorder cool down before resuming use.	–
CANNOT RECORD CHECK THE DISC	There is a problem with the disc. Replace the disc.	26
	This message can also appear if condensation has formed. Wait until the camcorder dries completely before resuming use.	110
	The disc's recording surface may be dirty or scratched.	–
REACHED THE MAXIMUM NUMBER OF SCENES	The maximum number of scenes has been reached. Delete some recordings (DVD-RW in VR mode) to free some space or replace the disc.	26 69
CANNOT PLAY DISC	The disc is dirty or you attempted to play back a disc type not supported (not DVD-R/RW).	–
	This message can also appear if condensation has formed. Wait until the camcorder dries completely before resuming use.	110
CANNOT EDIT DISC	There are no scenes to edit or the recording is damaged.	–
	This message can also appear if condensation has formed. Wait until the camcorder dries completely before resuming use.	110
CANNOT DIVIDE THE SCENE	Photomovie scenes cannot be divided.	74
	You may not be able to divide very short scenes.	–
	Scenes cannot be divided when the disc already contains 999 scenes.	–
	You may not be able to further divide scenes shorter than 5 seconds that were created by dividing a previous scene.	–
PLEASE USE ONLY THE RECOMMENDED DISCS	The dual-layered disc you inserted cannot be used with this camcorder.	6
DISC IS FINALIZED CANNOT RECORD	You cannot record additional scenes on a finalized DVD-R/DVD-R DL disc.	–
	You cannot record additional scenes or unfinalize a DVD-RW disc in VIDEO mode that was finalized with another digital device.	–
UNFINALIZE THE DISC	You cannot record additional scenes or convert still images to a Photomovie scene on a finalized DVD-RW in VIDEO mode. Unfinalize the disc first.	79
DISC IS PROTECTED	The disc is protected. Replace the disc or remove the disc protection.	71
CANNOT READ THE DISC CHECK THE DISC	Disc could not be read. Try cleaning it or replace the disc.	108
	This message can also appear if the camcorder has exceeded its operational temperature. Turn off the camcorder and let it cool down before resuming use.	–
	This message can also appear if condensation has formed. Wait until the camcorder dries completely before resuming use.	110
	The disc may not be loaded correctly. Try removing the disc and reinserting it.	26



Message	Explanation	
<ul style="list-style-type: none"> • ACCESS ERROR • DISC ACCESS FAILURE CHECK THE DISC	There was an error when reading the disc or attempting to write onto it. Try cleaning the disc or replace it.	108
	This message can also appear if condensation has formed. Wait until the camcorder dries completely before resuming use.	110
	The disc may not be loaded correctly. Try removing the disc and reinserting it.	26
DISC COVER IS OPEN	Verify the disc is correctly inserted and close the disc cover.	26
NO DISC	No disc is loaded. Insert a disc.	26
	This message can also appear if condensation has formed. Wait until the camcorder dries completely before resuming use.	110
LOADING THE DISC	The disc is being read. Wait before you start recording.	–
AVOID MOVING THE CAMCORDER	Try not to move the camcorder while the image is being recorded.	–
UNABLE TO RECOVER DATA	Could not recover a corrupted file.	–
	This message can also appear if condensation has formed. If you suspect condensation is the reason, do not initialize the disc and wait until the camcorder dries completely before resuming use.	110
DISC FULL	The disc is full (“END” flashes on the screen). Delete some recordings (DVD-RW in VR mode) to free some space or replace the disc.	26 69
TASK IN PROGRESS DO NOT DISCONNECT THE POWER SOURCE	The camcorder is updating important file allocation data on the disc. Do not disconnect the compact power adapter or remove the battery pack.	–
NO CARD	Memory card not is inserted into the camcorder.	28
NO IMAGES	No images are recorded on the memory card.	–
CARD ERROR	A memory card error occurred. The camcorder cannot record or display the image. If the message disappears after 4 seconds and “ ” flashes red, turn the camcorder off, remove the card and reinsert the card. If “ ” changes to green, you can continue recording/playback.	–
CARD FULL	Memory card is full. Erase some images to free some space or replace the memory card.	73
THE CAMCORDER IS SET TO STILL IMAGE MODE	You pressed the Start/Stop button while recording still images (CAMERA mode).	–
NAMING ERROR	The folder and file numbers have reached their maximum value. Set the [FILE NOS.] option to [RESET] and initialize the disc or memory card, erase all the images on the memory card or replace the disc.	–
OPERATION CANCELED	There was a problem with the disc or memory card while copying still images between them.	–
TRANSFER ORDER ERROR	You attempted to set more than 998 transfer orders.	91



Message	Explanation	
TOO MANY STILL IMAGES DISCONNECT USB CABLE	Disconnect the USB cable and decrease the number of still images on the memory card or disc to less than 1800. Images cannot be erased from a DVD-R/DVD-R DL or DVD-RW disc recorded in VIDEO mode. If a dialog appeared on the computer screen, close it and then reconnect the USB cable.	–
COPYRIGHT PROTECTED DUBBING RESTRICTED	You attempted to record copyright-protected contents. May also appear when an anomalous signal is received while recording from the analog video input.	82

Direct Print Related Messages

NOTES

About Canon PIXMA/SELPHY DS Printers: If the printer's error indicator flashes or an error message appears on the printer's operation panel, refer to the printer's instruction manual.

Message	Explanation
PAPER ERROR	There is a problem with the paper. The paper is not correctly loaded or the paper size is wrong. Alternatively, if the paper output tray is closed, open it to print.
NO PAPER	Paper is not correctly inserted or there is no paper.
PAPER JAM	The paper jammed during printing. Select [STOP] to cancel printing. After removing the paper, set some paper again and retry printing.
INK ERROR	There is a problem with the ink.
NO INK	The ink cartridge is not inserted or is out of ink.
LOW INK LEVEL	The ink cartridge needs to be replaced soon. Select [CONTINUE] to restart printing.
INK ABSORBER FULL	Select [CONTINUE] to resume printing. Consult a Canon Service Center (refer to the list included with the printer) to replace the ink absorber.
• FILE ERROR • CANNOT PRINT!	You attempted to print an image that was recorded with another camcorder, with a different compression, or was edited on a computer.
COULD NOT PRINT X IMAGES	You attempted to use the print order settings to print X images that were recorded with another camcorder, with a different compression or were edited on a computer.
SET  PRINT ORDER	No still image on the memory card has been marked with a  print order.
 PRINT ORDER ERROR	You attempted to set more than 998 still images in the print order.
CANNOT TRIM	You attempted to trim an image that was recorded with another camcorder.
READJUST TRIMMING	You changed the print style after you set the trimming settings.
PRINTER ERROR	Cancel printing. Turn off the printer and turn it back on. Check the printer status. If the error still persists, refer to the printer's instruction manual and contact the appropriate customer support center or service center.

Message	Explanation
PRINT ERROR	Cancel printing, disconnect the USB cable and turn off the printer. After a while, turn the printer back on and reconnect the USB cable. Check the printer status. Dc50 When you are printing using the  button, check the print settings.
HARDWARE ERROR	Cancel printing. Turn off the printer and turn it back on. Check the printer status. If the printer is equipped with a battery, it might be exhausted. In such case, turn off the printer, replace the battery and turn it back on.
COMMUNICATION ERROR	The printer is experiencing a data transfer error. Cancel printing, disconnect the USB cable and turn off the printer. After a while, turn the printer back on and reconnect the USB cable. Dc50 When you are printing using the  button, check the print settings. Or, you attempted to print from a memory card that contains a large number of images. Reduce the number of images.
CHECK PRINT SETTINGS	Dc50 The print settings cannot be used for printing with the  button.
INCOMPATIBLE PAPER SIZE	The paper settings of the camcorder conflict with the printer's settings.
PRINTER IN USE	The printer is in use. Check the printer status.
PAPER LEVER ERROR	Paper lever error occurred. Adjust the paper selection lever to the proper position.
PRINTER COVER OPEN	Close the printer cover securely.
NO PRINTHEAD	No print head is installed in the printer or the print head is defective.

Handling Precautions

Camcorder

- Do not subject the camcorder to vibrations or strong impacts while the DISC access indicator is on or flashing. The data may not be correctly recorded on the disc, and the recording may be permanently lost.
- Do not touch the pick up lens.
- Do not carry the camcorder by the LCD panel or the disc cover. Be careful when closing the LCD panel.
- Do not leave the camcorder in places subject to high temperatures (like the inside of a car under direct sunlight), or high humidity.
- Do not use the camcorder near strong electric or magnetic fields such as above TVs, near plasma TVs or mobile phones.
- Do not point the lens or viewfinder at strong light sources. Do not leave the camcorder pointed at a bright subject.
- Do not use or store the camcorder in dusty or sandy places. The camcorder is not waterproof – avoid also water, mud or salt. If any of the above should get into the camcorder it may damage the camcorder and/or the lens. Be sure to close the disc compartment cover after use.
- Be careful of heat generated by lighting equipment.
- Do not disassemble the camcorder. If the camcorder does not function properly, consult qualified service personnel.
- Handle the camcorder with care. Do not subject the camcorder to shocks or vibration as this may cause damage.

Battery Pack

DANGER!

Treat the battery pack with care.

- Keep it away from fire (or it might explode).
- Do not expose the battery pack to temperature higher than 60 °C (140 °F). Do not leave it near a heater or inside a car in hot weather.
- Do not try to disassemble or modify it.
- Do not drop or knock it.
- Do not get it wet.

- Charged battery packs continue to discharge naturally. Therefore, charge them on the day of use, or the day before, to ensure a full charge.
- Contact of the battery terminals with metallic objects may cause a short circuit and damage the battery pack.
- Dirty terminals may cause a poor contact between the battery pack and the camcorder. Wipe the terminals with a soft cloth.
- Since storing a charged battery pack for a long time (about 1 year) can shorten its lifecycle or affect performance, we recommend to discharge the battery pack fully and to store it in a dry place at temperatures no higher than 30 °C (86 °F). If you do not use the battery pack for long periods, charge and discharge it fully at least once a year. If you have more than one battery pack, perform these precautions at the same time for all battery packs.
- Although the battery pack's operating temperature range is from 0 °C to 40 °C (32 °F to 104 °F), the optimal range is from 10 °C to 30 °C (50 °F to 86 °F). At cold temperatures, performance will temporarily decline. Warm it in your pocket before use.

- Replace the battery pack if the usable time after full charge diminishes substantially at normal temperatures.

Mini DVD Disc

The recording surface of DVD discs is extremely delicate. If handled or stored in an incorrect manner, the camcorder may stop recognizing or may not be able to play back the disc. Be sure to observe the following precautions when storing/handling your discs.

- **Always remove the disc from the camcorder after you finish recording.**

- Do not store the camcorder with a disc left inside.
- Keep the disc clean of dust, dirt or smudges. Even very small smudges or particles of dust can lead to problems when recording or playing back the disc. Carefully inspect the recording surface of the disc before inserting it in the camcorder. If the disc gets dirty use a dry, soft lens-cleaning cloth to remove any fingerprints, dirt buildup or smudges from the disc surface. Clean the disc in a radial motion from its center outwards.
- Never use a chemically treated cloth or flammable solvents such as paint thinner to clean the disc.
- Do not bend, scratch or wet the disc and do not subject it to strong shocks.
- Do not attach any labels or stickers on the disc surfaces. The disc may not rotate in a stable manner and this may cause malfunctions.
- To protect the disc, return it to its case for storage.
- When writing on the label side of the disc, avoid hard tip pens. Use waterproof soft-tipped felt pens instead.
- Moving a disc rapidly between hot and cold temperatures may cause condensation to form on its surfaces. If

condensation forms on the disc, put it aside until the water droplets have evaporated completely.

- Never expose the disc to direct sunlight and do not store it in places subject to high temperatures or high humidity.
- Always finalize a disc before inserting it into an external DVD device. Failing to do so can result in the loss of the recorded data.

Memory Card

- We recommend saving backups of memory card images on your computer. Image data may be corrupted or lost due to memory card defects or exposure to static electricity. Canon Inc. makes no warranties for corrupted or lost data.
- Do not turn off the camcorder, disconnect the power source or remove the memory card while the CARD access indicator is flashing.
- Do not use memory cards in places subject to strong magnetic fields.
- Do not leave memory cards in places subject to high humidity and high temperature.
- Do not disassemble, bend, drop, or subject memory cards to shocks and do not expose them to water.
- Do not touch or expose the terminals to dust or dirt.
- Check the direction before inserting the memory card. Forcing a memory card into the slot if it is not correctly oriented may damage the memory card or the camcorder.
- Do not attach any labels or stickers on the memory card.
- When you erase image files or initialize the memory card, only the file allocation table is altered and the data itself is not actually deleted. Take the necessary precautions when you dispose of the

memory card, for example by physically damaging it to prevent the leakage of private data.

Lithium Button Battery

WARNING!

- The battery used in this device may present a fire or chemical burn hazard if mishandled. Do not recharge, disassemble, heat above 100 °C (212 °F) or incinerate the battery.
- Replace the battery with a CR2025 made by Panasonic, Hitachi Maxell, Sony, Sanyo, or with Duracell2025. Use of other batteries may present a risk of fire or explosion.
- Dispose of the used battery according to applicable recycling regulations.

- Do not pick up the battery using tweezers or other metal tools as this will cause a short circuit.
- Wipe the battery with a clean dry cloth to ensure proper contact.
- Keep the battery out of the reach of children. If swallowed, seek medical assistance immediately. The battery case may break and the battery fluids may cause internal damage.
- Do not disassemble, heat or immerse the battery in water to avoid the risk of explosion.

For California, USA only: The lithium battery included contains Perchlorate Material - special handling may apply. See www.dtsc.ca.gov/hazardouswaste/perchlorate for details.

Built-in Rechargeable Lithium Battery

The camcorder has a built-in rechargeable lithium battery to keep the date/time and other settings. The built-in lithium battery is recharged while you use the camcorder, however, it will become totally discharged if you do not use the camcorder for about 3 months.

To recharge the built-in lithium battery:

Connect the compact power adapter to the camcorder and leave it connected for 24 hours with the power switch set to

OFF.

Maintenance/Others

Storage

- If you do not intend to use the camcorder for a long time, store it in a place free of dust, in low humidity, and at temperatures not higher than 30 °C (86 °F).

Cleaning

Camcorder Body

- Use a soft, dry cloth to clean the camcorder body. Never use chemically treated cloth or volatile solvents such as paint thinner.

Pick Up Lens

- Remove any dust or dirt particles using a non-aerosol type blower brush. Never touch the pick up lens directly to clean it.

Lens and Viewfinder

- If the lens surface is dirty, the autofocus may not work properly.
- Remove any dust or dirt particles using a non-aerosol type blower brush.
- Use a clean, soft lens-cleaning cloth to gently wipe the lens or viewfinder. Never use tissue paper.

LCD Screen

- Clean the LCD screen using a clean, soft lens-cleaning cloth.
- Condensation may form on the surface of the screen when the temperature changes suddenly. Wipe it with a soft dry cloth.

Condensation

Moving the camcorder rapidly between hot and cold temperatures may cause condensation (water droplets) to form on its internal surfaces. Stop using the camcorder if condensation is detected. Continued use may damage the camcorder.

Condensation may form in the following cases:

When the camcorder is moved from an air-conditioned room to a warm, humid place

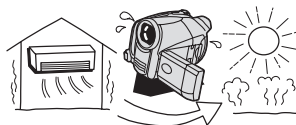

When the camcorder is moved from a cold place to a warm room

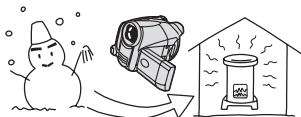

When the camcorder is left in a humid room

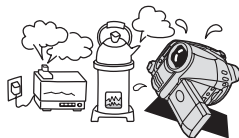

When a cold room is heated rapidly

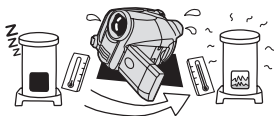

TO AVOID CONDENSATION

- Do not expose the camcorder to sudden or extreme changes in temperature.
- Unload the disc, place the camcorder in an airtight plastic bag and let it adjust to temperature changes slowly before removing it from the bag.

WHEN CONDENSATION IS DETECTED

- The camcorder automatically shuts off. If a disc is loaded, remove the disc immediately and leave the disc cover open. Leaving the disc in the camcorder may damage it.
- A disc cannot be loaded when condensation is detected.

RESUMING USE

- The precise time required for water droplets to evaporate will vary depending on the location and weather conditions. As a general rule, wait for 2 hours before resuming use of the camcorder.

Using the Camcorder Abroad**Power Sources**

You can use the compact power adapter to operate the camcorder and to charge battery packs in any country with power supply between 100 and 240 V AC, 50/60 Hz. Consult the Canon Service Center for information on plug adapters for overseas use.

Playback on a TV Screen

You can only play back your recordings on TVs compatible with the NTSC system. The NTSC system is used in the following countries/areas:

American Samoa, Antigua, Aruba, Bahamas, Barbados, Bermuda, Bolivia, Canada, Chile, Colombia, Costa Rica, Cuba, Ecuador, El Salvador, Guam, Guatemala, Greenland, Haiti, Honduras, Jamaica, Japan, Korea, Mexico, Micronesia, Myanmar, Nicaragua, Panama, Peru, Philippines, Puerto Rico, Saint Kitts and Nevis, Saint Lucia, Saint Vincent and the Grenadines, Surinam, Taiwan, Trinidad and Tobago, USA, Venezuela, Virgin Islands.

System Diagram (Availability differs from area to area)

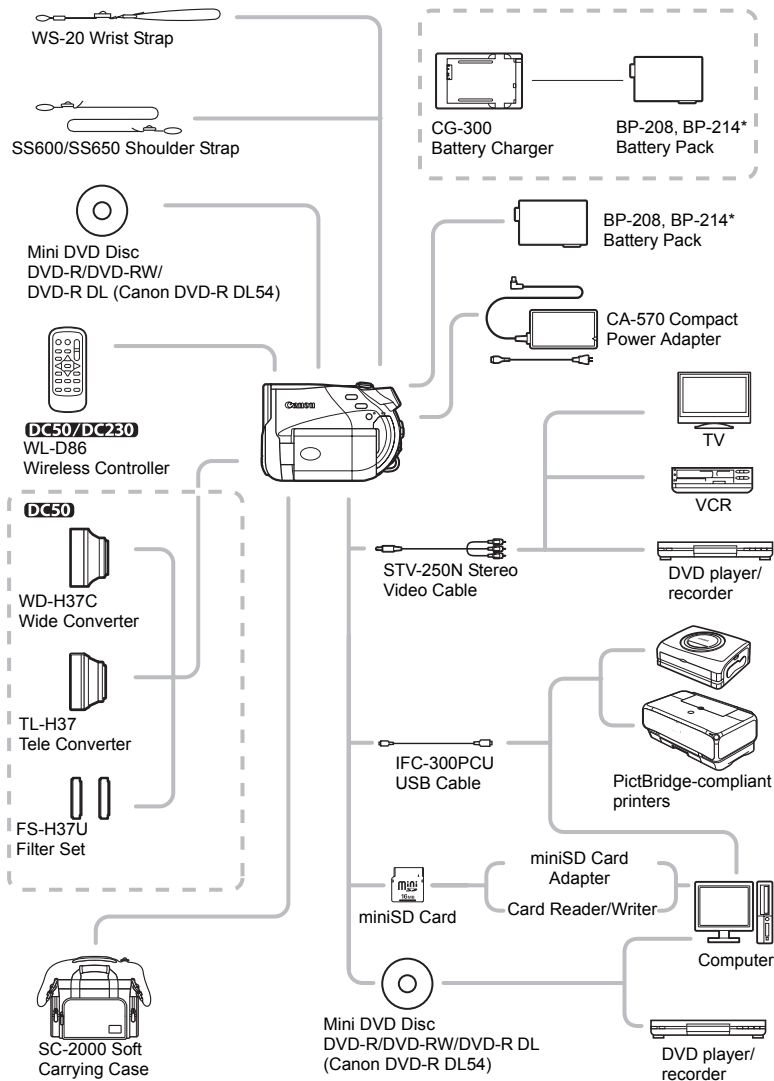

* The BP-214 Battery Pack can only be used with the **DC50**.

Optional Accessories

Call or visit your local retailer/dealer for genuine Canon video accessories. You can also obtain genuine accessories for your Canon camcorder by calling: 1-800-828-4040, Canon U.S.A. Information Center.

Use of genuine Canon accessories is recommended.

This product is designed to achieve excellent performance when used with genuine Canon accessories. Canon shall not be liable for any damage to this product and/or accidents such as fire, etc., caused by the malfunction of non-genuine Canon accessories (e.g., a leakage and/or explosion of a battery pack). Please note that this warranty does not apply to repairs arising out of the malfunction of non-genuine Canon accessories, although you may request such repairs on a chargeable basis.

Battery Packs

When you need extra battery packs, select one of the following models:

DC50 BP-208 or BP-214.

DC20/DC30 BP-208 only.

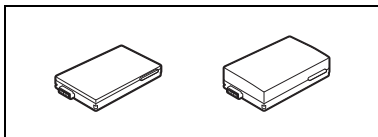

CG-300 Battery Charger

Use the battery charger for charging the battery packs. It plugs directly into a power outlet without a cable.

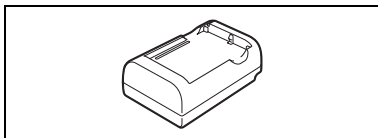

Battery Pack	Charging Time
BP-208	105 min.
BP-214	160 min.

Charging time varies according to the charging condition.

DC50 TL-H37 Tele-converter

This Tele-converter lens increases the focal length of the camcorder lens by a factor of 1.5.

- The image stabilizer is not as effective when the Tele-converter is attached.
- The minimum focusing distance with the TL-H37 is 2.3 m (7.5 ft.); 2.3 cm (0.91 in.) at maximum wide angle.
- When the Tele-converter is attached, a shadow may appear in the picture when you record with flash or assist lamp.

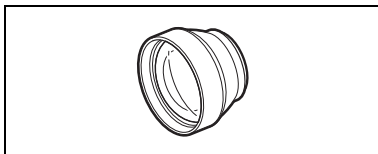

DC50 WD-H37C Wide-converter

This lens decreases focal length by a factor of 0.7, giving you a wide perspective for indoor shots or panoramic views.

- When the Wide-converter is attached, a shadow may appear in the picture when you record with flash or assist lamp.

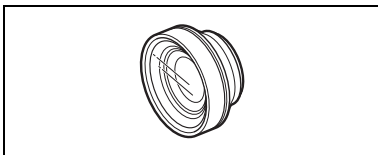
**DC50 FS-H37U Filter Set**

Neutral density and MC protector filters help you to control difficult lighting conditions.

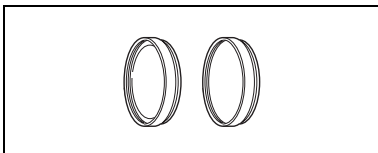
**Shoulder Strap**

You can attach a shoulder strap for more security and portability. Pass the ends through the strap mount and adjust the length of the strap.

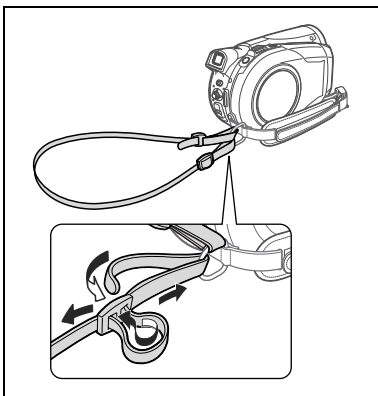
**WS-20 Wrist Strap**

Use this for extra additional protection for active shooting.

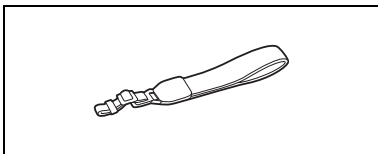
**SC-2000 Soft Carrying Case**

A handy camcorder bag with padded compartments and plenty of space for accessories.



This mark identifies genuine Canon video accessories. When you use Canon video equipment, we recommend Canon-brand accessories or products bearing the same mark.



Product Codes

Provided Accessories

CA-570 Compact Power Adapter	8468A002AA
BP-208 Battery Pack	0802B002AA
DC50/DC230 WL-D86 Wireless Controller	D83-0722-000
STV-250N Stereo Video Cable	3067A002AA (D82-0590-201)
IFC-300PCU USB Cable	D82-0710-001



Optional Accessories

DC50 BP-214 Battery Pack	2068B002AA
CG-300 Battery Charger	0784B002AA
DC50 TL-H37 Tele-converter	8835A001AA
DC50 WD-H37C Wide-converter	1305B001AA
DC50 FS-H37U Filter Set	8837A001AA
WS-20 Wrist Strap	3118A002AA (D81-0190-202)
SC-2000 Soft Carrying Case	9389A001AA

Specifications

DC50/DC220/DC230

System

Disc Recording System	Movies	DVD-VIDEO (VIDEO mode) DVD-VR (VR mode) only with 8 cm DVD-RW Video Compression: MPEG2 Audio Compression: Dolby Digital 2ch
	Still Images	Exif 2.2** compliant with JPEG compression
Television System	EIA standard (525 lines, 60 fields) NTSC color signal	
Compatible Media	8 cm (3 in.) mini DVD discs marked with the DVD-R, DVD-R DL or DVD-RW logo	  
Maximum Recording Time	1.4 GB single sided 8 cm mini DVD disc: XP: approx. 20 min., SP: approx. 30 min., LP: approx. 60 min. 2.6 GB single sided dual-layered 8 cm mini DVD disc: XP: approx. 36 min., SP: approx. 54 min., LP: approx. 108 min.	
Image Sensor	DC50 1/2.7-inch CCD, approx. 5,390,000 pixels	
	Effective pixels:	
	16:9 Movies	approx. 3,690,000 pixels
	4:3 Movies	approx. 3,980,000 pixels
	Still images	approx. 5,000,000 pixels
	DC230 1/6-inch CCD, approx. 1,070,000 pixels	
Effective pixels		
16:9 Movies (Image stabilizer [ON])	approx. 550,000 pixels	
16:9 Movies (Image stabilizer [OFF])	approx. 710,000 pixels	
4:3 Movies	approx. 690,000 pixels	
Still images	approx. 800,000 pixels	
DC220 1/6-inch CCD, approx. 680,000 pixels		
Effective pixels		
16:9 Movies (Image stabilizer [ON])	approx. 360,000 pixels	
16:9 Movies (Image stabilizer [OFF])	approx. 450,000 pixels	
4:3 Movies	approx. 340,000 pixels	
Still images	approx. 450,000 pixels	
LCD Screen	2.7 in., wide, TFT color, approx. 123,000 pixels	
Viewfinder	0.27 in., wide, TFT color, approx. 123,000 pixels	
Microphone	Stereo electret condenser microphone	
Lens	DC50 f=6.1-61 mm, F/1.8-3.0 (when recording movies), 10x power zoom	
	35 mm equivalent:	
	16:9 Movies	43.8 - 438 mm
	4:3 Movies	47.8 - 478 mm
	Still images	39.9 - 399 mm
	DC230 f=2.6-91 mm, F/2.0-5.0, 35x power zoom	
	35 mm equivalent:	
	16:9 Movies (Image stabilizer [ON])	47.1 - 1,649 mm
	16:9 Movies (Image stabilizer [OFF])	41.7 - 1,460 mm
	4:3 Movies	44.6 - 1,561 mm
	Still images	41.5 - 1,453 mm
	DC220 f=2.6-91 mm, F/2.0-5.0, 35x power zoom	
	16:9 Movies (Image stabilizer [ON])	45.8 - 1,603 mm
	16:9 Movies (Image stabilizer [OFF])	41.0 - 1,435 mm
	4:3 Movies	49.8 - 1,743 mm
Still images	43.6 - 1,526 mm	
Lens Configuration	DC50 11 elements in 9 groups (1 double-sided aspheric element) DC220/DC230 10 elements in 8 groups (1 double-sided aspheric element)	
DC50 Filter Diameter	37 mm	

AF system	TTL autofocus, manual focusing possible
Minimum Focusing Distance	1 m (3.3 ft.); 1 cm (0.39 in.) on maximum wide angle
White Balance	Auto white balance, custom white balance and preset white balance settings: DC50 DAYLIGHT, SHADE, CLOUDY, TUNGSTEN, FLUORESCENT, FLUORESCENT H DC220/DC230 DAYLIGHT, TUNGSTEN only
Minimum Illumination	DC50 0.3 lx ([NIGHT] recording program, Shutter speed at 1/2) 4.5 lx (Auto mode, Auto slow shutter [ON], Shutter speed at 1/30) DC230 2 lx ([NIGHT] recording program, Shutter speed at 1/8) 7.5 lx (Auto mode, Auto slow shutter [ON], Shutter speed at 1/30) DC220 1.3 lx ([NIGHT] recording program, Shutter speed at 1/8) 5 lx (Auto mode, Auto slow shutter [ON], Shutter speed at 1/30)
Recommended Illumination	More than 100 lx
Image Stabilization	DC50 Optical Shift Image Stabilizer DC220/DC230 Electronic

Memory Card

Recording Media	miniSD Card*
Size of Still Images	DC50 2592 x 1944, 2048 x 1536, 640 x 480 pixels Simultaneous recording: 1280 x 720, 1152 x 864 pixels DC230 1152 x 864, 640 x 480 pixels Simultaneous recording: 1024 x 768 pixels DC220 1024 x 768, 640 x 480 pixels
File Format	Design rule for Camera File system (DCF), Exif 2.2** compliant, DPOF compliant
Image Compression Method	JPEG (compression: Super Fine, Fine, Normal)

* This camcorder has been tested with miniSD cards up to 1 GB. You may not be able to use certain types of miniSD cards.

** This camcorder supports Exif 2.2 (also called "Exif Print"). Exif Print is a standard for enhancing the communication between camcorders and printers. By connecting to an Exif Print-compliant printer, the camcorder's image data at the time of shooting is used and optimized, yielding extremely high quality prints.

Input/Output Terminals

AV Terminal	∅ 3.5 mm minijack; DC50 Input/Output, DC220/DC230 Output only Video: 1 Vp-p / 75 ohms unbalanced Audio: Output: -10 dBV (47 kohm load) / 3 kohm or less DC50 Input: -10 dBV / 40 kohm or more
USB Terminal	mini-B

Power/Others

Power supply (rated)	7.4 V DC (battery pack), 8.4 V DC (compact power adapter)
Power consumption (SP mode, AF on)	DC50 4.1 W (viewfinder), 4.2 W (LCD screen [NORMAL]) DC230 3.1 W (viewfinder), 3.2 W (LCD screen [NORMAL]) DC220 2.9 W (viewfinder), 3.0 W (LCD screen [NORMAL])
Operating temperature	0 - 40 °C (32 - 104 °F)
Dimensions (W x H x D)	DC50 62 x 90 x 130 mm (2.4 x 3.5 x 5.1 in.) excluding the grip belt DC220/DC230 54 x 90 x 128 mm (2.1 x 3.5 x 5.0 in.) excluding the grip belt
Weight (camcorder body only)	DC50 480 g (1.1 lb.) DC220/DC230 405 g (14.3 oz.)

CA-570 Compact Power Adapter

Power supply	100 – 240 V AC, 50/60 Hz
Rated output / consumption	8.4 V DC, 1.5 A / 29 VA (100 V) – 39 VA (240 V)
Operating temperature	0 – 40 °C (32 – 104 °F)
Dimensions	52 x 29 x 90 mm (2.1 x 1.1 x 3.5 in.)
Weight	135 g (4.8 oz.)

BP-208 Battery Pack

Battery type	Rechargeable Lithium Ion Battery
Rated voltage	7.4 V DC
Operating temperature	0 – 40 °C (32 – 104 °F)
Battery capacity	850 mAh
Dimensions	39 x 8 x 63 mm (1.5 x 0.31 x 2.5 in.)
Weight	40 g (1.4 oz.)

Weight and dimensions are approximate. Errors and omissions excepted. Subject to change without notice.

Index

16:9 aspect ratio 35
 9 Point AiAF (Autofocus) 61

A

Abroad, using the camcorder 111
 AEB - Auto exposure bracketing 62
 AF-assist lamp¹ 65
 Auto (recording program) 52
 Auto slow shutter 45
 Autofocus (AF) 61
 Av (recording program)¹ 53
 AV terminal 80

B

Battery pack, charging 23
 Battery pack, remaining charge 21
 Beach (recording program) 52
 Beep 50
 Built-in backup battery 109

C

Center point (Autofocus) 61
 Compact power adapter 23
 Condensation 110
 Connection to a computer 83
 Connection to a TV/VCR 80
 Continuous shooting 62
 Copying still images 74

D

Data code 63
 Date and time 33
 Daylight saving time 32
 Digital effects 66
 Digital zoom 45
 Direct print 92
 Direct transfer 89
 Disc title 72
 Disc types
 (DVD-R, DVD-R DL, DVD-RW) 5
 Drive mode² 62

E

Erasing still images 73

Error messages 102

F

File numbers 50
 Finalizing the disc 77
 Fireworks (recording program) 52
 Flash¹ 64
 Focus priority 47
 FUNC. menu 31, 43

G

Grip belt 29

H

High-speed continuous shooting 62

I

Image effects 58
 Image jump 42
 Image stabilizer 46
 Index screen - Movies 39
 Index screen - Still images 41
 Initialization - Disc 71
 Initialization - Memory card 76

J

Joystick 11
 Joystick guide 11

L

Language 32
 LCD backlight 30
 LCD screen 30
 Light metering mode 61
 LP mode 44

M

Magnifying a still image 42
 Maintenance 110
 Manual exposure adjustment 55
 Manual focus 56
 Memory card 28, 108
 Mini video light 65
 miniSD card 28
 Mode switch 52
 MyDVD for Canon¹ 83

¹ DC50 only. ² DC50/DC230 only.

N

ND filter	47, 114
Night (recording program)	52
Normal TV (4:3)	51

O

Original recordings	68
---------------------	----

P

P (recording program)	53
Photomovie scene	74
Playback - Movies	39
Playback - Still images	41
Playlist	68
Portrait (recording program)	52
Power save	50
Print order	96
Print/share button ¹	87, 90, 93
Printing still images	92
Protecting still images	75
Protecting the disc	71

Q

Quick Start function	38
----------------------	----

R

Recommended discs	6
Recording - Movies	34
Recording - Still images	36
Recording data	63
Recording mode	44
Recording programs	52
Recording reminder	21
Remote sensor ²	29
RESET	98
Reviewing - Movies (Record review)	35
Reviewing - Still images	47

S

Scene editing	68
Screen displays	20
Screen markers	49
Selecting the on-screen displays	63
Self timer	66
Serial number	15, 17
Setup menus	31, 45

Shoulder strap	114
Simultaneous recording (disc/memory card)	60
Slideshow	41
Snow (recording program)	52
SP mode	44
Sports (recording program)	52
Spotlight (recording program)	52
Still image quality	59
Still image size	59
Sunset (recording program)	52

T

Telephoto	38
Time zone	32
Transfer order	91
Transferring still images	89
Tripod	35
Troubleshooting	98
Tv (recording program)	53

U

USB terminal	83
--------------	----

V

Video input recording	82
VIDEO mode (disc specification)	5
Viewfinder, dioptic adjustment	28
Volume	40
VR mode (disc specification)	5

W

White balance	57
Wide angle	38
Wide TV (16:9)	51
Widescreen	35
Wind screen	47
Wireless controller ²	29

X

XP mode	44
---------	----

Z

Zoom	38
Zoom speed	46

U.S.A.

CANON CONSUMER DIGITAL VIDEO EQUIPMENT LIMITED WARRANTY FOR THE UNITED STATES

The warranty set forward below is given by Canon U.S.A., Inc. with respect to equipment purchased in the United States. The limited warranty is only effective upon presentation of your Bill of Sale or other proof of purchase. Canon consumer DVD equipment is warranted under normal, non-commercial, personal use, against defective materials or workmanship as follows:

Parts: Defective parts will be exchanged for new parts or comparable rebuilt parts for a period of ONE YEAR from the date of original purchase, except for a defective Video Head, which will be exchanged for a period of three months from the date of purchase.

Labor: For a period of ONE YEAR from the date of original purchase, labor will be provided free of charge by our factory service centers or designated service facilities located in the United States.

When returning equipment under this warranty, you must pre-pay the shipping charges, and you must enclose the Bill of Sale or other proof of purchase with a complete explanation of the problem. During your ONE-YEAR warranty period, repairs will be made and the equipment return-shipped to you free of charge. After your warranty period is over, you will be given an estimate of the cost of repair and an opportunity to approve or disapprove of the repair expense before it is incurred. If you approve, repairs will be made and the equipment return-shipped to you. (shipping charges apply). If you disapprove, we will return-ship the equipment at no charge to you.

Non-Canon brand peripheral equipment and software which may be distributed with Canon DVD camcorders are sold "AS IS" without warranty of any kind by CUSA, including any implied warranty regarding merchantability or fitness for a particular purpose. The sole warranty with respect to such non-Canon brand items is given by the manufacturer or producer thereof.

CUSA shall have no responsibility under this limited warranty for use of Canon DVD Camcorders in conjunction with incompatible peripheral equipment and incompatible software.

In order to obtain warranty service, contact the authorized Canon retail dealer from whom you purchased the DVD Camcorder or call the CANON INFORMATION CENTER AT 1-800-828-4040). You will be directed to the nearest service facility for your product.

This Limited Warranty covers all defects encountered in normal use of the equipment and does not apply in the following cases:

- A) Loss or damage to the equipment due to abuse, mishandling, accident, improper maintenance, or failure to follow operating instructions;
- B) If the equipment is defective as a result of leaking batteries, sand, dirt or water damage;
- C) If defects or damages are caused by the use of unauthorized parts or by service other than our authorized agent;
- D) If the equipment is used for commercial or industrial use.

This Limited Warranty does not cover cabinet (exterior finish), DVD discs, nor does it apply to equipment purchased outside the United States. This warranty does not cover units sold to rental firms, military operations, hotels, schools, hospitals or for other commercial, industrial, or institutional applications. These uses are covered only by such specific warranty as Canon may issue with such sales.

This Limited Warranty does not apply to accessories or consumables for the DVD Camcorder, which are sold "AS IS", without warranty of any kind by CUSA.

Please retain this warranty card and your Bill of Sale as a permanent record of your purchase. This card is most important in order to be sure you are contacted right away should there be a safety inspection, modification or product recall under applicable laws or regulations.

NO IMPLIED WARRANTY, INCLUDING MERCHANTABILITY AND FITNESS FOR A PARTICULAR PURPOSE APPLIES TO THIS EQUIPMENT AFTER THE APPLICABLE PERIOD OF EXPRESS WARRANTY OR GUARANTY, EXCEPT AS MENTIONED ABOVE, GIVEN BY ANY PERSON, FIRM OR CORPORATION WITH RESPECT TO THIS EQUIPMENT SHALL BIND THE UNDERSIGNED. (SOME STATES DO NOT ALLOW LIMITATIONS ON HOW LONG AN IMPLIED WARRANTY LASTS, SO THE ABOVE LIMITATION OR EXCLUSION MAY NOT APPLY TO YOU). CUSA SHALL NOT BE LIABLE FOR LOSS OF REVENUES OR PROFITS, EXPENSE FOR SUBSTITUTE EQUIPMENT OR SERVICE, STORAGE CHARGES, LOSS OF DATA, OR ANY OTHER SPECIAL, INCIDENTAL OR CONSEQUENTIAL DAMAGES CAUSED BY THE USE, MISUSE OR INABILITY TO USE THE DV CAMCORDER, REGARDLESS OF THE LEGAL THEORY ON WHICH THE CLAIM IS BASED, AND EVEN IF CUSA HAS BEEN ADVISED OF THE POSSIBILITY OF SUCH DAMAGES. NOR SHALL RECOVERY OF ANY KIND AGAINST CUSA BE GREATER THAN THE PURCHASE PRICE OF THE DV CAMCORDER SOLD BY CUSA AND CAUSING THE ALLEGED DAMAGE. WITHOUT LIMITING THE FOREGOING, YOU ASSUME ALL RISK AND LIABILITY FOR LOSS, DAMAGE OR INJURY TO YOU AND YOUR PROPERTY AND TO OTHERS AND THEIR PROPERTY ARISING OUT OF USE, MISUSE OR INABILITY TO USE THE DV CAMCORDER NOT CAUSED DIRECTLY BY THE NEGLIGENCE OF CUSA. (SOME STATES DO NOT ALLOW THE EXCLUSION OR LIMITATION OF INCIDENTAL OR CONSEQUENTIAL DAMAGES, SO THE ABOVE LIMITATION MAY NOT APPLY TO YOU). THIS WARRANTY SHALL NOT EXTEND TO ANYONE OTHER THAN THE ORIGINAL PURCHASER OF THIS EQUIPMENT OR THE PERSON FOR WHOM IT WAS PURCHASED AS A GIFT.

This warranty gives you specific legal rights, and you may also have other rights which vary from state to state. CANON U.S.A., INC.

CANADA**CANON CONSUMER DIGITAL VIDEO EQUIPMENT LIMITED WARRANTY**

The limited warranty set forth below is given by Canon Canada Inc. ("Canon Canada") with respect to Canon DVD equipment purchased in Canada. This limited warranty is only effective upon presentation of a bill of sale or other proof of purchase for this Canon digital video equipment to a Canon Service Facility when repairs are required.

Canon consumer video digital equipment is warranted under normal, non-commercial, personal use, against defective materials or workmanship as follows:

Parts: Defective parts will be exchanged for new parts or, at Canon Canada's option, comparable rebuilt parts for a period of one year from the date of original purchase, except Video Heads which will be exchanged for a period of 3 months from the date of purchase.

Labour: For a period of one year from the date of original purchase, labour will be provided free of charge by our Canon Service Facilities in Canada.

This limited warranty covers all defects except where:

(a) The loss or damage to the product results from:

- i) accident, natural disaster, mishandling, abuse, neglect, unauthorized product modification or failure to follow instructions contained in the instruction manual;
- ii) the use of accessories, attachments, products, supplies, parts or devices with this Canon product that do not conform to Canon specifications or that cause abnormally frequent service problems;
- iii) repairs or services performed by any party other than a Canon Service Facility;
- iv) defective batteries or any exposure to water, sand or dirt;
- v) shipping (claim must be presented to the shipper);

(b) Any serial number on the video equipment is altered or removed.

(c) The digital video equipment is used for commercial, professional or industrial purposes.

This limited warranty does not cover the cabinet (exterior finish) of the DVD equipment, DVD discs, nor does it apply to DVD equipment purchased outside Canada.

TO OBTAIN WARRANTY SERVICE

Ship your Canon digital video equipment in its original carton, box or equivalent, properly packed, fully insured with shipping charges prepaid, together with a copy of your bill of sale or other proof of purchase and a description of the problem to any of the Canon Service Facilities in Canada.

LIMITATIONS

Except as otherwise required by applicable legislation, this warranty is in lieu of all other warranties, conditions, guarantees or representations, express or implied, statutory or otherwise, relative to this Canon product, including implied warranties or conditions of merchantability or fitness for a particular purpose.

Canon Canada assumes no liability for special, consequential or incidental damages or loss that may arise, whether on account of negligence or otherwise, from the use, misuse or inability to use this Canon product (including loss of profit, revenue, discs or enjoyment) or from failure to conform to any express or implied warranties, conditions, guarantees or representations. Any recovery under this limited warranty shall not exceed the purchase price of the product. Canon Canada does not assume or authorize any other person to assume for Canon Canada any other liability with respect to this Canon product.

This warranty does not extend to any person other than the original purchaser of this Canon product or the person for whom it was purchased as a gift and states your exclusive remedy.

NOTICE TO CONSUMER

If you plan to take important videos or if the product has not been used for some time, please check all functions with the instruction book before using it.



CANON INC.

U.S.A.

CANON U.S.A., INC. NEW JERSEY OFFICE
100 Jamesburg Road, Jamesburg, NJ 08831 USA

CANON U.S.A., INC. CHICAGO OFFICE
100 Park Blvd., Itasca, IL 60143 USA

CANON U.S.A., INC. LOS ANGELES OFFICE
15955 Alton Parkway, Irvine, CA 92618 USA

CANON U.S.A., INC. HONOLULU OFFICE
210 Ward Avenue, Suite 200, Honolulu, HI 96814 USA

- If you have any questions, call the Canon U.S.A. Information Center toll-free at 1-800-828-4040 (U.S.A. only).

CANADA

CANON CANADA INC. NATIONAL HEADQUARTERS
6390 Dixie Road, Mississauga, Ontario L5T 1P7

CANON CANADA INC. CALGARY
2828, 16th Street, N.E. Calgary, Alberta T2E 7K7

CANON CANADA INC. MONTREAL
5990 Côte de Liesse, Quebec H4T 1V7

- If you have any questions, call the Canon Canada Information Center toll-free at 1-800-828-4040 (CANADA only).

- Si vous avez des questions, veuillez téléphoner sans frais au Canada 1-800-828-4040 (CANADA seulement).

MEXICO

CANON MEXICANA, S. DE R.L. DE C.V.
Periferico Sur No. 4124 Col. Ex-Rancho de Anzaldo C.P. 01900
México, D.F., México

CANON U.S.A., INC. NEW JERSEY OFFICE
100 Jamesburg Road, Jamesburg, NJ 08831 USA

**CENTRO Y
SURAMÉRICA**

CANON LATIN AMERICA, INC.
703 Waterford Way Suite 400 Miami, FL 33126 USA

ASIA

CANON HONGKONG COMPANY LTD.
19/F, The Metropolis Tower, 10 Metropolis Drive, Hunghom, Kowloon,
Hong Kong



The information on this manual is verified as of January 1st, 2007.
Les informations contenues dans ce manuel ont été vérifiées le 1er janvier 2007.
La información de este manual fue verificada el 1 de enero de 2007.



Printed on 100% reused paper.
Document réalisé avec du papier recyclé à 100%.
El papel aquí utilizado es 100% reciclado.