

ELECTRONIC CASH REGISTER

TK-1550

THANK YOU
YOUR RECEIPT
CALL AGAIN !

GROCERY
DAIRY
H. B. A.
FROZEN
FOOD
DELICATESSEN

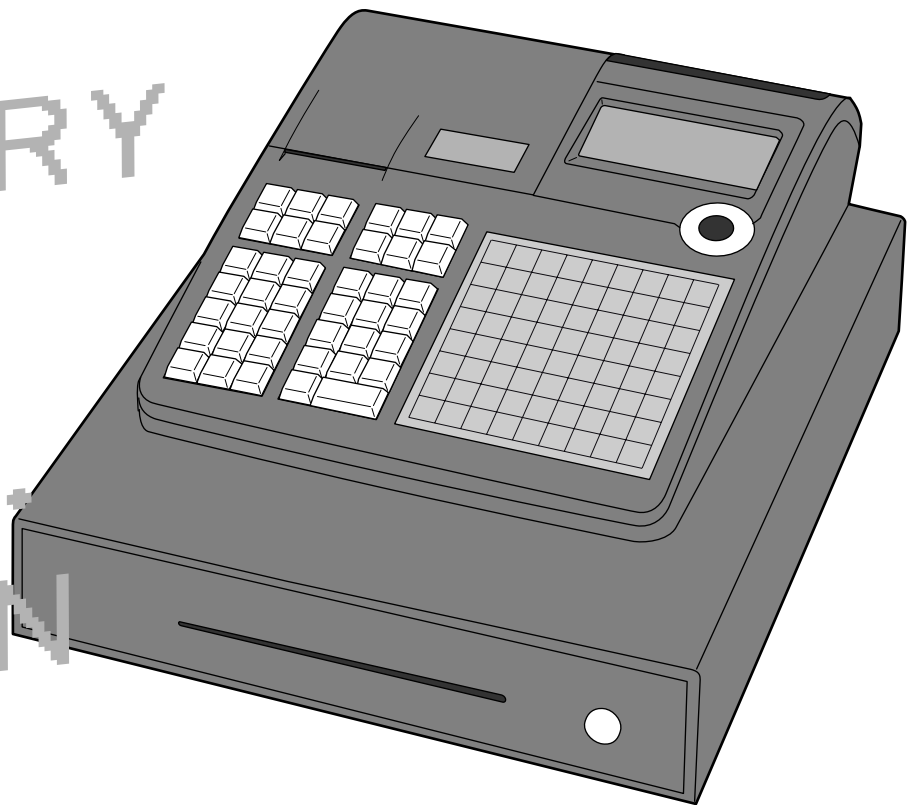

USER'S MANUAL

CI

CASIO[®]

Introduction & Contents

Important!

Your new cash register has been carefully tested before shipment to ensure proper operation. Safety devices eliminate worries about breakdowns resulting from operator errors or improper handling. In order to ensure years of trouble-free operation, however, the following points should be noted when handling the cash register.

Do not locate the cash register where it will be subjected to direct sunlight, high humidity, splashing with water or other liquids, or high temperature (such as near a heater).

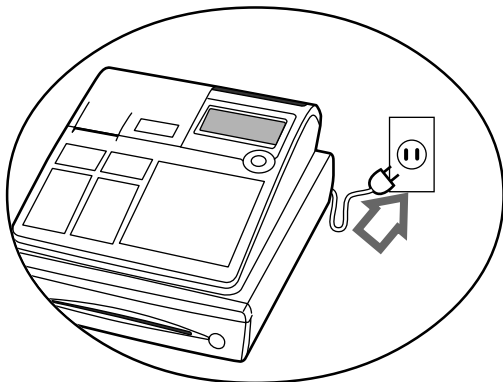
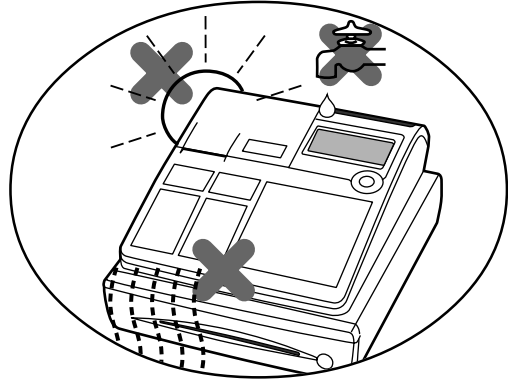

Be sure to check the sticker on the side of the cash register to make sure that its voltage matches that of the power supply in the area.

Never operate the cash register while your hands are wet.

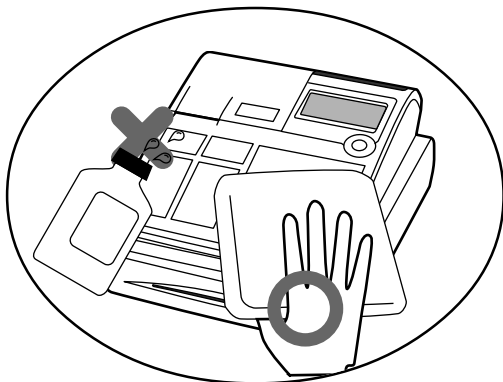
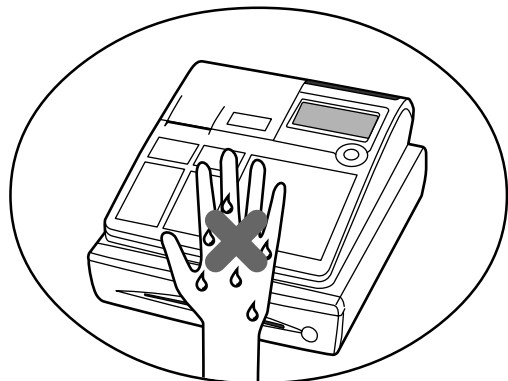

Use a soft, dry cloth to clean the exterior of the cash register. Never use benzene, thinner, or any other volatile agent.

Never try to open the cash register or attempt your own repairs. Take the cash register to your authorized CASIO dealer for repairs.

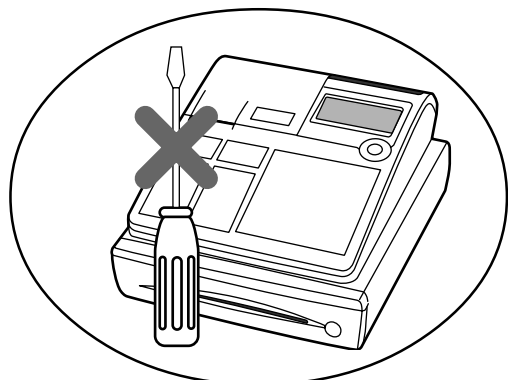

Welcome to CASIO Cash Register!

Congratulations upon your selection of a CASIO Electronic Cash Register, which is designed to provide years of reliable operation.

Operation of a CASIO cash register is simple enough to be mastered without special training.

Everything you need to know is included in this manual, so keep it on hand for reference.

Consult your CASIO dealer if you have any questions about points not specifically covered in this manual.

GUIDELINES LAID DOWN BY FCC RULES FOR USE OF THE UNIT IN THE U.S.A. (Not applicable to other areas)

WARNING: This equipment has been tested and found to comply with the limits for a Class A digital device, pursuant to Part 15 of the FCC Rules. These limits are designed to provide reasonable protection against harmful interference when the equipment is operated in a commercial environment. This equipment generates, uses, and can radiate radio frequency energy and, if not installed and used in accordance with the instruction manual, may cause harmful interference to radio communications. Operation of this equipment in a residential area is likely to cause harmful interference in which case the user will be required to correct the interference at his own expense.

FCC WARNING: Changes or modifications not expressly approved by the party responsible for compliance could void the user's authority to operate the equipment.

Please keep all information for future reference.

The main plug on this equipment must be used to disconnect mains power.
Please ensure that the socket outlet is installed near the equipment and shall be easily accessible.

Introduction & Contents

Safety Precautions

- To use this product safely and correctly, read this manual thoroughly and operate as instructed.
After reading this guide, keep it close at hand for easy reference.
Please keep all informations for future reference.
- Always observe the warnings and cautions indicated on the product.

About the icons

In this guide various icons are used to highlight safe operation of this product and to prevent injury to the operator and other personnel and also to prevent damage to property and this product. The icons and definitions are given below.



Indicates that there is a risk of severe injury or death if used incorrectly.



Indicates that injury or damage may result if used incorrectly.

Icon examples

To bring attention to risks and possible damage, the following types of icons are used.



The \triangle symbol indicates that it includes some symbol for attracting attention (including warning). In this triangle the actual type of precautions to be taken (electric shock, in this case) is indicated.



The \otimes symbol indicates a prohibited action. In this symbol the actual type of prohibited actions (disassembly, in this case) will be indicated.



The \bullet symbol indicates a restriction. In this symbol the type of actual restriction (removal of the power plug from an outlet, in this case) is indicated.

Warning!

Handling the register



Should the register malfunction, start to emit smoke or a strange odor, or otherwise behave abnormally, immediately shut down the power and unplug the AC plug from the power outlet. Continued use creates the danger of fire and electric shock.

- Contact CASIO service representative.



Do not place containers of liquids near the register and do not allow any foreign matter to get into it. Should water or other foreign matter get into the register, immediately shut down the power and unplug the AC plug from the power outlet. Continued use creates the danger of shorting, fire and electric shock.

- Contact CASIO service representative.



Should you drop the register and damage it, immediately shut down the power and unplug the AC plug from the power outlet. Continued use creates the danger of shorting, fire and electric shock.

- Attempting to repair the register yourself is extremely dangerous. Contact CASIO service representative.



Never try to take the register apart or modify it in any way. High-voltage components inside the register create the danger of fire and electric shock.

- Contact CASIO service representative for all repair and maintenance.
-

⚠ Warning!

Power plug and AC outlet



Use only a proper AC electric outlet (100V~240V) . Use of an outlet with a different voltage from the rating creates the danger of malfunction, fire, and electric shock. Overloading an electric outlet creates the danger of overheating and fire.



Make sure the power plug is inserted as far as it will go. Loose plugs create the danger of electric shock, overheating, and fire.

- Do not use the register if the plug is damaged. Never connect to a power outlet that is loose.



Use a dry cloth to periodically wipe off any dust built up on the prongs of the plug. Humidity can cause poor insulation and create the danger of electric shock and fire if dust stays on the prongs.

Never use detergent to clean the power cord, especially the plug and jack.



Do not allow the power cord or plug to become damaged, and never try to modify them in any way. Continued use of a damaged power cord can cause deterioration of the insulation, exposure of internal wiring, and shorting, which creates the danger of electric shock and fire.

- Contact CASIO service representative whenever the power cord or plug requires repair or maintenance.

⚠ Caution!



Do not place the register on an unstable or uneven surface. Doing so can cause the register — especially when the drawer is open — to fall, creating the danger of malfunction, fire, and electric shock.



Do not place the register in the following areas.

- Areas where the register will be subject to large amounts of humidity or dust, or directly exposed to hot or cold air.
- Areas exposed to direct sunlight, in a close motor vehicle, or any other area subject to very high temperatures.

The above conditions can cause malfunction, which creates the danger of fire.



Do not overlay bend the power cord, do not allow it to be caught between desks or other furniture, and never place heavy objects on top of the power cord. Doing so can cause shorting or breaking of the power cord, creating the danger of fire and electric shock.



Be sure to grasp the plug when unplugging the power cord from the wall outlet. Pulling on the cord can damage it, break the wiring, or cause short, creating the danger of fire and electric shock.



Never touch the plug while your hands are wet. Doing so creates the danger of electric shock. Pulling on the cord can damage it, break the wiring, or cause short, creating the danger of fire and electric shock.

Never touch the printer head, platen and cutter.

Introduction & Contents

Introduction & Contents	2
Getting Started	10
1. Load the memory protection batteries and Paper rolls	10
2. Install receipt / journal paper.	11
3. Plug the cash register into a wall outlet.	13
4. Insert the mode key marked "PGM" into the mode switch.	13
5. Turn the mode switch to the "PGM" position.	13
6. Set the date.	13
7. Set the time.	13
8. Tax table programming	14
9. Select watermark on receipt.	16
10. Department unit price programming	17
11. PLU unit price programming	17
12. Discount rate programming	17
13. Issuing daily reset report	17
14. Advanced operations and Setups	18
15. Issuing reports	18
16. Troubleshooting	18
Introducing the Register	20
General guide	20
Roll paper	20
Mode key	20
Drawer	20
Drawer lock / Drawer key	20
Magnetic plate	20
Mode switch	21
How to set the Pop-up display	21
How to set the menu sheet	21
Display	22
Display panel	22
Main display	22
Customer display	22
Keyboard	24
Allocatable functions	26
Basic Operations and Setups	28
How to read the printouts	28
How to use your cash register	29
Before business hours	30
Checking the time and date	30
To display and clear the date/time	30
Preparing coins for change	30
Preparing and using department keys	31
Registering department keys	31
Programming department keys	33
To program a unit price for each department	33
To program the tax calculation status for each department	33
To program high amount limit for each department	33
Registering department keys by programming data	34
Preset price	34
Preset tax status	34
Locking out high amount limitation	34

Preparing and using PLUs	35
Programming PLUs	35
To program a unit price for each PLU	35
To program tax calculation status for each PLU	35
Registering PLUs	36
Preparing and using discounts	38
Programming discounts	38
Registering discounts	38
Discount for items and subtotals	38
Preparing and using reductions	39
Programming for reductions	39
To program preset reduction amount	39
Registering reductions	39
Reduction for items and subtotal	39
Registering credit and check payments	40
Check	40
Charge	40
Credit	40
Mixed tender (cash and check)	40
Shifting the taxable status of an item	41
Calculation merchandise subtotal	41
Registering returned goods in the REG mode	42
Registering returned goods in the RF mode	42
Registering money received on account	43
Registering money paid out	43
No sale registration	43
Making corrections in a registration	44
To correct an item you input but not yet registered	44
To correct an item you input and registered	45
To cancel all items in a transaction	46
Printing the daily sales reset report	47
Advanced Operations	48
Using clerk functions	48
Enable clerk feature	48
Assigning a clerk	48
Clerk number key	48
Single item cash sales	49
Currency exchange function	50
Registering foreign currency	50
Full amount tender in foreign currency	50
Partial tender in a foreign currency	51
Premium	52
Coupon	52
Age verification	53
Check tracking systems	54
Check tracking system	54
Opening a check	54
Adding to a check	54
Issuing a guest receipt	55
Closing a check memory	55
New / old check key operation	55
Add check	56
Flat-PLU	57
Text recall	57
Inputting the number of customers	57
Clerk interrupt function	58

Introduction & Contents

Condiment / preparation PLUs	59
Set menu	59
Arrangement key registrations	60
Tips	60
Item correction by using VOID key	61
Addition	61
Programming department / PLU descriptors and preset messages in the list	62
How to choose and set the department / PLU descriptors in the list	62
How to choose and set the preset receipt message and graphic logo in the list	62
Preset message and graphic print sample	62
Character manual input	63
Entering characters	63
Using character keyboard	63
Entering characters by multi tapping	64
Programming descriptors and messages by entering characters	65
Programming PLU descriptor	65
Programming department / flat-PLU / function key descriptor	66
Function key	66
Department key	66
Flat-PLU key	66
Programming message	67
Receipt message	67
Programming Clerk name	67
Clerk name	67
Programming other descriptors	68
Report descriptor	68
Text recall character	69
Grand total, special character	69
Report title	69
Machine feature program	70
General control program	70
Programming procedure	70
Program data (by address code)	70
Address code 02 (machine number)	70
Address code 03 (consecutive number)	70
Address code 04 (tax system)	70
Address code 05 (print control for receipt)	71
Address code 06 (calculation & operation control)	71
Address code 08 (print control for fixed total report)	72
Address code 10 (print control for taxable amount)	72
Address code 14 (currency exchange control)	73
Address code 15 (print control for reports)	73
Address code 16 (print control for grand total)	74
Address code 17 (print control)	74
Address code 18 (print control for guest receipt)	74
Address code 19 (receipt control)	74
Address code 21 (message control)	75
Address code 26 (check tracking)	75
Address code 27 (clerk control)	75
Address code 30 (thermal printer control)	76
Address code 34 (backlight control)	76

Key function program	78
Department key/Flat-PLU key/PLU program (Batch feature programming)	78
Programming procedure	78
Program data	78
Department key/Flat-PLU key/PLU program (Individual feature programming)	79
Programming procedure	79
Program data (by address code)	80
Transaction key program	81
Programming procedure	81
Program data	81
Clerk program	85
Clerk number, check number programming	85
Clerk other programming	85
Set menu programming	86
Arrangement programming	86
Keyboard layout change	87
Programming the function of each key	87
Printing read/reset reports	88
To print the individual department, PLU read report	88
To print daily read reports (except open check)	89
To print open check read report	89
To print daily reset reports (except open check)	90
To print open check reset report	90
Read / reset report sample	91
To print the periodic 1/2 sales read/reset reports	94
Reading the cash register's program	96
To print unit price/rate program (except PLU)	96
To print key descriptor, name, message program (except PLU)	96
To print the machine program (except PLU)	97
To print the PLU unit price	98
To print the PLU descriptor	98
To print the PLU program	98
To print the key allocation program	98
Troubleshooting	100
When an error occurs	100
When the register does not operate at all	102
Clearing a machine lock up	102
In case of power failure	103
When the L sign appears on the display	103
User Maintenance and Options	104
To replace journal paper	104
To replace receipt paper	105
Options	105
Specifications	106
Index	107

Getting Started

This chapter shows how to setup the cash register and get it ready to operate. Please read this chapter even if you have used a cash register before.

1. Load the memory protection batteries and Paper rolls

Load the two memory protection batteries



printer cover

1. Remove the printer cover and open the platen arm (receipt side).



platen arm

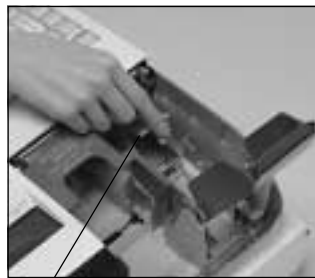

2. Remove the battery compartment cover.

battery compartment cover



3. Note the (+) and (-) markings in the battery compartment. Load a set of two new alkaline batteries so that their positive (+) and negative (-) ends are facing as indicated by the markings.



No battery is included in the accessories.

4. Replace the battery compartment cover.

5. Close the platen arm and replace the printer cover.

Important!

These batteries protect information stored in your cash register's memory when there is a power failure or when you unplug the cash register. Be sure to install these batteries.

WARNING!

- Never try to recharge the batteries supplied with the unit.
- Do not expose batteries to direct heat, let them become shorted or try to take them apart.

Keep batteries out of the reach of small children. If your child should swallow a battery, consult a physician immediately.

2. Install receipt / journal paper.

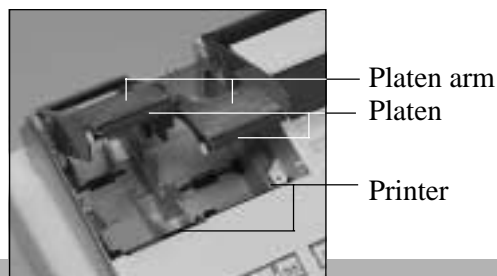

Important!

Take away the head protection sheet from the printer and close the platen arm.

Caution! (in handling the thermal paper)

- Never touch the printer head and the platen.
- Unpack the thermal paper just before your use.
- Avoid heat/direct sunlight.
- Avoid dusty and humid places for storage.
- Do not scratch the paper.
- Do not keep the printed paper under the following circumstances:
High humidity and temperature/direct sunlight/contact with glue, thinner or a rubber eraser.

To install receipt paper



Step 1

Remove the printer cover.



Step 4

Put the leading end of the paper over the printer.



Step 2

Open the platen arm.



Step 5

Close the platen arm slowly until it locks steadily.



Step 3

Ensuring the paper is being fed from the bottom of the roll, lower the roll into the space behind the printer.



Complete

Replace the printer cover, passing the leading end of the paper through the cutter slot. Tear off the excess paper.

To install journal paper



Step 1

Remove the printer cover.



Step 2

Open the platen arm.



Step 7

Slide the leading end of the paper into the groove on the spindle of the take-up reel and wind it onto the reel two or three turns.



Step 3

Ensuring the paper is being fed from the bottom of the roll, lower the roll into the space behind the printer.



Step 8

Replace the paper guide of the take-up reel.



Step 4

Put the leading end of the paper over the printer.



Step 9

Place the take-up reel into place behind the printer, above the roll paper.



Step 5

Close the platen arm slowly until it locks steadily.



Step 10

Press the  key to take up any slack in the paper.

During machine installation, press the  key after power on.



Step 6

Remove the paper guide of the take-up reel.



Complete

Replace the printer cover.

3. Plug the cash register into a wall outlet.

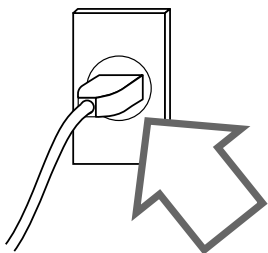

Be sure to check the sticker (rating plate) on the side of the cash register to make sure that its voltage matches that of the power supply in your area.

4. Insert the mode key marked “PGM” into the mode switch.

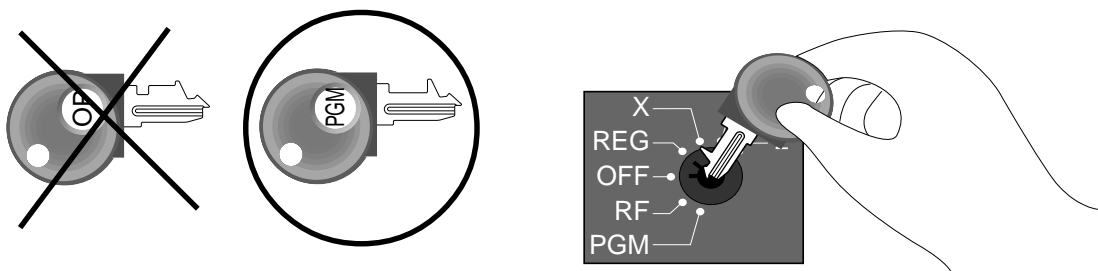

5. Turn the mode switch to the “PGM” position.

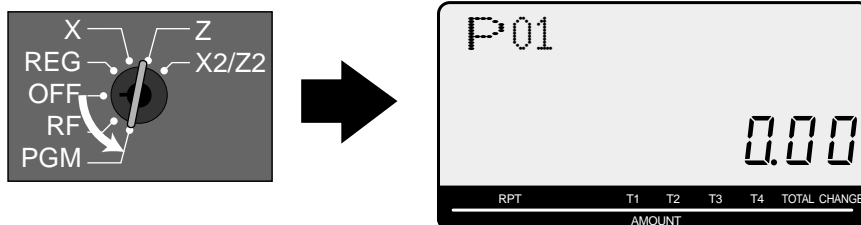

When the display shows “Low battery”, load memory protection batteries (refer to page 10).

6. Set the date.

1. Enter current date in year - month - day order, and press the <X/FOR>

Example: June 15, 2008 ⇒ **0 8 0 6 1 5**

2. Press <C> key.

Example: **C**

7. Set the time.

1. Enter current time in 24 hour system, and press the <X/FOR>

Example: 08:30 AM ⇒ **0 8 3 0** (9:45 PM ⇒ **2 1 4 5**)

2. Press <C> key.

Example: **C**

8. Tax table programming

Programming automatic tax calculation

Important!

After you program the tax calculations, you also have to individually specify which departments (page 33) and PLUs (page 35) are to be taxed.

For this cash register to be able to automatically register state sales tax, you must program its tax tables with tax calculation data from the tax table for your state. There are three tax tables (U. S.) and four tax tables (Canada) that you can program for automatic calculation of three/four separate sales taxes.

Programming for the U.S. tax tables procedure

There are two ways to set up the U.S. tax tables:

A) Input the desired tax rate / Changing the tax rate

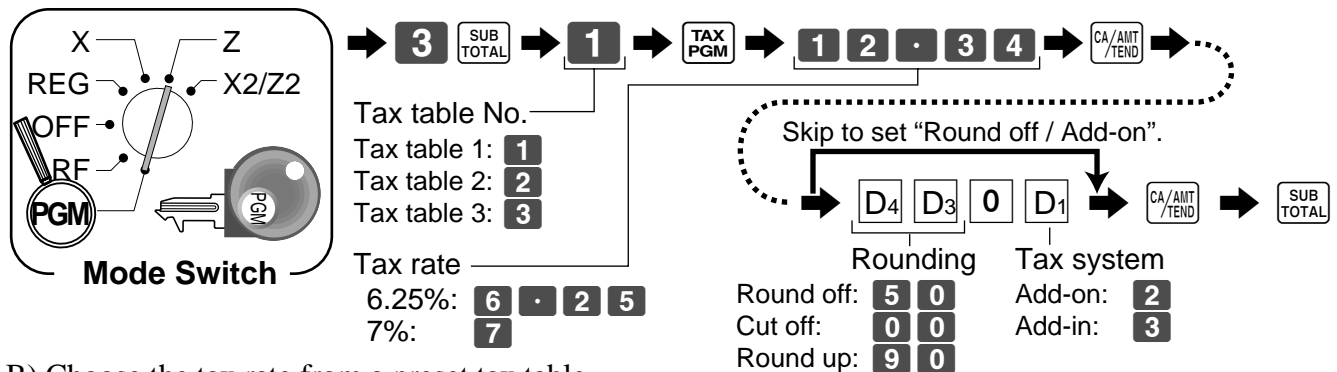

B) Choose the tax rate from a preset tax table.

The procedure to setup the tax table is printed on the guidance receipt. First issue the guidance receipt by the [HELP] key and follow it to set the tax table.



```

ENTER NUMBER THEN
PRESS <HELP> KEY.

01:HOW TO PROGRAM
DATE AND TIME?

02:HOW TO PROGRAM
TAX TABLE? (US)

:
:
    
```

```

02:HOW TO PROGRAM
TAX TABLE?

-SELECT YOUR STATE AND
ENTER NUMBER THEN
PRESS <HELP> KEY.

0101:ALABAMA
0201:ALASKA
0301:ARIZONA
0401:ARKANSAS
0501:CALIFORNIA
:
:
5001:WISCONSIN
5101:WYOMING
    
```

```

PLEASE SELECT YOUR
DISTRICT NUMBER FOR TAX
TABLE 1 (XXXX) AND TABLE
2 (YYYY) FROM BELOW
TABLE.

1)TURN MODE KEY TO PGM.
2)3<SUBTOTAL>
3)0025<SUBTOTAL>
4)XXXX <CASH> KEY.
5)YYYY <CASH> KEY.
(IF YOU DO NOT NEED
TABLE 2, JUST SKIP
STEP 5)
6)<SUBTOTAL>
XXXX, YYYY IS DISTRICT
NUMBER

ALABAMA
0101: 4% State
0102: 4.5% State & Local
:
0111: 9 % State & Local
    
```

Follow these steps.

8. Tax table programming (continued)

Programming Canadian tax table

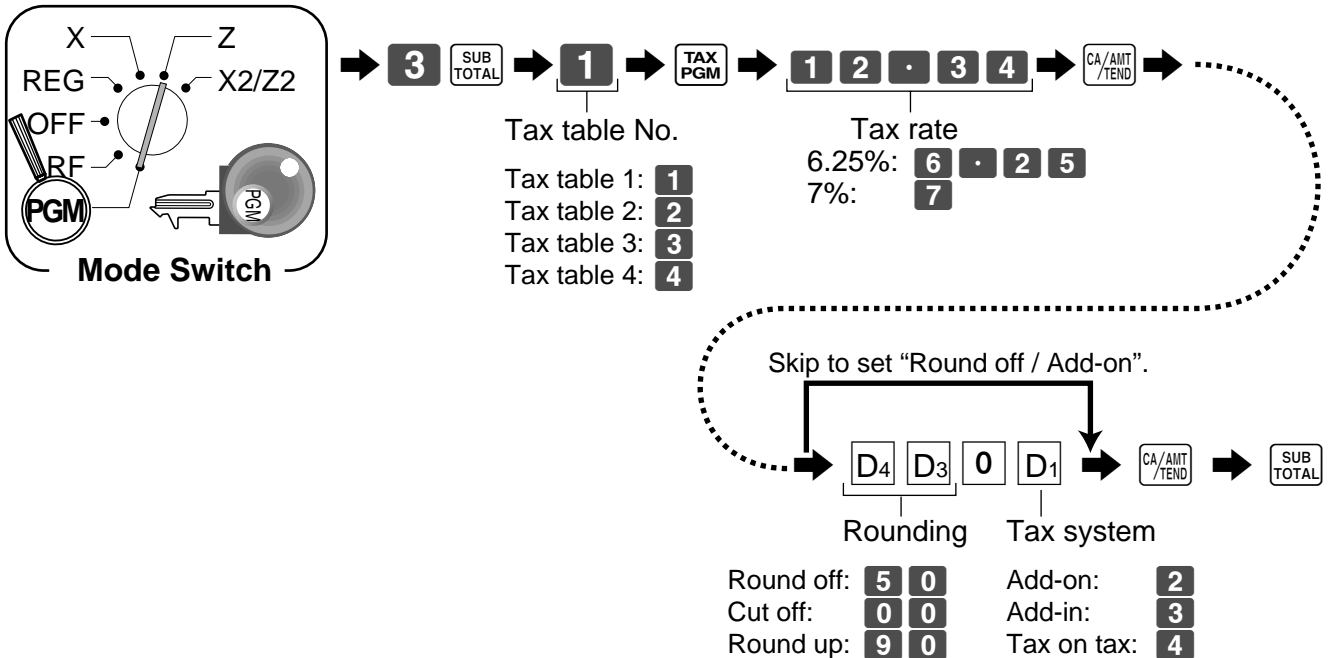

- 4 tax tables are used for the following purpose

Table 1: Used for the federal taxable items.

Table 2: Used for the provincial taxable items.

Table 3/4: Used for the provincial taxable items for different tax table.

Important!

Be sure you use the federal sales tax data with your provincial sales tax data. Even if your province use the same tax rate as another province, inputting the wrong data will result incorrect tax calculations.

9. Select watermark on receipt.

Turn the mode switch to “PGM”, enter <0> or <1>, and press the <CHK>, <ST>

Example: no watermark	⇒	0	CHK	<small>SUB TOTAL</small>
with watermark	⇒	1	CHK	<small>SUB TOTAL</small>

NOTE:

After completion of register programming, enter **6 2 0 0** and SUB
TOTAL in the PGM 7 mode (PGM mode ⇒ **7** SUB
TOTAL) to backup the program data into the internal non-volatile memory.

(This operation takes about 30 seconds.)

10. Department unit price programming

Maximum 6-digit unit price can be set to the department.

Refer to page-33.

Tax calculation status can be set to the department.

Refer to page-33.

11. PLU unit price programming

Maximum 6-digit unit price can be set to the PLU.

Refer to page-35.

Tax calculation status can be set to the PLU.

Refer to page-35.

12. Discount rate programming

0.01 - 99.99% rate can be set to the Discount key.

Refer to page-38.

Tax calculation status can be set to the Discount key.

Refer to page-38.

13. Issuing daily reset report

After business hours, issue daily reset report.

Refer to page-47.

14. Advanced operations and Setups

Using clerk functions	48	Set menu	59
Single item cash sales	49	Arrangement key registrations	60
Currency exchange function	50	Tips	60
Premium	52	Item correction by using VOID key	61
Coupon	52	Addition	61
Age verification	53	Department / PLU name selection / set	62
Check tracking system	54	Preset message /graphic selection / set	62
Flat-PLU	57	Character manual input	63
Text recall.....	57	Machine feature program	70
Input the number of customers	57	Key function program	78
Clerk interrupt function	58	Keyboard layout change	87
Condiment / preparation PLUs	59		

15. Issuing reports

Individual item read report	88	Periodic sales report	94
Daily read report	89	Program read report	96
PLU report	89		
Monthly report	89		
Hourly report	89		
Group report	89		
Flash report	89		
Open check report	89		
Daily reset report	90		

16. Troubleshooting

E sign appears	100	To replace receipt / journal paper.....	104, 105
Drawer does not open	101		
L sign appears	103		



Introducing the Register

General guide

This part of the manual introduces you to the cash register and provides a general explanation of its various parts.

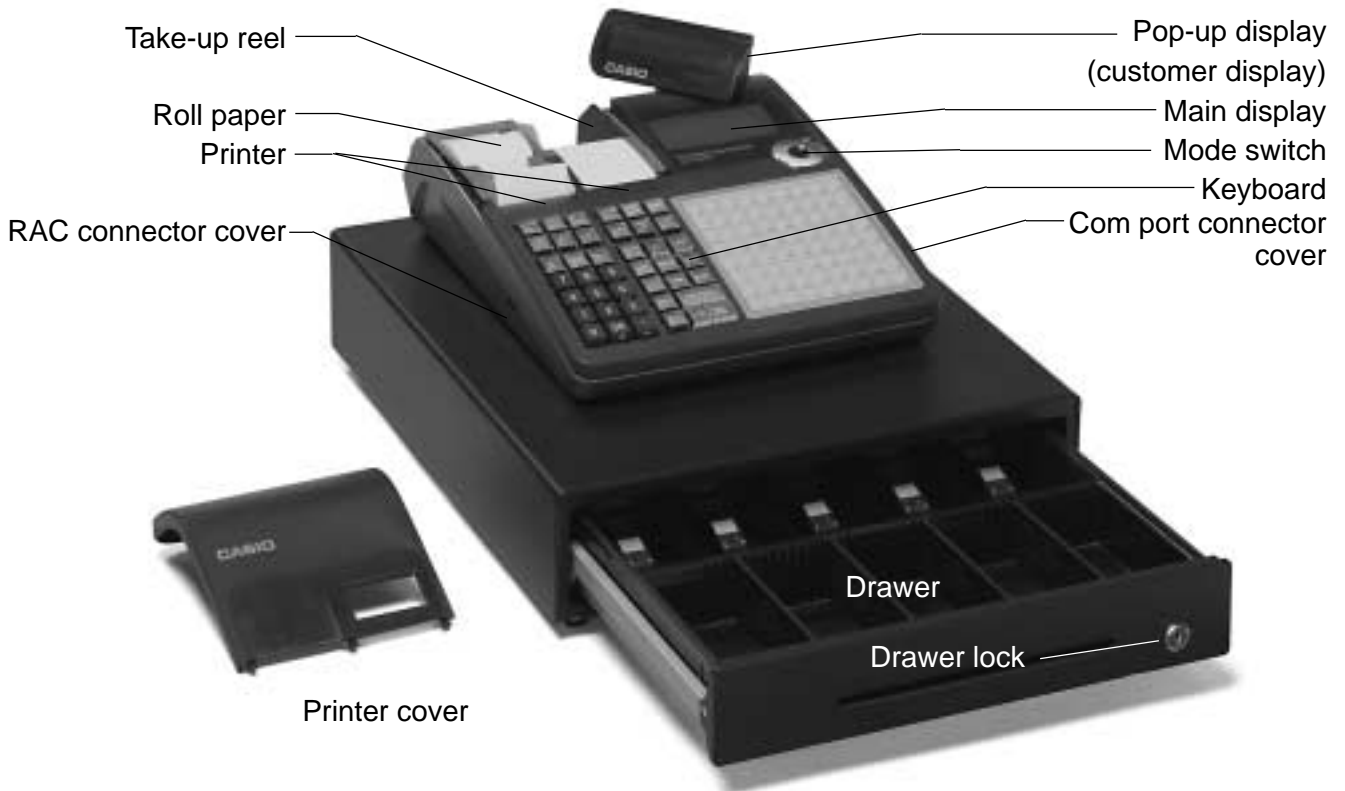

Roll paper

You can use the roll paper to print receipts and a journal (page 11 ~ 12).

Mode key

There are two types of mode keys: the program key (marked "PGM") and the operator key (marked "OP"). The program key can be used to set the mode switch to any position, while the operator key can select the **REG** and **OFF** position.

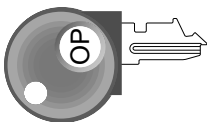

Operator key

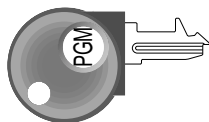

Program key

Drawer

The drawer opens automatically whenever you finalize a registration and whenever you issue a read or reset report. The drawer will not open if it is locked with the drawer key.

Drawer lock / Drawer key

Use the drawer key to lock and unlock the drawer.

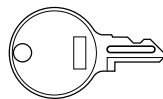

Drawer key

Magnetic plate

Use this plate for tacking the notes received from customer.

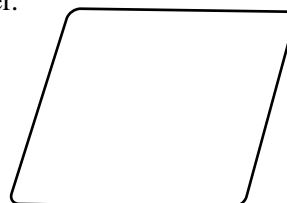

Mode switch

Use the mode keys to change the position of the mode switch and select the mode you want to use.

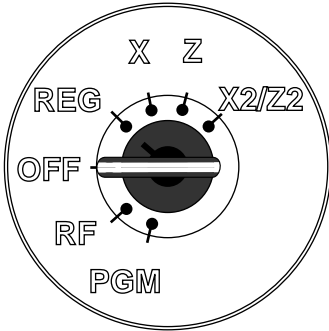

Mode Switch	Mode Name	Description
X2/Z2	Periodic sale read/reset	Used to obtain periodic sales reports without resetting total data or while resetting all total data.
Z	Daily sales reset	Used to obtain daily reports while resetting (clearing) all total data.
X	Daily sales read	Used to obtain daily reports without resetting (clearing) all total data.
REG	Register	Used for normal registration.
OFF	Stand-by	Cash register standing by.
RF	Refund	Used for registering refund transaction.
PGM	Program	Used for cash register programming.

How to set the Pop-up display

1. Lift the unit until it stops.

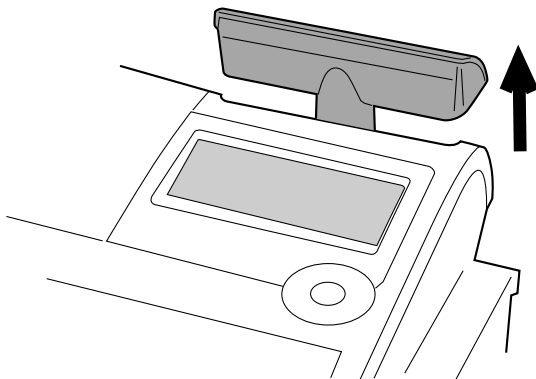

2. Rotate the unit.

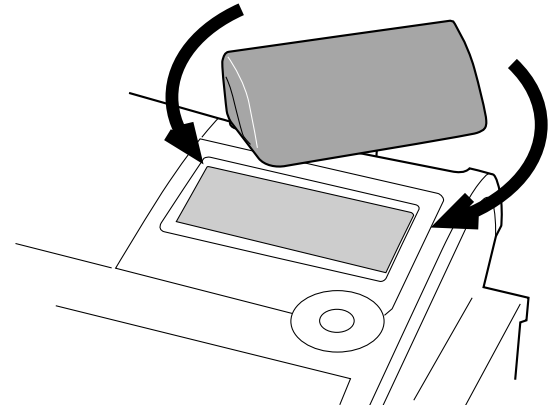

How to set the menu sheet

1. Pull the sheet cover up and remove the old menu sheet.

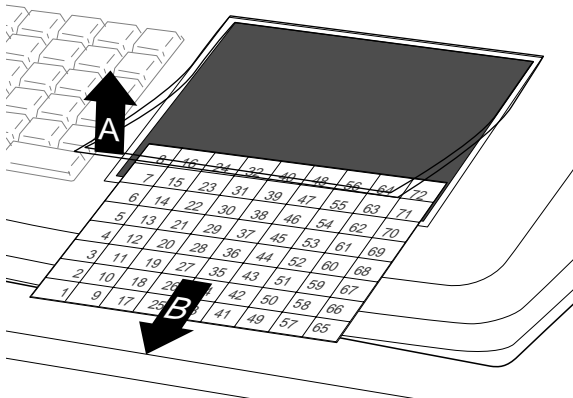

2. Put the new menu sheet and replace the cover.

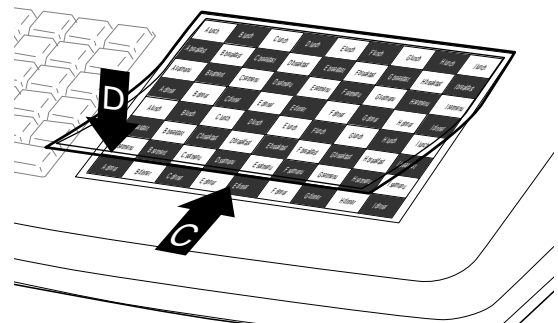

Introducing the Register

Display

Display panel

Main display

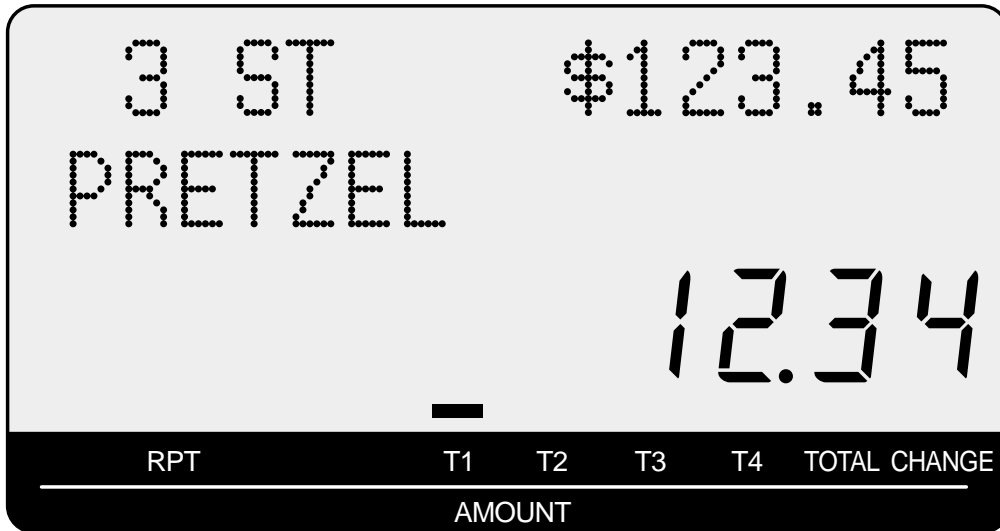

Customer display

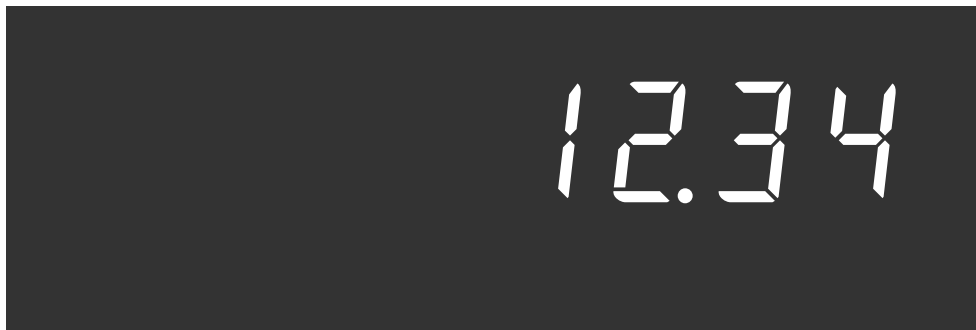

Displays

Main Display

(alphanumeric + numeric display)

Pop-up (customer) display

(numeric display)

Item registration (by department/PLU)

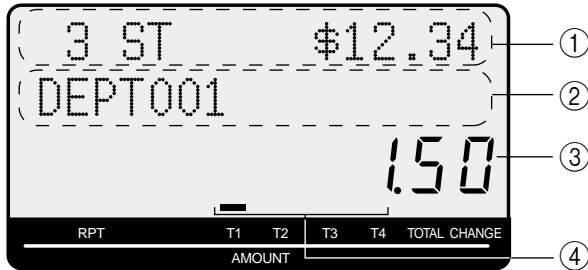

Repeat registration

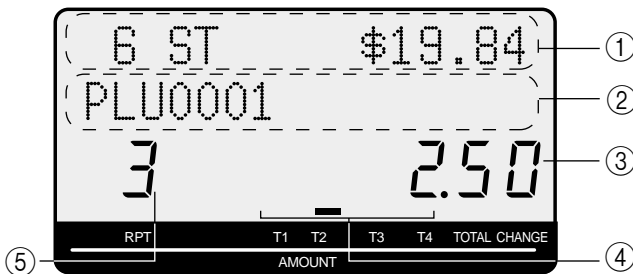

Totalize operation

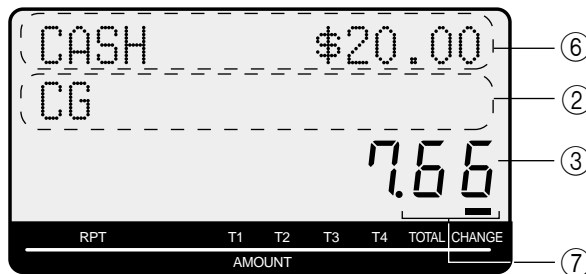

① Item count and subtotal

This part of the display shows item sold count and subtotal.

② Item / Key / Change descriptor

When you register an item or key, the item / key / change descriptor appears here.

Mode descriptor is also displayed here.

③ Amount / Quantity

This part of the display shows monetary amounts.

It also can be used to show the current time.

(The current date is shown in the alphanumeric display.)

④ Taxable sales status indicators

When you register a taxable item, the corresponding indicator is lit.

⑤ Number of repeats

Anytime you perform a repeat registration (page 31 36), the number of repeats appears here.

Note that only one digit is displayed for the number of repeats. This means that a “5” could mean 5, 15 or even 25 repeats.

⑥ Tendered amount

When the tender operation is made, the entered value appears here.

⑦ Total / Change indicators

When the TOTAL indicator is lit, the displayed value is monetary total or subtotal amount.

When the CHANGE indicator is lit, the displayed value is the change due.

Introducing the Register

Keyboard

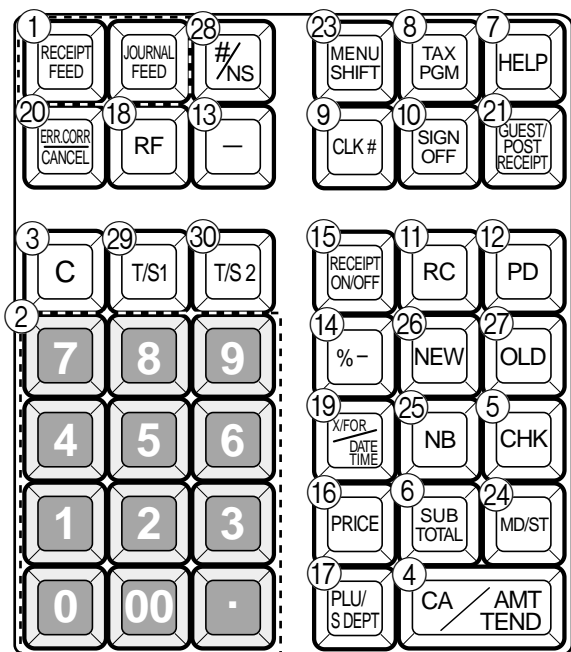

8	16	24	32	40	48	56	64	72
7	15	23	31	39	47	55	63	71
6	14	22	30	38	46	54	62	70
5	13	21	29	37	45	53	61	69
4	12	20	28	36	44	52	60	68
3	11	19	27	35	43	51	59	67
2	10	18	26	34	42	50	58	66
1	9	17	25	33	41	49	57	65

- ① **Paper feed key** ,
Hold this key down to feed paper from the printer.
- ② **Ten key pad** , , ~ , ,
Use these keys to input numbers.
- ③ **Clear key**
Use this key to clear an entry that has not yet been registered.
- ④ **Cash amount tendered key**
Use this key to register a cash sale.
- ⑤ **Check key**
Use this key to register a check tender.
- ⑥ **Subtotal key**
Use this key to display and print the current subtotal (includes add-on tax) amount.
- ⑦ **Help key**
Use this key to look up the procedures to set date/time, tax table etc.
- ⑧ **Tax program key**
Use this key to set the tax status and tax table.
- ⑨ **Clerk number key**
Use this key to sign clerk on and off the register.
- ⑩ **Sign off key**
Use this key to sign clerk off the register.
- ⑪ **Received on account key**
Use this key following a numeric entry to register money received for non-sale transactions.
- ⑫ **Paid out key**
Use this key following a numeric entry to register money paid out from the drawer.
- ⑬ **Reduction (minus) key**
Use this key to input values for reduction.
- ⑭ **Discount key**
Use this key to register discounts.
- ⑮ **Receipt on/off key**
Use this key twice to change the status "receipt issue" or "no receipt."
- ⑯ **Price key**
Use this key to register unit prices for subdepartment.
- ⑰ **PLU/Subdepartment key**
Use this key to input PLU (subdepartment) numbers.
- ⑱ **Refund key**
Use this key to input refund amounts and void certain entries.
- ⑲ **Multiplication/For/Date/Time key**
Use this key to input a quantity for a multiplication and registration of split sales of packaged items. Between transactions, this key displays the current time and date.
- ⑳ **Error correct / Cancel key**
Use this key to correct registration errors and to cancel registration of entire transactions.
- ㉑ **Guest / Post receipt key**
Use this key to produce a guest or post-finalization receipt.

- ②② **Department keys** , , ~
Use these keys to register items to departments.
- ②③ **Menu shift key**
Use this key to shift flat PLU keys to 1st ~ 3rd menu.
- ②④ **Merchandise subtotal key**
Use this key to display and print the current subtotal (excludes add-on tax) amount.
- ②⑤ **New balance key**
Use this key for adding the latest registered total amount to the previous balance to obtain a new balance.
- ②⑥ **New check key**
Use this key in a check tracking system to input a new check number in order to open a new check under that number.
- ②⑦ **Old check key**
Use this key in a check tracking system to input the number of an existing check (previously created by the new check key) whose details are stored in the check tracking memory.
- ②⑧ **Non-add / No sale key**
Non-add key: Use this key to print reference number (to identify a personal check, credit card, etc.) during a transaction, use this key after some numerical entries.
No sale key: Use this key to open the drawer without registering anything.
- ②⑨ **Tax shift 1 key**
Use this key without a numeric entry to change the Taxable 1 status of the next item.
- ③⑩ **Tax shift 2 key**
Use this key without a numeric entry to change the Taxable 2 status of the next item.

Introducing the Register

Allocatable functions

You can tailor a keyboard to suit your particular type of business.

Add check

Use this key in a check tracking system to combine the details of more than one check into a single check.

Addition (plus)

Use this key for registering surcharge.

Age verification

Use this key to enter the birthdate of the customer for age verification.

Arrangement

Use this key to activate an arrangement program programmed in the arrangement file. Any operation that can be performed from the keyboard, as well as mode, can be programmed in an arrangement program, and can be performed merely by pressing this key. In addition, one numeric entry can be included in an arrangement program. In this case, input the number and press this key.

The mode control function of this key can be programmed for all modes except for the OFF and PGM mode.

Cash amount tendered

Use this key to register a cash sale.

Charge

Use this key to register a charge sale.

Check tendered

Use this key to register a check tender.

Clerk number

Use this key to sign clerk on and off the register.

Coupon

Use this key to register coupons.

Credit

Use this key to register a credit sale.

Currency exchange

Use this key for calculating subtotal amounts or paying amount due in foreign currency.

Customer number

Use this key to register the number of customers.

Department

Use these keys to register items to departments.

Department no. / Department shift

Department no.: Use this key to input department numbers.

Department shift: Use this key to shift the department key number.

Discount

Use this key to register discounts.

Enter

In an arrangement program, this key is used to insert numbers entered before registering the arrangement.

Error correct / Cancel

Use this key to correct registration errors and to cancel registration of entire transactions.

Flat-PLU

Use this key to register items to flat-PLUs.

Help

Use this key to look up the procedures to set date/time, tax table etc.

Manual tax

Use this key to register a tax amount.

Menu shift

Use this key to shift flat PLU keys to 1st ~ 3rd menu.

Merchandise subtotal

Use this key to obtain subtotal excluding the add-on tax amount and the previous balance.

Multiplication

Use this key to input a quantity for a multiplication operation. Between transactions, this key displays the current time and date.

New balance

Use this key for adding the latest registered total amount to the previous balance to obtain a new balance.

New check

Use this key in a check tracking system to input a new check number in order to open a new check under that number.

New / Old check

Use this key in a check tracking system to input check numbers in order to open new checks and to reopen existing checks. When the clerk inputs a check number, the register checks to see if that number already exists in the check tracking memory. If there is no matching number in the memory, a new check is opened under the input number. If the check number input matches a number already stored in the memory, that check is reopened for further registration or finalization.

No sale

Use this key to open the drawer between transaction.

Non-add

Use this key to print reference numbers (personal check number, card number, etc.)

Non-add / No sale

Non-add: Use this key to print reference number (to identify a personal check, credit card, etc.) during a transaction, use this key after some numerical entries.

No sale: Use this key to open the drawer without registering anything.

Old check

Use this key in a check tracking system to input the number of an existing check (previously created by the New check key) whose details are stored in the check tracking memory. Existing checks are reopened to perform further registration or to finalize them.

Open

Use this key to temporarily release a limitation on the number of digits that can be input for a unit price.

Paid out

Use this key following a numeric entry to register money paid out from the drawer.

PLU/Subdepartment

Use this key to input PLU (subdepartment) numbers.

Premium

Use this key to register premiums.

Price

Use this key to register unit prices for PLU (subdepartment).

Multiplication / For

Use this key to input a quantity for a multiplication operation and registration of split sales of packaged items. Between transactions, this key displays the current time and date.

Post receipt

Use this key to produce a guest or post-finalization receipt.

Receipt on/off

Use this key twice to change the status “receipt issue” or “no receipt.”

Received on account

Use this key following a numeric entry to register money received for non-sale transactions.

Reduction (minus)

Use this key to input values for reduction.

Refund

Use this key to input refund amounts and void certain entries.

Sign off

Use this key to sign clerk off the register.

Subtotal

Use this key to display and print the current subtotal (includes add-on tax) amount.

Tax status shift 1

Use this key to change the Taxable 1 status of the next item.

Tax status shift 2

Use this key to change the Taxable 2 status of the next item.

Tax program

Use this key to program tax status and tax table easily.

Text recall

Use this key to print presett characters.

Tip

Use this key to register tips.

VAT

Use this key to print a VAT breakdown.

Void

Use this key to invalidate preceding item data registered.

How to read the printouts

- The journal / receipts are records of all transactions and operations.
- The contents printed on receipts and journal are almost identical.
- You can choose the journal skip function.
If the journal skip function is selected, the cash register will print the total amount of each transaction, and the details of premium, discount and reduction operations only, without printing department and PLU item registrations on the journal.
- The following items can be skipped on receipts and journal.
 - Taxable status
 - Taxable amount
 - Item counter

Receipt Sample

<pre>***** * THANK YOU * ** CALL AGAIN ** ***** * COMMERCIAL MESSAGE * * COMMERCIAL MESSAGE * * COMMERCIAL MESSAGE * * COMMERCIAL MESSAGE * New Year Sale 1st Anniversary 10% OFF  HAPPY NEW YEAR REG 03-06-2008 11:58 C01 0001 000123 1 DEPT001 T1 \$1.00 1 DEPT002 T1 \$2.00 5 DEPT003 \$5.00 7 No TA1 \$3.00 TX1 \$0.15 TL \$8.15 CASH \$10.00 CG \$1.85 *** BOTTOM MESSAGE *** *** BOTTOM MESSAGE *** *** BOTTOM MESSAGE *** *** BOTTOM MESSAGE ***</pre>	<p>Logo message</p> <p>Commercial message</p> <p>Preset message *1</p> <p>Preset graphic *1</p> <p>Mode/Date/Time Clerk/Machine No. Consecutive No.</p> <p>Q'ty/Item</p> <p>Item counter</p> <p>Bottom message</p>
--	--

**Journal Sample
(Item lines Included)**

```
REG 03-06-2008 11:58
C01 0001 000123
1 DEPT001 T1 $1.00
1 DEPT002 T1 $2.00
5 DEPT003 $5.00

7 No

TA1 $3.00
TX1 $0.15
TL $8.15
CASH $10.00
CG $1.85

REG 03-06-2008 11:59
C01 0001 000124
1 DEPT001 T1 $1.00
1 DEPT012 T1 $1.00
5 DEPT003 $6.00

7 No

TA1 $2.00
TX1 $0.10
TL $8.10
CASH $10.00
CG $1.90

REG 03-06-2008 11:59
C01 0001 000124
```

**Journal Sample
(by half height character)**

```
REG 03-06-2008 11:58
C01 0001 000123
1 DEPT001 T1 $1.00
1 DEPT002 T1 $2.00
5 DEPT003 $5.00

7 No
TA1 $3.00
TX1 $0.15
TL $8.15
CASH $10.00
CG $1.85

REG 03-06-2008 11:59
C01 0001 000124
1 DEPT001 T1 $1.00
1 DEPT012 T1 $1.00
5 DEPT003 $6.00

7 No
TA1 $2.00
TX1 $0.10
TL $8.10
CASH $10.00
CG $1.90

REG 03-06-2008 11:59
C01 0001 000125
```

*1 You can choose to print preset message and graphic at the top of the receipt or at the bottom of the receipt.

In the operation examples contained in this manual, the print samples are what would be produced if the roll paper is being used for receipts. They are not actual size. Actual receipts are 58 mm wide. Also, all sample receipts and journals are printout images.

How to use your cash register

The following describes the general procedure you should use in order to get the most out of your cash register.

BEFORE business hours...

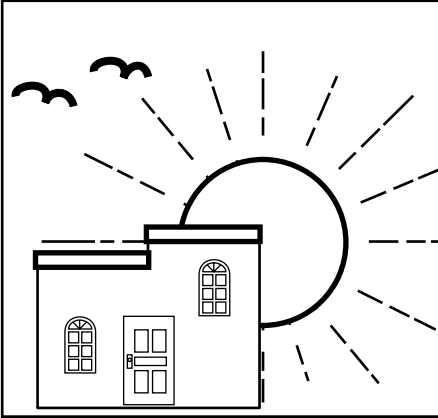

- Check to make sure that the cash register is plugged in securely. Page 13
- Check to make sure there is enough paper left on the roll. Pages 11, 12
- Read the flash report to confirm that totals are all zero. Page 89
- Check the date and time. Page 30

DURING business hours...

- Register transactions. Page 31 -
- Periodically read totals. Page 80

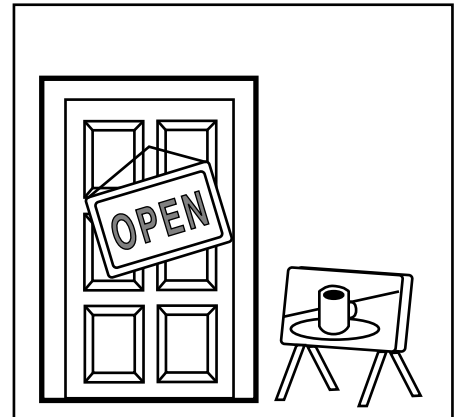

AFTER business hours...

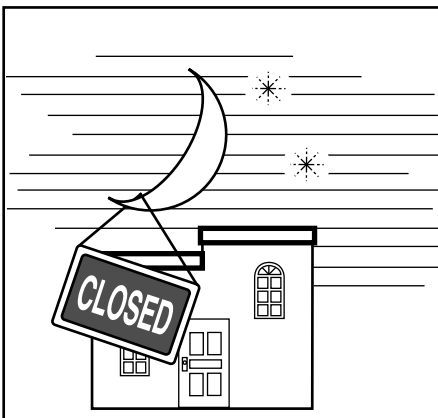

- Reset the daily totals. Page 47, 90
- Remove the journal. Page 104
- Empty the cash drawer and leave it open. Page 20
- Take the cash and journal to the office.

Before business hours

Checking the time and date

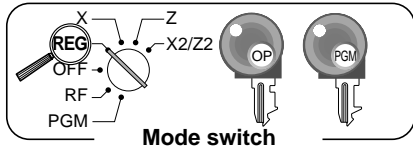

You can show the time or date on the display of the cash register whenever there is no registration being made.

To display and clear the date/time

OPERATION

DISPLAY



 Date/time appears on the display.

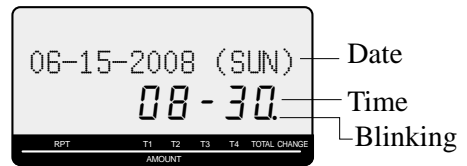



 Clears the date/time display.



Preparing coins for change

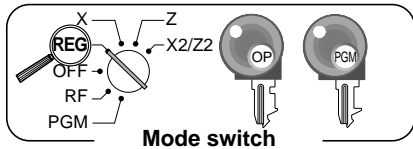

You can use the following procedure to open the drawer without registering an item. This operation must be performed out of a sale. (You can use the **RC** key instead of this key. See page 43.)

Opening the drawer without a sale

OPERATION

RECEIPT



Preparing and using department keys

Registering department keys

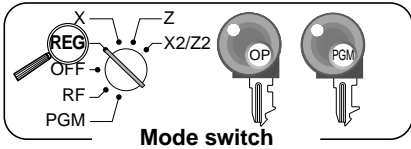

The following examples show how you can use the department keys in various types of registrations.

Single item sale

Example 1

OPERATION

RECEIPT

Item	Unit price	\$1.00
	Quantity	1
	Dept.	1
Payment	Cash	\$1.00

1 00
Unit price

1 DEPT001	\$1.00	Department No./ unit price
TL	\$ 1 . 00	Total amount
CASH	\$1.00	

1

Department

CA/AMT
/TEND

Example 2 (Subtotal registration and change computation)

OPERATION

RECEIPT

Item	Unit price	\$12.34
	Quantity	1
	Dept.	1
Payment	Cash	\$20.00

1 2 3 4
Unit price

1 DEPT001	\$12.34	Total amount
TL	\$ 12 . 34	Amount tendered
CASH	\$20.00	Change
CG	\$7.66	

1

Department

SUB
TOTAL

2 0 00 CA/AMT
/TEND

Amount tendered

Repeat

OPERATION

RECEIPT

Item	Unit price	\$1.50
	Quantity	3
	Dept.	1
Payment	Cash	\$10.00

1 5 0 **1**

1 DEPT001	\$1.50	Repeat
1 DEPT001	\$1.50	Repeat
1 DEPT001	\$1.50	
TL	\$ 4 . 50	
CASH	\$10.00	
CG	\$5.50	

1

SUB
TOTAL

1 0 00 CA/AMT
/TEND

Basic Operations and Setups

Multiplication

Item	Unit price	\$1.00
	Quantity	12
	Dept.	1
Payment	Cash	\$20.00

OPERATION

Quantity
(4-digit integer/3-digit decimal)

RECEIPT

12 DEPT001	\$12.00	Quantity/result
TL	\$ 12.00	
CASH	\$20.00	
CG	\$8.00	

Split sales of packaged items

Item	Unit price	4 for \$10.00
	Quantity	3
	Dept.	1
	Taxable	No
Payment	Cash	\$10.00

OPERATION

Quantity being purchased
(4-digit integer/3-digit decimal)

Package quantity
(4-digit integer/3-digit decimal)

Package price

RECEIPT

3 DEPT001	\$7.50	Quantity/result
TL	\$ 7.50	
CASH	\$10.00	
CG	\$2.50	

Department shift

Item	Unit price	\$1.00
	Quantity	1
	Dept.	73
Payment	Cash	\$1.00

OPERATION

Designating upper department
press first.
(- 2 - shows).

RECEIPT

1 DEPT073	\$1.00
TL	\$ 1.00
CASH	\$1.00

Department number

Item	Unit price	\$13.00
	Quantity	1
	Dept.	31
Payment	Cash	\$13.00

OPERATION

Department No.

Unit price

RECEIPT

1 DEPT031	\$13.00
TL	\$ 13.00
CASH	\$13.00

- If is not allocated on the keyboard, key allocation is necessary.

Programming department keys

To program a unit price for each department

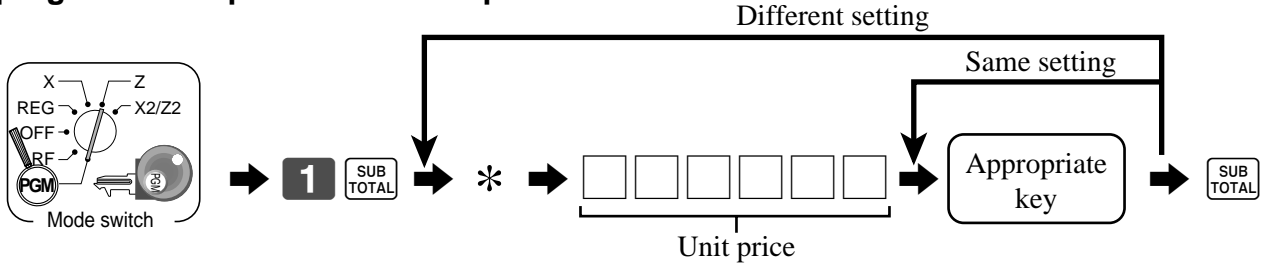

* In case of shifting upper department, press key here.

To program the tax calculation status for each department

Tax calculation status

This specification defines which tax table should be used for automatic tax calculation.

Programming procedure

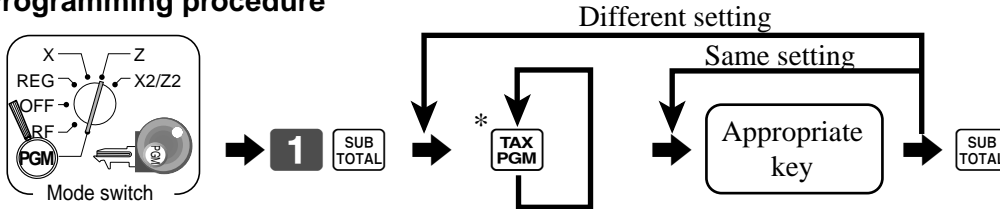

* Press key repeatedly until the status you want to program is appeared on the display.



Appropriate key: In case of shifting department, press key first.

To program high amount limit for each department

Programming procedure

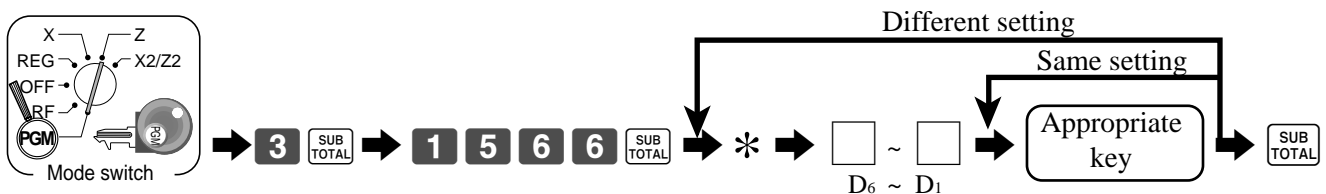

* In case of shifting upper department, press key here.

Description	Choice	Program code
High amount limit for entering unit price manually.	Significant numbers	<input type="text"/> ~ <input type="text"/> D ₆ ~ D ₁

- If is not allocated on the keyboard, key allocation is necessary.

Basic Operations and Setups

Registering department keys by programming data

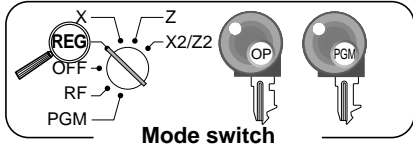

Preset price

Item	Unit price	(\$1.00) _{preset}
	Quantity	1
	Dept.	2
Payment	Cash	\$1.00

OPERATION

2
CA/AMT
TEND

RECEIPT

1 DEPT002		\$1.00	Department No./ unit price
TL	\$1.00		
CASH		\$1.00	

Preset tax status

Item 1	Unit price	(\$2.00) _{preset}
	Quantity	5
	Dept.	3
	Taxable	(1) _{preset}
Item 2	Unit price	(\$2.00) _{preset}
	Quantity	1
	Dept.	4
	Taxable	(2) _{preset}
Payment	Cash	\$20.00

OPERATION

5 FOR
DATE TIME
3
4
SUB
TOTAL
2 0 00 CA/AMT
TEND

RECEIPT

5 DEPT003	T1	\$10.00	Tax status
1 DEPT004	T2	\$2.00	
TA1		\$10.00	Taxable Amount 1
TX1		\$0.40	Tax 1
TA2		\$2.00	Taxable Amount 2
TX2		\$0.20	Tax 2
TL		\$12.60	
CASH		\$20.00	
CG		\$7.40	

Locking out high amount limitation

Item	Unit price	\$1.05
	Quantity	1
	Dept.	3
	Max.amount	(\$10.00) _{preset}
Payment	Cash	\$2.00

OPERATION

1 0 5 0 **3**
ERROR ALARM
(Exceeding high amount)
C
1 0 5 **3**
SUB
TOTAL
2 00 CA/AMT
TEND

RECEIPT

1 DEPT003		\$1.05
TL	\$1.05	
CASH		\$2.00
CG		\$0.95

Preparing and using PLUs

This section describes how to prepare and use PLUs.

CAUTION:

Before you use PLUs, you must first program the unit price and tax status.

Programming PLUs

To program a unit price for each PLU

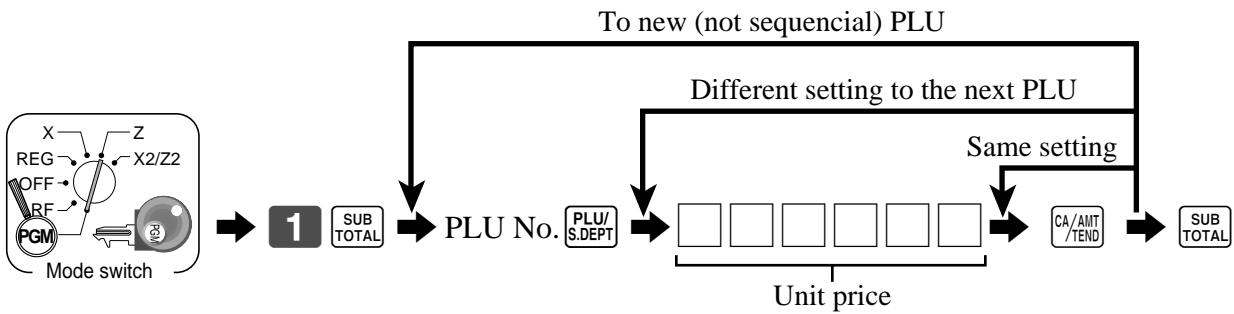

To program tax calculation status for each PLU

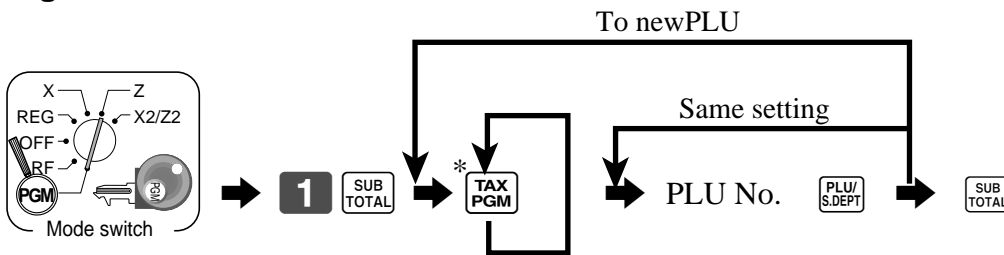

* Press **TAX PGM** key repeatedly until the status you want to program is appeared on the display.

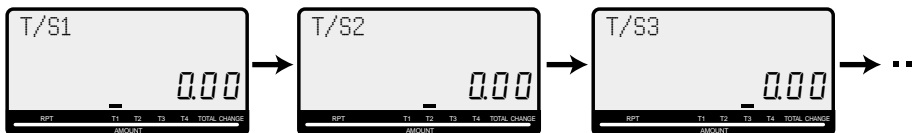

Basic Operations and Setups

Registering PLUs

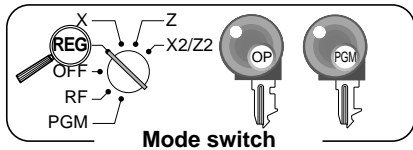

The following examples show how you can use PLUs in various types of registrations.

PLU single item sale

Item	Unit price	(\$2.50) _{preset}
	Quantity	1
	PLU	14
Payment	Cash	\$3.00

OPERATION

1 4
PLU code

PLU/
S.DEPT

SUB
TOTAL

3 00 CA/AMT
TEND

RECEIPT

1 PLU0014	\$2.50	— PLU No./unit price
TL	\$2.50	
CASH	\$3.00	
CG	\$0.50	

PLU repeat

Item	Unit price	(\$2.50) _{preset}
	Quantity	3
	PLU	14
Payment	Cash	\$10.00

OPERATION

1 4 PLU/
S.DEPT

PLU/
S.DEPT

PLU/
S.DEPT

SUB
TOTAL

1 0 00 CA/AMT
TEND

RECEIPT

1 PLU0014	\$2.50
1 PLU0014	\$2.50
1 PLU0014	\$2.50
TL	\$7.50
CASH	\$10.00
CG	\$2.50

PLU multiplication

Item	Unit price	(\$2.00) _{preset}
	Quantity	10
	PLU	7
Payment	Cash	\$20.00

OPERATION

1 0 X / FOR
DATE
TIME
Quantity
(4-digit integer/3-digit decimal)

7 PLU/
S.DEPT

SUB
TOTAL

2 0 00 CA/AMT
TEND

RECEIPT

10 PLU0007	\$20.00	— Quantity/result
TL	\$20.00	
CASH	\$20.00	
CG	\$0.00	

Split sales of packaged item

OPERATION

RECEIPT

Item	Unit price	(5for\$20.00) <small>preset</small>
	Quantity	3
	PLU	28
Payment	Cash	\$15.00

3 FOR DATE TIME

Quantity being purchased
(4-digit integer/3-digit decimal)

5 FOR DATE TIME

Package quantity
(4-digit integer/3-digit decimal)

2 8 PLU/S.DEPT

SUB TOTAL

1 5 00 CA/AMT/TEND

3 PLU0028	\$12.00	Quantity/result
TL	\$12.00	
CASH	\$15.00	
CG	\$3.00	

Open PLU

OPERATION

RECEIPT

Item 1	Unit price	\$32.80
	Quantity	1
	PLU	30
Item 2	Unit price	\$13.00
	Quantity	2
	PLU	31
Payment	Cash	\$60.00

3 0 PLU/S.DEPT

3 2 8 0 PRICE

Unit price

3 1 PLU/S.DEPT

1 3 00 PRICE

Repeat PRICE

SUB TOTAL

6 0 00 CA/AMT/TEND

1 PLU0030	\$32.80
1 PLU0031	\$13.00
1 PLU0031	\$13.00
TL	\$58.80
CASH	\$60.00
CG	\$1.20

- Before registering an open PLU, it is necessary to preset it as an open PLU.

Preparing and using discounts

This section describes how to prepare and register discounts.

Programming discounts

To program a rate to the $\%-\square$ key

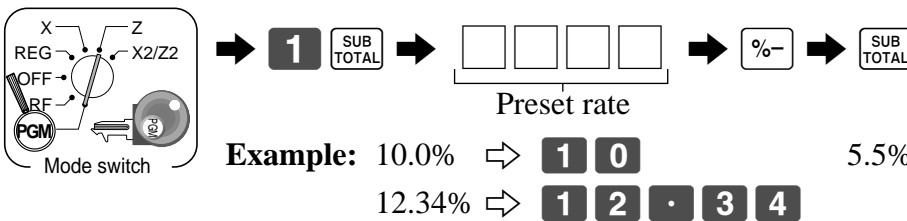

To program the tax calculation status to the $\%-\square$ key

Refer to page 33.

Registering discounts

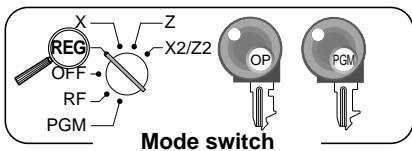

The following example shows how you can use the $\%-\square$ key in various types of registration.

Discount for items and subtotals

Item 1	Dept. 1	\$5.00
	Quantity	1
	Taxable	(1) _{preset}
Item 2	PLU 16	(\$10.00) _{preset}
	Quantity	1
	Taxable	(2) _{preset}
Discount	Rate	(5%) _{preset}
Subtotal discount	Rate	3.5%
	Taxable	Nontaxable
Payment	Cash	\$15.00

OPERATION

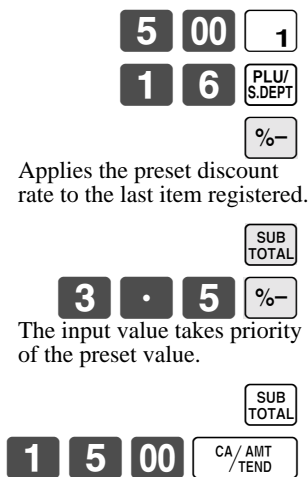

RECEIPT

1 DEPT001	T1	\$5.00
1 PLU0016	T2	\$10.00
5%		
$\%-\square$	T2	-0.50
ST		\$14.50
3.5%		
$\%-\square$		-0.51
TA1		\$5.00
TX1		\$0.20
TA2		\$9.50
TX2		\$0.48
TL		\$14.67
CASH		\$15.00
CG		\$0.33

- You can manually input rates up to 4 digits long (0.01% to 99.99%).

Taxable status of the $\%-\square$ key

- Whenever you perform a discount operation on the last item registered, the tax calculation for discount amount is performed in accordance with the tax status programmed for that item.
- Whenever you perform a discount operation on a subtotal amount, the tax calculation for the subtotal amount is performed in accordance with the tax status programmed for the $\%-\square$ key.

Preparing and using reductions

This section describes how to prepare and register reductions.

Programming for reductions

You can use the **[-]** key to reduce single item or subtotal amounts.

To program preset reduction amount

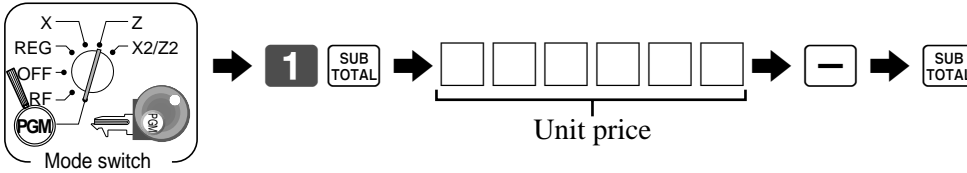

To program the tax calculation status to the **[-]** key

Refer to page 33.

Registering reductions

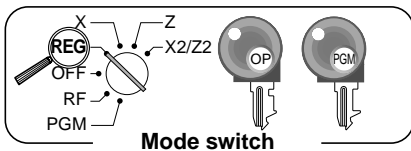

The following examples show how you can use the **[-]** key in various types of registration.

Reduction for items and subtotal

	Dept. 1	\$5.00
Item 1	Quantity	1
	Taxable	(1) _{preset}
Reduction	Amount	\$0.25
Item 2	PLU 45	(\$6.00) _{preset}
	Quantity	1
	Taxable	(1) _{preset}
Reduction	Amount	(\$0.50) _{preset}
Subtotal	Amount	\$0.75
Reduction	Taxable	(No) _{preset}
Payment	Cash	\$10.00

OPERATION

5 00 1
2 5 [-]
4 5 PLU/S.DEPT
[-]
SUB TOTAL
7 5 [-]
1 0 00 CA/AMT/TEND

Reduces the last amount registered by the value input.

RECEIPT

1	DEPT001	T1	\$5.00
-		T1	-0.25
1	PLU0045	T1	\$6.00
-		T1	-0.50
-			-0.75
	TA1		\$10.25
	TX1		\$0.41
	TL		\$9.91
	CASH		\$10.00
	CG		\$0.09

- You can manually input reduction values up to 7 digits long.
- If you want to subtract the reduction amount from the department or PLU totalizer, program “Net totaling.”

Registering credit and check payments

The following examples show how to register credits and payments by check.

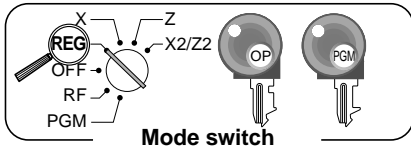

Check

OPERATION			RECEIPT																		
Item	Dept. 1	\$11.00	1	1	00	<table style="width: 100%; border-collapse: collapse;"> <tr> <td style="width: 60%;">1 DEPT001</td> <td style="width: 20%; text-align: right;">\$11.00</td> <td style="width: 20%;"></td> </tr> <tr> <td>#/NS</td> <td style="text-align: right;">1234</td> <td></td> </tr> <tr> <td>TL</td> <td style="text-align: right;">\$ 11.00</td> <td></td> </tr> <tr> <td>CHECK</td> <td style="text-align: right;">\$20.00</td> <td></td> </tr> <tr> <td>CG</td> <td style="text-align: right;">\$9.00</td> <td></td> </tr> </table>	1 DEPT001	\$11.00		#/NS	1234		TL	\$ 11.00		CHECK	\$20.00		CG	\$9.00	
1 DEPT001	\$11.00																				
#/NS	1234																				
TL	\$ 11.00																				
CHECK	\$20.00																				
CG	\$9.00																				
	Quantity	1																			
Reference	Number	1234	1	2	3																
Payment	Check	\$20.00	2	0	00																

Charge

OPERATION			RECEIPT												
Item	Dept. 4	\$15.00	1	5	00	<table style="width: 100%; border-collapse: collapse;"> <tr> <td style="width: 60%;">1 DEPT004</td> <td style="width: 20%; text-align: right;">\$15.00</td> <td style="width: 20%;"></td> </tr> <tr> <td>TL</td> <td style="text-align: right;">\$ 15.00</td> <td></td> </tr> <tr> <td>CHARGE</td> <td style="text-align: right;">\$15.00</td> <td></td> </tr> </table>	1 DEPT004	\$15.00		TL	\$ 15.00		CHARGE	\$15.00	
1 DEPT004	\$15.00														
TL	\$ 15.00														
CHARGE	\$15.00														
	Quantity	1													
Payment	Charge	\$15.00													

- If **CH** is not allocated on the keyboard, key allocation is necessary.

Credit

OPERATION			RECEIPT												
Item	Dept. 3	\$10.00	1	0	00	<table style="width: 100%; border-collapse: collapse;"> <tr> <td style="width: 60%;">1 DEPT003</td> <td style="width: 20%; text-align: right;">\$10.00</td> <td style="width: 20%;"></td> </tr> <tr> <td>TL</td> <td style="text-align: right;">\$ 10.00</td> <td></td> </tr> <tr> <td>CREDIT</td> <td style="text-align: right;">\$10.00</td> <td></td> </tr> </table>	1 DEPT003	\$10.00		TL	\$ 10.00		CREDIT	\$10.00	
1 DEPT003	\$10.00														
TL	\$ 10.00														
CREDIT	\$10.00														
	Quantity	1													
Payment	Credit	\$10.00													

- If **CR** is not allocated on the keyboard, key allocation is necessary.

Mixed tender (cash and check)

OPERATION			RECEIPT																		
Item	Dept. 4	\$55.00	5	5	00	<table style="width: 100%; border-collapse: collapse;"> <tr> <td style="width: 60%;">1 DEPT004</td> <td style="width: 20%; text-align: right;">\$55.00</td> <td style="width: 20%;"></td> </tr> <tr> <td>TL</td> <td style="text-align: right;">\$ 55.00</td> <td></td> </tr> <tr> <td>CHECK</td> <td style="text-align: right;">\$30.00</td> <td></td> </tr> <tr> <td>CASH</td> <td style="text-align: right;">\$25.00</td> <td></td> </tr> <tr> <td>CG</td> <td style="text-align: right;">\$0.00</td> <td></td> </tr> </table>	1 DEPT004	\$55.00		TL	\$ 55.00		CHECK	\$30.00		CASH	\$25.00		CG	\$0.00	
1 DEPT004	\$55.00																				
TL	\$ 55.00																				
CHECK	\$30.00																				
CASH	\$25.00																				
CG	\$0.00																				
	Quantity	1																			
Payment	Check	\$30.00	3	0	00																
	Cash	\$25.00	2	5	00																

Shifting the taxable status of an item

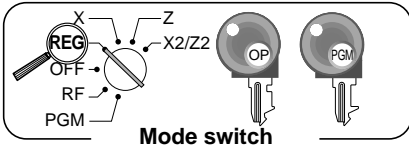

By pressing “Tax Shift” key, you can shift the taxable status of an item.

Calculation merchandise subtotal

			OPERATION	DISPLAY
Item 1	Dept. 1	\$4.00	4 00 1	
	Quantity	1	T/S1	
	Taxable	(2) _{preset}	2 00 2	
			Pressing T/S1 changes the tax status from Nontaxable to Taxable 1	
Item 2	Dept. 2	\$2.00	T/S2	
	Quantity	1	6 00 3	
	Taxable	(No)→1	T/S2	
			Pressing T/S2 changes the tax status from Taxable 1 to Taxable 1, 2	
Item 3	Dept. 3	\$6.00	7 00 4	
	Quantity	1	T/S2	
	Taxable	(1)→1, 2	T/S2	
			Pressing T/S2 changes the tax status from Taxable 2 to Nontaxable	
Item 4	Dept. 4	\$7.00	MD/ST	
	Quantity	1		
	Taxable	(2)→No		
Payment	Cash	\$20.00	SUB TOTAL	
			2 0 00 CA/AMT TEND	

OPERATION

RECEIPT

1	DEPT001	T2	\$4.00
1	DEPT002	T1	\$2.00
1	DEPT003	T12	\$6.00
1	DEPT004		\$7.00
	TA1		\$8.00
	TX1		\$0.32
	TA2		\$10.00
	TX2		\$0.50
	TL		\$19.82
	CASH		\$20.00
	CG		\$0.18

Important!

- To change the tax status of the next item to be registered, be sure to press **T/S1**, **T/S2**.
If the last item registered is programmed as nontaxable, a discount (**%-** key) operation on this item is always nontaxable.
In this case, you cannot manually change the tax status to Taxable 1 or 2 by pressing the **T/S1**, **T/S2** keys.
- For a partial tender operation, you should press the **SUB TOTAL** key instead of the **MD/ST** key.

Registering returned goods in the REG mode

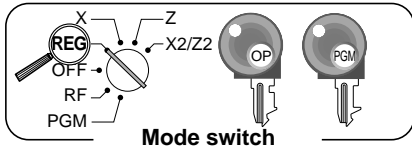

The following example shows how to use the **RF** key in the REG mode to register goods returned by customers.

OPERATION

RECEIPT

Item 1	Dept. 1	\$2.35
	Quantity	1
Item 2	Dept. 2	\$2.00
	Quantity	1
Item 3	PLU 1 (\$1.20) _{preset}	
	Quantity	1
Returned Item 1	Dept. 1	\$2.35
	Quantity	1
Returned Item 3	PLU 1 (\$1.20) _{preset}	
	Quantity	1
Payment	Cash	\$2.00

2 **3** **5** **1**
2 **00** **2**
1 **PLU/S.DEPT**
RF
2 **3** **5** **1**

Press **RF** before the item you want to return.

RF
1 **PLU/S.DEPT**
SUB TOTAL
CA/AMT/TEND

1	DEPT001	\$2.35
1	DEPT002	\$2.00
1	PLU0001	\$1.20
	RF
1	DEPT001	-2.35
	RF
1	PLU0001	-1.20
	TL	\$2.00
	CASH	\$2.00

Registering returned goods in the RF mode

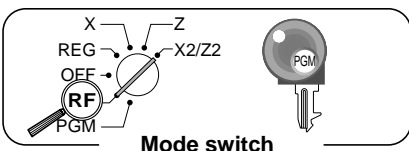

The following examples show how to use the RF mode to register goods returned by customers.

OPERATION

RECEIPT

Returned Item 1	Dept. 3	\$4.00
	Quantity	1
Reduction	Amount	\$0.15
Returned Item 2	PLU 2 (\$1.20) _{preset}	
	Quantity	1
Discount	Rate	(5%) _{preset}
Payment	Cash	\$4.99

4 **00** **3**
1 **5** **-**
2 **PLU/S.DEPT**
%-
SUB TOTAL
CA/AMT/TEND

1	DEPT003	\$4.00
	-	-0.15
1	PLU0002	\$1.20
	5%	
	%-	-0.06
	TL	\$4.99
	CASH	\$4.99

Important

- To avoid miss registrations in the RF mode, return the mode switch to the former position immediately.

Registering money received on account

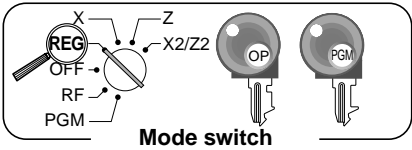

The following example shows how to register money received on account. This registration must be performed out of a sale.

Received amount	\$700.00
-----------------	----------

OPERATION

7 00 00 RC

Amount can be up to 8 digits.

RECEIPT

RC	\$700.00
----	----------

Registering money paid out

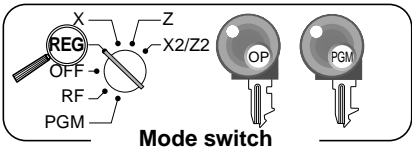

The following example shows how to register money paid out from the register. This registration must be performed out of a sale.

Paid out amount	\$1.50
-----------------	--------

OPERATION

1 5 0 PD

Amount can be up to 8 digits.

RECEIPT

PD	\$1.50
----	--------

No sale registration

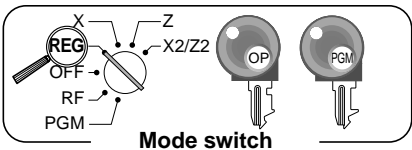

You can use the following procedure to open the drawer without registering a sale. This operation must be performed out of a sale.

OPERATION

#/NS

RECEIPT

#/NS
------	-------

Making corrections in a registration

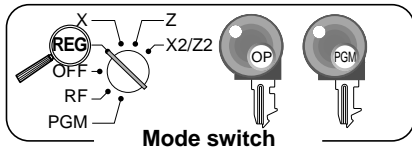

There are three techniques you can use to make corrections in a registration.

- \$To correct an item that you input but not yet registered.
- \$To correct the last item you input and registered.
- \$To cancel all items in a transaction.

To correct an item you input but not yet registered

OPERATION

RECEIPT

<p>2 00</p> <p>1 00 C</p> <p>1 2 X / FOR DATE TIME</p> <p>1 1 X / FOR DATE TIME</p> <p>2 00 2</p> <p>2</p> <p>1 5 PLU / S.DEPT</p> <p>1 5 PLU</p> <p>6 00</p> <p>1 5 PLU / S.DEPT Enter PLU No. again.</p> <p>1 0 00 PRICE</p> <p>1 0 00 SUB TOTAL</p> <p>1 5 00 C</p> <p>1 5 00 CA / AMT TEND</p> <p>CH</p>	<p>Correction of unit price</p> <p>Correction of quantity</p> <p>Correction of PLU No.</p> <p>Correction of open PLU unit price</p> <p>Correction of partial tender amount</p>	<table border="0"> <tr><td>1 DEPT001</td><td>\$1.00</td></tr> <tr><td>11 DEPT002</td><td>\$22.00</td></tr> <tr><td>1 PLU0003</td><td>\$1.30</td></tr> <tr><td>1 PLU0015</td><td>\$10.00</td></tr> <tr><td>TL</td><td>\$34.30</td></tr> <tr><td>CASH</td><td>\$15.00</td></tr> <tr><td>CHARGE</td><td>\$19.30</td></tr> </table>	1 DEPT001	\$1.00	11 DEPT002	\$22.00	1 PLU0003	\$1.30	1 PLU0015	\$10.00	TL	\$34.30	CASH	\$15.00	CHARGE	\$19.30
1 DEPT001	\$1.00															
11 DEPT002	\$22.00															
1 PLU0003	\$1.30															
1 PLU0015	\$10.00															
TL	\$34.30															
CASH	\$15.00															
CHARGE	\$19.30															

To correct an item you input and registered

OPERATION

RECEIPT

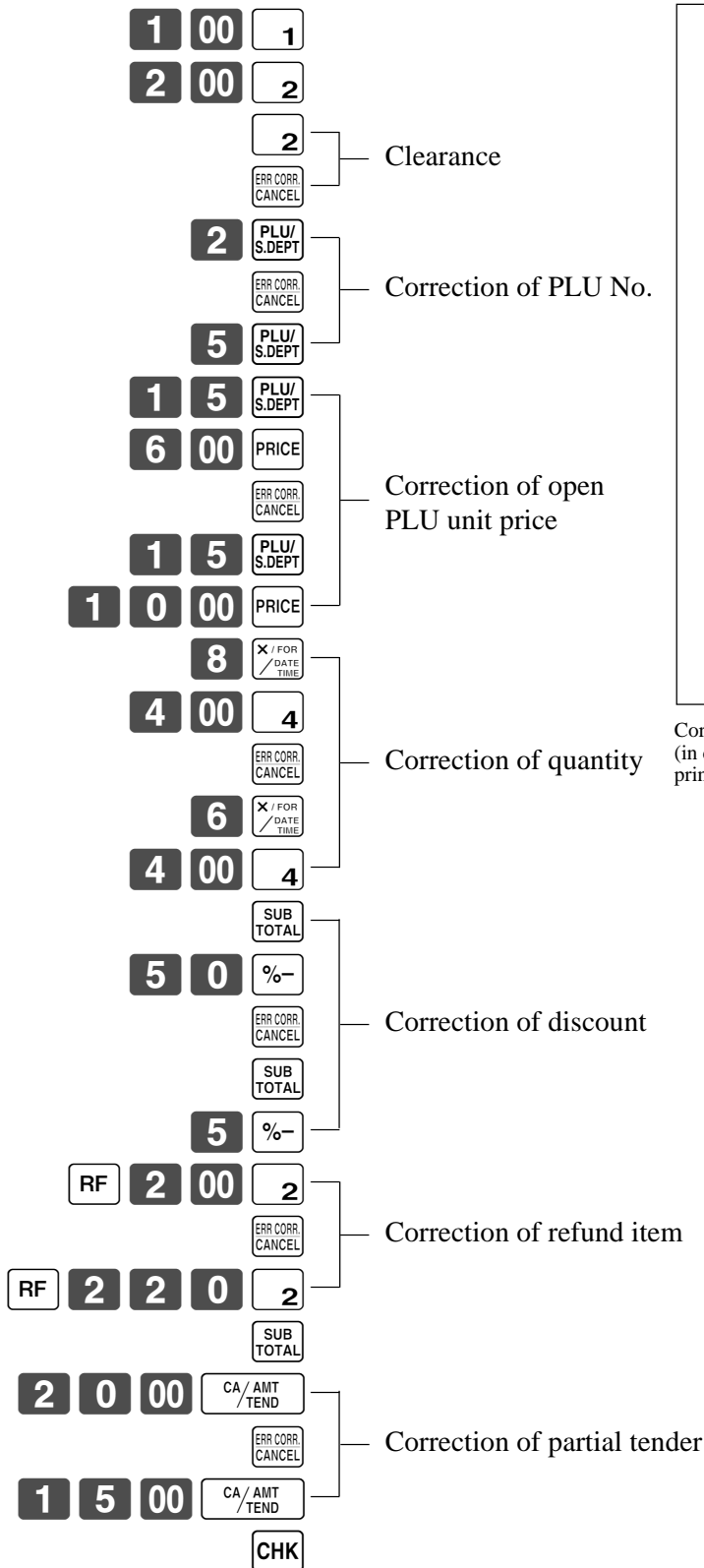

1	DEPT001	\$1.00
1	DEPT002	\$2.00
1	DEPT002	\$2.00
	CORR	-2.00
1	PLU0002	\$2.00
	CORR	-2.00
1	PLU0005	\$1.50
1	PLU0015	\$6.00
	CORR	-6.00
1	PLU0015	\$10.00
8	DEPT004	\$32.00
	CORR	-32.00
6	DEPT004	\$24.00
	ST	\$38.50
	50%	
	%-	-19.25
	CORR	\$19.25
	ST	\$38.50
	5%	
	%-	-1.93
	RF
1	DEPT	-2.00
	CORR	\$2.00
	RF
1	DEPT002	-2.20
	TL	\$34.37
	CASH	\$20.00
	CORR	-20.00
	CASH	\$15.00
	CHECK	\$19.37

Corrected items are not printed on receipt (in case of programming "Buffered receipt printing").

Basic Operations and Setups

To cancel all items in a transaction

OPERATION	RECEIPT
1 00 1	1 DEPT001 \$1.00 1 DEPT002 \$2.00 1 DEPT003 \$3.00 1 DEPT004 \$4.00 CANCEL
2 00 2	
3 00 3	
4 00 4	
SUB TOTAL	

Pressing **SUB TOTAL** key is necessary to cancel the transaction.

ERR CORR. CANCEL

Printing the daily sales reset report

This report shows daily sales totals.

OPERATION

REPORT

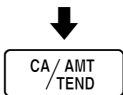
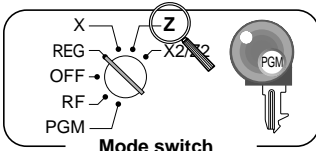

Z	03-06-2008 17:00	Date/time
	0001 000231	Machine No./consecutive No.
Z	DAILY Z	Report title
Z	DEPT 0001	Department report title/reset counter
	0001015	Report code
DEPT001	203.25	Department count/amount *1
	\$1,108.54	
DEPT002	183	Department count/amount *1
	\$1,362.26	
	5	
TL	421.25	Department total count/total amount
	\$2,872.28	
Z	FIX 0001	Fixed total report title/reset counter
	0001011	Report code
GROSS	981.25	Gross total *2
	\$6,574.40	
NET	No 111	Net total *2
	\$7,057.14	
CAID	\$1,919.04	Cash in drawer *2
CHID	\$139.04	Charge in drawer *2
CKID	\$859.85	Check in drawer *2
CRID(1)	\$709.85	Credit in drawer 1 *2
CRID(2)	\$0.00	Credit in drawer 2 *2
CRID(3)	\$0.00	Credit in drawer 3 *2
CRID(4)	\$0.00	Credit in drawer 4 *2
RF	No 3	Refund mode *2
	\$10.22	
CUST	CT 111	Number of customer *2
AVRG	\$63.57	Average sales per customer *2
DC	\$1.22	Discount total *2
REF	\$2.42	Refund key *2
ROUND	\$0.00	Rounding total *2
CANCEL	No 2	Cancellation *2
	\$12.97	

TA1	\$2,369.69	Taxable 1 amount *2
TX1	\$128.86	Tax 1 amount *2
TA2	\$2,172.96	Taxable 2 amount *2
TX2	\$217.33	Tax 2 amount *2
GT	\$00000000125478.96	Grand total *2
Z	TRANS 0001	Function key report title/reset counter
	0001012	Report code
CASH	No 362	Function key count/amount *1
	\$1,638.04	
CHARGE	No 56	Function key count/amount *1
	\$1,174.85	
RC	No 4	Function key count/amount *1
	\$810.00	
PD	No 5	Function key count/amount *1
	\$520.00	
	\$5.00	
CORR	No 14	Function key count/amount *1
	\$39.55	
RCT	No 3	Function key count/amount *1
	5	

*1 Zero totalled departments/functions (the amount and item numbers are both zero) are not printed.

*2 These items can be skipped by programming.

Using clerk functions

Enable clerk feature

Please follow the below procedure to enable clerk feature.

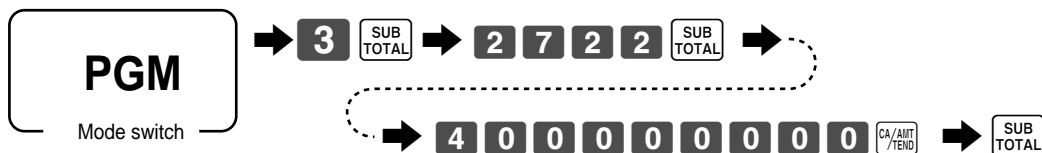

Assigning a clerk

You can assign clerks by using clerk number.

Clerk number key

Clerk sign on

Signing clerk 1 on:

1 →

Signing clerk 2 on:

2 →

Clerk number :
:

OPERATION

RECEIPT

```
* COMMERCIAL MESSAGE *
REG 03-06-2008 11:58
C01 0001 000123
1 DEPT01
```

Clerk name/machine No./consecutive No.

- If you do not want the clerk number to be shown on the display, press before entering the number.

Clerk sign off

Signing clerk off:
(except PGM mode)

OPERATION

- The current clerk is also signed off whenever you set the mode switch to OFF position.

Important!

- The error code "E008" appears on the display whenever you try to perform a registration, a read/reset operation without signing on.
- The signed on clerk is also identified on the receipt/journal.

Single item cash sales

A department key or PLU programmed with single item sale status finalizes the transaction as soon as it is registered.

The single item sales function can only be used for cash sales.

Example 1

OPERATION			RECEIPT											
	Dept. 1	\$1.00	1	00	1									
Item	Quantity	1	The transaction is immediately finalized.											
	Status	S.I.S												
Payment	Cash	\$1.00	<table style="width: 100%; border-collapse: collapse;"> <tr> <td style="width: 60%;">1 DEPT001</td> <td style="width: 10%; text-align: right;">\$1.00</td> <td style="width: 30%;"></td> </tr> <tr> <td>TL</td> <td style="text-align: right;">\$ 1.00</td> <td></td> </tr> <tr> <td>CASH</td> <td style="text-align: right;">\$1.00</td> <td></td> </tr> </table>			1 DEPT001	\$1.00		TL	\$ 1.00		CASH	\$1.00	
1 DEPT001	\$1.00													
TL	\$ 1.00													
CASH	\$1.00													

Department No./ unit price
Cash total amount

Example 2

OPERATION			RECEIPT											
	Dept. 1	(\$1.00)	3	<input checked="" type="checkbox"/> FOR DATE TIME	1									
Item	Quantity	3	The transaction is immediately finalized.											
	Status	S.I.S												
Payment	Cash	\$3.00	<table style="width: 100%; border-collapse: collapse;"> <tr> <td style="width: 60%;">3 DEPT001</td> <td style="width: 10%; text-align: right;">\$3.00</td> <td style="width: 30%;"></td> </tr> <tr> <td>TL</td> <td style="text-align: right;">\$3.00</td> <td></td> </tr> <tr> <td>CASH</td> <td style="text-align: right;">\$3.00</td> <td></td> </tr> </table>			3 DEPT001	\$3.00		TL	\$3.00		CASH	\$3.00	
3 DEPT001	\$3.00													
TL	\$3.00													
CASH	\$3.00													

Example 3

OPERATION			RECEIPT														
	Dept. 3	\$2.00	2	00	3												
Item 1	Quantity	1	The transaction is not finalized. Because another item is registered before the single item sales department.														
	Status	Normal															
	Dept. 1	(\$1.00)	<input type="checkbox"/> CA / AMT / TEND														
Item 2	Quantity	1															
	Status	S.I.S															
Payment	Cash	\$3.00	<table style="width: 100%; border-collapse: collapse;"> <tr> <td style="width: 60%;">1 DEPT003</td> <td style="width: 10%; text-align: right;">\$2.00</td> <td style="width: 30%;"></td> </tr> <tr> <td>1 DEPT001</td> <td style="text-align: right;">\$1.00</td> <td></td> </tr> <tr> <td>TL</td> <td style="text-align: right;">\$3.00</td> <td></td> </tr> <tr> <td>CASH</td> <td style="text-align: right;">\$3.00</td> <td></td> </tr> </table>			1 DEPT003	\$2.00		1 DEPT001	\$1.00		TL	\$3.00		CASH	\$3.00	
1 DEPT003	\$2.00																
1 DEPT001	\$1.00																
TL	\$3.00																
CASH	\$3.00																

Currency exchange function

When <CE> key is pressed, a current subtotal including tax is converted directly into foreign currency and the result is displayed, and the subsequent finalization is handled using the foreign currency. The currency exchange function is released by finalizing a transaction, partial tender operation, receipt issuance, or by pressing <SUBTOTAL>.

Before using the currency exchange function, it is necessary to program the conversion rate.

Registering foreign currency

Full amount tender in foreign currency

* Pre-programmed exchange rate: ¥ 100 = \$0.9524

Important!

Tenders in a foreign currency can be registered using the **CA/AMT/TEND** and **CHK** only. Other finalize keys cannot be used.

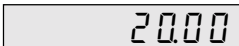
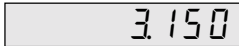
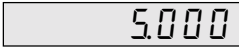
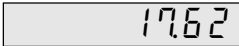
OPERATION	DISPLAY	RECEIPT														
1 0 00 1 ← Enter the unit price and press the applicable department key.	 (Displays in \$)	<table border="1"> <tr> <td>1 DEPT001</td> <td>\$10.00</td> </tr> <tr> <td>1 DEPT002</td> <td>\$20.00</td> </tr> <tr> <td>TL</td> <td>- 30.00</td> </tr> <tr> <td>CE</td> <td></td> </tr> <tr> <td>CASH</td> <td>¥5,000</td> </tr> <tr> <td>CASH</td> <td>\$47.62</td> </tr> <tr> <td>CG</td> <td>\$17.62</td> </tr> </table>	1 DEPT001	\$10.00	1 DEPT002	\$20.00	TL	- 30.00	CE		CASH	¥5,000	CASH	\$47.62	CG	\$17.62
1 DEPT001	\$10.00															
1 DEPT002	\$20.00															
TL	- 30.00															
CE																
CASH	¥5,000															
CASH	\$47.62															
CG	\$17.62															
2 0 00 2 ← Enter the next unit price and press the applicable department key.	 (Displays in \$)															
CE SUB TOTAL ← Press CE and SUB TOTAL without entering a numeric value. This operation converts the subtotal (including tax) dollar value into yen by applying a pre-programmed exchange rate. The result is shown on the display and printed on the receipt/journal by programming.	 (Displays in ¥: 3,150)															
5 0 00 CE ← Enter the amount tendered in yen and press CE . This operation converts the entered yen amount into dollars by applying a pre-programmed exchange rate. The result is shown on the display. (5,000)	 (Displays in \$)															
CA/AMT/TEND ← Press to finalize the transaction. Note that you do not need to reenter the dollar amount. The register automatically calculates the change amount due in dollars and shows it on the display, receipts and journal.	 (Displays in \$)															

Partial tender in a foreign currency

* Pre-programmed exchange rate: ¥ 100 = \$0.9524

Important!

Partial tender in a foreign currency can be registered using **CA/AMT/TEND** and **CHK** only. Other finalization keys cannot be used, but the remaining tender can be finalized using any finalize key.

OPERATION

DISPLAY

RECEIPT

1 0 00 **1**

← Enter the unit price and press the applicable department key.

10.00
(Displays in \$)

2 0 00 **2**

← Enter the next unit price and press the applicable department key.

20.00
(Displays in \$)

CE **SUB/TOTAL**

← Press **CE** and **SUB/TOTAL** without entering a numeric value. This operation converts the subtotal (including tax) dollar value into yen by applying a pre-programmed exchange rate. The result is shown on the display and printed on the receipt/journal by programming.

3.150
(Displays in ¥: 3,150)

2 0 00 **CE**
(2,000)

← Enter the partial amount tendered in yen and press **CE**. This operation converts the entered yen amount into dollars by applying a pre-programmed exchange rate. The result is shown on the display.

2.000

CA/AMT/TEND

← Press **CA/AMT/TEND** to specify cash tender for the yen partial tender. Note that you do not need to reenter the dollar amount. The register automatically deducts the dollar equivalent of the yen amount tendered from the total amount due and shows the amount on the display.

10.95
(Displays in \$)

CHK/TEND

← Press to finalize the transaction.

10.95
(Displays in \$)

1	DEPT001	\$10.00
1	DEPT002	\$20.00
	TL	\$30.00
	CE	
	CASH	¥2,000
	CASH	\$19.05
	CHECK	\$10.95

- If <Currency Exchange> key is not allocated on the keyboard, key allocation is necessary.

Advanced Operations and Setups

Premium

Example

OPERATION			RECEIPT		
Item 1	Dept. 1	\$1.00	1 00 1	1 DEPT001	\$1.00
	Quantity	1	1 0 %+	10%	\$0.10
	Premium	10%	3 X / FOR	3 DEPT001	\$6.00
Item 2	Dept. 1	\$2.00	2 00 1	ST	\$7.10
	Quantity	3	3 X / FOR	15%	\$1.07
Subtotal	Premium	(15%)	SUB	TL	\$8.17
Payment	Cash	\$8.17	TOTAL	CASH	\$8.17
			%+		
			CA / AMT		
			TEND		

- If **%+** is not allocated on the keyboard, key allocation is necessary.

Coupon

Note that errors result when the result of a calculation is negative if the cash register is programmed to prohibit credit balances.

Example

OPERATION			RECEIPT		
Item 1	Dept. 1	\$3.00	2 X / FOR	2 DEPT001	\$6.00
	Quantity	2	3 00 1	COUPON	-1.00
	Coupon	\$0.50 × 2	2 X / FOR	1 DEPT003	\$4.00
Item 2	Dept. 3	\$4.00	5 0 CPN	COUPON	-1.00
	Quantity	1	4 00 3	TL	\$8.00
	Coupon	(\$1.00)	CPN	CASH	\$8.00
Payment	Cash	\$8.00	CPN		
			CA / AMT		
			TEND		

- If **CPN** is not allocated on the keyboard, key allocation is necessary.

Age verification

This function is used to prohibit the item registration for the person whose age is under the programmed value.

Example

	OPERATION	RECEIPT																																							
<table border="1" style="width: 100%; border-collapse: collapse;"> <tr> <td style="width: 15%;">Item 1</td> <td style="width: 20%;">Dept. 1</td> <td style="width: 15%;">\$1.00</td> </tr> <tr> <td></td> <td>Quantity</td> <td>1</td> </tr> <tr> <td></td> <td>Age limit</td> <td>18</td> </tr> <tr> <td style="vertical-align: top;">Item 2</td> <td>Dept. 3</td> <td>\$2.00</td> </tr> <tr> <td></td> <td>Quantity</td> <td>1</td> </tr> <tr> <td></td> <td>Age limit</td> <td>20</td> </tr> <tr> <td>Payment</td> <td>Cash</td> <td>\$1.00</td> </tr> <tr> <td colspan="2">Birthdate</td> <td>May. 03. 1988</td> </tr> <tr> <td colspan="2">Current date</td> <td>Apr. 03. 2006</td> </tr> </table>	Item 1	Dept. 1	\$1.00		Quantity	1		Age limit	18	Item 2	Dept. 3	\$2.00		Quantity	1		Age limit	20	Payment	Cash	\$1.00	Birthdate		May. 03. 1988	Current date		Apr. 03. 2006	<div style="display: flex; justify-content: center; gap: 10px;"> 1 00 <input type="text" value="1"/> </div> <p>Error "PLEASE ENTER BIRTHDATE" occurs.</p> <div style="display: flex; justify-content: center; gap: 10px;"> 0 5 0 3 </div> <div style="display: flex; justify-content: center; gap: 10px;"> 1 9 8 8 <input type="text" value="AGE"/> </div> <p>Enter birthdate by "MM-DD-YYYY" order.</p> <div style="display: flex; justify-content: center; gap: 10px;"> 1 00 <input type="text" value="1"/> </div> <div style="display: flex; justify-content: center; gap: 10px;"> 2 00 <input type="text" value="3"/> </div> <p>Error "AGE DOES NOT PERMIT PRODUCT PURCHASE" occurs.</p> <div style="border: 1px solid black; padding: 2px; display: inline-block; margin-top: 5px;"> CA/AMT TEND </div>	<table border="1" style="width: 100%; border-collapse: collapse;"> <tr> <td style="width: 15%;">AGE</td> <td style="width: 40%;">05-03-1988</td> <td style="width: 45%;">Birthdate *</td> </tr> <tr> <td>1 DEPT001</td> <td>\$1.00</td> <td></td> </tr> <tr> <td>TL</td> <td>\$ 1.00</td> <td></td> </tr> <tr> <td>CASH</td> <td>\$1.00</td> <td></td> </tr> </table> <p style="text-align: center; margin-top: 10px;">* This item can be skipped by programming.</p>	AGE	05-03-1988	Birthdate *	1 DEPT001	\$1.00		TL	\$ 1.00		CASH	\$1.00	
Item 1	Dept. 1	\$1.00																																							
	Quantity	1																																							
	Age limit	18																																							
Item 2	Dept. 3	\$2.00																																							
	Quantity	1																																							
	Age limit	20																																							
Payment	Cash	\$1.00																																							
Birthdate		May. 03. 1988																																							
Current date		Apr. 03. 2006																																							
AGE	05-03-1988	Birthdate *																																							
1 DEPT001	\$1.00																																								
TL	\$ 1.00																																								
CASH	\$1.00																																								

- If is not allocated on the keyboard, key allocation is necessary.

Check tracking systems

Check tracking system

With the check tracking system, the amount, check number, store number, date/time and registration detail data are stored in two files (check tracking index file and check tracking detail file).

- Check tracking detail file and index file are cleared by the following timing:
 1. The check is cleared after printing finalized data on guest check receipts, or the check is also cleared when the new or old check operation is made.
 2. The check is cleared after printing finalized data on guest check receipt, or check is also cleared when the same finalized check number is assigned in new check operation.

You can select one of these options by programming.

- Either of the following two operations can be used to correct input of a wrong check number.

<NEW CHECK>

Re-input the correct check number, or cancel the original check number, issue a receipt, and then re-input the correct check number.

<OLD CHECK>, <NEW/OLD>

Temporary finalize the original check number, issue a receipt, and then re-input the correct check number.

Opening a check

Example

Check#			1234	OPERATION	RECEIPT
Item 1	Dept 1	\$10.00		1 2 3 4 NEW	CHECK No. 1234 1 DEPT001 \$10.00 1 DEPT001 \$10.00 1 DEPT002 \$20.00 1 DEPT002 \$20.00 1 DEPT003 \$30.00 SRVC TL \$90.00
	Quantity	2		1 0 00 1	
Item 2	Dept 2	\$20.00		2 0 00 2	
	Quantity	2		2	
Item 3	Dept 3	\$30.00		3 0 00 3	
	Quantity	1		NB	

Press <NEW BALANCE> to temporarily close the transaction. If you want to finalize a check immediately, use <CASH>, <CHARGE>, <CREDIT> or <CHECK>.

Adding to a check

Example

Check#			1234	OPERATION	RECEIPT
Item 1	Dept 1	\$30.00		1 2 3 4 OLD	CHECK No. 1234 CT 1 ST \$90.00 1 DEPT001 \$30.00 1 DEPT002 \$10.00 SRVC TL \$130.00
	Quantity	1		3 0 00 1	
Item 2	Dept 2	\$10.00		1 0 00 2	
	Quantity	1		NB	

Issuing a guest receipt

The following operation can be used to print out the balance of a temporarily finalized check.

Example

OPERATION	RECEIPT																				
<p>1 2 3 4 GUEST/POST RECEIPT</p> <p>Input the number of check you want.</p>	<table border="1"> <tr> <td>CHECK No. 1234</td> <td>CT 1</td> </tr> <tr> <td>1 DEPT001</td> <td>\$10.00</td> </tr> <tr> <td>1 DEPT001</td> <td>\$10.00</td> </tr> <tr> <td>1 DEPT002</td> <td>\$20.00</td> </tr> <tr> <td>1 DEPT002</td> <td>\$20.00</td> </tr> <tr> <td>1 DEPT003</td> <td>\$30.00</td> </tr> <tr> <td>1 DEPT001</td> <td>\$30.00</td> </tr> <tr> <td>1 DEPT002</td> <td>\$10.00</td> </tr> <tr> <td>SRVC TL</td> <td></td> </tr> <tr> <td></td> <td>\$130.00</td> </tr> </table>	CHECK No. 1234	CT 1	1 DEPT001	\$10.00	1 DEPT001	\$10.00	1 DEPT002	\$20.00	1 DEPT002	\$20.00	1 DEPT003	\$30.00	1 DEPT001	\$30.00	1 DEPT002	\$10.00	SRVC TL			\$130.00
CHECK No. 1234	CT 1																				
1 DEPT001	\$10.00																				
1 DEPT001	\$10.00																				
1 DEPT002	\$20.00																				
1 DEPT002	\$20.00																				
1 DEPT003	\$30.00																				
1 DEPT001	\$30.00																				
1 DEPT002	\$10.00																				
SRVC TL																					
	\$130.00																				

Closing a check memory

Example

OPERATION	RECEIPT										
<p>1 2 3 4 OLD</p> <p>1 5 0 00 CA/AMT/TEND</p>	<table border="1"> <tr> <td>CHECK No. 1234</td> <td>CT 1</td> </tr> <tr> <td>ST</td> <td>\$130.00</td> </tr> <tr> <td>TL</td> <td>\$130.00</td> </tr> <tr> <td>CASH</td> <td>\$130.00</td> </tr> <tr> <td>CG</td> <td>\$20.00</td> </tr> </table>	CHECK No. 1234	CT 1	ST	\$130.00	TL	\$130.00	CASH	\$130.00	CG	\$20.00
CHECK No. 1234	CT 1										
ST	\$130.00										
TL	\$130.00										
CASH	\$130.00										
CG	\$20.00										

New / old check key operation

Example 1

When a check number is input and <NEW/OLD> is pressed, the key works as a new check key function if there is no matching check number in the check tracking memory.

OPERATION	RECEIPT								
<p>3 4 5 6 NEW/OLD</p> <p>Input a check number and press <NEW/OLD>.</p> <p>1 0 00 1</p> <p>2 0 00 2</p> <p>NB</p>	<table border="1"> <tr> <td>CHECK No. 3456</td> <td></td> </tr> <tr> <td>1 DEPT001</td> <td>\$10.00</td> </tr> <tr> <td>1 DEPT002</td> <td>\$20.00</td> </tr> <tr> <td>SRVC TL</td> <td>\$30.00</td> </tr> </table>	CHECK No. 3456		1 DEPT001	\$10.00	1 DEPT002	\$20.00	SRVC TL	\$30.00
CHECK No. 3456									
1 DEPT001	\$10.00								
1 DEPT002	\$20.00								
SRVC TL	\$30.00								

Example 2

When a check number is input and <NEW/OLD> is pressed, the key works as an old check key if there is matching check number in the check tracking memory.

OPERATION	RECEIPT										
<p>3 4 5 6 NEW/OLD</p> <p>3 0 00 CA/AMT/TEND</p>	<table border="1"> <tr> <td>CHECK No. 3456</td> <td></td> </tr> <tr> <td>ST</td> <td>\$30.00</td> </tr> <tr> <td>TL</td> <td>\$30.00</td> </tr> <tr> <td>CASH</td> <td>\$30.00</td> </tr> <tr> <td>CG</td> <td>\$0.00</td> </tr> </table>	CHECK No. 3456		ST	\$30.00	TL	\$30.00	CASH	\$30.00	CG	\$0.00
CHECK No. 3456											
ST	\$30.00										
TL	\$30.00										
CASH	\$30.00										
CG	\$0.00										

- If **NEW/OLD** is not allocated on the keyboard, key allocation is necessary.

Advanced Operations and Setups

Add check

This operation lets you combine the amounts of more than one check into a single check.

Example

Registration for check number 1234

Original check			OPERATION	RECEIPT
Check#	1234		<div style="display: flex; justify-content: space-around;"> 1234NEW </div> <div style="display: flex; justify-content: space-around;"> 10001 </div> <div style="display: flex; justify-content: space-around;"> 20002 </div> <div style="text-align: center;">NB</div>	CHECK No. 1234 1 DEPT001 \$10.00 1 DEPT002 \$20.00 SRVC TL \$30.00
Item 1	Dept 1	\$10.00		
	Quantity	1		
Item 2	Dept 2	\$20.00		
	Quantity	1		

Registration for check number 3456

Added check			OPERATION	RECEIPT
Check#	3456		<div style="display: flex; justify-content: space-around;"> 3456NEW </div> <div style="display: flex; justify-content: space-around;"> 30001 </div> <div style="text-align: center;">NB</div>	CHECK No. 3456 1 DEPT001 \$30.00 SRVC TL \$30.00
Item	Dept 1	\$30.00		
	Quantity	1		

Registration for check number 1234

Check No. : 1234		OPERATION	RECEIPT
Check No. : 1234	Check No. : 3456	<div style="display: flex; justify-content: space-around;"> 1234OLD </div> <div style="display: flex; justify-content: space-around;"> 3456ADD CHECK </div> <div style="text-align: center;">NB</div>	CHECK No. 1234 CT 1 ST \$30.00 ADD CHK 3456 ST \$30.00 SRVC TL \$60.00

- If ADD CHECK is not allocated on the keyboard, key allocation is necessary.

Flat-PLU

You can use the flat-PLUs to register items.

The procedure to register flat-PLU or to program to flat-PLU is similar to department key.

Please refer to page 31 through 34.

On these pages, replace

1. Department key (**1**, **2** ..) to flat-PLU key(**001**, **002** ..)
 2. Department shift key (**DEPT**) to menu shift key (**MENU**)
- If flat-PLU key is not allocated on the keyboard, key allocation is necessary.

Text recall

This procedure is used to recall text by inputting the address where the text is stored. The recalled text is printed on the receipt and journal.

Example

OPERATION			RECEIPT															
Item 1	Unit price	\$46.00	4 6 00 1	<table border="1"> <tr><td>CT</td><td>3</td></tr> <tr><td>1 DEPT001</td><td>\$46.00</td></tr> <tr><td>MEDIUM SIZE</td><td></td></tr> <tr><td>1 DEPT002</td><td>\$10.00</td></tr> <tr><td>SMALL SIZE</td><td></td></tr> <tr><td>TL</td><td>\$56.00</td></tr> <tr><td>CASH</td><td>\$56.00</td></tr> </table>	CT	3	1 DEPT001	\$46.00	MEDIUM SIZE		1 DEPT002	\$10.00	SMALL SIZE		TL	\$56.00	CASH	\$56.00
CT	3																	
1 DEPT001	\$46.00																	
MEDIUM SIZE																		
1 DEPT002	\$10.00																	
SMALL SIZE																		
TL	\$56.00																	
CASH	\$56.00																	
	Dept.	1	1 TEXT															
			RECALL															
Item 2	Unit price	\$10.00	1 0 00 2															
	Dept.	2	2 TEXT															
			RECALL															
Payment	Cash	\$56.00	SUB															
			TOTAL															
Text 1	MEDIUM SIZE		CA / AMT															
Text 2	SMALL SIZE		TEND															

- If **TEXT** is not allocated on the keyboard, key allocation is necessary.

Inputting the number of customers

Example

OPERATION			RECEIPT											
Item 1	Unit price	\$15.00	2 CST	<table border="1"> <tr><td>CT</td><td>2</td></tr> <tr><td>1 DEPT001</td><td>\$15.00</td></tr> <tr><td>1 DEPT002</td><td>\$5.00</td></tr> <tr><td>TL</td><td>\$20.00</td></tr> <tr><td>CASH</td><td>\$20.00</td></tr> </table>	CT	2	1 DEPT001	\$15.00	1 DEPT002	\$5.00	TL	\$20.00	CASH	\$20.00
CT	2													
1 DEPT001	\$15.00													
1 DEPT002	\$5.00													
TL	\$20.00													
CASH	\$20.00													
	Dept.	1	1 5 00 1											
Item 2	Unit price	\$5.00	5 00 2											
	Dept.	2	SUB											
Customer	Number	2	TOTAL											
			CA / AMT											
Payment	Cash	\$20.00	TEND											

- If **CST** is not allocated on the keyboard, key allocation is necessary.

Clerk interrupt function

There are two types of clerk interrupt function, illustrated by PROCEDURE 1 and PROCEDURE 2 below.

- In PROCEDURE 1, each clerk possesses a unique clerk interrupt buffer, and so the clerk interrupt function gives each individual clerk the ability to perform an independent registration operation. In this case, each clerk is individually linked to a unique clerk interrupt buffer.
- In PROCEDURE 2, multiple clerks use the same clerk interrupt buffer, and so a single clerk interrupt operation (clerk change during registration) can be performed any registration is in progress. In this case, multiple clerks are linked to a single clerk interrupt buffer.

Note the following important points concerning the clerk interrupt function.

- The register must be programmed to allow use of the clerk interrupt function.
- You cannot use the clerk interrupt function on a register set up to function as part of a check tracking system. In the REG and RF modes, clerks can be change while a transaction is in progress, making it possible for multiple clerks to simultaneously perform registrations using a single register.

For example, if clerk 1 is interrupted while registering a transaction, clerk 2 can use the same machine to register a different transaction. Then clerk 1 can continue the original registration from the point where it was interrupted.

PROCEDURE 1



PROCEDURE 2

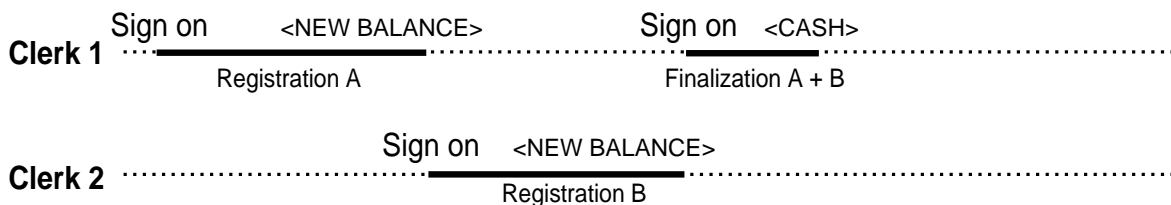

NOTES

- A guest receipt can be issued following clerk change, and receipts can be issued separately for each clerk.

Condiment / preparation PLUs

You can force entering condiment or preparation PLU after the main PLU registration by programming.

Example (condiment PLU)

OPERATION			RECEIPT																		
Main item	PLU 1	\$10.00	<div style="display: flex; justify-content: space-between;"> <div style="width: 40%;"> <p style="text-align: center;">1 PLU/ S.DEPT</p> <p>Registering main PLU. No condiment registration occurs an error condition.</p> <p style="text-align: center;">1 PLU/ S.DEPT</p> <p style="text-align: center;">1 2 PLU/ S.DEPT</p> <p style="text-align: center;">1 3 PLU/ S.DEPT</p> <p style="text-align: center; border: 1px solid black; padding: 2px;">CA/AMT /TEND</p> </div> <div style="width: 55%;"> <table style="width: 100%; border-collapse: collapse;"> <tr><td style="width: 5%;">1</td><td style="width: 75%;">PLU0001</td><td style="width: 20%; text-align: right;">\$10.00</td></tr> <tr><td></td><td>PLU0011</td><td style="text-align: right;">\$0.10</td></tr> <tr><td></td><td>PLU0012</td><td style="text-align: right;">\$0.20</td></tr> <tr><td></td><td>PLU0013</td><td style="text-align: right;">\$0.30</td></tr> <tr><td></td><td>TL</td><td style="text-align: right;">\$ 10.60</td></tr> <tr><td></td><td>CASH</td><td style="text-align: right;">\$10.60</td></tr> </table> </div> </div>	1	PLU0001	\$10.00		PLU0011	\$0.10		PLU0012	\$0.20		PLU0013	\$0.30		TL	\$ 10.60		CASH	\$10.60
1	PLU0001	\$10.00																			
	PLU0011	\$0.10																			
	PLU0012	\$0.20																			
	PLU0013	\$0.30																			
	TL	\$ 10.60																			
	CASH	\$10.60																			
	PLU 11	\$0.10																			
Condiment	PLU 12	\$0.20																			
	PLU 13	\$0.30																			
Payment	Cash	\$10.60																			

Example (preparation PLU)

OPERATION			RECEIPT																		
Main item	PLU 20	\$20.00	<div style="display: flex; justify-content: space-between;"> <div style="width: 40%;"> <p style="text-align: center;">2 0 PLU/ S.DEPT</p> <p>Registering main PLU.</p> <p style="text-align: center;">2 1 PLU/ S.DEPT</p> <p style="text-align: center;">2 2 PLU/ S.DEPT</p> <p style="text-align: center;">2 3 PLU/ S.DEPT</p> <p style="text-align: center; border: 1px solid black; padding: 2px;">CA/AMT /TEND</p> </div> <div style="width: 55%;"> <table style="width: 100%; border-collapse: collapse;"> <tr><td style="width: 5%;">1</td><td style="width: 75%;">PLU0020</td><td style="width: 20%; text-align: right;">\$20.00</td></tr> <tr><td></td><td>PLU0021</td><td></td></tr> <tr><td></td><td>PLU0022</td><td></td></tr> <tr><td></td><td>PLU0023</td><td></td></tr> <tr><td></td><td>TL</td><td style="text-align: right;">\$ 20.00</td></tr> <tr><td></td><td>CASH</td><td style="text-align: right;">\$20.00</td></tr> </table> </div> </div>	1	PLU0020	\$20.00		PLU0021			PLU0022			PLU0023			TL	\$ 20.00		CASH	\$20.00
1	PLU0020	\$20.00																			
	PLU0021																				
	PLU0022																				
	PLU0023																				
	TL	\$ 20.00																			
	CASH	\$20.00																			
	PLU 21	\$0.00																			
Preparation	PLU 22	\$0.00																			
	PLU 23	\$0.00																			
Payment	Cash	\$20.00																			

Set menu

When you register a set menu, its total amount is added to the PLU totalizer and counter. The price of each set menu item is also added to each respective PLU totalizer and counter.

Example

OPERATION			RECEIPT																					
Set menu	PLU 35	\$5.00	<div style="display: flex; justify-content: space-between;"> <div style="width: 40%;"> <p style="text-align: center;">3 5 PLU/ S.DEPT</p> <p style="text-align: center; border: 1px solid black; padding: 2px;">CA/AMT /TEND</p> </div> <div style="width: 55%;"> <table style="width: 100%; border-collapse: collapse;"> <tr><td style="width: 5%;">1</td><td style="width: 75%;">PLU0035</td><td style="width: 20%; text-align: right;">\$5.00</td></tr> <tr><td></td><td>PLU0001</td><td></td></tr> <tr><td></td><td>PLU0002</td><td></td></tr> <tr><td></td><td>PLU0003</td><td></td></tr> <tr><td></td><td>PLU0004</td><td></td></tr> <tr><td></td><td>TL</td><td style="text-align: right;">\$ 5.00</td></tr> <tr><td></td><td>CASH</td><td style="text-align: right;">\$5.00</td></tr> </table> </div> </div>	1	PLU0035	\$5.00		PLU0001			PLU0002			PLU0003			PLU0004			TL	\$ 5.00		CASH	\$5.00
1	PLU0035	\$5.00																						
	PLU0001																							
	PLU0002																							
	PLU0003																							
	PLU0004																							
	TL	\$ 5.00																						
	CASH	\$5.00																						
Item 1	PLU 1	--																						
Item 2	PLU 2	--																						
Item 3	PLU 3	--																						
Item 4	PLU 4	--																						
Payment	Cash	\$5.00																						

Arrangement key registrations

Key operations can be assigned to an <ARRANGE> (arrangement key). Then, simply pressing <ARRANGE> performs all of the key functions assigned to it.

Key operations can also be assigned to an address code. Then, when you input the address code using <ARRANGE>, all of the key functions assigned to the address code are performed.

Example 1

OPERATION			RECEIPT													
Arrangement 1			ARR	<table border="1"> <tr><td>1</td><td>PLU0001</td><td>\$8.00</td></tr> <tr><td>1</td><td>PLU0002</td><td>\$5.00</td></tr> <tr><td></td><td>TL</td><td>\$13.00</td></tr> <tr><td></td><td>CASH</td><td>\$13.00</td></tr> </table>	1	PLU0001	\$8.00	1	PLU0002	\$5.00		TL	\$13.00		CASH	\$13.00
1	PLU0001	\$8.00														
1	PLU0002	\$5.00														
	TL	\$13.00														
	CASH	\$13.00														
Item 1	PLU 1	(\$8.00)														
	Quantity	1														
Item 2	PLU 2	(\$5.00)														
	Quantity	1														
Payment	Cash	\$13.00														

Example 2

OPERATION			RECEIPT													
Arrangement 5			5 ARR	<table border="1"> <tr><td>1</td><td>DEPT001</td><td>\$1.00</td></tr> <tr><td>1</td><td>DEPT002</td><td>\$2.00</td></tr> <tr><td></td><td>TL</td><td>\$3.00</td></tr> <tr><td></td><td>CASH</td><td>\$3.00</td></tr> </table>	1	DEPT001	\$1.00	1	DEPT002	\$2.00		TL	\$3.00		CASH	\$3.00
1	DEPT001	\$1.00														
1	DEPT002	\$2.00														
	TL	\$3.00														
	CASH	\$3.00														
Item 1	Dept 1	\$1.00														
	Quantity	1														
Item 2	Dept 2	\$2.00														
	Quantity	1														
Payment	Cash	\$3.00														

- If **ARR** is not allocated on the keyboard, key allocation is necessary.

Tips

OPERATION			RECEIPT																				
Item 1	Unit price	\$3.00	3 00	1	<table border="1"> <tr><td>1</td><td>DEPT001</td><td>\$3.00</td></tr> <tr><td>1</td><td>DEPT002</td><td>\$5.00</td></tr> <tr><td></td><td>TIP</td><td>\$0.80</td></tr> <tr><td></td><td>TL</td><td>\$8.80</td></tr> <tr><td></td><td>CASH</td><td>\$10.00</td></tr> <tr><td></td><td>CG</td><td>\$1.20</td></tr> </table>	1	DEPT001	\$3.00	1	DEPT002	\$5.00		TIP	\$0.80		TL	\$8.80		CASH	\$10.00		CG	\$1.20
	1	DEPT001	\$3.00																				
1	DEPT002	\$5.00																					
	TIP	\$0.80																					
	TL	\$8.80																					
	CASH	\$10.00																					
	CG	\$1.20																					
	Dept.	1	5 00	2																			
Item 2	Unit price	\$5.00																					
	Dept.	2																					
Tip	Amount	\$0.80	8 0	TIP																			
Payment	Cash	\$10.00	1 0 00	CA/AMT/TEND																			

- If **TIP** is not allocated on the keyboard, key allocation is necessary.

Item correction by using VOID key

The following example shows how to use the **VOID** key to void previous registered items.

OPERATION				RECEIPT
Item 1	Dept. 1	\$2.35	2 3 5 1	1 DEPT001 \$2.35 1 DEPT002 \$2.00 1 PLU0001 \$1.20 VOID 1 DEPT001 -2.35 VOID 1 PLU0001 -1.20 TL \$2.00 CASH \$2.00
	Quantity	1	2 00 2	
Item 2	Dept. 2	\$2.00	1 PLU/S.DEPT	
	Quantity	1	VOID	
Item 3	PLU 1	(\$1.20) _{preset}	2 3 5 1	
	Quantity	1	Press VOID before the item you want to return.	
Void Item 1	Dept. 1	\$2.35	VOID	
	Quantity	1	1 PLU/S.DEPT	
Void Item 3	PLU 1	(\$1.20) _{preset}	SUB TOTAL	
	Quantity	1	CA/AMT TEND	
Payment	Cash	\$2.00		

Corrected items are not printed on receipt (in case of programming "Buffered receipt printing").

- If **VOID** is not allocated on the keyboard, key allocation is necessary.

Addition

OPERATION				RECEIPT
Item 1	Dept. 1	\$1.00	1 00 1	1 DEPT001 \$1.00 + \$0.10 3 DEPT001 \$6.00 + \$0.60 TL \$7.70 CASH \$7.70
	Quantity	1	1 0 +	
	Addition	\$0.10	3 X/FOR DATE TIME	
Item 2	Dept. 1	\$2.00	2 00 1	
	Quantity	3	3 X/FOR DATE TIME	
	Addition	3 × (\$0.20)	+	
Payment	Cash	\$7.70	CA/AMT TEND	

- If **+** is not allocated on the keyboard, key allocation is necessary.

Programming department / PLU descriptors and preset messages in the list

In this chapter, the procedures to choose department / PLU descriptors and preset messages from the preset list are described. Read help receipt, so that you can set the descriptors and messages easily.

How to choose and set the department / PLU descriptors in the list

1. Turn to the PGM mode.
2. Enter **0 7** and press the **HELP** key.
3. Select the item name and follow these steps in the list.

How to choose and set the preset receipt message and graphic logo in the list

1. Turn to the PGM mode.
2. Enter **0 8** and press the **HELP** key. (Programming procedure and Preset message list is issued.)
3. Follow these steps in the list.

Preset message and graphic print sample



Character manual input

This chapter shows the procedures to program department / PLU descriptors, store messages, key descriptors, report title, total descriptor (such as gross total, net total...) and clerk name.

The characters you entered by the character keyboard or multi-tapping keyboard, can be programmed.

The “Entering characters” section shows how to enter characters, and the “Programming descriptors and messages by entering characters” shows how to program the entered characters to each memory.

Entering characters

In this section, the method to enter descriptors or messages (characters) to the cash register during programming is described.

Characters are specified by character keyboard or by multi tapping method. In the first half of this section, the usage of character keyboard is described. In the latter half, inputting method by multi tapping is described.

Using character keyboard

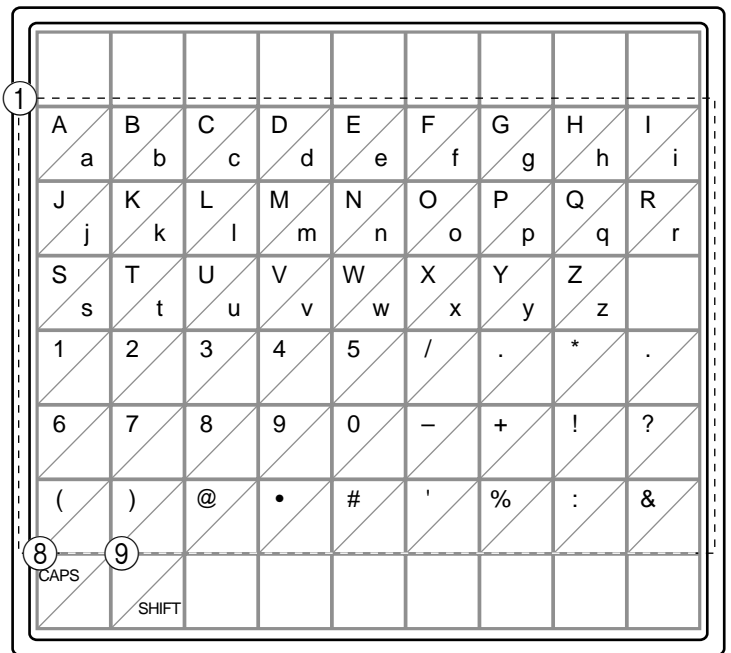
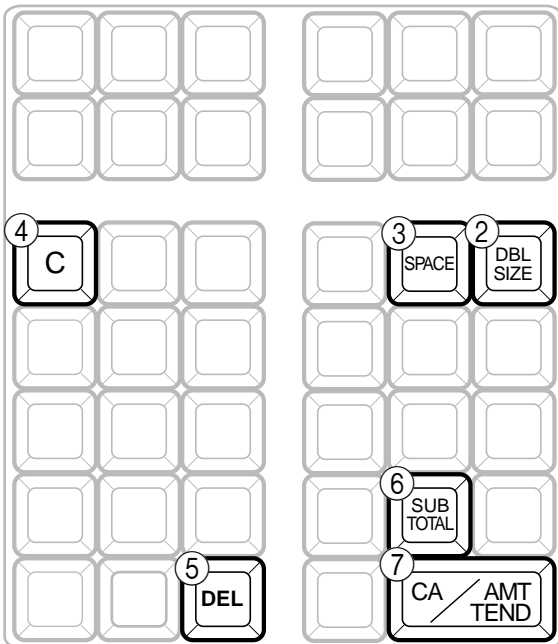

① **Alphabet keys**

Used input to characters.

② **Double size letter key**

Specifies that the next characters you input to double size characters. After completion of inputting double size character, press this key for normal size character.

③ **Space key**

Set a space by depression.

④ **Clear key**

Clears all input characters in the programming.

⑤ **Delete key**

Clears the last input character, much like a back space key.

Example:

Input “ **A** p p l e J u i c e ”,
 enter <DBL><A> <DBL><Shift><p> <p> <l> <e> <Space> <CAPS><J> <Shift><u> <i> <c> <e> .

⑥ **Program end key**

Terminates the character programming.

⑦ **Character enter key**

Registers the programmed characters.

⑧ **CAPS key**

Pressing this key shifts the character from the lowercase letter to upper case letter.

⑨ **Shift key**

Pressing this key shifts the character from the uppercase letter to lower case letter.

Entering characters by multi tapping

When you enter characters by this method, you need to press each key repeatedly until the desired character appears.

Multi tapping keyboard

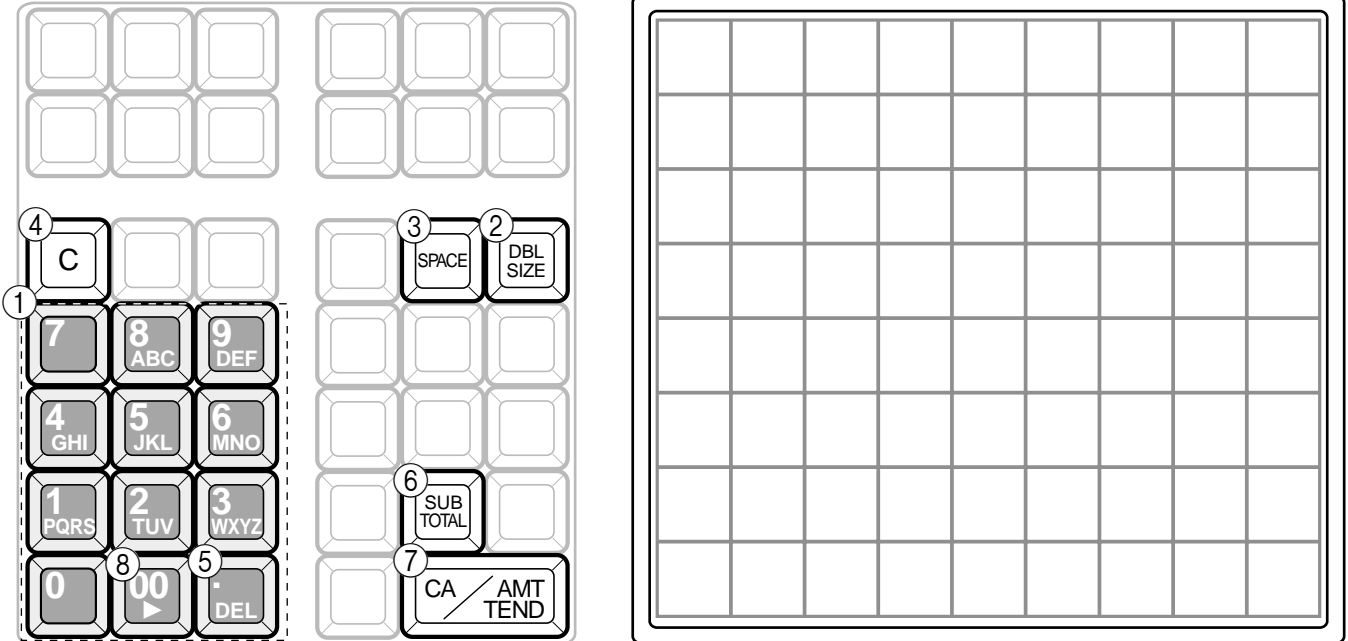

① Alphabet keys

Used input to characters.

Key	Text
7	7 @ - / : ! ? " () * # + , ^ ; < = > \$ ¥ % & [] ' { } . " . \ _ ` & x ó ì € \$ (space) _
8	A B C a b c 8 Ä Å Æ Á Â Ã Ç â ä à å æ á ã Ç
9	D E F d e f 9 ð É Ê Ë È ÿ é ê ë è f
4	G H I g h i 4 î ï ÿ ÿ î ï í
5	J K L j k l 5
6	M N O m n o 6 Ñ Ö ø Ó Ô Õ Õ ñ ô ö ò ø ó õ
1	P Q R S p q r s 1 Þ ß
2	T U V t u v 2 Û Ü Ú Û Ü Ü ú µ
3	W X Y Z w x y z 3 Ÿ Ÿ Ÿ
0	0
00	(Right cursor)
.	(Delete)

② Double size letter key

Specifies that the next characters you input to double size characters. After completion of inputting double size character, press this key for normal size character.

③ Space key

Set a space by depression.

④ Clear key

Clears all input characters in the programming.

⑤ Delete key

Clears the last input character, much like a back space key.

⑥ Program end key

Terminates the character programming.

⑦ Character enter key

Registers the programmed characters.

⑧ Right cursor key

Move the cursor to the right by one to enter a character on the same tapping key.

Example:

Input “ C L A S S a ” ,
 enter “ <DBL> 8 8 8 5 5 5 <DBL> 8 1 1 1 1 00 1 1 1 1 <Space> 8 8 8 8 ” .

Programming descriptors and messages by entering characters

The following descriptors and messages can be programmed;

- Report descriptor (such as gross total, net total, cash in drawer...)
- Grand total
- Special character (such as mode symbol, taxable symbol...)
- Read/reset report title
- Clerk name
- PLU item descriptor
- Messages (Logo, commercial and bottom message)
- Function key descriptor
- Department key descriptor

Programming PLU descriptor

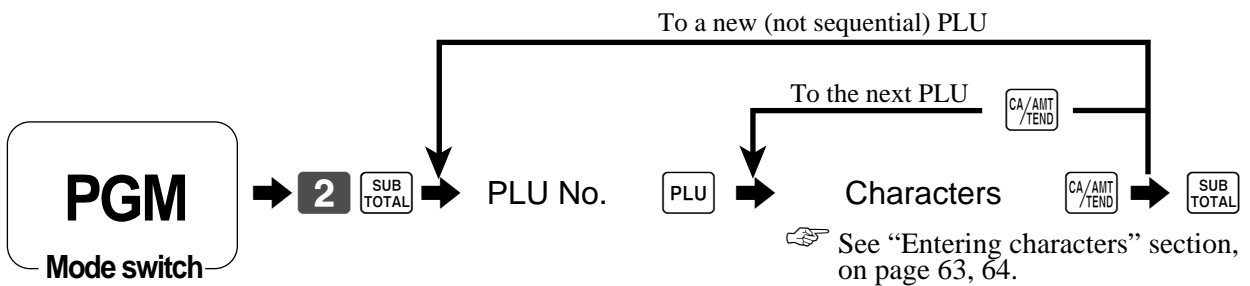

PLU No.	Contents	Initial character	Yours																	
0001	PLU0001	PLU0001																		
0002	PLU0002	PLU0002																		
0003	PLU0003	PLU0003																		
0004	PLU0004	PLU0004																		
0005	PLU0005	PLU0005																		
0006	PLU0006	PLU0006																		
0007	PLU0007	PLU0007																		
0008	PLU0008	PLU0008																		
0009	PLU0009	PLU0009																		
0010	PLU0010	PLU0010																		
0011	PLU0011	PLU0011																		
0012	PLU0012	PLU0012																		
0013	PLU0013	PLU0013																		
0014	PLU0014	PLU0014																		
0015	PLU0015	PLU0015																		
0016	PLU0016	PLU0016																		
0017	PLU0017	PLU0017																		
0018	PLU0018	PLU0018																		
0019	PLU0019	PLU0019																		
0020	PLU0020	PLU0020																		
0021	PLU0021	PLU0021																		
0022	PLU0022	PLU0022																		
0023	PLU0023	PLU0023																		
0024	PLU0024	PLU0024																		
0025	PLU0025	PLU0025																		
0026	PLU0026	PLU0026																		
0027	PLU0027	PLU0027																		
0028	PLU0028	PLU0028																		
0029	PLU0029	PLU0029																		
0030	PLU0030	PLU0030																		

Advanced Operations and Setups

Programming department / flat-PLU / function key descriptor

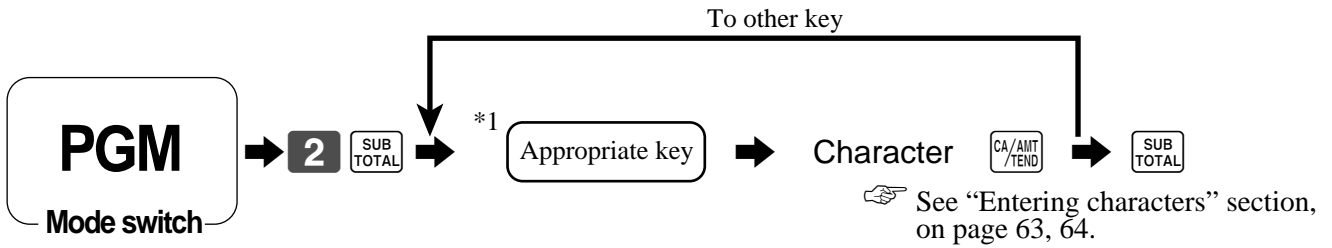

*1 Appropriate key: In case of shifting department, press <DEPT SHIFT> key first.
 In case of shifting flat-PLU, press <MENU> key first.

Function key

Contents	Initial character	Yours				
Cash/amount tendered	CASH					
Check	CHECK					
New balance	NB					
New check	NEW CHK					
Old check	OLD CHK					
Received on account	RC					
Paid out	PD					
Discount	%-					
Receipt on/off	RCT ON/OFF					
Guest / Post receipt	RCT					
Refund	RF					
Error correct/Cancel	CORR					
Sign off	SIGN-OFF					
Menu shift	MENU					
Multiplication/For/Date time	QT					
Tax shift 1	T/S1					
Tax shift 2	T/S2					
Non-add / No sale	#/NS					
MD/ST	MDST					

Department key

Contents	Initial character	Yours				
Department 001	DEPT001					
Department 002	DEPT002					
Department 003	DEPT003					
Department 004	DEPT004					
Department 005	DEPT005					
Department 006	DEPT006					
Department 007	DEPT007					

Flat-PLU key

Contents	Initial character	Yours				
PLU0001	PLU0001					
PLU0002	PLU0002					
PLU0003	PLU0003					
PLU0004	PLU0004					
PLU0005	PLU0005					
PLU0006	PLU0006					
PLU0007	PLU0007					

Programming message

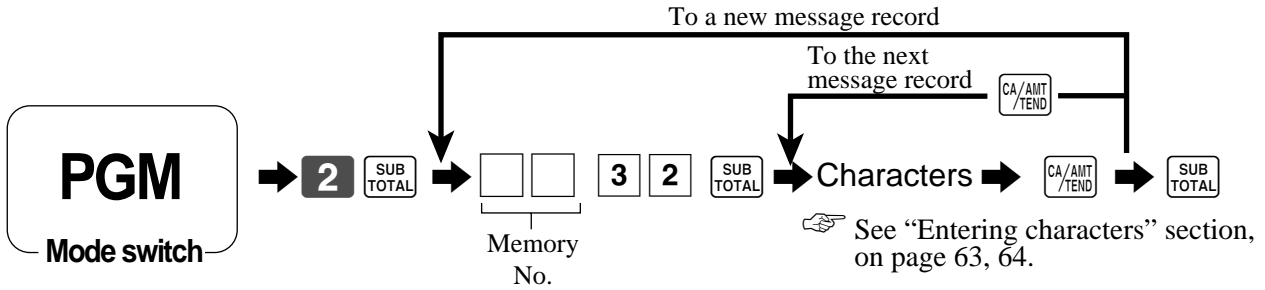

Receipt message

Refer to “(message control)” on page 75.

Memory No.	Contents	Initial character	Yours
01	1st line of logo message	YOUR RECEIPT	
02	2nd line of logo message	THANK YOU	
03	3rd line of logo message	CALL AGAIN	
04	4th line of logo message		
05	1st line of commercial message		
06	2nd line of commercial message		
07	3rd line of commercial message		
08	4th line of commercial message		
09	1st line of bottom message		
10	2nd line of bottom message		
11	3rd line of bottom message		
12	4th line of bottom message		
:	:		
25	(not used)	DUPLICATE RECEIPT	
:	:		
40	Australian GST message 1st. line	TAX INVOICE	
41	Australian GST message 2nd. line	* INDICATES	
42	Australian GST message 3rd. line	TAXABLE SUPPLY	

Programming Clerk name

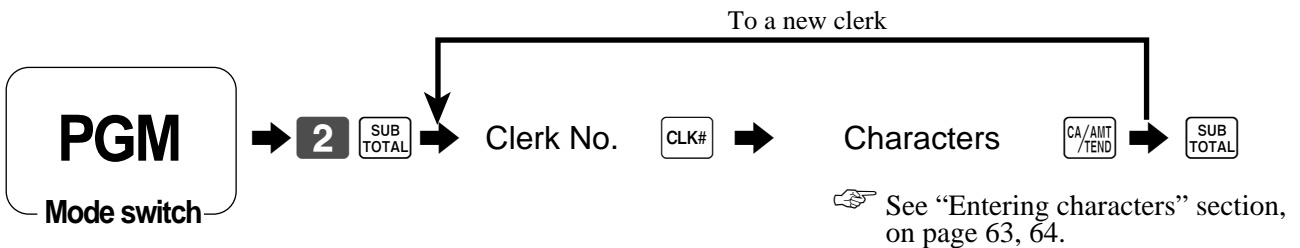

Clerk name

Clerk No.	Contents	Initial character	Yours
01	Clerk 01	C01	
02	Clerk 02	C02	
03	Clerk 03	C03	
04	Clerk 04	C04	

Advanced Operations and Setups

Programming other descriptors

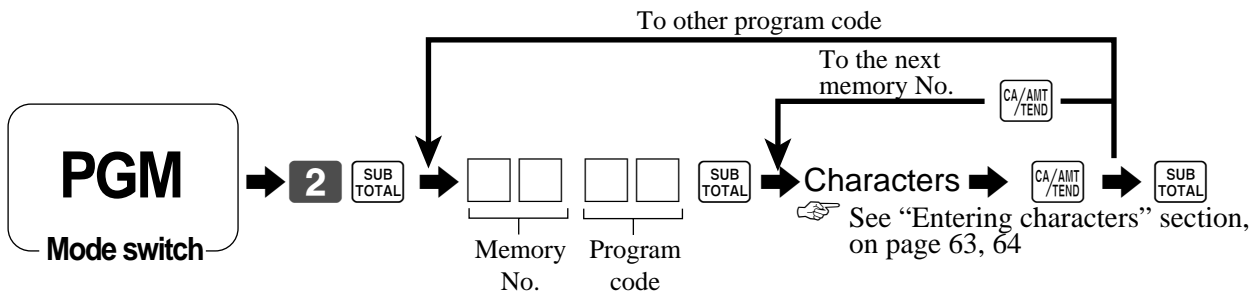

Report descriptor

Memory No.	Program code	Contents	Initial character	Yours			
01	01	Gross total	GROSS				
02		Net total	NET				
03		Cash in drawer	CAID				
04		Charge in drawer	CHID				
05		Check in drawer	CKID				
06		Credit 1 in drawer	CRID(1)				
07		Credit 2 in drawer	CRID(2)				
08		Credit 3 in drawer	CRID(3)				
09		Credit 4 in drawer	CRID(4)				
10		Cash in drawer for sub currency	CAID2				
11		Charge in drawer for sub currency	CHID2				
12		Check in drawer for sub currency	CKID2				
17		Refund mode total	RF				
18		Customer count	CUST				
19		Average sales per customer	AVER				
20		Clerk commision 1 total	C-1				
21		Clerk commision 2 total	C-2				
22		Foreign currency cash in drawer	CECA1				
23		Foreign currency check in drawer	CECK1				
26		Reduction	DC				
27		Coupon	COUPON				
28		Item return	REF				
29		Rounding for sub currency	ROUND				
30		Rounding	ROUND				
31		Cancellation	CANCEL				
33		Taxable amount 1	TA1				
34		Tax 1	TX1				
35		Taxable amount 2	TA2				
36		Tax 2	TX2				
37		Taxable amount 3	TA3				
38		Tax 3	TX3				
39		Taxable amount 4	TA4				
40		Tax 4	TX4				
41		Non taxable amount	NON TAX				

Text recall character

Memory No.	Program code	Contents	Initial character	Yours
01	39	Text recall character 01		
02		Text recall character 02		
03		Text recall character 03		
04		Text recall character 04		
05		Text recall character 05		

Grand total, special character

Memory No.	Program code	Contents	Initial character	Yours
01	23	main currency symbol (2), @ (2), No. (2), split pricing (2), not used (4), sub currency symbol (2)		\$@ No/ **
02		No. of item sold (2), No. of customer (2), not used (6), multiplication display (2)	NoCT @LB *QT	
03		multiplication (6) not used (6)	BUSY	
04		taxable symbol 1 (3 each) for tax 1, tax 2, tax 3, tax 4	T1 T2 T3 T4 T5	
06		taxable symbol 3 (3 each) for tax 1/2, tax 1/3, not used, not used, tax 2/3	T12T13T14 T23	
08		foreign currency (2 each), not used (8)	* * * * *	
09		mode symbol 1 (4 each) REG1/2, RF, not used	REG RFR	
10		mode symbol 2 (4 each) PGM, Daily X, Daily Z, Periodic	PnX Z XZ	
11		mode symbol 3 (4 each) not used, PGM read	TRG PGMX	
12		decimal: amount/q'ty, separator (main/sub) (1 each), not used (3), square (7)	. , , , , , , X	
13		A.M., P.M. (3 each), ST displayed on the dot display (2)	AM PM ST	
16		display subtotal symbol (ST key) (16)	ST	
17		subtotal discount / premium symbol (16)	ST	
18		post receipt total symbol (16)	TL	
19	change symbol (16)	CG		
01	20	Grand total (16)	GT	

Report title

Memory No.	Program code	Contents	Initial character	Yours
01	24	Fixed total report title	FIX	
02		Transaction key report title	TRANS	
03		PLU sales report title	PLU	
04		Department sales report title	DEPT	
05		Group sales report title	GROUP	
06		Clerk sales report title	CASHIER	
08		Hourly sales report title	HOURLY	
09		Monthly sales report title	MONTHLY	
16		Financial report title	FLASH	

Machine feature program

General control program

Programming procedure

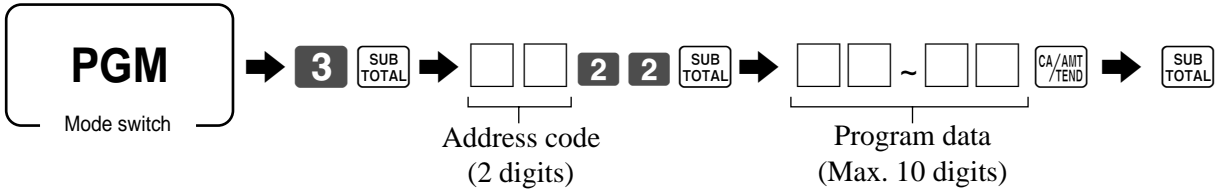

Program data (by address code)

Address code 02 (machine number)

Description	Choice	Program code	Initial value
Machine number	Significant numbers	<input type="text"/> <input type="text"/> <input type="text"/> <input type="text"/> D ₄ D ₃ D ₂ D ₁	<input type="text"/> <input type="text"/> <input type="text"/> <input type="text"/> D ₄ D ₃ D ₂ D ₁

Address code 03 (consecutive number)

Description	Choice	Program code	Initial value
Reset consecutive number after daily reset report is issued.	Yes = 0 No = 1	<input type="text"/> D ₈	<input type="text"/> D ₈
Always "00000000"		<input type="text"/> ~ <input type="text"/> D ₇ ~ D ₁	<input type="text"/> ~ <input type="text"/> D ₇ ~ D ₁

Address code 04 (tax system)

Description	Choice	Program code	Initial value
Tax system U.S. tax system = 1, Canadian tax system = 2	Significant number	<input type="text"/> D ₉	<input type="text"/> or <input type="text"/> (U.S.) (Canada) D ₉
Always "00000000"		<input type="text"/> ~ <input type="text"/> D ₈ ~ D ₁	<input type="text"/> ~ <input type="text"/> D ₈ ~ D ₁

Address code 05 (print control for receipt)

Description		Choice	Program code	Initial value
Print total line during finalization.	a	Yes = 0 No = 1	<input type="checkbox"/>	<input type="checkbox"/> 0
Time system: ① 24 hour system, ② 12 hour system	b	① = 0 ② = 2	(a+b) D ₁₀	(a+b) D ₁₀
Buffered receipt print *1		No = 0 Yes = 2	<input type="checkbox"/> D ₉	<input type="checkbox"/> D ₉
Skip item lines on journal. (journal skip)		No = 0 Yes = 1	<input type="checkbox"/> D ₈	<input type="checkbox"/> D ₈
Always "000"			<input type="checkbox"/> <input type="checkbox"/> <input type="checkbox"/> D ₇ D ₆ D ₅	<input type="checkbox"/> <input type="checkbox"/> <input type="checkbox"/> D ₇ D ₆ D ₅
Print number of item sold. (item counter)	a	No = 0 Yes = 1	<input type="checkbox"/>	<input type="checkbox"/> 0
Print tax symbols.	b	Yes = 0 No = 2	(a+b) D ₄	(a+b) D ₄
Always "00"			<input type="checkbox"/> <input type="checkbox"/> D ₃ D ₂	<input type="checkbox"/> <input type="checkbox"/> D ₃ D ₂
Print number of customers on header.		Yes = 0 No = 2	<input type="checkbox"/> D ₁	<input type="checkbox"/> D ₁

*1: Select "Yes" if you want to print receipts with watermarks.

Address code 06 (calculation & operation control)

Description		Choice	Program code	Initial value
Follow the taxable status and commission status of previous item when +/- operation is performed.	a	Yes = 0 No = 1	<input type="checkbox"/>	<input type="checkbox"/> 0
Force a money declaration before read/reset operation.	b	No = 0 Yes = 4	(a+b) D ₁₀	(a+b) D ₁₀
Force to press <input type="button" value="SUB TOTAL"/> before finalization	a	No = 0 Yes = 1	<input type="checkbox"/>	<input type="checkbox"/> 0
Allow credit balance while finalization.	b	Yes = 0 No = 2	(a+b+c) D ₉	(a+b+c) D ₉
Allow multiple refund operation.	c	Yes = 0 No = 4	<input type="checkbox"/>	<input type="checkbox"/> 0
Affect the result of +/-, %+/%- to the item. (Net totalling)		No = 0 Yes = 1	<input type="checkbox"/> D ₈	<input type="checkbox"/> D ₈
Include commission in net total.		Yes = 0 No = 2	<input type="checkbox"/> D ₇	<input type="checkbox"/> D ₇
Clear the key buffer when a receipt is issued. (REG mode only)	a	No = 0 Yes = 1	<input type="checkbox"/>	<input type="checkbox"/> 0
Sounds key catch tone.	b	Yes = 0 No = 2	(a+b+c) D ₆	(a+b+c) D ₆
Allow to issue post receipt, even if the original one is issued.	c	No = 0 Yes = 4	<input type="checkbox"/>	<input type="checkbox"/> 0
Always "00"			<input type="checkbox"/> <input type="checkbox"/> D ₅ D ₄	<input type="checkbox"/> <input type="checkbox"/> D ₅ D ₄
Treatment of flat-PLU key numeric inputs: ① Treat as amount override ② Treat as quantity extensions		① = 0 ② = 2	<input type="checkbox"/> D ₃	<input type="checkbox"/> D ₃
Always "00".			<input type="checkbox"/> <input type="checkbox"/> D ₂ D ₁	<input type="checkbox"/> <input type="checkbox"/> D ₂ D ₁

Advanced Operations and Setups

Address code 08 (print control for fixed total report)

Description		Choice	Program code	Initial value
Print gross sales total on fixed total report (GROSS)	a	Yes = 0 No = 1	<input type="checkbox"/> (a+b+c) D ₁₀	<input type="checkbox"/> 0 D ₁₀
Print net sales total on fixed total report (NET)	b	Yes = 0 No = 2		
Print cash in drawer total on fixed total report (CAID)	c	Yes = 0 No = 4		
Print charge in drawer total on fixed total report (CHID)		Yes = 0 No = 2	<input type="checkbox"/> D ₉	<input type="checkbox"/> 0 D ₉
Print check in drawer total on fixed total report (CKID)	a	Yes = 0 No = 1	<input type="checkbox"/> (a+b) D ₈	<input type="checkbox"/> (a+b) D ₈
Print credit in drawer total on fixed total report (CRID(1) ~ (4))	b	Yes = 0 No = 4		
Always "0"			<input type="checkbox"/> 0 D ₇	<input type="checkbox"/> 0 D ₇
Print RF mode total on fixed total report (RF)		Yes = 0 No = 4	<input type="checkbox"/> D ₆	<input type="checkbox"/> 0 D ₆
Print the net number of customers on fixed total report (CUST)	a	Yes = 0 No = 1	<input type="checkbox"/> (a+b) D ₅	<input type="checkbox"/> 2 D ₅
Print the average sales per customer on fixed total report (AVER)	b	Yes = 0 No = 2		
Always "0"			<input type="checkbox"/> 0 D ₄	<input type="checkbox"/> 0 D ₄
Print commission 1 total on fixed total report (C-1)	a	Yes = 0 No = 1	<input type="checkbox"/> (a+b+c) D ₃	<input type="checkbox"/> 7 D ₃
Print commission 2 total on fixed total report (C-2)	b	Yes = 0 No = 2		
Print foreign currency cash in drawer and check in drawer totals on fixed total report (CECA1 ~ 2, CECK1 ~ 2)	c	Yes = 0 No = 4		
Print <MINUS>, <COUPON>, <%-> and mix & match operation net total on fixed total report (DC)	a	Yes = 0 No = 1	<input type="checkbox"/> (a+b+c) D ₂	<input type="checkbox"/> 3 D ₂
Print <REFUND> and <VOID> operation net total on fixed total report (REF)	b	Yes = 0 No = 2		
Print nontaxable totals on fixed total report (NON TAX)	a	Yes = 0 No = 1	<input type="checkbox"/> (a+b+c) D ₁	<input type="checkbox"/> 3 D ₁
Print rounding totals on fixed total report (ROUND)	b	Yes = 0 No = 2		
Print cancellation total on fixed total report (CANCEL)	c	Yes = 0 No = 4		

Address code 10 (print control for taxable amount)

Description		Choice	Program code	Initial value
Print taxable amount 1 on receipt/journal.	a	Yes = 0 No = 1	<input type="checkbox"/> (a+b+c) D ₁₀	<input type="checkbox"/> 0 D ₁₀
Print taxable amount 2 on receipt/journal.	b	Yes = 0 No = 2		
Print taxable amount 3 on receipt/journal.	c	Yes = 0 No = 4		
Print taxable amount 4 on receipt/journal.		Yes = 0 No = 1	<input type="checkbox"/> D ₉	<input type="checkbox"/> 0 D ₉
Always "00000000"			<input type="checkbox"/> ~ <input type="checkbox"/> D ₈ ~ D ₁	<input type="checkbox"/> ~ <input type="checkbox"/> D ₈ ~ D ₁

Address code 14 (currency exchange control)

Description		Choice	Program code	Initial value
Monetary mode of CECA1 and CECK1 in fixed total report:		Significant number (0 ~ 9)	<input type="checkbox"/> D ₈	<input type="checkbox"/> D ₈
Decimal for CECA1 and CECK1 in fixed total report: ① Period = 0, ② Comma = 1	a	① = 0 ② = 1	<input type="checkbox"/> (a+b) D ₇	<input type="checkbox"/> (a+b) D ₇
Separator for CECA1 and CECK1 in fixed total report: ① Comma = 0, ② Period = 1	b	① = 0 ② = 4		
Monetary mode of CECA2 and CECK2 in fixed total report:		Significant number (0 ~ 9)	<input type="checkbox"/> D ₆	<input type="checkbox"/> D ₆
Decimal for CECA2 and CECK2 in fixed total report: ① Period = 0, ② Comma = 1	a	① = 0 ② = 1	<input type="checkbox"/> (a+b) D ₅	<input type="checkbox"/> (a+b) D ₅
Separator for CECA2 and CECK2 in fixed total report: ① Comma = 0, ② Period = 1	b	① = 0 ② = 4		
Always "0000"			<input type="checkbox"/> <input type="checkbox"/> <input type="checkbox"/> <input type="checkbox"/> D ₄ D ₃ D ₂ D ₁	<input type="checkbox"/> <input type="checkbox"/> <input type="checkbox"/> <input type="checkbox"/> D ₄ D ₃ D ₂ D ₁

Address code 15 (print control for reports)

Description		Choice	Program code	Initial value
Zero skip department report.	a	Yes = 0 No = 1	<input type="checkbox"/> (a+b) D ₁₀	<input type="checkbox"/> (a+b) D ₁₀
Zero skip clerk report.	b	Yes = 0 No = 2		
Zero skip transaction report.	a	Yes = 0 No = 1	<input type="checkbox"/> (a+b+c) D ₉	<input type="checkbox"/> (a+b+c) D ₉
Zero skip PLU report.	b	Yes = 0 No = 2		
Zero skip hourly report.	c	Yes = 0 No = 4		
Zero skip group report.		Yes = 0 No = 1	<input type="checkbox"/> D ₈	<input type="checkbox"/> D ₈
Always "0"			<input type="checkbox"/> D ₇	<input type="checkbox"/> D ₇
Prohibit issuing "OPEN CHECK Z" report.		No = 0 Yes = 1	<input type="checkbox"/> D ₆	<input type="checkbox"/> D ₆
Print PLU number on the PLU report.		No = 0 Yes = 4	<input type="checkbox"/> D ₅	<input type="checkbox"/> D ₅
Print sales ratio.	a	No = 0 Yes = 1	<input type="checkbox"/> (a+b) D ₄	<input type="checkbox"/> (a+b) D ₄
Issue double Z report.	b	No = 0 Yes = 2		
Always "000"			<input type="checkbox"/> <input type="checkbox"/> <input type="checkbox"/> D ₃ D ₂ D ₁	<input type="checkbox"/> <input type="checkbox"/> <input type="checkbox"/> D ₃ D ₂ D ₁

Advanced Operations and Setups

Address code 16 (print control for grand total)

Description	Choice	Program code	Initial value
Print consecutive number range of the day on daily fixed total report.	No = 0 Yes = 1	<input type="checkbox"/> D ₇	<input type="checkbox"/> 0 D ₇
Always "00000"		<input type="checkbox"/> 0 ~ <input type="checkbox"/> 0 D ₆ ~ D ₂	<input type="checkbox"/> 0 ~ <input type="checkbox"/> 0 D ₆ ~ D ₂
Print grand total on daily sales reset report.	Yes = 0 No = 1	<input type="checkbox"/> D ₁	<input type="checkbox"/> 0 D ₁

Address code 17 (print control)

Description	Choice	Program code	Initial value
Print date on journal.	a Yes = 0 No = 2	<input type="checkbox"/> (a+b) D ₄	<input type="checkbox"/> 0 (a+b) D ₄
Print consecutive number on receipt/journal.	b Yes = 0 No = 4		
Print time on receipt.	a Yes = 0 No = 1	<input type="checkbox"/> (a+b) D ₃	<input type="checkbox"/> 0 (a+b) D ₃
Print time on journal.	b Yes = 0 No = 2		
Always "00"		<input type="checkbox"/> 0 <input type="checkbox"/> 0 D ₂ D ₁	<input type="checkbox"/> 0 <input type="checkbox"/> 0 D ₂ D ₁

Address code 18 (print control for guest receipt)

Description	Choice	Program code	Initial value
Classify registered item by group on guest receipt.	No = 0 Yes = 4	<input type="checkbox"/> D ₆	<input type="checkbox"/> 0 D ₆
Always "0"		<input type="checkbox"/> 0 D ₅	<input type="checkbox"/> 0 D ₅
Print date on guest receipt.	a Yes = 0 No = 1	<input type="checkbox"/> (a+b) D ₄	<input type="checkbox"/> 0 (a+b) D ₄
Print time on guest receipt.	b Yes = 0 No = 2		
Merge the same registration on guest receipt. (Item consolidation)	No = 0 Yes = 4	<input type="checkbox"/> D ₃	<input type="checkbox"/> 0 D ₃
Always "00"		<input type="checkbox"/> 0 <input type="checkbox"/> 0 D ₂ D ₁	<input type="checkbox"/> 0 <input type="checkbox"/> 0 D ₂ D ₁

Address code 19 (receipt control)

Description	Choice	Program code	Initial value
Print receipt in double-height characters.	No = 0 Yes = 1	<input type="checkbox"/> D ₇	<input type="checkbox"/> 0 D ₇
Always "000000"		<input type="checkbox"/> 0 ~ <input type="checkbox"/> 0 D ₆ ~ D ₁	<input type="checkbox"/> 0 ~ <input type="checkbox"/> 0 D ₆ ~ D ₁

Address code 21 (message control)

Description	Choice	Program code	Initial value
Print graphic type logo. (If select "No", character type logo is printed.)	a No = 0 Yes = 2	<input type="checkbox"/> (a+b) D ₁₀	<input type="checkbox"/> (a+b) D ₁₀
Print watermark on receipt.	b Yes = 0 No = 4		
Print commercial message on guest receipt.	a No = 0 Yes = 1	<input type="checkbox"/> (a+b) D ₉	<input type="checkbox"/> (a+b) D ₉
Print bottom message on guest receipt.	b No = 0 Yes = 2		
Always "00"		<input type="checkbox"/> <input type="checkbox"/> D ₈ D ₇	<input type="checkbox"/> <input type="checkbox"/> D ₈ D ₇
Print commercial message on receipts in REG/RF mode.	a No = 0 Yes = 1	<input type="checkbox"/> (a+b) D ₆	<input type="checkbox"/> (a+b) D ₆
Print bottom message on receipts in REG/RF mode.	b No = 0 Yes = 2		
Always "0000"		<input type="checkbox"/> <input type="checkbox"/> <input type="checkbox"/> <input type="checkbox"/> D ₅ D ₄ D ₃ D ₂	<input type="checkbox"/> <input type="checkbox"/> <input type="checkbox"/> <input type="checkbox"/> D ₅ D ₄ D ₃ D ₂
Always "0"		<input type="checkbox"/> D ₁	<input type="checkbox"/> D ₁

Address code 26 (check tracking)

Description	Choice	Program code	Initial value
Check number compulsory	a No = 0 Yes = 1	<input type="checkbox"/> (a+b+c) D ₇	<input type="checkbox"/> (a+b+c) D ₇
Number of customer compulsory	b No = 0 Yes = 2		
Guest receipt compulsory (at finalization)	c No = 0 Yes = 4		
Always "0"		<input type="checkbox"/> D ₆	<input type="checkbox"/> D ₆
Tax calculation by new balance (Calculation result is not saved into totalizer.)	No = 0 Yes = 1	<input type="checkbox"/> D ₅	<input type="checkbox"/> D ₅
Always "0000"		<input type="checkbox"/> <input type="checkbox"/> <input type="checkbox"/> <input type="checkbox"/> D ₄ D ₃ D ₂ D ₁	<input type="checkbox"/> <input type="checkbox"/> <input type="checkbox"/> <input type="checkbox"/> D ₄ D ₃ D ₂ D ₁

Address code 27 (clerk control)

Description	Choice	Program code	Initial value
Enable clerk interrupt.	No = 0 Yes = 1	<input type="checkbox"/> D ₁₀	<input type="checkbox"/> D ₁₀
Enable clerk function.	No = 0 Yes = 4	<input type="checkbox"/> D ₉	<input type="checkbox"/> D ₉
Always "00000000"		<input type="checkbox"/> ~ <input type="checkbox"/> D ₈ ~ D ₁	<input type="checkbox"/> ~ <input type="checkbox"/> D ₈ ~ D ₁

Advanced Operations and Setups

Address code 30 (thermal printer control)

Description		Choice	Program code	Initial value
Print preset receipt message and graphic	a	No = 0 Yes = 1	<input type="checkbox"/>	<input type="checkbox"/> 0
Print preset receipt message and graphic: ① at the bottom of the receipt / ② at the top of the receipt	b	① = 0 ② = 2	(a+b) D ₅	(a+b) D ₅
Journal compressed print (print by half height characters)		Yes = 0 No = 1	<input type="checkbox"/> D ₄	<input type="checkbox"/> D ₄
Always "000"			<input type="checkbox"/> <input type="checkbox"/> <input type="checkbox"/> D ₃ D ₂ D ₁	<input type="checkbox"/> <input type="checkbox"/> <input type="checkbox"/> D ₃ D ₂ D ₁

Address code 34 (backlight control)

Description		Choice	Program code	Initial value
Backlight		Available = 0 Not available = 1	<input type="checkbox"/> D ₄	<input type="checkbox"/> D ₄
Always "000"			<input type="checkbox"/> <input type="checkbox"/> <input type="checkbox"/> D ₃ D ₂ D ₁	<input type="checkbox"/> <input type="checkbox"/> <input type="checkbox"/> D ₃ D ₂ D ₁



Key function program

Department key/Flat-PLU key/PLU program (Batch feature programming)

Programming procedure

Department/Flat-PLU key

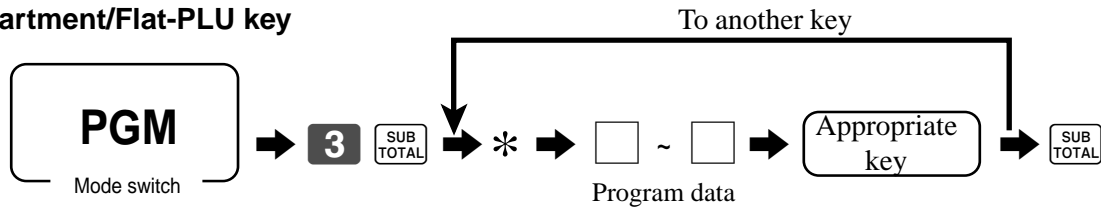

*: In case of shifting department, press <DEPT SHIFT> key first.
In case of shifting flat-PLU, press <MENU SHIFT> key first.

PLU

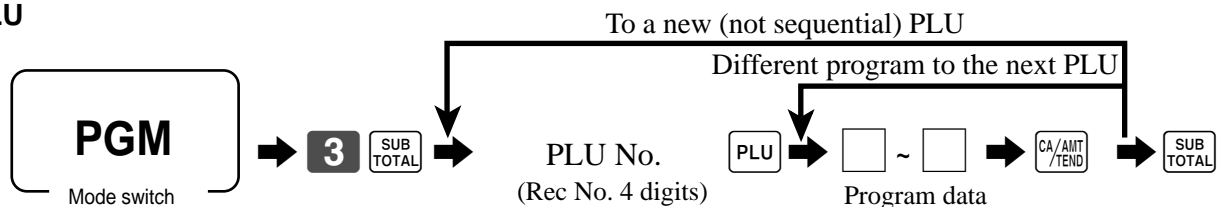

Program data

Description		Choice	Program code	Initial value
Age limitation ("00" means no limitation)		Significant number (00 - 99)	<input type="text"/> <input type="text"/> D ₁₄ D ₁₃	<input type="text"/> <input type="text"/> D ₁₄ D ₁₃
Single item control: Normal receipt = 0, Single item receipt = 3		Significant number	<input type="text"/> D ₁₂	<input type="text"/> D ₁₂
Always "0"			<input type="text"/> D ₁₁	<input type="text"/> D ₁₁
Normal / condiment / preparation (Only for PLU, Flat-PLU) Normal item = 0, Condiment = 1, Preparation = 2		Significant number	<input type="text"/> D ₁₀	<input type="text"/> D ₁₀
Always "0"			<input type="text"/> D ₉	<input type="text"/> D ₉
Taxable status: See page 81.			<input type="text"/> <input type="text"/> D ₈ D ₇	<input type="text"/> <input type="text"/> D ₈ D ₇
Enable 0 unit price.	a	No = 0 Yes = 1	<input type="text"/> (a+b+c) D ₆	<input type="text"/> (a+b+c) D ₆
Enable negative price.	b	No = 0 Yes = 2		
Hash	c	No = 0 Yes = 4		
Always "0"			<input type="text"/> D ₅	<input type="text"/> D ₅
Low digit limitation (LDL) for manually entered unit price.		Significant number	<input type="text"/> D ₄	<input type="text"/> D ₄
Open PLU (only for PLU)		No = 0 Yes = 4	<input type="text"/> D ₃	<input type="text"/> D ₃
Commission 1	a	No = 0 Yes = 1	<input type="text"/> (a+b) D ₂	<input type="text"/> (a+b) D ₂
Commission 2	b	No = 0 Yes = 2		
Always "0"			<input type="text"/> D ₁	<input type="text"/> D ₁

Department key/Flat-PLU key/PLU program (Individual feature programming)

Programming procedure

Department/Flat-PLU key

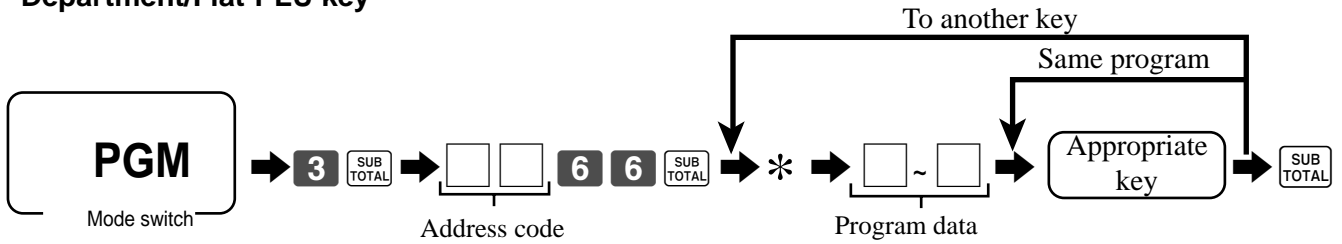

*: In case of shifting department, press <DEPT SHIFT> key first.
 In case of shifting flat-PLU, press <MENU SHIFT> key first.

PLU

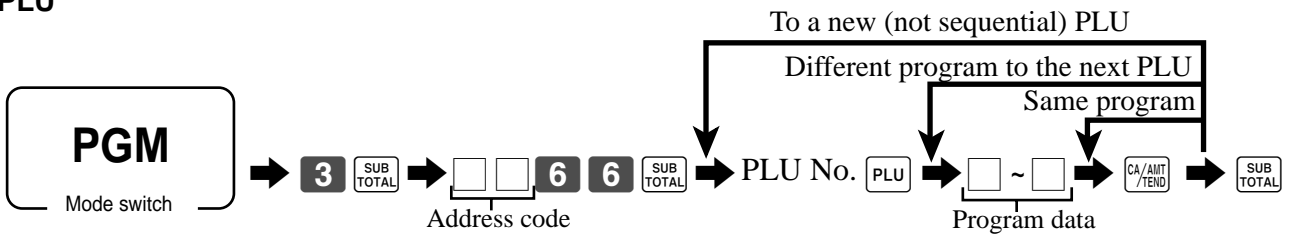

Advanced Operations and Setups

Program data (by address code)

Address code 11 (link)

Description	Choice	Program code
Link group record number: (000 ~ 999)	Significant numbers	<input type="text"/> <input type="text"/> <input type="text"/> D ₇ D ₆ D ₅
Always "0"		<input type="text"/> D ₄
Link department record number: (000 ~ 999) (only for PLU)	Significant numbers	<input type="text"/> <input type="text"/> <input type="text"/> D ₃ D ₂ D ₁

Address code 13 (set menu)

Description	Choice	Program code
Set menu table record number (only for PLU)	Significant numbers	<input type="text"/> <input type="text"/> <input type="text"/> <input type="text"/> D ₄ D ₃ D ₂ D ₁

Address code 15 (high amount limit)

Description	Choice	Program code
High amount limit for entering unit price manually.	Significant numbers	<input type="text"/> <input type="text"/> <input type="text"/> <input type="text"/> <input type="text"/> <input type="text"/> D ₆ D ₅ D ₄ D ₃ D ₂ D ₁

Other address code

Address code	Description	Choice	Program code
18	Single item control: Normal receipt = 0, Single item receipt = 3	Significant number	<input type="text"/>
01	Normal/condiment/preparation Normal item = 0, Condiment = 1, Preparation = 2	Significant number	<input type="text"/>
03	Taxable status: See page 81.	Significant numbers	<input type="text"/> <input type="text"/> D ₂ D ₁
05	Enable 0 unit price.	a	No = 0 Yes = 1
	Enable negative price.	b	No = 0 Yes = 2
	Hash	c	No = 0 Yes = 4
07	Low digit limitation (LDL) for manually entered unit price.	Significant number	<input type="text"/>
04	Open PLU (Only for PLU)	No = 0 Yes = 4	<input type="text"/>
09	Commission 1	a	No = 0 Yes = 1
	Commission 2	b	No = 0 Yes = 2
26	Age limitation ("00" means no limitation)	Significant number (00 ~ 99)	<input type="text"/> <input type="text"/>

Taxable status

for the U.S.

Always "0"			<input type="text" value="0"/> D ₈
Taxable 1 status	a	No = 0 Yes = 1	<input type="text"/> (a+b+c) D ₇
Taxable 2 status	b	No = 0 Yes = 2	
Taxable 3 status	c	No = 0 Yes = 4	

for Canada

Always "0"			<input type="text" value="0"/> D ₈
Non tax = 0 Taxable 1 = 1 Taxable 2 = 2	Taxable 3 = 3 Taxable 4 = 4 Taxable 1 & 2 = 5	Taxable 1 & 3 = 6 Taxable 1 & 4 = 7	Significant number <input type="text"/> D ₇

Transaction key program

Programming procedure

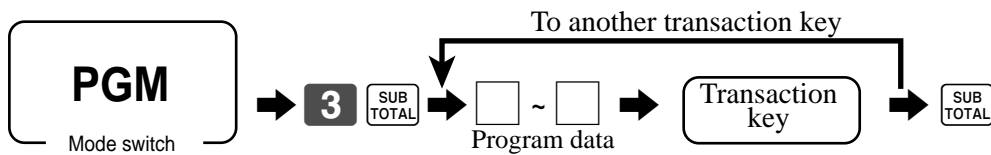

Program data

<CASH>, <CHARGE>, <CHECK>

Description	Choice	Program code
Prohibit entry of a partial payment	a No = 0 Yes = 1	<input type="text"/> (a+b+c) D ₇
Prohibit the entry of the amount tendered.	b No = 0 Yes = 2	
Force entry of the amount tendered.	c No = 0 Yes = 4	
Print VAT breakdown. *1	No = 0 Yes = 1	<input type="text"/> D ₆
Always "0"		<input type="text" value="0"/> D ₅
High amount limit specification for subtotal and tendering amounts.	Maximum value (0 ~ 9)	<input type="text"/> <input type="text"/> D ₄ D ₃
	Number of zeros (0 ~ 9)	
High amount limit specification for change amount due.	Maximum value (0 ~ 9)	<input type="text"/> <input type="text"/> D ₂ D ₁
	Number of zeros (0 ~ 9)	

*1 This is valid option for Auto Cash, Single item or Currency exchange (include partial tender) as well.

Advanced Operations and Setups

<RECEIVED ON ACCOUNT>, <PAID OUT>

Description	Choice	Program code
High amount limit specification for entering amounts	Maximum value (0 ~ 9)	<input type="text"/> <input type="text"/> D ₄ D ₃
	Number of zeros (0 ~ 9)	
Always "00"		<input type="text"/> <input type="text"/> D ₂ D ₁

<ADDITION (PLUS)>, <REDUCTION (MINUS)>, <COUPON>

Description	Choice	Program code
Taxable status: See page 81.		<input type="text"/> <input type="text"/> D ₈ D ₇
Allow credit balance. (-, CPN only)	a No = 0 Yes = 1	<input type="text"/> (a+b) D ₆
Allow out of sales (+ only)	b No = 0 Yes = 2	
Always "00"		<input type="text"/> <input type="text"/> D ₅ D ₄
High digit limitation (HDL) for manually entered unit price ("9" means NOT allow manual entry.)	Significant number	<input type="text"/> D ₃
Commission 1	a No = 0 Yes = 1	<input type="text"/> (a+b) D ₂
Commission 2	b No = 0 Yes = 2	
Always "0"		<input type="text"/> D ₁

<PREMIUM (%+)>, <DISCOUNT (%-)>

Description	Choice	Program code
Taxable status: See page 81.		<input type="text"/> <input type="text"/> D ₈ D ₇
Prohibit manual rate override.	No = 0 Yes = 2	<input type="text"/> D ₆
Rounding: Round off = 0, cut off = 1, round up = 2	Significant number	<input type="text"/> D ₅
Always "00"		<input type="text"/> <input type="text"/> D ₄ D ₃
Commission 1	a No = 0 Yes = 1	<input type="text"/> (a+b) D ₂
Commission 2	b No = 0 Yes = 2	
Always "0"		<input type="text"/> D ₁

<NON-ADD (#)>, <NON-ADD (#)/NO SALE>

Description	Choice	Program code
Allow mode change or clerk change after non-add registration as first transaction. (only for non-add function)	Yes = 0 No = 1	<input type="text"/> D ₇
Always "0000"		<input type="text"/> <input type="text"/> <input type="text"/> <input type="text"/> D ₆ D ₅ D ₄ D ₃
Always "00"		<input type="text"/> <input type="text"/> D ₂ D ₁

<CURRENCY EXCHANGE>

Description	Choice	Program code
Define amount symbol. (0, 1 ~ 2) ("0" means local currency symbol.)	Significant number	<input type="text"/> D ₇
Define foreign currency totalizer. (0, 1 ~ 2) ("0" treats as "1".)	Significant number	<input type="text"/> D ₆
Rounding: Round off = 0, cut off = 1, round up = 2	Significant number	<input type="text"/> D ₅
Always "0"		<input type="text"/> D ₄
Monetary mode (0 ~ 9): 0.00 = 2, 0.0 = 1, 0 = 0, 0.0000 = 3	Significant number	<input type="text"/> D ₃
Monetary symbol for decimal	a	<input type="text"/> (a+b) D ₂
Monetary symbol for separator	b	
Always "0"		<input type="text"/> D ₁

<MULTIPLICATION / FOR>

Description	Choice	Program code
Multiplication procedure: (<X> only) ① Quantity × Amount, ② Amount × Quantity	① = 0 ② = 1	<input type="text"/> D ₆
Rounding: Round off = 0, cut off = 1, round up = 2	Significant number	<input type="text"/> D ₅
Always "0000"		<input type="text"/> <input type="text"/> <input type="text"/> <input type="text"/> D ₄ D ₃ D ₂ D ₁

<AGE VERIFICATION>

Description	Choice	Program code
Print when this key is registered.	Yes = 0 No = 1	<input type="text"/> D ₁₀
Always "000"		<input type="text"/> <input type="text"/> <input type="text"/> D ₉ D ₈ D ₇
Always "000000"		<input type="text"/> <input type="text"/> <input type="text"/> <input type="text"/> <input type="text"/> <input type="text"/> D ₆ D ₅ D ₄ D ₃ D ₂ D ₁

<SUBTOTAL>, <MERCHANDISE SUBTOTAL>

Description	Choice	Program code
Print when key is pressed.	No = 0 Yes = 4	<input type="text"/> D ₆
Always "00000"		<input type="text"/> <input type="text"/> <input type="text"/> <input type="text"/> <input type="text"/> D ₅ D ₄ D ₃ D ₂ D ₁

<TAX SHIFT>

Description	Choice	Program code
Taxable status (00, 01 ~ 04) ("00" means taxable 1.)	Significant numbers	<input type="text"/> <input type="text"/> D ₈ D ₇
Always "000000"		<input type="text"/> <input type="text"/> <input type="text"/> <input type="text"/> <input type="text"/> <input type="text"/> D ₆ D ₅ D ₄ D ₃ D ₂ D ₁

Advanced Operations and Setups

<CREDIT>

Description	Choice	Program code
Prohibit entry of a partial payment	a No = 0 Yes = 1	<input type="checkbox"/> (a+b+c) D ₇
Prohibit the entry of the amount tendered.	b No = 0 Yes = 2	
Force entry of the amount tendered.	c No = 0 Yes = 4	
Print VAT breakdown.	No = 0 Yes = 1	<input type="checkbox"/> D ₆
Always "0"		<input type="checkbox"/> 0 D ₅
High amount limit specification for subtotal and tendering amounts.	Maximum value (0 ~ 9)	<input type="checkbox"/> <input type="checkbox"/> D ₄ D ₃
	Number of zeros (0 ~ 9)	
Always "0"		<input type="checkbox"/> 0 D ₂
Specify credit in drawer total in the fixed totalizer.	Significant number (0 ~ 4)	<input type="checkbox"/> D ₁

<NEW BALANCE>

Description	Choice	Program code
Cancel the transaction if no item is registered.	No = 0 Yes = 4	<input type="checkbox"/> D ₁₀
Always "00"		<input type="checkbox"/> 0 <input type="checkbox"/> 0 D ₉ D ₈
Function after normal (not in check tracking) registration: Operation error = 0, Auto Cash = 1	Significant number	<input type="checkbox"/> D ₇
Print VAT breakdown.	No = 0 Yes = 1	<input type="checkbox"/> D ₆
Always "00000"		<input type="checkbox"/> 0 <input type="checkbox"/> 0 <input type="checkbox"/> 0 <input type="checkbox"/> 0 <input type="checkbox"/> 0 D ₅ D ₄ D ₃ D ₂ D ₁

<ARRANGEMENT>

Description	Choice	Program code
Treat numeric entry as arrange table number	No = 0 Yes = 1	<input type="checkbox"/> D ₇
Arrangement table link number	Significant numbers	<input type="checkbox"/> <input type="checkbox"/> <input type="checkbox"/> <input type="checkbox"/> <input type="checkbox"/> <input type="checkbox"/> D ₆ D ₅ D ₄ D ₃ D ₂ D ₁

<TEXT RECALL>

Description	Choice	Program code
Order character file record number	Significant numbers	<input type="checkbox"/> <input type="checkbox"/> D ₆ D ₅
Always "0000"		<input type="checkbox"/> 0 <input type="checkbox"/> 0 <input type="checkbox"/> 0 <input type="checkbox"/> 0 D ₄ D ₃ D ₂ D ₁

Clerk program

Clerk number, check number programming

Programming procedure

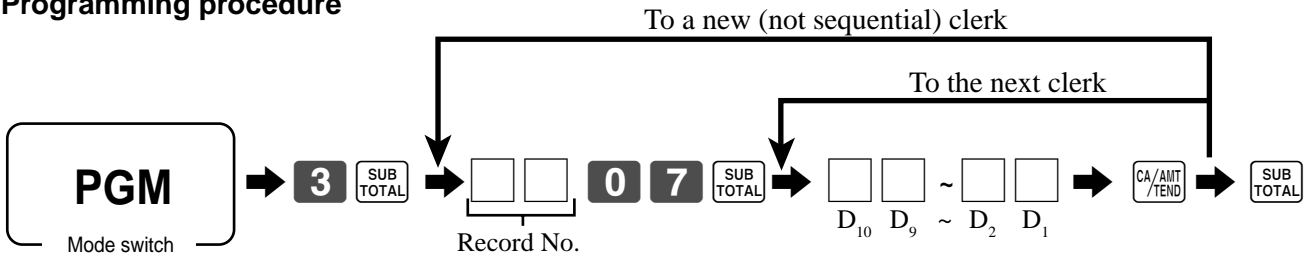

Program Data

Description	Choice	Program code
Check number for clerk interrupt	Significant numbers	<input type="text"/> <input type="text"/> <input type="text"/> <input type="text"/> <input type="text"/> <input type="text"/> D ₁₀ D ₉ D ₈ D ₇ D ₆ D ₅
Clerk secret number	Significant numbers	<input type="text"/> <input type="text"/> <input type="text"/> <input type="text"/> D ₄ D ₃ D ₂ D ₁

Clerk other programming

Programming procedure (individual)

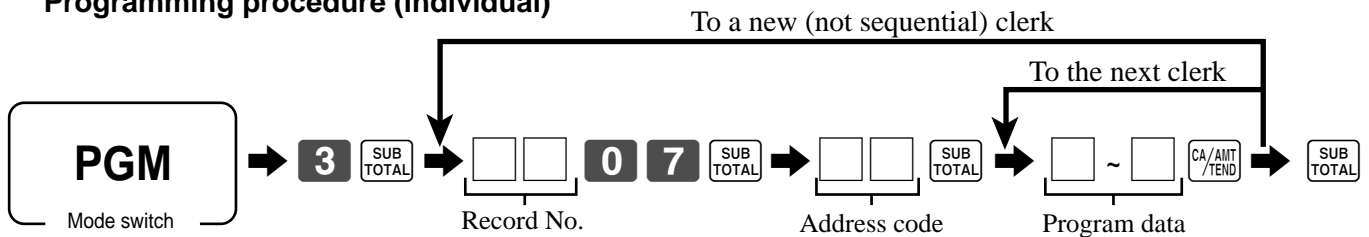

Program data

Address code 67 (Clerk control)

Description	Choice	Program code
Training clerk	No = 0 Yes = 1	<input type="text"/> D ₆
Always "00000"		<input type="text"/> ~ <input type="text"/> D ₅ ~ D ₁

Address code 68 (Commission rate)

Description	Choice	Program code
Commission rate 1 (integer: 00 ~ 99)	Significant numbers	<input type="text"/> <input type="text"/> D ₈ D ₇
Commission rate 1 (decimal: 00 ~ 99)	Significant numbers	<input type="text"/> <input type="text"/> D ₆ D ₅
Commission rate 2 (integer: 00 ~ 99)	Significant numbers	<input type="text"/> <input type="text"/> D ₄ D ₃
Commission rate 2 (decimal: 00 ~ 99)	Significant numbers	<input type="text"/> <input type="text"/> D ₂ D ₁

Advanced Operations and Setups

Set menu programming

Programming set menu includes two steps;

- ① Assigning PLUs and flat-PLUs to set menu tables. (These items are treated as “child” PLU.)
- ② Assigning set menu tables to “parent” PLU
(When a “parent” PLU is registered, all “child” PLUs in the designated set menu table are registered.)

Programming procedure

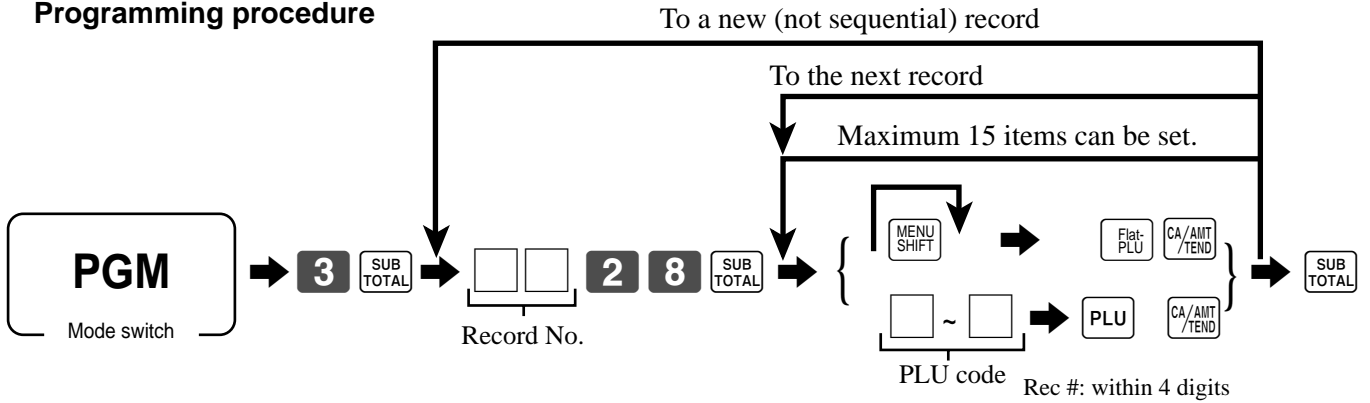

Arrangement programming

Programming procedure

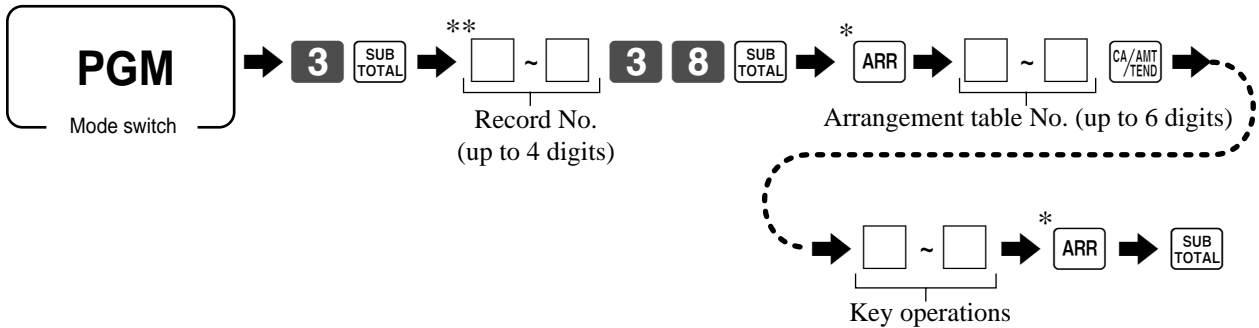

* The same **ARR** should be pressed.

** Vacant record search: If you want to set an arrangement program to a new record, “vacant record search” is possible. (enter **0 0 0 0** instead of entering a record No.)

Keyboard layout change

You can change the keyboard layout or allocate some new functions on the keyboard.

Note: Before changing the keyboard layout, you must issue the daily and periodic reset reports.

Configuration of the physical key layout

The shadowed keys are fixed function keys. You cannot change the function of these keys.

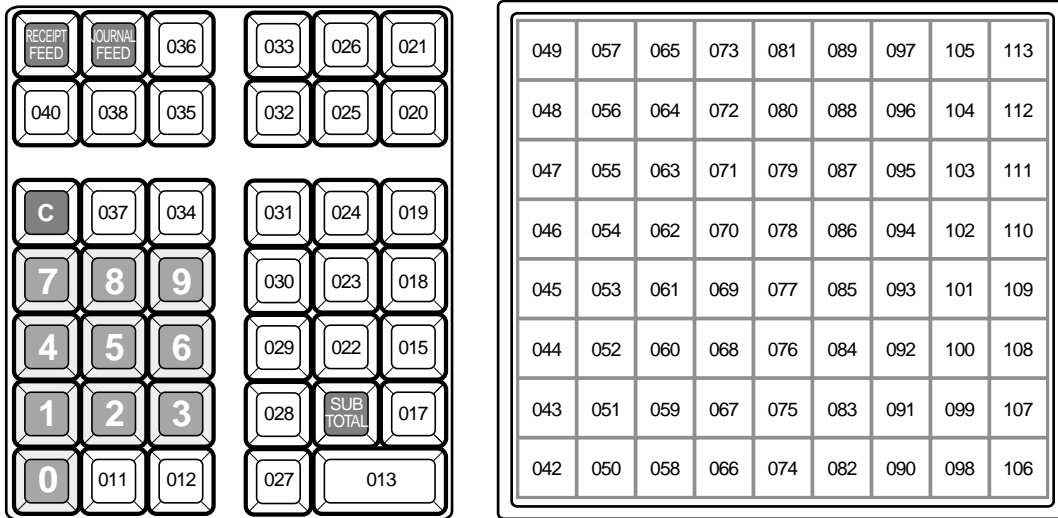

Note: The key in programming procedures mean the #-013 key on the keyboard.

Programming the function of each key

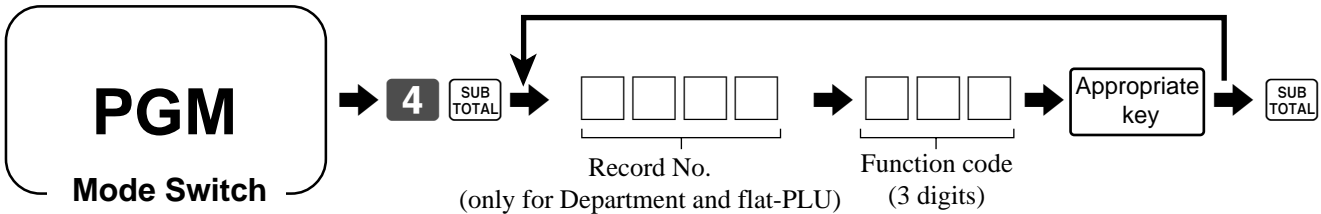

Content	Function code	Content	Function code	Content	Function code
Cash/amount tendered	001	Non-add	040	Multiplication	082
Charge	002	Non-add/no sale	041	Quantity/For	083
Check tendered	003	No sale	042	VAT	089
Credit	004	Customer number	043	New check	091
New balance	006	Arrangement	044	Old check	092
Text recall	010	Currency exchange	045	New/old check	093
Tip	015	VAT	046	Add check	094
Received on account	020	PLU	048	Age verification	106
Paid out	021	Price	049	Open check	117
Reduction (Minus)	027	Department	051	Help	141
Discount	028	Tax shift	057	Sign off	150
Addition (Plus)	029	Flat PLU	063	Tax Program	151
Premium	030	Menu shift	064	Dept no./Dept shift	152
Manual tax	032	Open	067	Cancel	236
Refund	033	Clerk number	072	"00" double zero *1	096
Error correct/cancel	034	Subtotal	075	"000" triple zero *1	097
Void	035	Receipt on/off	076	"." decimal point *1	098
Receipt	038	Merchandise subtotal	080		

*1 Two zero key, three zero key, decimal point key can only be allocated in #-011 and #-012 position.

Printing read/reset reports

- **Daily sales read report (“X” mode)**

You can print read reports at any time during the business day without affecting the data stored in the cash register's memory.

- **Daily sales reset report (“Z” mode)**

You should print reset reports at the end of the business day.

Important!

- The reset operation issues a report and also clears all sales data from the cash register's memory.
- Be sure to perform the reset operations at the end of each business day. Otherwise, you will not be able to distinguish between the sales data for different dates.

To print the individual department, PLU read report

This report shows sales for specific departments or PLUs.

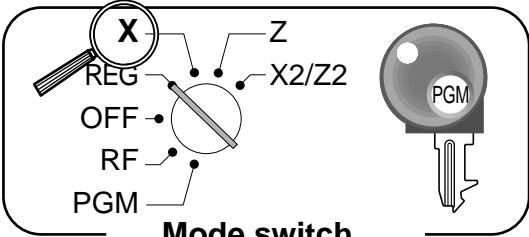
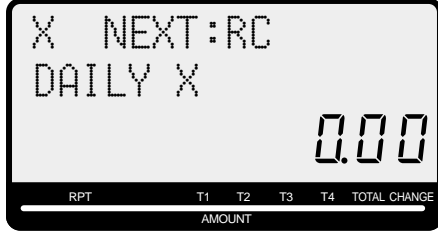
OPERATION	DISPLAY
<p>1. Turn to X mode.</p>  <p style="text-align: center;">Mode switch</p>	

2. Specify a department / PLU / flat PLU.

- Specifying a department
 , , ...
- Specifying a PLU
 , ...
- Specifying a flat-PLU
 , , ...

3. Press <ST> to exit this report.

REPORT		
X	INDIVIDUAL	Read symbol/report title
DEPT001	38	Department Name/No. of items
8.13%	\$257.53	Sales ratio/amount
PLU0001	17	PLU Name/No. of items
0.53%	\$17.00	Sales ratio/PLU amount
#0001		PLU code

TL	88.61	Total No. of items
	\$516.10	Total amount

To print daily read reports (except open check)

You can select the appropriate report shown in the display.

OPERATION

1. Turn to X mode.

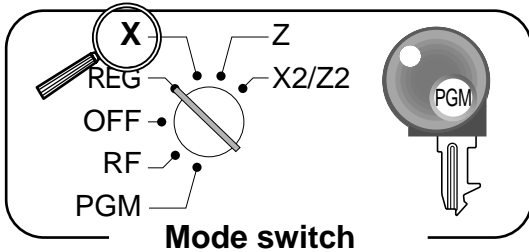

DISPLAY

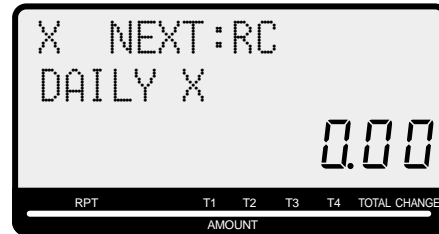

2. Select report you want to get by the <RC> key.



3. Press <CASH> to print report. *1

*1 If money declaration is necessary, count how much cash is in the drawer and input this amount (up to 10 digits) and press <#/NS> key.

The cash register will automatically compare the input with the cash in drawer in the memory and print the difference between these two amounts.

Note that if money declaration is required by programming, you cannot skip this procedure.

To print open check read report

OPERATION

1. Turn to X mode.
2. Select open check report by the <RC> key.
3. Press <CASH> key
- 4-a. Press <CASH> key to issue all open check.
- 4-b. Enter check no. and press <NEW> / <OLD> key to issue individual check report.
- 4-c. Enter clerk no. and press <CASH> key to issue check by clerk.

Advanced Operations and Setups

To print daily reset reports (except open check)

You can select the appropriate report shown in the display.

OPERATION

1. Turn to Z mode.

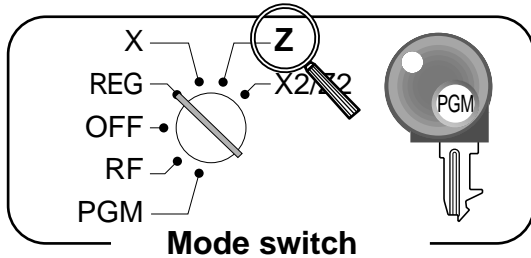

DISPLAY

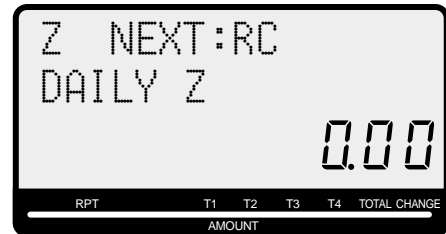

2. Select report you want to get by the <RC> key.



3. Press <CASH> to print report. *1

*1 If money declaration is necessary, count how much cash is in the drawer and input this amount (up to 10 digits) and press <#/NS> key.

The cash register will automatically compare the input with the cash in drawer in the memory and print the difference between these two amounts.

Note that if money declaration is required by programming, you cannot skip this procedure.

To print open check reset report

OPERATION

1. Turn to Z mode.
2. Select open check report by the <RC> key.
3. Press <CASH> key
- 4-a. Enter check no. and press <NEW> / <OLD> key to issue individual check report.
- 4-b. Enter clerk no. and press <CASH> key to issue check by clerk.

Read / reset report sample

Daily report

<pre> ----- Z DAILY ----- Z DEPT 0001 0001015 DEPT001 38 8.13% \$257.53 DEPT 183 \$1,362.26 ----- TL 88.61 \$1,916.10 ----- Z FIX 0001 0001011 DECLA \$6,919.04 \$0.00 GROSS 981.25 \$6,574.40 NET No 111 \$7,057.14 CAID \$6,919.04 CHID \$139.04 CKID \$859.85 CRID(1) \$709.85 CRID(2) \$0.00 CRID(3) \$0.00 CRID(4) \$0.00 ----- RF No 3 \$10.22 CUST CT 111 AVRG \$63.57 </pre>	<p>Report title</p> <p>Department report title/reset counter</p> <p>Report code</p> <p>Department name/No. of items *2</p> <p>Sales ratio/amount *2</p> <p>Total No. of items</p> <p>Total amount</p> <p>Fixed total report title/reset counter *4</p> <p>Report code</p> <p>Declared cash in drawer of main currency *1</p> <p>Difference (= declared - accumulated) *1</p> <p>Gross total *3</p> <p>Net total *3</p> <p>Cash in drawer *3</p> <p>Charge in drawer *3</p> <p>Check in drawer *3</p> <p>Credit in drawer 1 *3</p> <p>Credit in drawer 1 *3</p> <p>Credit in drawer 1 *3</p> <p>Credit in drawer 1 *3</p> <p>Refund mode *3</p> <p>Customer number *3</p> <p>Average sales per customer *3</p>
<pre> DC \$1.22 REF \$2.42 ROUND \$0.00 CANCEL No 2 \$12.97 ----- TA1 \$2,369.69 TX1 \$128.86 TA2 \$2,172.96 TX2 \$217.33 ----- GT \$00000000125478.96 ----- Z TRANS 0001 0001012 CASH No 362 \$1,638.04 CHARGE No 56 \$1,174.85 RC No 4 \$810.00 PD No 5 \$520.00 CORR No 14 \$5.00 C01 No 3 \$39.55 C02 No 5 ----- Z CASHIER 0001 0001017 C01 1 NET No 111 \$1,845.35 C02 1 </pre>	<p>Discount total *3</p> <p>Refund key *3</p> <p>Rounding total *3</p> <p>Cancellation *3</p> <p>Taxable 1 amount *3</p> <p>Tax 1 amount *3</p> <p>Taxable 2 amount *3</p> <p>Tax 2 amount *3</p> <p>Grand total *3</p> <p>Function key report title/reset counter</p> <p>Report code</p> <p>Function key count/amount *2</p> <p>Clerk report title/reset counter</p> <p>Report code</p> <p>Clerk name</p> <p>Net total</p> <p>Clerk name/drawer No.</p>

*1 Zero totalled departments/functions (the amount and item numbers are both zero) are not printed.

*2 These items can be skipped by programming.

Advanced Operations and Setups

Flash report

X	FLASH		0000071	Read symbol/report title
				Report code
DECLA		\$6,919.04		Main currency declared amount
		\$0.00		Difference
GROSS		111.15		Gross total
		\$7,054.14		
NET	No	120		Net total
		\$7,263.20		
CAID		\$6,919.04		Cash in drawer

PLU report

X	PLU		0000014	Read symbol/report title
				Report code
PLU0001		17		PLU name/No. of items
0.53%		\$17.00		Sales ratio/PLU amount
#0001				PLU code
PLU0100		42		
		\$69.00		

#0100				

TL		188.61		Total No. of items
		\$516.10		Total amount

Hourly report

X	HOURLY		0000019	Read symbol/report title
				Report code
00:00->01:00				Time range
	CT	1		No. of customers
GROSS		\$1.10		Gross sales amount
NET	No	1		No. of receipt
1.90%		\$1.20		Sales ratio/net sales amount

23:00->00:00				
	CT	1		
GROSS		\$3.45		
NET	No	1		
3.90%		\$3.59		

TL	CT	280		Total No. of customers
GROSS		\$1,937.61		Gross total amount
NET	No	25		Total No. of receipt
		\$2,096.80		Net total amount

Monthly report

X	MONTHLY		0000020	Read symbol/report title
				Report code
1.....				Date of a month
GROSS		1236.76		Gross symbol/No. of items
		\$12,202.57		Gross sales amount
NET	No	214		Net symbol/No. of customers
		\$12,202.57		Net sales amount

31.....				
GROSS		2132		
		\$14,187.57		
NET	No	205		
		\$13,398.76		

TL				Total symbol
GROSS		9746.63		Gross symbol/No. of items
		\$161,022.49		Gross sales amount
		\$16.52		Average daily gross sales
NET	No	2351		Net symbol/No. of customers
		\$161,022.49		Net sales amount
		\$68.49		Average daily net sales

Group report

X	GROUP		0000016	Read symbol/report title Report code
	GROUP01	203.25		Group No./No. of items
	33.87%	\$1,108.54		Sales ratio/group amount
	GROUP02	183		
	40.58%	\$1,327.80		
	GROUP03	12		
			\$13.25	
	GROUP99	12		
	0.54%	\$17.80		

	TL	862		Group total No. of items
		\$3,272.00		Group total amount

Open check report

Z	OPEN CHECK		0001025	Report header/title Report code
REG	03-04-2008	09:02		Mode symbol/date/time
C01	0001	000004		Clerk descriptor/Mc-No./consecutive No.
TABLE	No. 123456	CT 12		Table No./No. of customer
CHECK	No. 123			Check No.
			\$250.00	Subtotal amount

REG	03-04-2008	09:02		
C01	MC#01	000006		
TABLE	No. 111111	CT 14		
CHECK	No. 12345678			
BUSY			\$300.00	Print "BUSY", if the check is currently opened.

TL	No	28		No. of open check
			\$1,374.00	Open check total

Advanced Operations and Setups

• Periodic sales read report (“X2” mode)

You can print read reports at any time during the business day without affecting the data stored in the cash register's memory.

• Periodic sales reset report (“Z2” mode)

You should print reset reports at the end of the business day.

To print the periodic 1/2 sales read/reset reports

These reports show sales breakdowns of sales by any two kinds of period you want.

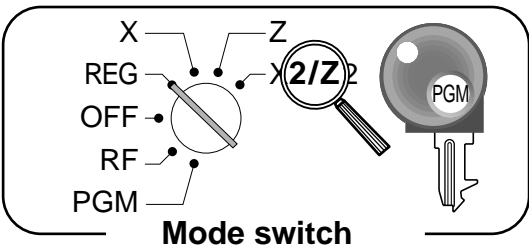
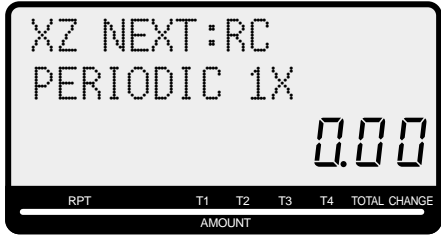
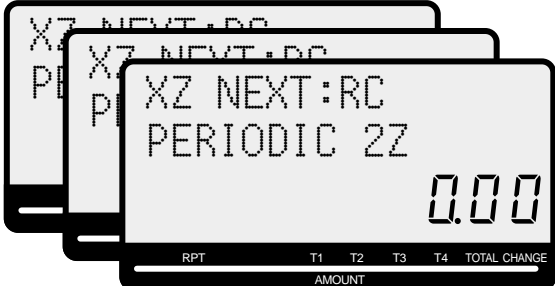
OPERATION	DISPLAY
<p>1. Turn to X2/Z2 mode.</p>  <p>Mode switch</p>	
<p>2. Select report you want to get by the <RC> key.</p>	
<p>3. Press <CASH> to print report.</p>	

ZZ1 PERIODIC 1Z		Report title

ZZ1 DEPT	0001	Department report title/reset counter
	0001115	Report code

DEPT001	38	Department Name/No. of items *1
8.13%	\$257.53	Sales ratio/amount *1
DEPT000	18	

	\$1,362.26	

TL	88.61	Total No. of items
	\$1,916.10	Total amount

ZZ1 FIX	0001	Fixed total report title/reset counter
	0001111	Report code

GROSS	981.25	Gross total *2
	\$6,574.40	
NET	No 111	Net total *2
	\$7,057.14	
CAID	\$6,919.04	Cash in drawer *2
CHID	\$139.04	Charge in drawer *2
CKID	\$859.85	Check in drawer *2
CRID(1)	\$709.85	Credit in drawer 1 *2
CRID(2)	\$0.00	Credit in drawer 2 *2
CRID(3)	\$0.00	Credit in drawer 3 *2
CRID(4)	\$0.00	Credit in drawer 4 *2

RF	No 3	Refund mode *2
	\$10.22	
CUST	CT 111	Customer number *2
AVRG	\$63.57	Average sales per customer *2
DC	\$1.22	Discount total *2
REF	\$2.42	Refund key *2
ROUND	\$0.00	Rounding total *2
CANCEL	No 2	Cancellation *2
	\$12.97	

TA1	\$2,369.69	Taxable 1 amount *2
TX1	\$128.86	Tax 1 amount *2
TA2	\$2,172.96	Taxable 2 amount *2
TX2	\$217.33	Tax 2 amount *2

ZZ1 TRANS	0001	Function key report title/reset counter
	0001112	Report code

CASH	No 362	Function key count/amount *1
	\$1,638.04	
CHARGE	No 56	
	\$1,174.85	
RC	No 4	
	\$810.00	
PD	No 5	
	\$5.00	
CORR	No 14	
	\$39.55	
BCT	No 3	
	5	

ZZ1 CASHIER	0001	Clerk report title/reset counter
	0001117	Report code

C01 1	Clerk name
NET	No 111	Net total
	\$1,845.35	

C02 1	Clerk name

*1 Zero totalled departments/functions (the amount and item numbers are both zero) are not printed.

*2 These items can be skipped by programming.

Reading the cash register's program

To print unit price/rate program (except PLU)

OPERATION	REPORT
<ol style="list-style-type: none"> 1. Turn to PGM mode. 2. Enter <1> and press <ST> key. 3. Press <ST> key. 	

To print key descriptor, name, message program (except PLU)

OPERATION	REPORT
<ol style="list-style-type: none"> 1. Turn to PGM mode. 2. Enter <2> and press <ST> key. 3. Press <ST> key. 	

To print the machine program (except PLU)

OPERATION	REPORT
1. Turn to PGM mode.	
2. Enter <3> and press <ST> key.	
3. Press <ST> key.	
<pre> P03..... Program read symbol CASH 0001-02 Transaction key program 0000000000000000 Key character/rec-#/file-# CHECK 0002-02 Key program 0000000000000000 PD 0003-02 0000000000000000 DEPT001 0001-05 Department program 0000000000000000 Key character/rec-#/file-# 11-66 00000000 Key program 15-66 @1.23 Address code 11 program 0002-05 Address code 15 program C01 0001-07 Clerk program 0001000001 Clerk name/rec-#/file-# 67 0000000000 Clerk #/secret-# 68 0000000000 Compulsory 00000000 Commission rate 0002-07 0001-09 00:00 -> 01:00 Time range program 0002-09 01:00 -> 02:00 03:00 -> 03:00 0001-22 2200000000 General control program 0002-22 0000000000 0003-22 0000000000 0001-28 0002-28 0001-25 Tax table TX1 10.25% TX1 0000 TX1 5003 DAILY X 0001-29 Batch X/Z program 00 11-12-17-15-00 00-00-00-00-00 PERIODIC 1X 0002-29 01 11-12-17-15-00 00-00-00-00-00 </pre>	<pre> 0001-30 Clerk detail link program NET 0001-01 0020-01 0001-38 Arrangement program REG1 000001 Rec-#/file-#/arrange no. 204-000 Key descriptor/rec-#/file-# 1 001-000 2 002-000 DEPT001 026-051 CASH 013-001 PD 0001-62 Scheduler program 000000 0000000000000000 000000000000 MC#01 0001-91 00000000 0001-98 I/O parameter table 0002-98 0000000000000000 0000000000000000 </pre>

Advanced Operations and Setups

To print the PLU unit price

OPERATION

1. Turn to PGM mode.
2. Enter <6> and press <ST> key.
3. Enter <104> and press <ST> key.
4. Enter <start rec-#> and <CA> key.
5. Enter <end rec-#> and <CA> key.

REPORT

P01.....		Program read symbol
	#0001 - #0010	PLU range
PLU0001	0001-04	PLU descriptor/rec-#/04
	@1.00	Unit price
PLU0002	0002-04	
	@2.00	

To print the PLU descriptor

OPERATION

1. Turn to PGM mode.
2. Enter <6> and press <ST> key.
3. Enter <204> and press <ST> key.
4. Enter <start rec-#> and <CA> key.
5. Enter <end rec-#> and <CA> key.

REPORT

P02.....		Program 2 mode symbol
	#0001 - #0010	PLU range
PLU0001	0001-04	PLU character
PLU0002	0002-04	
PLU0003	0003-04	

To print the PLU program

OPERATION

1. Turn to PGM mode.
2. Enter <6> and press <ST> key.
3. Enter <304> and press <ST> key.
4. Enter <start rec-#> and <CA> key.
5. Enter <end rec-#> and <CA> key.

REPORT

P03.....		Program 3 mode symbol
	#0001 - #0010	PLU range
PLU0001	0001-04	PLU descriptor/rec-#/file-#
	00000000000000	Address code 01 ~ 10, 18 program
11-66	000000	Address code 11 program
13-66	<- 0001-28	Address code 13 program
14-66	0	
15-66	@1234.56	Address code 15 program
PLU0002	0002-04	

To print the key allocation program

OPERATION

1. Turn to PGM mode.
2. Enter <4> and press <ST> key.
3. Press <ST> key.

REPORT

P04.....		Program read symbol
1-----		
00	0015-02	Function character/rec-#/file-#
	011-096	Hard key code/function code
.	0009-02	
	012-098	
CASH	0004-02	
	013-001	

Troubleshooting

This section describes what to do when you have problems with operation.

When an error occurs

Errors are indicated by an error codes. When this happens, you can usually find out what the problem is as illustrated below.

Press **C** and check the appropriate section of this manual for the operation you want to perform.

Error code	Message	Meaning	Action
E001	Wrong mode	Mode switch position changed before finalization.	Return the mode switch to its original setting and finalize the operation.
E003	Wrong operator	The signed on clerk differs from the clerk performed the tracking check registration.	Input correct check number or assign the proper clerk number.
E004	Error INIT/FC	Initialization or unit lock clear operation in progress.	Complete operation.
E008	Please sign on	Registration without entering a clerk number.	Enter a clerk number.
E010	Close the drawer	The drawer is left open longer than the program time (drawer open alarm).	Close the drawer.
E011	Close the drawer	Attempt to register while the cash drawer is open.	Shut the cash drawer.
E016	Change back to REG mode	Two consecutive transactions attempted in the refund mode.	Switch to another mode and then back to the RF mode for the next transaction.
E017	Enter CHK/TBL number	Attempt made to register an item without inputting a check number.	Input a check number.
E018	Enter Table number	Attempt made to register an item without inputting a table number.	Input a table number.
E019	Enter number of customers	Finalize operation attempted without entering the number of customer.	Enter the number of customer.
E021	No DEPT Link	No department linked PLU is registered.	Correct the program.
E026	Enter condiment/preparation PLU	No condiment/preparation PLU is registered.	Register condiment/preparation PLU.
E029	In the tender operation	Item registration is prohibited, while partial tender.	Finalize the transaction.
E031	Press ST key	Finalization of a transaction attempted without confirming the subtotal.	Press <SUBTOTAL>.
E033	Enter tendered amount	Finalize operation attempted without entering amount tender.	Enter the amount tendered.
E035	Change amount exceeds limit	Change amount exceeds preset limit.	Input amount tendered again.
E036	Remove money from the drawer	Contents of the drawer exceed programmed limit.	Perform payout operation.
E037	Digit or amount limitation over	High amount lock out/low digit lock out error	Enter correct amount.
E038	Perform money declaration	Read/reset operation without declaring cash in drawer. This error appears only when this function is activated.	Perform money declaration.
E040	Issue guest receipt	Attempt to register a new transaction without issuing a guest receipt.	Issue a guest receipt.
E046	REG buffer full	Registration buffer full.	Finalize the transaction.
E049	CHECK memory full	Check tracking index memory full.	Finalize and close the check number currently used.
E050	DETAIL memory full	Check tracking detail memory full.	Finalize and close the check number currently used.
E051	CHK/TBL No. is occupied	Attempt to made use <New Check> to open a new check using a number that is already used for an existing check in check tracking memory.	Finalize and close the check that is currently under the number that you want to use or use a different check number.
E053	CHK/TBL No. is not opened	Attempt made to use <Old Check> reopen a new check using a number that is not used for an existing check in check tracking memory.	Use the correct check number (if you want to reopen a check that already exists in check tracking memory) or use <New Check> to open a new check.
E075	Negative balance cannot be finalized	Attempt to finalize a transaction when balance is less than or equal to zero.	Register item(s) until the balance becomes positive amount.

Error code	Message	Meaning	Action
E101	PLU maintenance file full. Press <#2> to exit	Scanning PLU direct maintenance/batch maintenance file becomes full.	Terminate the maintenance.
E103	PLU Code is not exist. Input the PLU Code	PLU code is not existed in the file.	Enter proper PLU code.
E105	PLU file full	Scanning PLU file full	Modify the designated item.
E106	Item exists in the PLU FILE	The designated item has already existed in the scanning PLU file.	
E112	Close the journal platen arm	The journal platen arm is opened.	Close the journal platen arm.
E114	Close the receipt platen arm	The receipt platen arm is opened.	Close the receipt platen arm.
E139	Negative balance is not allowed	Attempt to register <-> or <CPN> when the balance becomes negative.	Enter proper minus/coupon amount.
E146	Arrangement file full	Arrangement file is full.	Set the arrangement properly.
E200	Insert RAC	RAC is set.	Set RAC.
E201	Illegal Format	Illegally formatted RAC	Format the RAC.
E202	File not found	The designated file is not found in the RAC.	Enter proper file name.
E205	File already exist.	Can not write, because designated file has already been in the RAC.	Check the operation and retry.

When the cash drawer does not open!

In case of power failure or the machine is in malfunction, the cash drawer does not open automatically. Even in these cases, you can open the cash drawer by pulling drawer release lever (see below).

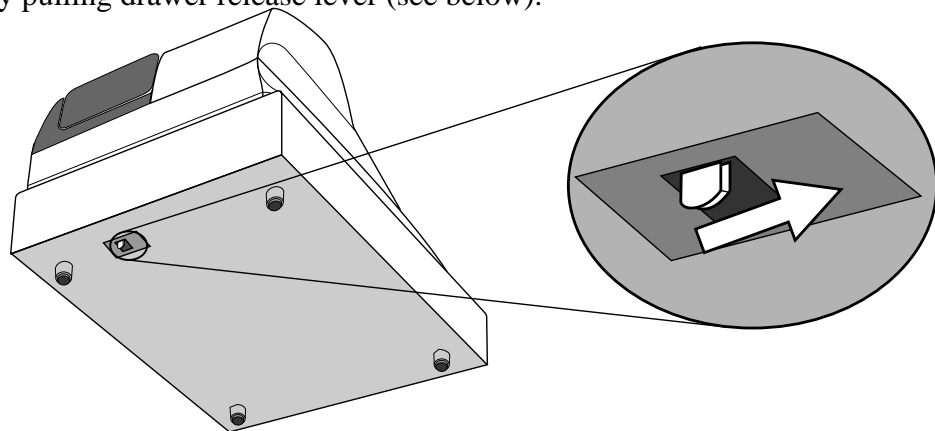

Important!

The drawer will not open, if it is locked with a drawer lock key.

When the register does not operate at all

Perform the following check whenever the cash register enter an error condition as soon as you switch it on. The results of this check are required by service personnel, so be sure to perform this check before you contact a CASIO representative for servicing.

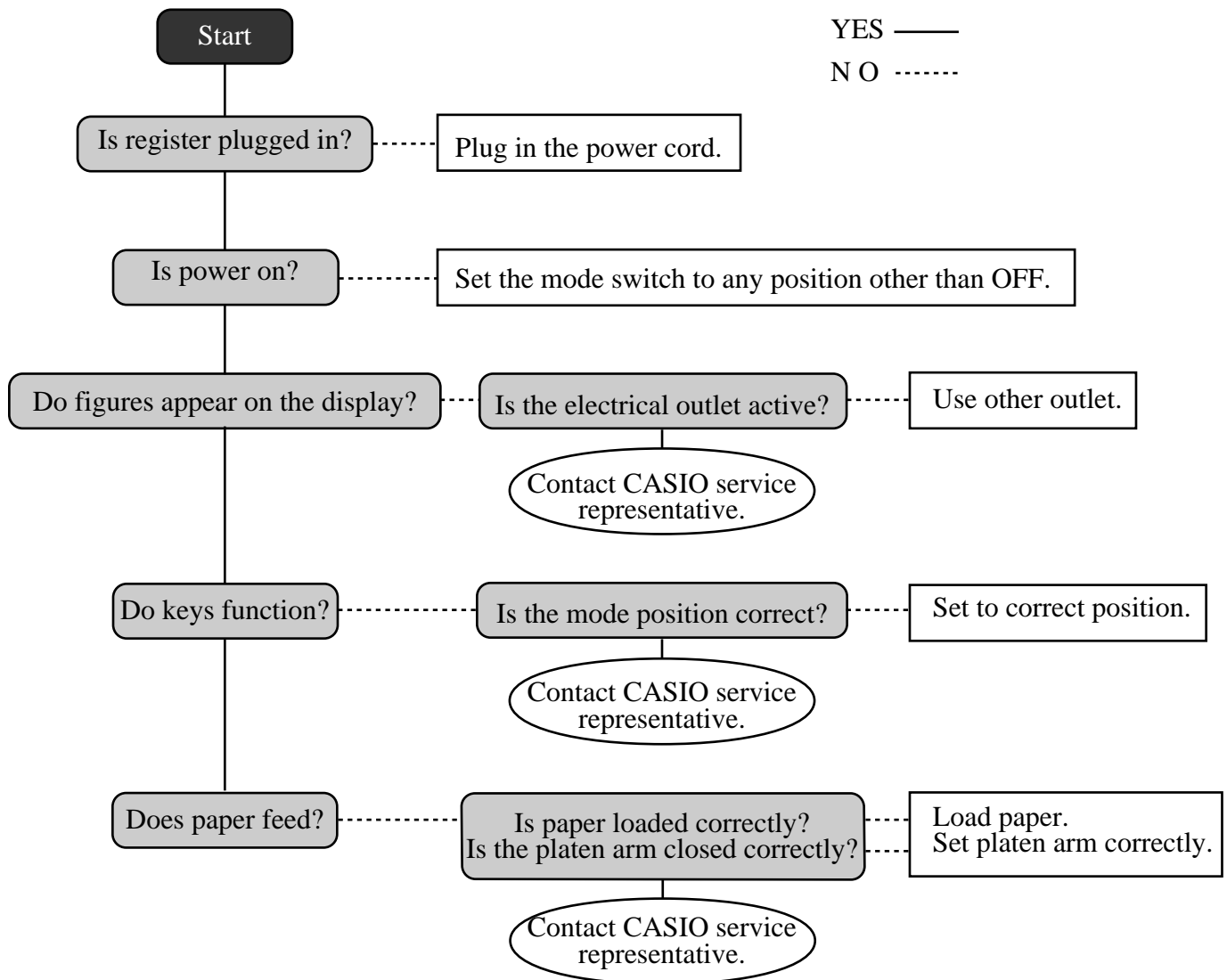

Clearing a machine lock up

If you make a mistake in operation, the cash register may lock up to avoid damage to programs and preset data. Should it happens, you can use the following procedure to clear the lock up without losing any data.

- 1 Power off the register.
- 2 Insert the PGM key in the mode switch.
- 3 Press down **RECEIPT FEED**, and turn the mode switch to PGM mode.
- 4 The display shows 0.00, then release **RECEIPT FEED**.
- 5 Press **SUB TOTAL**, then issue a receipt.

In case of power failure

If the power supply to the cash register is cut by a power failure or any other reason, simply wait for power to be restored. The details of any ongoing transaction as well as all sales data in memory are protected by the memory backup batteries. (This is the reason to install the batteries.)

- Power failure during a registration
The subtotal for items registered up to the power failure is retained in memory. You will be able to continue with the registration when power is restored.
- Power failure during printing a read / reset report
The data already printed before the power failure is retained in memory. You will be able to issue a report when power is restored.
- Power failure during printing of a receipt / journal
Printing will resume after power is restored. A line that was being printed when the power failure occurred is printed in full.
- Other
The power failure symbol is printed and any item that was being printed when the power failure occurred is reprinted in full.

Important!

Once receipt / journal printing or printing of a report starts, it can be stopped only by interruption of power to the cash register.

When the L sign appears on the display

About the low battery indicator...

The following shows the low battery indicator.

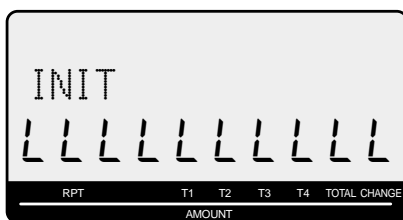

If this indicator appears when you switch the cash register on, it can mean one of three things:

- No memory backup batteries are loaded in the cash register.
- The power of the batteries loaded in the unit is below a certain level.
- The batteries loaded in the unit are dead.

Important!

Whenever the low battery indicator appears on the display, load a set of two new batteries as soon as possible. If there is a power failure or you unplug the cash register when this indicator appears, you will lose all of your sales data and settings.

**BE SURE TO KEEP THE POWER CORD OF THE CASH REGISTER
PLUGGED IN WHENEVER YOU REPLACE THE BATTERIES.**

To replace journal paper

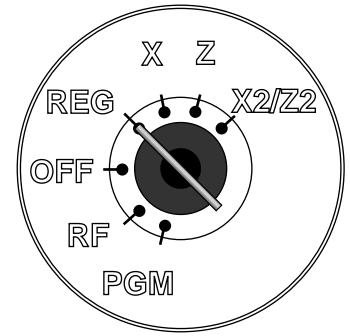

Step 1

Set the mode switch to the REG position and remove the printer cover.



Step 2

Press **JOURNAL FEED** to feed about 20 cm of paper.



Step 6

Slide the printed journal from the take-up reel.



Step 3

Cut the journal paper at the point where nothing is printed.



Step 7

Open the platen arm.



Step 4

Remove the journal take-up reel from its holder.



Step 8

Remove the old paper roll from the cash register.



Step 5

Remove the paper guide from the take-up reel.

Step 9

Load new paper.

Go to the step 3 described on page 12 of this manual.

To replace receipt paper



Step 1

Set the mode switch to the REG position and remove the printer cover.



Step 2

Open the platen arm.



Step 3

Remove the old paper roll from the cash register.

Step 4

Load new paper.

Go to the step 3 described on page 11 of this manual.

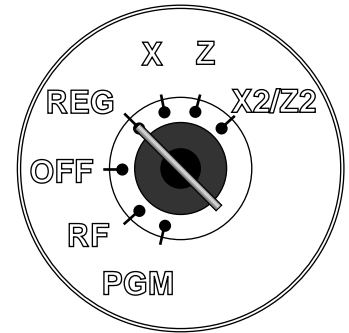

Options

P-5880T roll paper

WT-90, 91 wetproof cover

The optional wetproof cover protects the keyboard from moisture damage.

Consult your CASIO dealer for details.

Specifications

Input method

Entry: 10-key system, buffer memory 8 keys (2-key roll over)
 Department: Full key system

Display

Main: Amount 10 digits (zero suppression); No. of repeats, total, change, transaction indicator
 Descriptor 16 digits × 2 lines; item descriptor, No. of items, mode, clerk name
 Customer: Amount 8 digits (zero suppression)

Printer

Receipt: Thermal alpha-numeric system 24 digits, receipt on/off key
 Store name or slogan is printed automatically
 Journal: Thermal alpha-numeric system 24 digits
 Automatic take up roll winding
 Paper roll: 58 (W) × 80 (D) mm
 Paper thickness: 0.06 ~ 0.085 mm
 Paper feed: Separate for receipt and journal
 Print speed: About 14 l/s

Listing capacity

Amount: 99999999
 Quantity: 9999.999
 Tendered amount: 9999999999
 Percent: 99.99
 Tax rate: 9999.9999
 Numbers: 9999999999999999

Chronological data

Date print: Automatic date printout on receipt or journal, automatic calendar
 Time print: Automatic time printout on receipt or journal, 24-hour system/12-hour system

Alarm

Key catch tone, error alarm, sentinel alarm

Memory protection battery

The effective service life of memory protection batteries (two new size AA alkaline batteries) is approximately one year from installation into the machine.

Power supply/power consumption

See the rating plate.

Operation temperature

0°C ~ 40°C (32°F ~ 104°F)

Humidity

10 ~ 90%

Dimensions and weight

213mm (H) × 400mm (W) × 450mm (D) / 10kg ...with medium size drawer
 (8.4" (H) × 15.7" (W) × 17.7" (D) / 22lbs.)

Category	No. of Totalizers	Contents				Periodic Totalizer
		Amount (10 digits)	No. of items (4 digits)	Count (4 digits)	No. of customers (4 digits)	
Department	200	✓*1	✓*3			✓
PLU	2000	✓*1	✓*3			
Hourly sales	24	✓*1			✓*4	
Monthly	31	✓*1			✓*4	
Clerk	30	✓*1			✓*4	
Transaction key & fix total	--	✓*1	or ✓*4	or ✓*4	or ✓*4	✓
Non resettable grand sales total	1	✓*2				
Reset counter	8			✓*4		✓
Consecutive No.	1			✓*4		

*1: -9,999,999.99 ~ 99,999,999.99 *2: -999,999,999.99 ~ 9,999,999,999.99 *3: -999.99 ~ 9999.99 *4: 1 ~ 9999

* Specifications and design are subject to change without notice.

- A**
- add check 26, 56
 - addition 26, 61, 82
 - age limitation 78, 81
 - age verification 26, 53, 83
 - allocatable function 26
 - alphabet key 63, 64
 - arrangement 26, 60, 84, 86
- B**
- backlight 76
 - bottom message 28
- C**
- cancel 24, 26, 46
 - CAPS key 63
 - cash 24, 26, 81
 - cash in drawer 47
 - change 31
 - character enter key 63, 64
 - character keyboard 63
 - character manual input 63
 - charge 26, 40, 81
 - check 24, 26, 40, 81
 - check adding 54
 - check closing 55
 - check opening 54
 - check tracking 54, 75
 - clear 24
 - clear key 63, 64
 - clerk 48
 - clerk function 74
 - clerk interrupt 58, 74
 - clerk name 67
 - clerk number 24, 26, 48, 85
 - commercial message 28
 - commission 78, 81, 85
 - compressed print 76
 - condiment / preparation 59, 78
 - consecutive number 28, 70
 - correction 44, 45
 - coupon 26, 52, 82
 - credit 26, 40, 84
 - credit balance 71
 - currency exchange 26, 50, 73, 83
 - customer display 20, 22
 - customer number 26, 57
- D**
- daily sales X 20
 - daily sales X report 88
 - daily sales Z 20
 - daily sales Z report 47, 88
 - daily X report 89
 - daily Z report 17, 90
 - date 30
 - date set 13
 - delete key 63, 64
 - department 25, 26, 31, 66, 78, 79, 88
 - department number 26, 32
 - department report 47
 - department shift 26, 32
 - descriptor 62
 - descriptors by list 62
 - discount 24, 26, 38, 82
 - display 22
 - double size letter key 63, 64
 - double Z report 73
 - drawer 20
 - drawer key 20
 - drawer lock 20
- E**
- enter 26
 - error correct 24, 26
- F**
- feed 24
 - fixed total report 47
 - flash report 92
 - flat-PLU 26, 57, 66, 78, 79
 - function code 86
 - function key 66
 - function key report 47
- G**
- general control program 70
 - grand total 47, 69
 - gross total 47
 - group report 93
 - guest receipt 24, 27, 55
- H**
- hash 78, 81
 - help 24, 26
 - high amount limit 33, 80
 - high amount limitation 34
 - hourly report 92
- I**
- individual key report 88
 - item counter 28, 71
- J**
- journal 12, 28
 - journal skip 71
- K**
- key catch tone 71
 - key function program 78
 - keyboard 20
 - keyboard layout 87

L

link 80
logo message 28
low digit limitation 78, 81

M

machine feature program 70
machine number 28, 70
magnetic plate 20
main display 20, 22
manual tax 26
memory protection 10
menu sheet 21
menu shift 25, 26, 57
merchandise subtotal 25, 26, 41, 83
message 67
message control 75
mixed tender 40
mode switch 20, 21
monthly report 92
multi tapping 64
multiplication 24, 26, 32, 36
multiplication / for 24, 27, 32, 37, 83

N

negative price 78, 81
net total 47
new / old check 26, 54, 55
new balance 25, 26, 84
new check 25, 26, 54
no sale 26, 43
non-add 26, 82
non-add / no sale 25, 26, 82

O

OFF mode 20
old check 25, 26, 54
open 26
open check report 89, 93
open PLU 37, 78, 81
operator key 20

P

paid out 24, 26, 43, 82
paper install 11
periodic sale X/Z 20
periodic sales X report 94
periodic sales Z report 94
PGM mode 20
platen 11
PLU 24, 27, 35, 78, 79, 88
PLU report 92
pop-up display 20, 21
post receipt 24, 27
premium 27, 52, 82
preset graphic 28, 62, 76
preset message 28, 62, 76

preset price 34
preset tax status 34
price 24, 27
print control 71, 72, 73, 74
printer 20
printer cover 20
program backup 16
program end key 63, 64
program key 20
program mode 20
program report 96

R

rate 38
receipt 11, 28
receipt control 74
receipt on/off 24, 27
received on account 24, 27, 43, 82
reduction 24, 26, 39, 82
refund 24, 27, 42
refund mode 20
REG mode 20
register mode 20
repeat 23, 31, 36
report 88
report descriptor 68
report sample 91
report title 47, 69
RF mode 20, 42
right cursor key 64
roll paper 20

S

set menu 59, 80, 86
shift key 63
sign off 24, 27, 48
sign on 48
single item 31, 36, 49, 78, 81
space key 64
special character 69
stand-by 20
status indicator 23
subdepartment 24, 27
subtotal 24, 27, 31, 83
subtotal compulsory 71

T

take-up reel 12, 20
tax program 24, 27
tax shift 25, 27, 41, 83
tax status 33, 35, 38, 39
tax system 70
tax table 14
taxable status 81
text recall 27, 57, 69, 84
thermal paper 11
time 30
time set 13
tip 27, 60
training clerk 84

U

unit price 31, 33, 35

V

VAT 27
void 27, 61

W

watermark 16

X

X mode 20, 88
X2/Z2 mode 20, 94

Z

Z mode 20, 88
zero skip 73
zero unit price 78, 81

LIMITED WARRANTY: ELECTRONIC CASH REGISTERS

This product, except the battery, is warranted by Casio to the original purchaser to be free from defects in material and workmanship under normal use for a period, from the date of purchase, of one year for parts and 90 days for labor. For one year, upon proof of purchase, the product will be repaired or replaced (with the same or a similar model) at Casio's option, at a Casio Authorized Service Center without charge for parts. Labor will be provided without charge for 90 days. The terminal resident software and programmable software, if any, included with this product or any programmable software which may be licensed by Casio or one of its authorized dealers, is warranted by Casio to the original licensee for a period of ninety (90) days from the date of license to conform substantially to published specifications and documentation provided it is used with the Casio hardware and software for which it is designed.

For a period of ninety (90) days, upon proof of license, Casio will, at its option, replace defective terminal resident software or programmable software, correct significant program errors, or refund the license fee for such software. Significant program errors will be significant deviations from written documentation or specifications. These are your sole remedies for any breach of warranty. In no event will Casio's liability exceed the license fee, if any, for such software. This warranty will not apply if the product has been misused, abused, or altered.

Without limiting the foregoing, battery leakage, bending of the unit, a broken display tube, and any cracks or breaks in the display will be presumed to have resulted from misuse or abuse. To obtain warranty service you must take or ship the product, freight prepaid, with a copy of the sales receipt or other proof of purchase and the date of purchase, to a Casio Authorized Service Center. Due to the possibility of damage or loss, it is recommended when shipping the product to a Casio Authorized Service Center that you package the product securely and ship it insured. CASIO HEREBY EXPRESSLY DISCLAIMS ALL OTHER WARRANTIES, EXPRESS OR IMPLIED, INCLUDING ANY IMPLIED WARRANTY OF MERCHANTABILITY OR OF FITNESS FOR A PARTICULAR PURPOSE. NO RESPONSIBILITY IS ASSUMED FOR ANY INCIDENTAL OR CONSEQUENTIAL DAMAGES, INCLUDING WITHOUT LIMITATION DAMAGES RESULTING FROM MATHEMATICAL INACCURACY OF THE PRODUCT OR LOSS OF STORED DATA. SOME STATES DO NOT ALLOW THE EXCLUSION OR LIMITATION OF INCIDENTAL OR CONSEQUENTIAL DAMAGES, SO THE ABOVE LIMITATIONS OR EXCLUSIONS MAY NOT APPLY TO YOU. This warranty gives you specific rights, and you may also have other rights which vary from state to state.

CASIO, INC.
570 MOUNT PLEASANT AVENUE,
P. O. BOX 7000, DOVER, NEW JERSEY 07801 U.S.A.

Model:..... Serial Number:..... Date of Purchase:.....

Your Name:.....

Address:.....

Dealer's Name:.....

Address:.....

CASIO®

CASIO COMPUTER CO., LTD.
6-2, Hon-machi 1-chome
Shibuya-ku, Tokyo 151-8543, Japan

MO0712-A Printed in Indonesia

TK-1550*E