

TABLE OF CONTENTS

SECTION		PAGE
1	INTRODUCTION	3
2	THINGS TO KNOW BEFORE STARTING YOUR VEHICLE	9
3	UNDERSTANDING THE FEATURES OF YOUR VEHICLE	119
4	UNDERSTANDING YOUR INSTRUMENT PANEL	219
5	STARTING AND OPERATING	287
6	WHAT TO DO IN EMERGENCIES	357
7	MAINTAINING YOUR VEHICLE	375
8	MAINTENANCE SCHEDULES	433
9	IF YOU NEED CONSUMER ASSISTANCE	459
10	INDEX	469

INTRODUCTION

CONTENTS

■ Introduction	4	■ Vehicle Identification Number	6
■ How To Use This Manual	4	■ Vehicle Modifications/Alterations	7
■ Warnings And Cautions	6		

INTRODUCTION

This Owner's Manual has been prepared with the assistance of service and engineering specialists to acquaint you with the operation and maintenance of your vehicle. It is supplemented by a Warranty Information Booklet and various customer-oriented documents. You are urged to read these publications carefully. Following the instructions and recommendations in this manual will help assure safe and enjoyable operation of your vehicle.

NOTE: After you read the manual, it should be stored in the vehicle for convenient reference and remain with the vehicle when sold, so that the new owner will be aware of all safety warnings.



















































When it comes to service, remember that your authorized dealer knows your vehicle best, has the factory-trained technicians and genuine Mopar® parts, and is interested in your satisfaction.

HOW TO USE THIS MANUAL

Consult the table of contents to determine which section contains the information you desire.

The detailed index, at the rear of this manual, contains a complete listing of all subjects.

Consult the following table for a description of the symbols that may be used on your vehicle or throughout this owner's manual:

											
WATER IN FUEL	REAR WINDOW WIPER	WINDSHIELD WIPER INTERMITTENT	EXTERIOR BULB FAILURE	HIGH BEAM	TURN SIGNALS	UPPER AIR OUTLET	HEATED SEAT LOW	DOOR LOCK	ADJUSTABLE PEDALS	ELECTRONIC SPEED CONTROL	ELECTRONIC STABILITY PROGRAM / BRAKE ASSIST SYSTEM
											
FUEL	REAR WINDOW INTERMITTENT WIPER	WINDSHIELD WASHER	MASTER LIGHTING SWITCH	LOW BEAM	KEY ACTIVATE (POWER OUTLET)	UPPER AND LOWER AIR OUTLET	HEATED SEAT HIGH	WINDOW LIFT	TIRE PRESSURE MONITOR	HILL DESCENT CONTROL	BRAKE ASSIST SYSTEM
											
FUEL FILL SIDE	REAR WINDOW WASHER	WINDSHIELD WASHER FLUID LEVEL	DOME LIGHT	FRONT FOG LIGHT	HOOD RELEASE	LOWER AIR OUTLET	RECIRCULATION	CONVERTIBLE WINDOW DOWN	TRACTION CONTROL	AWD!	FAILURE OF ANTI-LOCK BRAKING SYSTEM
											
ENGINE OIL	REAR WINDOW DEFROST	WINDSHIELD, ELECTRICALLY HEATED	PARK LIGHTS	REAR FOG LAMP	LIFTGATE RELEASE AND LIFTGATE OPEN	DEFROST AND LOWER AIR OUTLET	VENTILATING FAN	WINDOW LOCK	ELECTRONIC THROTTLE CONTROL	4WD!	BRAKE ASSIST SYSTEM
											
BATTERY CHARGING	HEATED MIRROR	WINDSHIELD DEFROST	INSTRUMENT PANEL ILLUMINATION	SEAT BELT	SLIDING DOOR	TRUNK / DECK RELEASE	AIR CONDITIONING	CHILD SEAT TETHER ANCHOR	VOICE RECOGNITION BUTTON	WARNING	TOW / HAUL
											
GLOW PLUG	POWER STEERING FLUID	WINDSHIELD WIPER AND WASHER	SIDE AIRBAG	AIRBAG	SLIDING DOOR	EMERGENCY RELEASE HANDLE	LIGHTER	LOWER ANCHORS AND TETHER FOR CHILDREN (LATCH)	UCONNECT™ BUTTON	HAZARD	4 LOW
											
MALFUNCTION INDICATOR LIGHT	TRANS OIL TEMP	ENGINE COOLANT TEMPERATURE	SRS AIRBAG	PASSENGER AIRBAG OFF	DOOR AJAR	CONVERTIBLE TOP DOWN	CONVERTIBLE TOP UP	HORN	SEE OWNER'S MANUAL ISO		

WARNINGS AND CAUTIONS

This manual contains **WARNINGS** against operating procedures that could result in an accident or bodily injury. It also contains **CAUTIONS** against procedures that could result in damage to your vehicle. If you do not read this entire manual you may miss important information. Observe all Warnings and Cautions.

VEHICLE IDENTIFICATION NUMBER

The Vehicle Identification Number (VIN) is found on the driver's front corner of the instrument panel, visible through the windshield. This number also appears on the vehicle registration or title.

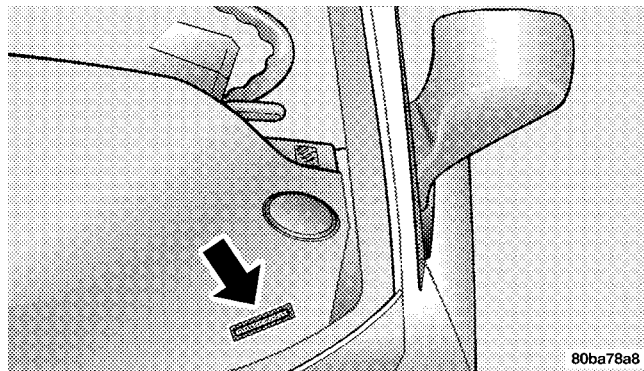

Vehicle Identification Number

VEHICLE MODIFICATIONS/ALTERATIONS**WARNING!**

Any modifications or alterations to this vehicle could seriously affect its roadworthiness and safety and may lead to an accident resulting in serious injury or death.

THINGS TO KNOW BEFORE STARTING YOUR VEHICLE

CONTENTS

■ A Word About Your Keys	13	□ If You Wish To Manually Lock The Steering Wheel	18
□ Ignition Key Removal	13	□ To Release The Steering Wheel Lock	18
□ Locking Doors With A Key	14	□ Automatic Transaxle Ignition Interlock System	19
□ Key-In-Ignition Reminder	15	■ Door Locks	19
■ Sentry Key® — If Equipped	15	□ Manual Door Locks	19
□ Replacement Keys	16	□ Power Door Locks — If Equipped	20
□ Sentry Key® Programming	17	□ Child Protection Door Lock System — If Equipped	22
□ General Information	18	■ Remote Keyless Entry (Sedan)	24
■ Steering Wheel Lock — If Equipped	18		

10 THINGS TO KNOW BEFORE STARTING YOUR VEHICLE

- To Unlock The Doors And Liftgate24
- To Lock The Doors And Liftgate — If Equipped With Power Options25
- Panic Alarm26
- To Turn Off “Flash Lights With Lock”26
- To Program Additional Transmitters27
- General Information28
- Transmitter Battery Service29
- Remote Keyless Entry (Convertible)30
 - To Unlock The Doors31
 - To Lock The Doors32
 - To Unlatch The Deck Lid32
 - Panic Alarm32
 - To Turn Off “Flash Lights With Lock”33
 - To Program Additional Transmitters33
 - General Information34
 - Transmitter Battery Service35
- Security Alarm System — If Equipped36
 - To Set The Alarm36
 - To Disarm The System37
 - Security System Manual Override37
- Liftgate (Sedan)37
 - Opening The Liftgate While The Security Alarm Is Activated38
- Deck Lid (Convertible)39
 - Power Deck Lid Release (Convertible)39

■ Emergency Seat Back Release (Sedan)40
■ Emergency Deck Lid Release Latch (Convertible)41
■ Power Windows42
□ Auto Down Feature43
□ Rear Window Switches43
□ Wind Buffeting44
■ Occupant Restraints (Sedan)44
□ Lap/Shoulder Belts45
□ Lap/Shoulder Seat Belt Untwisting Procedure52
□ Adjustable Upper Shoulder Seat Belt Anchorage52
□ Seat Belt Pretensioners53

THINGS TO KNOW BEFORE STARTING YOUR VEHICLE 11

□ Enhanced Seat Belt Reminder System (BeltAlert®)54
□ Seat Belts And Pregnant Women54
□ Driver And Front Passenger Supplemental Restraint System (SRS) Airbag55
□ Child Restraint72
■ Occupant Restraints (Convertible)81
□ Lap/Shoulder Belts82
□ Lap/Shoulder Seat Belt Untwisting Procedure88
□ Seat Belt Pretensioners88
□ Enhanced Seat Belt Reminder System (BeltAlert®)89
□ Seat Belts And Pregnant Women89

12 THINGS TO KNOW BEFORE STARTING YOUR VEHICLE

- Driver And Front Passenger Supplemental Restraint System (SRS)90
- Child Restraint107
- Engine Break-In Recommendations115
- Safety Tips115
- Exhaust Gas 115
- Safety Checks You Should Make Inside The Vehicle 116
- Periodic Safety Checks You Should Make Outside The Vehicle 117

A WORD ABOUT YOUR KEYS

The dealer that sold you your new vehicle has the key code numbers for your vehicle locks. These numbers can be used to order duplicate keys from your dealer. Ask your dealer for these numbers and keep them in a safe place.

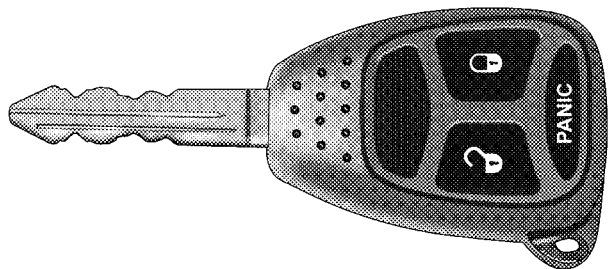

81182d3d

Vehicle Key

IGNITION KEY REMOVAL

Automatic Transaxle

Place the shift lever in PARK and make sure that the shift knob push button has returned to the out position. Turn the ignition switch to the ACC position, push the key and cylinder inward, rotate the key to the LOCK position, and remove the key.

2

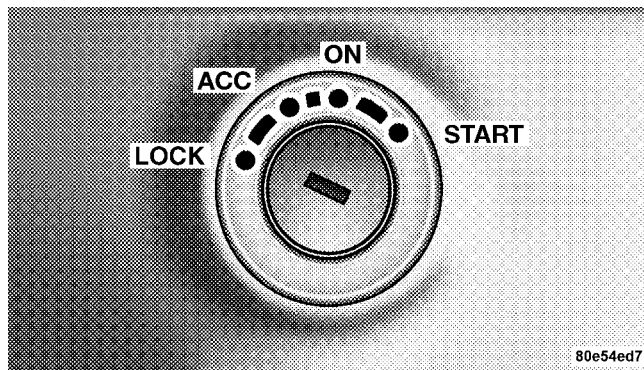

80e54ed7

Ignition Key Positions

NOTE: If you try to remove the key before you place the lever in PARK, the key may become trapped temporarily in the ignition cylinder. If this occurs, rotate the key to the right slightly, then remove the key as described. If a malfunction occurs, the system will trap the key in the ignition cylinder to warn you that this safety feature is inoperable. The engine can be started and stopped but the key cannot be removed until you obtain service.

WARNING!

Never leave children alone in a vehicle. Leaving children in a vehicle unattended is dangerous for a number of reasons. A child or others could be seriously or fatally injured. Don't leave the keys in the ignition. A child could operate power windows, other controls, or move the vehicle.

CAUTION!

An unlocked car is an invitation to thieves. Always remove key from the ignition and lock all doors when leaving the vehicle unattended.

Manual Transaxle—If Equipped

Turn the ignition switch to the ACC position, push the key and cylinder inward, rotate the key to the LOCK position, and remove the key.

LOCKING DOORS WITH A KEY

You can insert the key with either side up. To lock the door, turn the key rearward, to unlock the door, turn the key forward. See Section 7 of this manual for door lock lubrication.

KEY-IN-IGNITION REMINDER

Opening the driver's door when the key is in the ignition, sounds a signal to remind you to remove the key.

NOTE: With the driver's door open, and the key in the ignition, both the power door locks and Remote Keyless Entry (RKE) will not function.

SENTRY KEY® — IF EQUIPPED

The Sentry Key® Immobilizer System prevents unauthorized operation of the vehicle by disabling the engine. The system will shut the engine off after two seconds of running if an invalid key is used to start the vehicle. This system utilizes ignition keys, which have an electronic chip (transponder) embedded into them. Only keys that have been programmed to the vehicle can be used to start and operate the vehicle.

The Sentry Key® Immobilizer System does not need to be armed or activated. Operation of the system is automatic regardless of whether or not the vehicle is locked or

unlocked. During normal operation, the Theft Alarm/Immobilizer Light will come on for three seconds immediately after the ignition switch is turned on for a bulb check. Afterwards, if the bulb remains on, this indicates a problem with the electronics.

If the bulb begins to flash after the bulb check, this indicates that an invalid key has been used to start the vehicle. Both of these conditions will result in the engine being shut off after two seconds of running.

Keep in mind that a key, which has not been programmed is also considered an invalid key even if it is cut to fit the ignition lock cylinder for that vehicle.

If the Theft Alarm/Immobilizer Light comes on during normal vehicle operation, (the vehicle has been running for longer than 10 seconds), a fault has been detected in the electronics and the vehicle should be serviced as soon as possible.

NOTE:

- The Sentry Key® Immobilizer System is not compatible with remote starting systems. Use of these systems may result in vehicle starting problems and loss of security protection.
- Exxon/Mobil Speed Pass,™ additional Sentry Keys, or any other transponder equipped components on the same keychain will **not** cause a key-related (transponder) fault unless the additional part is **physically held against the ignition key** being used when starting the vehicle. Cell phones, pagers, or other RF electronics will not cause interference with this system.

All of the keys provided with your new vehicle have been programmed to the vehicle electronics.

Replacement Keys

NOTE: Only keys that have been programmed to the vehicle electronics can be used to start the vehicle. Once a Sentry Key® has been programmed to a vehicle, it cannot be programmed to any other vehicle.

CAUTION!

Always remove Sentry Keys from the vehicle and lock all doors when leaving the vehicle unattended.

At the time of purchase, the original owner is provided with a four digit Personal Identification Number (PIN). This PIN is required for replacement of keys by an authorized dealer. Duplication of keys must be performed at an authorized dealer. This procedure consists of programming a blank key to the vehicle electronics. A blank key is one which has never been programmed.

NOTE: When having the Sentry Key® Immobilizer System serviced, bring all vehicle keys with you to the dealer.

Sentry Key® Programming

If you have two valid sentry keys, you can program new sentry keys to the system by performing the following procedure:

1. Cut the additional Sentry Key® Transponder blank(s) to match the ignition switch lock cylinder key code.
2. Insert the first valid key into the ignition switch. Turn the ignition switch to the “ON” position for at least three seconds, but no longer than 15-seconds. Then, turn the ignition switch to the “LOCK” position and remove the first key.

3. Insert the second valid key into the ignition switch. Turn the ignition switch to the “ON” position within 15 seconds. After ten seconds, a chime will sound. In addition, the Vehicle Security Alarm Indicator Light will begin to flash. Turn the ignition switch to the “LOCK” position and remove the second key.

4. Insert a blank Sentry Key® into the ignition switch. Turn the ignition switch to the “ON” position within 60 seconds. After 10 seconds, a single chime will sound. In addition, the Vehicle Security Alarm Indicator Light will stop flashing. To indicate that programming is complete, the indicator light will turn on again for three seconds and then turn off.

The new Sentry Key® has been programmed. **The Keyless Entry Transmitter will also be programmed during this procedure.** Repeat this procedure to program up to a total of 8 keys. If you do not have a programmed Sentry Key®, contact your dealer for details.

NOTE: If a programmed key is lost, see your dealer to have all remaining keys erased from the systems memory. This will prevent the lost key from starting your vehicle. The remaining keys must then be reprogrammed. All vehicle keys must be taken to the dealer at the time of service to be reprogrammed.

General Information

The Sentry Key® system complies with FCC rules part 15 and with RSS-210 of Industry Canada. Operation is subject to the following conditions:

- This device may not cause harmful interference.
- This device must accept any interference that may be received, including interference that may cause undesired operation.

STEERING WHEEL LOCK — IF EQUIPPED

Your vehicle may be equipped with a passive steering wheel lock. This lock prevents steering the vehicle without the ignition key. If the steering wheel is moved no more than one—half turn in either direction and the key is not in the ignition switch, the steering wheel will lock.

If You Wish To Manually Lock The Steering Wheel:

With the engine running, turn the steering wheel upside down, turn off the engine and remove the key. Turn the steering wheel slightly in either direction until the lock engages.

To Release The Steering Wheel Lock:

Insert the key in the ignition switch and start the engine. If the key is difficult to turn, move the wheel slightly to the right or left to disengage the lock.

NOTE: If you turned the wheel to the right to engage the lock, you must turn the wheel slightly to the right to disengage it. If you turned the wheel to the left to engage the lock, turn the wheel slightly to the left to disengage it.

Automatic Transaxle Ignition Interlock System

This system prevents the key from being removed unless the shift lever is in PARK and the shift knob push-button is out. It also prevents shifting out of PARK unless the key is in the ACC, or ON positions, and the brake pedal is depressed.

DOOR LOCKS

MANUAL DOOR LOCKS

Use the manual door lock plunger to lock the doors from inside the vehicle. If the plunger is down when the door is closed, the door will lock. Therefore, make sure the keys are not inside the vehicle before closing the door.

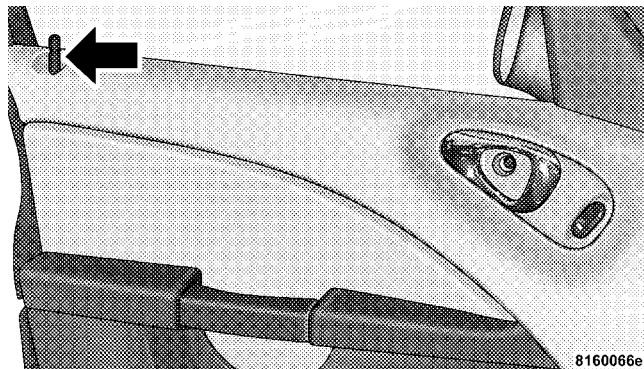

Door Lock Plunger

WARNING!

For personal security, and safety in the event of an accident, lock the vehicle doors as you drive as well as when you park and leave the vehicle.

WARNING!

When leaving the vehicle always remove the key from the ignition lock, and lock your vehicle. Do not leave children unattended in the vehicle, or with access to an unlocked vehicle. Unsupervised use of vehicle equipment may cause severe personal injuries and death.

CAUTION!

An unlocked vehicle is an invitation to thieves. Always remove the key from the ignition and lock all of the doors when leaving the vehicle unattended.

POWER DOOR LOCKS — IF EQUIPPED

A door lock switch is on each front door panel. Press this switch to lock or unlock the doors.

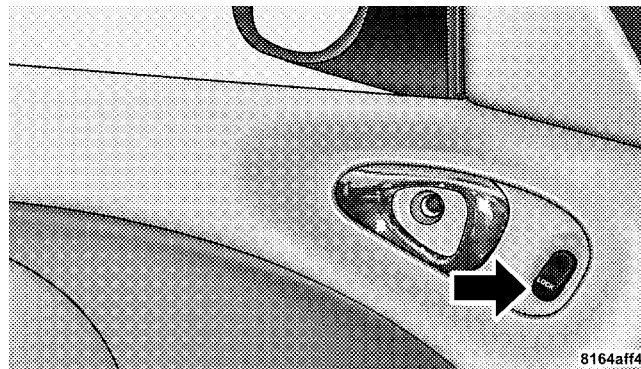

Power Door Lock Switch

AUTOMATIC DOOR LOCKS — IF EQUIPPED

The doors will lock automatically on vehicles with power door locks if all of the following conditions are met:

1. The Auto Lock feature is enabled.
2. The transmission is in gear.
3. All doors are closed.
4. The throttle is pressed.
5. The vehicle speed is above 15 mph (24 km/h).
6. The doors were not previously locked using the power door lock switch or remote keyless entry transmitter.

The Automatic Door Lock feature can be enabled or disabled. Refer to “Personal Settings” (Customer Programmable Features) in the Electronic Vehicle Information Center (EVIC) — if equipped section of this manual for details.

For vehicles not equipped with the EVIC the Automatic Door Locks can be enabled or disabled by performing the following procedure:

1. Close all doors and place the key in the ignition.
2. Cycle the ignition switch between LOCK and ON and back to LOCK four times ending up in the LOCK position.
3. Depress the power door lock switch to lock the doors.
4. A single chime will indicate the completion of the programming.

Auto Unlock

The doors will unlock automatically on vehicles with power door locks if:

1. The Auto Unlock feature is enabled.
2. The transmission was in gear and the vehicle speed returned to 0 mph (0 km/h).

22 THINGS TO KNOW BEFORE STARTING YOUR VEHICLE

3. The transmission is in NEUTRAL or PARK.
4. The driver door is opened.
5. The doors were not previously unlocked.
6. The vehicle speed is 0 mph (0 km/h).

The Auto Unlock feature can be enabled or disabled. Refer to “Personal Settings” (Customer Programmable Features) in the Electronic Vehicle Information Center (EVIC) — if equipped section of this manual.

For vehicles not equipped with the EVIC the Auto Unlock Feature can be enabled or disabled by performing the following procedure:

1. Close all doors and place the key in the ignition.
2. Cycle the ignition switch between LOCK and ON and back to LOCK four times ending up in the LOCK position.

3. Depress the power door unlock switch to unlock the doors.

4. Verify reprogramming by driving the vehicle.

NOTE: Use the Auto Door Locks and Auto Unlock features in accordance with local laws.

CHILD PROTECTION DOOR LOCK SYSTEM — IF EQUIPPED

To provide a safer environment for children riding in the rear seat, the rear doors have the “child-protection” door lock system.

To use the system, open each rear door and move the control UP to engage. When the system on a door is engaged, that door can only be opened by using the outside door handle even if the inside door lock is in the unlocked position.

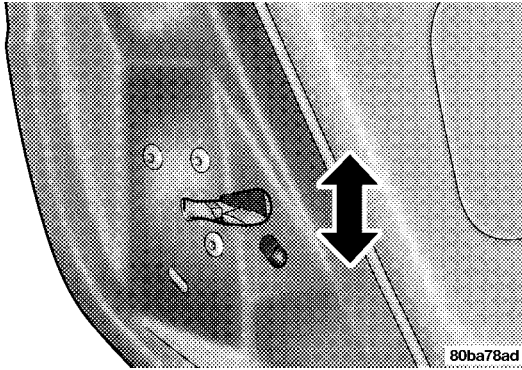

Child Lock Control

WARNING!

Avoid trapping anyone in a vehicle in a collision. Remember that the rear doors can only be opened from the outside when the child protection locks are engaged.

2

NOTE: For emergency exit with the system engaged, move the lock plunger up (unlocked position), roll down window and open the door with the outside door handle.

REMOTE KEYLESS ENTRY (SEDAN)

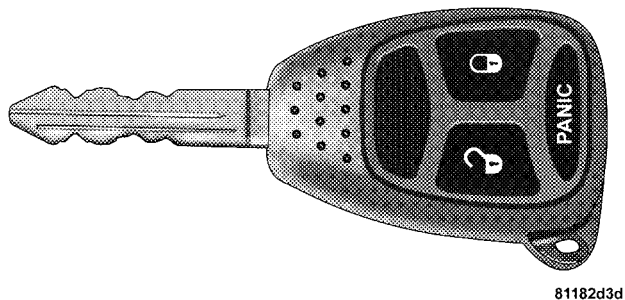

Three Button Key

This system allows you to lock or unlock the doors and liftgate or activate the panic alarm from distances a minimum of 66 feet (20 meters) using a hand held radio transmitter. The transmitter need not be pointed at the vehicle to activate the system.

NOTE: The line of transmission must not be blocked with metal objects.

TO UNLOCK THE DOORS AND LIFTGATE:

Press and release the UNLOCK button on the keyfob once to unlock only the driver's door or twice to unlock all the doors and liftgate. When the UNLOCK button is pressed, the illuminated entry will initiate, and the parking lights will flash on twice. The time for this feature is programmable on vehicles equipped with the Electronic Vehicle Information Center (EVIC). Refer to "Turn Headlamps on with Remote Key Unlock" under "Personal Settings" in the Electronic Vehicle Information Center (EVIC) section of this manual for details.

NOTE: The system can also be programmed to unlock all doors on the first press of the UNLOCK button. On electronic vehicle information center (EVIC) equipped vehicles refer to "Remote Unlock Driver's Door 1st"

under “Personal Settings” in the EVIC section of this manual. On non EVIC – equipped vehicles perform the following steps:

The system can be programmed to unlock all the doors upon the first UNLOCK button press by using the following procedure:

1. Press and hold the LOCK button on a programmed keyfob.
2. Continue to hold the LOCK button at least four seconds, but not longer than 10 seconds, then press and hold the UNLOCK button. A single chime will sound to indicate that this feature has changed.
3. Release both buttons at the same time.
4. Test the feature while outside of the vehicle, by pressing the LOCK/UNLOCK button on the keyfob.

NOTE: Pressing the LOCK button on the keyfob while you are inside the vehicle will activate the Security Alarm. Opening a door with the Security Alarm activated will cause the alarm to sound. Press the UNLOCK button to deactivate the Security Alarm.

5. If the desired programming was not achieved or to reactivate this feature, repeat the above steps.

TO LOCK THE DOORS AND LIFTGATE — IF EQUIPPED WITH POWER OPTIONS:

Press and release the LOCK button on the transmitter to lock all doors. The turn signal lights will flash and the horn will chirp once to acknowledge the lock signal. If desired, the “Sound Horn On Lock” and “Flash Lamps With Lock” feature can be turned on or off. On electronic vehicle information center (EVIC) equipped vehicles refer to “Personal Settings” in the “Electronic Vehicle

Information Center (EVIC)” section of this manual. On non EVIC – equipped vehicles perform the following steps:

1. Press the LOCK button for four to ten seconds.
2. While the LOCK button is pressed (after four seconds), press the PANIC button. Release both buttons.

The “Sound Horn On Lock” and “Flash Lamps With Lock” feature can be reactivated by repeating this procedure.

PANIC ALARM

The panic mode flashes the park lights, and sounds the horn for about three minutes or until the alarm is turned off.

Using The Panic Alarm:

To turn the panic alarm feature ON or OFF, press and hold the PANIC button on the transmitter for at least one second and release. When the panic alarm is on, the

headlights and park lights will flash, the horn will pulse on and off and the interior lights will turn on.

The panic alarm will stay on for three minutes unless you turn it off by pressing the PANIC button a second time or if the vehicle speed is 5 mph (8 km/h) or greater.

NOTE: When you turn off the panic alarm by pressing the PANIC button a second time, you may have to be closer to the vehicle due to the radio frequency noises of the system.

TO TURN OFF “FLASH LIGHTS WITH LOCK”:

NOTE: The Flash Lights With Lock feature can be turned on or off. On Electronic Vehicle Information Center (EVIC) equipped vehicles refer to “Personal Settings” in the EVIC section of this manual. On non EVIC - equipped vehicles perform the following steps:

1. Press the UNLOCK button for four to ten seconds.

2. While the UNLOCK button is pressed, (after four seconds) press the LOCK button. Release both buttons.
3. Test the flash lamps with LOCK feature while outside of the vehicle, by pressing the LOCK button on the keyfob with the ignition in the LOCK position, and the key removed.

NOTE: Pressing the LOCK button on the keyfob, while you are in the vehicle, will activate the Security Alarm. Opening a door with the Security Alarm activated will cause the alarm to sound. Press the UNLOCK button to deactivate the Security Alarm.

The “Flash Lights On Lock/Unlock” feature can be reactivated by repeating this procedure.

TO PROGRAM ADDITIONAL TRANSMITTERS:

Vehicles will be shipped from the assembly plants with two keyfob transmitters programmed only for that vehicle. A total of eight fobs can be programmed for your vehicle. Additional fobs can be programmed to your vehicle through the use of a currently programmed fob.

NOTE: When entering program mode using that fob, all other programmed fobs will be erased and you will have to reprogram them for your vehicle.

Use the Following procedure to program additional key fobs if the vehicle is not equipped with Sentry Key®:

1. Enter your vehicle and close all doors.
2. Fasten your seat belt (Fastening the seatbelt will cancel any chiming that may confuse you during this programming procedure).
3. Place the key into the ignition.

28 THINGS TO KNOW BEFORE STARTING YOUR VEHICLE

4. Turn the ignition to the ON position **Do not start the engine.**
5. Press and hold the UNLOCK button on the keyfob.
6. After holding the UNLOCK button for four seconds, also press the PANIC button within six seconds.
7. When a single chime is heard release both buttons. The chime is an indication that you have successfully entered program mode. All fobs that are to be programmed must be done so within 60 seconds of when the chime was heard.
8. Using the fob to be programmed, press and release both the LOCK and UNLOCK buttons, simultaneously.
9. A single chime will be heard.
10. Within four seconds of hearing the chime, press and release the UNLOCK button on the fob.
11. A single chime will be heard.

12. Repeat steps eight through ten to program up to six additional fobs.

13. Turn the ignition to the OFF position.

14. Your vehicle will remain in program mode up to 60 seconds from when the original chime was heard. After 60 seconds, all programmed fobs function normally.

NOTE: If you do not have a programmed transmitter, contact your dealer for details.

GENERAL INFORMATION

This device complies with part 15 of FCC rules and with RS-210 of Industry Canada. Operation is subject to the following conditions:

1. This device may not cause harmful interference.
2. This device must accept any interference that may be received including interference that may cause undesired operation.

NOTE: Changes or modifications not expressly approved by the party responsible for compliance could void the user's authority to operate the equipment.

If your Remote Lock Control fails to operate from a normal distance, check for these two conditions.

1. Weak batteries in transmitter. The expected life of batteries is five years.
2. Closeness to a radio transmitter such as a radio station tower, airport transmitter, military base, and some mobile or CB radios.

TRANSMITTER BATTERY SERVICE

NOTE: Perchlorate Material – special handling may apply, See www.dtsc.ca.gov/hazardouswaste/perchlorate.

The recommended replacement battery is CR2032.

1. If the keyfob is equipped with a screw, remove the screw. With the transmitter buttons facing down, use a flat blade to pry the two halves of the transmitter apart. Make sure not to damage the elastomer seal during removal.

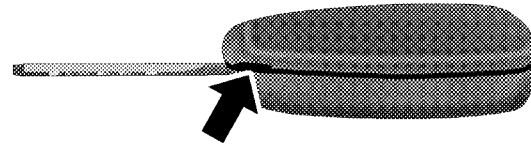

Separating RKE Transmitter Halves

30 THINGS TO KNOW BEFORE STARTING YOUR VEHICLE

2. Remove and replace the batteries. Avoid touching the new batteries with your fingers. Skin oils may cause battery deterioration. If you touch a battery, clean it with rubbing alcohol.

3. To assemble the transmitter case, snap the two halves together.

NOTE: If the keyfob is equipped with a screw, reinstall and tighten the screw until snug.

REMOTE KEYLESS ENTRY (CONVERTIBLE)

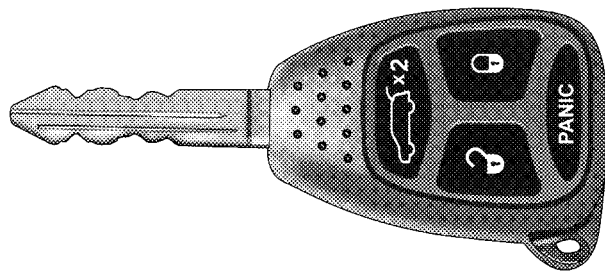

8159413b

Four-Button Transmitter

This system allows you to lock or unlock the doors or open the deck lid from distances of 23–50 feet (7–15 meters) using a transmitter. You don't have to point the transmitter at the vehicle to activate the system. Each vehicle comes with two transmitters.

TO UNLOCK THE DOORS:

Press and release the UNLOCK button on the keyfob once to unlock only the driver's door or twice to unlock all the doors and liftgate. When the UNLOCK button is pressed, the illuminated entry will initiate, and the parking lights will flash on twice. The time for this feature is programmable on vehicles equipped with the Electronic Vehicle Information Center (EVIC). Refer to "Turn Headlamps on with Remote Key Unlock" under "Personal Settings" in the Electronic Vehicle Information Center (EVIC) section of this manual for details.

NOTE: The system can also be programmed to unlock all doors on the first press of the UNLOCK button. On electronic vehicle information center (EVIC) equipped vehicles refer to "Remote Unlock Driver's Door 1st" under "Personal Settings" in the EVIC section of this manual. On non EVIC - equipped vehicles perform the following steps:

The system can be programmed to unlock all the doors upon the first UNLOCK button press by using the following procedure:

1. Press and hold the LOCK button on a programmed keyfob.
2. Continue to hold the LOCK button at least four seconds, but not longer than ten seconds, then press and hold the UNLOCK button. A single chime will sound to indicate that this feature has changed.
3. Release both buttons at the same time.
4. Test the feature while outside of the vehicle, by pressing the LOCK/UNLOCK button on the keyfob.

NOTE: Pressing the LOCK button on the keyfob while you are inside the vehicle will activate the Security Alarm. Opening a door with the Security Alarm activated will cause the alarm to sound. Press the UNLOCK button to deactivate the Security Alarm.

5. If the desired programming was not achieved or to reactivate this feature, repeat the above steps.

TO LOCK THE DOORS:

Press and release the LOCK button on the transmitter to lock all doors. The turn signal lights will flash and the horn will chirp once to acknowledge the lock signal. If desired, the “Sound Horn On Lock” and “Flash Lamps With Lock” feature can be turned on or off. On electronic vehicle information center (EVIC) equipped vehicles refer to “Personal Settings” in the “Electronic Vehicle Information Center (EVIC)” section of this manual. On non EVIC – equipped vehicles perform the following steps:

1. Press the LOCK button for four to ten seconds.
2. While the LOCK button is pressed (after four seconds), press the PANIC button. Release both buttons.

The “Sound Horn On Lock” and “Flash Lamps With Lock” feature can be reactivated by repeating this procedure.

TO UNLATCH THE DECK LID:

Press the “Rear Release” button twice to unlatch the deck lid.

PANIC ALARM

The panic mode flashes the park lights, and sounds the horn for about three minutes or until the alarm is turned off.

Using The Panic Alarm:

To turn the panic alarm feature ON or OFF, press and hold the PANIC button on the transmitter for at least one second and release. When the panic alarm is on, the headlights and park lights will flash, the horn will pulse on and off and the interior lights will turn on.

The panic alarm will stay on for three minutes unless you turn it off by pressing the PANIC button a second time or if the vehicle speed is 5 mph (8 km/h) or greater.

NOTE: When you turn off the panic alarm by pressing the PANIC button a second time, you may have to be closer to the vehicle due to the radio frequency noises of the system.

TO TURN OFF “FLASH LIGHTS WITH LOCK”:

NOTE: The Flash Lights With Lock feature can be turned on or off. On electronic vehicle information center (EVIC) equipped vehicles refer to “Personal Settings” in the EVIC section of this manual. On non EVIC - equipped vehicles perform the following steps:

1. Press the UNLOCK button for four to ten seconds.
2. While the UNLOCK button is pressed, (after four seconds) press the LOCK button. Release both buttons.

3. Test the flash lamps with LOCK feature while outside of the vehicle, by pressing the LOCK button on the keyfob with the ignition in the LOCK position, and the key removed.

NOTE: Pressing the LOCK button on the keyfob, while you are in the vehicle, will activate the Security Alarm. Opening a door with the Security Alarm activated will cause the alarm to sound. Press the UNLOCK button to deactivate the Security Alarm.

The “Flash Lights On Lock/Unlock” feature can be reactivated by repeating this procedure.

TO PROGRAM ADDITIONAL TRANSMITTERS:

NOTE: If vehicle is equipped with the optional Electronic Vehicle Information Center (EVIC) in the instrument cluster, the transmitters may also be programmed through the EVIC display.

Up to eight transmitters can be programmed to your vehicle. To obtain additional transmitters, contact your authorized dealer. To program a transmitter (within 23–50 ft/7–15 m of the vehicle), perform the following procedure:

1. Gather every transmitter that is to be used with the vehicle including any transmitters that are currently programmed.
2. **Enter Program Mode:** Turn the ignition to the ON position, and using a currently programmed transmitter; press and hold the "Unlock" button on the transmitter. Continue to hold the "Unlock" button, wait at least four but no longer than 10 seconds, then press and hold the PANIC button for at least one second. Release both buttons simultaneously.
3. **Program Each Transmitter:** All transmitters to be used with your vehicle must be programmed as follows:

Press and release the "Lock" and "Unlock" buttons simultaneously, followed by a press and release of ANY button on

each transmitter to be programmed. You will hear a chime when a transmitter has been successfully programmed.

GENERAL INFORMATION

This transmitter complies with FCC rules part 15 and with RSS-210 of Industry Canada. Operation is subject to the following two conditions:

1. This device may not cause harmful interference.
2. This device must accept any interference that may be received, including interference that may cause undesired operation.

If your Remote Keyless Entry® fails to operate from a normal distance, check for these two conditions:

1. Weak batteries in transmitter. The expected life of batteries is from one to two years
2. Closeness to a radio transmitter such as a radio station tower, airport transmitter, and some mobile or CB radios.

TRANSMITTER BATTERY SERVICE

NOTE: Perchlorate Material – special handling may apply, See www.dtsc.ca.gov/hazardouswaste/perchlorate.”

The recommended replacement battery is the Panasonic® CR2032 or equivalent.

1. Pry the transmitter halves apart with a dime or similar object. Make sure not to damage the rubber gasket material during removal.

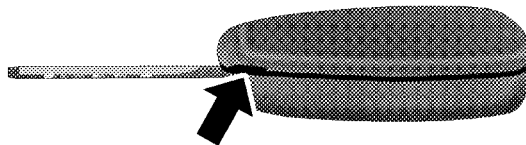

2

81182c72

Separating Transmitter Halves

2. Remove and replace the batteries. Avoid touching the new batteries with your fingers. Skin oils may cause battery deterioration. If you touch the battery, clean it with rubbing alcohol.
3. Reassemble the transmitter case. Snap the halves together and test transmitter operation.

NOTE: If the keyfob is equipped with a screw, reinstall and tighten the screw until snug.

SECURITY ALARM SYSTEM — IF EQUIPPED

The system monitors the doors, liftgate, and ignition switch for unauthorized operation.

If something triggers the alarm, the system will signal for about 18 minutes. For the first three minutes the horn will sound and the headlights, park lights, tail lights and the indicator light in the cluster will flash. Then the exterior lights will flash for another 15 minutes.

If the monitored system, which triggered the alarm is deactivated the alarm will continue to sound until three minutes of alarm time is reached. If the monitored system, which triggered the alarm is deactivated after the alarm has been on for three minutes the alarm will shut off immediately.

To set the alarm:

1. Remove the keys from the ignition switch and get out of the vehicle.
2. Lock the door using either the power door lock switch, or the Keyless Entry Transmitter and close all doors.
3. The indicator light in the instrument cluster will flash rapidly for 16 seconds. This shows that the system is arming. During this period, if a door is opened, the ignition switch is turned ON, or the power door locks are unlocked by either the power door lock switch or the remote keyless entry transmitter, the system will automatically disarm. After 16 seconds the indicator light will flash slowly. This shows that the system is fully armed.

To disarm the system:

Unlock a front door using the Keyless Entry Transmitter.

Starting the vehicle with a valid Sentry key will disarm the system. A valid key is one that is programmed to that particular vehicle. A valid key will disarm the system, an invalid key will trigger the alarm.

Tamper Alert

If the horn sounds three times when you unlock a front door using the Keyless Entry Transmitter, the alarm has been activated. Check the vehicle for tampering.

Security System Manual Override

The system will not arm if you lock the doors using the manual door lock plunger.

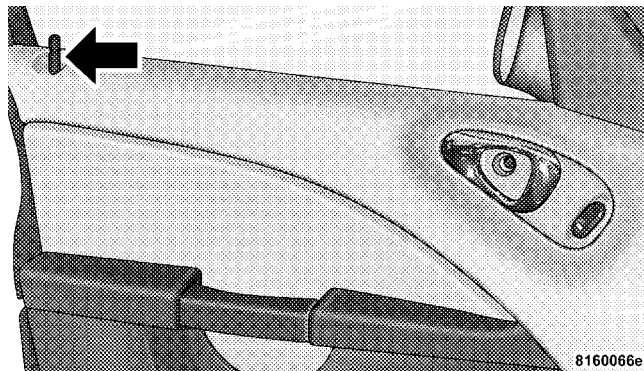

Door Lock Plunger

LIFTGATE (SEDAN)

The liftgate can be unlocked by pressing twice on the remote keyless entry button or by activating the power door lock switches located on the front doors.

To open the unlocked liftgate, squeeze the liftgate release touch pad located on the backside of the liftgate handle and pull the liftgate open with one fluid motion.

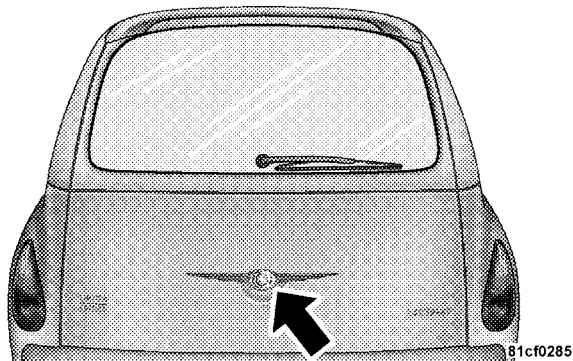

Liftgate Handle

Opening The Liftgate While the Security Alarm Is Activated

Unlocking the liftgate with the remote keyless entry transmitter will allow access to the liftgate without sounding or disarming the security alarm system. Once the liftgate is closed, it will again be monitored by the security alarm system.

WARNING!

- Driving with the liftgate open can allow poisonous exhaust gases into your vehicle. You and your passengers could be injured by these fumes. Keep the liftgate closed when you are operating the vehicle.
- If you are required to drive with the liftgate open, make sure that all windows are closed, and the climate control blower switch is set at high speed. DO NOT use the recirculation mode.

Gas props support the liftgate in the open position. However, because the gas pressure drops with temperature, it may be necessary to assist the props when opening the liftgate in cold weather.

DECK LID (CONVERTIBLE)

Gas props support the deck lid in the open position. However, because the gas pressure drops with temperature, it may be necessary to assist the props when opening the deck lid in cold weather.

POWER DECK LID RELEASE (Convertible)

You can open the deck lid by pressing the Remote Keyless Entry Button or from inside the vehicle, using the switch located inside the glove box. On vehicles equipped with a manual transmission, the power deck lid release switch is disabled if the doors are locked, or if vehicle speed exceeds 0 mph (0 km/h), or when the clutch pedal is depressed. On vehicles equipped with an

automatic transmission, the power deck lid release switch is disabled if the doors are locked, or the transmission is out of PARK.

WARNING!

- **Driving with the deck lid open can allow poisonous exhaust gases into your vehicle. You and your passengers could be injured by these fumes. Keep the deck lid closed when you are operating the vehicle.**
- **If you are required to drive with the deck lid open, make sure that all windows are closed, and the climate control blower switch is set at high speed. DO NOT use the recirculation mode.**

EMERGENCY SEAT BACK RELEASE (SEDAN)

WARNING!

Do not allow children to have access to the liftgate area with the rear shelf panel in position 1 (Top) or position 2 (Middle), either by climbing into the liftgate from outside, or through the inside of the vehicle. Always close the liftgate when your vehicle is unattended. Once in the liftgate area, young children may not be able to escape, even if they entered through the rear seat. If trapped in the liftgate, children can die from suffocation or heat stroke.

As a security measure, a Seat Back Emergency Release lever is built into the left side rear seat back latching mechanism. In the event of an individual being locked inside the liftgate area with the rear shelf panel in position 1 (Top) or position 2 (Middle), the left side rear

seat back can be unlatched by pulling down on the glow-in-the-dark lever attached to the left rear seat back latching mechanism.

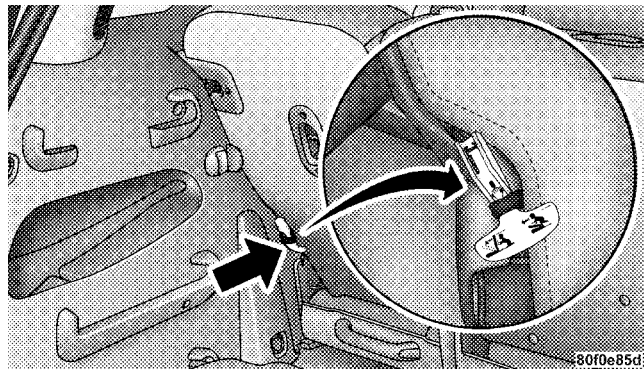

Emergency Seat Back Release

Once unlatched the seat back can be pushed forward to gain access into the interior of the vehicle.

NOTE: Make sure that the elastic loop is around the emergency release handle at all times. If the handle is pulled downward, entirely through the elastic loop, the handle will not return to its original position and the seat back may not operate properly.

EMERGENCY DECK LID RELEASE LATCH (CONVERTIBLE)

WARNING!

Do not allow children to have access to the trunk, either by climbing into the trunk from outside, or through the inside of the vehicle. Always close the deck lid when your vehicle is unattended. Once in the trunk, young children may not be able to escape, even if they entered through the rear seat. If trapped in the trunk, children can die from suffocation or heat stroke.

As a security measure, an emergency deck lid release lever is built into the deck lid latching mechanism. In the event of an individual being locked inside the trunk, the trunk can be simply opened by pulling on the glow-in-the-dark lever attached to the deck lid latching mechanism. See following picture.

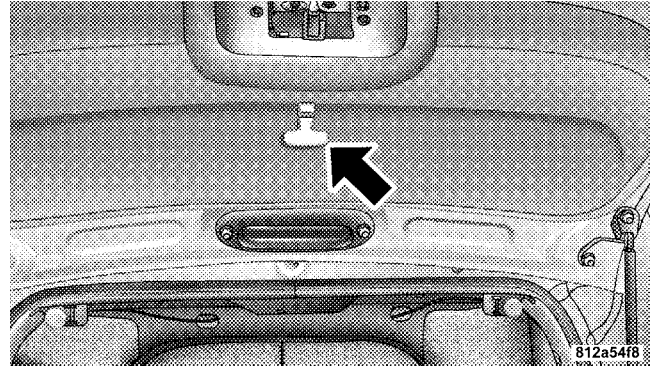

Emergency Deck Lid Release Handle

POWER WINDOWS

The power window switches are located on the instrument panel above the radio. The top left switch controls the left front window and the top right switch controls the right front window.

The lower left switch controls the left rear window and the lower right switch controls the right rear window.

The sedan has a window lock switch, located between the window switches that are located at the back of the center floor console.

The convertible has an "All windows up" and "All windows down," switch located between the window switches instead of the lock switch.

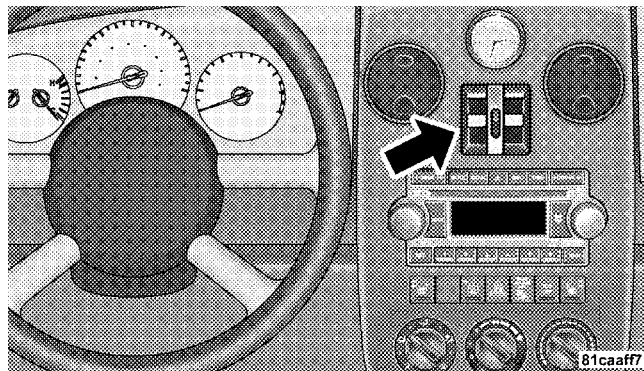

Power Window Switches

WARNING!

Never leave children in a vehicle, with the keys in the ignition switch. Occupants, particularly unattended children, can become entrapped by the windows while operating the power window switches. Such entrapment may result in serious injury or death.

AUTO DOWN FEATURE

The driver's and passenger's front window switches have an auto down feature. Press the window switch past the detent, release, and the window will go down automatically. Press the switch a second time in either direction to stop the window.

To open the window part way, press the window switch part way and release it when you want the window to stop.

REAR WINDOW SWITCHES

There are also rear passenger window switches (sedan only) located at the rear of the center console.

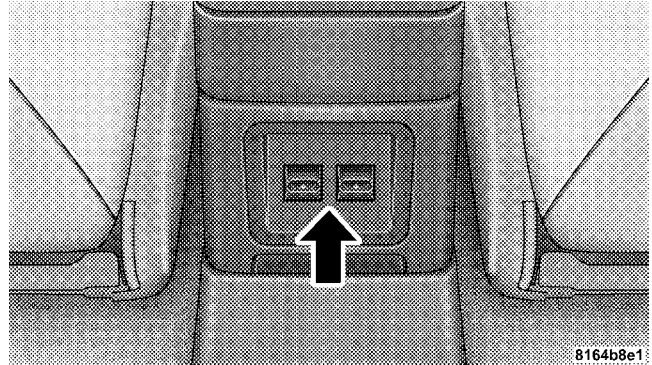

Power Rear Window Switches Sedans

WIND BUFFETING

Wind buffeting can be described as the perception of pressure on the ears or a helicopter type sound in the ears. Your vehicle may exhibit wind buffeting with the windows down, or the sunroof (if equipped) in certain open or partially open positions. This is a normal occurrence and can be minimized. If the buffeting occurs with the rear windows open, open the front and rear windows together to minimize the buffeting. If the buffeting occurs with the sunroof open, adjust the sunroof opening to minimize the buffeting.

OCCUPANT RESTRAINTS (SEDAN)

Some of the most important safety features in your vehicle are the restraint systems. These include:

- Front and rear seat belts for all passengers
- Front airbags for both the driver and front passenger

- Pretensioning and load-limiting retractors for the front seat belts.
- Knee Impact Blocker panels for front seat occupants.
- Supplemental front seat mounted side Head/Thorax airbags for both the driver and front passenger (if equipped).
- Front seat belt retractors that incorporate pretensioners to enhance occupant protection by managing occupant energy during an impact event.

If you will be carrying children too small for adult-size seat belts, your seat belts or the LATCH feature also, can be used to hold infant and child restraint systems.

Please pay close attention to the information in this section. It tells you how to use your restraint system properly to keep you and your passengers as safe as possible.

WARNING!

In a collision, you and your passengers can suffer much greater injuries if you are not properly buckled up. You can strike the interior of your vehicle or other passengers, or you can be thrown out of the vehicle. Always be sure you and others in your vehicle are buckled up properly.

Buckle up even though you are an excellent driver, even on short trips. Someone on the road may be a poor driver and cause a collision that includes you. This can happen far away from home or on your own street.

Research has shown that seat belts save lives, and they can reduce the seriousness of injuries in a collision. Some of the worst injuries happen when people are thrown from the vehicle. Seat belts reduce the possibility of ejection and the risk of injury caused by striking the inside of the vehicle. **Everyone in a motor vehicle should be belted at all times.**

LAP/SHOULDER BELTS

All the seats in your vehicle are equipped with Lap/Shoulder Belts.

The belt webbing retractor is designed to lock during very sudden stops or collisions. This feature allows the shoulder part of the belt to move freely with you under normal conditions. But in a collision, the belt will lock and reduce the risk of your striking the inside of the vehicle or being thrown out.

WARNING!

- It is extremely dangerous to ride in a cargo area, inside or outside of a vehicle. In a collision, people riding in these areas are more likely to be seriously injured or killed.
- Do not allow people to ride in any area of your vehicle that is not equipped with seats and seat belts.
- Be sure everyone in your vehicle is in a seat and using a seat belt properly.

WARNING!

- Wearing a seat belt incorrectly is dangerous. Seat belts are designed to go around the large bones of your body. These are the strongest parts of your body and can take the forces of a collision the best.
- Wearing your belt in the wrong place could make your injuries in a collision much worse. You might suffer internal injuries, or you could even slide out of part of the belt. Follow these instructions to wear your seat belt safely and to keep your passengers safe, too.

WARNING!

Two people should never be belted into a single seat belt. People belted together can crash into one another in an accident, hurting one another badly. Never use a lap/shoulder belt or lap belt for more than one person, no matter what their size.

Lap/Shoulder Belt Operating Instructions

1. Enter the vehicle and close the door. Sit back and adjust the seat.

2. The seat belt latch plate is above the back of the front seat, next to your arm. Grasp the latch plate and pull out the belt. Slide the latch plate up the webbing as far as necessary to allow the belt to go around your lap.

WARNING!

A shoulder belt placed behind you will not protect you from injury during a collision. You are more likely to hit your head in a collision if you do not wear your shoulder belt. The lap and shoulder belt are meant to be used together.

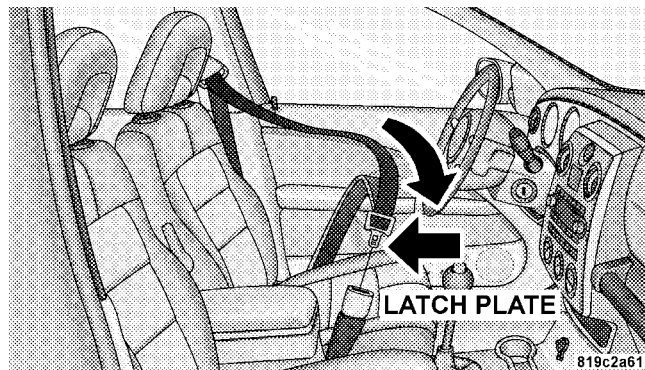

Latch Plate

3. When the belt is long enough to fit, insert the latch plate into the buckle until you hear a “click.”

WARNING!

- A belt that is worn under your arm is very dangerous. Your body could strike the inside surfaces of the vehicle in a collision, increasing head and neck injury. A belt worn under the arm can cause internal injuries. Ribs aren't as strong as shoulder bones. Wear the belt over your shoulder so that your strongest bones will take the force in a collision.
- A shoulder belt placed behind you will not protect you from injury during a collision. You are more likely to hit your head in a collision if you do not wear your shoulder belt. The lap and shoulder belt are meant to be used together.

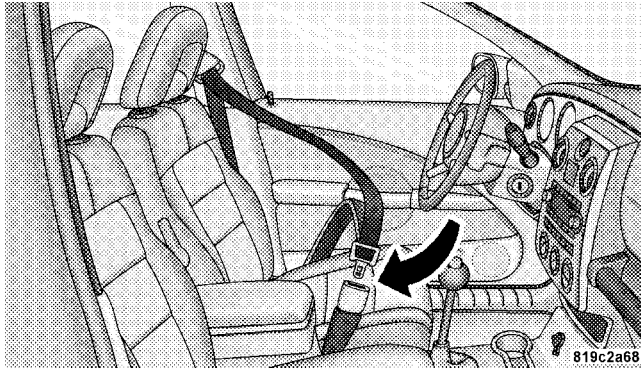

Inserting Latch Plate Into Buckle

4. Position the lap belt across your thighs, below your abdomen. To remove slack in the lap belt portion, pull up on the shoulder belt. To loosen the lap belt if it is too tight, tilt the latch plate and pull on the lap belt. A snug belt reduces the risk of sliding under the belt in a collision.

2

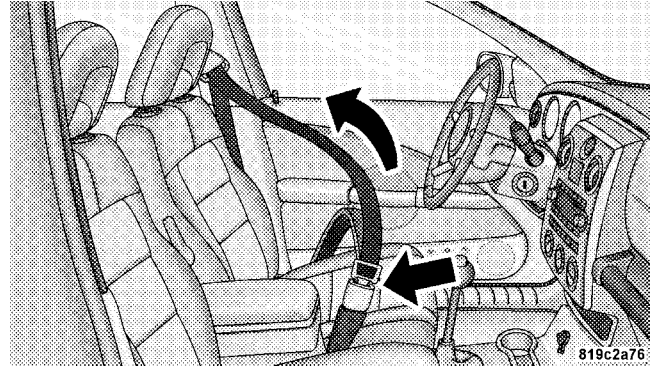

Removing Slack From Belt

WARNING!

- A lap belt worn too high can increase the risk of internal injury in a collision. The belt forces won't be at the strong hip and pelvic bones, but across your abdomen. Always wear the lap belt as low as possible and keep it snug.
- A twisted belt can't do its job as well. In a collision it could even cut into you. Be sure the belt is straight. If you can't straighten a belt in your vehicle, take it to your dealer and have it fixed.

WARNING!

- A belt that is buckled into the wrong buckle will not protect you properly. The lap portion could ride too high on your body, possibly causing internal injuries. Always buckle your belt into the buckle nearest you.
- A belt that is too loose will not protect you as well. In a sudden stop you could move too far forward, increasing the possibility of injury. Wear your seat belt snugly.

5. Position the shoulder belt on your chest so that it is comfortable and not resting on your neck. The retractor will withdraw any slack in the belt.

6. To release the belt, push the red button on the buckle. The belt will automatically retract to its stowed position. If necessary, slide the latch plate down the webbing to allow the belt to retract fully.

WARNING!

A frayed or torn belt could rip apart in a collision and leave you with no protection. Inspect the belt system periodically, checking for cuts, frays, or loose parts. Damaged parts must be replaced immediately. Do not disassemble or modify the system. Seat belt assemblies must be replaced after a collision if they have been damaged (bent retractor, torn webbing, etc.).

Rear Center Lap/Shoulder Belt Retractor Lock-Out

This feature is designed to lock the retractor whenever the rear seat back is not fully latched. This prevents someone from wearing the rear center lap/shoulder belt when the rear seat back is not fully latched.

NOTE:

- If the rear center lap/shoulder belt can not be pulled out, check that the rear seat back is fully latched.
- If the rear seat back is properly latched and the rear center lap/shoulder belt still can not be pulled out, the Automatic-Locking Retractor (ALR) system may be activated. To reset this feature you must let all of the belt webbing return into the retractor. You will not be able to pull out more webbing until all of the webbing has been returned back into the retractor.

WARNING!

The rear center lap/shoulder belt is equipped with a lockout feature to ensure that the rear seat back is in the fully upright and locked position when occupied. If the rear seat back is not fully upright and locked and the rear center lap/shoulder belt can be pulled out of the retractor, the vehicle should immediately be taken to your dealer for service. Failure to follow this warning could result in serious or fatal injury.

LAP/SHOULDER SEAT BELT UNTWISTING PROCEDURE

Use the following procedure to untwist a twisted lap/shoulder belt.

1. Position the latch plate as close as possible to the anchor point.

2. At about six to twelve inches (15 to 30 cm) above the latch plate, grasp and twist the belt webbing 180° to create a fold that begins immediately above the latch plate.

3. Slide the latch plate upward over the folded webbing. The folded webbing must enter the slot at the top of the latch plate.

4. Continue to slide the latch plate up until it clears the folded webbing.

ADJUSTABLE UPPER SHOULDER SEAT BELT ANCHORAGE

In the front seat, the shoulder belt can be adjusted upward or downward to position the belt away from your neck. Push up or down on the anchorage button to release the anchorage, and move it up or down to the position that serves you best.

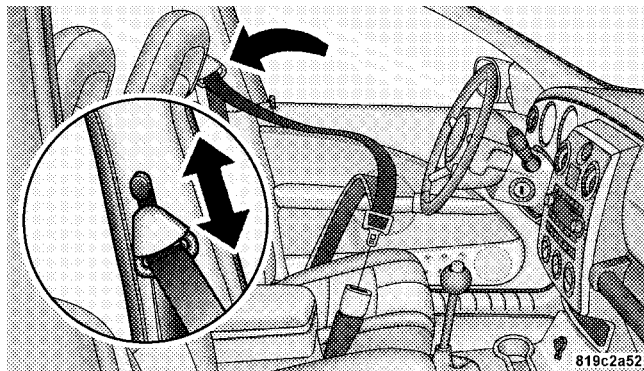

Adjusting Upper Shoulder Belt

As a guide, if you are shorter than average, you will prefer a lower position, and if you are taller than average, you'll prefer a higher position. When you release the anchorage, try to move it up or down to make sure that it is locked in position.

SEAT BELT PRETENSIONERS

The seat belts for both front seating positions are equipped with pretensioning devices that are designed to remove slack from the seat belt in the event of a collision. These devices improve the performance of the seat belt by assuring that the belt is tight about the occupant early in a collision. Pretensioners work for all size occupants, including those in child restraints.

NOTE: These devices are not a substitute for proper seat belt placement by the occupant. The seat belt still must be worn snugly and positioned properly.

The pretensioners are triggered by the front airbag control module (see Airbag Section). Like the front airbags, the pretensioners are single use items. After a collision that is severe enough to deploy the airbags and pretensioners, both must be replaced.

ENHANCED SEAT BELT REMINDER SYSTEM (BELTALERT®)

If the driver's or front passenger's seat belt has not been buckled within 60 seconds of starting the vehicle and if the vehicle speed is greater than 5 mph (8 km/h), the Enhanced Warning System (BeltAlert®) will alert the driver or front passenger to buckle their seat belt. The driver should also instruct all other occupants to buckle their seat belts. If the driver unbuckles the seat belt while the vehicle is in motion an immediate chime will be heard and, the Enhanced Warning System (BeltAlert®) will continue to chime and flash the Seat Belt Warning Light for 96 seconds or until the driver's seat belt is buckled. The Enhanced Warning System (BeltAlert®) will be reactivated if the driver's or front passenger's seat belt is unbuckled for more than 10 seconds and the vehicle speed is greater than 5 mph (8 km/h).

NOTE:

- The Enhanced Warning System (BeltAlert®) can be enabled or disabled by your authorized dealer.
- DaimlerChrysler does not recommend deactivating the Enhanced Warning System (BeltAlert®).

If the Enhanced Warning System (BeltAlert®) is deactivated, the Seat Belt Warning Light will continue to illuminate while the driver seat belt remains unfastened.

SEAT BELTS AND PREGNANT WOMEN

We recommend that pregnant women use the seat belts throughout their pregnancy. Keeping the mother safe is the best way to keep the baby safe.

Pregnant women should wear the lap part of the belt across the thighs and as snug across the hips as possible. Keep the belt low so that it does not come across the abdomen. That way the strong bones of the hips will take the force if there is a collision.

DRIVER AND FRONT PASSENGER SUPPLEMENTAL RESTRAINT SYSTEM (SRS) AIRBAG

This vehicle has airbags for both the driver and front passenger as a supplement to the seat belt restraint systems. The driver's front airbag is mounted in the center of the steering wheel. The passenger's front airbag is mounted in the instrument panel, above the glove compartment. The words SRS AIRBAG are embossed on the airbag covers.

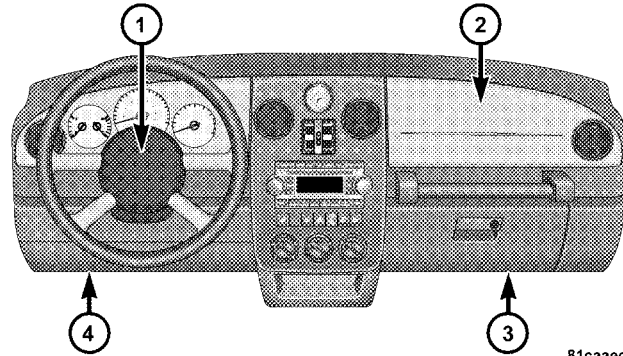

81caaece

Front Panel SRS Features

- | | |
|----------------------|----------------------------|
| 1 — Driver Airbag | 3 — Passenger Knee Blocker |
| 2 — Passenger Airbag | 4 — Driver Knee Blocker |

Head/Thorax airbags (if equipped) are located inside the driver and front passenger seats, and their covers are also labeled SRS AIRBAG.

NOTE: Airbag covers may not be obvious in the interior trim; but they will open to allow airbag deployment.

WARNING!

- Do not drill, cut or tamper with the knee impact blocker panels in any way.
- Do not mount any accessories to the knee blocker panel such as alarm lights, stereos, citizens band radios etc.

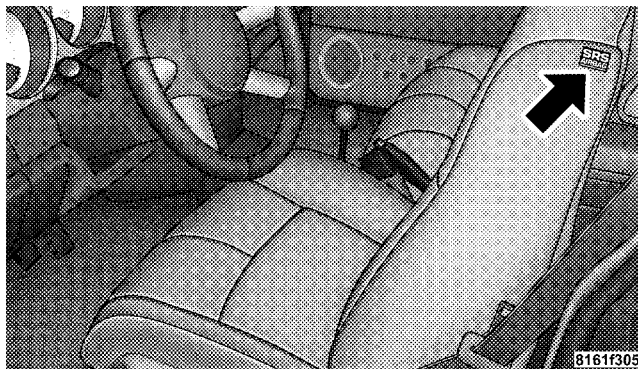

WARNING!

- **Do not put anything on or around the airbag covers or attempt to manually open them. You may damage the airbags and you could be injured because the airbags are not there to protect you. These protective covers for the airbag cushions are designed to open only when the airbags are inflating.**
- **If your vehicle is equipped with Head/Thorax airbags, do not use accessory seat covers or place objects between you and the airbags; the performance could be adversely affected and/or objects could be pushed into you, causing serious injury.**

Airbags inflate in moderate to high speed impacts. Along with seat belts and pretensioners, front airbags work with the instrument panel knee impact blockers to provide

improved protection for the driver and front passenger. Head/Thorax side airbags also work with seat belts to improve occupant protection.

The seat belts are designed to protect you in many types of collisions. The front airbags deploy in moderate to severe frontal collisions. If your vehicle is equipped, the Head/Thorax airbag on the crash side of the vehicle is triggered in moderate to severe side collisions. In certain types of collisions, both the front seat Head/Thorax airbags may be triggered. But even in collisions where the airbags work, you need to wear the seat belts to keep you in the right position for the airbags to protect you properly.

NOTE: The passenger front airbag may not deploy even when the driver front airbag has if the Occupant Classification System (refer to "Occupant Classification System" in this section) has determined the passenger seat is

empty or is occupied by someone that is classified in the “child” category. This could be a child, a teenager, or even a small adult.

Here are some simple steps you can take to minimize the risk of harm from a deploying airbag.

1. Children 12 years old and under should always ride buckled up in a rear seat.

Infants in rear facing child restraints should **NEVER** ride in the front seat of a vehicle with a passenger front airbag. An airbag deployment can cause severe injury or death to infants in that position.

Children that are not big enough to properly wear the vehicle seat belt (see Section on Child Restraints) should be secured in the rear seat in child restraints or belt-positioning booster seats. Older children who do not use child restraints or belt-positioning booster seats should

ride properly buckled up in the rear seat. Never allow children to slide the shoulder belt behind them or under their arm.

You should read the instructions provided with your child restraint to make sure that you are using it properly.

2. All occupants should wear their lap and shoulder belts properly.
3. The driver and front passenger seats should be moved back as far as practical to allow the front airbags room to inflate.
4. If your vehicle has supplemental side and or thorax airbags, do not lean against the door, airbags will inflate forcefully into the space between you and the door.
5. If the airbag system in this vehicle needs to be modified to accommodate a disabled person, contact the Customer Center. Phone numbers are provided under “If You Need Assistance” in Section 9 of this manual.

WARNING!

- **Relying on the airbags alone could lead to more severe injuries in a collision. The airbags work with your seat belt to restrain you properly. In some collisions the airbags won't deploy at all. Always wear your seat belts even though you have airbags.**
- **Being too close to the steering wheel or instrument panel during front airbag deployment could cause serious injury. Airbags need room to inflate. Sit back, comfortably extending your arms to reach the steering wheel or instrument panel.**
- **Seat airbags also need room to inflate. Do not lean against the door. Sit upright in the center of the seat.**

The front airbag system consists of the following:

- Occupant Restraint Controller
- Side Remote Acceleration Sensors (If equipped)
- Airbag Warning Light
- Driver and Front Passenger Airbag
- Front Seat Mounted Head/Thorax Airbags (if equipped)
- Steering Wheel and Column
- Instrument Panel
- Driver and Front Passenger Knee Impact Blockers
- Front Acceleration Sensors
- Driver and Front Passenger Seat Belt Pretensioners
- Passenger Airbag Disable (PAD) Indicator Light

The Head/Thorax airbag system (if equipped) consists of the following:

- AIRBAG Readiness Light (shared with the front airbag system)
- Front Seat— side mounted Head/Thorax Airbags — if equipped
- Airbag Control Module (shared with the front airbag system)
- Side impact sensors

How The Airbag System Works

- The **Occupant Restraint Controller (ORC)** determines if a frontal collision is severe enough to require the airbags to inflate. The front airbag inflators are designed to provide different rates of airbag inflation from direction provided by the ORC. The ORC may

also modify the rate of inflation based on the occupant size provided by the Occupant Classification Module. The ORC will not detect roll over.

The ORC also monitors the readiness of the electronic parts of the system whenever the ignition switch is in the START or RUN positions. These include all of the items listed above except the steering wheel and column, and knee blocker panels. If the key is in the OFF position, in the ACC position, or not in the ignition, the airbags are not on and will not inflate.

During a moderate-to-severe rear impact the ORC may deploy the seat belt pretensioners alone.



Also, the ORC turns on the AIRBAG warning light and PAD indicator light in the instrument panel for six to eight seconds for a self-check when the ignition is first turned on. After the self-check, the AIRBAG warning light will turn off. The PAD indicator light will function normally (Refer to

"Passenger Airbag Disable (PAD) Indicator Light" in this section). If the ORC detects a malfunction in any part of the system, it turns on the AIRBAG warning light either momentarily or continuously. A single chime will sound if the light comes on again after initial start up.

WARNING!

Ignoring the AIRBAG light in your instrument panel could mean you won't have the airbags to protect you in a collision. If the light does not come on, stays on after you start the vehicle, or if it comes on as you drive, have the airbag system checked right away.

- When the front airbag control module detects a collision requiring the front airbags, it signals the inflator units. A large quantity of nontoxic gas is generated to inflate the front airbags. The front airbag covers separate and fold out of the way as the front airbags inflate

to their full size. The front airbags fully inflate in about 50 milliseconds. This is only about half of the time it takes you to blink your eyes. The front airbags then quickly deflate while helping to restrain the driver and front passenger. The driver's and passenger's front airbag gas is vented through holes in the sides of the airbag. In this way the front airbags do not interfere with your control of the vehicle.

- The **Passenger Airbag Disable (PAD) Indicator Light** (an amber light located in the center of the instrument panel) tells the driver and front passenger when the front passenger airbag is turned off. The PAD Indicator lamp illuminates the words "PASS AIRBAG OFF" to show that the front passenger airbag will not inflate during a collision requiring airbags. When the right front passenger seat is empty or when very light objects are placed on the seat, the passenger airbag will not inflate even though the PAD indicator lamp is not illuminated.

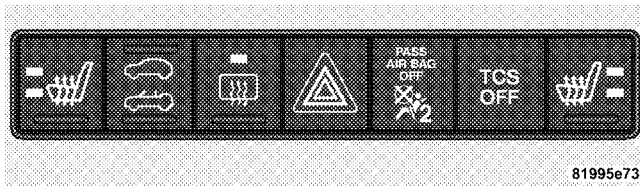

81995e73

Passenger Airbag Disabled Light



- The PAD indicator light should not be illuminated when an adult passenger is properly seated in the front passenger seat. In this case, the airbag is ready to be inflated if a collision requiring an airbag occurs.

For all other occupants, the PAD indicator light will be illuminated indicating that the front passenger airbag is turned off and will not inflate.

NOTE: Even though this vehicle is equipped with an occupant classification system, children 12 years and under should always ride buckled up in a rear seat in an appropriate child restraint (see section on child restraints).

WARNING!

Never place a rear facing infant seat in front of an airbag. A deploying passenger airbag can cause death or serious injury to a child in a rear facing infant seat.

Passenger Airbag Disable (PAD) System		
Front Passenger	Indicator Light	Airbag Status
Adult	OFF	ON
Child	ON	OFF
Grocery Bags, Heavy Briefcases and Other Relatively Light Objects	ON	OFF
Empty or Very Small Objects	OFF*	OFF
* Since the system senses weight, some small objects will turn the PAD Indicator Light on.		

Drivers and adult passengers should verify that the PAD Indicator Light is not illuminated when an adult is riding in the front passenger seat. If an adult occupant's weight is transferred to another part of the vehicle (like the door or instrument panel), the weight sensors in the seat may

not properly classify the occupant. Objects lodged under the seat or between the seat and the center console can prevent the occupant's weight from being measured properly and may result in the occupant being improperly classified. Ensure that the front passenger seat back does not touch anything placed on the second row of seats because this can also affect occupant classification. Also, if you fold down the seats in the second row check to be sure they don't touch the front passenger seat.

If the front passenger seat is damaged in any way, it should only be serviced by an authorized dealer. If the seat is removed (or even if the seat attachment bolts are loosened or tightened in any way), take the vehicle to an authorized dealer.

If there is a fault present in the Airbag Warning Light (a red light located in the center of the instrument cluster directly in front of the driver) will be turned on. This

indicates that you should take the vehicle to an authorized dealer. The Airbag Warning Light is turned on whenever there is a fault that can affect the operation of the airbag system. If there is a fault present in the PAD Indicator Light the Airbag Warning Light remains illuminated to show that the passenger airbag is turned off until the fault is cleared. If an object is lodged under the seat and interferes with operation of the weight sensors, a fault will occur which turns on both the PAD Indicator Light and the Airbag Warning Light. Once the lodged object is removed, the fault will be automatically cleared after a short period of time.

- The **Driver and Passenger Airbag/Inflator Units** are located in the center of the steering wheel and the right side of the instrument panel. When the ORC detects a collision requiring the airbags, it signals the inflator units. A large quantity of nontoxic gas is generated to inflate the front airbags. Different airbag inflation rates

may be possible based on collision severity and occupant size. The steering wheel hub trim cover and the upper right side of the instrument panel separate and fold out of the way as the bags inflate to their full size. The bags fully inflate in about 50 - 70 milliseconds. This is about half of the time it takes to blink your eyes. The bags then quickly deflate while helping to restrain the driver and front passenger. The driver's front airbag gas is vented through vent holes in the sides of the airbag. The passenger's front airbag gas is vented through vent holes in the sides of the airbag. In this way the airbags do not interfere with your control of the vehicle.

- The **Occupant Classification Module (OCM)** is located beneath the front passenger seat. The OCM classifies the occupant into categories based on the measurements made by the seat weight sensors. The OCM communicates with the ORC. The ORC uses the occupant category to determine whether the front

passenger airbag should be turned off. It also determines the rate of airbag inflation during a collision.

- Your vehicle has four **Weight Sensors** located between the seat and the floor pan. The weight sensors measure applied weight and transfers that information to the OCM.
- The **Head/Thorax Side Airbags—If Equipped (SRS)** are designed to activate only in certain side collisions.

The ORC module determines if a side collision is severe enough to require the Head/Thorax airbags to inflate. The side airbag control module will not detect roll over, front or rear collisions.

The ORC Module monitors the readiness of the electronic parts of the system whenever the ignition switch is in the START or ON positions. These include all of the items listed under **“The Head/Thorax side airbag system consists of the following”**.

In moderate to severe side collisions the inflating Head/Thorax airbag exits through the seat seam into the space between the occupant and the door. The Head/Thorax airbag moves at a very high speed and with such a high force, that it could injure you if you are not seated properly, or if items are positioned in the area where the airbag inflates. This especially applies to children.

The following requirements must be strictly adhered to:

- Do not modify the front passenger seat assembly or components in any way.
- Do not modify the front seat center console or center position seat in any way.
- Do not use prior or future model year seat covers not designated for the specific model being repaired. Always use the correct seat cover specified for the vehicle.

- Do not replace the seat cover with an aftermarket seat cover.
- Do not add a secondary seat cover other than those approved by DaimlerChrysler/Mopar®.
- At no time should any supplemental restraint system (SRS) component or SRS related component or fastener be modified or replaced with any part except those which are approved by DaimlerChrysler/Mopar®.

WARNING!

Unapproved modifications or service procedures to the front passenger seat assembly, its related components, or seat cover may inadvertently change the airbag deployment in case of a frontal crash. This could result in death or serious injury to the front seat passenger if the vehicle is involved in an accident.

If A Deployment Occurs

The airbag systems are designed to deploy when the airbag control modules detect a moderate-to-severe collision, to help restrain the driver and front passenger, and then immediately deflate.

NOTE: A frontal collision that is not severe enough to need airbag protection will not activate the system. This does not mean something is wrong with the airbag system.

If you do have a collision which deploys the airbags, any or all of the following may occur:

- The nylon airbag material may sometimes cause abrasions and/or skin reddening to the driver and front passenger as the airbags deploy and unfold. The abrasions are similar to friction rope burns or those you might get sliding along a carpet or gymnasium floor. They are not caused by contact with chemicals. They are not permanent and normally heal quickly. However, if you haven't healed significantly within a few days, or if you have any blistering, see your doctor immediately.
- As the airbags deflate you may see some smoke-like particles. The particles are a normal by-product of the process that generates the nontoxic gas used for airbag inflation. These airborne particles may irritate the skin, eyes, nose, or throat. If you have skin or eye irritation, rinse the area with cool water. For nose or throat irritation, move to fresh air. If the irritation continues, see your doctor. If these particles settle on your clothing, follow the garment manufacturer's instructions for cleaning.
- It is not advisable to drive your vehicle after the airbags have deployed. If you are involved in another collision, the airbags will not be in place to protect you.

WARNING!

Deployed airbags and seat belt pretensioners cannot protect you in another collision. Have the airbags, seat belt pretensioners, front passenger seat belt retractor assembly and Occupant Classification System, replaced by an authorized dealer as soon as possible.

Maintaining Your Airbag System

WARNING!

Modifications to any part of the airbag system could cause it to fail when you need it. You could be injured if the airbag system is not there to protect you. Do not modify the components or wiring, including adding any kind of badges or stickers to the steering wheel hub trim cover or the upper right side of the instrument panel. Do not modify the front bumper, vehicle body structure, or add aftermarket side steps or running boards.

WARNING!

Do not attempt to modify any part of your advanced airbag system. The airbag may inflate accidentally or may not function properly if modifications are made. Take your vehicle to an authorized dealer for any advanced airbag system service. If your seat including your trim cover and cushion needs to be serviced in any way (including removal or loosening/tightening of seat attachment bolts), take the vehicle to your authorized dealer. Only manufacturer approved seat accessories may be used. If it is necessary to modify an advanced airbag system for persons with disabilities, contact your authorized dealer.

WARNING!

- Do not place or hang any items such as add-on video players on the front seat backs. The additional weight may cause the Occupant Classification System to be unable to correctly classify the right front occupant. This could allow the passenger frontal airbag to inflate when it is not desired.
- You need proper knee impact protection in a collision. Do not mount or locate any aftermarket equipment on or behind the knee blocker panel.
- It is dangerous to try to repair any part of the airbag system yourself. Be sure to tell anyone who works on your vehicle that it has an airbag system.

NOTE: Perchlorate Material – special handling may apply, See www.dtsc.ca.gov/hazardouswaste/perchlorate.”

Airbag Light

You will want to have the airbags ready to inflate for your protection in a collision. While the airbag system is designed to be maintenance free, if any of the following occurs, have an authorized dealer service the system immediately.

- The AIRBAG light does not come on during the six to eight seconds when the ignition switch is first turned on.
- The light remains on after the six to eight second interval.
- The light comes on and remains on while driving.

Event Data Recorder (EDR)

In the event of an accident, your vehicle is designed to record up to five - seconds of specific vehicle data parameters (see list below) in an event data recorder

prior to the moment of airbag deployment, or near-deployment, and up to a quarter second of high-speed deceleration data during and/or after airbag deployment or near-deployment. EDR data are ONLY recorded if an airbag deploys, or nearly deploys, and are otherwise unavailable.

NOTE:

1. A near-deployment event occurs when the airbag sensor detects severe vehicle deceleration usually indicative of a crash, but not severe enough to warrant airbag deployment.
2. Under certain circumstances, EDR data may not be recorded (e.g., loss of battery power).

In conjunction with other data gathered during a complete accident investigation, the electronic data may be used by DaimlerChrysler and others to learn more about the possible causes of crashes and associated injuries in order to assess and improve vehicle performance. In

addition to crash investigations initiated by DaimlerChrysler, such investigations may be requested by customers, insurance carriers, government officials, and professional crash researchers, such as those associated with universities, and with hospital and insurance organizations.

In the event that an investigation is undertaken by DaimlerChrysler (regardless of initiative), the company or its designated representative will first obtain permission of the appropriate custodial entity for the vehicle (usually the vehicle owner or lessee) before accessing the electronic data stored, unless ordered to download data by a court with legal jurisdiction (i.e., pursuant to a warrant). A copy of the data will be provided to the custodial entity upon request. General data that does not identify particular vehicles or crashes may be released for incorporation in aggregate crash databases, such as those maintained by the US government and various states. Data of a potentially sensitive nature, such as would

identify a particular driver, vehicle, or crash, will be treated confidentially. Confidential data will not be disclosed by DaimlerChrysler to any third party except when:

1. Used for research purposes, such as to match data with a particular crash record in an aggregate database, provided confidentiality of personal data is thereafter preserved
2. Used in defense of litigation involving a DaimlerChrysler product
3. Requested by police under a legal warrant
4. Otherwise required by law

Data Parameters that May Be Recorded:

- Diagnostic trouble code(s) and warning lamp status for electronically-controlled safety systems, including the airbag system

- Airbag disable lamp status (if equipped)
- "Time" of airbag deployment (in terms of ignition cycles and vehicle mileage)
- Airbag deployment level (if applicable)
- Impact acceleration and angle
- Seatbelt status
- Brake status (service and parking brakes)
- Accelerator status (including vehicle speed)
- Engine control status (including engine speed)
- Transmission gear selection
- Cruise control status
- Traction/stability control status
- Tire pressure monitoring system status

CHILD RESTRAINT

Everyone in your vehicle needs to be buckled up at all times — babies and children, too. Every state in the United States and all Canadian provinces require that small children ride in proper restraint systems. This is the law, and you can be prosecuted for ignoring it.

Children 12 years and under should ride properly buckled up in a rear seat, if available. According to crash statistics, children are safer when properly restrained in the rear seats, rather than in the front.

WARNING!

In a collision, an unrestrained child, even a tiny baby, can become a missile inside the vehicle. The force required to hold even an infant on your lap could become so great that you could not hold the child, no matter how strong you are. The child and others could be badly injured. Any child riding in your vehicle should be in a proper restraint for the child's size.

Infants And Small Children

There are different sizes and types of restraints for children from newborn size to the child almost large enough for an adult safety belt. Always check the child seat owner's manual to ensure you have the correct seat for your child. Use the restraint that is correct for your child:

- Safety experts recommend that children ride rearward-facing in the vehicle until they are at least one year old and weigh at least 20 lbs (9 kg). Two types of child restraints can be used rearward-facing: infant carriers and "convertible" child seats. Both types of child restraints are held in the vehicle by the lap/shoulder belt or the LATCH child restraint anchorage system.
- This vehicle is not capable of accommodating the installation of a car bed used for carrying newborn babies at the right front passenger seat position. If a car bed must be used to transport a newborn baby, the car bed must be installed in the second seating row only.
- The infant carrier is only used rearward-facing in the vehicle. It is recommended for children who weigh up to about 20 lbs (9 kg). "Convertible" child seats can be used either rearward-facing or forward-facing in the vehicle. Convertible child seats often have a higher

74 THINGS TO KNOW BEFORE STARTING YOUR VEHICLE

weight limit in the rearward-facing direction than infant carriers do, so they can be used rearward-facing by children who weigh more than 9 kg (20 lbs) but are less than one year old.

- Rearward-facing child seats must **NEVER** be used in the front seat of a vehicle with a front passenger airbag. An airbag deployment could cause severe injury or death to infants in this position.
- Children who weigh more than 20 lbs (9 kg) and who are older than one year can ride forward-facing in the vehicle. Forward-facing child seats and convertible child seats used in the forward-facing direction are for children who weigh 20 to 40 lbs (9 to 18 kg) and who are older than one year. These child seats are also held in the vehicle by the lap/shoulder belt or the LATCH child restraint anchorage system.
- The belt-positioning booster seat is for children weighing more than 40 lbs (18 kg), but who are still too small to fit the vehicle's seat belts properly. If the child cannot sit with knees bent over the vehicle's cushion while the child's back is against the seat back; they should use a Belt Positioning Booster Seat. The child and booster seat are held in the vehicle by the lap/shoulder belt. (Some booster seats are equipped with a front shield and are held in the vehicle by the lap portion.)

NOTE: For additional information refer to www.nhtsa.gov or www.seatcheck.org.

WARNING!

- **Improper installation can lead to failure of an infant or child restraint. It could come loose in a collision. The child could be badly injured or killed. Follow the manufacturer's directions exactly when installing an infant or child restraint.**
- **A rearward facing child restraint should only be used in a rear seat. A rearward facing child restraint in the front seat may be struck by a deploying passenger airbag which may cause severe or fatal injury to the infant.**

Here are some tips on getting the most out of your child restraint:

- Before buying any restraint system, make sure that it has a label certifying that it meets all applicable Safety Standards. We also recommend that you make sure

that you can install the child restraint in the vehicle where you will use it, before you buy it.

- The restraint must be appropriate for your child's weight and height. Check the label on the restraint for weight and height limits.
- Carefully follow the instructions that come with the restraint. If you install the restraint improperly, it may not work when you need it.

The passenger seat belts are equipped with either cinching latch plates or seat belt retractors that can be switched to an automatic locking mode, which are designed to keep the lap portion tight around the child restraint so that it is not necessary to use a locking clip. If the seat belt has a cinching latch plate, pulling up on the shoulder portion of the lap/shoulder belt will tighten the belt. The cinching latch plate will keep the belt tight, however, any seat belt system will loosen with time, so check the belt occasionally and pull it tight if necessary.

If the seat belt has a switchable retractor, please refer to Automatic-Locking Retractor (ALR) in this section.

- In the rear seat, you may have trouble tightening the lap/shoulder belt on the child restraint because the buckle or latch plate is too close to the belt path opening on the restraint. Disconnect the latch plate from the buckle and twist the short buckle end of the belt several times to shorten it. Insert the latch plate into the buckle with the release button facing out.
- If the belt still can't be tightened, or if by pulling and pushing on the restraint loosens the belt, disconnect the latch plate from the buckle, turn the latch plate around, and insert the latch plate into the buckle again. If you still can't make the child restraint secure, try a different seating position.
- Buckle the child into the seat according to the child restraint manufacturer's directions.

- When your child restraint is not in use, secure it in the vehicle with the seat belt or remove it from the vehicle. Don't leave it loose in the vehicle. In a sudden stop or collision, it could strike the occupants or seat backs and cause serious personal injury.

Automatic-Locking Retractor (ALR)

To operate the switchable retractor, pull the belt from the retractor until there is enough to allow you to pass through the child restraint and slide the latch plate into the buckle. Then pull on the belt until it is all removed from the retractor. Allow the belt to return into the retractor, pulling on the excess webbing to tighten the lap portion about the child restraint. Follow the instructions of the child restraint manufacture.

NOTE: To reset this feature you must let all of the belt webbing return into the retractor. You will not be able to pull out more webbing until all of the webbing has been returned back into the retractor.

Lower Anchors and Tether for Children (LATCH)

Your vehicle is equipped with the child restraint anchorage system called LATCH, which stands for Lower Anchors and Tether for Children. The LATCH system provides for the installation of the child restraint without using the vehicle seat belt. All three rear seating positions have lower and tether anchorages that are capable of accommodating LATCH-compatible child seats having flexible, webbing-mounted lower attachments. Child seats with fixed lower attachments must be installed in the outboard positions only. Regardless of the specific type of lower attachment, **NEVER** install LATCH-compatible child seats such that two seats share a common lower anchorage. If you are installing LATCH-compatible child restraints in adjacent rear seating positions, you can use the LATCH anchors or the vehicle's seat belt for the outboard position, but you must use the vehicle's seat belt at the center position. If your child

restraints are not LATCH-compatible, you can only install the child restraints using the vehicle's seat belts. Please refer to, *Installing the Child Restraint System* for typical installation instructions.

2

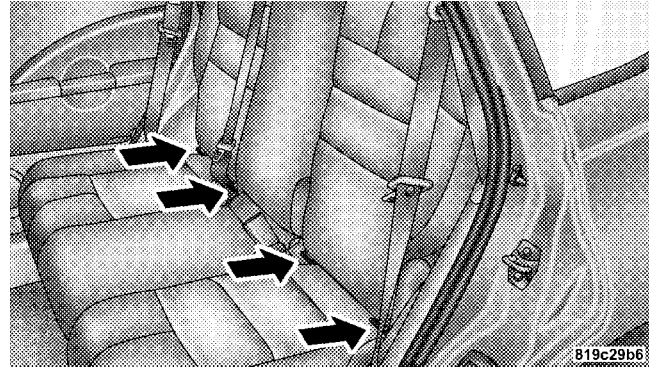
**Latch Anchors**

Child restraints systems having attachments designed to connect to the lower anchorages are now available. Child restraints having tether straps and hooks for connection to the top tether anchorage have been available for some time. In fact, many child restraint manufacturers will provide add-on tether strap kits for some of their older products. Tether anchorage kits are also available for most older vehicles.

Because the lower anchorages are to be introduced to passenger carrying vehicles over a period of years, child restraint systems having attachments for those anchorages will continue to have features for installation in vehicles using the lap or lap/shoulder belt. They will also have tether straps, and you are urged to take advantage of all of the available attachments provided with your child restraint in any vehicle.

NOTE: When using the LATCH attaching system to install a child restraint, please ensure that all seat belts

not being used for occupant restraints are stowed and out of reach of children. It is recommended that before installing the child restraint, buckle the seat belt so the seat belt is tucked behind the child restraint and out of reach. If the buckled seat belt interferes with the child restraint installation, instead of tucking the seat belt behind the child restraint, route the seat belt through the child restraint belt path and then buckle it. This should stow the seat belt out of the reach of an inquisitive child. Remind all children in the vehicle that the seat belts are not toys and should not be played with, and never leave your child unattended in the vehicle.

Installing the Child Restraint System

We urge that you carefully follow the directions of the manufacturer when installing your child restraint. Many, but not all, restraint systems will be equipped with separate straps on each side, with each having a hook or connector and a means for adjusting the tension in the strap. Forward-facing toddler restraints and some

rearward-facing infant restraints will also be equipped with a tether strap with a hook and means for adjusting the tension in the strap.

In general, you will first loosen the adjusters on the lower and tether straps so that you can more easily attach the hook or connector to the lower and tether anchorages. The tether strap should be routed under the center of the head restraint and attached to the tether anchor on the rear of the seat back. Then tighten all three straps as you push the child restraint rearward and downward into the seat.

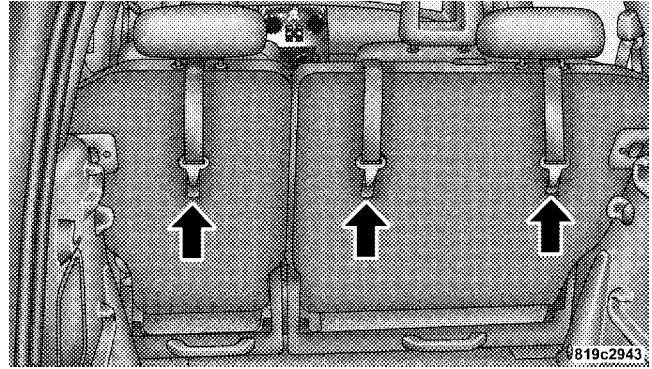

Tether Strap Mounting

Not all child restraint systems will be installed as we have described here. Again, carefully follow the instructions that come with the child restraint system.

NOTE: If your child restraint seat is not LATCH compatible, install the restraint using the vehicle seat belts.

WARNING!

An incorrectly anchored tether strap could lead to increased head motion and possible injury to the child. Use only the anchor position directly behind the child seat to secure a child restraint top tether strap.

Children Too Large For Booster Seats

Children who are large enough to wear the shoulder belt comfortably, and whose legs are long enough to bend over the front of the seat when their back is against the seat back, should use the lap/shoulder belt in a rear seat.

- Make sure that the child is upright in the seat.
- The lap portion should be low on the hips and as snug as possible.

- Check belt fit periodically. A child's squirming or slouching can move the belt out of position.
- If the shoulder belt contacts the face or neck, move the child closer to the center of the vehicle. Never allow a child to put the shoulder belt under an arm or behind their back.

Transporting Pets

Airbags deploying in the front seat could harm your pet. An unrestrained pet will be thrown about and possibly injured, or injure a passenger during panic braking or in a collision.

Pets should be restrained in the rear seat in pet harnesses or pet carriers that are secured by seat belts.

OCCUPANT RESTRAINTS (CONVERTIBLE)

Some of the most important safety features in your vehicle are the restraint systems. These include:

- Front and rear seat belts for all passengers
- Front airbags for both the driver and front passenger
- Pretensioning and load-limiting retractors for the front seat belts.
- Knee Blocker panels for front seat occupants.
- Supplemental front seat mounted side Head/Thorax airbags for both the driver and front passenger (if equipped).
- Front seat belt retractors that incorporate pretensioners to enhance occupant protection by managing occupant energy during an impact event.

If you will be carrying children too small for adult-size seat belts, your seat belts or the LATCH feature also, can be used to hold infant and child restraint systems.

Please pay close attention to the information in this section. It tells you how to use your restraint system properly to keep you and your passengers as safe as possible.

WARNING!

In a collision, you and your passengers can suffer much greater injuries if you are not properly buckled up. You can strike the interior of your vehicle or other passengers, or you can be thrown out of the vehicle. Always be sure you and others in your vehicle are buckled up properly.

Buckle up even though you are an excellent driver, even on short trips. Someone on the road may be a poor driver and cause a collision that includes you. This can happen far away from home or on your own street.

Research has shown that seat belts save lives, and they can reduce the seriousness of injuries in a collision. Some of the worst injuries happen when people are thrown from the vehicle. Seat belts reduce the possibility of ejection and the risk of injury caused by striking the inside of the vehicle. **Everyone in a motor vehicle should be belted at all times.**

LAP/SHOULDER BELTS

All the seats in your vehicle are equipped with Lap/Shoulder Belts.

The belt webbing retractor is designed to lock during very sudden stops or collisions. This feature allows the shoulder part of the belt to move freely with you under

normal conditions. But in a collision, the belt will lock and reduce the risk of your striking the inside of the vehicle or being thrown out.

WARNING!

- **It is extremely dangerous to ride in a cargo area, inside or outside of a vehicle. In a collision, people riding in these areas are more likely to be seriously injured or killed.**
- **Do not allow people to ride in any area of your vehicle that is not equipped with seats and seat belts.**
- **Be sure everyone in your vehicle is in a seat and using a seat belt properly.**

WARNING!

- Wearing a seat belt incorrectly is dangerous. Seat belts are designed to go around the large bones of your body. These are the strongest parts of your body and can take the forces of a collision the best.
- Wearing your belt in the wrong place could make your injuries in a collision much worse. You might suffer internal injuries, or you could even slide out of part of the belt. Follow these instructions to wear your seat belt safely and to keep your passengers safe, too.

WARNING!

Two people should never be belted into a single seat belt. People belted together can crash into one another in an accident, hurting one another badly. Never use a lap/shoulder belt or lap belt for more than one person, no matter what their size.

2

Lap/Shoulder Belt Operating Instructions

1. Enter the vehicle and close the door. Sit back and adjust the seat.
2. The seat belt latch plate is above the back of the front seat, next to your arm. Grasp the latch plate and pull out the belt. Slide the latch plate up the webbing as far as necessary to allow the belt to go around your lap.

WARNING!

A shoulder belt placed behind you will not protect you from injury during a collision. You are more likely to hit your head in a collision if you do not wear your shoulder belt. The lap and shoulder belt are meant to be used together.

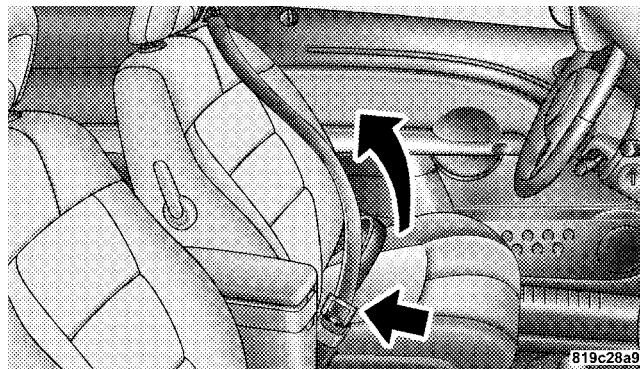

Removing Slack From Belt

3. When the belt is long enough to fit, insert the latch plate into the buckle until you hear a “click.”

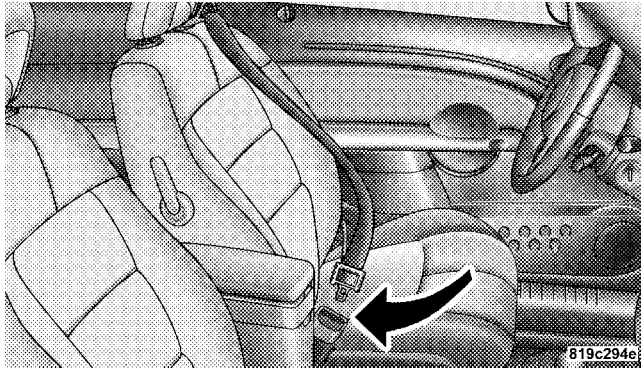

Latch Plate To Buckle

WARNING!

A belt that is worn under your arm is very dangerous. Your body could strike the inside surfaces of the vehicle in a collision, increasing head and neck injury. A belt worn under the arm can cause internal injuries. Ribs aren't as strong as shoulder bones. Wear the belt over your shoulder so that your strongest bones will take the force in a collision.

A belt that is too loose will not protect you as well. In a sudden stop you could move too far forward, increasing the possibility of injury. Wear your seat belt snugly.

4. Position the lap belt across your thighs, below your abdomen. To remove slack in the lap belt portion, pull up on the shoulder belt. To loosen the lap belt if it is too tight, tilt the latch plate and pull on the lap belt. A snug belt reduces the risk of sliding under the belt in a collision.

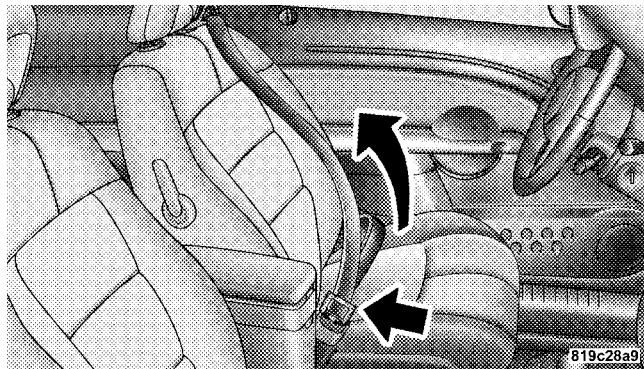

Removing Slack From Belt

WARNING!

- A lap belt worn too high can increase the risk of internal injury in a collision. The belt forces won't be at the strong hip and pelvic bones, but across your abdomen. Always wear the lap belt as low as possible and keep it snug.
- A twisted belt can't do its job as well. In a collision it could even cut into you. Be sure the belt is straight. If you can't straighten a belt in your vehicle, take it to your dealer and have it fixed.

5. Position the shoulder belt on your chest so that it is comfortable and not resting on your neck. The retractor will withdraw any slack in the belt.

6. To release the belt, push the red button on the buckle. The belt will automatically retract to its stowed position. If necessary, slide the latch plate down the webbing to allow the belt to retract fully.

WARNING!

A frayed or torn belt could rip apart in a collision and leave you with no protection. Inspect the belt system periodically, checking for cuts, frays, or loose parts. Damaged parts must be replaced immediately. Do not disassemble or modify the system. Seat belt assemblies must be replaced after a collision if they have been damaged (bent retractor, torn webbing, etc.).

Seat Belt Webbing Guide

NOTE: The manufacturer recommends that the seat belt is routed through the seat belt webbing guide when using the seat belt.

The seat belt webbing guide should be used to improve seat belt accessibility. The seat belt can be removed from the guide to allow for easier access to the rear seats.

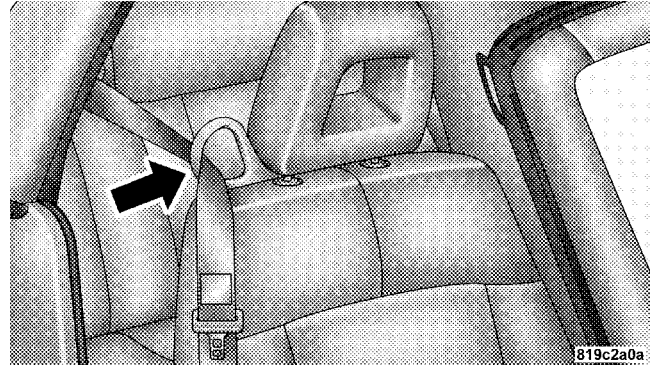

Seat Belt Webbing Guide

LAP/SHOULDER SEAT BELT UNTWISTING PROCEDURE

Use the following procedure to untwist a twisted lap/shoulder belt.

1. Position the latch plate as close as possible to the anchor point.
2. At about six to twelve inches (15 to 30 cm) above the latch plate, grasp and twist the belt webbing 180° to create a fold that begins immediately above the latch plate.
3. Slide the latch plate upward over the folded webbing. The folded webbing must enter the slot at the top of the latch plate.
4. Continue to slide the latch plate up until it clears the folded webbing.

SEAT BELT PRETENSIONERS

The seat belts for both front seating positions are equipped with pretensioning devices that are designed to remove slack from the seat belt in the event of a collision. These devices improve the performance of the seat belt by assuring that the belt is tight about the occupant early in a collision. Pretensioners work for all size occupants, including those in child restraints.

NOTE: These devices are not a substitute for proper seat belt placement by the occupant. The seat belt still must be worn snugly and positioned properly.

The pretensioners are triggered by the front airbag control module (see Airbag Section). Like the front airbags, the pretensioners are single use items. After a collision that is severe enough to deploy the airbags and pretensioners, both must be replaced.

ENHANCED SEAT BELT REMINDER SYSTEM (BELTALERT®)

If the driver's or front passenger's seat belt has not been buckled within 60 seconds of starting the vehicle and if the vehicle speed is greater than 5 mph (8 km/h), the Enhanced Warning System (BeltAlert®) will alert the driver or front passenger to buckle their seat belt. The driver should also instruct all other occupants to buckle their seat belts. Once the warning is triggered, the Enhanced Warning System (BeltAlert®) will continue to chime and flash the Seat Belt Warning Light for 96 seconds or until the driver's or front passenger's seat belt is buckled. The Enhanced Warning System (BeltAlert®) will be reactivated if the driver's or front passenger's seat belt is unbuckled for more than 10 seconds and the vehicle speed is greater than 5 mph (8 km/h).

NOTE:

- The Enhanced Warning System (BeltAlert®) can be enabled or disabled by your authorized dealer.
- DaimlerChrysler does not recommend deactivating the Enhanced Warning System (BeltAlert®).

If the Enhanced Warning System (BeltAlert®) is deactivated, the Seat Belt Warning Light will continue to illuminate while the driver seat belt remains unfastened.

SEAT BELTS AND PREGNANT WOMEN

We recommend that pregnant women use the seat belts throughout their pregnancy. Keeping the mother safe is the best way to keep the baby safe.

Pregnant women should wear the lap part of the belt across the thighs and as snug across the hips as possible. Keep the belt low so that it does not come across the abdomen. That way the strong bones of the hips will take the force if there is a collision.

DRIVER AND FRONT PASSENGER SUPPLEMENTAL RESTRAINT SYSTEM (SRS)

This vehicle has airbags for both the driver and front passenger as a supplement to the seat belt restraint systems. The driver's front airbag is mounted in the center of the steering wheel. The passenger's front airbag is mounted in the instrument panel, above the glove compartment. The words SRS AIRBAG are embossed on the airbag covers.

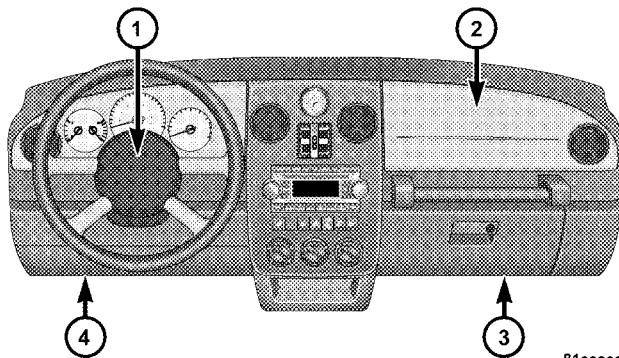

81caaee

Front Panel SRS Features

- | | |
|----------------------|----------------------------|
| 1 — Driver Airbag | 3 — Passenger Knee Blocker |
| 2 — Passenger Airbag | 4 — Driver Knee Blocker |

Head/Thorax airbags (if equipped) are located inside the driver and front passenger seats, and their covers are also labeled SRS AIRBAG.

NOTE: Airbag covers may not be obvious in the interior trim; but they will open to allow airbag deployment.

WARNING!

- Do not drill, cut or tamper with the knee blocker panel in any way.
- Do not mount any accessories to the knee blocker panel such as alarm lights, stereos, citizens band radios etc.

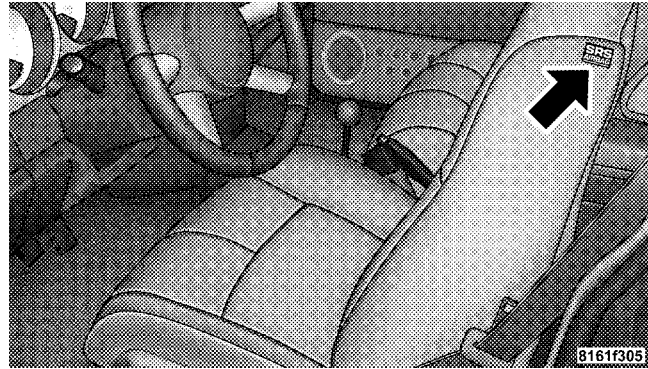

SRS Airbag Label

WARNING!

- **Do not put anything on or around the airbag covers or attempt to manually open them. You may damage the airbags and you could be injured because the airbags are not there to protect you. These protective covers for the airbag cushions are designed to open only when the airbags are inflating.**
- **If your vehicle is equipped with Head/Thorax airbags, do not use accessory seat covers or place objects between you and the side airbags; the performance could be adversely affected and/or objects could be pushed into you, causing serious injury.**

Airbags inflate in moderate to high speed impacts. Along with seat belts and pretensioners, front airbags work with knee impact blocker panels to provide improved protection for the driver and front passenger.

The seat belts are designed to protect you in many types of collisions. The front airbags deploy in moderate to severe frontal collisions. If your vehicle is equipped, the Head/Thorax airbag on the crash side of the vehicle is triggered in moderate to severe side collisions. In certain types of collisions, both the front seat and Head/Thorax airbags may be triggered. But even in collisions where the airbags work, you need the seat belts to keep you in the right position for the airbags to protect you properly.

NOTE: The passenger front airbag may not deploy even when the driver front airbag has if the Occupant Classification System (refer to "Occupant Classification System" in this section) has determined the passenger seat is

empty or is occupied by someone that is classified in the “child” category. This could be a child, a teenager, or even a small adult.

Here are some simple steps you can take to minimize the risk of harm from a deploying airbag.

1. Children 12 years old and under should always ride buckled up in a rear seat.

Infants in rear facing child restraints should **NEVER** ride in the front seat of a vehicle with a passenger front airbag. An airbag deployment can cause severe injury or death to infants in that position.

Children that are not big enough to properly wear the vehicle seat belt (see Section on Child Restraints) should be secured in the rear seat in child restraints or belt-positioning booster seats. Older children who do not use child restraints or belt-positioning booster seats should

ride properly buckled up in the rear seat. Never allow children to slide the shoulder belt behind them or under their arm.

You should read the instructions provided with your child restraint to make sure that you are using it properly.

2. All occupants should wear their lap and shoulder belts properly.
3. The driver and front passenger seats should be moved back as far as practical to allow the front airbags room to inflate.
4. If your vehicle has side airbags, do not lean against the door, airbags will inflate forcefully into the space between you and the door.
5. If the airbag system in this vehicle needs to be modified to accommodate a disabled person, contact the Customer Center. Phone numbers are provided under “If You Need Assistance” in Section 9 of this manual.

WARNING!

- **Relying on the airbags alone could lead to more severe injuries in a collision. The airbags work with your seat belt to restrain you properly. In some collisions the airbags won't deploy at all. Always wear your seat belts even though you have airbags.**
- **Being too close to the steering wheel or instrument panel during front airbag deployment could cause serious injury. Airbags need room to inflate. Sit back, comfortably extending your arms to reach the steering wheel or instrument panel.**
- **If the vehicle has Head/Thorax airbags, they also need room to inflate. Do not lean against the door. Sit upright in the center of the seat.**

The front airbag system consists of the following:

- Occupant Restraint Controller
- Side Remote Acceleration Sensors (If Equipped)
- Airbag Warning Light
- Driver Airbag
- Passenger Airbag
- Front Seat Mounted Head/Thorax Airbags (if equipped)
- Steering Wheel and Column
- Instrument Panel
- Driver and Front Passenger Knee Impact Blockers
- Front Acceleration Sensors
- Driver and Front Passenger Seat Belt Pretensioners
- Passenger Airbag Disable (PAD) Indicator Light

The Head/Thorax airbag system (if equipped) consists of the following:

- AIRBAG Readiness Light (shared with the front airbag system)
- Front Seat— side mounted Head/Thorax Airbags — if equipped
- Airbag Control Module (shared with the front airbag system)
- Side impact sensors

How The Airbag System Works

- The **Occupant Restraint Controller (ORC)** determines if a frontal collision is severe enough to require the airbags to inflate. The front airbag inflators are designed to provide different rates of airbag inflation from direction provided by the ORC. The ORC may

also modify the rate of inflation based on the occupant size provided by the Occupant Classification Module. The ORC will not detect roll over.

The ORC also monitors the readiness of the electronic parts of the system whenever the ignition switch is in the START or RUN positions. These include all of the items listed above except the steering wheel and column, and knee impact blockers. If the key is in the OFF position, in the ACC position, or not in the ignition, the airbags are not on and will not inflate.

During a moderate-to-severe rear impact the ORC may deploy the seat belt pretensioners alone.



Also, the ORC turns on the AIRBAG warning light and PAD indicator light in the instrument panel for six to eight seconds for a self-check when the ignition is first turned on. After the self-check, the AIRBAG warning light will turn off. The PAD indicator light will function normally (Refer to

"Passenger Airbag Disable (PAD) Indicator Light" in this section). If the ORC detects a malfunction in any part of the system, it turns on the AIRBAG warning light either momentarily or continuously. A single chime will sound if the light comes on again after initial start up.

WARNING!

Ignoring the AIRBAG light in your instrument panel could mean you won't have the airbags to protect you in a collision. If the light does not come on, stays on after you start the vehicle, or if it comes on as you drive, have the airbag system checked right away.

NOTE: Children 12 years and under should always ride buckled up in a rear seat in an appropriate child restraint.

- When the front airbag control module detects a collision requiring the front airbags, it signals the inflator

units. A large quantity of nontoxic gas is generated to inflate the front airbags. The front airbag covers separate and fold out of the way as the front airbags inflate to their full size. The front airbags fully inflate in about 50 milliseconds. This is only about half of the time it takes you to blink your eyes. The front airbags then quickly deflate while helping to restrain the driver and front passenger. The driver's and passenger's front airbag gas is vented through holes in the sides of the airbag. In this way the front airbags do not interfere with your control of the vehicle.

- The **Passenger Airbag Disable (PAD) Indicator Light** (an amber light located in the center of the instrument panel) tells the driver and front passenger when the front passenger airbag is turned off. The PAD Indicator lamp illuminates the words "PASS AIR BAG OFF" to show that the front passenger airbag will not inflate during a collision requiring airbags. When the right front passenger seat is empty or when very light

objects are placed on the seat, the passenger air bag will not inflate even though the PAD indicator lamp is not illuminated.

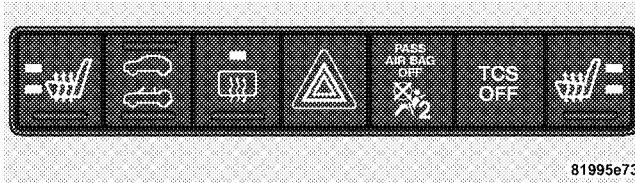

Passenger Airbag Disabled Light



- The PAD indicator light should not be illuminated when teenagers, most children in a forward facing child restraint or booster seats, most children that can properly wear the vehicle's seat belt, and when an adult passenger is properly seated in the front passenger seat. In this case, the air bag is ready to be inflated if a collision requiring an airbag occurs.

For all other occupants, the PAD indicator light will be illuminated indicating that the front passenger airbag is turned off and will not inflate.

NOTE: Even though this vehicle is equipped with an occupant classification system, children 12 years and under should always ride buckled up in a rear seat in an appropriate child restraint (see section on child restraints).

WARNING!

Never place a rear facing infant seat in front of an airbag. A deploying passenger airbag can cause death or serious injury to a child in a rear facing infant seat.

Passenger Airbag Disable (PAD) System		
Front Passenger	Indicator Light	Airbag Status
Adult	OFF	ON
Child	ON	OFF
Grocery Bags, Heavy Briefcases and Other Relatively Light Objects	ON	OFF
Empty or Very Small Objects	OFF*	OFF
* Since the system senses weight, some small objects will turn the PAD Indicator Light on.		

Drivers and adult passengers should verify that the PAD Indicator Light is not illuminated when an adult is riding in the front passenger seat. If an adult occupant's weight is transferred to another part of the vehicle (like the door or instrument panel), the weight sensors in the seat may

not properly classify the occupant. Objects lodged under the seat or between the seat and the center console can prevent the occupant's weight from being measured properly and may result in the occupant being improperly classified. Ensure that the front passenger seat back does not touch anything placed on the second row of seats because this can also affect occupant classification. Also, if you fold down the seats in the second row check to be sure they don't touch the front passenger seat.

If the front passenger seat is damaged in any way, it should only be serviced by an authorized dealer. If the seat is removed (or even if the seat attachment bolts are loosened or tightened in any way), take the vehicle to an authorized dealer.

If there is a fault present in the Airbag Warning Light (a red light located in the center of the instrument cluster directly in front of the driver) will be turned on. This

indicates that you should take the vehicle to an authorized dealer. The Airbag Warning Light is turned on whenever there is a fault that can affect the operation of the airbag system. If there is a fault present in the PAD Indicator Light the Airbag Warning Light remains illuminated to show that the passenger airbag is turned off until the fault is cleared. If an object is lodged under the seat and interferes with operation of the weight sensors, a fault will occur which turns on both the PAD Indicator Light and the Airbag Warning Light. Once the lodged object is removed, the fault will be automatically cleared after a short period of time.

- The **Driver and Passenger Airbag/Inflator Units** are located in the center of the steering wheel and the right side of the instrument panel. When the ORC detects a collision requiring the airbags, it signals the inflator units. A large quantity of nontoxic gas is generated to inflate the front airbags. Different airbag inflation rates

may be possible based on collision severity and occupant size. The steering wheel hub trim cover and the upper right side of the instrument panel separate and fold out of the way as the bags inflate to their full size. The bags fully inflate in about 50 - 70 milliseconds. This is about half of the time it takes to blink your eyes. The bags then quickly deflate while helping to restrain the driver and front passenger. The driver's and passenger's front airbag gas is vented through holes in the sides of the airbag. In this way the airbags do not interfere with your control of the vehicle.

- The **Occupant Classification Module (OCM)** is located beneath the front passenger seat. The OCM classifies the occupant into categories based on the measurements made by the seat weight sensors. The OCM communicates with the ORC. The ORC uses the occupant category to determine whether the front passenger airbag should be turned off. It also determines the rate of airbag inflation during a collision.

- Your vehicle has four **Weight Sensors** located between the seat and the floor pan. The weight sensors measure applied weight and transfers that information to the OCM.
- The **Head/Thorax Airbag and Supplemental Restraint Systems** are designed to activate only in certain side collisions. The ORC module determines if a side collision is severe enough to require the Head/Thorax airbags to inflate. The side airbag control module will not detect roll over, front or rear collisions.

The ORC Module monitors the readiness of the electronic parts of the system whenever the ignition switch is in the START or ON positions. These include all of the items listed under “**The Side Airbag System**”, **on vehicles equipped, consists of the following**”.

In moderate to severe side collisions, the side airbag inflator on the crash side of the vehicle is triggered, releasing a quantity of nontoxic gas. The inflating Head/

Thorax Airbags exit through the seat seam into the space between the occupant and the door. The Head/Thorax airbags moves at a very high speed and with such a high force, that it could injure you if you are not seated properly, or if items are positioned in the area where the side airbag inflates. This especially applies to children.

The following requirements must be strictly adhered to:

- Do not modify the front passenger seat assembly or components in any way.
- Do not modify the front seat center console or center position seat in any way.
- Do not use prior or future model year seat covers not designated for the specific model being repaired. Always use the correct seat cover specified for the vehicle.
- Do not replace the seat cover with an aftermarket seat cover.

- Do not add a secondary seat cover other than those approved by DaimlerChrysler/Mopar.
- At no time should any supplemental restraint system (SRS) component or SRS related component or fastener be modified or replaced with any part except those which are approved by DaimlerChrysler/Mopar.

WARNING!

Unapproved modifications or service procedures to the front passenger seat assembly, its related components, or seat cover may inadvertently change the airbag deployment in case of a frontal crash. This could result in death or serious injury to the front seat passenger if the vehicle is involved in an accident. A modified vehicle may not comply with required Federal Motor Vehicle Safety Standards (FMVSS).

If A Deployment Occurs

The airbag systems are designed to deploy when the airbag control modules detect a moderate-to-severe collision, to help restrain the driver and front passenger, and then immediately deflate.

NOTE: A collision that is not severe enough to need airbag protection will not activate the system. This does not mean something is wrong with the airbag system.

If you do have a collision which deploys the airbags, any or all of the following may occur:

- The nylon airbag material may sometimes cause abrasions and/or skin reddening to the driver and front passenger as the airbags deploy and unfold. The abrasions are similar to friction rope burns or those you might get sliding along a carpet or gymnasium floor. They are not caused by contact with chemicals. They are not permanent and normally heal quickly.

However, if you haven't healed significantly within a few days, or if you have any blistering, see your doctor immediately.

- As the airbags deflate you may see some smoke-like particles. The particles are a normal by-product of the process that generates the nontoxic gas used for airbag inflation. These airborne particles may irritate the skin, eyes, nose, or throat. If you have skin or eye irritation, rinse the area with cool water. For nose or throat irritation, move to fresh air. If the irritation continues, see your doctor. If these particles settle on your clothing, follow the garment manufacturer's instructions for cleaning.

- It is not advisable to drive your vehicle after the airbags have deployed. If you are involved in another collision, the airbags will not be in place to protect you.

WARNING!

Deployed airbags and seat belt pretensioners cannot protect you in another collision. Have the airbags, seat belt pretensioners, front passenger seat belt retractor assembly, and Occupant Classification System replaced and/or serviced by an authorized dealer as soon as possible.

Maintaining Your Airbag System

WARNING!

Modifications to any part of the airbag system could cause it to fail when you need it. You could be injured if the airbag system is not there to protect you. Do not modify the components or wiring, including adding any kind of badges or stickers to the steering wheel hub trim cover or the upper right side of the instrument panel. Do not modify the front bumper, vehicle body structure, or add aftermarket side steps or running boards.

WARNING!

Do not attempt to modify any part of your advanced airbag system. The airbag may inflate accidentally or may not function properly if modifications are made. Take your vehicle to an authorized dealer for any advanced airbag system service. If your seat including your trim cover and cushion needs to be serviced in any way (including removal or loosening/tightening of seat attachment bolts), take the vehicle to your authorized dealer. Only manufacturer approved seat accessories may be used. If it is necessary to modify an advanced airbag system for persons with disabilities, contact your authorized dealer.

WARNING!

- **Do not place or hang any items such as add-on video players on the right front passenger seat back. The additional weight may cause the Occupant Classification System to be unable to correctly classify the right front occupant. This could allow the passenger frontal airbag to inflate when it is not desired.**
- **You need proper knee impact protection in a collision. Do not mount or locate any aftermarket equipment on or behind the knee impact blocker panels.**
- **It is dangerous to try to repair any part of the airbag system yourself. Be sure to tell anyone who works on your vehicle that it has an airbag system.**

NOTE: Perchlorate Material – special handling may apply. See www.dtsc.ca.gov/hazardouswaste/perchlorate.”

Airbag Light

You will want to have the airbags ready to inflate for your protection in a collision. While the airbag system is designed to be maintenance free, if any of the following occurs, have an authorized dealer service the system immediately.

- The AIRBAG light does not come on during the six to eight seconds when the ignition switch is first turned on.
- The light remains on after the six to eight second interval.
- The light comes on and remains on while driving.

Event Data Recorder (EDR)

In the event of an accident, your vehicle is designed to record up to five seconds of specific vehicle data parameters (see list below) in an event data recorder prior to the moment of airbag deployment, or near-deployment, and up to a quarter second of high-speed deceleration data during and/or after air bag deployment or near-deployment. EDR data are ONLY recorded if an airbag deploys, or nearly deploys, and are otherwise unavailable.

NOTE:

1. A near-deployment event occurs when the airbag sensor detects severe vehicle deceleration usually indicative of a crash, but not severe enough to warrant airbag deployment.
2. Under certain circumstances, EDR data may not be recorded (e.g., loss of battery power).

In conjunction with other data gathered during a complete accident investigation, the electronic data may be used by DaimlerChrysler and others to learn more about the possible causes of crashes and associated injuries in order to assess and improve vehicle performance. In addition to crash investigations initiated by DaimlerChrysler, such investigations may be requested by customers, insurance carriers, government officials, and professional crash researchers, such as those associated with universities, and with hospital and insurance organizations.

In the event that an investigation is undertaken by DaimlerChrysler (regardless of initiative), the company or its designated representative will first obtain permission of the appropriate custodial entity for the vehicle (usually the vehicle owner or lessee) before accessing the electronic data stored, unless ordered to download data by a court with legal jurisdiction (i.e., pursuant to a warrant). A copy of the data will be provided to the

custodial entity upon request. General data that does not identify particular vehicles or crashes may be released for incorporation in aggregate crash databases, such as those maintained by the US government and various states. Data of a potentially sensitive nature, such as would identify a particular driver, vehicle, or crash, will be treated confidentially. Confidential data will not be disclosed by DaimlerChrysler to any third party except when:

1. Used for research purposes, such as to match data with a particular crash record in an aggregate database, provided confidentiality of personal data is thereafter preserved
2. Used in defense of litigation involving a DaimlerChrysler product
3. Requested by police under a legal warrant
4. Otherwise required by law

Data Parameters that May Be Recorded:

- Diagnostic trouble code(s) and warning lamp status for electronically-controlled safety systems, including the airbag system
- Airbag disable lamp status (if equipped)
- "Time" of airbag deployment (in terms of ignition cycles and vehicle mileage)
- Airbag deployment level (if applicable)
- Impact acceleration and angle
- Seatbelt status
- Brake status (service and parking brakes)
- Accelerator status (including vehicle speed)
- Engine control status (including engine speed)
- Transmission gear selection

- Cruise control status
- Traction/stability control status
- Tire pressure monitoring system status

CHILD RESTRAINT

Everyone in your vehicle needs to be buckled up at all times — babies and children, too. Every state in the United States and all Canadian provinces require that small children ride in proper restraint systems. This is the law, and you can be prosecuted for ignoring it.

Children 12 years and under should ride properly buckled up in a rear seat, if available. According to crash statistics, children are safer when properly restrained in the rear seats, rather than in the front.

WARNING!

In a collision, an unrestrained child, even a tiny baby, can become a missile inside the vehicle. The force required to hold even an infant on your lap could become so great that you could not hold the child, no matter how strong you are. The child and others could be badly injured. Any child riding in your vehicle should be in a proper restraint for the child's size.

Infants And Small Children

There are different sizes and types of restraints for children from newborn size to the child almost large enough for an adult safety belt. Always check the child seat owner's manual to ensure you have the correct seat for your child. Use the restraint that is correct for your child:

- Safety experts recommend that children ride rearward-facing in the vehicle until they are at least one year old and weigh at least 20 lbs (9 kg). Two types of child restraints can be used rearward-facing: infant carriers and "convertible" child seats. Both types of child restraints are held in the vehicle by the lap/shoulder belt or the LATCH child restraint anchorage system.
- This vehicle is not capable of accommodating the installation of a car bed used for carrying newborn babies at the right front passenger seat position. If a car bed must be used to transport a newborn baby, the car bed must be installed in the second seating row only.
- The infant carrier is only used rearward-facing in the vehicle. It is recommended for children who weigh up to about 20 lbs (9 kg). "Convertible" child seats can be used either rearward-facing or forward-facing in the vehicle. Convertible child seats often have a higher weight limit in the rearward-facing direction than infant carriers do, so they can be used rearward-facing by children who weigh more than 9 kg (20 lbs) but are less than one year old.
- Rearward-facing child seats must **NEVER** be used in the front seat of a vehicle with a front passenger airbag. An airbag deployment could cause severe injury or death to infants in this position.
- Children who weigh more than 20 lbs (9 kg) and who are older than one year can ride forward-facing in the vehicle. Forward-facing child seats and convertible child seats used in the forward-facing direction are for children who weigh 20 to 40 lbs (9 to 18 kg) and who are older than one year. These child seats are also held in the vehicle by the lap/shoulder belt or the LATCH child restraint anchorage system.

- The belt-positioning booster seat is for children weighing more than 40 lbs (18 kg), but who are still too small to fit the vehicle's seat belts properly. If the child cannot sit with knees bent over the vehicle's cushion while the child's back is against the seat back; they should use a Belt Positioning Booster Seat. The child and booster seat are held in the vehicle by the lap/shoulder belt. (Some booster seats are equipped with a front shield and are held in the vehicle by the lap portion.)

NOTE: For additional information refer to www.nhtsa.gov or www.seatcheck.org.

WARNING!

- **Improper installation can lead to failure of an infant or child restraint. It could come loose in a collision. The child could be badly injured or killed. Follow the manufacturer's directions exactly when installing an infant or child restraint.**
- **A rearward facing child restraint should only be used in a rear seat. A rearward facing child restraint in the front seat may be struck by a deploying passenger airbag which may cause severe or fatal injury to the infant.**

Here are some tips on getting the most out of your child restraint:

- Before buying any restraint system, make sure that it has a label certifying that it meets all applicable Safety

Standards. We also recommend that you make sure that you can install the child restraint in the vehicle where you will use it, before you buy it.

- The restraint must be appropriate for your child's weight and height. Check the label on the restraint for weight and height limits.
- Carefully follow the instructions that come with the restraint. If you install the restraint improperly, it may not work when you need it.

The passenger seat belts are equipped with seat belt retractors that can be switched to an automatic locking mode, which are designed to keep the lap portion tight around the child restraint so that it is not necessary to use a locking clip.

Pull the belt from the retractor until there is enough to allow you to pass through the child restraint and slide the latch plate into the buckle. Then pull on the belt until it is

all removed from the retractor. Allow the belt to return into the retractor, as the belt retracts, you will hear a clicking sound. This indicates that the seat belt is now in the automatic locking mode. Pull on the excess webbing to tighten the lap portion about the child restraint. Follow the instructions of the child restraint manufacture.

NOTE: To reset this feature you must let all of the belt webbing return into the retractor. You will not be able to pull out more webbing until all of the webbing has been returned back into the retractor.

- In the rear seat, you may have trouble tightening the lap/shoulder belt on the child restraint because the buckle or latch plate is too close to the belt path opening on the restraint. Disconnect the latch plate from the buckle and twist the short buckle end of the belt several times to shorten it. Insert the latch plate into the buckle with the release button facing out.

- If the belt still can't be tightened, or if by pulling and pushing on the restraint loosens the belt, disconnect the latch plate from the buckle, turn the latch plate around, and insert the latch plate into the buckle again. If you still can't make the child restraint secure, try a different seating position.
- Buckle the child into the seat according to the child restraint manufacturer's directions.
- When your child restraint is not in use, secure it in the vehicle with the seat belt or remove it from the vehicle. Don't leave it loose in the vehicle. In a sudden stop or collision, it could strike the occupants or seat backs and cause serious personal injury.

Lower Anchors and Tether for CHILDREN (LATCH)

Your vehicle is equipped with the child restraint anchorage system called LATCH, which stands for Lower Anchors and Tether for CHILDREN. The LATCH system provides for the installation of the child restraint without

using the vehicle seat belt. Both rear seating positions have exclusive lower anchorages located at the rear of the seat cushion. They are round bars, part of the seat and body structure, and are readily visible. In addition, there are two tether strap anchorages located behind the rear seat head form, in the convertible top storage area.

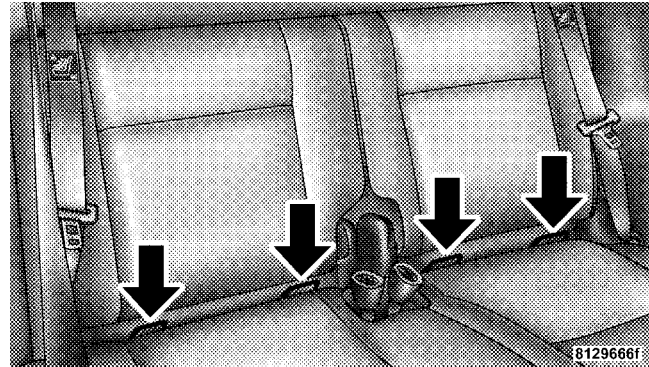

Latch Anchors

Child restraints systems having attachments designed to connect to the lower anchorages are now available. Child restraints having tether straps and hooks for connection to the top tether anchorage have been available for some time. In fact, many child restraint manufacturers will provide add-on tether strap kits for some of their older products. Tether anchorage kits are also available for most older vehicles.

Because the lower anchorages are to be introduced to passenger carrying vehicles over a period of years, child restraint systems having attachments for those anchorages will continue to have features for installation in vehicles using the lap or lap/shoulder belt. They will also have tether straps, and you are urged to take advantage of all of the available attachments provided with your child restraint in any vehicle.

NOTE: When using the LATCH attaching system to install a child restraint, please ensure that all seat belts

not being used for occupant restraints are stowed and out of reach of children. It is recommended that before installing the child restraint, buckle the seat belt so the seat belt is tucked behind the child restraint and out of reach. If the buckled seat belt interferes with the child restraint installation, instead of tucking the seat belt behind the child restraint, route the seat belt through the child restraint belt path and then buckle it. This should stow the seat belt out of the reach of an inquisitive child. Remind all children in the vehicle that the seat belts are not toys and should not be played with, and never leave your child unattended in the vehicle.

Installing the Child Restraint System

We urge that you carefully follow the directions of the manufacturer when installing your child restraint. Many, but not all, restraint systems will be equipped with separate straps on each side, with each having a hook or connector and a means for adjusting the tension in the strap. Forward-facing toddler restraints and some

rearward-facing infant restraints will also be equipped with a tether strap with a hook and means for adjusting the tension in the strap.

In general, you will first loosen the adjusters on the lower and tether straps so that you can more easily attach the hook or connector to the lower and tether anchorages. The tether strap should be routed over the center of the head form and attached to the tether anchor, located behind the rear seat head form, in the convertible top storage area. Then tighten all three straps as you push the child restraint rearward and downward into the seat.

NOTE: To gain access to the anchorages, locate the child tether anchorage decals on the carpet behind the rear seat head forms and use a small screwdriver to pry the carpet flap open. The carpet flap is attached in two different places.

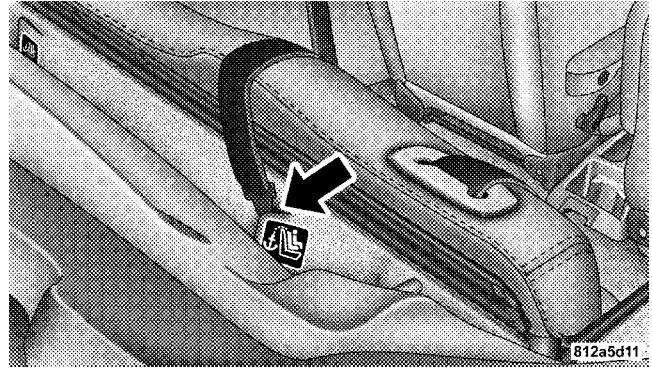

Tether Strap Mounting

Not all child restraint systems will be installed as we have described here. Again, carefully follow the instructions that come with the child restraint system.

NOTE: If your child restraint seat is not LATCH compatible, install the restraint using the vehicle seat belts.

WARNING!

An incorrectly anchored tether strap could lead to increased head motion and possible injury to the child. Use only the anchor position directly behind the child seat to secure a child restraint top tether strap.

Children Too Large For Booster Seats

Children who are large enough to wear the shoulder belt comfortably, and whose legs are long enough to bend over the front of the seat when their back is against the seat back, should use the lap/shoulder belt in a rear seat.

- Make sure that the child is upright in the seat.
- The lap portion should be low on the hips and as snug as possible.

- Check belt fit periodically. A child's squirming or slouching can move the belt out of position.
- If the shoulder belt contacts the face or neck, move the child closer to the center of the vehicle. Never allow a child to put the shoulder belt under an arm or behind their back.

Transporting Pets

Airbags deploying in the front seat could harm your pet. An unrestrained pet will be thrown about and possibly injured, or injure a passenger during panic braking or in a collision.

Pets should be restrained in the rear seat in pet harnesses or pet carriers that are secured by seat belts.

ENGINE BREAK-IN RECOMMENDATIONS

A long break-in period is not required for the engine in your vehicle.

Drive moderately during the first 300 mi (500 km). After the initial 60 mi (100 km), speeds up to 50 or 55 mph (80 or 90 km/h) are desirable.

While cruising, brief full-throttle acceleration, within the limits of local traffic laws, contributes to a good break-in. Wide-open throttle acceleration in low gear can be detrimental and should be avoided.

The engine oil installed in the engine at the factory is a high-quality energy-conserving type lubricant. Oil changes should be consistent with anticipated climate conditions under which vehicle operations will occur. For the recommended viscosity and quality grades, refer to "Maintenance Procedures" in Section 7 of this manual. **NON-DETERGENT OR STRAIGHT MINERAL OILS MUST NEVER BE USED.**

A new engine may consume some oil during its first few thousand miles (kilometers) of operation. This should be considered as a normal part of the break-in and not interpreted as an indication of difficulty.

SAFETY TIPS

Exhaust Gas

WARNING!

Exhaust gases can injure or kill. They contain carbon monoxide (CO) which is colorless and odorless. Breathing it can make you unconscious and can eventually poison you. To avoid breathing (CO) follow the safety tips below.

Do not run the engine in a closed garage or in confined areas any longer than needed to move your vehicle in or out of the area.

If it is necessary to sit in a parked vehicle with the engine running, adjust your heating or cooling controls to force outside air into the vehicle. Set the blower at high speed.

WARNING!

If you are required to drive with the deck lid/liftgate open, make sure that all windows are closed, and the climate control blower switch is set at high speed. DO NOT use the recirculation mode.

Safety Checks You Should Make Inside The Vehicle

Seat Belts

Inspect the belt system periodically, checking for cuts, frays and loose parts. Damaged parts must be replaced immediately. Do not disassemble or modify the system.

Front seat belt assemblies must be replaced after a collision. Rear seat belt assemblies must be replaced after a collision if they have been damaged (bent retractor, torn webbing, etc. If there is any question regarding belt or retractor condition, replace the belt.

Airbag Light

The light should come on and remain on for 6 to 8 seconds as a bulb check when the ignition switch is first turned ON. If the LED is not lit during starting, have it checked. If the light stays on or comes on while driving, have the system checked by an authorized dealer.

Defroster

Check operation by selecting the defrost mode and place the blower control on high speed. You should be able to feel the air directed against the windshield.

Periodic Safety Checks You Should Make Outside The Vehicle

Tires

Examine tires for excessive tread wear or uneven wear patterns. Check for stones, nails, glass, or other objects lodged in the tread. Inspect tread and sidewall for cuts or cracks. Check wheel nuts for tightness, and tires (including spare) for proper pressure.

Lights

Have someone observe the operation of exterior lights while you work the controls. Check turn signal and high beam indicator lights on the instrument panel.

Fluid Leaks

Check area under vehicle after overnight parking for fuel, engine coolant, oil or other fluid leaks. Also, if gasoline fumes are detected or fuel, power steering fluid or brake fluid leaks are suspected, the cause should be located and corrected immediately.

UNDERSTANDING THE FEATURES OF YOUR VEHICLE

CONTENTS

- Convertible Top Operation123
 - To Lower The Top123
 - To Raise The Top126
 - Convertible Top Boot Cover Installation-If Equipped128
 - Convertible Top Boot Cover Removal And Storage132
 - Convertible Top Manual Override134
- Mirrors135
 - Inside Day/Night Mirror — If Equipped135
 - Outside Mirror—Driver’s Side136
 - Outside Mirror—Passenger’s Side136
 - Electric Remote-Control Mirrors — If Equipped137
 - Illuminated Vanity Mirrors — If Equipped138
 - Sun Visor Sliding Feature138
- Hands-Free Communication (UConnect™) — If Equipped138
 - Operations140
 - Phone Call Features147

120 UNDERSTANDING THE FEATURES OF YOUR VEHICLE

- UConnect™ System Features 149
- Advanced Phone Connectivity 154
- Things You Should Know About Your UConnect™ System 155
- General Information 163
- Seats 164
 - Front Seat Adjustment 164
 - Power Seat Adjuster — If Equipped 165
 - Manual Lumbar — If Equipped 166
 - Folding Front Passenger Seat — If Equipped . . 167
 - Driver's Seat Back Tilt — If Equipped 167
 - Passenger Seat Back Tilt (Easy Entry System) — Convertible 168
 - Adjustable Head Restraints 169
 - Heated Seats — If Equipped 169
 - Folding Rear Seat (Sedan) 171
 - Folding Rear Seat (Convertible) 173
 - Tumbling Rear Seat (Sedan) 175
 - Tumbling Rear Seat (Convertible) 177
 - Rear Seat Removal (Sedan) 181
- To Open And Close The Hood 183
- Lights 184
 - Map/Reading Lights (Sedan) 184
 - Map/Reading Lights (Convertible) 185
 - Multi-Function Control Lever 186
 - Headlights, Parking Lights, Instrument Panel Lights 186
 - Daytime Running Lights (DRL) — If Equipped 187

<hr/>		UNDERSTANDING THE FEATURES OF YOUR VEHICLE	121
<input type="checkbox"/>	Lights-On Reminder		187
<input type="checkbox"/>	Fog Lights — If Equipped		188
<input type="checkbox"/>	Turn Signals		188
<input type="checkbox"/>	Highbeam/Lowbeam Select Switch		189
<input type="checkbox"/>	Passing Light		190
<input checked="" type="checkbox"/>	Windshield Wipers And Washers		190
<input type="checkbox"/>	Windshield Washers		191
<input type="checkbox"/>	Mist Feature		191
<input type="checkbox"/>	Windshield Wiper Operation		192
<input type="checkbox"/>	Intermittent Wiper System		192
<input checked="" type="checkbox"/>	Tilt Steering Column		193
<input checked="" type="checkbox"/>	Electronic Speed Control — If Equipped		194
<input type="checkbox"/>	To Activate		194
<input type="checkbox"/>	To Set At A Desired Speed		195
<input type="checkbox"/>	To Deactivate		195
<input type="checkbox"/>	To Resume Speed		195
<input type="checkbox"/>	To Vary The Speed Setting		195
<input type="checkbox"/>	Manual Transaxle		196
<input type="checkbox"/>	To Accelerate For Passing		196
<input checked="" type="checkbox"/>	Garage Door Opener — If Equipped		197
<input type="checkbox"/>	Programming HomeLink®		198
<input type="checkbox"/>	Gate Operator/Canadian Programming		201
<input type="checkbox"/>	Using HomeLink®		202
<input type="checkbox"/>	Reprogramming A Single HomeLink® Button		202
<input type="checkbox"/>	Security		202

122 UNDERSTANDING THE FEATURES OF YOUR VEHICLE

- Troubleshooting Tips203
- General Information203
- Power Sunroof (Sedan Only) — If Equipped204
 - Express Open Feature204
 - Wind Buffeting205
 - Sunroof Maintenance206
- Electrical Power Outlets206
 - Electrical Outlet Use With Engine Off208
- Console Features208
- Storage209
 - Center Console/Armrest Storage Bin209
 - Storage Pockets210
- Rear Shelf Panel— If Equipped210
 - Position 1 (Top)211
 - Position 2 (Middle)212
 - Position 3 (Floor)212
 - Position 4 (Vertical)212
 - Position 5 (Table)213
- Roof Luggage Rack — If Equipped215
- Rear Window Features217
 - Electric Rear Window Defroster217
 - Rear Wiper/Washer Switch (Sedan Models Only) — If Equipped217
 - Adding Washer Fluid218

CONVERTIBLE TOP OPERATION**WARNING!**

The convertible top does not provide the structural protection that a reinforced metal roof does, and the fabric top cannot be expected to prevent the ejection of the occupants of a vehicle in a collision. Therefore it is important that all occupants wear their seat belts at all times when riding in a convertible. Studies have shown that it is generally safer to remain inside a vehicle during a collision, than to be ejected from the vehicle.

To Lower The Top:

NOTE: Thoroughly dry the convertible top and top storage area, prior to leaving the top lowered for an extended period of time. This will help prevent possible mildew build-up.

CAUTION!

To avoid damage to the convertible top or its components, your vehicle is equipped with a feature that prevents convertible top operation at speeds over 10 mph (16 km/h).

CAUTION!

To fully insure that no damage occurs, be sure that the vehicle is at a complete stop with the gear selector in the Park position (automatic transaxle) or in the Neutral position (manual transaxle) before lowering or raising the top.

CAUTION!

Do not operate the convertible top with ice or snow build-up on the top. Damage to the top may occur.

CAUTION!

To avoid damage to either the top or the rear window, check the top storage area at the rear of the vehicle interior to be sure that it is clear of debris or other items. Be sure that child seat flip up bars are lowered. Do not use the top storage area for other storage purposes.

NOTE: When closing the convertible top all windows will drop slightly from the full up position.

1. Turn the ignition key to the ON position.
2. Release the top from the windshield header by pulling down on the latch handle and turning the latch handle clockwise until it stops.

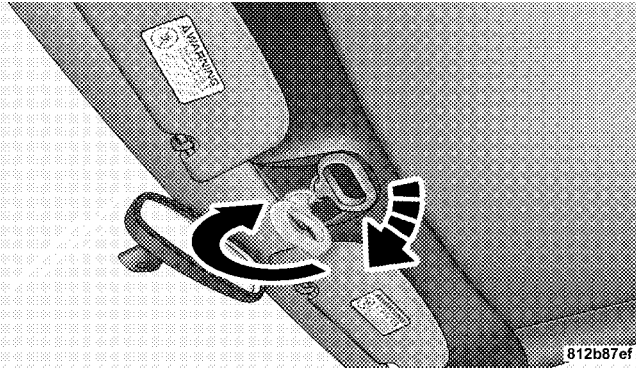

Releasing Convertible Top Latches

3. Press the Power Top Switch to lower the top just enough to disengage the top pins from the header, turn the handle counterclockwise and raise the handle to the stowed position.

NOTE: The Power Top Switch has two detent positions for lowering the convertible top. Pressing and holding

the Power Top Switch lightly in the first detent position will lower the windows slightly and the convertible top to the full down position. Pressing and holding the switch in the second detent position will lower all four windows completely and the top to the full down position.

3

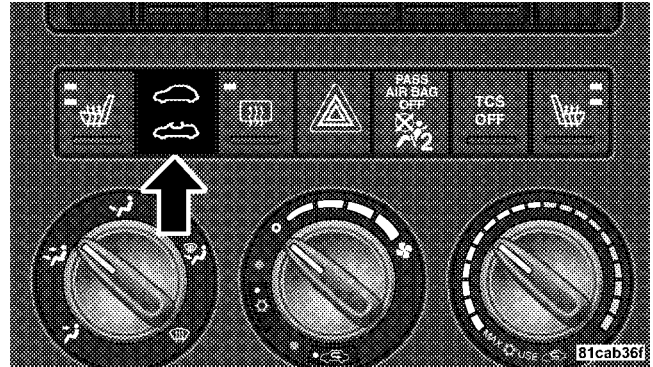

Convertible Top Switch

4. Continue pressing the Power Top Switch until the convertible top is lowered completely.
5. Install the Convertible Top Boot Cover, if equipped. Refer to Convertible Top Boot Cover Installation–If Equipped, in this section.

CAUTION!

Damage to the convertible top boot cover could result if the latch handle is not completely closed when the top is lowered. The convertible top boot cover cannot be installed while the latch handle is open.

To Raise The Top:

CAUTION!

To avoid damage to the convertible top or its components, your vehicle is equipped with a feature that prevents convertible top operation at speeds over 10 mph (16 km/h).

CAUTION!

To fully insure that no damage occurs, be sure that the vehicle is at a complete stop with the gear selector in the Park position (automatic transaxle) or in the Neutral position (manual transaxle) before lowering or raising the top.

1. Remove the convertible top boot cover, if equipped. Refer to Convertible Top Boot Cover Removal and Storage, in this section.
2. Turn the ignition to the ON position.
3. Press the Power Top Switch to raise the top. Before the top reaches the windshield, open the latch handle and turn the handle clockwise to open the latches. Press the switch again to continue raising the top until the two pins seat themselves in the windshield header.

NOTE: If the top is not latched right away, it may be necessary to press the power top switch, UP or DOWN quickly, to align the pins to the windshield header.

4. Pull down on the latch handle and rotate it counter-clockwise to engage the latches.

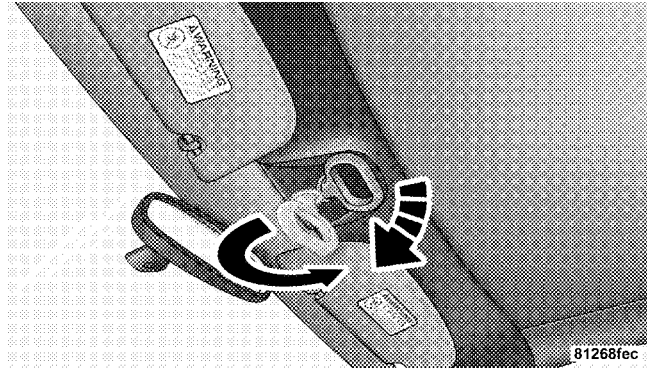

Engaging Convertible Top Latches

5. Raise the latch handle into the stowed position.

CAUTION!

Car top carriers, ski racks, etc., should not be attached to the convertible top mechanism as they will damage the top. Do not place objects on the convertible top, in the top well or on the sport bar. Damage to the convertible top may occur.

Convertible Top Boot Cover Installation—If Equipped

1. With the top down and the convertible top latch handle in the stowed position, lay the unfolded boot cover across the convertible top.



Convertible Top Latch Handle

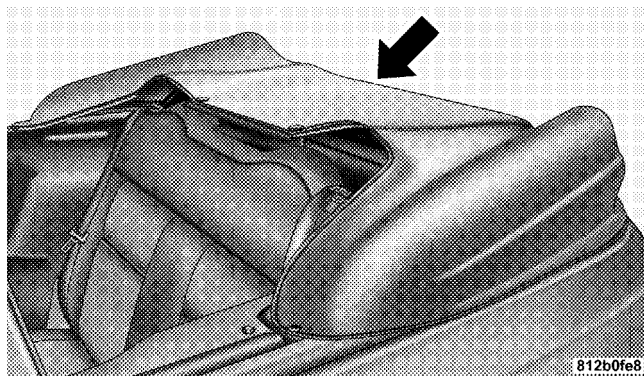

Boot Laying Across Convertible Top

2. Install the rear edge of the boot, first tucking the rear edge of the boot under the rear and both sides of the rails.

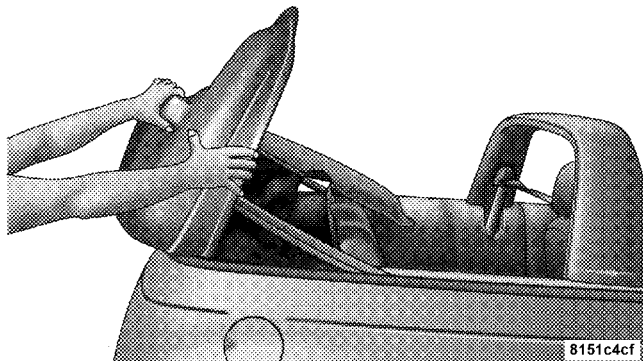

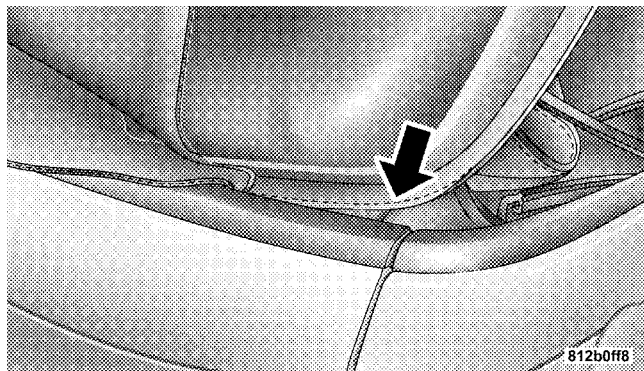

Tucking Boot Under Rail

3. Pull the right and left boot arms forward and engage both boot arm snaps. Make sure both snaps are fully engaged.

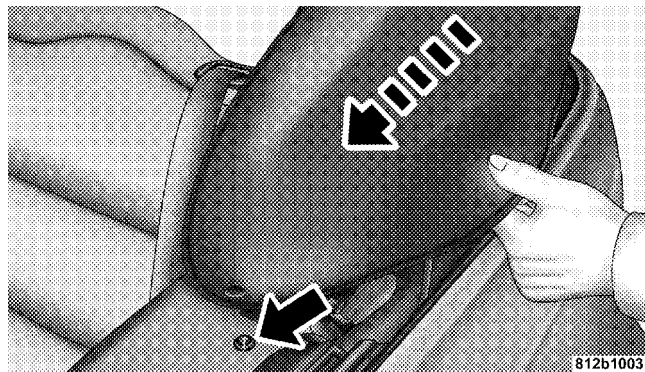

Engaging Boot Arm Snaps

4. Engage the boot center section retainer using the tabs provided.

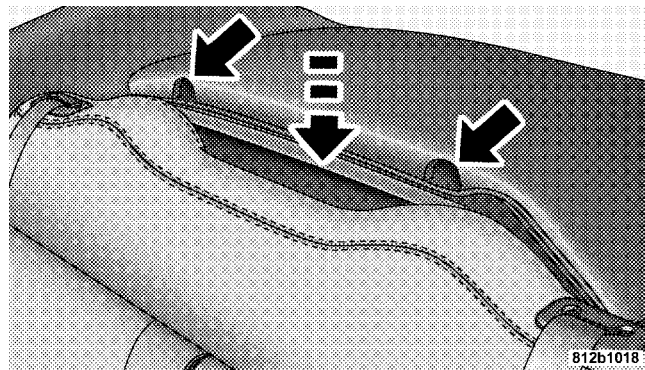

Engaging Boot Center Section

5. Tuck the rear flap of the boot in behind the Upper Moulding.

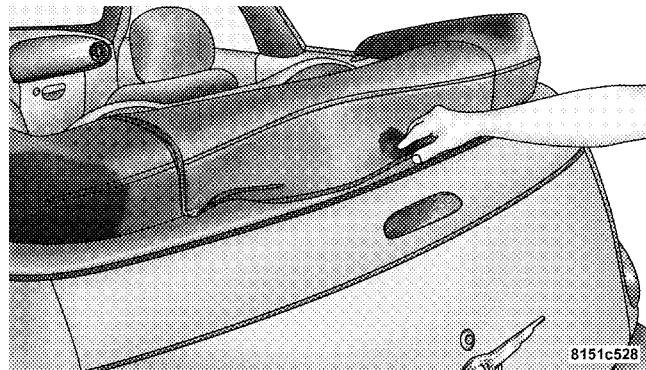

Tucking In Rear Flap

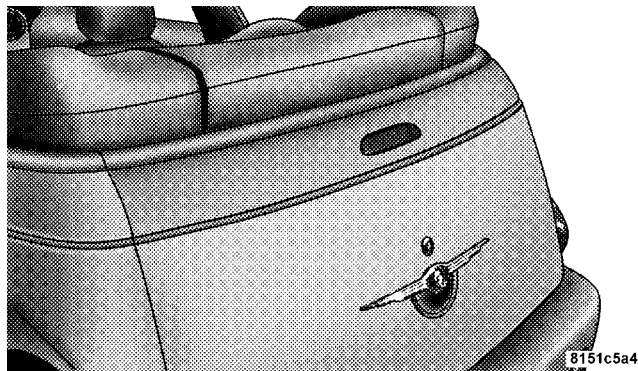

Convertible Top Boot Cover Removal and Storage

1. Unsnap the snaps and remove the top cover boot.
2. Lay the boot cover flat with the center section retainer facing the rear of the car.

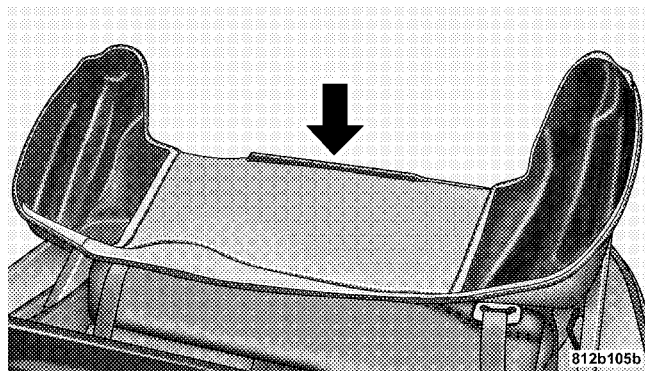

Boot Removed And Laying Flat

3. First fold the left side of the boot cover to the middle of the boot cover.

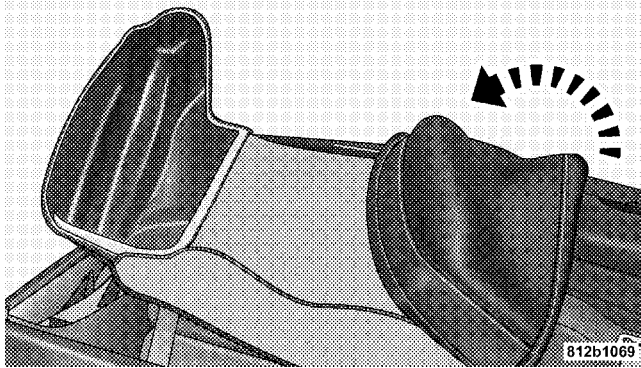

Folding Boot Cover Left Side

4. Second fold the right side of the boot cover to the middle, fitting it inside the left side of the boot cover and store it in the trunk or a dry secure area.

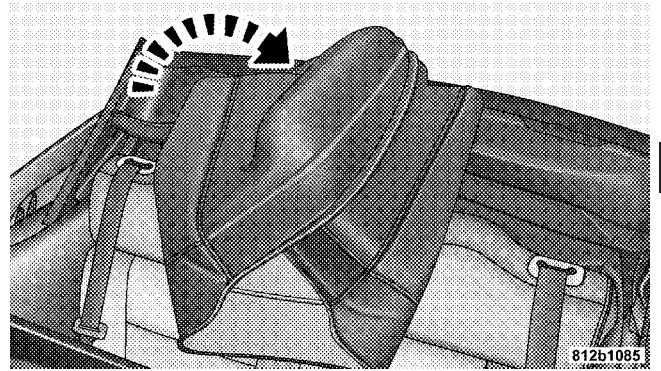

Folding Boot Cover Right Side

CAUTION!

Do not lay heavy objects on top of the boot or lay the boot on top of sharp/pointy objects. Damage could occur to the boot.

CONVERTIBLE TOP MANUAL OVERRIDE

If your vehicle is experiencing electrical failure (low battery, etc.) and it is necessary to raise the convertible top, perform the following steps:

1. Locate the convertible top motor bypass screw, which is found in the trunk under the convertible top storage area.
2. Turn the screw counterclockwise until the screw stops. This will relieve the hydraulic pressure and allow the convertible top to be raised manually.

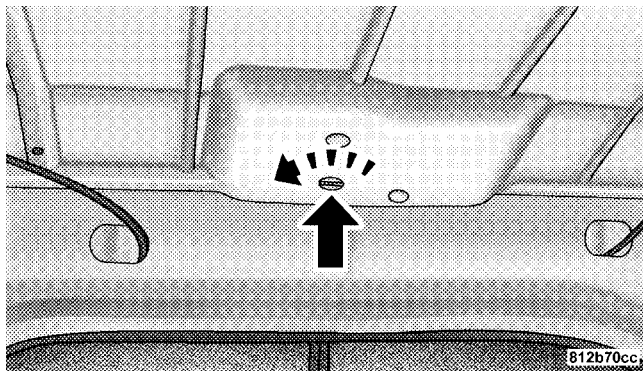

Bleeder Screw

3. Using the latch handle raise the top until the two pins seat themselves in the windshield header.
4. Rotate the latch handle clockwise to open the latches.
5. Pull down and rotate the handle counterclockwise to engage the latches.

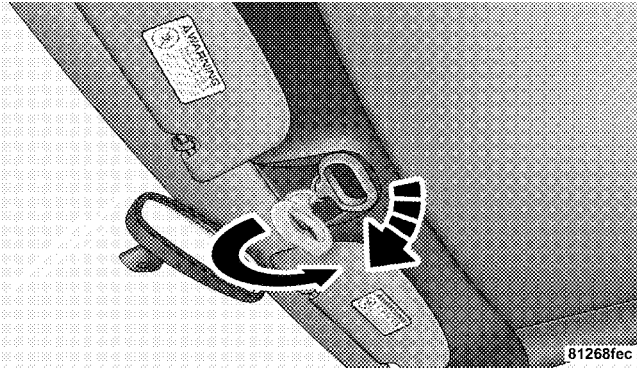

Engaging Convertible Top Latches

6. Raise the handle into the stowed position.

7. Close the convertible top motor bypass screw by turning the screw clockwise until it stops. Tighten the screw securely.

NOTE: Failure to tighten the bypass screw securely can cause convertible top operating concerns.

3

MIRRORS

Inside Day/Night Mirror — If Equipped

Adjust the mirror to center on the view through the rear window. A two point pivot system allows for horizontal and vertical mirror adjustment.

Annoying headlight glare can be reduced by moving the small control under the mirror to the night position (toward rear of vehicle). The mirror should be adjusted while set in the day position (toward windshield).

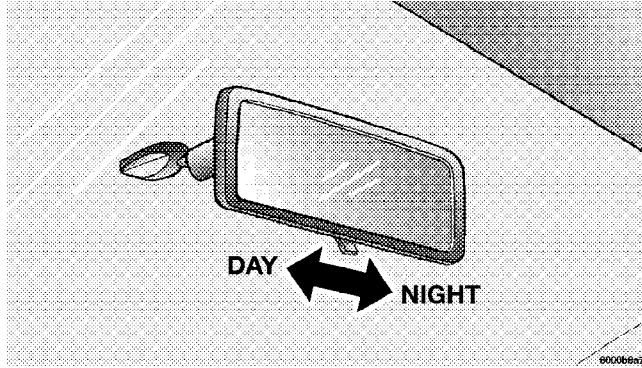

Adjusting Rearview Mirror

Outside Mirror—Driver's Side

Adjust the outside mirror to center on the adjacent lane of traffic, with a slight overlap of the view obtained on the inside mirror.

Outside Mirror—Passenger's Side

Adjust the convex outside mirror so you can just see the side of your vehicle in the part of the mirror closest to the vehicle.

WARNING!

Vehicles and other objects seen in the passenger side convex mirror will look smaller and farther away than they really are. Relying too much on your passenger side mirror could cause you to collide with another vehicle or other object. Use your inside mirror when judging the size or distance of a vehicle seen in this convex mirror.

Electric Remote-Control Mirrors — If Equipped

The power mirror switch is located to the left of the steering column on the instrument panel. To adjust the view in the outside mirrors, turn the rotary knob to the L (Left), O (Center) or R (Right) position. After selecting the mirror, move the knob in the same direction you want the mirror to move. Use the O (Center) position to guard against accidentally moving a mirror position.

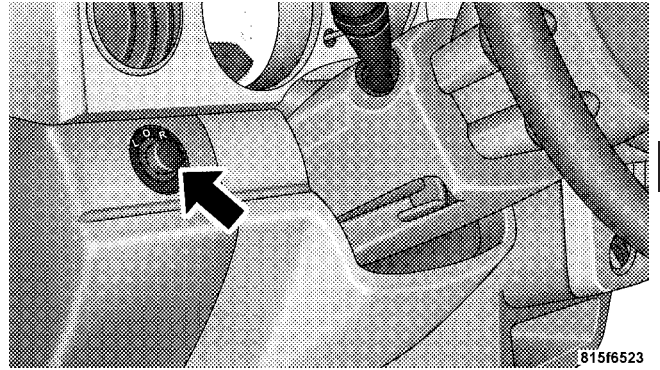
**Power Mirror Switch**

Illuminated Vanity Mirrors — If Equipped

An illuminated vanity mirror is on the sun visor. To use the mirror, rotate the sun visor down and swing the mirror cover upward. The lights turn on automatically. Closing the mirror cover turns off the lights.

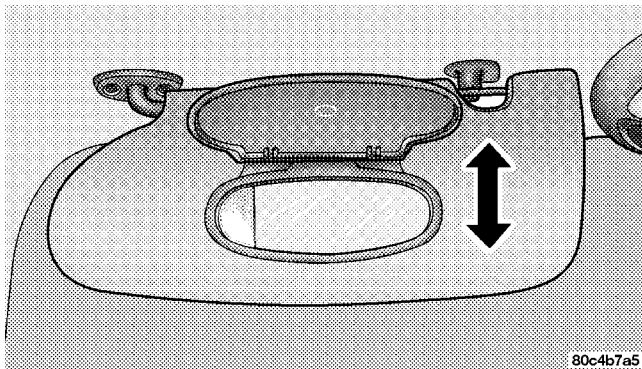

Illuminated Vanity Mirror

NOTE: The driver vanity mirror will become inoperable when the vehicle alarm is enabled.

NOTE: The passenger vanity mirror will become inoperable if left on for more than 10 minutes.

Sun Visor Sliding Feature

The sun visors may be pulled out to provide extended coverage of the side glass.

HANDS-FREE COMMUNICATION (UConnect™) — IF EQUIPPED

UConnect™ is a voice-activated, hands-free, in-vehicle communications system. UConnect™ allows you to dial a phone number with your cellular phone using simple voice commands (e.g., "Call" ... "Mike" ... "Work" or "Dial" ... "248-555-1212"). Your cellular phone's audio is transmitted through your vehicle's audio system; the system will automatically mute your radio when using the UConnect™ system.

NOTE: The UConnect™ system use requires a cellular phone equipped with the Bluetooth "Hands-Free Profile," version 0.96 or higher. See www.chrysler.com/uconnect for supported phones.

UConnect™ allows you to transfer calls between the system and your cellular phone as you enter or exit your vehicle, and enables you to mute the system's microphone for private conversation.

The UConnect™ phonebook enables you to store up to 32 names and four numbers per name. Each language has a separate 32-name phonebook accessible only in that language. This system is driven through your Bluetooth™ Hands-Free profile cellular phone. UConnect™ features Bluetooth™ technology - the global standard that enables different electronic devices to connect to each other without wires or a docking station, so UConnect works no matter where you stow your cellular phone (be it your purse, pocket, or briefcase), as long as your phone is turned on and has been paired to the

vehicle's UConnect™ system. The UConnect™ system allows up to seven cellular phones to be linked to system. Only one linked (or paired) cellular phone can be used with the system at a time. The system is available in English, Spanish, or French languages (as equipped).

The rearview mirror contains the microphone for the system and the control buttons that will enable you to access the system.



UConnect® Switches

8105b20d

The UConnect™ system can be used with any Hands-Free Profile certified Bluetooth™ cellular phone. See www.chrysler.com/uconnect for supported phones. If your cellular phone supports a different profile (e.g., Headset Profile), you may not be able to use any UConnect™ features. Refer to your cellular service provider or the phone manufacturer for details.

The UConnect™ system is fully integrated with the vehicle's audio system. The volume of the UConnect™ system can be adjusted either from the radio volume control knob, or from the steering wheel radio control (right switch), if so equipped.

The radio display will be used for visual prompts from the UConnect™ system such as "CELL" or caller ID on certain radios.

Operations

Voice commands can be used to operate the UConnect™ system and to navigate through the UConnect™ menu structure. Voice commands are required after most UConnect™ system prompts. You will be prompted for a specific command and then guided through the available options.

- Prior to giving a voice command, one must wait for the voice on beep, which follows the "Ready" prompt or another prompt.
- For certain operations, compound commands can be used. For example, instead of saying "Setup" and then "Phone Pairing," the following compound command can be said: "Setup Phone Pairing."
- For each feature explanation in this section, only the combined form of the voice command is given. You can also break the commands into parts and say each part of the command, when you are asked for it. For

example, you can use the combined form voice command "Phonebook New Entry," or you can break the combined form command into two voice commands: "Phonebook" and "New Entry." Please remember, the UConnect™ system works best when you talk in a normal conversational tone, as if speaking to some one sitting eight feet away from you.

Voice Command Tree

Refer to "Voice Tree" at the end of this section.

Help Command

If you need assistance at any prompt, or if you want to know your options at any prompt, say "Help" following the voice on beep. The UConnect™ system will play all the options at any prompt if you ask for help.

To activate the UConnect™ system from idle, simply press the 'Phone' button and follow audible prompts for directions. All UConnect™ system sessions begin with a press of the 'Phone' button on the mirror.

Cancel Command

At any prompt, after the voice on beep, you can say "Cancel" and you will be returned to the main menu. However, in a few instances the system will take you back to the previous menu.

Pair (Link) UConnect™ System to a Cellular Phone

To begin using your UConnect™ system, you must pair your compatible Bluetooth™ enabled cellular phone.

NOTE: The UConnect™ system use requires a cellular phone equipped with the Bluetooth "Hands-Free Profile," version 0.96 or higher. See www.chrysler.com/uconnect for supported phones.

To complete the pairing process, you will need to reference your cellular phone owner's manual. One of the following vehicle specific websites may also provide detailed instructions for pairing with the brand of phone that you have:

NOTE:

- www.chrysler.com/uconnect
- www.dodge.com/uconnect
- www.jeep.com/uconnect

The following are general phone to UConnect™ System pairing instructions:

- Press the 'Phone' button to begin.
- After the "Ready" prompt and the following beep, say "Setup Phone Pairing" and follow the audible prompts.
- When prompted, after the voice on beep, say "Pair a Phone" and follow the audible prompts.
- You will be asked to say a four-digit pin number, which you will later need to enter into your cellular. You can enter any four-digit pin number. You will not need to remember this pin number after the initial pairing process.
- For identification purposes, you will be prompted to give the UConnect™ system a name for your cellular phone. Each cellular phone that is paired should be given a unique phone name.
- You will then be asked to give your cellular phone a priority level between 1 and 7, 1 being the highest priority. You can pair up to seven cellular phones to your UConnect™ system. However, at any given time, only one cellular phone can be in use, connected to your UConnect™ System. The priority allows the UConnect™ system to know which cellular phone to use if multiple cellular phones are in the vehicle at the same time. For example, if priority 3 and priority 5 phones are present in the vehicle, the UConnect™ system will use the priority 3 cellular phone when you make a call. You can select to use a lower priority cellular phone at any time (refer to "Advanced Phone Connectivity").

Call/Dial by Saying a Number

- Press the 'Phone' button to begin.
- After the "Ready" prompt and the following beep, say "Dial."
- System will prompt you to say the number you want call.
- For example, you can say "234-567-8901." The phone number that you enter must be of valid length and combination. Based on the Country in which the vehicle was purchased, the UConnect™ limits the user from dialing invalid combination of numbers. For example, in USA, 234-567-890 is nine digits long, which is not a valid USA phone number - the closest valid phone number has ten digits.
- The UConnect™ system will confirm the phone number and then dial. The number will appear in the display of certain radios.

Call/Dial by Saying a Name

- Press the "Phone" button to begin.
- After the "Ready" prompt and the following beep, say "Dial" or Call."
- System will prompt you to say the name of the person you want call.
- After the "Ready" prompt and the following beep, say the name of the person you want to call. For example, you can say "John Doe," where John Doe is a previously stored name entry in the UConnect™ phonebook. Refer to "Add Names to Your UConnect™ Phonebook," to learn how to store a name in the phonebook.
- The UConnect™ system will confirm the name and then dial the corresponding phone number, which may appear in the display of certain radios.

Add Names to Your UConnect™ Phonebook

NOTE: Adding names to phonebook is recommended when vehicle is not in motion.

- Press the “Phone” button to begin.
- After the “Ready” prompt and the following beep, say “Phonebook New Entry.”
- When prompted, say the name of the new entry. Use of long names helps the voice recognition and is recommended. For example, say “Robert Smith” or “Robert” instead of “Bob.”
- When prompted, enter the number designation (e.g., “Home,” “Work,” “Mobile,” or “Pager”). This will allow you to store multiple numbers for each phonebook entry, if desired.
- When prompted, recite the phone number for the phonebook entry that you are adding.

After you are finished adding an entry into the phonebook, you will be given the opportunity to add more phone numbers to the current entry or to return to the main menu.

The UConnect™ system will allow you to enter up to 32 names in the phonebook with each name having up to four associated phone numbers and designations. Each language has a separate 32-name phonebook accessible only in that language.

Edit Entries in the UConnect™ Phonebook

NOTE: Editing phonebook entries is recommended when vehicle is not in motion.

- Press the ‘Phone’ button to begin.
- After the “Ready” prompt and the following beep, say “Phonebook Edit.”

- You will then be asked for the name of the phonebook entry that you wish to edit.
- Next, choose the number designation (home, work, mobile, or pager) that you wish to edit.
- When prompted, recite the new phone number for the phonebook entry that you are editing.

After you are finished editing an entry in the phonebook, you will be given the opportunities to edit another entry in the phonebook, call the number you just edited, or return to the main menu.

"Phonebook Edit" can be used to add another phone number to a name entry that already exists in the phonebook. For example, the entry John Doe may have a mobile and a home number, but you can add John Doe's work number later using the "Phonebook Edit" feature.

Delete Entries in the UConnect™ Phonebook

NOTE: Editing phonebook entries is recommended when vehicle is not in motion.

- Press the 'Phone' button to begin.
- After the "Ready" prompt and the following beep, say "Phonebook Delete."
- After you enter the Phonebook Delete menu, you will then be asked for the name of the entry that you wish to delete. You can either say the name of a phonebook entry that you wish to delete or you can say "List Names" to hear a list of the entries in the phonebook from which you choose. To select one of the entries from the list, press the "Voice Recognition" button while the UConnect™ system is playing the desired entry and say "Delete."

- After you enter the name, the UConnect™ system will ask you which designation you wish to delete, home, work, mobile, or pager. Say the designation you wish to delete.
- Note that only the phonebook entry in the current language is deleted.

After confirmation, the phonebook entries will be deleted. Note that only the phonebook in the current language is deleted.

Delete All Entries in the UConnect™ Phonebook

- Press the 'Phone' button to begin.
- After the "Ready" prompt and the following beep, say "Phonebook Erase All."
- The UConnect™ system will ask you to verify that you wish to delete all the entries from the phonebook.

- After confirmation, the phonebook entries will be deleted.

List All Names in the UConnect™ Phonebook

- Press the 'Phone' button to begin.
- After the "Ready" prompt and the following beep, say "Phonebook List Names."
- The UConnect™ system will play the names of all the phonebook entries.
- To call one of the names in the list, press the "Voice Recognition" button during the playing of the desired name, and then say "Call." NOTE: the user can also exercise "Edit" or "Delete" operations at this point.
- The UConnect™ system will then prompt you as to number designation you wish to call.
- The selected number will be dialed.

Phone Call Features

The following features can be accessed through the UConnect™ system if the feature(s) are available on your cellular service plan. For example, if your cellular service plan provides three-way calling, this feature can be accessed through the UConnect™ system. Check with your cellular service provider for the features that you have.

Answer or Reject an Incoming Call - No Call Currently in Progress

When you receive a call on your cellular phone, the UConnect™ system will interrupt the vehicle audio system, if on, and will ask if you would like to answer the call. To reject the call, press and hold the 'Phone' button until you hear a single beep indicating that the incoming call was rejected.

Answer or Reject an Incoming Call - Call Currently in Progress

If a call is currently in progress and you have another incoming call, you will hear the same network tones for call waiting that you normally hear when using your cell phone. Press the 'Phone' button to place the current call on hold and answer the incoming call.

NOTE: The UConnect™ system compatible phones in market today do not support rejecting an incoming call when another call is in progress. Therefore, the user can only either answer an incoming call or ignore it.

Making a Second Call while Current Call in Progress

To make a second call while you are currently in a call, press the 'Voice Recognition' button and say "Dial" or "Call" followed by the phone number or phonebook entry you wish to call. The first call will be on hold while the

second call is in progress. To go back to the first call, refer to "Toggling Between Calls." To combine two calls, refer to "Conference Call."

Place/Retrieve a Call from Hold

To put a call on hold, press the 'Phone' button until you hear a single beep. This indicates that the call is on hold. To bring the call back from hold, press and hold the 'Phone' button until you hear a single beep.

Toggling Between Calls

If two calls are in progress (one active and one on hold), press the 'Phone' button until you hear a single beep indicating that the active and hold status of the two calls have switched. Only one call can be placed on hold at one time.

Conference Call

When two calls are in progress (one active and one on hold), press and hold the 'Phone' button until you hear a double beep indicating that the two calls have been joined into one conference call.

Three-Way Calling

To initiate three-way calling, press the 'Voice Recognition' button while a call is in progress and make a second phone call as described under "Making a Second Call while Current Call in Progress." After the second call has established, press and hold the 'Phone' button until you hear a double beep indicating that the two calls have been joined into one conference call.

Call Termination

To end a call in progress, momentarily press the 'Phone' button. Only the active call(s) will be terminated and if there is a call on hold, it will become the new active call. If the active call is terminated by the far end, a call on

hold may not become active automatically. This is cell phone dependent. To bring the call back from hold, press and hold the 'Phone' button until you hear a single beep.

Redial

- Press the 'Phone' button to begin.
- After the "Ready" prompt and the following beep, say "Redial."
- The UConnect™ system will call the last number that was dialed on your cellular phone. Note: this may not be the last number dialed from the UConnect™ system.

Call Continuation

Call continuation is progression of a phone call on UConnect™ system after the vehicle ignition key has been switched to off. Call continuation functionality available on the vehicle can be any one of three types:

- After ignition key is switched off, a call can continue on the UConnect™ system either until the call ends or until the vehicle battery condition dictates cessation of the call on the UConnect™ system and transfer of the call to the mobile phone.
- After ignition key is switched to off, a call can continue on the UConnect™ system for certain duration, after which the call is automatically transferred from the UConnect™ system to the mobile phone.
- An active call is automatically transferred to the mobile phone after ignition key is switched to off.

UConnect™ System Features

Language Selection

To change the language that the UConnect™ system is using,

- Press the 'Phone' button to begin.

- After the "Ready" prompt and the following beep, say the name of the language you wish to switch to (English, Espanol, or Francais, if so equipped).
- Continue to follow the system prompts to complete language selection.

After selecting one of the languages, all prompts and voice commands will be in that language.

NOTE: After every UConnect™ language change operation, only the language specific 32-name phonebook is usable. The paired phone name is not language specific and usable across all languages.

For command translations and alternate commands in supported languages, refer to "Command Translations" at the end of this section.

Emergency Assistance

If you are in an emergency and the mobile phone is reachable:

- Pick up the phone and manually dial the emergency number for your area.

If the phone is not reachable and the UConnect™ system is operational, you may reach the emergency number as follows:

- Press the 'Phone' button to begin.
- After the "Ready" prompt and the following beep, say "Emergency" and the UConnect™ system will instruct the paired cellular phone to call the emergency number. This feature is only supported in the USA.

NOTE: The emergency number dialed is based on the Country where the vehicle is purchased (911 for USA and Canada and 060 for Mexico). The number dialed may not be applicable with the available cellular service and area.

The UConnect™ system does slightly lower your chances of successfully making a phone call as compared to that for the cell phone directly.

Your phone must be turned on and paired to the UConnect™ system to allow use of this vehicle feature in emergency situations when the cell phone has network coverage and stays paired to the UConnect™ system.

Towing Assistance

If you need towing assistance,

- Press the 'Phone' button to begin.
- After the "Ready" prompt and the following beep, say "Towing Assistance."

NOTE: The Towing Assistance number dialed is based on the Country where the vehicle is purchased (1-800-528-2069 for USA, 1-877-213-4525 for Canada, 55-14-3454 for Mexico city and 1-800-712-3040 for outside Mexico city in Mexico).

Please refer to the 24-Hour "Towing Assistance" coverage details in the Warranty information booklet and on the 24-Hour Towing Assistance Card.

Paging

To learn how to page, refer to "Working with Automated Systems." Paging works properly except for pagers of certain companies which time-out a little too soon to work properly with the UConnect™ system.

Voice Mail Calling

To learn how to access your voice mail, refer to "Working with Automated Systems."

Working with Automated Systems

This method is designed to be used in instances where one generally has to press numbers on the cellular phone keypad while navigating through an automated telephone system.

You can use your UConnect™ system to access a voice-mail system or an automated service, such as, paging service or automated customer service. Some services require immediate response selection, in some instances, that may be too quick for use of UConnect™ system.

When calling a number with your UConnect™ system that normally requires you to enter in a touch-tone sequence on your cellular phone keypad, you can push the 'Voice Recognition' button and say the sequence you wish to enter followed by the word "Send." For example, if required to enter your pin number followed with a pound 3 7 4 6 #, you can press the 'Voice Recognition' button and say "3 7 4 6 # Send." Saying a number, or sequence of numbers, followed by "Send" is also to be used to navigate through an automated customer service center menu structure and to leave a number on a pager.

Barge In - Overriding Prompts

The 'Voice Recognition' button can be used when you wish to skip part of a prompt and issue your voice recognition command immediately. For example, if a prompt is playing "Would you like to pair a phone, clear a...," you could press the 'Voice Recognition' button and say "Pair a Phone" to select that option without having to listen to the rest of the voice prompt.

Turning Confirmation Prompts On/Off

Turning confirmation prompts off will stop the system from confirming your choices (e.g., the UConnect™ system will not repeat a phone number before you dial it).

- Press the 'Phone' button to begin.
- After the "Ready" prompt and the following beep, say "Setup Confirmations." The UConnect™ system will play the current confirmation prompt status and you will be given the choice to change it.

Phone and Network Status Indicators

If available on the radio and/or on a premium display such as the instrument panel cluster, and supported by your cell phone, the UConnect™ system will provide notification to inform you of your phone and network status when you are attempting to make a phone call using UConnect™. The status is given for roaming network signal strength, phone battery strength, etc.

Dialing Using the Cellular Phone Keypad

You can dial a phone number with your cellular phone keypad and still use the UConnect™ system (while dialing via the cell phone keypad, the user must exercise caution and take precautionary safety measures). By dialing a number with your paired Bluetooth™ cellular phone, the audio will be played through your vehicle's audio system. The UConnect™ system will work the same as if you dial the number using voice recognition.

NOTE: Certain brands of mobile phones do not send the dial ring to the UConnect™ system to play it on the vehicle audio system, so you will not hear it. Under this situation, after successfully dialing a number, the user may feel that the call did not go through even though the call is in progress. Once your call is answered, you will hear the audio.

Mute/Un-mute (Mute off)

When you mute the UConnect™ system, you will still be able to hear the conversation coming from the other party, but the other party will not be able to hear you. In order to mute the UConnect™ system:

- Press the 'Voice Recognition' button.
- After the "Ready" prompt and the following beep, say "Mute."

In order to un-mute the UConnect™ system:

- Press the 'Voice Recognition' button.
- After the "Ready" prompt and the following beep, say "Mute-off."

Information Service

When using AT&T Wireless Service, dialing to phone number "#121," you can access voice activated automated system to receive news, weather, stocks, traffic, etc. related information.

Advanced Phone Connectivity**Transfer Call to and from Cellular Phone**

The UConnect™ system allows on going calls to be transferred from your cellular phone to the UConnect™ system without terminating the call. To transfer an ongoing call from your UConnect™ paired cellular phone to the UConnect™ system or vice-versa, press the 'Voice Recognition' button and say "Transfer Call."

Connect or Disconnect Link Between the UConnect™ System and Cellular Phone

Your cellular phone can be paired with many different electronic devices, but can only be actively "connected" with one electronic device at a time.

If you would like to connect or disconnect the Bluetooth™ connection between a UConnect™ paired cellular phone and the UConnect™ system, then follow the instruction described in your cellular phone user's manual.

List Paired Cellular Phone Names

- Press the 'Phone' button to begin.
- After the "Ready" prompt and the following beep, say "Setup Phone pairing".
- When prompted, say "List Phones."
- The UConnect™ system will play the phone names of all paired cellular phones in order from the highest to the lowest priority. To "select" or "delete" a paired phone being announced, press the 'Voice recognition' button and say "Select" or "Delete." Also, see the next two sections for an alternate way to "select" or "delete" a paired phone.

Select another Cellular Phone

This feature allows you to select and start using another phone with the UConnect™ system. The phone must have been previously paired to the UConnect™ system that you want to use it with.

- Press the 'Phone' button to begin.
- After the "Ready" prompt and the following beep, say "Setup Select Phone" and follow the prompts.
- You can also press the 'Voice Recognition' button anytime while the list is being played, and then choose the phone that you wish to select.
- The selected phone will be used for the next phone call. If the selected phone is not available, the UConnect™ system will return to using the highest priority phone present in or near (approximately within 30 feet) the vehicle.

Delete UConnect™ Paired Cellular Phones

- Press the 'Phone' button to begin.
- After the "Ready" prompt and the following beep, say "Setup Phone Pairing."
- At the next prompt, say "Delete" and follow the prompts.
- You can also press the 'Voice Recognition' button anytime while the list is being played and then choose the phone you wish to delete.

Things You Should Know About Your UConnect™ System

Voice Training

For users experiencing difficulty with the system recognizing their voice commands or numbers, the UConnect system Voice Training feature may be used. To enter this

training mode, follow one of the two procedures: From outside the UConnect mode (e.g. from radio mode),

- Press and hold the 'Voice Recognition' button for 5 seconds until the session begins, or
- Press the 'Voice Recognition' button and say "Setup, Voice Training" command.

Repeat the words and phrases when prompted by the UConnect System. For best results, the Voice Training session should be completed when the vehicle is parked, engine running, all windows closed, and the blower fan switched off.

This procedure may be repeated with a new user. The system will adapt to the last trained voice only.

To restore the Voice recognition system to factory default settings, enter the Voice Training session via the above procedure and follow the prompts.

Voice Recognition (VR)

- Always wait for the beep before speaking.
- Speak normally, without pausing, just as you would speak to a person sitting approximately eight (8) feet away from you.
- Make sure that no one other than you is speaking during a voice recognition period.
- Performance is maximized under:
 - low-to-medium blower setting,
 - low-to-medium vehicle speed,
 - low road noise,
 - smooth road surface,
 - fully closed windows,
 - dry weather condition.

- In a convertible vehicle, the system performance may be compromised with roof top down.
- Even though the system is designed for users speaking in North American English, French, and Spanish accents, the system may not always work for some.
- When navigating through an automated system, such as voice mail, or when sending a page at the end of speaking the digit string, make sure to say "send."
- Storing names in phonebook when vehicle is not in motion is recommended.
- It is not recommended to store similar sounding names in the UConnect™ phonebook.
- UConnect™ phonebook nametag recognition rate is optimized for the voice of the person who stored the name in the phonebook.
- You can say "O" (letter "O") for "0" (zero). "800" must be spoken "eight-zero-zero."
- Even though international dialing for most number combinations is supported, some shortcut dialing number combinations may not be supported.

Far End Audio Performance

- Audio quality is maximized under:
 - low-to-medium blower setting,
 - low-to-medium vehicle speed,
 - low road noise,
 - smooth road surface,
 - fully closed windows, and
 - dry weather condition.
- Operation from driver seat.

- In a convertible vehicle, the system performance may be compromised with roof top down.
- Performance, such as audio clarity, echo, and loudness to a large degree rely on the phone and network, and not the UConnect™ system.
- Echo at far end can sometime be reduced by lowering the in-vehicle audio volume.

Bluetooth Communication Link

Occasionally, Cellular phones have been found to lose connection to the UConnect™ system. When this happens, the connection can generally be re-established by switching the phone off/on. Your cell phone is recommended to remain in Bluetooth "on" mode.

Power-Up

After switching the ignition key from OFF to either ON or ACC position, or after a reset, you must wait at least five (5) seconds prior to using the system.

Voice Command Tree

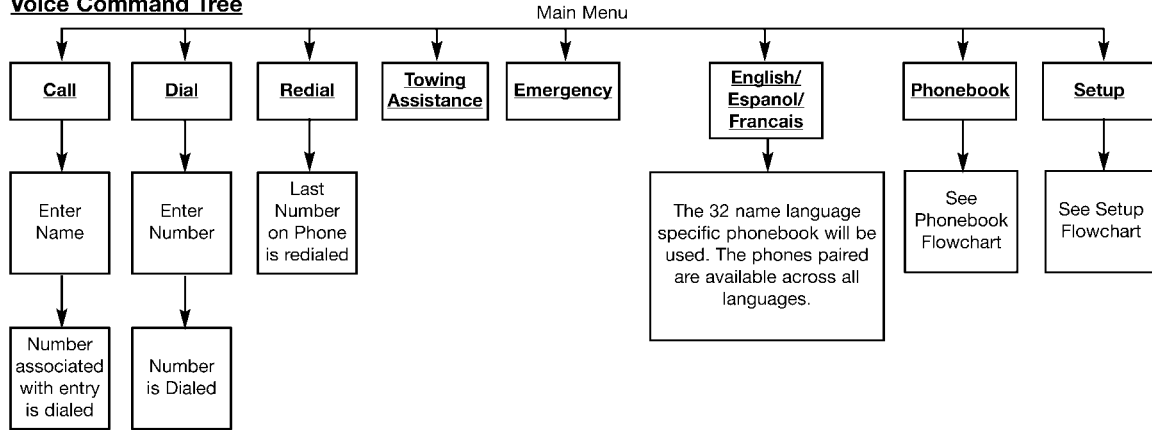

Note: Available Voice commands are shown in bold face and are underlined.

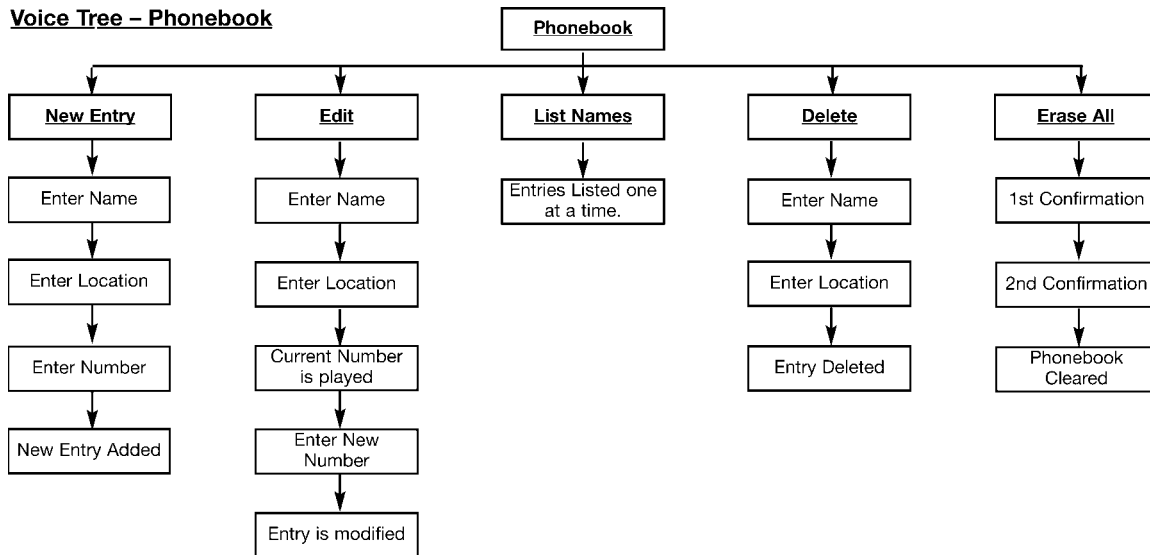
Voice Tree – Phonebook

Note: Available Voice commands are shown in bold face and are underlined.

Voice Tree – Setup

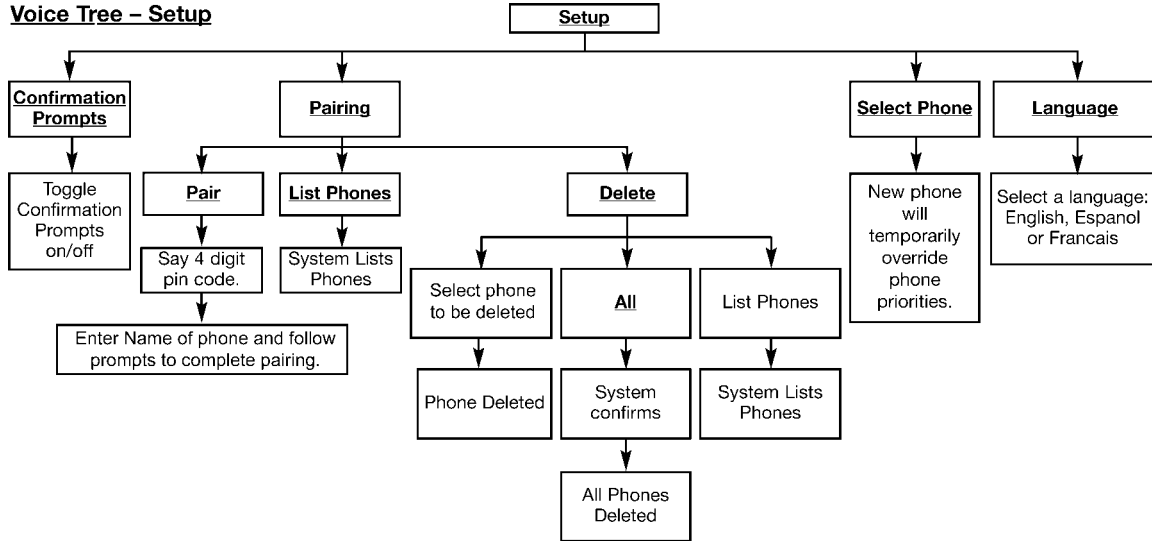

Note: Available Voice commands are shown in bold face and are underlined.

North American English	
Primary	Alternate(s)
Zero	
One	
Two	
Three	
Four	
Five	
Six	
Seven	
Eight	
Nine	
Star (*)	
Plus (+)	
Pound (#)	
Add Location	
All	

Call	
Cancel	
Confirmation Prompts	
Continue	
Delete	
Dial	
Edit	
Emergency	
English	
Erase All	
Espanol	
Francais	
Help	
Home	
Language	
List names	
List phones	

Mobile	
Mute	
Mute off	
New entry	
No	
Pager	
Pair a phone	
Phone pairing	Pairing
Phonebook	Phone book
Previous	
Record again	
Redial	
Return to main menu	Return. Main menu
Select phone	Select
Send	
Set up	Phone settings / Phone set up

Towing assistance	
Transfer call	
Try again	
Voice training	
Work	
Yes	

General Information

This device complies with part 15 of the FCC rules and RSS 210 of Industry Canada. Operation is subject to the following conditions:

- This device may not cause harmful interference.
- This device must accept any interference received, including interference that may cause undesired operation.

SEATS

FRONT SEAT ADJUSTMENT

The adjusting bar is at the front of the seats, near the floor. Pull the bar up to move the seat to the desired position.



Manual Adjustment Bar

Using body pressure, move forward and rearward on the seat to be sure the seat adjusters have latched.

WARNING!

- **Adjusting a seat while the vehicle is moving is dangerous. The sudden movement of the seat could cause you to lose control. The seat belt might not be properly adjusted and you could be injured. Adjust the seat only while the vehicle is parked.**
- **Do not ride with the seatback reclined so that the shoulder belt is no longer resting against your chest. In a collision you could slide under the seat belt and be seriously or even fatally injured. Use the recliner only when the vehicle is parked.**

POWER SEAT ADJUSTER — IF EQUIPPED**WARNING!**

Do not ride with the seatback reclined so that the seat belt is no longer resting against your chest. In a collision you could slide under the seat belt and be seriously or even fatally injured. Use the recliner only when the vehicle is parked.

Six-Way Power Seat with Manual Recliner

The seat switch is on the outboard side of the seat near the floor. Use this switch to move the seat up or down, forward or rearward, or to tilt the seat.

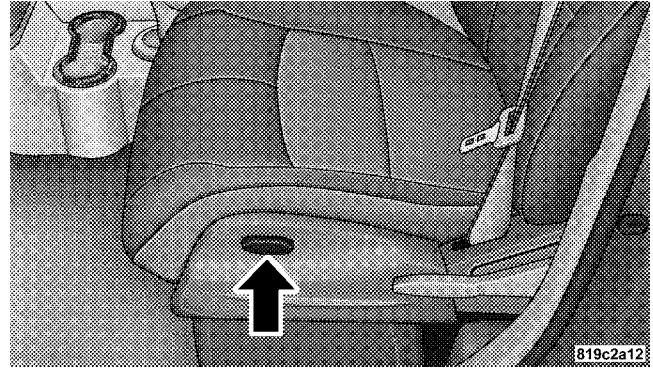
**Power Seat Switch**

This seat also has a manual recline lever located just to the rear of the power seat switch. To recline, lean forward slightly before lifting the lever, then lean back to the desired position and release the lever. Lean forward and lift the lever to return the seatback to its normal position.

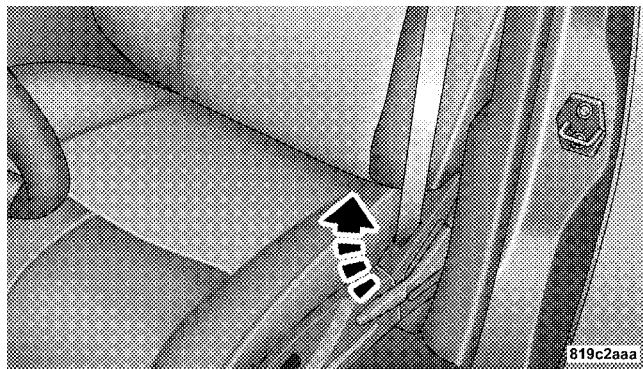

Recliner Control Lever

MANUAL LUMBAR — IF EQUIPPED

The Lumbar adjustment is located on the inboard side of the driver's seat. To increase support, rotate the handle down.

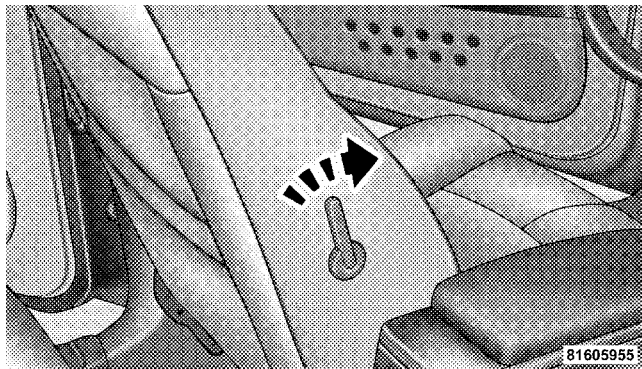

Lumbar Adjust Handle

FOLDING FRONT PASSENGER SEAT — IF EQUIPPED

The passenger front seat may be folded fully forward to provide additional cargo space.

To fold the seat forward pull up on the recliner lever located on the outboard side of the seat.

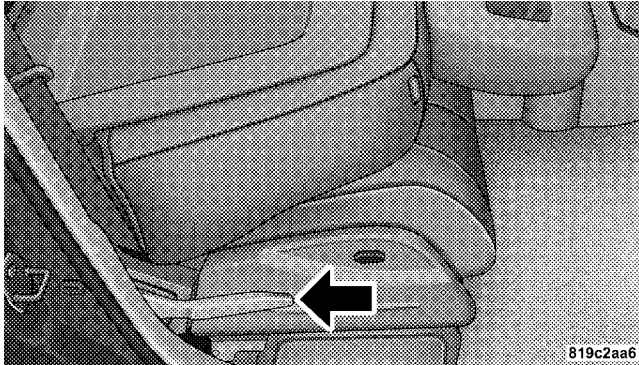

Folding Seat Control Lever

DRIVER'S SEAT BACK TILT — IF EQUIPPED

How to operate the driver's seat:

1. Push the lever down until seat back releases.
2. Push the seat back forward.
3. To return seat to a sitting position, push seat back rearward.

NOTE: The driver's front seat has a full recliner memory, which will allow the seat back to return to its original position.

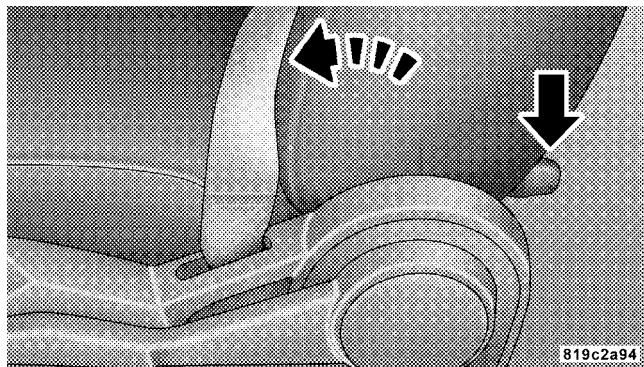

Driver's Seat Back Tilt Lever

PASSENGER SEAT BACK TILT (EASY ENTRY SYSTEM) — CONVERTIBLE

How to operate the passenger front seat:

1. Push the lever down until seat back releases.
2. Push seat back forward until it slides toward the dashboard.

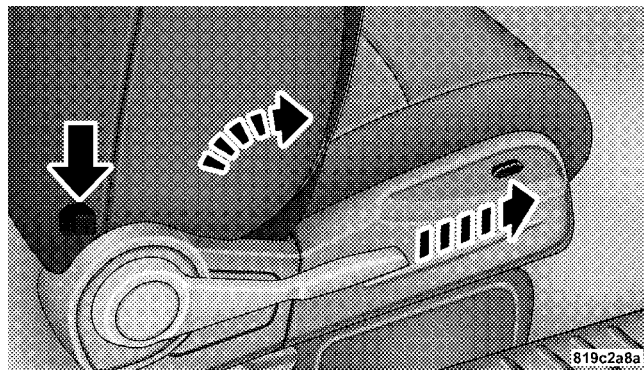

Passenger Seat Back Tilt Lever

3. To return seat to a sitting position, rotate seat back upright until it locks.
4. Push seat rearward until the track locks.

NOTE: The passenger front seat has a full recliner memory, which will allow the seat back to returned to its original position.

NOTE: The passenger front seat has a track memory, which returns the seat to just past the half way point of the track regardless of original position.

ADJUSTABLE HEAD RESTRAINTS

Head restraints can reduce the risk of whiplash injury in the event of impact from the rear. Pull up or push down on the head restraints so that the upper edge is as high as practical. To raise the head restraint, pull up on the head restraint. To lower the head restraint, push in the button that is part of the head restraint rod guide, and push down on the head restraint.

HEATED SEATS — IF EQUIPPED

WARNING!

Persons who are unable to feel pain to the skin because of advanced age, chronic illness, diabetes, spinal cord injury, medication, alcohol use, exhaustion or other physical condition must exercise care when using the seat heater. It may cause burns even at low temperatures, especially if used for long periods of time. Do not place anything on the seat that insulates against heat, such as a blanket or cushion. This may cause the seat heater to overheat.

CAUTION!

Do not place anything on the seat that insulates against heat, such as a blanket or cushion. This may cause the seat heater to overheat. To avoid heated seat surfaces coming in contact and potential seat overheating, ALWAYS ensure that the seat heater is in the OFF position (amber lights are on for HIGH or LOW and no amber lights for the OFF position) before placing any of the seats into a folded flat position.

Heated seats provide comfort and warmth when needed for the front driver's and passenger's seats. The heaters provide the same average heat level for both seat and back cushions. The controls for each heater are located near the bottom center of the instrument panel.



81995e73

Heated Seat Switches

With the ignition switch in the on or run position, you may choose from HIGH, LOW, or OFF heat settings. Amber LEDs on the side of each switch indicate the level of heat in use. Two LEDs are illuminated for HIGH, one for LOW, and none for OFF. Pressing the switch once will select the HIGH setting. Pressing the switch a second time, will select the LOW setting. Pressing the switch a third time, will turn the heating elements OFF.

When the HIGH setting is selected, the heater will provide a boosted heat level during the first four minutes of operation. Then, the heat output will drop to the normal HIGH temperature level. If the HIGH setting is selected, the system will automatically switch to LOW after 30 minutes of continuous operation. At that time, the number of illuminated LEDs changes from two to one, indicating the change. The LOW setting will turn off automatically after 30 minutes.

NOTE: Once a heat setting is selected, heat will be felt within two to five minutes.

FOLDING REAR SEAT (SEDAN)

To provide additional storage area, each rear seatback can be folded forward. Push and hold the buttons shown in the picture to fold down either or both seatbacks.

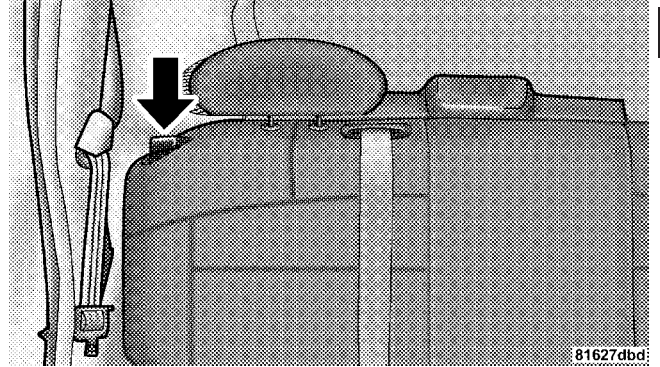

Folding Rear Seat Button

WARNING!

- **It is extremely dangerous to ride in a cargo area, inside or outside of a vehicle. In a collision, people riding in these areas are more likely to be seriously injured or killed.**
- **Do not allow people to ride in any area of your vehicle that is not equipped with seats and seat belts**
- **Be sure that everyone in your vehicle is in a seat and using a seat belt properly.**

NOTE:

- If the rear center lap/shoulder belt appears to be locked into place, check to verify that the seatback is fully latched.

- If the seatback is properly latched and the rear center lap/shoulder belt still does not operate properly check and see if the Automatic Locking retractor (ALR) system is activated.

WARNING!

The rear center lap/shoulder belt is equipped with a lock-out feature to ensure that the seatback is in the fully upright and locked position when occupied. If the rear seatback is not fully upright and locked and the rear center lap/shoulder belt can be pulled out of the retractor, the vehicle should immediately be taken to your dealer for service. Failure to follow this warning could result in serious or fatal injury.

FOLDING REAR SEAT (CONVERTIBLE)

To provide additional storage area, each rear seatback can be folded forward. The seat back release knobs are located in the trunk area. Pull the left side seatback release knob to fold down the left side seatback. Pull the right side seatback release knob to fold down the right side seatback.

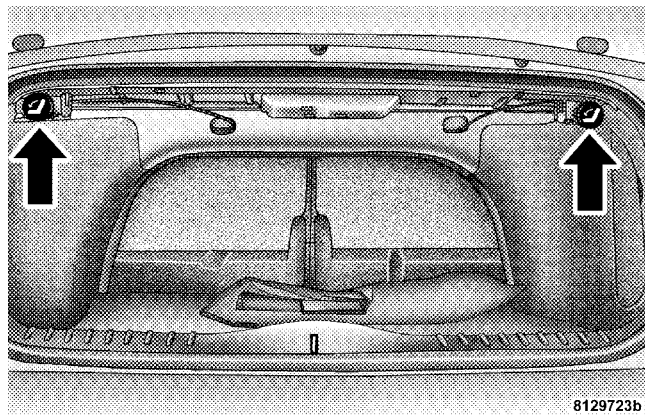

3

Folding Rear Seat Release Knobs

WARNING!

- **It is extremely dangerous to ride in a cargo area, inside or outside of a vehicle. In a collision, people riding in these areas are more likely to be seriously injured or killed.**
- **Do not allow people to ride in any area of your vehicle that is not equipped with seats and seat belts.**
- **Be sure that everyone in your vehicle is in a seat and using a seat belt properly.**

NOTE: Prior to lifting either seatback to the upright position, be sure that the seat belt is brought forward to avoid trapping it behind the seatback.

CAUTION!

Ensure that the seat back is latched with a hard push to engage the latch, noting the presence of seat back rubber-overslam bumpers that need to be overcome. Check that the seat back release knobs are pushed fully forward in order to allow the latch to engage.

TUMBLING REAR SEAT (SEDAN)

To provide additional storage in the cargo area, each rear seat can be tumbled forward.

CAUTION!

It is important that the front seats be pulled forward to the midpoint of the seat track to avoid contact between the rear seat and the front seatback. If the front seat is not pulled forward the two seats will make contact during the tumbling motion and cause damage to the rear seat material. After the rear seat is tumbled forward and secured the front seat can then be repositioned to the preferred position.

- Push and hold the button on the seatback and fold down the rear seatback.

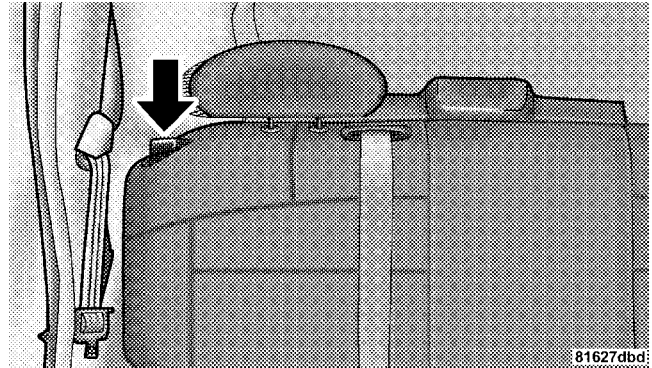

3

Folding Rear Seat Button

- Pull the release handle located on the outboard side of the seat. Lift up the seat and tumble the seat forward.

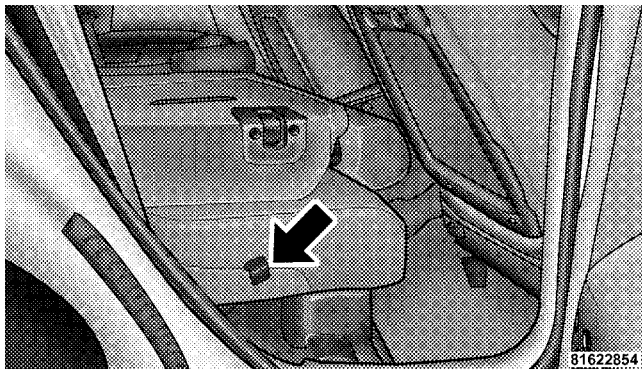

Tumbling Seat Release Strap

- Attach the elastic strap, located at the base of the seat cushion, onto the hook bar on the center trim panel to hold the seat in place.

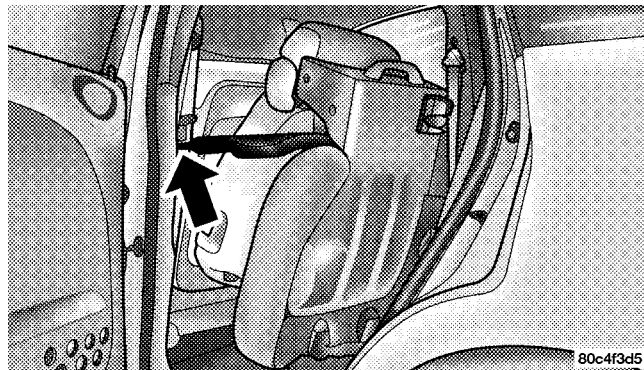

Tumbling Seat Strap

To return the rear seat to its upright latched position, rotate the seat cushion rearward to latch the seat. Then lift the seatback to its upright latched position.

NOTE: The elastic strap should be reinstalled in the clip on the base of the seat cushion before returning the seat to its normal position.

TUMBLING REAR SEAT (CONVERTIBLE)

To provide additional storage area, each rear seat can be tumbled forward.

CAUTION!

It is important that the front seats be pulled forward to the midpoint of the seat track to avoid contact between the rear seat and the front seatback. If the front seat is not pulled forward the two seats will make contact during the tumbling motion and cause damage to the rear seat material. After the rear seat is tumbled forward and secured the front seat can then be repositioned to the preferred position.

To tumble the seat forward use the following procedure:

1. The seat back release knobs are located in the trunk area. Pull the left side seatback release knob to fold down the left side seatback. Pull the right side seatback release knob to fold down the right side seatback.

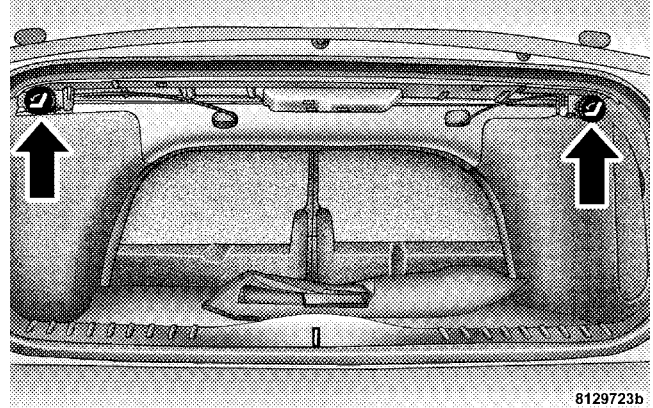

Folding Rear Seat Release Knobs

8129723b

2. From inside the vehicle, fold the rear seat back down flat.

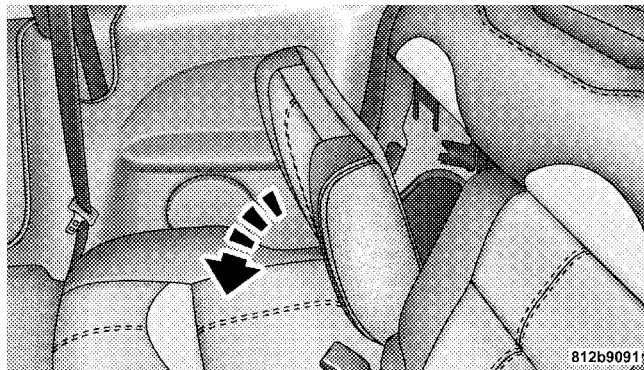

Folding Rear Seat Back

3. Pull the release strap located at the bottom of the folded seat back and tumble the seat forward.

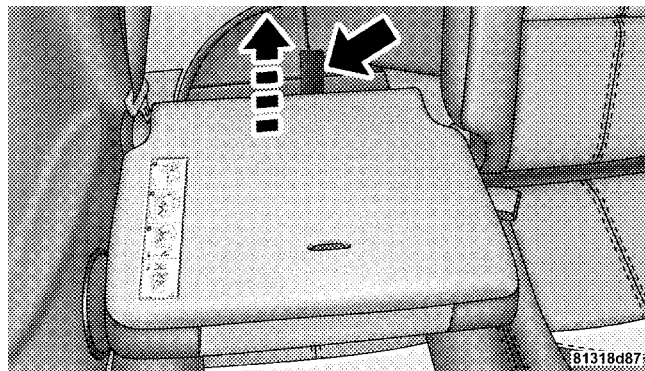

Tumbling Rear Seat

4. Attach the cinching tether strap, located at the side of the seat cushion, onto the hook bar on the center trim panel and tighten by pulling the cinching strap until the seat is secure.

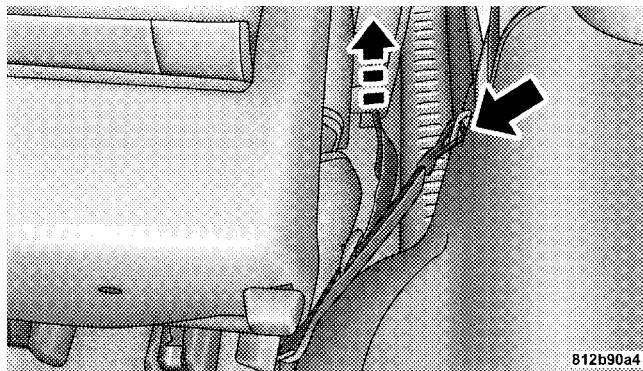

Cinching Tether Strap

To return the tumbling rear seat to the latched (normal) position use the following procedure:

1. Loosen the strap by pushing rearward on the cinching tether strap buckle.

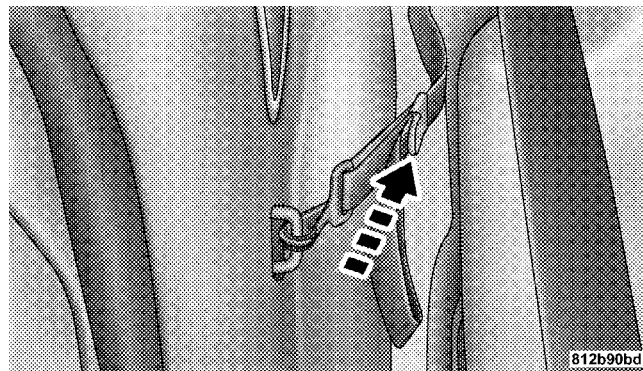

Releasing Cinching Tether Strap

2. Disconnect the cinching tether strap.

NOTE: The strap should be reinstalled in the side pocket on the seat cushion before returning the seat to the latched (normal) position.

NOTE: Prior to rotating the seat cushions rearward, be sure that the rear seat belt buckles are secured with the straps, so that the buckles are accessible.

3. Rotate the seat cushion rearward to latch the seat. Then lift the seatback to its upright latched position.

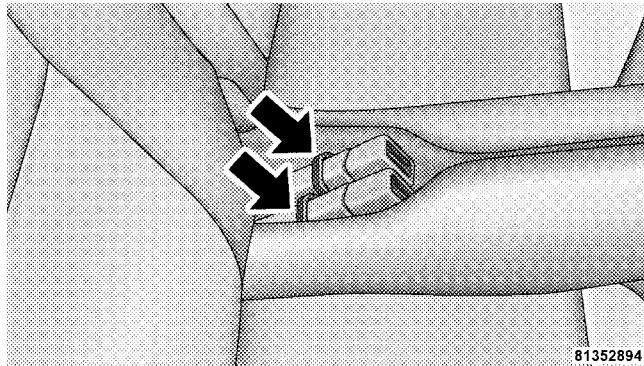

Rear Seat Belt Buckle Straps

NOTE: Prior to lifting either seatback to the upright position, be sure that the seat belt is brought forward to avoid trapping it behind the seatback.

CAUTION!

Ensure that the seat back is latched with a hard push to engage the latch, noting the presence of seat back rubber-overslam bumpers that need to be overcome. Check that the seat back release knobs are pushed fully forward in order to allow the latch to engage.

WARNING!

In an accident, you or others in your vehicle could be injured if seats are not properly latched to their attachments. Always be sure the seats are fully latched.

REAR SEAT REMOVAL (SEDAN)

The rear seats can be removed to provide more cargo space.

- Push and hold the button on the seatback and fold down the rear seatback.

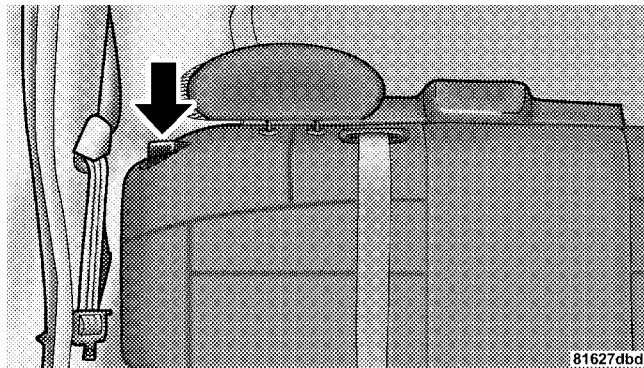

Folding Rear Seat Button

- Pull the release lever located on the outboard side of the seat. Lift up the seat and tumble the seat forward.

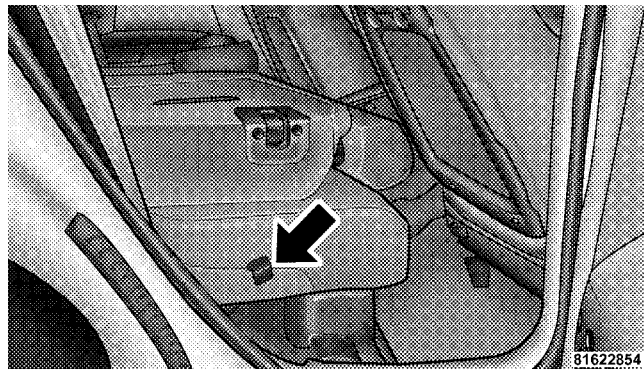

Tumbling Seat Release Strap

- Lift up the release levers to disengage the seat from the floor attachments.

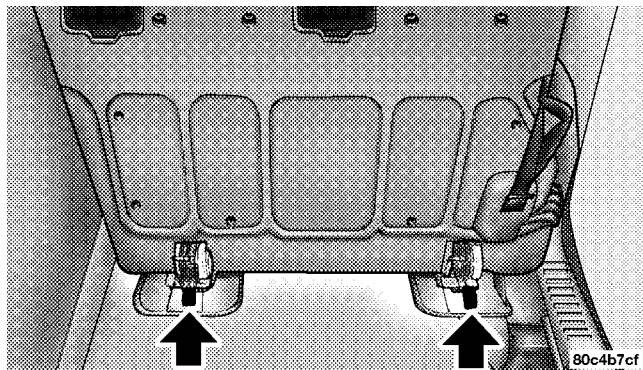

Release Lever Location

- Using the handle on the seat, the seat assembly can now be lifted and removed from the vehicle.

NOTE: Small rollers on the bottom of the folded seat and a handle at the top allow the seat to be easily moved when removed from the vehicle.

To reinstall the rear seat, insert the seat into the floor attachments. Lower the release levers of the seat to latch the front floor attachments and rotate the seat rearward to latch the seat. Lift the seat back to its upright latched position.

WARNING!

In an accident, you or others in your vehicle could be injured if seats are not properly latched to their floor attachments. Always be sure the seats are fully latched.

TO OPEN AND CLOSE THE HOOD

To open the hood, two latches must be released. First pull the primary hood release lever located under the left side of the instrument panel.

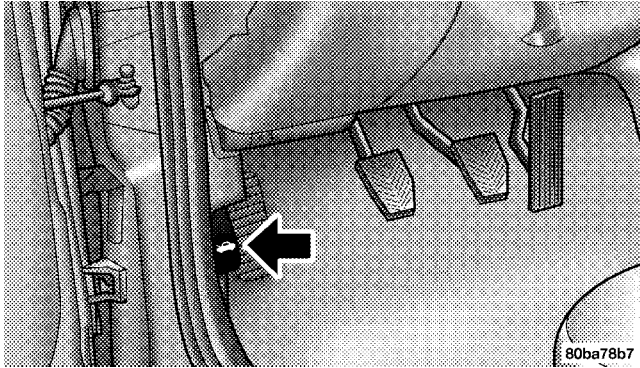

Primary Hood Release Lever

Then move the secondary hood latch (safety latch) located under the front edge of the hood, slightly to the right of center, and raise the hood.

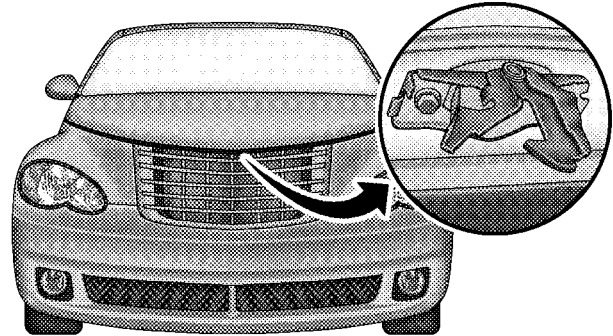

Secondary Hood Latch

81a8ed6b

Use the hood prop rod clipped to the driver's side of the engine compartment to secure the hood in the open position. Place the hood prop at the location stamped into the inner hood surface.

To prevent possible damage, do not slam the hood to close it. Lower the hood until it is open approximately 20 cm (8 inches) and then drop it. This should secure both latches. Never drive your vehicle unless the hood is fully closed, with both latches engaged.

WARNING!

If the hood is not fully latched it could fly up when the vehicle is moving and block your forward vision. You could have a collision. Be sure all hood latches are fully latched before driving.

LIGHTS

Map/Reading Lights (Sedan)

These lights are mounted between the sun visors above the rear view mirror. Each light is turned ON by pressing the button. Press the button a second time to turn the light OFF. The lights also come on when a door is opened or the dimmer control is turned fully upward, past the second detent.

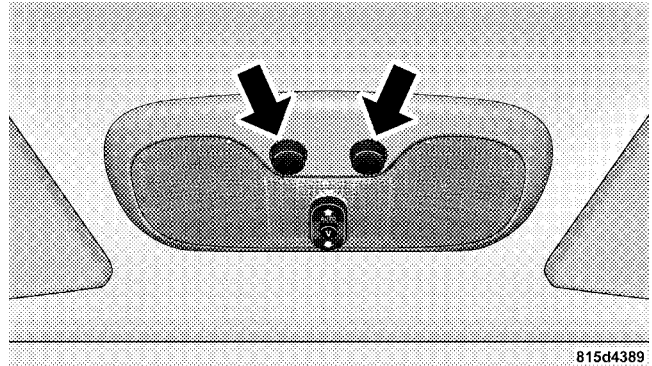

NOTE: The lights will remain on until the switch is pressed a second time, so be sure they have been turned off before leaving the vehicle. They will not turn off automatically.

Map/Reading Lights (Convertible)

When the ignition switch is in the ON position, these lights, located under the rearview mirror can be turned on by switches located at the base of the rearview mirror.

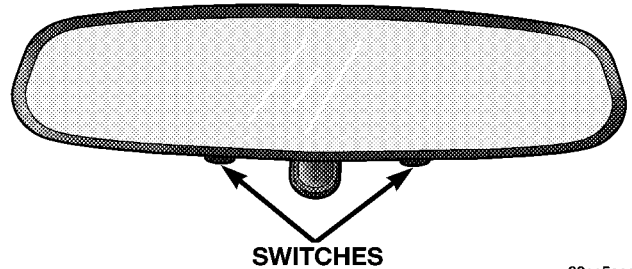

80ce5aaa

NOTE: The lights will remain on until the switch is pressed a second time, so be sure they have been turned off before leaving the vehicle. They will not turn off automatically.

Multi-Function Control Lever

The Multi-Function Control Lever controls the operation of the headlights, parking lights, turn signals, headlight beam selection, instrument panel light dimming, interior lights, the passing lights, and fog lights. The lever is located on the left side of the steering column.

Headlights, Parking Lights, Instrument Panel Lights

Turn the end of the Multi-Function Control Lever to the first detent for parking light operation. Turn to the second detent for headlight operation.

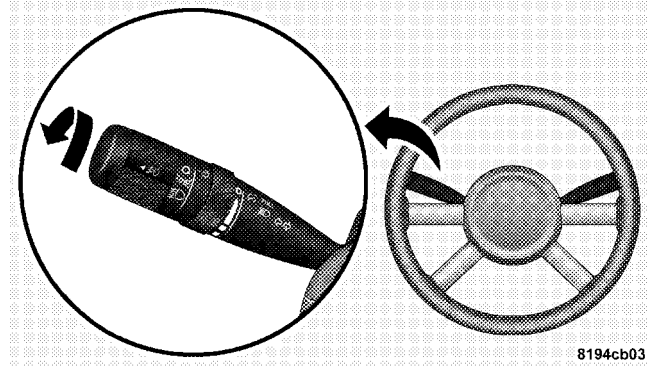

8194cb03

Headlamp Control

To change the brightness of the instrument panel lights, rotate the center portion of the Multi-Function Control Lever up or down.

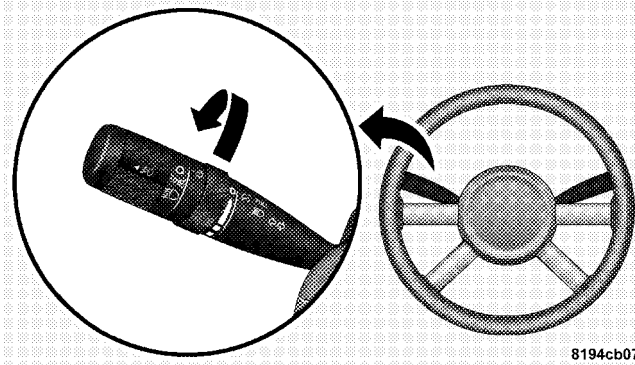

8194cb07

Dimmer Control

Daytime Running Lights (DRL) — If Equipped

The high beam lights will come on as Daytime Running Lights (DRL) at DRL intensity (lower), whenever the ignition is on, the engine is running, the headlight switch is off, the parking brake is off, the turn signal is off, and the gear shift is in any position except park.

NOTE: On this vehicle, the daytime running light will automatically turn off when the turn signal is in operation and automatically turn back on when the turn signal is not operating.

Lights-on Reminder

If the headlights or parking lights are on after the ignition is turned OFF, a chime will sound to alert the driver when the driver's door is opened.

Fog Lights — If Equipped

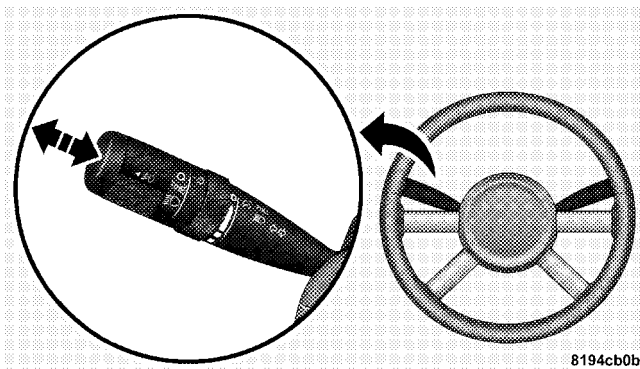

Fog Lamp Control

#D The front fog light switch is on the Multi-Function Control Lever. To activate the front fog lights, turn on the parking lights or the low beam headlights and pull out the end of the control lever.

NOTE: The fog lights will only operate with the headlights on low beam. Selecting high beam headlights will turn off the fog lights.

Turn Signals

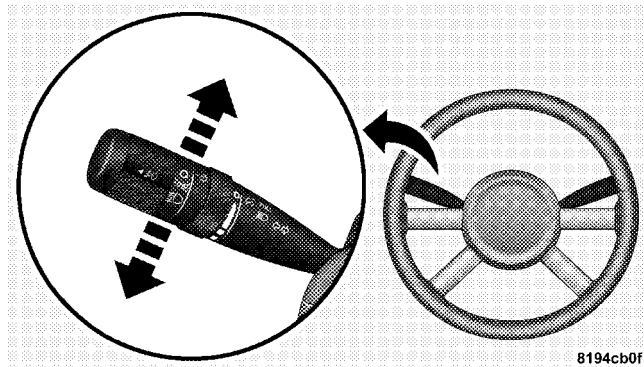

Turn Signal Control

Move the Multi-Function Control Lever up or down and the arrows on each side of the instrument cluster flash to show proper operation of the front and rear turn signal lights. You can signal a lane change by moving the lever partially up or down without moving beyond the detent.

If either light remains on and does not flash, or there is a very fast flash rate, check for a defective outside light bulb. If an indicator fails to light when the lever is moved, it would suggest that the fuse or indicator bulb is defective.

Highbeam/Lowbeam Select Switch

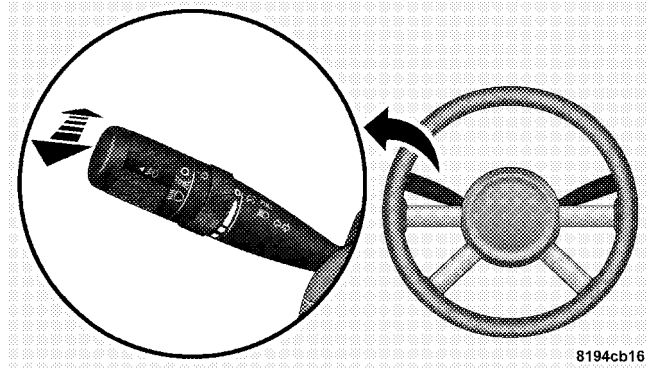

8194cb16

Highbeam, Lowbeam, and Passing Lights

Push the Multi-Function Control Lever away from you to switch the headlights to HIGH beam. Pull the Lever toward you to switch the headlights back to Low beam.

Passing Light

You can signal another vehicle with your headlights by lightly pulling the Multi-Function Control Lever toward you. This will cause the headlights to turn on at high beam and remain on until the lever is released.

NOTE: If the Multi-Function Control Lever is held in the flash to pass position for more than 15 seconds, the high beams will shut off. If this occurs, wait 30 seconds for the next flash to pass operation.

WINDSHIELD WIPERS AND WASHERS



The wipers and washers are operated by a switch on the control lever. The lever is located on the right side of the steering column. Rotate the control to select the desired wiper speed.

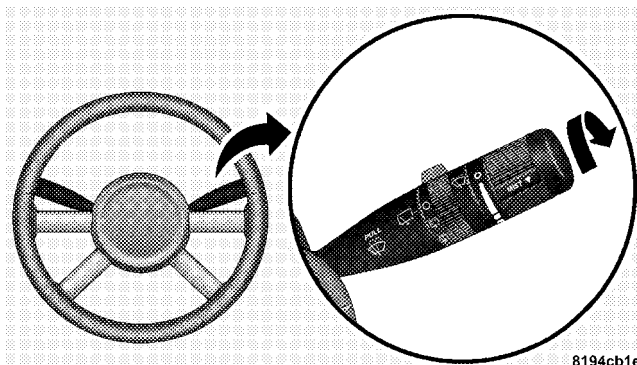

8194cb1e

Wiper/Washer Switch

Windshield Washers

To use the washer, pull the control lever toward you and hold while spray is desired. If the lever is pulled while in the delay range, the wiper will operate in low speed for two wipe cycles after the lever is released, and then resume the intermittent interval previously selected.

If the lever is pulled while in the OFF position, the wipers will operate for two wipe cycles, then turn OFF.

Mist Feature

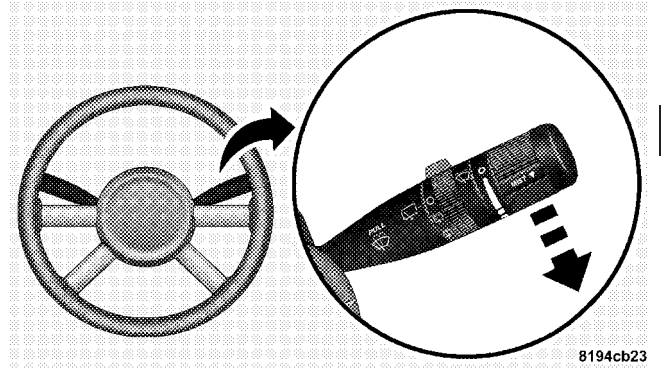

Mist Control

Push down on the wiper control lever to activate a single wipe to clear the windshield of road mist or spray from a passing vehicle. As long as the lever is held down, the wipers will continue to operate.

CAUTION!

In cold weather, always turn off the wiper switch and allow the wipers to return to the park position before turning off the engine. If the wiper switch is left on and the wipers freeze to the windshield, damage to the wiper motor may occur when the vehicle is restarted.

Windshield Wiper Operation

Rotate the control to the second detent for Low speed wiper operation, or to the third detent for High speed operation

Intermittent Wiper System

The intermittent feature of this system was designed for use when weather conditions make a single wiping cycle, with a variable pause between cycles, desirable. For maximum delay between cycles, rotate the control knob into the upper end of the delay range.

The delay interval decreases as you rotate the knob until it enters the LO continual speed position.

WARNING!

Sudden loss of visibility through the windshield could lead to an accident. You might not see other vehicles or other obstacles. To avoid sudden icing of the windshield during freezing weather, warm the windshield with defroster before and during windshield washer use.

NOTE: If the front wiper is operating when the ignition is turned off, the wiper will automatically return to the "Park" position. When the vehicle is restarted, the wipers will resume operation.

TILT STEERING COLUMN

To tilt the column, push down on the lever below the multifunction control lever and move the steering wheel up or down, as desired. Pull the lever back up to lock the column firmly in place.

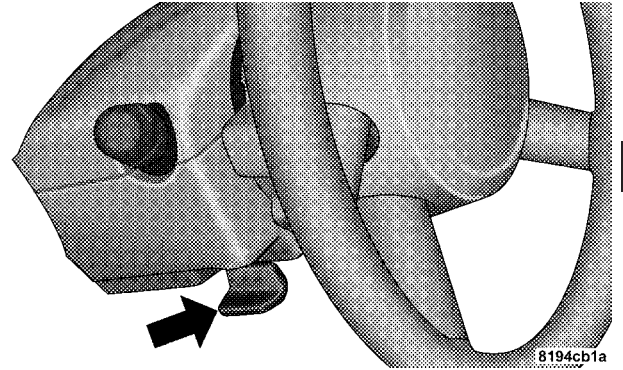

Tilt Steering Column Control

WARNING!

Tilting the steering column while the vehicle is moving is dangerous. Without a stable steering column, you could lose control of the vehicle and have an accident. Adjust the column only while the vehicle is stopped. Be sure it is locked before driving.

ELECTRONIC SPEED CONTROL — IF EQUIPPED

When engaged, this device takes over the accelerator operation at approximately either 30 mph (40 km/h) or 35 mph (56 km/h) depending on the model or engine size. The speed control lever is located on the right side of the steering wheel.

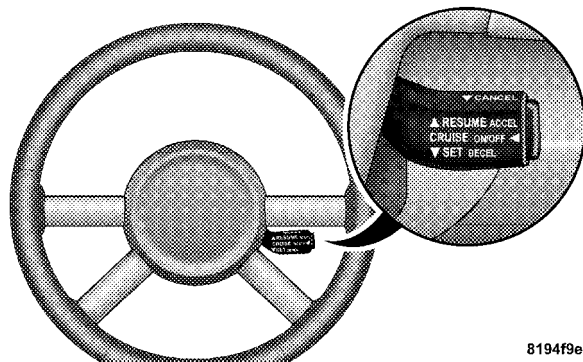

8194f9e6

PT 7 Speed Control Ballon L or R**To Activate:**

Push the ON/OFF button. The CRUISE indicator in the instrument cluster will illuminate. To turn the system OFF, push the ON/OFF button a second time. The CRUISE indicator will turn off. The system should be turned OFF when not in use.

WARNING!

Leaving the Electronic Speed Control system on when not in use is dangerous. You could accidentally set the system or cause it to go faster than you want. You could lose control and have an accident. Always leave the system OFF when you are not using it.

To Set At A Desired Speed:

When the vehicle has reached the desired speed, press down on the lever and release. Release the accelerator and the vehicle will operate at the selected speed.

NOTE: The vehicle should be traveling at a steady speed and on level ground before pressing the SET lever.

While in the AutoStick mode, speed control will only operate in third and fourth gear.

To Deactivate:

A soft tap on the brake pedal, pulling the speed control lever towards you CANCEL, or normal brake or clutch pressure while slowing the vehicle will deactivate speed control without erasing the set speed memory. Pressing the ON/OFF button or turning off the ignition switch erases the set speed memory.

To Resume Speed:

To resume a previously set speed, push the RESUME ACCEL lever up and release. Resume can be used at any speed above 20 mph (32 km/h).

To Vary The Speed Setting:

When the speed control is ON, speed can be increased by pushing up and holding RESUME ACCEL. Release the lever when the desired speed is reached, and the new speed will be set.

Tapping RESUME ACCEL once will result in a 2 mph (3 km/h) speed increase. Each time the lever is tapped, speed increases so that tapping the lever three times will increase speed by 6 mph (10 km/h), etc.

To decrease speed while speed control is ON, push down and hold SET DECEL. Release the lever when the desired speed is reached, and the new speed will be set.

Tapping the SET DECEL button once will result in a 1 mph (2 km/h) speed decrease. Each time the button is tapped, speed decreases.

Manual Transaxle:

Depressing the clutch pedal will disengage the speed control. A slight increase in engine RPM before the speed control disengages is normal.

Vehicles equipped with manual transaxles may need to be shifted into a lower gear to climb hills without speed loss.

WARNING!

Speed Control can be dangerous where the system can't maintain a constant speed. Your vehicle could go too fast for the conditions, and you could lose control. An accident could be the result. Don't use Speed Control in heavy traffic or on roads that are winding, icy, snow-covered, or slippery.

To Accelerate For Passing:

Depress the accelerator as you would normally. When the pedal is released, the vehicle will return to the set speed.

Using Speed Control On Hills

NOTE: The speed control system maintains speed up and down hills. A slight speed change on moderate hills is normal.

Vehicles equipped with four speed automatic transaxles may experience a downshift to third gear while climbing uphill or descending downhill. This downshift to third gear is necessary to maintain vehicle set speed.

On steep hills a greater speed loss or gain may occur so it may be preferable to drive without speed control.

GARAGE DOOR OPENER — IF EQUIPPED

HomeLink® replaces up to three remote controls (hand-held transmitters) that operate devices such as garage door openers, motorized gates, lighting, or home security systems. The HomeLink® unit operates off your vehicle's battery.

The HomeLink® buttons that are located in the headliner or sun visor designate the three different HomeLink® channels.

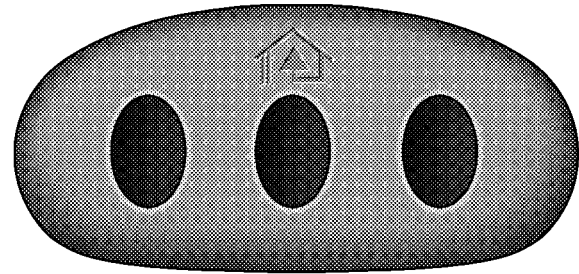

81cb44fe

HomeLink® Buttons

NOTE: HomeLink® is disabled when the Vehicle Security Alarm is active.

WARNING!

Your motorized door or gate will open and close while you are training the Universal Transceiver. Do not train the transceiver if people or pets are in the path of the door or gate. Only use this transceiver with a garage door opener that has a “stop and reverse” feature as required by Federal safety standards. This includes most garage door opener models manufactured after 1982. Do not use a garage door opener without these safety features. Call toll-free 1-800-355-3515 or, on the Internet at www.HomeLink.com for safety information or assistance.

WARNING!

Vehicle exhaust contains carbon monoxide, a dangerous gas. Do not run your vehicle in the garage while training the transceiver. Exhaust gas can cause serious injury or death.

PROGRAMMING HOMELINK®**Before You Begin**

If you have not trained any of the HomeLink® buttons, erase all channels before you begin training.

To do this, press and hold the two outside buttons for 20 seconds until the red indicator flashes.

It is recommended that a new battery be placed in the hand-held transmitter of the device being programmed to HomeLink® for more efficient training and accurate transmission of the radio-frequency signal.

Your vehicle should be parked outside of the garage when programming.

1. Turn the ignition switch to the ON/RUN position.
2. Hold the battery side of the hand-held transmitter away from the HomeLink® button you wish to program.

Place the hand-held transmitter 1–3 in (3–8 cm) away from the HomeLink® button you wish to program while keeping the indicator light in view.

3. Simultaneously press and hold both the chosen HomeLink® button and the hand-held transmitter button until the HomeLink® indicator changes from a slow to a rapidly blinking light, then release both the HomeLink® and hand-held transmitter buttons.

Watch for the HomeLink® indicator to change flash rates. When it changes, it is programmed. It may take up to 30 seconds, or longer in rare cases. The garage door may open and close while you train.

NOTE:

- Some gate operators and garage door openers may require you to replace Step 3 with procedures noted in the “Gate Operator/Canadian Programming” section.
 - After training a HomeLink® channel, if the garage door does not operate with HomeLink® and the garage door opener was manufactured after 1995, the garage door opener may have a rolling code. If so, proceed to the heading “Programming A Rolling Code System.”
4. Press and hold the just-trained HomeLink® button and observe the indicator light.

If the indicator light stays on constantly, programming is complete and the garage door (or device) should activate when the HomeLink® button is pressed.

If the indicator light blinks rapidly for two seconds, and then turns to a constant light, continue with programming for a Rolling Code.

5. PROGRAMMING A ROLLING CODE SYSTEM

At the garage door opener motor (in the garage), locate the “Learn” or “Training” button.

This can usually be found where the hanging antenna wire is attached to the garage door opener motor (it is NOT the button normally used to open and close the door).

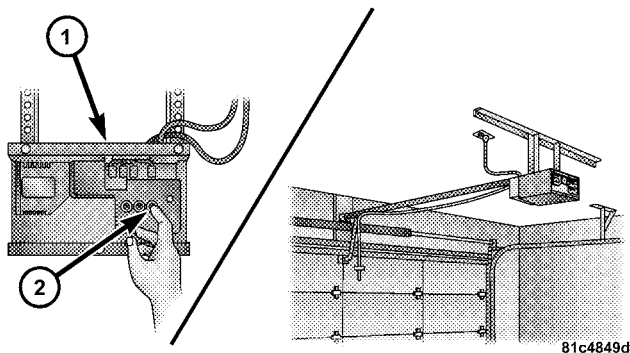

Training The Garage Door Opener

1 — Door Opener

2 — Training Button

6. Firmly press and release the “Learn” or “Training” button. The name and color of the button may vary by manufacturer.

NOTE: There are 30 seconds in which to initiate the next step after the “Learn” button has been pressed.

7. Return to the vehicle and press the programmed HomeLink® button twice (holding the button for two seconds each time). If the device is plugged in and activates, programming is complete.

If the device does not activate, press the button a third time (for two seconds) to complete the training.

If you have any problems, or require assistance, please call toll-free 1-800-355-3515 or, on the Internet at www.HomeLink.com for information or assistance.

To program the remaining two HomeLink® buttons, repeat each step for each remaining button. **DO NOT** erase the channels.

GATE OPERATOR/CANADIAN PROGRAMMING

Canadian radio-frequency laws require transmitter signals to “time-out” (or quit) after several seconds of transmission – which may not be long enough for HomeLink® to pick up the signal during programming. Similar to this Canadian law, some U.S. gate operators are designed to “time-out” in the same manner.

It may be helpful to unplug the device during the cycling process to prevent possible overheating of the garage door or gate motor.

If you are having difficulties programming a garage door opener or a gate operator, replace “Programming HomeLink®” Step 3 with the following:

3. Continue to press and hold the HomeLink® button while you press and release - every two seconds (“cycle”) your hand-held transmitter until HomeLink®

has successfully accepted the frequency signal. The indicator light will flash slowly and then rapidly when fully trained.

If you unplugged the device for training, plug it back in at this time.

Then proceed with Step 4 under “Programming HomeLink®” earlier in this section.

USING HOMELINK®

To operate, simply press and release the programmed HomeLink® button. Activation will now occur for the trained device (i.e., garage door opener, gate operator, Security system, entry door lock, home/office lighting, etc. The hand-held transmitter of the device may also be used at any time.

REPROGRAMMING A SINGLE HOMELINK® BUTTON

To re-program a channel that has been previously trained, follow these steps:

1. Turn the ignition switch to the ON/RUN position.
2. Press and hold the desired HomeLink® button until the indicator light begins to flash after 20 seconds. **Do not release the button.**
3. **Without releasing the button**, proceed with Programming Homelink® Step 2 and follow all remaining steps.

SECURITY

It is advised to erase all channels before you sell or turn in your vehicle.

To do this, press and hold the two outside buttons for 20 seconds until the red indicator flashes. Note that all channels will be erased. Individual channels cannot be erased.

The HomeLink® Universal Transceiver is disabled when the Vehicle Security Alarm is active.

TROUBLESHOOTING TIPS

If you are having trouble programming HomeLink®, here are some of the most common solutions:

- Replace the battery in the original transmitter.
- Press the “Learn” button on the Garage Door Opener to complete the training for a Rolling Code.
- Did you unplug the device for training, and remember to plug it back in?

If you have any problems, or require assistance, please call toll-free 1-800-355-3515 or, on the Internet at www.HomeLink.com for information or assistance.

GENERAL INFORMATION

This device complies with FCC rules Part 15 and Industry Canada RSS-210. Operation is subject to the following two conditions:

1. This device may not cause harmful interference
2. This device must accept any interference that may be received including interference that may cause undesired operation

NOTE: The transmitter has been tested and it complies with FCC and IC rules. Changes or modifications not expressly approved by the party responsible for compliance could void the user’s authority to operate the device.

The term IC before the certification/registration number only signifies that Industry Canada technical specifications were met.

POWER SUNROOF (SEDAN ONLY) — IF EQUIPPED

The power sunroof switch is located in the reading lamp.

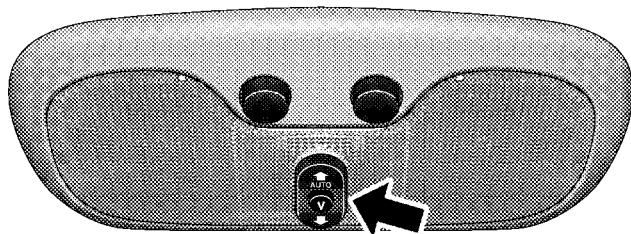

Power Sunroof Switch

815d5564

Turn the Ignition Key to the ACC or ON position, press and hold the switch rearward to fully open the sunroof. The sunroof can be stopped at any position between closed and full open. Momentarily pressing the switch rearward will activate the Express Open Feature, causing the sunroof to open automatically.

Press and hold the button in the center of the sunroof switch to open the vent. The sunroof can be stopped at any position between closed and full vent. To close the sunroof from the vent position, press and hold the switch forward. Releasing the switch will stop the movement of the sunroof and the sunroof will remain in the partial vent position until the switch is pushed forward again.

Express Open Feature

During the Express Open operation, any movement of the switch will stop the sunroof and it will remain in a partial open position. Again, momentarily pressing the switch rearward will activate the Express Open Feature.

To close the sunroof, hold the switch in the forward position. Again, any release of the switch will stop the movement and the sunroof will remain in a partial open condition until the switch is pushed forward again.

The sunshade can be opened manually. It will also open as the sunroof opens. The sunshade cannot be closed if the sunroof is open.

WARNING!

Never leave children in a vehicle, with the keys in the ignition switch. Occupants, particularly unattended children, can become entrapped by the power sunroof while operating the power sunroof switch. Such entrapment may result in serious injury or death.

WARNING!

In an accident, there is a greater risk of being thrown from a vehicle with an open sunroof. You could also be seriously injured or killed. Always fasten your seat belt properly and make sure all passengers are properly secured too.

Do not allow small children to operate the sunroof. Never allow fingers or other body parts, or any object to project through the sunroof opening. Injury may result.

Wind Buffeting

Wind buffeting can be described as the perception of pressure on the ears or a helicopter type sound in the ears. Your vehicle may exhibit wind buffeting with the windows down, or the sunroof (if equipped) in certain

open or partially open positions. This is a normal occurrence and can be minimized. If the buffeting occurs with the rear windows open, open the front and rear windows together to minimize the buffeting. If the buffeting occurs with the sunroof open, adjust the sunroof opening to minimize the buffeting or open any window.

Sunroof Maintenance

Use only a non-abrasive cleaner and a soft cloth to clean the glass panel.

ELECTRICAL POWER OUTLETS

The outlets include tethered caps, labeled with a key symbol or battery symbol, indicating power source. All outlets are protected by a single 20-Amp fuse.

The standard outlet in the front of the center floor console is a conventional cigar lighter outlet.

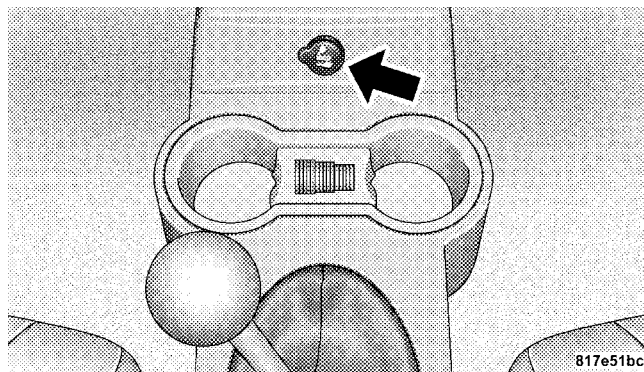

Front Power Outlet

It will accept a cigar lighter unit, which is part of the optional Smokers Package. To preserve the heating element of the cigar lighter unit, do not hold the lighter in the heating position. As a child safety precaution, this outlet is powered by the ignition switch, only when the switch is in the ON or ACC positions.

There is one optional power outlet located in the right rear cargo area.

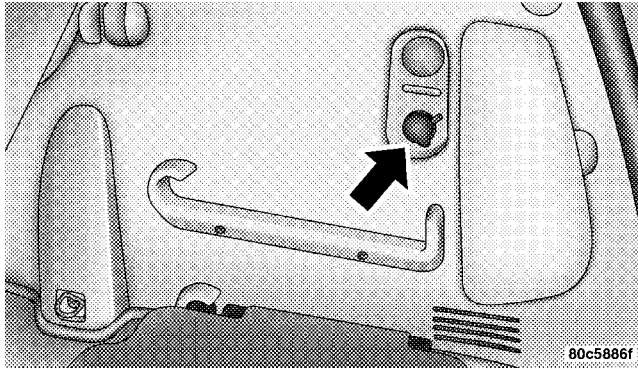

Rear Power Outlet

The Rear Power Outlet is powered directly by the battery. As an option, fuse #11 in the Integrated Power Module (IPM), may be repositioned to allow power to come from the ignition switch only when in the ON or ACC positions.

NOTE: The Rear Power Outlet will not accept a cigar lighter unit as it is intended only for accessory items.

Electrical Outlet Use With Engine Off

CAUTION!

- Many accessories that can be plugged in draw power from the vehicle's battery, even when not in use (i.e., cellular phones, etc.). Eventually, if plugged in long enough, the vehicle's battery will discharge sufficiently to degrade battery life and/or prevent engine starting.
- Accessories that draw higher power (i.e., coolers, vacuum cleaners, lights, etc.), will degrade the battery even more quickly. Only use these intermittently and with greater caution.
- After the use of high power draw accessories, or long periods of the vehicle not being started (with accessories still plugged in), the vehicle must be driven a sufficient length of time to allow the generator to recharge the vehicle's battery.

CONSOLE FEATURES

The console has two front cup holders, a removable coin holder, 12 volt power outlet and a front storage tray. There are three additional cup holders; one is molded in the center of the console to hold large cups and the others are in the rear of the console to serve passengers in the rear seat. The floor console power outlet will also operate a conventional cigar lighter unit (if equipped with an optional Smoker's Package).

CAUTION!

- Many accessories that can be plugged into the 12 volt power outlet, draw power from the vehicle's battery, even when not in use; i.e. cellular phones, etc. Eventually, if plugged in long enough, the vehicle's battery will discharge sufficiently to degrade battery life and/or prevent engine starting.
- Accessories that draw higher power such as coolers, vacuum cleaners, lights, etc., will discharge the battery even more quickly. Only use these intermittently and with greater caution.
- After the use of high power draw accessories, or long periods of the vehicle not being started, (with accessories still plugged in), the vehicle must be driven a sufficient length of time to allow the generator to recharge the vehicle's battery.

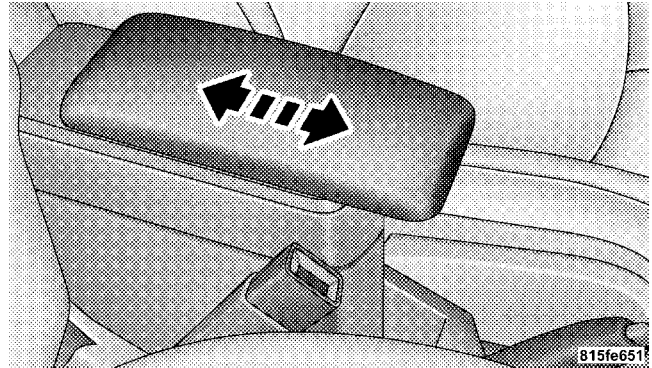
STORAGE**Center Console/Armrest Storage Bin****Sliding Armrest**

The center console provides a sliding armrest with two unique storage compartments under the lid.

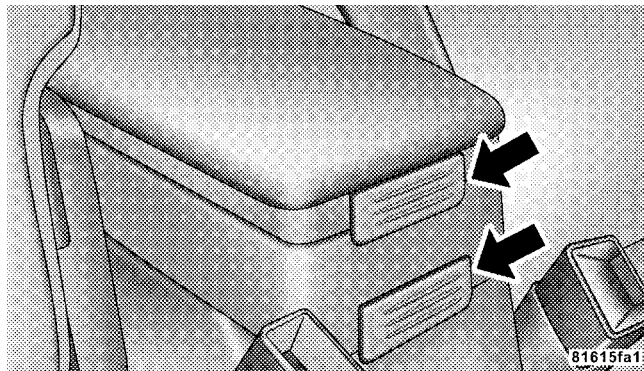

Sliding Armrest Storage Bins

Push the upper button on the front of the armrest to raise the upper cover. Inside is an area to store a cell phone and other miscellaneous items. Push the lower button on the front of the armrest, and raise the armrest for access to the lower storage bin. The lower storage area can be used for storing up to six CD's and other miscellaneous items.

Storage Pockets

There are also Storage pockets located on each door trim panel.

REAR SHELF PANEL— IF EQUIPPED

The rear shelf panel attaches to guides in the rear cargo area. The rear shelf panel may be installed in one of five different positions.

NOTE: The liftgate may be opened or closed with the rear cargo shelf panel in position 1, position 2, position 3 or position 4.

WARNING!

- To avoid tipping, lock the shelf securely in all positions.
- Do not drive this vehicle with the liftgate open, or use the shelf as a seat.
- Failure to follow these warnings could result in serious or fatal injury.

Position 1 (Top)

Insert the front outboard corners of the shelf panel into the top guides and slide forward. Press down on the back of the shelf panel to lock it into place.

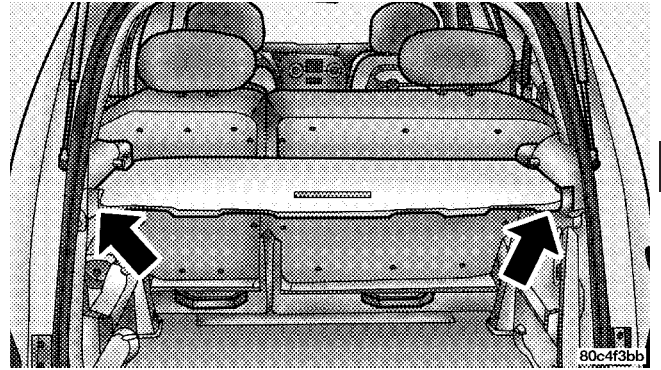
**Rear Shelf Panel Position 1****WARNING!**

Do not load objects on the shelf in position 1 (top). In an accident objects could strike occupants causing serious or fatal injury.

Position 2 (Middle)

Insert the front outboard corners of the shelf panel into the middle guides and slide forward. Press down on the back of the shelf panel to lock it into place.

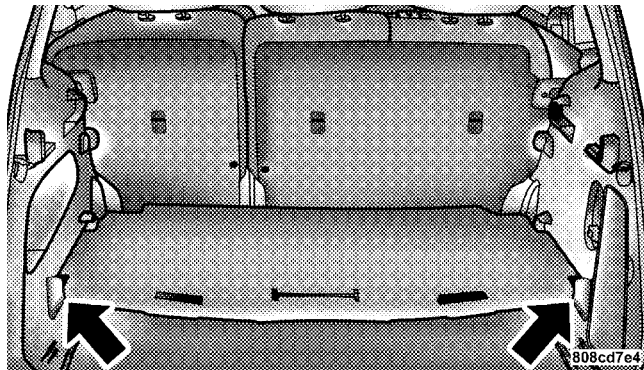

Rear Shelf Panel Position 2

WARNING!

Do not load objects over 100 lbs (45 kg) in position 2 (middle). Failure to follow this warning could cause the shelf to collapse resulting in personal injury.

Position 3 (Floor)

Insert the front outboard corners of the shelf panel into the bottom guides and slide forward.

NOTE: To carry items that may soil the carpeting, the rear shelf panel may be inverted in position 2 or position 3.

Position 4 (Vertical)

Insert the front outboard corners of the shelf panel into the vertical guides behind the rear seatbacks near the floor and slide downward. Push the shelf panel forward to lock it into place.

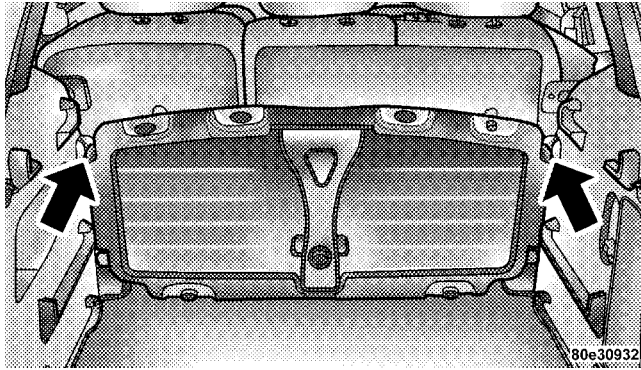

Rear Shelf Panel Position 4

WARNING!

When in the vertical position, the rear shelf panel should not be used as a barrier for large objects in the cargo area when the seatbacks folded down. In an accident objects could strike the seatbacks or occupants causing serious or fatal injury.

3

Position 5 (table)

With the liftgate open the rear shelf panel can be moved rearward to act as a serving counter.

1. Install the front corners of the shelf panel into the top rear guides. Press down on the shelf panel to lock it into place.

2. Twist the knob on the underside of the panel and lower the shelf leg.

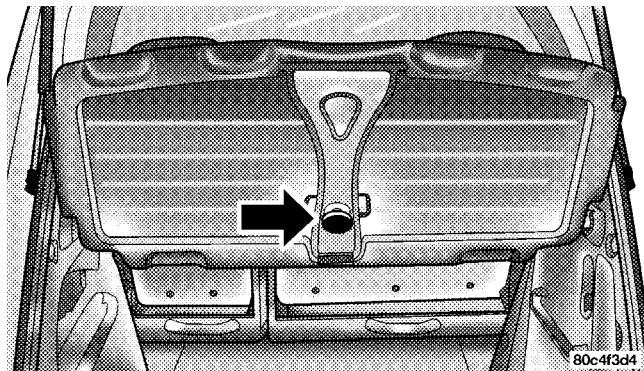

Rear Shelf Leg Release Knob

3. Install the shelf leg into the liftgate latch area as labeled on the rear scuff plate.

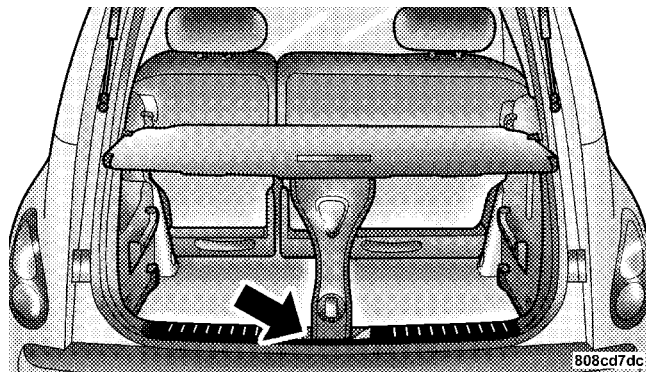

Rear Shelf Panel Position 5

WARNING!

Do not load objects over 100 lbs (45 kg) in position 5 (table). Failure to follow this warning could cause the shelf to collapse resulting in personal injury.

ROOF LUGGAGE RACK — IF EQUIPPED

The crossbars and siderails are designed to carry the weight on vehicles equipped with a luggage rack. The load must not exceed 150 lbs (68 kg), and should be uniformly distributed over the luggage rack crossbars.

Use both adjustable crossbars assemblies to support the load and distribute the load as evenly as possible.

To adjust the crossbars with latch-style releases (if equipped), release the latches on the inboard side of the crossbar supports on each side of the vehicle, then move the crossbars to the desired position. Once the crossbar is in the desired position, return both latches to the locked position.

To adjust the crossbars with bottom-style releases (if equipped), depress the button and slide the crossbar to the next locking position. Alternate sides until the crossbars are positioned correctly for your cargo and the stanchions are locked square to the slide rails.

External racks do not increase the total load carrying capacity of the vehicle. Be sure that the total occupant and luggage load inside the vehicle, plus the load on the luggage rack, do not exceed the rated vehicle capacity.

NOTE: When the luggage rack is not in use, place the crossbars together at the rear of the vehicle. In this position they are designed to improve the vehicle aerodynamics and reduce wind noise.

CAUTION!

To avoid damage to the roof rack and vehicle, do not exceed the maximum roof rack load capacity of 150 lbs (68 kg). Always distribute heavy loads as evenly as possible and secure the load appropriately.

Long loads which extend over the windshield, such as wood panels or surfboards, should be secured to both the front and rear of the vehicle.

Travel at reduced speeds and turn corners carefully when carrying large or heavy loads on the roof rack. Wind forces, due to natural causes or nearby truck traffic, can add sudden upward loads. This is especially true on large flat loads and may result in damage to the cargo or your vehicle.

WARNING!

Cargo must be securely tied before driving your vehicle. Improperly secured loads can fly off the vehicle, particularly at high speeds, resulting in personal injury or property damage. Follow the roof rack "Cautions" when carrying cargo on your roof rack.

REAR WINDOW FEATURES

Electric Rear Window Defroster

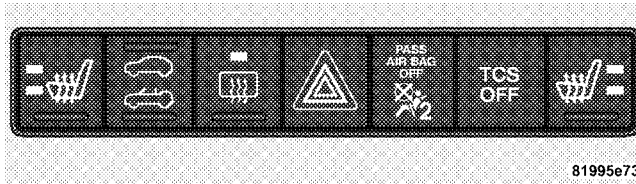

Rear Defroster Switch



The push-button is located at the center of the instrument panel, below the radio. Press this button to turn on the rear window defroster, and the optional electric remote control heated mirrors. An amber light shows that the defroster is on.

NOTE: The defroster turns off automatically after 10 minutes of operation. Each following activation of the defroster will last for five minutes.

CAUTION!

To avoid damaging the electrical conductors, do not use scrapers, sharp instruments, or abrasive window cleaners on the interior surface of the rear window. Labels can be peeled off after soaking with warm water.

Rear Wiper/Washer Switch (Sedan Models Only) — If Equipped

A switch on the right side of the steering column controls operation of the rear wiper/washer function. Rotating the center of the switch forward to the ON position will activate the wiper. Rotating the center of the switch all the way forward will turn on the wash function. The

wash pump will continue to operate as long as the button is pressed. Upon release, the wipers will cycle two times before returning to the set position.

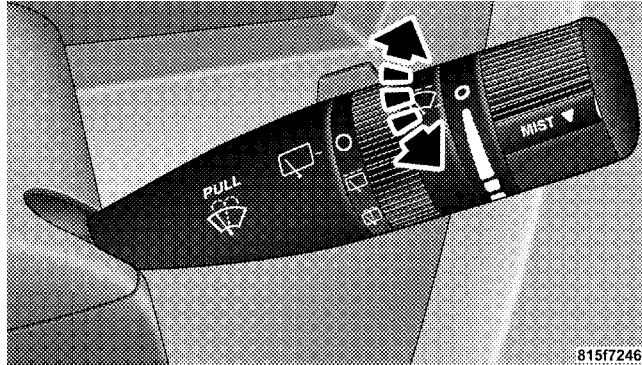

06 Rear Wiper Switch

If the rear wiper is operating when the ignition is turned OFF, the wiper will automatically return to the “Park” position if power accessory delay is active. Power accessory delay can be cancelled by opening the door, if this happens the rear wiper will stop at its current position and will not go to park.

Adding Washer Fluid

The fluid reservoir for the windshield washers and the rear window washer (if equipped) is shared. It is located in the rear of the engine compartment on the passenger side and should be checked for fluid level at regular intervals. Fill the reservoir with windshield washer solvent (not radiator antifreeze) and operate the system for a few seconds to flush out the residual water.

UNDERSTANDING YOUR INSTRUMENT PANEL

CONTENTS

■ Instrument Panel Features	222	□ Odometer Display	239
■ Instrument Cluster—Base	223	□ Trip Odometer (ODO)	239
■ Instrument Cluster—Premium	224	■ Electronic Vehicle Information Center (EVIC) – If Equipped	240
■ Instrument Cluster—Turbo	225	□ EVIC Functions	242
■ Instrument Cluster Descriptions	226	□ Compass/Temperature/Audio	243
■ Compass Mini Trip Computer (CMTC) — If Equipped	235	□ Average Fuel Economy	243
□ Compass Mini Trip Computer Reset Button	235	□ Distance To Empty (DTE)	243
□ Compass/Temperature Display	236	□ Elapsed Time	244

- Tire Pressure Monitor (TPM)244
- Personal Settings (Customer Programmable Features)244
- Setting The Analog Clock250
- Radio General Information250
 - Radio Broadcast Signals250
 - Two Types Of Signals250
 - Electrical Disturbances251
 - AM Reception251
 - FM Reception251
- Sales Code REF — AM/FM/CD (Single Disc) Radio With Optional Satellite Radio And Hands Free Phone Capability251
 - Operating Instructions - Radio Mode252
 - Operating Instructions - CD Mode255
 - Operating Instructions - Auxiliary Mode257
 - Operating Instructions - Hands-Free Phone — If Equipped258
 - Operating Instructions - Satellite Radio — If Equipped258
- Sales Code RAQ – AM/FM/CD (6-Disc) Radio With Optional Satellite Radio, Hands-Free Phone, And Video Entertainment Systems (VES™) Capabilities259
 - Operating Instructions - Radio Mode259
 - Operating Instructions - (CD Mode For CD Audio Play)265
 - Load/Eject Button (CD Mode For CD Audio Play)266

□ Notes On Playing MP3 Files	268	□ Using The PTY (Program Type) Button (If Equipped)	275
□ Operating Instructions - (CD Mode For MP3 Audio Play)	270	□ PTY Button "Scan"	275
□ Load/Eject Button (CD Mode For MP3 Play) . . .	271	□ PTY Button "Seek"	276
■ Satellite Radio — If Equipped	273	□ Satellite Antenna	276
□ System Activation	273	□ Reception Quality	276
□ Electronic Serial Number/Sirius Identification Number (ESN/SID)	273	■ CD/DVD Disc Maintenance	277
□ Selecting Satellite Mode In REF, And RAQ, Radios	274	■ Radio Operation And Cellular Phones	277
□ Selecting a Channel	274	■ Climate Controls	277
□ Storing And Selecting Pre-Set Channels	275	□ Climate Controls	277
		□ Operating Tips	283

INSTRUMENT PANEL FEATURES

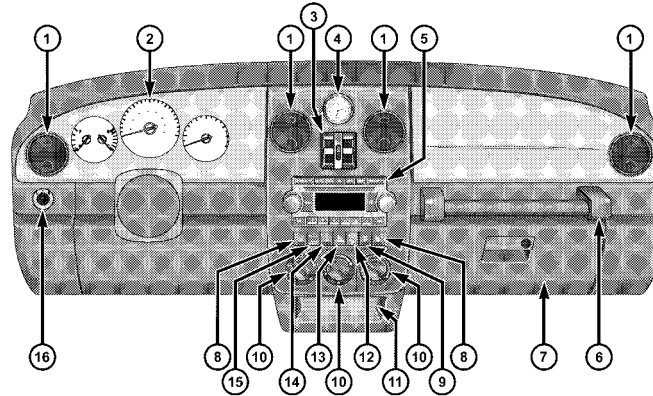

81cab3a5

1 - Air Vent
2 - Instrument Cluster
3 - Power Windows
4 - Analog Clock
* If Equipped

5 - Radio
6 - Assist Handle
7 - Glove Compartment
8 - Heated Seats*

9 - TRAC Off
10 - Climate Controls
11 - Storage Cubby
12 - Pass Airbag Off

13 - Hazard Lights
14 - Rear Window Defroster*
15 - Power Convertible Top
16 - Side Mirror Control*

INSTRUMENT CLUSTER—BASE

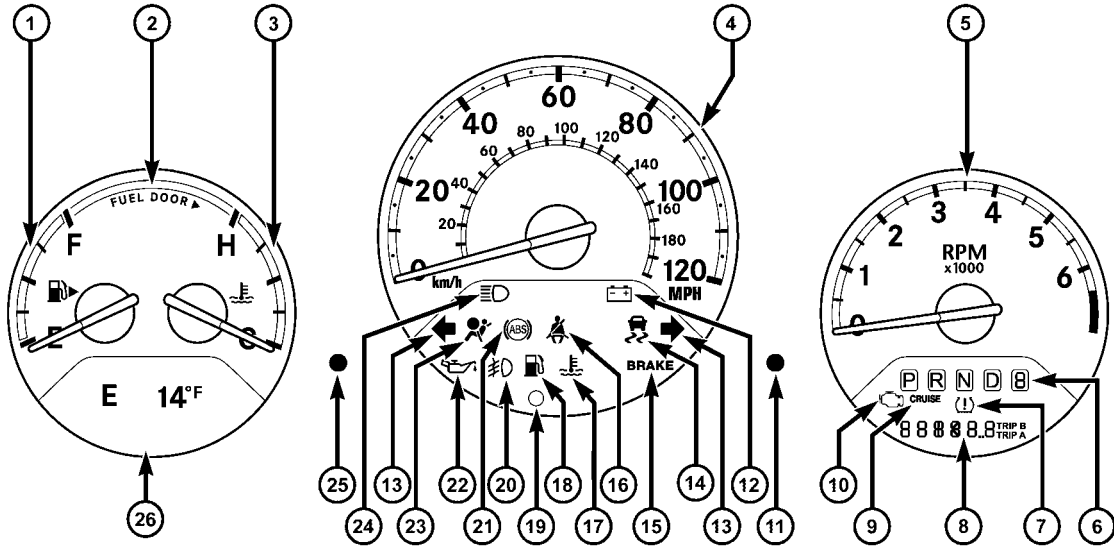

81c9daf8

INSTRUMENT CLUSTER—PREMIUM

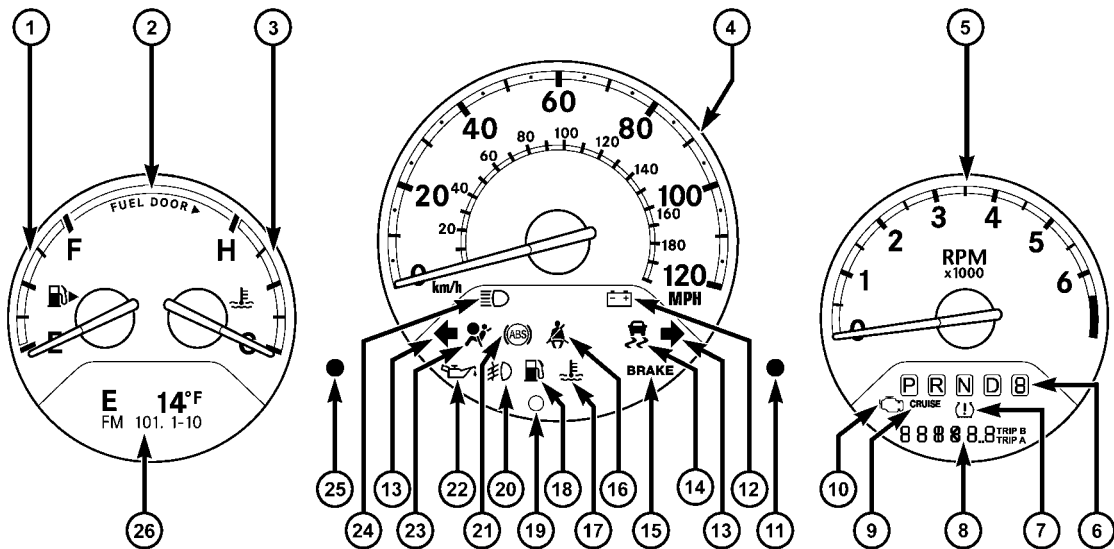

INSTRUMENT CLUSTER—TURBO

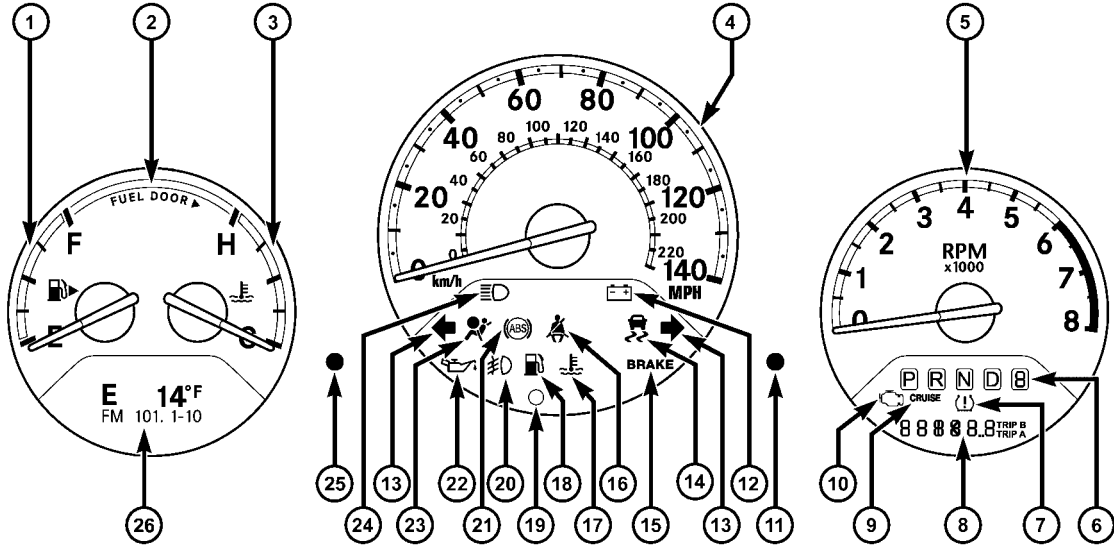

81c9dd12

INSTRUMENT CLUSTER DESCRIPTIONS

1. *Fuel Gauge*



When the ignition switch is in the ON position, the pointer will show the level of fuel remaining in the fuel tank.

2. *Fuel Door Reminder*

This is a reminder that the Fuel Filler Door is located on the front passenger's (right) side of the vehicle.

3. *Temperature Gauge*



The temperature gauge shows engine coolant temperature. Any reading below the red area of the gauge shows that the engine cooling system is operating properly. The gauge pointer may show a higher than normal temperature when driving in hot weather, up mountain grades, in heavy stop and go traffic, or when towing a trailer.

If the pointer rises to the **H** (red) mark, the instrument cluster will sound a chime. Pull over and stop the vehicle. Idle the vehicle with the air conditioner turned off until the pointer drops back into the normal range. If the pointer remains on the **H** (red) mark, turn the engine off immediately and call for service.

There are steps that you can take to slow down an impending overheating condition. If your air conditioning is on, turn it off. The air conditioning system adds heat to the engine cooling system and turning off the A/C removes this heat. You can also turn the Temperature control to maximum heat, the Mode control to Floor and the Fan control to High. This allows the heater core to act as a supplement to the radiator and aids in removing heat from the engine cooling system.

4. *Speedometer*

Indicates vehicle speed.

5. *Tachometer*

The white area of the scale shows the permissible engine revolutions-per-minute (rpm x 1000) for each gear range. Before reaching the red area, ease up on the accelerator to prevent engine damage.

6. *Transmission Range Indicator*

This display indicator shows the automatic transmission gear selection.

7. *Tire Pressure Monitor Light*



Each tire, including the spare (if provided), should be checked monthly when cold and inflated to the inflation pressure recommended by the vehicle manufacturer on the vehicle placard or tire inflation pressure label. (If your vehicle has tires of a different size than the size indicated on the vehicle placard or tire inflation pressure label, you should determine the proper tire inflation pressure for those tires.)

As an added safety feature, your vehicle has been equipped with a Tire Pressure Monitoring System (TPMS) that illuminates a low tire pressure telltale when one or more of your tires is significantly under-inflated. Accordingly, when the low tire pressure telltale illuminates, you should stop and check your tires as soon as possible, and inflate them to the proper pressure. Driving on a significantly under-inflated tire causes the tire to overheat and can lead to tire failure. Under-inflation also reduces fuel efficiency and tire tread life, and may affect the vehicle's handling and stopping ability.

NOTE: Please note that the TPMS is not a substitute for proper tire maintenance, and it is the driver's responsibility to maintain correct tire pressure, even if under-inflation has not reached the level to trigger illumination of the TPMS low tire pressure telltale.

Your vehicle has also been equipped with a TPMS malfunction indicator to indicate when the system is not operating properly. The TPMS malfunction indicator is combined with the low tire pressure telltale. When the system detects a malfunction, the telltale will flash for approximately one minute and then remain continuously illuminated. This sequence will continue upon subsequent vehicle start-ups as long as the malfunction exists. When the malfunction indicator is illuminated, the system may not be able to detect or signal low tire pressure as intended. TPMS malfunctions may occur for a variety of reasons, including the installation of replacement or alternate tires or wheels on the vehicle that prevent the TPMS from functioning properly. Always check the TPMS malfunction telltale after replacing one or more tires or wheels on your vehicle to ensure that the replacement or alternate tires and wheels allow the TPMS to continue to function properly.

CAUTION!

The TPMS has been optimized for the original equipment tires and wheels. TPMS pressures and warning have been established for the tire size equipped on your vehicle. Undesirable system operation or sensor damage may result when using replacement equipment that is not of the same size, type, and/or style. Aftermarket wheels can cause sensor damage. Do not use aftermarket tire sealants or balance beads if your vehicle is equipped with a TPMS, as damage to the sensors may result.

(Refer to “Tire Inflation Pressures” under “Tires — General Information” and to “Tire Pressure Monitor System (TPMS)” in Section 5 of this manual for more information).

8. *Odometer/Trip Odometer*

A vacuum fluorescent display indicates the total distance the vehicle has been driven. Also, the cluster will display, replacing the odometer/trip odometer, vehicle warning messages such as: door/deck/hatch/gate ajar and loose gas cap. Loose gas cap will be displayed from the Odometer/Trip Odometer on all models.

NOTE: If vehicle is equipped with the optional Electronic Vehicle Information Center (EVIC) in the instrument cluster, all warnings including “door”, “dECK”, “hATCh”, and “gATE” will only be displayed in the EVIC display. For additional information, refer to “Electronic Vehicle Information Center — If Equipped” in Section 3.

U.S. federal regulations require that upon transfer of vehicle ownership, the seller certify to the purchaser the correct mileage that the vehicle has been driven. Therefore, if the odometer reading is changed during repair or

replacement, be sure to keep a record of the reading before and after the service so that the correct mileage can be determined.

9. *Cruise Indicator — If Equipped*

CRUISE This indicator shows that the Speed Control System is ON.

NOTE: The word “SET” **will not** illuminate when the Speed Control System is on.

10. *Malfunction Indicator Light*

 This light is part of an onboard diagnostic system called OBD that monitors emissions, engine, and automatic transmission control systems. The light will illuminate when the key is in the ON/RUN position before engine start. If the bulb does not come on when turning the key from OFF to ON/RUN, have the condition checked promptly.

Certain conditions such as a loose or missing gas cap, poor fuel quality, etc. may illuminate the light after engine start. The vehicle should be serviced if the light stays on through several of your typical driving cycles. In most situations the vehicle will drive normally and will not require towing.

If the Malfunction Indicator Light flashes when the engine is running, serious conditions may exist that could lead to immediate loss of power or severe catalytic converter damage. The vehicle should be serviced as soon as possible if this occurs.

11. Odometer/Trip Odometer Reset Knob

Press this button to change the display from odometer to either of the two trip odometer settings. Trip A or Trip B will appear when in the trip odometer mode. Push in and hold the button for two seconds to reset the trip odometer to 0 miles or kilometers. The odometer must be in trip mode to reset.

12. Charging System Light



This light shows the status of the electrical charging system. The light should come on briefly when the ignition switch is first turned ON and remain on briefly as a bulb check. If the light stays on or comes on while driving, it means that there is a problem with the charging system. Obtain SERVICE IMMEDIATELY.

13. Turn Signal Indicators



The arrows will flash in unison with the exterior turn signal, when using the turn signal lever.

NOTE: Turn signal bulbs are located in the Instrument Panel.

14. *Electronic Stability Program (ESP) Indicator Light/Traction Control System (TCS) Indicator Light — If Equipped*



If this indicator light flashes during acceleration, apply as little throttle as possible. While driving, ease up on the accelerator. Adapt your speed and driving to the prevailing road conditions, and do not switch off the ESP, or TCS — if equipped.

15. *Brake System Warning Light*

BRAKE This light monitors various brake functions, including brake fluid level and parking brake application. If the brake light turns on, it may indicate that the parking brake is applied, there is a low brake fluid level or there is a problem with the anti-lock brake system.

The dual brake system provides a reserve braking capacity in the event of a failure to a portion of the hydraulic system. Failure of either half of the dual brake system is indicated by the Brake Warning Light which will turn on when the brake fluid level in the master cylinder has dropped below a specified level.

The light will remain on until the cause is corrected.

NOTE: The light may flash momentarily during sharp cornering maneuvers which change fluid level conditions. The vehicle should have service performed, and the brake fluid level checked.

If brake failure is indicated, immediate repair is necessary.

WARNING!

Driving a vehicle with the brake light on is dangerous. Part of the brake system may have failed. It will take longer to stop the vehicle. You could have an accident. Have the vehicle checked immediately.

Vehicles equipped with Anti-Lock brakes (ABS), are also equipped with Electronic Brake Force Distribution (EBD). In the event of an EBD failure, the Brake Warning Light will turn on along with the ABS Light. Immediate repair to the ABS system is required.

The operation of the Brake Warning Light can be checked by turning the ignition switch from the OFF position to the ON position. The light should illuminate for approximately two seconds. The light should then turn off unless

the parking brake is applied or a brake fault is detected. If the light does not illuminate, have the light inspected by an authorized dealer.

The light also will turn on when the parking brake is applied with the ignition switch in the ON position.

NOTE: This light shows only that the parking brake is applied. It does not show the degree of brake application.

16. Seat Belt Reminder Light

When the ignition switch is first turned ON, this light will come on for about six seconds. A chime will sound if you have not pulled the shoulder belt out of the retractor. This is a reminder to “buckle up”. If you do not buckle up, the light will remain on.

17. Engine Temperature Warning Light

This light warns of an overheated engine condition. If the engine is critically hot, a warning chime

will sound 10 times. After the chime turns off, the engine will still be critically hot until the light goes out.

18. *Low Fuel Light*



When the fuel level drops to 2 gallons, the fuel symbol will light and a single chime will sound.

19. *Theft Alarm Light — If Equipped*

This light will flash rapidly for several seconds when the alarm system is arming. The light will begin to flash slowly indicating that the system is armed.

20. *Front Fog Light Indicator — If Equipped*



This light shows when the front fog lights are ON.

21. *Anti-Lock Warning Light (ABS) — If Equipped*



This light monitors the Anti-Lock Brake System (ABS) described elsewhere in this manual. This

light will come on when the ignition key is turned to the ON position and may stay on for as long as four seconds.

If the ABS light remains on or comes on during driving, it indicates that the Anti-Lock portion of the brake system is not functioning and that service is required, however, the conventional brake system will continue to operate normally provided that the BRAKE warning light is not on.

If the ABS light is on, the brake system should be serviced as soon as possible to restore the benefit of Anti-Lock Brakes.

The warning light should be checked frequently to assure that it is operating properly. Turn the ignition key to the on position, but do not start the vehicle. The light should come on. If the light does not come on, have the system checked by an authorized dealer.

22. Oil Pressure Light

 Shows low engine oil pressure. The light will come on and remain on when the ignition switch is turned from the OFF to the ON position, and the light will turn off after the engine is started. If the bulb does not come on during starting, have the system checked by an authorized dealer.

If the light comes on and remains on while driving, stop the vehicle and shut off the engine. **DO NOT OPERATE THE VEHICLE UNTIL THE CAUSE IS CORRECTED.**

The light does not show the quantity of oil in the engine. This can be determined using the procedure shown in Section 7.

23. Airbag Light



The light comes on and remains on for 6 to 8 seconds as a bulb check when the ignition switch is first turned ON. If the light does not

come on during starting, stays on, or comes on while driving, have the system checked by an authorized dealer.

24. High Beam Indicator

 This light shows that the headlights are on high beam. Pull the turn signal lever toward the steering wheel to switch the headlights from high or low beam.

25. Compass Mini-Trip Computer (CMTC) or Electronic Vehicle Information Center (EVIC) Button—If Equipped

Pushing this button will switch between the different EVIC functions.

Press the CMTC reset button to scroll through sub menus (i.e. Trip Functions: AVG. Fuel Economy, DTE, Elapsed Time, and Units).

26. *Compass Mini-Trip Computer (CMTC) or Electronic Vehicle Information Center (EVIC) Display — If Equipped*

On vehicles equipped with Electronic Vehicle Information Center (EVIC), when the appropriate conditions exist, this display shows the EVIC messages. Refer to “Electronic Vehicle Information Center” later in this section.

On vehicles equipped with Compass Mini Trip Computer (CMTC) the display provides the outside temperature, one of eight compass headings to indicate the direction the vehicle is facing and the current radio station. Refer to “Compass Mini Trip Computer” later in this section.

COMPASS MINI TRIP COMPUTER (CMTC) — IF EQUIPPED

NOTE: The compass on your vehicle is self-calibrating, eliminating the need to manually calibrate the compass.

The Compass Mini Trip Computer features a driver-interactive display (displays information on outside temperature, compass direction, and trip information). The display is located on the lower left part of the cluster below the fuel and engine temperature gauge.

Compass Mini Trip Computer Reset Button

CMTC Reset Button — Secondary Reset Button

Press the left compass/temperature reset button to scroll through sub menus (i.e. Trip Functions: AVG. Fuel Economy, DTE, Elapsed Time, and Units (U.S. or Metric).

When the appropriate conditions exist, the following messages will display in the window below the fuel and engine temperature gauge:

- E** Eight-point compass headings are displayed
(N, S, E, W, NE, NW, SE, SW)
- 14°F** Temperature (Fahrenheit or Celsius)
- AVG** Average Fuel Economy (U.S. or Metric)
- DTE** Distance to Empty
- ET** Elapsed Time

NOTE: Temperature and Average Fuel Economy can be changed from U.S. or Metric. by pressing and holding the (left) secondary push button.

Compass/Temperature Display

Compass Variance

Compass Variance is the difference between magnetic North and Geographic North. In some areas of the country, the difference between magnetic and geographic North is great enough to introduce some compass error. In order to ensure compass accuracy, the compass variance should be properly set according to the compass variance zone map for the vehicle's current location. The compass in your vehicle will now automatically compensate for this difference.

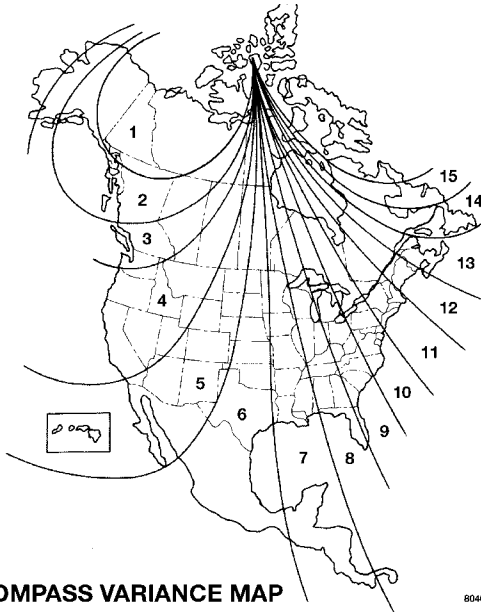

NOTE: Magnetic materials such as a laptop computer, cell phone, and PDA's (anything with a battery), should be kept away from the top of the instrument panel. This is where the compass sensor is located.

To Set the Variance

Start the engine, and leave the transmission gear selector lever in the PARK position. Press and hold (approximately ten seconds) the compass/temperature reset button until the current variance zone number is displayed. To change the zone, press and release the reset button to increment the variance one step. Repeat as necessary, until the desired variance is achieved.

NOTE: The factory default zone is 8. During programming, the zone value will wrap around from zone 15 to zone 1.

Automatic Compass Calibration

The compass on your vehicle is self-calibrating, eliminating the need to manually calibrate the compass. When the vehicle is new, the compass may appear erratic and the CAL indicator message will flash in the EVIC until the calibration is complete.

A good calibration requires a level surface and an environment free from large metallic objects such as buildings, bridges, underground cables, railroad tracks, etc.

Calibrate the compass by driving slowly, under 5 mph (8 km/h) in one or more complete circles in a area free from large metallic objects, until the CAL indicator in the EVIC turns off. The compass will now function normally.

NOTE: Keep all magnetic objects, such as laptop computers, cell phones and PDAs (anything with a battery) away from the compass sensor which is located in the top of the instrument panel. These devices can interfere with compass accuracy and performance.

Manual Compass Calibration

If the compass appears to be inaccurate, you may wish to manually calibrate the compass. Prior to calibrating the compass, make sure the proper compass variance value (zone) is selected (refer to the above “Compass Variance” for additional information). Then continue to calibrate the compass as follows:

1. Start the engine, and leave the transmission in the PARK position.
2. Press and hold (approximately 10 seconds) the Compass/Temperature reset button until the current variance zone number is displayed.
3. Release the reset button, then press and hold again (approximately 10 seconds), until the direction is displayed with the “CAL” indicator on continuously in the display.

4. To complete the compass calibration, drive the vehicle in one or more complete 360 degree circles under 5 mph (8 km/h) in an area free from power lines, large metallic objects, until the “CAL” indicator turns off. The compass will now function normally.

Odometer Display

When the appropriate conditions exist, the following odometer messages will display:

- CRUISE** Cruise Activated
- gASCAP** Fuel Cap Fault
- noFUSE** Fuse Fault

These messages can be manually turned off by pressing the right reset button (on the instrument cluster).

Trip Odometer (ODO)

This display shows the distance traveled since the last reset. Press and release the right button (on the instrument cluster) to switch from odometer, to trip A or trip B. Press and hold the right button while the odometer/trip odometer is displayed to reset.

Trip A

Shows the total distance traveled for trip A since the last reset.

Trip B

Shows the total distance traveled for trip B since the last reset.

ELECTRONIC VEHICLE INFORMATION CENTER (EVIC) – If Equipped

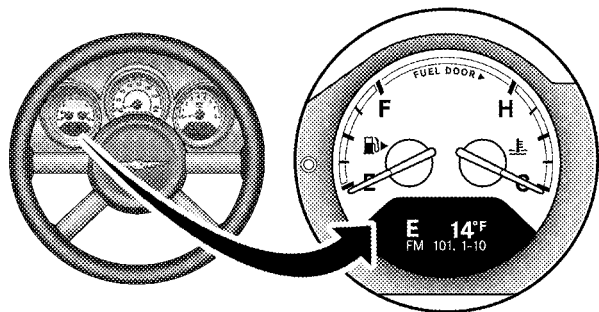

EVIC Location

816415d1

NOTE: The compass on your vehicle is self-calibrating, eliminating the need to manually calibrate the compass.

The Electronic Vehicle Information Center (EVIC) features a driver-interactive display. It is located in the lower left part of the cluster below the fuel and engine temperature gauge. The EVIC consists of the following:

- System Status
- Vehicle information warning message displays
- Personal Settings (customer programmable features)
- Compass heading
- Outside temperature display
- Trip computer functions
- UConnect™ hands-free communication system displays — If Equipped
- Audio mode display

When the appropriate conditions exist, the Electronic Vehicle Information Center (EVIC) displays the following messages.

- Turn Signal On (with a continuous warning chime)
- Left Front Turn Signal Lamp Out (with a single chime)
- Left Rear Turn Signal Lamp Out (with a single chime)
- Right Front Turn Signal Lamp Out (with a single chime)
- Right Rear Turn Signal Lamp Out (with a single chime)
- RKE Battery Low (with a single chime)
- Personal Settings Not Available – Vehicle Not in (automatic transmissions) or vehicle is in motion (manual transmissions).
- Left/Right Front Door Ajar (one or more, with a single chime if speed is above 1 mph)
- Left/Right Rear Door Ajar (one or more, with a single chime if speed is above 1 mph)
- Door (S) Ajar (with a single chime if vehicle is in motion)
- Trunk Ajar (with a single chime)
- Headlamps On
- Key In Ignition

EVIC Functions

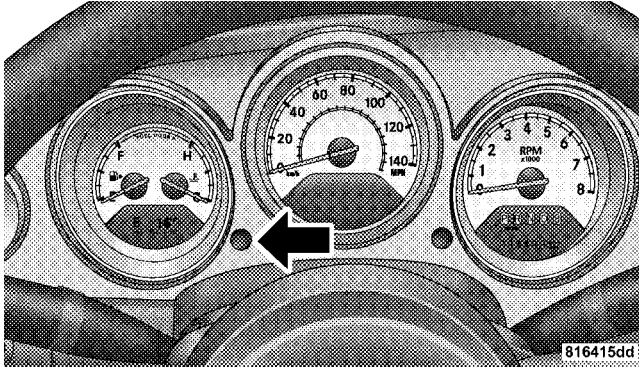

EVIC Button

Press the EVIC button until one of the following functions are displayed on the EVIC:

- Compass/Temperature/Audio
- Average Fuel Economy

- Distance To Empty (DTE)
- Elapsed Time
- Tire Pressure Monitor (TPM)
- Personal Settings

To Reset The Display

Pressing and holding the EVIC button once will clear the resettable function currently being displayed. Reset will only occur if a resettable function is currently being displayed. To reset all resettable functions, press and release the EVIC button a second time within three seconds of resetting the currently displayed function (Reset ALL will be displayed during this three second window).

Compass/Temperature/Audio

Press and release the EVIC button to display one of eight compass headings to indicate the direction the vehicle is facing, the outside temperature and the current radio station.

For additional information regarding the compass, refer to Personal Settings (Customer Programmable Features) in this section.

Average Fuel Economy

Shows the average fuel economy since the last reset. When the fuel economy is reset, the display will read "RESET" or show dashes for two seconds. Then, the history information will be erased, and the averaging will continue from where it was before the reset.

Distance To Empty (DTE)

Shows the estimated distance that can be travelled with the fuel remaining in the tank. This estimated distance is determined by a weighted average of the instantaneous and average fuel economy, according to the current fuel tank level. This is not resettable.

NOTE: Significant changes in driving style or vehicle loading will greatly affect the actual drivable distance of the vehicle, regardless of the DTE displayed value.

When the DTE value is less than 30 miles estimated driving distance, the DTE display will change to a text display of "LOW FUEL". This display will continue until the vehicle runs out of fuel. Adding a significant amount of fuel to the vehicle will turn off the "LOW FUEL" text and a new DTE value will be displayed, based on the current values in the DTE calculation and the current fuel tank level.

Elapsed Time

Shows the total elapsed time of travel since the last reset when the ignition switch is in the ACC position. Elapsed time will increment when the ignition switch is in the ON or START position.

Tire Pressure Monitor (TPM)

Refer to Section 5, “Tire Pressure Monitoring System (TPMS) for system operation.

Personal Settings (Customer Programmable Features)

This allows the driver to set and recall features when the transmission is in PARK (automatic transmission) or the vehicle is stopped (manual transmissions).

Press and release the EVIC button until Personal Settings is displayed in the EVIC.

Use the EVIC button to display one of the following choices:

Language

When in this display you may select different languages for all display nomenclature, including the trip functions. Pressing the EVIC button while in this display selects English, Espanol, Deutsch, Italiano, or Francais depending on availability. As you continue the displayed information will be shown in the selected language.

NOTE: UConnect™ language will not change using the EVIC. Please refer to “Language Selection” in the HANDS-FREE COMMUNICATION (UConnect™) — IF EQUIPPED section of this manual for details.

Lock Doors Automatically at 15 MPH (24 Km/h)

When ON is selected all doors lock automatically when the speed of the vehicle reaches 15 mph (24 km/h). Press and hold the EVIC button when in this display until ON or OFF appears to make your selection.

Auto Unlock On Exit

When ON is selected all the vehicle's doors will unlock when the driver's door is opened if the vehicle is stopped (manual transmissions) or the vehicle is stopped and the transmission is in PARK or NEUTRAL position (automatic transmissions). Press and hold the EVIC button when in this display until ON or OFF appears to make your selection.

Remote Unlock Driver's Door 1st

When **DRIVER'S DOOR 1st** is selected only the driver's door will unlock on the first press of the remote keyless entry unlock button and require a second press to unlock the remaining locked doors. When **REMOTE UNLOCK ALL DOORS** is selected all of the doors will unlock at the first press of the remote keyless entry unlock button. Press and hold the EVIC button when in this display until **DRIVER'S DOOR 1st** or **ALL DOORS** appears to make your selection.

Sound Horn with Remote Key Lock

When ON is selected a short horn sound will occur when the remote keyless entry LOCK button is pressed. This feature may be selected with or without the flash lights on LOCK/UNLOCK feature. Press and hold the EVIC button when in this display until ON or OFF appears to make your selection.

Flash Lights with Remote Key Lock

When ON is selected, the front and rear turn signals will flash when the doors are locked or unlocked using the remote keyless entry transmitter. This feature may be selected with or without the sound horn on lock feature selected. Press and hold the EVIC button when in this display until ON or OFF appears to make your selection.

Delay Turning Headlamps Off

When this feature is selected the driver can choose to have the headlamps remain on for 0, 30, 60, or 90 seconds

when exiting the vehicle. Press and hold the EVIC button when in this display until 0, 30, 60, or 90 appears to make your selection.

Headlamps On With Wipers (Available with Auto Headlights Only)

When ON is selected and the headlight switch is in the AUTO position, the headlights will turn on approximately 10 seconds after the wipers are turned on. The headlights will also turn off when the wipers are turned off if they were turned on by this feature. Press and hold the EVIC button when in this display until ON or OFF appears to make your selection.

NOTE: Turning the headlights on during the daytime causes the instrument panel lights to dim. To increase the brightness, refer to “Lights” in this section.

Delay Power Off to Accessories Until Exit

When this feature is selected, the power window switches, radio, hands-free system, DVD video system,

power sunroof, and power outlets will remain active for up to 60 minutes after the ignition switch has been turned off. Opening a vehicle door will cancel this feature. Press and hold the EVIC button when in this display until “Off”, “45 sec.”, “5 min.”, or “10 min.” appears to make your selection.

Turn Headlamps on with Remote Key Unlock

When this feature is selected the headlamps will activate and remain on for up to 90 seconds when the doors are unlocked using the remote keyless entry transmitter. Press and hold the EVIC button when in this display until “OFF”, “30 sec.”, “60 sec.”, or “90 sec.” appears to make your selection.

Confirmation of Voice Commands — If Equipped

When ON is selected all voice commands from the U-Connect™ system are confirmed. Press and hold the EVIC button when in this display until ON or OFF appears to make your selection.

Display English or Metric

The EVIC, odometer, and navigation system units can be changed between English and Metric.

Press and hold the EVIC button when in this display until “US” or “METRIC” appears to make your selection.

Automatic Compass Calibration

The compass on your vehicle is self-calibrating, eliminating the need to manually calibrate the compass. When the vehicle is new, the compass may appear erratic and the “CAL” indicator message will flash in the EVIC until the calibration is complete.

A good calibration requires a level surface and an environment free from large metallic objects such as buildings, bridges, underground cables, railroad tracks, etc.

Calibrate the compass by driving slowly, under 5 mph (8 km/h) in one or more complete circles in a area free from

large metallic objects, until the “CAL” indicator in the EVIC turns off. The compass will now function normally.

NOTE: Keep all magnetic objects, such as laptop computers, cell phones and PDA’s (anything with a battery) away from the compass sensor which is located in the top of the instrument panel. These devices can interfere with compass accuracy and performance.

Manual Compass Calibration

If the compass appears to be inaccurate, you may wish to manually calibrate the compass. Prior to calibrating the compass, make sure the proper Compass Variance Value is selected (Refer to “Compass Variance” for additional information). Then continue to calibrate the compass as follows:

1. Start the engine and leave the transmission in the PARK position.

2. Press and release the EVIC button several times until the EVIC displays the Personal Settings (Customer Programmable Features) menu.
3. Press and release the EVIC button several times until "Calibrate Compass (Yes)" is displayed. A long (longer than two seconds) EVIC button Press will place the Compass in calibration mode.
4. The "CAL" indicator will come on continuously in the EVIC display to indicate that the compass is now in the calibration mode and that the vehicle can now be driven to calibrate. Press the EVIC button from the "Calibrate Compass (Yes)" screen will exit the EVIC Customer Programmable features, and return it to its normal operating mode).
5. Drive the vehicle slowly, under 5 mph (8 km/h), completing one or more circles (in an area free from large metal or metallic objects) until the "CAL" indicator turns off. The compass will now function normally.

Compass Variance

Compass Variance is the difference between magnetic North and Geographic North. In some areas of the country, the difference between magnetic and geographic North is great enough to introduce some compass error. In order to ensure compass accuracy, the compass variance should be properly set according to the variance zone map for the vehicle's current location. The compass in your vehicle will now automatically compensate for this difference.

NOTE: Magnetic materials such as a laptop computer, cell phone, and PDA's (anything with a battery), should be kept away from the top of the instrument panel. This is where the compass sensor is located.

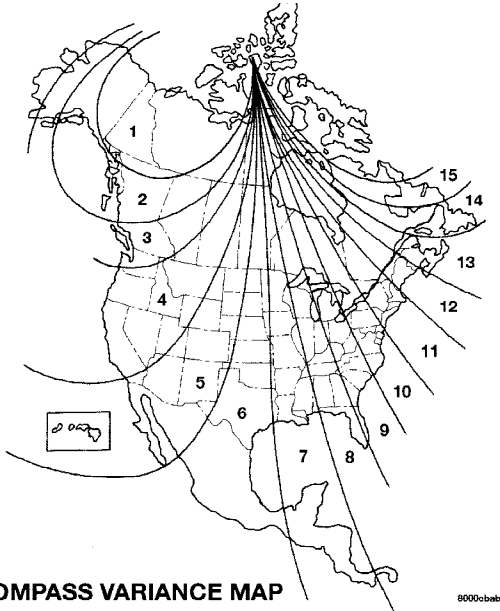

1. Turn the ignition switch to the ON position. Leave the gear selector lever in PARK.
2. Press and release the EVIC button several times until you have displayed the Personal Settings (Customer Programmable Features) menu.

3. Press and release the EVIC button until “Compass Variance” and the current Variance Value displays in the EVIC.

4

4. Press and release the EVIC button to increment the Variance Value by one, (one button press per update), until the proper variance zone is selected according to the map.

NOTE: The factory default Zone is 8. During programming, the Zone value will wrap around from Zone 15 to Zone 1.

5. Press and release the EVIC button to exit.

SETTING THE ANALOG CLOCK

To set the analog clock at the top center of the instrument panel, press and hold the button until the setting is correct. The clock will adjust slowly at first and then quicker the longer the button is held.

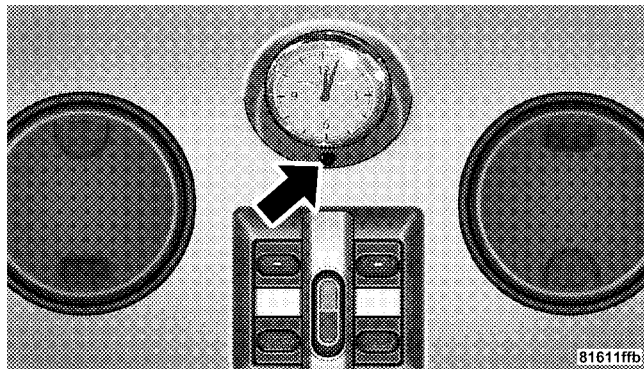

Setting The Analog Clock

RADIO GENERAL INFORMATION

Radio Broadcast Signals

The radio will provide excellent reception under most operating conditions. Like any system, however, automotive radios have performance limitations, due to mobile operation and natural phenomena, which might lead you to believe your sound system is malfunctioning. To help you understand and save you concern about these “apparent” malfunctions, you must understand a point or two about the transmission and reception of radio signals.

Two Types of Signals

There are two basic types of radio signals: AM or Amplitude Modulation, in which the transmitted sound causes the amplitude, or height, of the radio waves to vary; and FM or Frequency Modulation, in which the frequency of the wave is varied to carry the sound.

Electrical Disturbances

Radio waves may pick up electrical disturbances during transmission. They mainly affect the wave amplitude, and thus remain a part of the AM reception. They interfere very little with the frequency variations that carry the the FM signal.

AM Reception

AM sound is based on wave amplitude, so AM reception can be disrupted by such things as lightning, power lines and neon signs.

FM Reception

Because FM transmission is based on frequency variations, interference that consists of amplitude variations can be filtered out, leaving the reception relatively clear, which is the major feature of FM radio.

NOTE: The radio, steering wheel radio controls (if equipped), and six-disc CD/DVD changer (if equipped) will remain active for up to 10 minutes after the ignition switch has been turned OFF. Opening a vehicle front door will cancel this feature.

SALES CODE REF — AM/FM/CD (SINGLE DISC) RADIO WITH OPTIONAL SATELLITE RADIO AND HANDS FREE PHONE CAPABILITY

NOTE: The radio sales code is located on the lower right side of your radio faceplate.

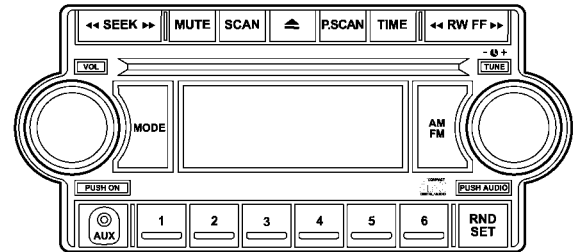

REF Radio

815eb156

Operating Instructions - Radio Mode

NOTE: The ignition switch must be in the ON or ACC position to operate the radio.

Power Switch/Volume Control (Rotary)

Press the ON/VOL control to turn the radio ON. Press the ON/VOL a second time to turn OFF the radio.

Electronic Volume Control

The electronic volume control turns continuously (360 degrees) in either direction without stopping. Turning the volume control to the right increases the volume and to the left decreases it.

When the audio system is turned on, the sound will be set at the same volume level as last played.

For your convenience, the volume can be turned down, but not up, when the audio system is off and the ignition is ON.

Mode Button (Radio Mode)

Press the MODE button repeatedly to select between the CD player and Satellite Radio (if equipped).

SEEK Button (Radio Mode)

Press and release the SEEK button to search for the next listenable station in either AM/FM or Satellite (if equipped) mode. Press the right side of the button to seek up and the left side to seek down. The radio will remain tuned to the new station until you make another selection. Holding the button will bypass stations without stopping until you release it.

MUTE Button (Radio Mode)

Press the MUTE button to cancel the sound from the speakers. MUTE will display. Press the MUTE button a second time and the sound from the speakers will return. Rotating the volume control, turning the radio ON/OFF, or turning ON/OFF the ignition, will cancel the MUTE feature.

NOTE: In Hands-Free Phone (if equipped) mode, the MUTE button mutes the microphone.

SCAN Button (Radio Mode)

Pressing the SCAN button causes the tuner to search for the next listenable station in either, AM, FM, or Satellite (if equipped) frequencies, pausing for five seconds at each listenable station before continuing to the next. To stop the search, press SCAN a second time.

PSCAN Button (Radio Mode)

Pressing the PSCAN button causes the tuner to scan through preset stations in either, AM, FM, or Satellite (if equipped) frequencies, pausing for five seconds at each preset station before continuing to the next. To stop the search, press PSCAN a second time.

TIME Button

Press the TIME button and the time of day will display for five seconds.

Clock Setting Procedure

1. Press and hold the TIME button until the hours blink.
2. Adjust the hours by turning the TUNE/AUDIO control.
3. After the hours are adjusted, press the TUNE/AUDIO control to set the minutes. The minutes will begin to blink.
4. Adjust the minutes using the TUNE/AUDIO control.
5. To exit, press any button/knob or wait five seconds.

RW/FF (Radio Mode)

Pressing the Rewind/Fast Forward button causes the tuner to search for the next frequency in the direction of the arrows. This feature operates in either AM, FM or Satellite (if equipped) frequencies.

TUNE Control (Radio Mode)

Turn the rotary TUNE control clockwise to increase or counterclockwise to decrease the frequency.

AM/FM Button (Radio Mode)

Press the button to select AM or FM modes.

Setting the Tone, Balance, and Fade

Press the rotary TUNE control, and BASS will display. Turn the TUNE control to the right or left to increase or decrease the Bass tones.

Press the rotary TUNE control a second time and MID will display. Turn the TUNE control to the right or left to increase or decrease the Mid-Range tones.

Press the rotary TUNE control a third time and TREB will display. Turn the TUNE control to the right or left to increase or decrease the Treble tones.

Press the rotary TUNE control a fourth time and BAL will display. Turn the TUNE control to the right or left to adjust the sound level from the right or left side speakers.

Press the rotary TUNE control a fifth time and FADE will display. Turn the TUNE control to the left or right to adjust the sound level between the front and rear speakers.

Press the tune control again or wait five seconds to exit setting tone, balance, and fade.

RND/SET Button (Radio Mode) To Set The Pushbutton Memory

When you are receiving a station that you wish to commit to pushbutton memory, press the SET button. The symbol SET 1 will now show in the display window. Select the button (1-6) you wish to lock onto this station and press and release that button. If a button is not selected within five seconds after pressing the SET button, the station will continue to play but will not be stored into pushbutton memory.

You may add a second station to each pushbutton by repeating the above procedure with this exception: Press the SET button twice and SET 2 will show in the display window. Each button can be set for SET 1 and SET 2 in both AM and FM. This allows a total of 12 AM, 12 FM, and 12 Satellite (if equipped) stations to be stored into pushbutton memory. The stations stored in SET 2 memory can be selected by pressing the pushbutton twice.

Every time a preset button is used, a corresponding button number will display.

Preset Buttons 1 - 6 (Radio Mode)

These buttons tune the Radio to the stations that you commit to pushbutton memory, 12 AM, 12 FM, and 12 Satellite (if equipped) stations.

Operating Instructions - CD Mode

NOTE: The ignition switch must be in the ON or ACC position to operate the radio.

Inserting The Compact Disc (Single CD Player)

Gently insert one CD into the CD player with the CD label facing up. The CD will automatically be pulled into the CD Player and the CD icon will illuminate on the radio display.

If the volume control is ON, the unit will switch to CD mode and begin to play. The display will show the track number and play time in minutes and seconds. Play will begin at the start of track one.

NOTE:

- On some vehicles, you may insert or eject a disc with the radio or ignition switch OFF.

- If you insert a disc with the ignition ON and the radio OFF, the CD will automatically be pulled into the CD player.
- This radio does not play discs with MP3 tracks.

SEEK Button (CD Mode)

Press the right side of the SEEK button for the next track on the CD. Press the left side of the button to return to the beginning of the current track, or return to the beginning of the previous track if the CD is within the first 10 seconds of the current selection.

MUTE Button (CD Mode)

Press the MUTE button to cancel the sound from the speakers. "MUTE" will display. Press the MUTE button a second time and the sound from the speakers will return. Rotating the volume control or turning OFF the ignition will also return the sound from the speakers.

SCAN Button (CD Mode)

Press this button to play the first 10 seconds of each track. To stop the scan function, press the button a second time.

EJECT Button (CD Mode)

Press this button and the disc will unload and move to the entrance for easy removal. The unit will switch to the last selected mode.

If you do not remove the disc within 15 seconds, it will be reloaded. The radio mode will continue to appear.

TIME Button (CD Mode)

Press this button to change the display from elapsed CD playing time to time of day. The time of day will display for five seconds.

RW/FF (CD Mode)

Press and hold the FF (Fast Forward) and the CD player will begin to fast forward until FF is released. The RW (Reverse) button works in a similar manner.

Press and hold the FF button to fast forward through the tracks. Release the FF button to stop the fast forward feature. If the RW button is pressed, the current track will reverse to the beginning of the track and begin playing.

RND/SET Button (Random Play Button) (CD Mode)

Press this button while the CD is playing to activate Random play. This feature plays the selections on the compact disc in random order to provide an interesting change of pace.

Press the SEEK button to move to the next randomly selected track.

Press the RND button a second time to stop Random play.

Operating Instructions - Auxiliary Mode

The auxiliary (AUX) jack is an audio input jack, which allows the user to plug in a portable device such as an MP3 player, cassette player, or microphone and utilize the vehicle's audio system to amplify the source and play through the vehicle speakers.

The auxiliary mode becomes active when an electrical device is plugged into the AUX jack using a standard 3.5 mm stereo audio cable and the user presses and releases the MODE button until AUX appears on the display.

NOTE: The radio will return to the last stored mode if the ignition switch is turned from the OFF/LOCK position to the ACC position, the radio is turned on, and the radio was previously in the AUX mode.

SEEK Button (Auxiliary Mode)

No function.

MUTE Button (Auxiliary Mode)

Press the MUTE button to cancel the sound from the speakers. "MUTE" will display. Press the MUTE button a second time and the sound from the speakers will return. Rotating the volume control or turning off the ignition will also return the sound from the speakers.

SCAN Button (Auxiliary Mode)

No function.

EJECT Button (Auxiliary Mode)

No function.

PSCAN Button (Auxiliary Mode)

No function.

TIME Button (Auxiliary Mode)

Press this button to change the display from elapsed playing time to time of day. The time of day will display for five seconds.

RW/FF (Auxiliary Mode)

No function.

RND/SET Button (Auxiliary Mode)

No function.

Mode Button (Auxiliary Mode)

Press the MODE button repeatedly to select between the CD player and Satellite Radio (if equipped).

Operating Instructions - Hands-Free Phone — If Equipped

Refer to the "Hands-Free Phone (UConnect®)" section of this Owner's Manual.

Operating Instructions - Satellite Radio — If Equipped

Refer to the "Satellite Radio" section of this Owner's Manual.

**SALES CODE RAQ – AM/FM/CD (6-DISC) RADIO
WITH OPTIONAL SATELLITE RADIO,
HANDS-FREE PHONE, AND VIDEO
ENTERTAINMENT SYSTEMS (VES™)
CAPABILITIES**

NOTE: The radio sales code is located on the lower right side of your radio faceplate.

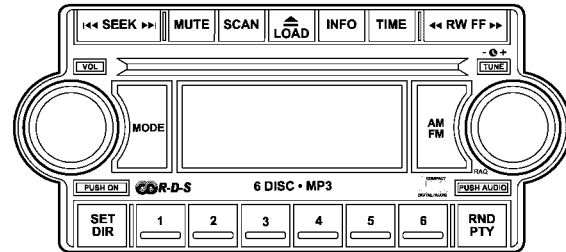

4

81365bb1

**RAQ Radio
Operating Instructions - Radio Mode**

NOTE: The ignition switch must be in the ON or ACC position to operate the radio.

Power Switch/Volume Control (Rotary)

Press the ON/VOL control to turn the radio ON. Press the ON/VOL a second time to turn off the radio.

Electronic Volume Control

The electronic volume control turns continuously (360 degrees) in either direction without stopping. Turning the volume control to the right increases the volume and to the left decreases it.

When the audio system is turned on, the sound will be set at the same volume level as last played.

For your convenience, the volume can be turned down, but not up, when the audio system is off and the ignition is ON.

Mode Button (Radio Mode)

Press the MODE button repeatedly to select between the CD player, Satellite Radio, or Video Entertainment System (VES)TM (if equipped).

SEEK Button (Radio Mode)

Press and release the SEEK button to search for the next listenable station in either AM/FM or Satellite (if equipped) mode. Press the right side of the button to seek up and the left side to seek down. The radio will remain tuned to the new station until you make another selection. Holding the button will bypass stations without stopping until you release it.

MUTE Button (Radio Mode)

Press the MUTE button to cancel the sound from the speakers. "MUTE" will be displayed. Press the MUTE button a second time and the sound from the speakers will return. Rotating the volume control, turning the radio ON/OFF, or turning OFF the ignition will also return the sound from the speakers

NOTE: In Hands-Free Phone (if equipped) mode, the MUTE button mutes the microphone.

SCAN Button (Radio Mode)

Pressing the SCAN button causes the tuner to search for the next listenable station, in either AM, FM or Satellite (if equipped) frequencies, pausing for five seconds at each listenable station before continuing to the next. To stop the search, press SCAN a second time.

MSG or INFO Button (Radio Mode)

Press the MSG or INFO button for an RBDS station (one with call letters displayed). The radio will return a Radio Text message broadcast from an FM station (FM mode only).

TIME Button

Press the TIME button and the time of day will be displayed for five seconds.

Clock Setting Procedure

1. Press and hold the time button until the hours blink.

2. Adjust the hours by turning the TUNE/AUDIO control.

3. After the hours are adjusted, press the TUNE/AUDIO control to set the minutes. The minutes will begin to blink.

4. Adjust the minutes by turning the TUNE/AUDIO control.

5. To exit, press any button/knob or wait five seconds.

RW/FF (Radio Mode)

Pressing the Rewind/Fast Forward button causes the tuner to search for the next frequency in the direction of the arrows. This feature operates in either AM, FM or Satellite (if equipped) frequencies.

TUNE Control (Radio Mode)

Turn the rotary TUNE control clockwise to increase or counterclockwise to decrease the frequency.

AM/FM Button (Radio Mode)

Press the button to select AM or FM Modes.

Setting the Tone, Balance, and Fade

Press the rotary TUNE control, and BASS will display. Turn the TUNE control to the right or left to increase or decrease the Bass tones.

Press the rotary TUNE control a second time and MID will display. Turn the TUNE control to the right or left to increase or decrease the Mid Range tones.

Press the rotary TUNE control a third time and TREBLE will display. Turn the TUNE control to the right or left to increase or decrease the Treble tones.

Press the rotary TUNE control a fourth time and BALANCE will display. Turn the TUNE control to the right or left to adjust the sound level from the right or left side speakers.

Press the rotary TUNE control a fifth time and FADE will display. Turn the TUNE control to the left or right to adjust the sound level between the front and rear speakers.

Press the rotary TUNE control again to exit setting tone, balance and fade.

RND/PTY Button (Radio Mode)

Pressing this button once will turn on the PTY mode for five seconds. If no action is taken during the five second time out the PTY icon will turn off. Pressing the PTY button or turning the TUNE rotary knob within five seconds will allow the program format type to be selected. Many radio stations do not currently broadcast PTY information.

Toggle the PTY button to select the following format types:

Program Type	16 Digit-Character Display
No program type or undefined	None
Adult Hits	Adult_Hits
Alert Alert	Alert Alert
Classical	Classical
Classic Rock	Classic_Rock
College	College
Country	Country
Emergency Test	Emergency Test
Foreign Language	Foreign_Language
Information	Information
Jazz	Jazz
News	News
Nostalgia	Nostalgia

Program Type	16 Digit-Character Display
Oldies	Oldies
Personality	Personality
Public	Public
Rhythm and Blues	Rhythm_and_Blues
Religious Music	Religious_Music
Religious Talk	Religious_Talk
Rock	Rock
Soft	Soft
Soft Rock	Soft_Rock
Soft Rhythm and Blues	Soft_R_&_B
Sports	Sports
Talk	Talk
Top 40	Top_40
Weather	Weather

By pressing the SEEK button when the PTY icon is displayed, the radio will be tuned to the next frequency station with the same selected PTY name. The PTY function only operates when in the FM mode.

If a preset button is activated while in the PTY (Program Type) mode, the PTY mode will be exited and the radio will tune to the preset station.

SET/DIR Button (Radio Mode) — To Set the Pushbutton Memory

When you are receiving a station that you wish to commit to pushbutton memory, press the SET/DIR button. The symbol SET 1 will now show in the display window. Select the button (1-6) you wish to lock onto this station and press and release that button. If a button is not selected within five seconds after pressing the SET/DIR button, the station will continue to play but will not be stored into pushbutton memory.

You may add a second station to each pushbutton by repeating the above procedure with this exception: Press the SET/DIR button twice and SET 2 will show in the display window. Each button can be set for SET 1 and SET 2 in both AM and FM. This allows a total of 12 AM, 12 FM and 12 Satellite (if equipped) stations to be stored into pushbutton memory. The stations stored in SET 2 memory can be selected by pressing the pushbutton twice.

Every time a preset button is used, a corresponding button number will be displayed.

Buttons 1 - 6 (Radio Mode)

These buttons tune the Radio to the stations that you commit to pushbutton memory, 12AM, 12 FM, and 12 Satellite (if equipped) stations.

Operating Instructions - (CD Mode for CD Audio Play)

NOTE: The ignition switch must be in the ON or ACC position to operate the radio.

NOTE: This Radio is capable of playing compact discs (CD), recordable compact discs (CD-R), rewritable compact discs (CD-RW) compact discs with MP3 tracks and multisession compact discs with CD and MP3 tracks.

Inserting Compact Disc(s)

Gently insert one CD into the CD player with the CD label facing up. The CD will automatically be pulled into the CD Player and the CD icon will illuminate on the radio display.

CAUTION!

This CD player will accept 4 3/4 in (12 cm) discs only. The use of other sized discs may damage the CD player mechanism.

You may eject a disc with the radio OFF.

If you insert a disc with the ignition ON and the radio ON, the unit will switch from radio to CD mode and begin to play when you insert the disc. The display will show the disc number, the track number, and index time in minutes and seconds. Play will begin at the start of track one.

SEEK Button (CD Mode for CD Audio Play)

Press the right side of the SEEK button for the next selection on the CD. Press the left side of the button to return to the beginning of the current selection, or return to the beginning of the previous selection if the CD is within the first 10 seconds of the current selection.

MUTE Button (CD Mode for CD Audio Play)

Press the MUTE button to cancel the sound from the speakers. "MUTE" will be displayed. Press the MUTE button a second time and the sound from the speakers will return. Rotating the volume control, turning the radio ON/OFF, or turning OFF the ignition will also return the sound from the speakers.

SCAN Button (CD Mode for CD Audio Play)

Press the SCAN button to scan through each track on the CD currently playing.

LOAD/EJECT Button (CD Mode for CD Audio Play)**LOAD/ EJECT - Load**

Press the LOAD/EJECT button and the push-button with the corresponding number where the CD is being loaded. The radio will display PLEASE WAIT and prompt when to INSERT DISC. After the radio displays "LOAD DISC" insert the CD into the player.

Radio display will show "LOADING DISC" when the disc is loading, and "READING DISC" when the radio is reading the disc.

LOAD / EJT - Eject

Press the LOAD/ EJT button and the push-button with the corresponding number where the CD was loaded and the disc will unload and move to the entrance for easy removal.

Radio display will show "EJECTING DISC" when the disc is being ejected and prompt the user to remove the disc.

Press and hold the LOAD/ EJT button for five seconds and all CDs will be ejected from the radio.

If you have ejected a disc and have not removed it within 15 seconds, it will be reloaded. If the CD is not removed, the radio will continue to play the non-removed CD. If the CD is removed and there are other CDs in the radio, the radio will play the next CD after a two minute timeout. If the CD is removed and there are no other CDs in the radio, the radio will remain in CD mode and display "INSERT DISC" for 10 seconds. If no discs are inserted within 10 seconds "NO DISCS LOADED" will be displayed.

On some vehicles a disc can be ejected with the radio and ignition OFF.

TIME Button (CD Mode for CD Audio Play)

Press this button to change the display from a large CD playing time display to a small CD playing time display.

RW/FF (CD Mode for CD Audio Play)

Press and hold FF (Fast Forward) and the CD player will begin to fast forward until FF is released or RW or another CD button is pressed. The RW (Reverse) button works in a similar manner.

Press and hold the FF button to fast forward through the tracks. Release the FF button to stop the fast forward feature.

TUNE Control (CD Mode for CD Audio Play)

Pressing the TUNE control allows the setting of the Tone, Fade, and Balance. See Radio Mode.

AM/FM Button (CD Mode for CD Audio Play)

Switches the Radio to the Radio mode.

RND/PTY Button (Random Play Button) (CD Mode for CD Audio Play)

Press this button while the CD is playing to activate Random Play. This feature plays the selections on the compact disc in random order to provide an interesting change of pace.

Press the SEEK button to move to the next randomly selected track.

Press the RND button a second time to stop Random play.

Buttons 1 - 6 (CD Mode for CD Audio Play)

Selects disc positions 1 - 6 for Play/Load/Eject.

Notes On Playing MP3 Files

The radio can play MP3 files, however, acceptable MP3 file recording media and formats are limited. When writing MP3 files, pay attention to the following restrictions.

Supported Media (Disc Types)

The MP3 file recording media supported by the radio are CD-ROM, CD-R and CD-RW.

Supported Medium Formats (File Systems)

The medium formats supported by the radio are ISO 9660 Level 1 and Level 2 and includes the Joliet extension. When reading discs recorded using formats other than ISO 9660 Level 1 and Level 2, the radio may fail to read files properly and may be unable to play the file normally. UDF and Apple HFS formats are not supported.

The radio uses the following limits for file systems:

- Maximum number of directory levels: 15
- Maximum number of files: 255
- Maximum number of folders: 100

- Maximum number of characters in file/folder names:
 - Level 1: 12 (including a separator "." and a 3-character extension)
 - Level 2: 31 (including a separator "." and a 3-character extension)

Multisession disc formats are supported by the radio. Multisession discs may contain combinations of normal CD audio tracks and computer files (including MP3 files). Discs created with an option such as "keep disc open after writing" are most likely multisession discs. The use of multisession for CD audio or MP3 playback may result in longer disc loading times.

Supported MP3 File Formats

The radio will recognize only files with the *.mp3 extension as MP3 files. Non-MP3 files named with the *.mp3

extension may cause playback problems. The radio is designed to recognize the file as an invalid MP3 and will not play the file.

When using the MP3 encoder to compress audio data to an MP3 file, the bit rate and sampling frequencies in the following table are supported. In addition, variable bit rates (VBR) are also supported. The majority of MP3 files use a 44.1 kHz sampling rate and a 192, 160, 128, 96 or VBR bit rates.

MPEG Specification	Sampling Frequency (kHz)	Bit rate (kbps)
MPEG-1 Audio Layer 3	48, 44.1, 32	320, 256, 224, 192, 160, 128, 112, 96, 80, 64, 56, 48, 40, 32
MPEG-2 Audio Layer 3	24, 22.05, 16	160, 128, 144, 112, 96, 80, 64, 56, 48, 40, 32, 24, 16, 8

ID3 Tag information for artist, song title and album title are supported for version 1 ID3 tags. ID3 version 2 is not supported by the radios.

Playlist files are not supported. MP3 Pro files are not supported.

Playback of MP3 Files

When a medium containing MP3 data is loaded, the radio checks all files on the medium. If the medium contains a lot of folders or files, the radio will take more time to start playing the MP3 files.

Loading times for playback of MP3 files may be affected by the following:

- Media - CD-RW media may take longer to load than CD-R media
- Medium formats - Multisession discs may take longer to load than non-multisession discs

- Number of files and folders - Loading times will increase with more files and folders

To increase the speed of disc loading, it is recommended to use CD-R media and single-session discs. To create a single-session disc, enable the Disc at Once option before writing to the disc.

Operating Instructions - (CD Mode for MP3 Audio Play)

SEEK Button (CD Mode for MP3 Play)

Pressing the right side of the SEEK button plays the next MP3 File. Pressing the left side of the SEEK button plays the beginning of the MP3 file. Pressing the button within the first ten seconds plays the previous file.

LOAD/EJECT Button (CD Mode for MP3 Play)

LOAD/EJECT - Load



Press the LOAD/ EJECT button and the push-button with the corresponding number where the CD is being loaded. The radio will display PLEASE WAIT and prompt when to INSERT DISC. After the radio displays "LOAD DISC" insert the CD into the player.

Radio display will show "LOADING DISC" when the disc is loading.

LOAD/EJECT - Eject



Press the LOAD/ EJECT button and the push-button with the corresponding number where the CD was loaded and the disc will unload and move to the entrance for easy removal. Radio display will show "EJECTING DISC" when the disc is being ejected and prompt the user to remove the disc.

If you have ejected a disc and have not removed it within 15 seconds, it will be reloaded. If the CD is not removed, the radio will continue to play the non-removed CD. If the CD is removed and there are other CDs in the radio, the radio will play the next CD after a two minute timeout. If the CD is removed and there are no other CD's in the radio, the radio will remain in CD mode and display "INSERT DISC" for two minutes. After two minutes the radio will go to the previous tuner mode.

MSG or INFO Button (CD Mode for MP3 Play)

Press and MSG or INFO button while playing MP3 disc. The radio scrolls through the following TAG information: Song Title, Artist, File Name, and Folder Name (if available).

Press the MSG or INFO button once more to return to "elapsed time" priority mode.

Press and hold the MSG or INFO button while in the message display priority mode or elapsed time display priority mode will display the song title for each file.

RW/FF (CD Mode for MP3 Play)

Press the FF side of the button to move forward through the MP3 selection.

TUNE Control (CD Mode for MP3 Play)

Pressing the TUNE control allows the adjustment of Tone, Balance, and Fade.

AM/FM Button (CD Mode for MP3 Play)

Switches back to Radio mode.

RND/ PTY Button (CD Mode for MP3 Play)

Pressing this button plays files randomly.

SET/DIR Button (CD Mode for MP3 Play)

Press the SET/DIR Button to display folders, when playing an MP3 discs that have a file/folder structure.

Turn the TUNE control to display available folders or move through available folders. Press the TUNE control to select a folder.

Buttons 1 - 6 (CD Mode for MP3 Play)

Selects disc positions 1 - 6 for Play/Load/Eject.

Operating Instructions - Hands-Free Phone (If Equipped)

Refer to Hands Free Phone in Section 3 of this Owner's Manual.

Operating Instructions - Satellite Radio Mode (If Equipped)

Refer to the Satellite Radio section of this Owner's Manual.

Operating Instructions - Video Entertainment System (VES™) (If Equipped)

Refer to separate Video Entertainment System (VES™) Guide.

SATELLITE RADIO — IF EQUIPPED

Satellite radio uses direct satellite to receiver broadcasting technology to provide clear digital sound, coast to coast. The subscription service provider is Sirius™ Satellite Radio. This service offers over 130 channels of music, sports, news, entertainment, and programming for children, directly from its satellites and broadcasting studios.

System Activation

To activate your Sirius Satellite Radio service, call the toll-free number 888-539-7474, or visit the Sirius web site at www.sirius.com. Please have the following information available when activating your system:

1. The Electronic Serial Number/Sirius Identification Number (ESN/SID).
2. Credit card information.
3. Your Vehicle Identification Number.

Electronic Serial Number/Sirius Identification Number (ESN/SID)

The Electronic Serial Number/Sirius Identification Number is needed to activate your Sirius Satellite Radio system. To access the ESN/SID, refer to the following steps:

ESN/SID Access With REF Radios

With the ignition switch in the ACCESSORY position and the radio OFF, press the CD Eject and Time buttons simultaneously for 3 seconds. The first four digits of the twelve-digit ESN/SID number will be displayed. Press the SEEK UP button to display the next four digits. Continue to press the SEEK UP button until all twelve ESN/SID digits have been displayed. The SEEK DOWN will page down until the first four digits are displayed. The radio will exit the ESN/SID mode when any other button is pushed, the ignition is turned OFF, or 5 minutes has passed since any button was pushed.

ESN/SID Access With RAQ Radios

With the ignition switch in the ACCESSORY position and the radio OFF, press the CD Eject and TIME buttons simultaneously for 3 seconds. All twelve ESN/SID numbers will be displayed. The radio will exit the ESN/SID mode when any other button is pushed, the ignition is turned OFF, or 5 minutes has passed since any button was pushed.

ESN/SID Access With Navigation Radios

Please refer to your Navigation User's Manual.

Selecting Satellite Mode in REF, and RAQ, Radios**Selecting Satellite Mode — REF Radio**

Press the MODE button repeatedly until the word "SAT" appears in the display.

A CD may remain in the radio while in the Satellite radio mode.

Selecting Satellite Mode — RAQ Radio

Press the MODE button repeatedly until the word "SAT" appears in the display.

These radios will also display the current station name and program type. For more information such as song title and artist press the MSG or INFO button.

A CD or tape may remain in the radio while in the Satellite radio mode.

Selecting a Channel

Press and release the SEEK or TUNE knob to search for the next channel. Press the top of the button to search up and the bottom of the button to search down. Holding the TUNE button causes the radio to bypass channels until the button is released.

Press and release the SCAN button (if equipped) to automatically change channels every 7 seconds. The radio will pause on each channel for 7 seconds before moving on to the next channel. The word "SCAN" will appear in the display between each channel change. Press the SCAN button a second time to stop the search.

NOTE: Channels that may contain objectionable content can be blocked. Contact Sirius Customer Care at 888-539-7474 to discuss options for channel blocking or unblocking. Please have your ESN/SID information available.

Storing and Selecting Pre-Set Channels

In addition to the 12 AM and 12 FM pre-set stations, you may also commit 12 satellite stations to push button memory. These satellite channel pre-set stations will not erase any AM or FM pre-set memory stations. Follow the memory pre-set procedures that apply to your radio.

Using the PTY (Program Type) Button (if equipped)

Follow the PTY button instructions that apply to your radio.

PTY Button "SCAN"

When the desired program type is obtained, press the "SCAN" button within five seconds. The radio will play 7 seconds of the selected channel before moving to the next channel of the selected program type. Press the "SCAN" button a second time to stop the search.

NOTE: Pressing the "SEEK" or "SCAN" button while performing a music type scan will change the channel by one and stop the search. Pressing a pre-set memory button during a music type scan, will call up the memory channel and stop the search.

PTY Button "SEEK"

When the desired program is obtained, press the "SEEK" button within five seconds. The channel will change to the next channel that matches the program type selected.

Satellite Antenna

To ensure optimum reception, do not place items on the roof around the rooftop antenna location. Metal objects placed within the line of sight of the antenna will cause decreased performance. Larger luggage items should be placed as far forward as possible. Do not place items directly on or above the antenna. The luggage rack (if equipped), should also not be positioned directly above the antenna.

Reception Quality

Satellite reception may be interrupted due to one of the following reasons.

- The vehicle is parked in an underground parking structure or under a physical obstacle.
- Dense tree coverage may interrupt reception in the form of short audio mutes.
- Driving under wide bridges or along tall buildings can cause intermittent reception.
- Placing objects over or too close to the antenna can cause signal blockage.

CD/DVD DISC MAINTENANCE

To keep the CD/DVD discs in good condition, take the following precautions:

1. Handle the disc by its edge; avoid touching the surface.
2. If the disc is stained, clean the surface with a soft cloth, wiping from center to edge.
3. Do not apply paper, paper CD labels, or tape to the disc; avoid scratching the disc.
4. Do not use solvents such as benzine, thinner, cleaners, or antistatic sprays.
5. Store the disc in its case after playing.
6. Do not expose the disc to direct sunlight.
7. Do not store the disc where temperatures may become too high.

8. Do not play discs that are small in size or have irregular shapes.

RADIO OPERATION AND CELLULAR PHONES

Under certain conditions, the cellular phone being ON in your vehicle can cause erratic or noisy performance from your radio. This condition may be lessened or eliminated by relocating the cellular phone antenna. This condition is not harmful to the radio. If your radio performance does not satisfactorily “clear” by the repositioning of the antenna, it is recommended that the radio volume be turned down or off during cellular phone operation.

CLIMATE CONTROLS

Climate Controls

The Climate Control System allows you to balance the temperature, amount, and direction of air circulating throughout the vehicle. The controls are located in the center instrument panel, below the radio.

The air conditioning system of your vehicle contains R-134a, a refrigerant that does not deplete the ozone layer in the upper atmosphere.

The controls are as follows:

Fan Control

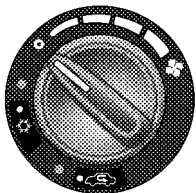

81ca72d2

Use this control to regulate the amount of air forced through the system in any mode you select. The fan speed increases as you move the control to the right from the OFF position.

Mode Control (Air Direction)

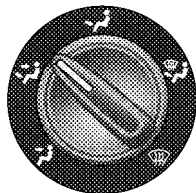

81caad23

The mode control allows you to choose from several patterns of air distribution. You can select either a primary mode, as identified by the symbols, or a blend of two of these modes. The closer the control is to a particular mode, the more air distribution you receive from that mode

Panel

 Air is directed through the outlets in the instrument panel. These outlets can be adjusted to direct air flow.

Bi-Level

 Air is directed through the panel and floor outlets.

NOTE: There is a difference in temperature between the upper and lower outlets for added comfort. The warmer air goes to the floor outlets. This feature gives improved comfort during sunny but cool conditions.

Floor

 Air is directed through the floor outlets and side window demist outlets with a small amount through the defrost outlet.

Mix

 Air is directed through the floor, defrost and side window demist outlets. This setting works best in cold or snowy conditions that require extra heat at the windshield. This setting is good for maintaining comfort while reducing moisture on the windshield.

Defrost



Air is directed through the windshield and side window demist outlets. Use this mode with maximum fan and temperature settings for best windshield and side window defrosting.

NOTE: The air conditioning compressor operates in both Mix and Defrost or a blend of these modes even if the A/C button has not been pressed and the indicator lamp is off. This dehumidifies the air to help dry the windshield. To improve fuel economy, use these modes only when necessary.

CAUTION!

If the Defroster is not working the windshield and windows may become fogged and your visibility will be greatly diminished. See your authorized dealer as soon as possible. the windshield and windows may become fogged and your visibility will be greatly diminished.

Air Outlets

The airflow from each of the instrument panel outlets can be adjusted for direction and turned on or off to control air flow.

NOTE: For maximum airflow to the rear seat passengers, the center instrument panel outlets can be aimed, so that the left center outlet is directed toward the right rear passenger and the right center outlet is directed toward the left rear passenger.

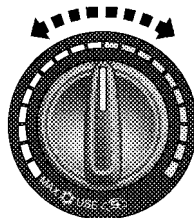
Temperature Control

81caad41

Use this control to regulate the temperature of the air inside the passenger compartment. The blue area of the scale indicates cooler temperatures while the red area indicates warmer temperatures.

NOTE: If your air conditioning performance seems lower than expected, check the front of the A/C condenser: located in front of the radiator, for an accumulation of dirt or insects. Clean with a gentle water spray from behind the radiator and through the condenser. Fabric front fascia protectors may reduce air flow to the condenser, reducing air conditioning performance.

Air Conditioning

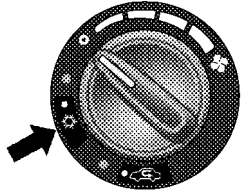

81ca746c

Rotate this control to engage the Air Conditioning. A lamp will illuminate when the Air Conditioning System is engaged

NOTE: The air conditioning compressor will not engage until the engine has been running for about 10 seconds.

MAX A/C

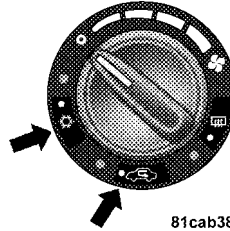

81cab384

To quickly cool the vehicle interior follow the steps listed below:

1. Set the Temperature Control to Max Cool.
2. Set the Mode Control to Panel or Be-Level.
3. Press the Recirculation Button and the A/C Button.
4. Adjust the Fan Control to desired air flow setting.

NOTE:

- Recirculation Mode will not operate in floor, mix or defrost modes.
- See “Circulation Control” in this section, for proper or extended use of this position.

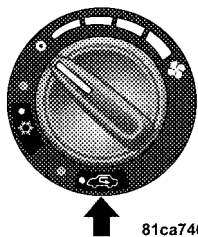
Circulation Control

81ca746b

Rotate this control to choose between outside air intake or recirculation of the air inside the vehicle. A lamp will illuminate when you are in recirculate mode. Only use the recirculate mode to temporarily block out any outside odors, smoke, or dust and to cool the interior rapidly upon initial











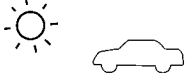







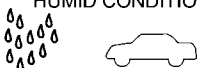

start up in very hot or humid weather.

NOTE: Continuous use of the recirculate mode may make the inside air stuffy and window fogging may occur. Extended use of this mode is not recommended.

In cold or damp weather, the use of the Recirculate position will cause windows to fog on the inside because of moisture build up inside the vehicle. For defogging, select the Outside Air position.

NOTE: Recirculation Mode will not operate in floor, mix or defrost modes.

Operating Tips

WEATHER	CONTROL SETTINGS
<p>HOT WEATHER AND VEHICLE INTERIOR IS VERY HOT</p> 	<p>Open the windows, start the vehicle, and place the Circulation control at . Set the Fan control to the high A/C position (full counterclockwise) position. Set the Mode control at or between  and . Set the temperature control to full cool. After the hot air is flushed from the vehicle, turn the Circulation control to  and roll up the windows. Once you are comfortable, place the Circulation control at  and adjust the temperature control for comfort.</p>
<p>WARM WEATHER</p> 	<p>Set the Circulation control to . If it's sunny, set the Mode control at or near  and turn the air conditioning on. If it's cloudy or dark, set the Mode control at or near .</p>
<p>COOL OR COLD HUMID CONDITIONS</p> 	<p>Set the Circulation control to . If it's sunny, set the Mode control at or between  and  then turn the air conditioning on. If it's cloudy or dark, set the Mode control at or near  and turn the air conditioning on.</p>
<p>COLD DRY CONDITIONS</p> 	<p>Set the Circulation control to . Set the Mode control at or near . If it is sunny, you may want more upper air. In this case, set the Mode control at or between  and . In very cold weather, if you need extra heat at the windshield, set the Mode control at or near the .</p>

808cd8a6

Control Settings Chart

Window Fogging

Vehicle side windows tend to fog on the inside in mild rainy or humid weather. To clear the windows, use the A/C, PANEL and blower controls. Direct the panel outlets toward the side windows. Do not use recirculate without A/C for long periods as fogging may occur.

Interior fogging on the windshield can be quickly removed by using the defrost position.

If the fogging problem persists, clean the inside window surfaces. The cause of undue fogging may be dirt collecting on the inside surface of the glass

NOTE: In cold weather, the use of the recirculate position will cause windows to fog on the inside because of moisture build up inside the vehicle. For maximum defogging, use the Outside Air position.

Summer Operation

Vehicles must be protected with a high-quality antifreeze coolant to provide proper corrosion protection and to raise the boiling point of the coolant for protection against overheating. A 50% concentration is recommended.

Outside Air Intake

When operating the system, make sure the air intake, directly in front of the windshield, is free of ice, slush, snow or other obstructions such as leaves. Leaves collected in the air-intake plenum may reduce air flow and plug the plenum water drains.

The blower air will heat faster in cold weather if you use only a low blower speed for the first few minutes of vehicle operation.

Side Window Demisters

A side window demister outlet is at each end of the instrument panel. These nonadjustable outlets direct air toward the side windows when the system is in either the FLOOR, MIX, or DEFROST mode. The air is directed at the area of the windows through which you view the outside mirrors.

STARTING AND OPERATING

CONTENTS

■ Starting Procedures	291	■ Automatic Transaxle — If Equipped	294
□ Automatic Transaxle	291	□ Brake/Transmission Interlock System	295
□ Manual Transaxle	292	□ Automatic Transaxle Ignition Interlock System	295
□ Normal Starting	292	□ Four-Speed Automatic Transaxle	296
□ Extremely Cold Weather (Below -20°F Or -29°C)	292	□ Reset Mode	296
□ If The Engine Fails To Start	293	□ Gear Ranges For The Four-Speed Automatic Transaxle	297
□ After Starting	293		
□ Turbocharger "Cool-Down"	293		

- AutoStick — If Equipped 299
 - AutoStick Operation 300
 - AutoStick General Information 300
- Manual Transaxle Operation — If Equipped 301
 - 2.4 Liter Turbo — If Equipped 303
 - Manual Transaxle — Recommended Shift Speeds 304
 - Downshifting 304
- Parking Brake 305
- Brake System 307
 - Anti-Lock Brake System (ABS) — If Equipped 308
- Power Steering 310
- Traction Control System — If Equipped 311
- Tire Safety Information 313
 - Tire Markings 313
 - Tire Identification Number (TIN) 316
 - Tire Loading And Tire Pressure 317
- Tires — General Information 321
 - Tire Pressure 321
 - Tire Inflation Pressures 322
 - Radial Ply Tires 324
 - Compact Spare Tire — If Equipped 325
 - Limited-Use Spare — If Equipped 325
 - Tire Spinning 326
 - Tread Wear Indicators 327
 - Life Of Tire 327

- Replacement Tires 328
- Alignment And Balance 329
- Tire Chains 330
- Snow Tires 330
- Tire Rotation Recommendations 331
- Tire Pressure Monitor System (TPMS) —
If Equipped 332
 - Base System — If Equipped 334
 - General Information 336
- Fuel Requirements — Gasoline Engines 337
 - 2.4L And 2.4L Standard Turbo Engines 337
 - Reformulated Gasoline 337
 - Gasoline/Oxygenate Blends 337
- MMT In Gasoline 338
- Materials Added To Fuel 338
- Fuel System Cautions 338
- Carbon Monoxide Warnings 339
- Adding Fuel 340
 - Fuel Filler Cap (Gas Cap) 340
 - Loose Fuel Filler Cap Message 342
- Vehicle Loading 342
- Trailer Towing 343
 - Common Towing Definitions 343
 - Trailer Hitch Classification 345
 - Trailer Towing Weights (Maximum Trailer
Weight Ratings) 347

290 STARTING AND OPERATING

- Trailer And Tongue Weight348
- Towing Requirements349
- Towing Tips354
- Recreational Towing (Behind Motorhome, Etc.) . . 356
 - Towing This Vehicle Behind Another Vehicle
(Flat Towing With All Four Wheels On The
Ground)356

STARTING PROCEDURES

Before starting your vehicle, adjust your seat, adjust both inside and outside mirrors, and fasten your seat belts.

WARNING!

Never leave children alone in a vehicle. Leaving children in a vehicle unattended is dangerous for a number of reasons. A child or others could be seriously or fatally injured. Don't leave the keys in the ignition. A child could operate power windows, other controls, or move the vehicle.

WARNING!

Be sure to turn off the engine if you want to rest or sleep in your car. Accidents can be caused by inadvertently moving the gear selector lever or by pressing the accelerator pedal. This may cause excessive heat in the exhaust system, resulting in overheating and vehicle fire which may cause serious or fatal injuries.

5

AUTOMATIC TRANSAXLE

The gear selector lever must be in the NEUTRAL or PARK position before you can start the engine. Apply the brakes and depress the gear selector lever knob button before shifting to any driving gear.

NOTE: You must press the brake pedal before shifting out of PARK.

MANUAL TRANSAXLE

Before starting the engine fully apply the parking brake, press the clutch pedal to the floor and shift the gear selector lever in NEUTRAL.

NOTE: The engine will not start unless the clutch pedal is pressed to the floor.

NORMAL STARTING

Normal starting of either a cold or a warm engine does not require pumping or depressing the accelerator pedal. Simply turn the ignition switch to the START position and release when the engine starts. If the engine has not started within three seconds, slightly depress the accelerator pedal while continuing to crank. If the engine fails to start within 15 seconds, turn the ignition switch to the OFF position, wait 10 to 15 seconds, then repeat the "NORMAL STARTING" procedure above.

WARNING!

Do not attempt to push or tow your vehicle to get it started. Vehicles equipped with an automatic trans-axle cannot be started this way. Unburned fuel could enter the catalytic converter and once the engine has started, ignite and damage the converter and vehicle. If the vehicle has a discharged battery, booster cables may be used to obtain a start from another vehicle. This type of start can be dangerous if done improperly, so follow the procedure carefully. See Section 6 of this manual for jump starting instructions.

EXTREMELY COLD WEATHER (BELOW -20°F or -29°C)

To insure reliable starting at these temperatures, use of an externally powered electric engine block heater (available from your authorized dealer) is recommended.

IF THE ENGINE FAILS TO START

If the engine fails to start after you have followed the “NORMAL STARTING” procedure, it may be flooded. Push the accelerator pedal all the way to the floor and hold it there. Crank the engine for no more than 15 seconds. This should clear any excess fuel in case the engine is flooded. Leave the ignition key in the ON position, release the accelerator pedal and repeat the “NORMAL STARTING” procedure.

WARNING!

Never pour fuel or other flammable liquid into the throttle body air inlet opening in an attempt to start the vehicle. This could result in flash fire causing serious personal injury.

CAUTION!

To prevent damage to the starter, do not crank the engine for more than 15 seconds at a time. Wait 10 to 15 seconds before trying again.

AFTER STARTING

The idle speed will automatically decrease as the engine warms up.

TURBOCHARGER “COOL-DOWN”

NOTE: Letting the engine idle after severe operation allows the turbine housing to cool to normal operating temperature. Do not increase the idle speed manually.

The following chart should be used as a guide in determining the amount of engine idle time required to sufficiently cool down the turbocharger before shut down, depending upon the type of driving and the amount of cargo.

TURBOCHARGER "COOL-DOWN" CHART	
Driving Conditions	Idle Before Shut Down
Normal	0 min
Aggressive/Heavy Load	3 min
Trailer Tow	5 min

AUTOMATIC TRANSAXLE — IF EQUIPPED

You must step on the brake pedal and depress the gear selector lever knob button before you will be able to shift out of PARK.

CAUTION!

Damage to the transaxle may occur if the following precautions are not observed:

- Shift into PARK only after the vehicle has come to a complete stop.
- Shift into or out of REVERSE only after the vehicle has come to a complete stop and the engine is at idle speed.
- Do not shift from REVERSE, PARK, or NEUTRAL into any forward gear when the engine is above idle speed.
- Before shifting into any gear, make sure your foot is firmly on the brake pedal.

NOTE: You must step on the brake pedal and depress the gear selector lever knob button before you will be able to shift the gear selector lever out of PARK.

WARNING!

It is dangerous to shift the gear selector lever out of PARK, or NEUTRAL if the engine speed is higher than idle speed. If your foot is not firmly on the brake pedal, the vehicle could accelerate quickly forward or in REVERSE. You could lose control of the vehicle and hit someone or something. Only shift the gear selector lever into gear when the engine is idling normally and when your right foot is firmly on the brake pedal.

BRAKE/TRANSMISSION INTERLOCK SYSTEM

This system prevents you from shifting the gear selector lever out of PARK and into any gear unless the brake pedal is pressed. This system is active only while the ignition switch is in the ON or ACC positions. **Always**

step on the brake pedal and depress the gear selector lever knob button before shifting out of PARK.

NOTE: If a malfunction occurs, the system will function normally, except you may be able to shift the vehicle from PARK, without depressing the brake pedal. If this occurs obtain service from an authorized dealer as soon as possible.

AUTOMATIC TRANSAXLE IGNITION INTERLOCK SYSTEM

This system prevents the key from being removed unless the gear selector lever is in PARK and the gear selector lever knob push button is out. It also prevents shifting out of PARK unless the key is in the ACC or ON positions, and the brake pedal is depressed.

NOTE: If a malfunction occurs, the system will trap the key in the ignition cylinder to warn you that this safety

feature is inoperable. The engine can be started and stopped but the key cannot be removed until you obtain service.

FOUR-SPEED AUTOMATIC TRANSAXLE

The electronically controlled transaxle provides a precise shift schedule. The transaxle electronics are self calibrating; therefore, the first few shifts on a new vehicle may be somewhat abrupt. This is a normal condition, and precision shifts will develop within a few shift cycles.

RESET MODE

The transaxle is monitored electronically for abnormal conditions. If a condition is detected that could cause damage, the transaxle shifts automatically into second gear. The transaxle remains in second gear despite the forward gear selected. PARK, REVERSE, and NEUTRAL will continue to operate. This second gear limp-in feature allows the vehicle to be driven to a dealer for service without damaging the transaxle.

In the event that the problem has been momentary, the transaxle can be reset to regain all forward gears.

Stop the vehicle and shift the gear selector lever into PARK.

Turn the Key to OFF then restart the engine.

Shift the gear selector lever into DRIVE and resume driving.

If the transaxle cannot be reset, authorized dealer service is required.

NOTE: Even if the transaxle can be reset, it is recommended that you visit an authorized dealer at your earliest possible convenience. Your authorized dealer has diagnostic equipment to determine if the problem could recur.

GEAR RANGES FOR THE FOUR-SPEED AUTOMATIC TRANSAXLE

DO NOT race the engine when shifting from PARK or NEUTRAL positions into another gear range.

PARK

PARK supplements the parking brake by locking the transmission. The engine can be started in this range. Never use PARK while the vehicle is in motion. Apply the parking brake when leaving the vehicle in this range. Always apply the parking brake first, and then shift the gear selector lever into the PARK position.

WARNING!

Unintended movement of a vehicle could injure those in and near the vehicle. As with all vehicles, you should never exit a vehicle while the engine is running. Before exiting a vehicle, you should always shift the vehicle into PARK, remove the key from the ignition, and apply the parking brake. Once the key is removed from the ignition, the transmission gear selector lever is locked in the PARK position, securing the vehicle against unwanted movement. Furthermore, you should never leave children unattended inside a vehicle.

The following indicators should be used to ensure that you have engaged the transmission gear selector lever into the PARK position:

- When shifting the gear selector lever into PARK, depress the button on the gear selector lever knob and firmly move the lever all the way forward until it stops.
- Look at the shift indicator window on the console to ensure it is in the PARK position.
- When engaged in PARK, you will not be able to move the gear selector lever rearward without depressing the gear selector lever knob button

CAUTION!

Before shifting the gear selector lever out of PARK, you must turn the ignition from LOCK to ON so the steering wheel and gear selector lever are released. Otherwise, damage to the steering column or gear selector lever could result.

REVERSE

Shift into this range only after the vehicle has come to a complete stop.

NEUTRAL

The engine may be started in this range.

DRIVE / OVERDRIVE

This range should be used for most city and highway driving. It provides smoothest upshifts and downshifts, and best fuel economy.

When frequent transaxle shifting occurs while using the DRIVE/OVERDRIVE range, such as when operating the vehicle under heavy loading conditions (in hilly terrain, traveling into strong head winds, or while towing trailers), use the [3] range.

[3] DRIVE

This range eliminates shifts into OVERDRIVE. The transaxle will operate normally in first and second while in this range.

NOTE: Using the [3] range while operating the vehicle under heavy operating conditions will improve performance, fuel economy, and extend transaxle life by reducing excessive shifting and heat build up.

Use the [3] range when descending steep grades to prevent brake system distress.

[1] Low

This range should be used for maximum engine braking when descending steep grades. In this range, up shifts will occur only to prevent engine over speed while down shifts from [2] to [1] will occur as early as possible.

AUTOSTICK — IF EQUIPPED

AUTOSTICK is a driver-interactive transmission that offers manual gear shifting capability to provide you with more control. AUTOSTICK allows you to maximize engine braking, eliminate undesirable upshifts and downshifts, and improve overall vehicle performance. This system can also provide you with more control during passing, city driving, cold slippery conditions, mountain driving, trailer towing, and many other situations.

AUTOSTICK Operation

The AUTOSTICK position is just below the OVERDRIVE position and is identified by the word “AUTOSTICK”. When you place the gear selector lever in the AUTOSTICK position, it can be moved from side to side. Moving the lever to the left (-) triggers a downshift and to the right (+) an upshift. The gear position will be shown in the transmission gear display, located in the instrument cluster.

You can shift in or out of the AUTOSTICK mode at any time without taking your foot off the accelerator pedal. If you choose the OVERDRIVE mode, the transmission will operate automatically; shifting between the four available gears. When you wish to engage AUTOSTICK, simply move the gear selector lever to the AUTOSTICK position. The transmission will remain in the current gear until an upshift or downshift is chosen.

Move the lever back to the OVERDRIVE position to shift out of the AUTOSTICK mode.

AUTOSTICK General Information

- The transmission will automatically upshift from first to second gear and from second to third gear when engine speed reaches about 6,300 RPM.
- Downshifts from third to second gear above 74 mph (119 km/h) and from second to first gear above 41 mph (66 km/h) will be ignored.
- You can start out in first, second, or third gear. Shifting into fourth gear can occur only after vehicle speed reaches 15 mph (24 km/h).
- The transmission will automatically downshift to first gear when coming to a stop.
- Starting out in third gear is helpful in snowy or icy conditions.

- While in the AUTOSTICK mode, Speed Control will only function in third or fourth gear.

Downshifting out of third gear will turn off the speed control.

- If the system detects powertrain overheating, the transmission will revert to the automatic shift mode and remain in that mode until the powertrain cools off.
- If the system detects a problem it will disable the AUTOSTICK mode and the transmission will return to the automatic mode until the problem is corrected.

MANUAL TRANSAXLE OPERATION — IF EQUIPPED

WARNING!

You or others could be injured if you leave the vehicle unattended without having the parking brake fully applied. The parking brake should always be applied when the driver is not in the vehicle, especially on an incline.

Fully depress the clutch pedal before you shift gears. As you release the clutch pedal, lightly depress the accelerator pedal.

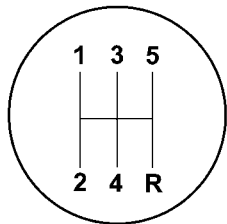

Five-Speed Shift Pattern

80f7bc4b

Use each gear in numerical order - do not skip a gear. Be sure the gear selector lever is in **FIRST** gear, (not **THIRD**), when starting from a standing position. Damage to the clutch can result from starting in **THIRD**.

For most city driving you will find it easier to use only the lower gears. For steady highway driving with light accelerations, **FIFTH** gear is recommended.

Never drive with your foot resting on the clutch pedal, or try to hold the vehicle on a hill with the clutch pedal partially engaged. This will cause abnormal wear on the clutch.

Never shift the gear selector lever into **REVERSE** until the vehicle has come to a complete stop.

NOTE: During cold weather, until the transaxle lubricant is warm, you may experience slightly higher shift efforts. This is normal and not harmful to the transaxle.

2.4 LITER TURBO — IF EQUIPPED

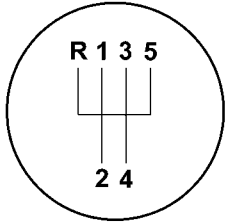

Five-Speed Shift Pattern With Turbo

80f7bc54

The neutral position of the gear selector lever is located between THIRD and FOURTH gear. This is the position the gear selector lever will return to automatically when neutral is selected. When shifting into FIFTH gear, be sure to press the gear selector lever all the way to the right to avoid accidentally selecting THIRD gear. Also, use care when selecting FIRST gear to avoid accidentally shifting the gear selector lever into REVERSE.

When moving the gear selector lever into REVERSE press the lever to the left until the resistance is overcome. When the ignition switch is in the ON position, a chime will sound to confirm that reverse has been selected and the backup lights will illuminate.

NOTE: Listen for the audible chime to confirm REVERSE gear is properly selected. Never shift the gear selector lever into REVERSE until the vehicle has come to a complete stop.

MANUAL TRANSAXLE — RECOMMENDED SHIFT SPEEDS

To use your manual transaxle for optimal fuel economy, it should be upshifted as listed in Table 1.

Engine	Mode	1 to 2	2 to 3	3 to 4	4 to 5
2.4L Turbo	Acceleration	15 (24)	25 (40)	40 (65)	45 (72)
	Cruise	15 (24)	25 (40)	42 (68)	45 (72)
2.4L Non-Turbo	Acceleration	15 (24)	25 (40)	40 (65)	45 (72)
	Cruise	15 (24)	25 (40)	42 (68)	45 (72)

For improved performance, your manual transaxle may be upshifted up to the maximum speeds listed in Table 2 (within legal speed limits).

Table 2 - Manual Transaxle Maximum Performance Shift Speeds In mph (km/h)

Engine	1 to 2	2 to 3	3 to 4	4 to 5
2.4L	30 (48)	60 (97)	85 (136)	115 (185)

If you exceed these speeds, you may notice the engine cut in and out. This is caused by an electronic limiter in the engine computer. The engine will run normally when you reduce engine speed.

Downshifting

Proper downshifting will improve fuel economy and prolong engine life.

CAUTION!

If you skip a gear while downshifting or downshift at too high an engine speed, you could damage the engine, transmission, or clutch.

To maintain a safe speed and prolong brake life, shift down to **SECOND** or **FIRST** gear when descending a steep grade.

When turning a corner, or driving up a steep grade, downshift early so that the engine will not be overburdened.

PARKING BRAKE

BRAKE When the parking brake is applied with the ignition on, the **BRAKE** Light in the instrument cluster will come on.

NOTE: This light only shows that the parking brake is on. It does not show the degree of brake application.

If the parking brake is applied while the vehicle is moving, a chime will sound to alert the driver. The chime will sound up to 10 times or until the vehicle has returned to a stop.

Before leaving the vehicle, make sure that the parking brake is set. To set the parking brake, pull up firmly on the lever. Always shift the gear selector lever into the **PARK** position (automatic transaxle) or into the **REVERSE** position (manual transaxle). To release the parking brake, apply the brake pedal, pull up slightly on the lever, then depress the button on the end of the lever and push the lever fully down toward the floor.

NOTE: The parking brake lever will not release unless the lever is pulled up slightly past its applied position.

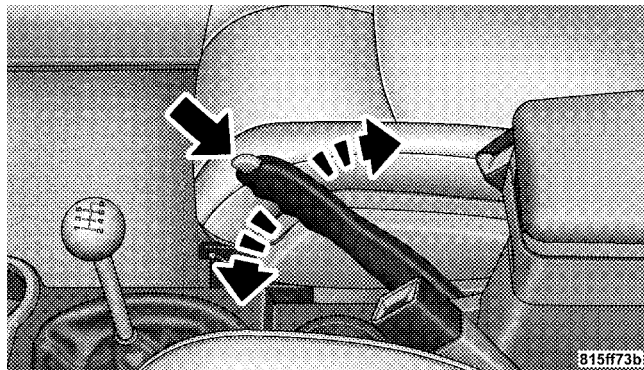

Parking Brake Lever

When parking on a hill, it is important to set the parking brake before placing the gear selector lever in PARK, otherwise the load on the automatic transaxle locking mechanism may make it difficult to move the gear

selector lever out of PARK. As an added precaution, turn the front wheels toward the curb on a downhill grade and away from the curb on an uphill grade.

You should always apply the parking brake before leaving the vehicle.

WARNING!

- **Never leave children alone in a vehicle. Leaving children in a vehicle unattended is dangerous for a number of reasons. A child or others could be seriously or fatally injured. Don't leave the keys in the ignition. A child could operate power windows, other controls, or move the vehicle.**
- **Be sure the parking brake is fully disengaged before driving; failure to do so can lead to brake failure and an accident.**

BRAKE SYSTEM

Your vehicle is equipped with power assisted brakes as standard equipment. In the event power assist is lost for any reason (for example, repeated brake applications with the engine off), the brakes will still function. However, the effort required to brake the vehicle will be much greater than that required with the power system operating.

WARNING!

Riding the brakes can lead to brake failure and possibly an accident. Driving with your foot resting or riding on the brake pedal can result in abnormally high brake temperatures, excessive lining wear, and possible brake damage. You wouldn't have your full braking capacity in an emergency.

If either of the two hydraulic systems lose normal capability, the remaining system will still function with some loss of overall braking effectiveness. This will be evident by increased pedal travel during application and greater pedal force required to slow or stop. In addition, if the malfunction is caused by an internal leak, as the brake fluid in the master cylinder drops, the brake warning indicator will light.

WARNING!

Driving a vehicle with the brake light on is dangerous. A significant decrease in braking performance or vehicle stability during braking may occur. It will take you longer to stop the vehicle or will make your vehicle harder to control. You could have an accident. Have the vehicle checked immediately.

ANTI-LOCK BRAKE SYSTEM (ABS) — IF EQUIPPED

The ABS provides increased vehicle stability and brake performance under most braking conditions. The system automatically “pumps” the brakes during severe braking conditions to prevent wheel lock-up.

WARNING!

Pumping of the ABS will diminish their effectiveness and may lead to an accident. Pumping makes the stopping distance longer. Just press firmly on your brake pedal when you need to slow down or stop.

WARNING!

- **The ABS cannot prevent the natural laws of physics from acting on the vehicle, nor can it increase braking or steering efficiency beyond that afforded by the condition of the vehicle brakes and tires or the traction afforded.**
- **An ABS cannot prevent accidents, including those resulting from excessive speed in turns, following another vehicle too closely, or hydroplaning. Only a safe, attentive, and skillful driver can prevent accidents.**
- **The capabilities of an ABS equipped vehicle must never be exploited in a reckless or dangerous manner which could jeopardize the user’s safety or the safety of others.**



The ABS telltale light monitors the Anti-Lock Brake System. The light will come on when the ignition switch is turned to the ON position and may stay on for as long as four seconds.

If the ABS light remains on or comes on while driving, it indicates that the Anti-Lock portion of the brake system is not functioning and that service is required. However, the conventional brake system will continue to operate normally if the BRAKE warning light is not on.

If the ABS light is on, the brake system should be serviced as soon as possible to restore the benefits of Anti-Lock brakes. If the ABS light does not come on when the Ignition switch is turned to the ON position, have the bulb repaired as soon as possible.

If both the Brake Warning Light and the ABS Light remain on, the Anti-Lock brakes (ABS) and Electronic Brake Force Distribution (EBD) systems are not functioning properly. Immediate repair to the ABS system at an authorized dealer is required.

When the vehicle is driven over 7 mph (11 km/h), you may also hear a slight clicking sound as well as some related motor noises. These noises are the system performing its self check cycle to ensure that the ABS system is working properly. This self-check occurs each time the vehicle is started and accelerated past 7 mph (11 km/h).

ABS is activated during braking under certain road or stopping conditions. ABS-inducing conditions can include ice, snow, gravel, bumps, railroad tracks, loose debris, or panic stops.

You also may experience the following when the brake system goes into Anti-Lock:

- The ABS motor running (it may continue to run for a short time after the stop).
- A clicking sound of solenoid valves.
- Brake pedal pulsations.

- A slight drop or fall away of the brake pedal at the end of the stop.

These are all normal characteristics of ABS.

WARNING!

The Anti-Lock Brake System contains sophisticated electronic equipment that may be susceptible to interference caused by improperly installed or high output radio transmitting equipment. This interference can cause possible loss of Anti-Lock braking capability. Installation of such equipment should be performed by qualified dealership professionals.

All vehicle wheels and tires must be the same size and type and tires must be properly inflated to produce accurate signals for the computer.

POWER STEERING

The standard power steering system will give you good vehicle response and increased ease of maneuverability in tight spaces. The system will provide mechanical steering capability if power assist is lost.

If for some reason the power assist is interrupted, it will still be possible to steer your vehicle. Under these conditions, you will observe a substantial increase in steering effort, especially at very low vehicle speeds and during parking maneuvers.

NOTE: Increased noise levels at the end of the steering wheel travel are considered normal and do not indicate that there is a problem with the power steering system.

Upon initial start-up in cold weather, the power steering pump may make noise for a short amount of time. This is due to the cold, thick fluid in the steering system. This noise should be considered normal, and it does not in any way damage the steering system.

WARNING!

Continued operation with reduced power steering assist could pose a safety risk to yourself and others. Service should be obtained as soon as possible.

CAUTION!

Prolonged operation of the steering system at the end of the steering wheel travel will increase the steering fluid temperature and it should be avoided when possible. Damage to the power steering pump may occur.

TRACTION CONTROL SYSTEM — IF EQUIPPED

The Traction Control System (TCS) will improve acceleration and steering on slippery surfaces by reducing tire spin. The system reduces wheel slip and maintains traction at the driving (front) wheels by engaging the brake on the wheel that is losing traction. When this occurs the TCS indicator lamp located above the instrument cluster odometer will flash. The system operates at speeds below 35 mph (56 km/h).

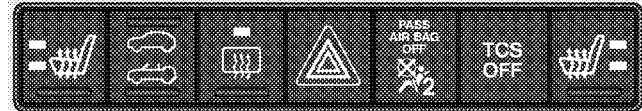

81995e73

TCS OFF Switch

A push-button at the center of the instrument panel, below the radio, turns the Traction Control System ON or OFF.

The system is always in the “ON” mode unless:

- The TCS OFF switch has been used to turn the system off;
- There is a Anti-Lock Brake System malfunction;
- There is a Traction Control System malfunction;
- The system has been automatically deactivated to prevent damage to the brake system due to overheated brake temperatures.

NOTE: Extended heavy use of Traction Control may cause the system to deactivate and turn on the TCS indicator lamp located in the instrument cluster.

This is to prevent overheating of the brake system and is a normal condition. The system will remain disabled for about 4 minutes until the brakes have cooled. The system will automatically reactivate and turn off the TCS indicator lamp.

If your vehicle becomes stuck in mud, ice, or snow, turn the Traction Control System Off before attempting to “rock” the vehicle free.

TIRE SAFETY INFORMATION

Tire Markings

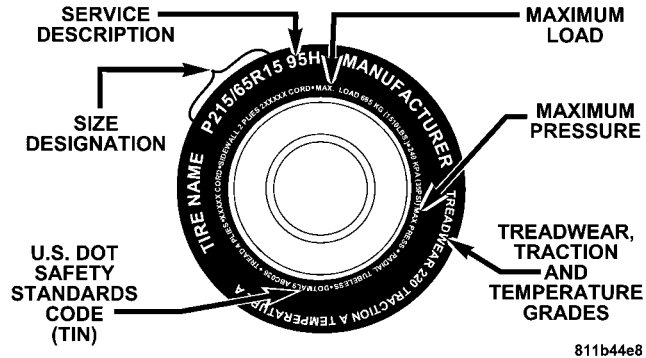

NOTE:

- P (Passenger)-Metric tire sizing is based on U.S. design standards. P-Metric tires have the letter “P” molded into the sidewall preceding the size designation. Example: P215/65R15 95H.

- European Metric tire sizing is based on European design standards. Tires designed to this standard have the tire size molded into the sidewall beginning with the section width. The letter “P” is absent from this tire size designation. Example: 215/65R15 96H.
- LT (Light Truck)-Metric tire sizing is based on U.S. design standards. The size designation for LT-Metric tires is the same as for P-Metric tires except for the letters “LT” that are molded into the sidewall preceding the size designation. Example: LT235/85R16.
- Temporary spare tires are high-pressure compact spares designed for temporary emergency use only. Tires designed to this standard have the letter “T” molded into the sidewall preceding the size designation. Example: T145/80D18 103M.
- High flotation tire sizing is based on U.S. design standards, and it begins with the tire diameter molded into the sidewall. Example: 31x10.5 R15 LT.

Tire Sizing Chart

EXAMPLE:
<p>Size Designation:</p> <p>P = Passenger Car tire size based on U.S. design standards "...blank..." = Passenger Car tire based on European design standards LT = Light Truck tire based on U.S. design standards T = Temporary spare tire 31 = Overall diameter in inches (in)</p>
215 = Section width in millimeters (mm)
<p>65 = Aspect ratio in percent (%). — Ratio of section height to section width of tire</p> <p>10.5 = Section width in inches (in)</p>
<p>R = Construction code — "R" means radial construction — "D" means diagonal or bias construction</p>
15 = Rim diameter in inches (in)

EXAMPLE:**Service Description:****95** = Load Index

— A numerical code associated with the maximum load a tire can carry

H = Speed Symbol

— A symbol indicating the range of speeds at which a tire can carry a load corresponding to its load index under certain operating conditions

— The maximum speed corresponding to the speed symbol should only be achieved under specified operating conditions (i.e., tire pressure, vehicle loading, road conditions, and posted speed limits)

Load Identification:**"....blank...."** = Absence of any text on the sidewall of the tire indicates a Standard Load (SL) Tire**Extra Load (XL)** = Extra load (or reinforced) tire**Light Load** = Light load tire**C, D, E** = Load range associated with the maximum load a tire can carry at a specified pressure**Maximum Load** — Maximum load indicates the maximum load this tire is designed to carry**Maximum Pressure** — Maximum pressure indicates the maximum permissible cold tire inflation pressure for this tire

Tire Identification Number (TIN)

The TIN may be found on one or both sides of the tire, however, the date code may only be on one side. Tires with white sidewalls will have the full TIN, including the date code,

located on the white sidewall side of the tire. Look for the TIN on the outboard side of black sidewall tires as mounted on the vehicle. If the TIN is not found on the outboard side, then you will find it on the inboard side of the tire.

EXAMPLE:**DOT MA L9 ABCD 0301**

DOT = Department of Transportation

— This symbol certifies that the tire is in compliance with the U.S. Department of Transportation tire safety standards, and is approved for highway use

MA = Code representing the tire manufacturing location (two digits)

L9 = Code representing the tire size (two digits)

ABCD = Code used by the tire manufacturer (one to four digits)

03 = Number representing the week in which the tire was manufactured (two digits)

—03 means the 3rd week.

01 = Number representing the year in which the tire was manufactured (two digits)

—01 means the year 2001

— Prior to July 2000, tire manufacturers were only required to have one number to represent the year in which the tire was manufactured. Example: 031 could represent the 3rd week of 1981 or 1991

Tire Loading and Tire Pressure

Tire Placard Location

NOTE: The proper cold tire inflation pressure is listed on either the face of the driver's door or the driver's side B-Pillar.

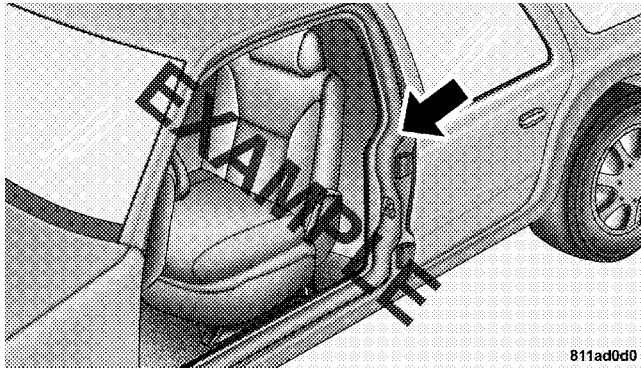

811ad0d0

Tire Placard Location

Tire and Loading Information Placard

TIRE AND LOADING INFORMATION			
SEATING CAPACITY - TOTAL 5 FRONT 2 REAR 3			
THE COMBINED WEIGHT OF OCCUPANTS AND CARGO SHOULD NEVER EXCEED XXX KG OR XXX LBS.			
TIRE	FRONT	REAR	SPARE
ORIGINAL TIRE SIZE	P195/70R14	P195/70R14	T125/70D15
COLD TIRE INFLATION PRESSURE	200kPa, 29PSI	200kPa, 29PSI	420kPa, 60PSI
SEE OWNER'S MANUAL FOR ADDITIONAL INFORMATION			4N109268

811b5a9a

Tire And Loading Information Placard

This placard tells you important information about the:

- 1) number of people that can be carried in the vehicle
- 2) total weight your vehicle can carry
- 3) tire size designed for your vehicle
- 4) cold tire inflation pressures for the front, rear, and spare tires.

Loading

The vehicle maximum load on the tire must not exceed the load carrying capacity of the tire on your vehicle. You will not exceed the tire's load carrying capacity if you adhere to the loading conditions, tire size, and cold tire inflation pressures specified on the Tire and Loading Information placard and in the "Vehicle Loading" section of this manual.

NOTE: Under a maximum loaded vehicle condition, gross axle weight ratings (GAWRs) for the front and rear axles must not be exceeded. For further information on GAWRs, vehicle loading, and trailer towing, refer to "Vehicle Loading" in this section.

To determine the maximum loading conditions of your vehicle, locate the statement "The combined weight of occupants and cargo should never exceed XXX kg or XXX lbs." on the Tire and Loading Information placard. The

combined weight of occupants, cargo/luggage and trailer tongue weight (if applicable) should never exceed the weight referenced here.

Steps for Determining Correct Load Limit

1. Locate the statement "The combined weight of occupants and cargo should never exceed XXX lbs or XXX kg" on your vehicle's placard.
2. Determine the combined weight of the driver and passengers that will be riding in your vehicle.
3. Subtract the combined weight of the driver and passengers from XXX kg or XXX lbs.
4. The resulting figure equals the available amount of cargo and luggage load capacity. For example, if "XXX" amount equals 1,400 lbs (635 kg) and there will be five 150 lb (68 kg) passengers in your vehicle, the amount of

available cargo and luggage load capacity is 650 lbs (295 kg) {(since $5 \times 150 = 750$, and $1400 - 750 = 650$ lbs (295 kg))}.

5. Determine the combined weight of luggage and cargo being loaded on the vehicle. That weight may not safely exceed the available cargo and luggage load capacity calculated in Step 4.

6. If your vehicle will be towing a trailer, load from your trailer will be transferred to your vehicle. Consult this manual to determine how this reduces the available cargo and luggage load capacity of your vehicle.

NOTE: The following table shows examples on how to calculate total load, cargo/luggage, and towing capacities of your vehicle with varying seating configurations and number and size of occupants. This table is for illustration purposes only and may not be accurate for the seating and load carry capacity of your vehicle.

NOTE: For the following example, the combined weight of occupants and cargo should never exceed 865 lbs (392 kg).

320 STARTING AND OPERATING

Occupants			Combined weight of occupants and cargo from Tire Placard	MINUS	Combined Occupant's weight	=	AVAILABLE Cargo/Luggage and Trailer Tongue Weight
TOTAL	FRONT	REAR					
EXAMPLE 1							
5	2	3			Occupant 1: 200 lbs Occupant 2: 130 lbs Occupant 3: 160 lbs Occupant 4: 100 lbs Occupant 5: 80 lbs TOTAL WEIGHT: 670 lbs		
			865 lbs	minus	670 lbs	=	195 lbs
EXAMPLE 2							
3	2	1			Occupant 1: 210 lbs Occupant 2: 180 lbs Occupant 3: 150 lbs TOTAL WEIGHT: 540 lbs		
			865 lbs	minus	540 lbs	=	325 lbs
EXAMPLE 3							
2	2	0			Occupant 1: 200 lbs Occupant 2: 200 lbs TOTAL WEIGHT: 400 lbs		
			865 lbs	minus	400 lbs	=	465 lbs

WARNING!

Overloading of your tires is dangerous. Overloading can cause tire failure, affect vehicle handling, and increase your stopping distance. Use tires of the recommended load capacity for your vehicle. Never overload them.

TIRES — GENERAL INFORMATION**Tire Pressure**

Proper tire inflation pressure is essential to the safe and satisfactory operation of your vehicle. Three primary areas are affected by improper tire pressure:

1. Safety—**WARNING!**

- Improperly inflated tires are dangerous and can cause accidents.
- Under-inflation increases tire flexing and can result in tire failure.
- Over-inflation reduces a tire's ability to cushion shock. Objects on the road and chuckholes can cause damage that result in tire failure.
- Unequal tire pressures can cause steering problems. You could lose control of your vehicle.
- Over-inflated or under-inflated tires can affect vehicle handling and can fail suddenly, resulting in loss of vehicle control.
- Unequal tire pressures from one side of the vehicle to the other can cause the vehicle to drift to the right or left.
- Always drive with each tire inflated to the recommended cold tire inflation pressure.

2. *Economy*—

Improper inflation pressures can cause uneven wear patterns to develop across the tire tread. These abnormal wear patterns will reduce tread life resulting in a need for earlier tire replacement. Under-inflation also increases tire rolling resistance and results in higher fuel consumption.

3. *Ride Comfort and Vehicle Stability*—

Proper tire inflation contributes to a comfortable ride. Over-inflation produces a jarring and uncomfortable ride.

Tire Inflation Pressures

The proper cold tire inflation pressure is listed either on the face of the driver's door or on the driver's side "B" pillar.

Some vehicles may have Supplemental Tire Pressure Information for vehicle loads that are less than the

maximum loaded vehicle condition. These pressure conditions will be found in the "Supplemental Tire Pressure Information" section of this manual.

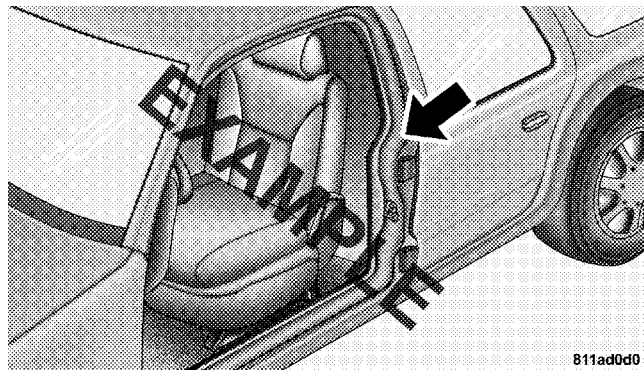

Tire Placard Location

The pressure should be checked and adjusted as well as inspecting for signs of tire wear or visible damage at least once a month. Use a good quality pocket-type gauge to

check tire pressure. Do not make a visual judgement when determining proper inflation. Radial tires may look properly inflated even when they are under-inflated.

CAUTION!

After inspecting or adjusting the tire pressure, always reinstall the valve stem cap (if equipped). This will prevent moisture and dirt from entering the valve stem, which could damage the valve stem.

Inflation pressures specified on the placard are always “cold tire inflation pressure.” Cold tire inflation pressure is defined as the tire pressure after the vehicle has not been driven for at least three hours, or driven less than 1 mi (1.6 km) after a three hour period. The cold tire inflation pressure must not exceed the maximum inflation pressure molded into the tire sidewall.

Check tire pressures more often if subject to a wide range of outdoor temperatures, as tire pressures vary with temperature changes.

Tire pressures change by approximately 1 psi (7 kPa) per 12°F (7°C) of air temperature change. Keep this in mind when checking tire pressure inside a garage, especially in the Winter.

Example: If garage temperature = 68°F (20°C) and the outside temperature = 32°F (0°C) then the cold tire inflation pressure should be increased by 3 psi (21 kPa), which equals 1 psi (7 kPa) for every 12°F (7°C) for this outside temperature condition.

Tire pressure may increase from 2 to 6 psi (13 to 40 kPa) during operation. DO NOT reduce this normal pressure build up or your tire pressure will be too low.

Tire Pressures for High Speed Operation

The manufacturer advocates driving at safe speeds within posted speed limits. Where speed limits or conditions are such that the vehicle can be driven at high speeds, maintaining correct tire inflation pressure is very important. Increased tire pressure and reduced vehicle loading may be required for high-speed vehicle operation. Refer to original equipment or an authorized tire dealer for recommended safe operating speeds, loading and cold tire inflation pressures.

WARNING!

High speed driving with your vehicle under maximum load is dangerous. The added strain on your tires could cause them to fail. You could have a serious accident. Don't drive a vehicle loaded to the maximum capacity at continuous speeds above 75 mph (120 km/h).

Radial Ply Tires

WARNING!

Combining radial ply tires with other types of tires on your vehicle will cause your vehicle to handle poorly. The instability could cause an accident. Always use radial ply tires in sets of four (or six, in case of trucks with dual rear wheels). Never combine them with other types of tires.

Cuts and punctures in radial tires are repairable only in the tread area because of sidewall flexing. Consult your authorized tire dealer for radial tire repairs.

Compact Spare Tire — If Equipped

The compact spare is for temporary emergency use with radial tires. It is engineered to be used on your style vehicle only. Since this tire has limited tread life, the original tire should be repaired (or replaced) and reinstalled at the first opportunity.

WARNING!

Temporary use spare tires are for emergency use only. With these tires, do not drive more than 50 mph (80 km/h). Temporary use spare tires have limited tread life. When the tread is worn to the tread wear indicators, the temporary use spare tire needs to be replaced. Be sure to follow the warnings, which apply to your spare. Failure to do so could result in spare tire failure and loss of vehicle control.

Do not install a wheel cover or attempt to mount a conventional tire on the compact spare wheel, since the wheel is designed specifically for the compact spare.

Do not install more than one compact spare tire/wheel on the vehicle at any given time.

CAUTION!

Because of the reduced ground clearance, do not take your vehicle through an automatic car wash with the compact spare installed. Damage to the vehicle may result.

Limited-Use Spare — If Equipped

The limited-use spare tire is for temporary emergency use on your vehicle. This tire is identified by a limited-use spare tire warning label located on the limited-use spare tire and wheel assembly. This tire may look like the

original equipped tire on the front or rear axle of your vehicle, but it is not. Installation of this limited-use spare tire affects vehicle handling. Since it is not the same tire, replace (or repair) the original tire and reinstall on the vehicle at the first opportunity.

WARNING!

The limited-use spare tires are for emergency use only. Installation of this limited-use spare tire affects vehicle handling. With this tire, do not drive more than 50 mph (80 km/h). Keep inflated to the cold tire inflation pressure listed on either your tire placard or limited-use spare tire and wheel assembly. Replace (or repair) the original tire at the first opportunity and reinstall it on your vehicle. Failure to do so could result in loss of vehicle control.

Tire Spinning

When stuck in mud, sand, snow, or ice conditions, do not spin your vehicle's wheels faster than 30 mph (48 km/h) or for longer than 30 seconds continuously without stopping when you are stuck.

For additional information, refer to "Freeing A Stuck Vehicle" in Section 6.

WARNING!

Fast spinning tires can be dangerous. Forces generated by excessive wheel speeds may cause tire damage or failure. A tire could explode and injure someone. Do not spin your vehicle's wheels faster than 30 mph (48 km/h) or for more than 30 seconds continuously when you are stuck, and don't let anyone near a spinning wheel, no matter what the speed.

Tread Wear Indicators

Tread wear indicators are in the original equipment tires to help you in determining when your tires should be replaced.

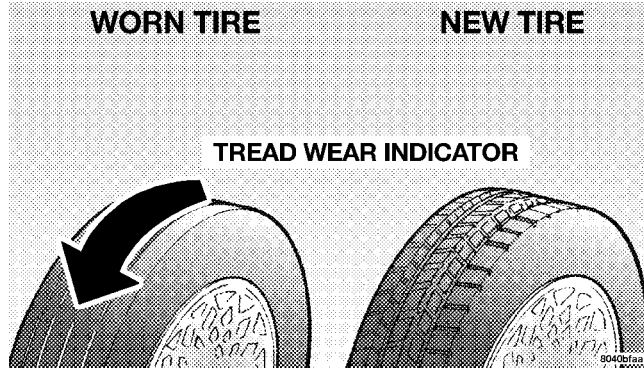

These indicators are molded into the bottom of the tread grooves. They will appear as bands when the tread depth becomes $1/16$ in (2 mm). When the tread is worn to the tread wear indicators, the tire should be replaced.

Many states have laws requiring tire replacement at this point.

Life of Tire

The service life of a tire is dependent upon varying factors including, but not limited to:

- Driving style
- Tire pressure
- Distance driven

WARNING!

Tires and the spare tire should be replaced after six years, regardless of the remaining tread. Failure to follow this warning can result in sudden tire failure. You could lose control and have an accident resulting in serious injury or death.

Keep dismounted tires in a cool, dry place with as little exposure to light as possible. Protect tires from contact with oil, grease, and gasoline.

Replacement Tires

The tires on your new vehicle provide a balance of many characteristics. They should be inspected regularly for wear and correct cold tire inflation pressure. The manufacturer strongly recommends that you use tires equivalent to the originals in size, quality and performance when replacement is needed. (Refer to the paragraph on “Tread Wear Indicators”). Refer to the “Tire and Loading Information” placard for the size designation of your tire. The service description and load identification will be found on the original equipment tire. Failure to use equivalent replacement tires may adversely affect the safety, handling, and ride of your vehicle. We recommend that you contact your original equipment or an authorized tire dealer with any questions you may have on tire specifications or capability.

WARNING!

- Do not use a tire, wheel size or rating other than that specified for your vehicle. Some combinations of unapproved tires and wheels may change suspension dimensions and performance characteristics, resulting in changes to steering, handling, and braking of your vehicle. This can cause unpredictable handling and stress to steering and suspension components. You could lose control and have an accident resulting in serious injury or death. Use only the tire and wheel sizes with load ratings approved for your vehicle.
- Never use a tire with a smaller load index or capacity, other than what was originally equipped on your vehicle. Using a tire with a smaller load index could result in tire overloading and failure. You could lose control and have an accident.
- Failure to equip your vehicle with tires having adequate speed capability can result in sudden tire failure and loss of vehicle control.

CAUTION!

Replacing original tires with tires of a different size may result in false speedometer and odometer readings.

Alignment and Balance

Poor suspension alignment may result in:

- Fast tire wear.
- Uneven tire wear, such as feathering and one-sided wear.
- Vehicle pull to right or left.

Tires may also cause the vehicle to pull to the left or right. Alignment will not correct this condition. See your authorized dealer for proper diagnosis.

Improper alignment will not cause vehicle vibration. Vibration may be a result of tire and wheel out-of-balance. Proper balancing will reduce vibration and avoid tire cupping and spotty wear.

TIRE CHAINS

Due to limited clearance, tire chains are not recommended.

CAUTION!
Damage to the vehicle may result if tire chains are used.

SNOW TIRES

Some areas of the country require the use of snow tires during Winter. Standard tires are of the all-season type and satisfy this requirement as indicated by the M+S designation on the tire sidewall.

If you need snow tires, select tires equivalent in size and type to the original equipment tires. Use snow tires only in sets of four; failure to do so may adversely affect the safety and handling of your vehicle.

Snow tires generally have lower speed ratings than what was originally equipped with your vehicle and should not be operated at sustained speeds over 75 mph (120 km/h).

TIRE ROTATION RECOMMENDATIONS

Tires on the front and rear axles of vehicles operate at different loads and perform different steering, driving, and braking functions. For these reasons, they wear at unequal rates and tend to develop irregular wear patterns.

These effects can be reduced by timely rotation of the tires. The benefits of rotation are especially worthwhile with aggressive tread designs such as those on all-season type tires. Rotation will increase tread life, help to maintain mud, snow, and wet traction levels and contribute to a smooth, quiet ride.

Follow the recommended tire rotation frequency for your type of driving found in the “Maintenance Schedules” Section of this manual. More frequent rotation is permissible, if desired. The reason(s) for any rapid or unusual wear should be corrected before rotating. The suggested rotation method is the “forward-cross” shown in the diagram below.

TIRE ROTATION PATTERN

← FRONT OF VEHICLE

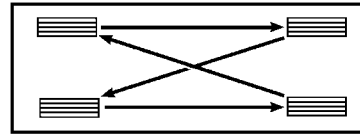

4 TIRE ROTATION

80ba79fe

TIRE PRESSURE MONITOR SYSTEM (TPMS) — IF EQUIPPED

- The Tire Pressure Monitor System (TPMS) will warn the driver of a low tire pressure based on the vehicle recommended cold placard pressure.
- The tire pressure will vary with temperature by about 1 psi (7 kPa) for every 12°F (7°C). This means that when the outside temperature decreases, the tire pressure will decrease. Tire pressure should always be set based on cold inflation tire pressure. This is defined as the tire pressure after the vehicle has not been driven for at least three hours, or driven less than 1 mi (1.6 km) after a three hour period. The cold tire inflation pressure must not exceed the maximum inflation pressure molded into the tire sidewall. **Refer to the “Tires – General Information” in this section for information on how to properly inflate the vehicle’s tires.** The tire pressure will also increase as the vehicle is driven - this is normal and there should be no adjustment for this increased pressure.
- TPMS will warn the driver of a low tire pressure if the tire pressure falls below the low-pressure warning limit for any reason, including low temperature effects and natural pressure loss through the tire.
- TPMS will continue to warn the driver of low tire pressure as long as the condition exists, and will not turn off until the tire pressure is at or above the recommended cold placard pressure. Once the low tire pressure warning has been illuminated, you must increase the tire pressure to the recommended cold placard pressure in order for the TPM Light to turn off. The system will automatically update and the TPM Light will turn off once the system receives the updated tire pressures. The vehicle may need to be

driven for up to 10 minutes above 15 mph (25 km/h) in order for the TPMS to receive this information.

- For example, your vehicle may have a recommended cold (parked for more than three hours) placard pressure of 33 psi (227 kPa). If the ambient temperature is 68° F (20° C) and the measured tire pressure is 28 psi (193 kPa), a temperature drop to 20° F (-7° C) will decrease the tire pressure to approximately 24 psi (165 kPa). This tire pressure is sufficiently low enough to turn ON the TPM Light. Driving the vehicle may cause the tire pressure to rise to approximately 28 psi (193 kPa), but the TPM Light will still be ON. In this situation, the TPM Light will turn OFF only after the tires are inflated to the vehicle's recommended cold placard pressure value.

CAUTION!

- **The TPMS has been optimized for the original equipment tires and wheels. TPMS pressures and warning have been established for the tire size equipped on your vehicle. Undesirable system operation or sensor damage may result when using replacement equipment that is not of the same size, type, and/or style. Aftermarket wheels can cause sensor damage. Do not use aftermarket tire sealants or balance beads if your vehicle is equipped with a TPMS, as damage to the sensors may result.**
- **After inspecting or adjusting the tire pressure, always reinstall the valve stem cap. This will prevent moisture and dirt from entering the valve stem, which could damage the Tire Pressure Monitoring Sensor.**

NOTE:

- TPMS is not intended to replace normal tire care and maintenance, or to provide warning of a tire failure or condition.
- TPMS should not be used as a tire pressure gauge while adjusting your tire pressure.
- Driving on a significantly under-inflated tire causes the tire to overheat and can lead to tire failure. Under-inflation also reduces fuel efficiency and tire tread life, and may affect the vehicle's handling and stopping ability.
- TPMS is not a substitute for proper tire maintenance, and it is the driver's responsibility to maintain correct tire pressure using an accurate tire pressure gauge, even if under-inflation has not reached the level to trigger illumination of the TPM Light.

- Seasonal temperature changes will affect tire pressure, and the TPMS will monitor the actual tire pressure in the tire.

BASE SYSTEM — IF EQUIPPED

The Tire Pressure Monitor System (TPMS) uses wireless technology with wheel rim mounted electronic sensors to monitor tire pressure levels. Sensors, mounted to each wheel as part of the valve stem, transmit tire pressure readings to the Receiver Module.

NOTE: It is particularly important for you to check the tire pressure in all of the tires on your vehicle monthly and to maintain the proper pressure.

The TPMS consists of the following components:

- Receiver Module
- Four Tire Pressure Monitoring Sensors
- Tire Pressure Monitoring Telltale Light

Tire Pressure Monitoring Low Pressure Warnings



The TPM Light will illuminate in the instrument cluster and a chime will sound when tire pressure is low in one or more of the four active road tires. Should this occur, you should stop as soon as possible, check the inflation pressure of each tire on your vehicle, and inflate each tire to the vehicle's recommended cold placard pressure value. Once the system receives the updated tire pressures, the system will automatically update and the TPM Light will turn off. The vehicle may need to be driven for up to 10 minutes above 15 mph (25 km/h) in order for the TPMS to receive this information.

Check TPMS Warning

The TPM Light will flash on and off for 75 seconds and then remain on solid when a system fault is detected. The system fault will also sound a chime. If the ignition key is cycled, this sequence will repeat, providing the system

fault still exists. The TPM Light will turn off when the fault condition no longer exists. A system fault can occur due to any of the following:

1. Signal interference due to electronic devices or driving next to facilities emitting the same Radio Frequencies as the TPM sensors.
2. Installing aftermarket window tinting that contains materials which may block radio wave signals.
3. Excessive accumulation of snow or ice around the wheels or wheel housings.
4. Using tire chains on the vehicle.
5. Using wheels/tires not equipped with TPM sensors.

NOTE:

1. The compact spare tire (if so equipped) does not have a tire pressure monitoring sensor. Therefore, the TPMS will not monitor the pressure in the compact spare tire.

2. If you install the compact spare tire in place of a road tire that has a pressure below the low-pressure warning limit, upon the next ignition key cycle, a chime will sound and the TPM Telltale Light will turn ON due to the low tire.
3. After driving the vehicle for up to 10 minutes above 15 mph (25 km/h), the TPM Telltale Light will flash on and off for 75 seconds and then remain on solid.
4. For each subsequent ignition key cycle, a chime will sound and the TPM Telltale Light will flash on and off for 75 seconds and then remain on solid.
5. Once you repair or replace the original road tire, and reinstall it on the vehicle in place of the compact spare, the TPMS will update automatically and the TPM Telltale Light will turn OFF, as long no tire pressure is below the low-pressure warning limit in any of the four active road

tires. The vehicle may need to be driven for up to 10 minutes above 15 mph (25 km/h) in order for the TPMS to receive this information.

GENERAL INFORMATION

This device complies with part 15 of the FCC rules and RSS 210 of Industry Canada. Operation is subject to the following conditions:

- This device may not cause harmful interference.
- This device must accept any interference received, including interference that may cause undesired operation.

The tire pressure sensors are covered under one of the following licenses:

United States	KR5S120123
Canada	2671-S120123

FUEL REQUIREMENTS — GASOLINE ENGINES

2.4L AND 2.4L STANDARD TURBO ENGINES



2.4L standard engines are designed to meet all emission regulations and provide excellent fuel economy and performance when using high quality unleaded “regular” gasolines having an octane rating of 87.

The use of premium gasoline is not recommended. Under normal conditions, the use of premium gasoline will not provide a benefit over high quality unleaded “regular” gasolines, and in some circumstances may result in poorer performance.

REFORMULATED GASOLINE

Many areas of the country require the use of cleaner burning gasoline referred to as “Reformulated Gasoline”.

Reformulated gasolines contain oxygenates, and are specifically blended to reduce vehicle emissions and improve air quality.

The manufacturer supports the use of reformulated gasolines. Properly blended reformulated gasolines will provide excellent performance and durability of engine and fuel system components.

GASOLINE/OXYGENATE BLENDS

Some fuel suppliers blend unleaded gasoline with oxygenates such as 10% ethanol, MTBE, and ETBE. Oxygenates are required in some areas of the country during the winter months to reduce carbon monoxide emissions. Fuels blended with these oxygenates may be used in your vehicle.

CAUTION!

DO NOT use gasoline containing Methanol or E85 Ethanol. Use of these blends may result in starting and driveability problems and may damage critical fuel system components.

Problems that result from using methanol/gasoline or E85 Ethanol blends are not the responsibility of the manufacturer. While MTBE is an oxygenate made from Methanol, it does not have the negative effects of Methanol.

MMT IN GASOLINE

MMT is a manganese containing metallic additive that is blended into some gasoline to increase the octane number. Gasolines blended with MMT offer no performance advantage beyond gasolines of the same octane number without MMT. Gasolines blended with MMT have shown to reduce spark plug life and reduce emission system performance in some vehicles. The manufacturer recommends using gasolines without MMT. Since the MMT content of gasoline may not be indicated on the pump, you should ask your gasoline retailer whether or not his/her gasoline contains MMT.

It is even more important to look for gasolines without MMT in Canada, because MMT can be used at levels higher than those allowed in the United States.

MMT is prohibited in Federal and California reformulated gasolines.

MATERIALS ADDED TO FUEL

All gasoline sold in the United States is required to contain effective detergent additives. Use of additional detergents or other additives is not needed under normal conditions and would result in additional cost. Therefore you should not have to add anything to the fuel.

FUEL SYSTEM CAUTIONS

CAUTION!
Follow these guidelines to maintain your vehicle's performance:

- The use of leaded gas is prohibited by Federal law. Using leaded gasoline can impair engine performance, damage the emission control system.
- An out-of-tune engine, or certain fuel or ignition malfunctions, can cause the catalytic converter to overheat. If you notice a pungent burning odor or some light smoke, your engine may be out of tune or malfunctioning and may require immediate service. Contact your dealer for service assistance.
- The use of fuel additives which are now being sold as octane enhancers is not recommended. Most of these products contain high concentrations of methanol. Fuel system damage or vehicle performance problems resulting from the use of such fuels or additives is not the responsibility of the manufacturer.

NOTE: Intentional tampering with emissions control systems can result in civil penalties being assessed against you.

CARBON MONOXIDE WARNINGS

WARNING!

Carbon monoxide (CO) in exhaust gases is deadly. Follow the precautions below to prevent carbon monoxide poisoning:

- Do not inhale exhaust gases. They contain carbon monoxide, a colorless and odorless gas which can kill. Never run the engine in a closed area, such as a garage, and never sit in a parked vehicle with the engine running for an extended period. If the vehicle is stopped in an open area with the engine running for more than a short period, adjust the ventilation system to force fresh, outside air into the vehicle.
- Guard against carbon monoxide with proper maintenance. Have the exhaust system inspected every time

the vehicle is raised. Have any abnormal conditions repaired promptly. Until repaired, drive with all side windows fully open.

- Keep the liftgate closed when driving your vehicle to prevent carbon monoxide and other poisonous exhaust gases from entering the vehicle.

ADDING FUEL

The fuel tank filler tube has a restricting door about 2 inches (50 mm) inside the opening. If using a portable container, it should have a flexible nozzle long enough to force open the restricting door.

Fuel Filler Cap (Gas Cap)

The gas cap is behind the fuel filler door, on the passenger's side of the vehicle. If the gas cap is lost or damaged, be sure the replacement cap is for use with this vehicle.

NOTE: When removing the fuel filler cap, lay the cap tether in the hook, located on the fuel filler cap door reinforcement.

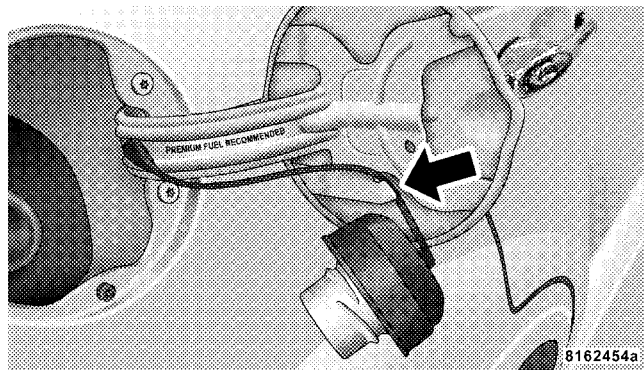

Gas Cap Tether Hook

NOTE: If the gas cap is lost or damaged, be sure the replacement cap is for use with this vehicle.

CAUTION!

- Damage to the fuel system or emission control system could result from using an improper fuel tank filler tube cap (gas cap).
- A poorly fitting gas cap could let impurities into the fuel system.
- A poorly fitting gas cap may cause the Malfunction Indicator Light to turn on.
- To avoid fuel spillage and overfilling, do not “top off” the fuel tank after filling. When the fuel nozzle “clicks” or shuts off, the fuel tank is full.

WARNING!

- Never have any smoking materials lit in or near the vehicle when the gas cap is removed or the tank filled.
- Never add fuel when the engine is running. This is in violation of most state and federal fire regulations and doing so will cause the malfunction indicator light to turn on.
- A fire may result if gasoline is pumped into a portable container that is inside of a vehicle. You could be burned. Always place gas containers on the ground while filling.

NOTE:

- Tighten the gas cap until you hear a “clicking” sound. This is an indication that the gas cap is tightened properly. The Malfunction Indicator Light in the instrument cluster may turn on if the gas cap is not secured properly. Make sure that the gas cap is tightened each time the vehicle is refueled.
- When the fuel nozzle “clicks” or shuts off, the fuel tank is full.

Loose Fuel Filler Cap Message

If the vehicle diagnostic system determines that the fuel filler cap is loose, improperly installed, or damaged, a “gASCAP” message will be displayed in the Odometer/Trip Odometer in the instrument cluster. Refer to “Instrument Cluster Description” in Section 4 of this manual. Tighten the fuel filler cap properly and press the odometer/trip odometer reset button to turn the message off. If the problem continues, the message will appear the

next time the vehicle is started. This might indicate a damaged cap. If the problem is detected twice in a row, the system will turn on the Malfunction Indicator Light (MIL). Resolving the problem will turn the MIL light off. Refer to “Onboard Diagnostic System — OBDII” in Section 7 of this manual for more information.

VEHICLE LOADING

Vehicle Loading Capacities

Front Seat Occupants	2
Rear Seat Occupants (sedan)	3
Rear Seat Occupants (convertible)	2
Luggage	115 lbs (52 kg)
Rated Vehicle Capacity (sedan)	865 lb (392 kg)
Rated Vehicle Capacity (convertible)	715 lb (324 kg)

TRAILER TOWING

In this section you will find safety tips and information on limits to the type of towing you can reasonably do with your vehicle. Before towing a trailer carefully review this information to tow your load as efficiently and safely as possible.

To maintain warranty coverage, follow the requirements and recommendations in this manual concerning vehicles used for trailer towing.

COMMON TOWING DEFINITIONS

The following trailer towing related definitions will assist you in understanding the following information:

Gross Vehicle Weight Rating (GVWR)

The GVWR is the total allowable weight of your vehicle. This includes driver, passengers, cargo and tongue weight. The total load must be limited so that you do not exceed the GVWR.

Gross Trailer Weight (GTW)

The gross trailer weight (GTW) is the weight of the trailer plus the weight of all cargo, consumables and equipment (permanent or temporary) loaded in or on the trailer in its "loaded and ready for operation" condition. The recommended way to measure GTW is to put your fully loaded trailer on a vehicle scale. The entire weight of the trailer must be supported by the scale.

Gross Combination Weight Rating (GCWR)

The gross combination weight rating (GCWR) is the total permissible weight of your vehicle and trailer when weighed in combination. (Note that GCWR ratings include a 68 kg (150 lbs) allowance for the presence of a driver).

Gross Axle Weight Rating (GAWR)

The GAWR is the maximum capacity of the front and rear axles. Distribute the load over the front and rear axles evenly. Make sure that you do not exceed either front or rear GAWR.

WARNING!

It is important that you do not exceed the maximum front or rear GAWR. A dangerous driving condition can result if either rating is exceeded. You could lose control of the vehicle and have an accident.

Tongue Weight (TW)

The downward force exerted on the hitch ball by the trailer. In most cases it should not be less than 10% or more than 15% of the trailer load. You must consider this as part of the load on your vehicle.

Frontal Area

The maximum height and maximum width of the front of a trailer.

Trailer Sway Control

The trailer sway control is a telescoping link that can be installed between the hitch receiver and the trailer tongue that typically provides adjustable friction associated with the telescoping motion to dampen any unwanted trailer swaying motions while traveling.

Weight-Carrying Hitch

A weight-carrying hitch supports the trailer tongue weight, just as if it were luggage located at a hitch ball or some other connecting point of the vehicle. These kind of hitches are the most popular on the market today and they're commonly used to tow small- and medium-sized trailers.

Weight-Distributing Hitch

A weight-distributing system works by applying leverage through spring (load) bars. They are typically used for heavier loads, to distribute trailer tongue weight to the tow vehicle's front axle and the trailer axle(s). When used in accordance with the manufacturers' directions, it provides for a more level ride, offering more consistent steering and brake control thereby enhancing towing safety. The addition of a friction/hydraulic sway control also dampens sway caused by traffic and crosswinds and contributes positively to tow vehicle and trailer stability. Trailer sway control and a weight distributing (load equalizing) hitch are recommended for heavier Tongue Weights (TW) and may be required depending on Vehicle and Trailer configuration / loading to comply with gross axle weight rating (GAWR) requirements.

WARNING!

An improperly adjusted Weight Distributing Hitch system may reduce handling, stability, braking performance, and could result in an accident.

Weight Distributing Systems may not be compatible with Surge Brake Couplers. Consult with your hitch and trailer manufacturer or a reputable Recreational Vehicle dealer for additional information.

5

TRAILER HITCH CLASSIFICATION

Your vehicle may be factory equipped for safe towing of trailers weighing over 1,000 lbs (454 kg) with the optional Trailer Tow Prep Package. See your authorized dealer service center for package content.

The following chart provides the industry standard for the maximum trailer weight a given trailer hitch class can tow and should be used to assist you in selecting the correct trailer hitch for your intended towing condition. Refer to the Trailer Towing Weights (Maximum Trailer Weight Ratings) chart for the Max. GTW towable for your given drivetrain.

TRAILER HITCH CLASSIFICATION	
Class	Max. GTW (Gross Trailer Wt.)
Class I - Light Duty	2,000 lbs (907 kg)
Class II - Medium Duty	3,500 lbs (1 587 kg)

All trailer hitches should be professionally installed on your vehicle.

TRAILER TOWING WEIGHTS (MAXIMUM TRAILER WEIGHT RATINGS)

The following chart provides the maximum trailer weight ratings towable for your given drivetrain.

TRAILER TOWING WEIGHTS			
Engine/Transmission	Frontal Area	Max. GTW (Gross Trailer Wt.)	Max. Tongue Wt. (See Note 1)
2.4L N/A and 2.4L Turbo/ Automatic*	20 Sq Ft	1000 lbs (454 kg)	110 lbs (50 kg)
2.4L N/A and 2.4L Turbo/ Manual*	20 Sq Ft	1000 lbs (454 kg)	110 lbs (50 kg)
* N/A (Naturally Aspirated)			
Note 1 - The trailer tongue weight must be considered as part of the combined weight of occupants and cargo, and should never exceed the weight referenced on the Tire and Loading Information placard. Refer to the following "Tire-Safety Information" section in this manual.			
Refer to local laws for maximum trailer towing speeds.			

TRAILER AND TONGUE WEIGHT

Always load a trailer with 60% to 65% of the weight in the front of the trailer. This places 10% to 15% of the Gross Trailer Weight (GTW) on the tow hitch of your vehicle. Loads balanced over the wheels or heavier in the rear can cause the trailer to sway **severely** side to side which will cause loss of control of the vehicle and trailer. Failure to load trailers heavier in front is the cause of many trailer accidents.

Never exceed the maximum tongue weight stamped on your bumper or trailer hitch.

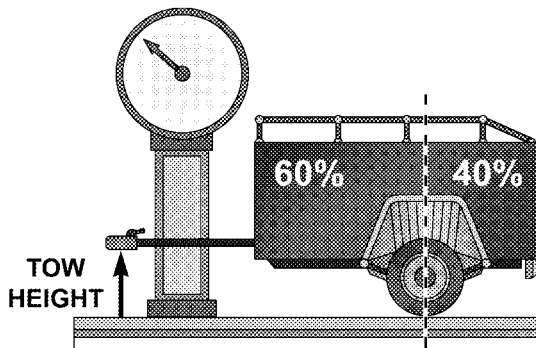

Consider the following items when computing the weight on the rear axle of the vehicle:

- The tongue weight of the trailer.
- The weight of any other type of cargo or equipment put in or on your vehicle.
- The weight of the driver and all passengers.

NOTE: Remember that everything put into or on the trailer adds to the load on your vehicle. Also, additional factory-installed options, or dealer-installed options, must be considered as part of the total load on your vehicle. Refer to the Tire and Loading Information placard in the Tire Safety Information Section of this manual for the maximum combined weight of occupants and cargo for your vehicle.

TOWING REQUIREMENTS

To promote proper break-in of your new vehicle drivetrain components the following guidelines are recommended:

CAUTION!

- **Avoid towing a trailer for the first 500 mi (805 km) of vehicle operation. Doing so may damage your vehicle.**
- **During the first 500 mi (805 km) of trailer towing, limit your speed to 50 mph (80 km/h).**

Perform the maintenance listed in Section 8 of this manual. When towing a trailer, never exceed the GAWR, or GCWR, ratings.

WARNING!

- **Improper towing can lead to an injury accident.**
 - **Make certain that the load is secured in the trailer and will not shift during travel. When trailering cargo that is not fully secured, dynamic load shifts can occur that may be difficult for the driver to control. You could lose control of your vehicle and have an accident.**
- When hauling cargo or towing a trailer, do not overload your vehicle or trailer. Overloading can cause a loss of control, poor performance or damage to brakes, axle, engine, transmission, steering, suspension, chassis structure or tires.
 - Safety chains must always be used between your vehicle and trailer. Always connect the chains to the frame or hook retainers of the vehicle hitch. Cross the chains under the trailer tongue and allow enough slack for turning corners.
 - Vehicles with trailers should not be parked on a grade. When parking, apply the parking brake on the tow vehicle. Put the tow vehicle automatic transmission in PARK. Always, block or "chock" the trailer wheels.
 - GCWR must not be exceeded.
 - **Total weight must be distributed between the tow vehicle and the trailer such that the following four ratings are not exceeded:**
 1. GVWR
 2. GTW
 3. GAWR

4. Tongue weight rating for the trailer hitch utilized (This requirement may limit the ability to always achieve the 10% to 15% range of tongue weight as a percentage of total trailer weight).

Towing Requirements — Tires

- Do not attempt to tow a trailer while using a compact spare tire.
- Proper tire inflation pressures are essential to the safe and satisfactory operation of your vehicle. Refer to the Tires–General Information section of this manual on Tire Pressures for proper tire inflation procedures.
- Also, check the trailer tires for proper tire inflation pressures before trailer usage.
- Check for signs of tire wear or visible tire damage before towing a trailer. Refer to the Tires–General Information section of this manual on Tread Wear Indicators for the proper inspection procedure.

- When replacing tires refer to the Tires–General Information section of this manual on Replacement Tires for proper tire replacement procedures. Replacing tires with a higher load carrying capacity will not increase the vehicle's GVWR and GAWR limits.

Towing Requirements — Trailer Brakes

- **Do not** interconnect the hydraulic brake system or vacuum system of your vehicle with that of the trailer. This could cause inadequate braking and possible personal injury.
- An electronically actuated trailer brake controller is required when towing a trailer with electronically actuated brakes. When towing a trailer equipped with a hydraulic surge actuated brake system, an electronic brake controller is not required.

- Trailer brakes are recommended for trailers over 1,000 lbs (454 kg) and required for trailers in excess of 2,000 lbs (907 kg).

CAUTION!

If the trailer weighs more than 1,000 lbs (454 kg) loaded, it should have its own brakes and they should be of adequate capacity. Failure to do this could lead to accelerated brake lining wear, higher brake pedal effort, and longer stopping distances.

WARNING!

Do not connect trailer brakes to your vehicle's hydraulic brake lines. It can overload your brake system and cause it to fail. You might not have brakes when you need them and could have an accident.

Towing any trailer will increase your stopping distance. When towing you should allow for additional space between your vehicle and the vehicle in front of you. Failure to do so could result in an accident.

Towing Requirements — Trailer Lights & Wiring

Whenever you pull a trailer, regardless of the trailer size, stop lights and turn signals on the trailer are required for motoring safety.

The Trailer Tow Package may include a four- or seven-pin wiring harness. Use a factory approved trailer harness and connector.

NOTE: Do not cut or splice wiring into the vehicles wiring harness.

The electrical connections are all complete to the vehicle but you must mate the harness to a trailer connector. Refer to the following illustrations.

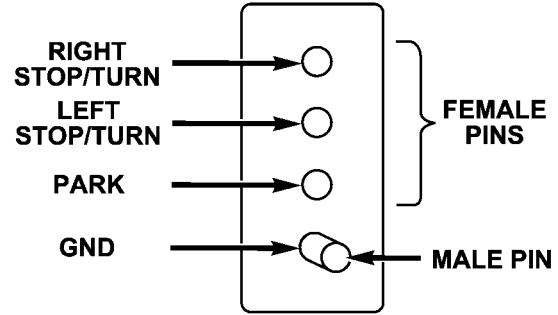

4-Pin Connector

813262be

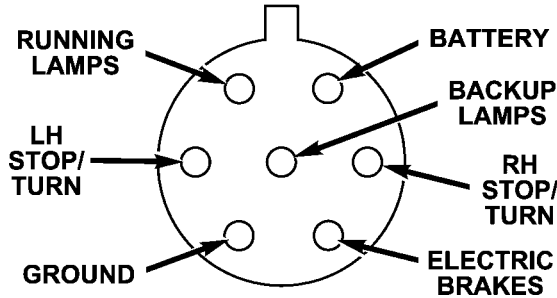

812634c6

7-Pin Connector

TOWING TIPS

Before setting out on a trip, practice turning, stopping and backing the trailer in an area away from heavy traffic.

Towing Tips — Automatic Transmission

The OVERDRIVE/DRIVE range can be selected when towing. However, if frequent shifting occurs while in this range, the [3] range should be selected.

NOTE: Using the [3] range while operating the vehicle under heavy operating conditions will improve performance and extend transmission life by reducing excessive shifting and heat build up. This action will also provide better engine braking.

The automatic transmission fluid and filter should be changed if you REGULARLY tow a trailer for more than 45 minutes of continuous operation. See the “Maintenance Schedule” in Section 8 of this manual for transmission fluid change intervals.

NOTE: Check the automatic transmission fluid level before towing.

Towing Tips — Electronic Speed Control (If Equipped)

- Don't use in hilly terrain or with heavy loads.
- When using the speed control, if you experience speed drops greater than 10 mph (16 km/h), disengage until you can get back to cruising speed.
- Use speed control in flat terrain and with light loads to maximize fuel efficiency.

Towing Tips — Cooling System

To reduce potential for engine and transmission overheating, take the following actions:

- ***City Driving***

When stopped for short periods of time, put transmission in NEUTRAL but do not increase engine idle speed.

- ***Highway Driving***

Reduce speed.

- ***Air Conditioning***

Turn off temporarily.

- Refer to Cooling System Operating information in the Maintenance Section of this manual for more information.

**RECREATIONAL TOWING (BEHIND
MOTORHOME, ETC.)**

**Towing This Vehicle Behind Another Vehicle (Flat
towing with all four wheels on the ground)**

CAUTION!

**Recreational towing on vehicle's equipped with au-
tomatic transaxle's is not recommended.**

NOTE: If the vehicle requires towing make sure all four wheels are off the ground.

If your vehicle is equipped with a manual transaxle, it may be towed with all four wheels on the ground, in a forward direction, at any legal highway speed, for any distance, if the transaxle is in NEUTRAL.

WHAT TO DO IN EMERGENCIES

CONTENTS

■ Hazard Warning Flasher	358	■ Driving On Slippery Surfaces	369
■ If Your Engine Overheats	358	□ Acceleration	369
■ Jacking And Tire Changing	360	□ Traction	370
□ Jack Location	361	■ Freeing A Stuck Vehicle	370
□ Spare Tire Stowage	361	■ Towing A Disabled Vehicle	371
□ Preparations For Jacking	362	□ With Ignition Key	371
□ Jacking Instructions	363	□ Without The Ignition Key	372
■ Jump-Starting Procedures Due To A Low Battery	367	■ Convertible Top Manual Override	373

HAZARD WARNING FLASHER

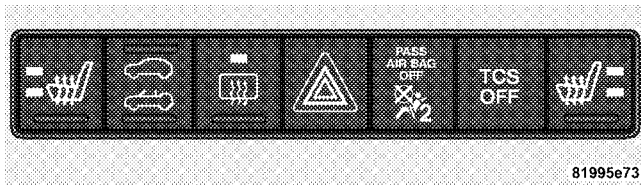

Hazard Warning Switch



The flasher switch is located on the instrument panel, below the radio. Depress the switch and both cluster indicators and all front and rear directional signals will flash. Depress the switch again to turn Hazard Warning Flashers off.

Do not use this emergency warning system when the vehicle is in motion. Use it when your vehicle is disabled and is creating a safety hazard for other motorists.

If it is necessary to leave the vehicle to go for service, the flasher system will continue to operate with the ignition key removed and the vehicle locked.

NOTE: With extended use, the flasher may wear down your battery.

IF YOUR ENGINE OVERHEATS

In any of the following situations, you can reduce the potential for overheating by taking the appropriate action.

- On the highways — Slow down.
- In city traffic — While stopped, put transaxle in neutral, but do not increase engine idle speed.

If the pointer rises to the **H** (red) mark, the instrument cluster will sound a chime. Pull over and stop the vehicle with the engine at idle, when safe. Turn off the air conditioning and wait until the pointer drops back into

the normal range. If the pointer remains on the H (red) mark for more than a minute, turn the engine off immediately and call for service.

NOTE: There are steps that you can take to slow down an impending overheat condition. If your air conditioner is on, turn it off. The air conditioning system adds heat to the engine cooling system and turning off the A/C removes this heat. You can also turn the Temperature control to maximum heat, the Mode control to floor, and the fan control to High. This allows the heater core to act as a supplement to the radiator and aids in removing heat from the engine cooling system.

CAUTION!

Driving with a hot cooling system could damage your vehicle. If temperature gauge reads “H”, pull over and stop the vehicle with the engine at idle, when safe. Turn the air conditioner off and wait until the pointer drops back into the normal range. After appropriate action has been taken, if the pointer remains on the “H”, turn the engine off immediately, and call for service.

WARNING!

A hot engine cooling system is dangerous. You or others could be badly burned by steam or boiling coolant. You may want to call a service center if your vehicle overheats. If you decide to look under the hood yourself, refer to Section 7, Maintenance, of this manual. Follow the warnings under the Cooling System Pressure Cap paragraph.

JACKING AND TIRE CHANGING**WARNING!**

- Being under a jacked-up vehicle is dangerous. The vehicle could slip off the jack and fall on you. You could be crushed. Never put any part of your body under a vehicle that is on a jack. Never start or run the engine while the vehicle is on a jack. If you need to get under a raised vehicle, take it to a service center where it can be raised on a lift.
- The jack is designed to use as a tool for changing tires only. The jack should not be used to lift the vehicle for service purposes. The vehicle should be jacked on a firm level surface only. Avoid ice or slippery areas.

JACK LOCATION

The jack and jack-handle are stowed behind the right rear side trim panel in the cargo area.

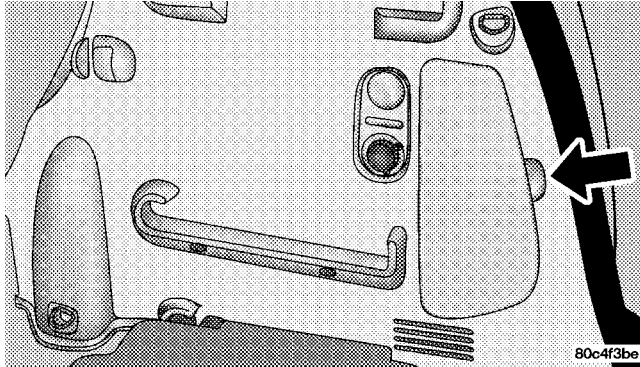

Jack Storage

Do not attempt to raise this vehicle using a bumper jack.

SPARE TIRE STORAGE

The compact spare tire is stowed under the rear of the vehicle by means of a hook/basket mechanism. To remove or stow the compact spare, use the jack handle to rotate the “spare tire drive” nut. The nut is located under the rear scuff plate at the right rear of the cargo area, just inside the liftgate opening.

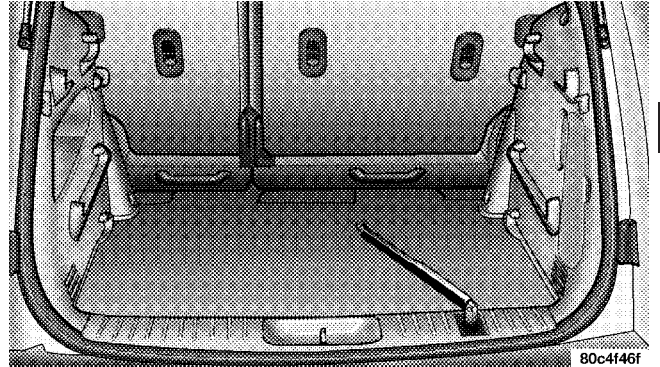

Spare Tire Storage

Spare Tire Removal

Lift up the cover and fit the jack-handle over the drive nut. Rotate the nut to the left until you can remove the swivel hook from the stowage basket. Swing the basket down to remove the compact spare tire.

CAUTION!

The hook is designed for use with the jack handle only. Use of an air wrench or other power tools is not recommended and can damage the winch.

PREPARATIONS FOR JACKING

Park the vehicle on a firm level surface, avoid ice or slippery areas, **set the parking brake** and place the gear selector in PARK (automatic transaxle) or REVERSE (manual transaxle). Turn OFF the ignition.

WARNING!

Do not attempt to change a tire on the side of the vehicle close to moving traffic. Pull far enough off the road to avoid the danger of being hit when operating the jack or changing the wheel.

- Turn on the Hazard Warning Flasher.

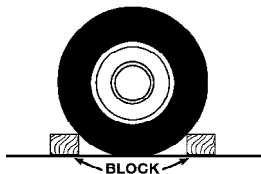

- Block both the front and rear of the wheel diagonally opposite the jacking position. For example, if changing the right front tire, block the left rear wheel.
- Passengers should not remain in the vehicle while the vehicle is being jacked.

JACKING INSTRUCTIONS



Jack Warning Label

WARNING!

Carefully follow these tire changing warnings to help prevent personal injury or damage to your vehicle:

- Always park on a firm, level surface as far from the edge of the roadway as possible before raising the vehicle.
- Block the wheel diagonally opposite the wheel to be raised.
- Set the parking brake firmly and set an automatic transmission in park; a manual transmission in reverse.

WARNING!

Carefully follow these tire changing warnings to help prevent personal injury or damage to your vehicle:

- Never start or run the engine with the vehicle on a jack.
- Do not let anyone sit in the vehicle when it is on a jack.
- Do not get under the vehicle when it is on a jack.
- Only use the jack in the positions indicated and for lifting this vehicle during a tire change.

WARNING!

Carefully follow these tire changing warnings to help prevent personal injury or damage to your vehicle:

- If working on or near a roadway, be extremely careful of motor traffic.
- To assure that spare tires, flat or inflated are securely stowed, spares must be stowed with the valve stem facing the ground.
- Turn on the Hazard warning flasher.

1. Remove the scissors jack and lug wrench from the stowage bag.

NOTE: If equipped with a center cap that covers the wheel nuts, pry off the cap using the small end of the lug wrench. To reinstall the cap, make sure it is properly lined up before pushing it on to the wheel.

2. Loosen, but do not remove, the wheel nuts by turning them to the left one turn while the wheel is still on the ground.

CAUTION!

Do not attempt to raise the vehicle by jacking on the cross-member below the radiator, on the front suspension cross-member, or on the rear axle assembly.

3. There are two front jacking locations on each side of the body and rear jacking locations located on the trailing arm bracket under the triangular cut out symbol. Turn

the jack screw to the right until the jack head is properly engaged with the lift area closest to the wheel to be changed.

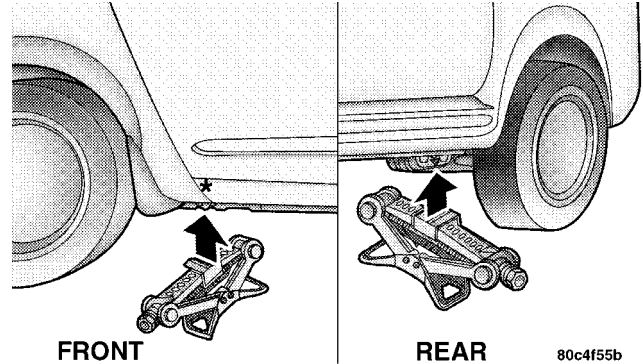

Jacking Locations

Do not raise the vehicle until you are sure the jack is securely engaged.

4. Raise the vehicle by turning the jack screw to the right, using the swivel wrench. Raise the vehicle only until the tire just clears the surface and enough clearance is obtained to install the spare tire. Minimum tire lift provides maximum stability.

WARNING!

Raising the vehicle higher than necessary can make the vehicle less stable. It could slip off the jack and hurt someone near it. Raise the vehicle only enough to remove the tire.

5. Remove the wheel nuts and pull the wheel and wheel covers where applicable off the hub. Install the spare wheel and wheel nuts with the cone shaped end of the nuts toward the wheel. Lightly tighten the nuts. To avoid the risk of forcing the vehicle off the jack, do not tighten the nuts fully until the vehicle has been lowered.

WARNING!

To avoid possible personal injury, handle the wheel covers with care to avoid contact with any sharp edges.

NOTE: The wheel cover is held on the wheel by the wheel nuts. When reinstalling original wheel, properly align the wheel cover to the valve stem, place the wheel cover onto the wheel, then install the wheel nuts.

6. Lower the vehicle by turning the jack screw to the left.

7. Finish tightening the nuts. Push down on the wrench while tightening the wheel nuts. Alternate nuts until each nut has been tightened twice. Correct wheel nut torque is 100 ft. lbs (135 N·m). If you doubt that you have tightened the nuts correctly, have them checked with a torque wrench by your dealer or at a service station.

8. Remove the wheel blocks and lower the jack until it is free. Stow the lug wrench, and jack in their designated location. Secure all parts using the means provided.

WARNING!

A loose tire or jack thrown forward in a collision or hard stop could endanger the occupants of the vehicle. Always stow the jack parts and the spare tire in the places provided. Have the deflated (flat) tire repaired or replaced immediately.

9. Place the deflated (flat) tire in the cargo area, **have the tire repaired or replaced as soon as possible.**

10. Check the tire pressure as soon as possible. Correct pressure as required.

JUMP-STARTING PROCEDURES DUE TO A LOW BATTERY

WARNING!

Take care to avoid the radiator cooling fan whenever the hood is raised. It can start anytime the ignition switch is on. You can be hurt by the fan.

WARNING!

Do not attempt to push or tow your vehicle to get it started. Vehicles equipped with an automatic transaxle cannot be started this way. Unburned fuel could enter the catalytic converter and once the engine has started, ignite and damage the converter and vehicle. If the vehicle has a discharged battery, booster cables may be used to obtain a start from another vehicle. This type of start can be dangerous if done improperly, so follow this procedure carefully.

1. Wear eye protection and remove any metal jewelry such as watch bands or bracelets that might make an inadvertent electrical contact.

2. When boosting from a battery in another vehicle, park that vehicle within booster cable reach but without letting the vehicles touch. Set parking brake, place automatic transaxle in PARK (manual transaxle in NEUTRAL) and turn ignition to OFF for both vehicles.

3. Turn off the heater, radio and all unnecessary electrical loads.

4. Connect one end of a jumper cable to the positive terminal of the booster battery. Connect the other end of the jumper cable to the positive terminal of the discharged battery.

WARNING!

Battery fluid is a corrosive acid solution; do not allow battery fluid to contact eyes, skin or clothing. Don't lean over battery when attaching clamps or allow the clamps to touch each other. If acid splashes in eyes or on skin, flush the contaminated area immediately with large quantities of water.

A battery generates hydrogen gas which is flammable and explosive. Keep flame or spark away from the vent holes. Do not use a booster battery or any other booster source with an output that exceeds 12 volts.

5. Connect the other cable, first to the negative terminal of the booster battery and then to the negative terminal of the discharged battery. Make sure you have a good contact.

6. If the vehicle is equipped with Sentry Key Immobilizer, turn the ignition switch to the ON position for 3 seconds before moving the ignition switch to the START position.

7. Start the engine in the vehicle that has the booster battery, let the engine idle a few minutes, then start the engine in the vehicle with the discharged battery.

8. When removing the jumper cables, reverse the sequence exactly. Be careful of the moving belts and fan.

DRIVING ON SLIPPERY SURFACES**ACCELERATION**

Rapid acceleration on snow covered, wet, or other slippery surfaces may cause the front wheels to pull erratically to the right or left. This phenomenon occurs when there is a difference in the surface traction under the front (driving) wheels.

WARNING!

Rapid acceleration on slippery surfaces is dangerous. Unequal traction can cause sudden pulling of the front wheels. You could lose control of the vehicle and possibly have an accident. Accelerate slowly and carefully whenever there is likely to be poor traction (ice, snow, wet, mud, loose sand, etc.).

TRACTION

When driving on wet or slushy roads, it is possible for a wedge of water to build up between the tire and road surface. This is hydroplaning and may cause partial or complete loss of vehicle control and stopping ability. To reduce this possibility, the following precautions should be observed:

1. Slow down during rainstorms or when roads are slushy.

2. Slow down if the road has standing water or puddles.
3. Replace the tires when tread wear indicators first become visible.
4. Keep the tires properly inflated.
5. Maintain enough distance between your vehicle and the vehicle in front of you to avoid a collision in a sudden stop.

FREEING A STUCK VEHICLE

NOTE: If your vehicle is equipped with Traction Control, turn the system OFF before attempting to “rock” the vehicle.

If your vehicle becomes stuck in mud, sand or snow, it can often be moved by a rocking motion. Turn your steering wheel right and left to clear the area around the front wheels. Then shift back and forth between Reverse and First gear. Usually the least accelerator pedal pressure to maintain the rocking motion without spinning the wheels is most effective.

WARNING!

Fast spinning tires can be dangerous. Forces generated by excessive wheel speeds may cause tire damage or failure. A tire could explode and injure someone. Do not spin your vehicle's wheels faster than 30 mph (48 km/h) when you are stuck. And don't let anyone near a spinning wheel, no matter what the speed.

CAUTION!

Racing the engine or spinning the wheels too fast may lead to transaxle overheating and failure. It can also damage the tires. Do not spin the wheels above 30 mph (48 km/h).

TOWING A DISABLED VEHICLE**With Ignition Key****Four Speed Automatic Transaxle**

Your vehicle may be towed under the following conditions: The steering column must be unlocked and the gear selector must be in NEUTRAL, the distance to be towed must not exceed 100 miles (160 km), and the towing speed must not exceed 44 mph (72 km/h). If the transaxle is not operative, or if the vehicle is to be towed more than 100 miles (160 km), the vehicle must be towed with the front wheels off the ground to avoid damage to the transaxle.

Manual Transaxle

Your vehicle may be towed in a forward direction, with all 4 wheels on the ground, and the gearshift lever is in NEUTRAL. If the transaxle is not operative, the vehicle must be towed with the front wheels off the ground.

All Transaxles

CAUTION!

If the vehicle being towed requires steering, the ignition switch must be in the ACC position, not in the LOCK positions.

Do not attempt to use sling type equipment when towing. When securing vehicle to flat bed truck, do not attach to front or rear suspension components. Damage to your vehicle may result from improper towing.

If it is necessary to use the accessories while being towed (wipers, defrosters, etc.), the key must be in the ON position, not the ACC position. Make certain the transaxle remains in NEUTRAL.

Without The Ignition Key

Special care must be taken when the vehicle is towed with the ignition in the LOCK position. A dolly should be used under the front wheels if the rear wheels are raised. Proper towing equipment is necessary to prevent damage to the vehicle.

Towing This Vehicle Behind Another Vehicle (Flat Towing With All Four Wheels On The Ground)

If your vehicle is equipped with a manual transaxle, it may be towed in a forward direction, at any legal highway speed, for any distance, if the transaxle is in NEUTRAL.

If the ignition key is not available, vehicles with automatic transaxles can not be flat towed at any time.

CONVERTIBLE TOP MANUAL OVERRIDE

If your vehicle is experiencing electrical failure (low battery, etc.) and it is necessary to raise the convertible top, perform the following steps:

1. Locate the convertible top motor bypass screw, which is found in the trunk under the convertible top storage area.
2. Turn the screw counterclockwise until the screw stops. This will relieve the hydraulic pressure and allow the convertible top to be raised manually.

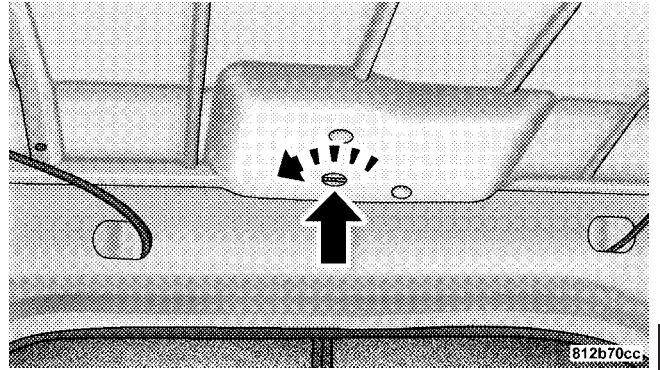

Bleeder Screw

3. Using the latch handle raise the top until the two pins seat themselves in the windshield header.
4. Rotate the latch handle clockwise to open the latches.
5. Pull down and rotate the handle counterclockwise to engage the latches.

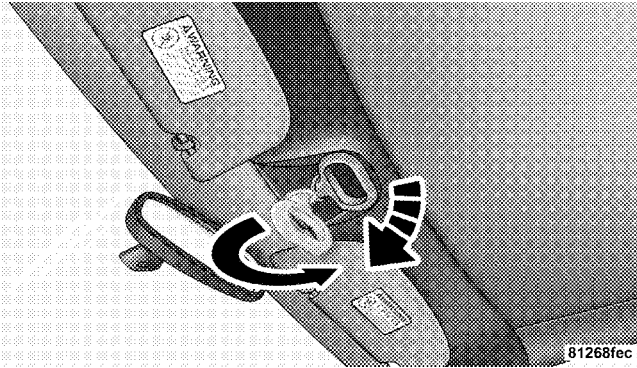

Engaging Convertible Top

6. Raise the handle into the stowed position.
 7. Close the convertible top motor bypass screw by turning the screw clockwise until it stops. Tighten the screw securely.
- NOTE:** Failure to tighten the bypass screw securely can cause convertible top operating concerns.

MAINTAINING YOUR VEHICLE

CONTENTS

■ 2.4L Turbo Engine Compartment	378	□ Engine Oil	384
■ 2.4L Engine Compartment	379	□ Drive Belts — Check Condition And Tension . .	388
■ Onboard Diagnostic System — OBD II	380	□ Spark Plugs	388
□ Loose Fuel Filler Cap Message	381	□ Ignition Wiring System	388
■ Emissions Inspection And Maintenance Programs	381	□ Catalytic Converter	389
■ Replacement Parts	383	□ Engine Timing Belt	390
■ Authorized Dealer Service	383	□ Crankcase Emission Control System	390
■ Maintenance Procedures	384	□ Fuel Filter	391
		□ Air Cleaner Element (Air Filter)	391

- Maintenance-Free Battery392
- Air Conditioner Maintenance393
- Power Steering – Fluid Check394
- Front Suspension Ball Joints395
- Steering Linkage395
- Body Lubrication395
- Windshield Wiper Blades396
- Windshield Washer Reservoir396
- Exhaust System397
- Cooling System398
- Hoses And Vacuum/Vapor Harnesses403
- Fuel System Connections404
- Brake System404
- Automatic Transaxle408
- Manual Transaxle410
- Appearance Care And Protection From Corrosion411
- Convertible Top Care416
 - Washing416
 - General Cleaning417
 - Cloth Top Additional Cleaning Procedure418
 - Cloth Top Protection418
 - Weather Strip Care418
- Integrated Power Module (IPM)419
- Vehicle Storage423
- Replacement Bulbs424

■ Bulb Replacement	425	<input type="checkbox"/> Center High Mounted Stop Light	428
<input type="checkbox"/> Headlights	425	■ Fluids And Capacities	429
<input type="checkbox"/> Front Park/Turn Signal/Side Marker Lights . .	426	■ Fluids, Lubricants And Genuine Parts	430
<input type="checkbox"/> Front Fog Lights — If Equipped	426	<input type="checkbox"/> Engine	430
<input type="checkbox"/> Tail/Stop, And Rear Turn Signal Lights	427	<input type="checkbox"/> Chassis	431
<input type="checkbox"/> Back Up Lights	427		

2.4L TURBO ENGINE COMPARTMENT

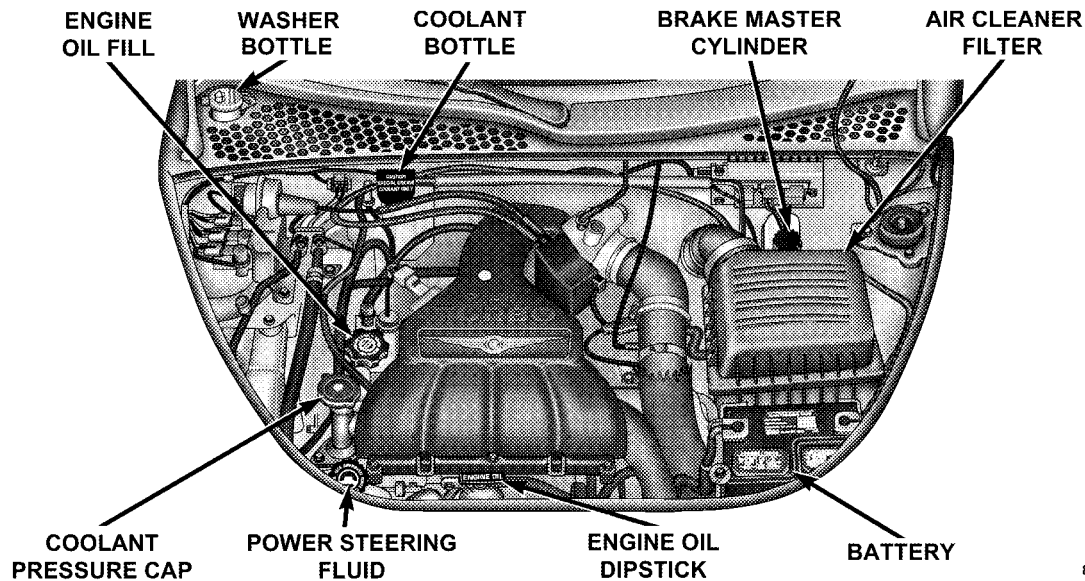

2.4L ENGINE COMPARTMENT

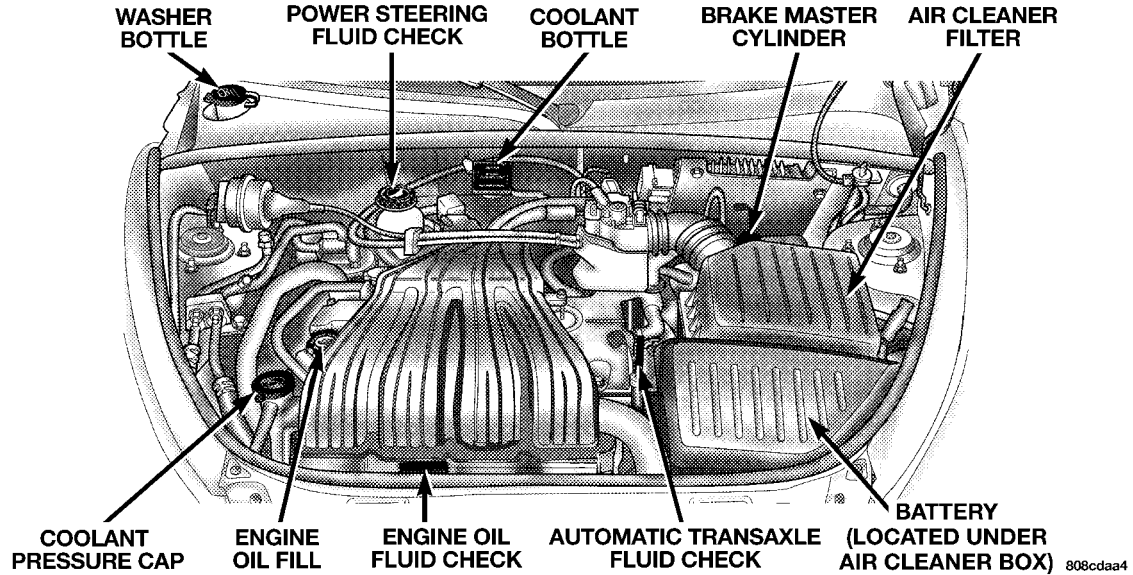

ONBOARD DIAGNOSTIC SYSTEM — OBD II

Your vehicle is equipped with a sophisticated onboard diagnostic system called OBD II. This system monitors the performance of the emissions, engine, and automatic transmission control systems. When these systems are operating properly, your vehicle will provide excellent performance and fuel economy, as well as engine emissions well within current government regulations.

If any of these systems require service, the OBD II system will turn on the “Malfunction Indicator Light.” It will also store diagnostic codes and other information to assist your service technician in making repairs. Although your vehicle will usually be drivable and not need towing, see your dealer for service as soon as possible.

CAUTION!

- **Prolonged driving with the “Malfunction Indicator Light” on could cause further damage to the emission control system. It could also affect fuel economy and driveability. The vehicle must be serviced before any emissions tests can be performed.**
- **If the “Malfunction Indicator Light” is flashing while the engine is running, severe catalytic converter damage and power loss will soon occur. Immediate service is required.**

Loose Fuel Filler Cap Message

After fuel is added, the vehicle diagnostic system can determine if the fuel filler cap is loose, improperly installed, or damaged. A gASCAP message will be displayed in the instrument cluster. Tighten the gas cap until a "clicking" sound is heard. This is an indication that the gas cap is properly tightened. Press the odometer reset button to turn the message off. If the problem persists, the message will appear the next time the vehicle is started. This might indicate a damaged cap. If the problem is detected twice in a row, the system will turn on the Malfunction Indicator Light (MIL). Resolving the problem will turn the MIL light off.

EMISSIONS INSPECTION AND MAINTENANCE PROGRAMS

In some localities, it may be a legal requirement to pass an inspection of your vehicle's emissions control system. Failure to pass could prevent vehicle registration.



For states that require an Inspection and Maintenance (I/M), this check verifies the Malfunction Indicator Light (MIL) is functioning and is not on when the engine is running, and that the OBD II system is ready for testing.

Normally, the OBD II system will be ready. The OBD II system may **not** be ready if your vehicle was recently serviced, recently had a dead battery, or a battery replacement. If the OBD II system should be determined not ready for the I/M test, your vehicle may fail the test.

Your vehicle has a simple ignition key-actuated test, which you can use prior to going to the test station. To check if your vehicle's OBD II system is ready, you must do the following:

1. Insert your ignition key into the ignition switch.
2. Turn the ignition to the ON position, but do not crank or start the engine.
3. If you crank or start the engine, you will have to start this test over.
4. As soon as you turn your key to the ON position, you will see the MIL symbol come on as part of a normal bulb check.
5. Approximately 15 seconds later, one of two things will happen:
 - a. The MIL will flash for about 10 seconds and then return to being fully illuminated until you turn OFF

the ignition key or start the engine. This means that your vehicle's OBD II system is **not ready** and you should **not** proceed to the I/M station.

- b. The MIL will not flash at all and will remain fully illuminated until you turn OFF the ignition key or start the engine. This means that your vehicle's OBD II system is **ready**, and you can proceed to the I/M station.

If your OBD II system is **not ready**, you should see your authorized dealer or repair facility. If your vehicle was recently serviced or had a battery failure or replacement, you may need to do nothing more than drive your vehicle as you normally would in order for your OBD II system to update. A recheck with the above test routine may then indicate that the system is now ready.

Regardless of whether your vehicle's OBD II system is ready or not ready, if the MIL is illuminated during normal vehicle operation, you should have your vehicle

serviced before going to the I/M station. The I/M station can fail your vehicle because the MIL is on with the engine running.

REPLACEMENT PARTS

Use of genuine Mopar® parts for normal/scheduled maintenance and repairs is highly recommended to ensure the designed performance. Damage or failures caused by the use of non-Mopar® parts for maintenance and repairs will not be covered by the manufacturer's warranty.

AUTHORIZED DEALER SERVICE

Your authorized dealer has the qualified service personnel, special tools, and equipment to perform all service operations in an expert manner. Service manuals are available which include detailed service information for your vehicle. Refer to these Service manuals before attempting any procedure yourself.

NOTE: Intentional tampering with emissions control systems can result in civil penalties being assessed against you.

WARNING!

You can be badly injured working on or around a motor vehicle. Only do service work for which you have the knowledge and the proper equipment. If you have any doubt about your ability to perform a service job, take your vehicle to a competent mechanic.

MAINTENANCE PROCEDURES

The pages that follow contain the **required** maintenance services determined by the engineers who designed your vehicle.

Besides the maintenance items for which there are fixed maintenance intervals, there are other items that should operate satisfactorily without periodic maintenance. However, if a malfunction of these items does occur, it could adversely affect the engine or vehicle performance. These items should be inspected if a malfunction is observed or suspected.

ENGINE OIL

Checking Oil Level

To assure proper engine lubrication, the engine oil must be maintained at the correct level. Check the oil level at regular intervals, such as every fuel stop.

The best time to check the engine oil level is about five minutes after a fully warmed engine is shut off. Do not check oil level before starting the engine after it has sat overnight. Checking engine oil level when the engine is cold will give you an incorrect reading.

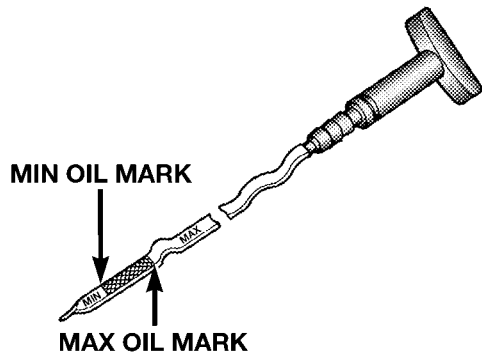

Engine Oil Dipstick

Checking the oil while the vehicle is on level ground, will improve the accuracy of the oil level readings. Maintain the oil level between the MIN and MAX markings on the dipstick. Adding one quart of oil when the reading is at the MIN mark will result in a MAX reading on these engines.

CAUTION!

Overfilling the crankcase as indicated by an oil level above the “Max” mark on the engine oil dipstick will cause oil aeration, which can lead to loss of oil pressure and an increase in oil temperature. This could damage your engine.

Change Engine Oil

Road conditions and your kind of driving affects the interval at which your oil should be changed. Check the following list to decide if any apply to you.

- Day and night temperatures are below 32°F (0°C).
- Stop and Go driving.
- Extensive engine idling.
- Driving in dusty conditions.
- Short trips of less than 10 miles (16 km).
- More than 50% of your driving is at sustained high speeds during hot weather, above 90°F (32°C).
- Trailer towing.
- Taxi, Police or delivery service (commercial service).
- Off-Road or desert operation.
- **If equipped for and operating with E-85 (ethanol) fuel.**

NOTE: If ANY of these apply to you then change your engine oil every 3,000 miles (5 000 km) or three months,

whichever comes first, and follow schedule “B—All Engines” of the “Maintenance Schedules” section of this manual.

If none of these apply to you, and your vehicle is equipped with a Non-Turbo Charged Engine then change your engine oil at every interval shown on schedule “A”—NON TURBO in the maintenance schedule section of this manual.

If none of these apply to you, and your vehicle is equipped with a Turbo Charged Engine change your engine oil at every interval shown on schedule “A”—TURBO in the maintenance schedule section of this manual.

NOTE: Under no circumstances should oil change intervals exceed 6000 miles (10 000 km) or 6 months whichever comes first.

Engine Oil Selection

For best performance and maximum protection under all types of operating conditions, the manufacturer only recommends engine oils that are API certified and meet the requirements of DaimlerChrysler Material Standard MS-6395.

American Petroleum Institute (API) Engine Oil Identification Symbol



This symbol means that the oil has been certified by the American Petroleum Institute (API). The manufacturer only recommends API Certified engine oils.

Engine Oil Viscosity (SAE Grade) — 2.4L and 2.4L Turbo Engines

SAE 5W-30 engine oil is recommended for all operating temperatures. This engine oil improves low temperature starting and vehicle fuel economy.

The engine oil filler cap also shows the recommended engine oil viscosity for your engine. For information on engine oil filler cap location, refer to the “Engine Compartment” illustration in this section.

Lubricants which do not have both, the engine oil certification mark and the correct SAE viscosity grade number should not be used.

Synthetic Engine Oils

You may use synthetic engine oils provided the recommended oil quality requirements are met, and the recommended maintenance intervals for oil and filter changes are followed.

Materials Added To Engine Oils

The manufacture strongly recommends against the addition of any additives (other than leak detection dyes) to the engine oil. Engine oil is an engineered product and it's performance may be impaired by supplemental additives.

Disposing of Used Engine Oil

Care should be taken in disposing of used engine oil from your vehicle. Used oil, indiscriminately discarded, can present a problem to the environment. Contact your dealer, service station, or governmental agency for advice on how and where used oil can be safely discarded in your area.

Engine Oil Filter

The engine oil filter should be replaced at every engine oil change.

Engine Oil Filter Selection

All of this manufacturer's engines have a full-flow type disposable oil filter. Use a filter of this type for replacement. The quality of replacement filters varies considerably. Only high quality filters should be used to assure most efficient service. Mopar Engine Oil Filters are high quality oil filters and are recommended.

DRIVE BELTS — CHECK CONDITION AND TENSION

At the mileage shown in the maintenance schedules, check all drive belts for condition and proper tension. Improper belt tension can cause belt slippage and failure.

Inspect the drive belts for evidence of cuts, cracks, or glazing and replace them if there is any sign of damage which could result in belt failure. If adjustment is required, see your authorized dealer for service.

Special tools are required to properly measure tension and to restore belt tension to factory specifications. Also, check belt routing to make sure there is no interference between the belts and other engine components.

SPARK PLUGS

Spark plugs must fire properly to assure engine performance and emission control. New plugs should be installed at the specified mileage. The entire set should be replaced if there is any malfunction due to a faulty spark plug. Refer to "Fluids, Lubricants, and Genuine Parts" in this section for the proper type of spark plug for use in your vehicle.

IGNITION WIRING SYSTEM

The ignition cables should be kept clean and properly connected. Terminals should be fully seated. Cracked, damaged, or faulty cables should be replaced.

CATALYTIC CONVERTER

The catalytic converter requires the use of unleaded fuel only. Leaded gasoline will destroy the effectiveness of the catalyst as an emission control device.

Under normal operating conditions, the catalytic converter will not require maintenance. However, it is important to keep the engine properly tuned to assure proper catalyst operation and prevent possible catalyst damage.

CAUTION!

Damage to the catalytic converter can result if your vehicle is not kept in proper operating condition. In the event of engine malfunction, particularly involving engine misfire or other apparent loss of performance, have your vehicle serviced promptly. Continued operation of your vehicle with a severe malfunction could cause the converter to overheat, resulting in possible damage to the converter and the vehicle.

NOTE: Intentional tampering with emissions control systems can result in civil penalties being assessed against you.

WARNING!

A hot exhaust system can start a fire if you park over materials that can burn. Such materials might be grass or leaves coming into contact with your exhaust system. Do not park or operate your vehicle in areas where your exhaust system can contact anything that can burn.

In unusual situations involving grossly malfunctioning engine operation, a scorching odor may suggest severe and abnormal catalyst overheating. If this occurs, stop the vehicle, turn off the engine and allow it to cool. Service, including a tune up to manufacturers specifications, should be obtained immediately.

To minimize the possibility of catalyst damage:

- Do not shut off the engine or interrupt the ignition when the transaxle is in gear and the vehicle is in motion.
- Do not try to start the engine by pushing or towing the vehicle.
- Do not idle the engine with any spark plug wires disconnected for prolonged period.

ENGINE TIMING BELT

Replace the engine timing belt at the intervals described in the appropriate maintenance schedule.

CRANKCASE EMISSION CONTROL SYSTEM

Proper operation of this system depends on freedom from sticking or plugging due to deposits. As vehicle mileage builds up, the PCV valve and passages may accumulate deposits. If a valve is not working properly, replace it with a new valve. **DO NOT ATTEMPT TO CLEAN THE OLD PCV VALVE!**

Check ventilation hose for indication of damage or plugging deposits. Replace if necessary.

FUEL FILTER

A plugged fuel filter can cause hard starting or limit the speed at which a vehicle can be driven. Should an excessive amount of dirt accumulate in the fuel tank, frequent filter replacement may be necessary. The fuel filters are located inside the fuel tank. See your dealer for service.

AIR CLEANER ELEMENT (AIR FILTER)

Under normal driving conditions, replace the filter at the intervals shown on Schedule "A". If, however, you drive the vehicle frequently under dusty or severe conditions, the filter element should be inspected periodically and replaced if necessary at the intervals shown on Schedule "B".

NOTE: For vehicles with a Turbo engine, a small amount of oil accumulation in the air cleaner box is normal. The amount will depend on driving style. The air cleaner box should be cleaned out and a new make-up-air filter element should be installed during the normal air filter maintenance procedure.

WARNING!

The air cleaner can provide a measure of protection in the case of engine backfire. Do not remove the air cleaner unless such removal is necessary for repair or maintenance. Make sure that no one is near the engine compartment before starting the vehicle with the air cleaner removed. Failure to do so can result in serious personal injury.

MAINTENANCE-FREE BATTERY

You will never have to add water, nor is periodic maintenance required.

CAUTION!

When servicing the battery, always reinstall the battery thermowrap. The thermowrap provides battery heat protection and will extend overall battery life. Failure to reinstall the thermowrap can result in evaporative loss of the battery fluid.

WARNING!

Battery fluid is a corrosive acid solution and can burn or even blind you. Don't allow battery fluid to contact your eyes, skin or clothing. Don't lean over a battery when attaching clamps. If acid splashes in eyes or on skin, flush the area immediately with large amounts of water.

Battery gas is flammable and explosive. Keep flame or sparks away from the battery. Don't use a booster battery or any other booster source with an output greater than 12 volts. Don't allow cable clamps to touch each other.

Battery posts, terminals and related accessories contain lead and lead compounds. Wash hands after handling.

CAUTION!

It is essential when replacing the cables on the battery that the positive cable is attached to the positive post and the negative cable is attached to the negative post. Battery posts are marked positive (+) and negative (-) and identified on the battery case. Cable clamps should be tight on the terminal posts and free of corrosion. Apply grease to posts and clamps after tightening.

If a “fast charger” is used while the battery is in the vehicle, disconnect both vehicle battery cables before connecting the charger to battery. Do not use a “fast charger” to provide starting voltage as battery damage can result.

AIR CONDITIONER MAINTENANCE

For best possible performance, your air conditioner should be checked and serviced by an Authorized Dealer at the start of each warm season. This service should include cleaning of the condenser fins and a performance test. Drive belt tension should also be checked at this time.

WARNING!

- Use only refrigerants and compressor lubricants approved by the manufacturer for your air conditioning system. Some unapproved refrigerants are flammable and can explode, injuring you. Other unapproved refrigerants or lubricants can cause the system to fail, requiring costly repairs. Refer to Section 3 of the Warranty Information book for further warranty information.
- The air conditioning system contains refrigerant under high pressure. To avoid risk of personal injury or damage to the system, adding refrigerant or any repair requiring lines to be disconnected should be done by an experienced repairman.

Refrigerant Recovery and Recycling

R-134a Air Conditioning Refrigerant is a hydrofluorocarbon (HFC) that is endorsed by the Environmental Protection Agency and is an ozone-saving product. However, the manufacturer recommends that air conditioning service be performed by dealers or other service facilities using recovery and recycling equipment.

NOTE: Use only manufacturer approved A/C System Sealers, Stop Leak Products, Seal Conditioners, Compressor Oil, or Refrigerants.

POWER STEERING – FLUID CHECK

Checking the power steering fluid level at a defined service interval is not required. The fluid should only be checked if a leak is suspected, abnormal noises are apparent, and/or the system is not functioning as anticipated. Coordinate inspection efforts through a certified DaimlerChrysler Dealership.

WARNING!

Fluid level should be checked on a level surface and with the engine off to prevent injury from moving parts and to insure accurate fluid level reading. Do not overfill. Use only manufacturers recommended power steering fluid.

If necessary, add fluid to restore to the proper indicated level. With a clean cloth, wipe any spilled fluid from all surfaces. Refer to Fluids, Lubricants, and Genuine Parts for correct fluid types.

FRONT SUSPENSION BALL JOINTS

There are two front suspension lower ball joints that are permanently lubricated. Inspect these ball joints whenever under vehicle service is done. Damaged seals and their corresponding potentially damaged ball joints must be replaced.

STEERING LINKAGE

The tie rod end ball joints should be inspected for external leakage and damage when other maintenance is performed.

BODY LUBRICATION

Locks and all body pivot points, including such items as seat tracks, doors, liftgate and hood hinges, should be lubricated periodically to assure quiet, easy operation and to protect against rust and wear. Prior to the application of any lubricant, the parts concerned should be wiped clean to remove dust and grit; after lubricating excess oil and grease should be removed. Particular attention should also be given to hood latching components to insure proper function. When performing other underhood services, the hood latch, release mechanism and safety catch should be cleaned and lubricated.

The external lock cylinders should be lubricated twice a year, preferably in the fall and spring. Apply a small

amount of a high quality lubricant such as Mopar® Lock Cylinder Lubricant directly into the lock cylinder.

WINDSHIELD WIPER BLADES

Clean the rubber edges of the wiper blades and the windshield periodically with a sponge or soft cloth and a mild non abrasive cleaner or use the washer solvent. This will remove accumulations of salt, waxes or road film and help reduce streaking and smearing.

Operation of the wipers on dry glass for long periods may cause deterioration of the wiper blades. Always use washer fluid when using the wipers to remove salt or dirt from a dry windshield. Avoid using the wiper blades to remove frost or ice from the windshield. make sure that they are not frozen to the glass before turning them on to avoid damaging the blade. Keep the blade rubber out of contact with petroleum products such as engine oil, gasoline, etc.

Windshield Wiper Blade Replacement

1. Lift the wiper arm away from the glass.
2. Push the release tab shown in the illustration and slide the wiper blade assembly down along the arm. Gently place the wiper arm on the windshield.
3. Install the new blade assembly onto the wiper arm tip until it locks in place.

NOTE: Always refer to the wiper blade packaging for specific installation instructions. Many wiper blade replacements fit multiple vehicles.

WINDSHIELD WASHER RESERVOIR

NOTE: Always refer to the wiper blade packaging for specific installation instructions. Many wiper blade replacements fit multiple vehicles.

The washer fluid reservoir is located in the rear of the engine compartment on the passenger side and should be

checked for fluid level at regular intervals. Fill the reservoir with windshield washer solvent (not radiator antifreeze) and operate the system for a few seconds to flush out the residual water.

WARNING!

Commercially available windshield washer solvents are flammable. They could ignite and burn you. Care must be exercised when filling or working around the washer solution.

EXHAUST SYSTEM

The best protection against carbon monoxide entry into the vehicle body is a properly maintained engine exhaust system.

If you notice a change in the sound of the exhaust system, or if exhaust fumes can be detected inside the vehicle, or

when the underside or rear of the vehicle is damaged; have a competent technician inspect the complete exhaust system and adjacent body areas for broken, damaged, deteriorated, or mispositioned parts. Open seams or loose connections could permit exhaust fumes to seep into the passenger compartment. In addition, inspect the exhaust system each time the vehicle is raised for an oil change or lubrication. Replace as required.

WARNING!

Exhaust gases can injure or kill. They contain carbon monoxide (CO) which is colorless and odorless. Breathing it can make you unconscious and can eventually poison you. To avoid breathing CO, refer to Exhaust Gas in the Safety Tips section of this manual.

COOLING SYSTEM

WARNING!

- **When working near the radiator cooling fan, disconnect the fan motor lead or turn the ignition switch to the OFF position. The fan is temperature controlled and can start at any time the ignition switch is in the ON position.**
- **You or others can be badly burned by hot coolant or steam from your radiator. If you see or hear steam coming from under the hood, don't open the hood until the radiator has had time to cool. Never try to open a cooling system pressure cap when the radiator is hot.**

Coolant Checks

Check engine coolant (antifreeze) protection every 12 months (before the onset of freezing weather, where applicable). If coolant is dirty or rusty in appearance, the system should be drained, flushed and refilled with fresh coolant. Check the front of the A/C condenser for any accumulation of bugs, leaves, etc. If dirty, clean by gently spraying water from a garden hose vertically down the face of the condenser.

Check the coolant recovery bottle tubing for brittle rubber, cracking, tears, cuts and tightness of the connection at the bottle and radiator. Inspect the entire system for leaks.

Cooling System — Drain, Flush and Refill

The system should be drained, flushed, and refilled at the intervals shown in the “Maintenance Schedules” in Section 8 of this manual.

If the solution is dirty or contains a considerable amount of sediment, clean and flush with a reliable cooling system cleaner. Follow with a thorough rinsing to remove all deposits and chemicals. Properly dispose of old antifreeze solution.

Selection Of Coolant

Use only the manufacturers recommended coolant, refer to Fluids, Lubricants and Genuine Parts for correct coolant type.

CAUTION!

Mixing of coolants other than specified HOAT engine coolants, may result in engine damage and may decrease corrosion protection. If a non-HOAT coolant is introduced into the cooling system in an emergency, it should be replaced with the specified coolant as soon as possible.

Do not use plain water alone or alcohol base engine coolant (antifreeze) products. Do not use additional rust inhibitors or antirust products, as they may not be compatible with the radiator engine coolant and may plug the radiator.

This vehicle has not been designed for use with Propylene Glycol based coolants. Use of Propylene Glycol based coolants is not recommended.

Adding Coolant

Your vehicle has been built with an improved engine coolant that allows extended maintenance intervals. This coolant can be used up to five Years or 100,000 miles before replacement. To prevent reducing this extended maintenance period, it is important that you use the same coolant throughout the life of your vehicle. Please review these recommendations for using Hybrid Organic Additive Technology (HOAT) coolant.

When adding coolant:

- The manufacturer recommends using Mopar® Antifreeze/Coolant five Year/100,000 Mile Formula HOAT (Hybrid Organic Additive Technology).
- Mix a minimum solution of 50% HOAT engine coolant and distilled water. Use higher concentrations (not to exceed 70%) if temperatures below -34°F (-37°C) are anticipated.

- Use only high purity water such as distilled or deionized water when mixing the water/engine coolant solution. The use of lower quality water will reduce the amount of corrosion protection in the engine cooling system.

Please note that it is the owner's responsibility to maintain the proper level of protection against freezing according to the temperatures occurring in the area where the vehicle is operated.

NOTE: Mixing coolant types will decrease the life of the engine coolant and will require more frequent coolant changes.

Cooling System Pressure Cap

The cap must be fully tightened to prevent loss of coolant, and to insure that coolant will return to the radiator from the coolant recovery bottle.

The cap should be inspected and cleaned if there is any accumulation of foreign material on the sealing surfaces.

WARNING!

- **The warning words “DO NOT OPEN HOT” on the cooling system pressure cap are a safety precaution. Never add coolant when the engine is overheated. Do not loosen or remove the cap to cool an overheated engine. Heat causes pressure to build up in the cooling system. To prevent scalding or injury, do not remove the pressure cap while the system is hot or under pressure.**
- **Do not use a pressure cap other than the one specified for your vehicle. Personal injury or engine damage may result.**

Disposal of Used Engine Coolant

Used ethylene glycol based engine coolant is a regulated substance requiring proper disposal. Check with your local authorities to determine the disposal rules for your community. To prevent ingestion by humans and animals do not store ethylene glycol based engine coolant in open containers or allow it to remain in puddles on the ground. If ethylene glycol engine coolant is ingested by anyone, contact a physician immediately. Clean up any ground spills immediately.

Coolant Level

The coolant bottle provides a quick visual method for determining that the coolant level is adequate. With the engine idling, and warm to normal operating temperature, the level of the coolant in the bottle should be between the ranges indicated on the bottle.

The radiator normally remains completely full, so there is no need to remove the radiator cap unless checking for coolant freeze point or replacing coolant. Advise your service attendant of this. As long as the engine operating temperature is satisfactory, the coolant bottle need only be checked once a month.

When additional coolant is needed to maintain the proper level, it should be added to the coolant bottle. Do not overfill.

Points To Remember

NOTE: When the vehicle is stopped after a few miles (a few kilometers) of operation, you may observe vapor coming from the front of the engine compartment. This is normally a result of moisture from rain, snow, or high humidity accumulating on the radiator and being vaporized when the thermostat opens, allowing hot coolant to enter the radiator.

If an examination of your engine compartment shows no evidence of radiator or hose leaks, the vehicle may be safely driven. The vapor will soon dissipate.

- Do not overfill the coolant recovery bottle.
- Check coolant freeze point in the radiator and in the coolant recovery bottle. If antifreeze needs to be added, contents of coolant recovery bottle must also be protected against freezing.
- If frequent coolant additions are required, or if the level in the coolant recovery bottle does not drop when the engine cools, the cooling system should be pressure tested for leaks.
- Maintain coolant concentration at 50% HOAT engine coolant (minimum) and distilled water for proper corrosion protection of your engine which contains aluminum components.

- Make sure that the radiator and coolant recovery bottle overflow hoses are not kinked or obstructed.
- Keep the front of the radiator clean. If your vehicle is equipped with air conditioning, keep the front of the condenser clean, also.
- Do not change the thermostat for summer or winter operation. If replacement is ever necessary, install **ONLY** the correct type thermostat. Other designs may result in unsatisfactory coolant performance, poor gas mileage, and increased emissions.

HOSES AND VACUUM/VAPOR HARNESSSES

Inspect surfaces of hoses and nylon tubing for evidence of heat and mechanical damage. Hard or soft spots, brittle rubber, cracking, tears, cuts, abrasions, and excessive swelling indicate deterioration of the rubber

Pay particular attention to the hoses nearest to high heat sources such as the exhaust manifold. Inspect hose routing to be sure hoses do not touch any heat source or moving component that may cause heat damage or mechanical wear.

Insure nylon tubing in these areas has not melted or collapsed

Inspect all hose connections such as clamps and couplings to make sure they are secure and no leaks are present.

Components should be replaced immediately if there is any evidence of degradation that could cause failure.

FUEL SYSTEM CONNECTIONS

Electronic Fuel Injection high pressure fuel systems are designed with tubes and special connects, connections and clamps which have unique material characteristics to provide adequate sealing and resist attack by deteriorated gasoline.

You are urged to use only the manufactures-specified tubes, connections and clamps, or their equivalent in material and specification, in any fuel system servicing.

BRAKE SYSTEM

In order to assure brake system performance, all brake system components should be inspected periodically. Suggested service intervals can be found in the "Maintenance Schedule" in this manual.

WARNING!

Riding the brakes can lead to brake failure and possibly an accident. Driving with your foot resting or riding on the brake pedal can result in abnormally high brake temperatures, excessive lining wear, and possible brake damage. You wouldn't have your full braking capacity in an emergency.

Brake, Power Steering and Oil Cooler System Hoses

When servicing the vehicle for scheduled maintenance, inspect the surface of the hoses and nylon tubing for evidence of heat and mechanical damage. Hard and

brittle rubber, cracking, tears, cuts, abrasions, and excessive swelling suggest deterioration of the rubber. Particular attention should be made to examining those hose surfaces nearest to high heat sources, such as the exhaust manifold.

Inspect all hose clamps and couplings to make sure they are secure and no leaks are present.

Insure nylon tubing in these areas has not melted or collapsed.

NOTE: Often, fluids such as oil, power steering fluid, and brake fluid are used during assembly plant operations to ease the assembly of hoses to couplings. Therefore, oil wetness at the hose-coupling area is not necessarily an indication of leakage. Actual dripping of hot fluid when systems are under pressure (during vehicle operation) should be noted before a hose is replaced based on leakage.

NOTE: Inspection of brake hoses should be done whenever the brake system is serviced and at every engine oil change. Inspect hydraulic brake hoses for surface cracking, scuffing, or worn spots. If there is any evidence of cracking, scuffing, or worn spots, the hose should be replaced immediately! Eventual deterioration of the hose can take place resulting in a possibility of a burst failure.

WARNING!

Worn brake hoses can burst and cause brake failure. You could have an accident. If you see any signs of cracking, scuffing, or worn spots, have the brake hoses replaced immediately.

Master Cylinder - Brake Fluid Level Check

Check the fluid level in the master cylinder immediately if the brake system warning light indicates system failure.

Check the fluid level in the master cylinder when performing underhood services.

Clean the top of the master cylinder area before removing the cap. If necessary, add fluid to bring the fluid level up to the requirements described on the brake fluid reservoir.

Overfilling of fluid is not recommended because it may cause leaking in the system.

Fluid level can be expected to fall as the brake pads wear. Brake fluid level should be checked when pads are replaced. However, low fluid level may be caused by a leak and a checkup may be needed.

Use only manufacturers recommended brake fluid. Refer to “Fluids, Lubricants, and Genuine Parts” for the correct fluid type.

NOTE: If your vehicle is equipped with a **Manual transaxle**, the Brake Fluid Reservoir supplies fluid to both the Brake System and the Clutch Release System. The two systems are separated in the reservoir and a leak in one system will not affect the other system. The **Manual Transaxle** Clutch Release System should not require fluid replacement during the life of the vehicle. If the Brake Fluid Reservoir is low, and the brake system does not indicate any leaks or other problems, it may be a result of a leak in the Hydraulic Clutch Release System. See your local authorized dealer for service.

Use only manufacturers recommended brake fluid, refer to Fluids, Lubricants and Genuine Parts for correct fluid type.

WARNING!

Use of a brake fluid that has a lower initial boiling point than the recommended MOPAR® DOT 3 product or a brake fluid that is unidentified as to FMVSS specification may result in sudden brake failure during hard prolonged braking. You could have an accident.

CAUTION!

Use of improper brake fluids will affect overall clutch system performance. Improper brake fluids may damage the clutch system resulting in loss of clutch function and the ability to shift the transaxle.

WARNING!

Overfilling the brake fluid reservoir can result in spilling brake fluid on hot engine parts and the brake fluid catching fire.

Use only brake fluid that has been in a tightly closed container to avoid contamination from foreign matter.

CAUTION!

Do not allow petroleum base fluid to contaminate the brake fluid, all brake seal components could be damaged causing partial or complete brake failure.

AUTOMATIC TRANSAXLE

The automatic transaxle and differential assembly are contained within a single housing.

The fluid level in the automatic transaxle should be checked whenever the vehicle is serviced. Operation with an improper fluid level will greatly reduce the life of the transaxle and the fluid.

FLUID LEVEL CHECK — FOUR-CYLINDER ENGINES

Use the following procedure to check the automatic transaxle fluid level properly:

1. Park the vehicle on level ground.
2. Run the engine at curb idle speed for a minimum of 60 seconds.
3. Apply the parking brake fully.

4. Place the gear selector momentarily in each gear position ending with the lever in “P” (Park).

5. Wipe the area around the dipstick clean to eliminate the possibility of dirt entering the transaxle.

6. Remove the dipstick and determine if the fluid is hot or cold. Hot fluid is approximately 180° F (82° C), which is the normal operating temperature after the vehicle is driven at least 15 miles (24 km). Hot fluid cannot be held comfortably between the fingertips. Cold fluid is at a temperature below 80°F (27°C).

7. Wipe the dipstick clean and reinsert until seated. Then, remove dipstick and note the reading.

a. If the fluid is hot, the reading should be in the crosshatched area marked “HOT” (between the upper two holes in the dipstick).

b. If the fluid is cold, the fluid level should be between the lower two holes in the area marked “COLD.”

If the fluid level is low, add sufficient fluid through the filler (dipstick) tube to bring it to the proper level. Do not overfill.

CAUTION!

- Using a transmission fluid other than the manufacturer's recommended fluid may cause deterioration in transmission shift quality and/or torque converter shudder. Using a transmission fluid other than that recommended by the manufacturer will result in more frequent fluid and filter changes. Refer to "Fluids, Lubricants, and Genuine Parts" for the correct fluid type.
- Dirt and water in the transaxle can cause serious damage. To prevent dirt and water from entering the transaxle after checking or replenishing fluid, make certain that the dipstick cap is re-seated properly.

Fluid And Filter Changes

Automatic transmission fluid and filter should be changed as follows:

Maintenance schedule "A"—Non Turbo Charged Engines – No change necessary.

Maintenance schedule "A"—Turbo Charged Engines – No change necessary.

Maintenance schedule "B"—All Engines – Every 60,000 miles (100 000 km) change fluid and filter under the following conditions:

- Police, taxi, limousine, commercial type operation, or trailer towing where the vehicle is driven **regularly** for more than 45 minutes of continuous operation.

NOTE: Refer to Section 8 of this manual for maintenance schedules.

If the transaxle is disassembled for any reason, the fluid and filter should be changed.

Special Additives

Automatic Transmission Fluid (ATF) is an engineered product and its performance may be impaired by supplemental additives. Therefore, do not add any fluid additives to the transaxle. The only exception to this policy is the use of special dyes to aid in detecting fluid leaks. In addition, avoid using transmission sealers as they may adversely affect seals.

MANUAL TRANSAXLE

Lubricant Selection

Use only manufacturers recommended transmission fluid. **Refer to Fluids, Lubricants and Genuine Parts for the correct fluid type.**

Fluid Level Check

Check the fluid level by removing the fill plug. The fluid level should be between the bottom of the fill hole and a point not more than 3/16" (4.7 mm) below the bottom of the hole.

Add fluid, if necessary, to maintain the proper level.

Frequency Of Fluid Change

Under normal operating conditions, the fluid installed at the factory will give satisfactory lubrication for the life of the vehicle. Fluid changes are not necessary unless the following conditions exist:

- The lubricant has become contaminated with water. If contaminated with water, the fluid should be changed immediately.
- If severe usage has occurred, refer to Maintenance Schedule "B" in Section 8 of this manual.

APPEARANCE CARE AND PROTECTION FROM CORROSION

Protection Of Body And Paint from Corrosion

Vehicle body care requirements vary according to geographic locations and usage. Chemicals that make roads passable in snow and ice, and those that are sprayed on trees and road surfaces during other seasons, are highly corrosive to the metal in your vehicle. Outside parking, which exposes your vehicle to airborne contaminants, road surfaces on which the vehicle is operated, extreme hot or cold weather and other extreme conditions will have an adverse effect on paint, metal trim, and underbody protection.

The following maintenance recommendations will enable you to obtain maximum benefit from the corrosion resistance built into your vehicle.

What Causes Corrosion?

Corrosion is the result of deterioration or removal of paint and protective coatings from your vehicle.

The most common causes are:

- Road salt, dirt and moisture accumulation.
- Stone and gravel impact.
- Insects, tree sap and tar.
- Salt in the air near sea coast localities.
- Atmospheric fallout/industrial pollutants.

Washing

- Wash your vehicle regularly. Always wash your vehicle in the shade using Mopar® Car Wash or a mild car wash soap, and rinse the panels completely with clear water.

- If insects, tar, or other similar deposits have accumulated on your vehicle, use Mopar® Super Kleen Bug and Tar Remover to remove.
- Use Mopar® Cleaner Wax to remove road film, stains and to protect your paint finish. Take care never to scratch the paint.
- Avoid using abrasive compounds and power buffing that may diminish the gloss or thin out the paint finish.

CAUTION!

Do not use abrasive or strong cleaning materials such as steel wool or scouring powder, which will scratch metal and painted surfaces.

Special Care

- If you drive on salted or dusty roads or if you drive near the ocean, hose off the undercarriage at least once a month.
- It is important that the drain holes in the lower edges of the doors, rocker panels and trunk be kept clear and open.
- If you detect any stone chips or scratches in the paint, touch them up immediately. The cost of such repairs is considered the responsibility of the owner.
- If your vehicle is damaged due to an accident or similar cause which destroys the paint and protective coating, have your vehicle repaired as soon as possible. The cost of such repairs is considered the responsibility of the owner.

- If you carry special cargo such as chemicals, fertilizers, de-icer salt, etc., be sure that such materials are well packaged and sealed.
- If a lot of driving is done on gravel roads, consider mud or stone shields behind each wheel.
- Use Mopar touch up paint on scratches as soon as possible. Your dealer has touch up paint to match the color of your vehicle.

Wheel and Wheel Trim Care

All wheels and wheel trim, especially aluminum and chrome plated wheels should be cleaned regularly with a mild soap and water to prevent corrosion. To remove heavy soil and/or excessive brake dust, use Mopar® Wheel Cleaner (05066247AB) or equivalent or select a nonabrasive, non-acidic cleaner. Do not use scouring pads, steel wool, a bristle brush, or metal polishes. Only Mopar® or equivalent is recommended. Do not use oven

cleaner. Avoid automatic car washes that use acidic solutions or harsh brushes that may damage the wheels' protective finish.

Interior Care

Instrument Panel Cover

The instrument panel cover has a low glare surface, which minimizes reflections in the windshield. Do not use protectants or other products, which may cause undesirable reflections. Use soap and warm water to restore the low glare surface.

Cleaning Interior Trim

Interior Trim should be cleaned starting with a damp cloth, a damp cloth with Mopar® Total Clean, then Mopar® Spot & Stain Remover if absolutely necessary. Do not use harsh cleaners or Armorall. Use Mopar® Total Clean to clean vinyl upholstery

Cleaning Leather Upholstery

Mopar® Total Clean is specifically recommended for leather upholstery.

Your leather upholstery can be best preserved by regular cleaning with a damp soft cloth. Small particles of dirt can act as an abrasive and damage the leather upholstery and should be removed promptly with a damp cloth. Stubborn soils can be removed easily with a soft cloth and Mopar® Total Clean. Care should be taken to avoid soaking your leather upholstery with any liquid. Please do not use polishes, oils, cleaning fluids, solvents, detergents, or ammonia-based cleaners to clean your leather upholstery. Application of a leather conditioner is not required to maintain the original condition.

WARNING!

Do not use volatile solvents for cleaning purposes. Many are potentially flammable, and if used in closed areas they may cause respiratory harm.

YES Essentials® Fabric Cleaning Procedure – If Equipped

YES Essentials® seats may be cleaned in the following manner:

- Remove as much of the stain as possible by blotting with a clean, dry towel.
- Blot any remaining stain with a clean, damp towel.
- For tough stains, apply Mopar® Total Clean or a mild soap solution to a clean, damp cloth and remove stain. Use a fresh, damp towel to remove soap residue.

- For grease stains, apply Mopar® Multi-Purpose Cleaner to a clean, damp cloth and remove stain. Use a fresh, damp towel to remove soap residue.
- Do not use any solvents or protectants on Yes Essentials® products.

Cleaning Headlights

Your vehicle has plastic headlights that are lighter and less susceptible to stone breakage than glass headlights.

Plastic is not as scratch resistant as glass and therefore different lens cleaning procedures must be followed.

To minimize the possibility of scratching the lenses and reducing light output, avoid wiping with a dry cloth. To remove road dirt, wash with a mild soap solution followed by rinsing.

Do not use abrasive cleaning components, solvents, steel wool or other aggressive material to clean the lenses.

Glass Surfaces

All glass surfaces should be cleaned on a regular basis with Mopar Glass Cleaner or any commercial household-type glass cleaner. Never use an abrasive type cleaner. Use caution when cleaning the inside rear window equipped with electric defrosters or the right rear quarter window equipped with the radio antenna. Do not use scrapers or other sharp instruments which may scratch the elements. When cleaning the rear view mirror, spray cleaner on the towel or rag that you are using. Do not spray cleaner directly on the mirror.

Instrument Panel Cover

The instrument panel cover has a low glare surface which minimizes reflections in the windshield. Do not use protectants or other products which may cause undesirable reflections. Use soap and warm water to restore the low glare surface.

Cleaning Plastic Instrument Cluster Lenses

The lenses in front of the instruments in this vehicle are molded in clear plastic. When cleaning the lenses, care must be taken to avoid scratching the plastic.

1. Clean with a wet soft rag. A mild soap solution may be used, but do not use high alcohol content or abrasive cleaners. If soap is used, wipe clean with a clean damp rag.
2. Dry with a soft tissue.

Seat Belt Maintenance

Do not bleach, dye or clean the belts with chemical solvents or abrasive cleaners. This will weaken the fabric. Sun damage can also weaken the fabric.

If the belts need cleaning, use a mild soap solution or lukewarm water. Do not remove the belts from the car to wash them.

Replace the belts if they appear frayed or worn or if the buckles do not work properly.

Dry with a soft tissue.

CONVERTIBLE TOP CARE

Immediate removal of any contaminant is recommended. Regular washing of the top will enhance its life and appearance, and make successive cleanings easier. Do not subject the top to excessive heat. Frequently vacuum the top and storage compartment.

Washing

Hand washing is highly recommended. Automatic car washing equipment can damage the top material. If you must use an automatic car wash, soft cloth systems are preferred.

CAUTION!

Avoid high pressure car washes, as they can damage the top material. Also, increased water pressure may force water past the weather strips.

CAUTION!

Never use an abrasive type cleaner or bleaches. Cleaners should not contain silicones, organic solvents, petroleum distillates or plasticizers. always wait until the top is thoroughly dry before lowering it into the storage area.

General Cleaning

Careful vacuuming of the top before washing is helpful in removing dust and other foreign particles. Wash in partial shade instead of direct sun. Wet the entire vehicle before washing the top. The top should be washed with a soft, natural bristle scrub brush, and Mopar Car Wash or a mild soap solution. Do not use detergent.

Scrub in all directions, covering an area of about two square feet at a time. Avoid heavy scrubbing. Rinse the entire vehicle with water to remove all soap and dirt from the top fabric and to prevent streaking on painted and chrome surfaces. Allow the top to dry before lowering. Vacuuming the top with a wet/dry shop vacuum will decrease the top's drying time, ensure removal of all dirt, and delete streaks in the material. Multiple cleanings may be necessary to remove stubborn stains. If stains persist, contact your local dealership for further suggestions.

Cloth Top Additional Cleaning Procedure

For additional cleaning assistance in removing stubborn stains, apply Mopar Convertible Cloth Top Cleaner (part number 05012245AA) to the complete stain, extending 2 inches (50 mm) beyond the stain. With a soft bristle brush, scrub in all directions over the stain. Avoid heavy scrubbing. Rinse the area with warm water. If the stain is still apparent, repeat the cleaning procedure. When the stain is no longer showing, rinse the complete top with warm water. Let the top dry before lowering it. 7

Cloth Top Protection

For appearance purposes, you may wish to protect your Twillfast™ (cloth) top periodically. Use Mopar Convertible Cloth Top Treatment or a fabric protectant such as Scotchguard_ is suggested. The top should be clean and dry before application of the protectant.

CAUTION!

Avoid getting Scotchguard_ on the surrounding weather strips, moldings, paint, or glass. Damage to these items might occur.

Weather Strip Care

Lubricate all top and door glass weather strips periodically with Mopar Weather Strip Lubricant (part number 4773427), to keep them soft and pliable.

INTEGRATED POWER MODULE (IPM)

An Integrated Power Module is located in the engine compartment near the air cleaner assembly. This center contains cartridge fuses and mini fuses. A description of each fuse and component may be stamped on the inside of the cover.

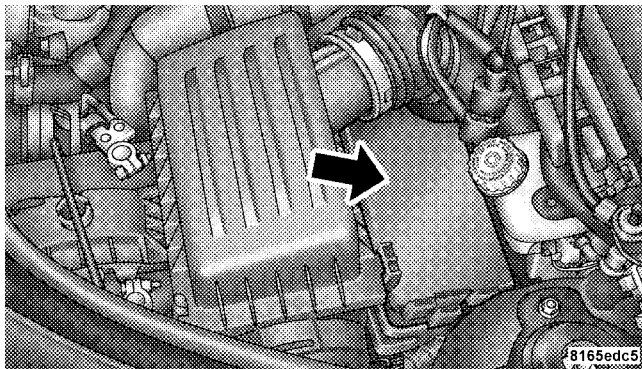

Integrated Power Module Location

INTEGRATED POWER MODULE (IPM)			
Cavity	Cartridge Fuse	Mini Fuse	Description
1	40 Amp Green		Power Top Feed — Convertible Only
2		20 Amp Yellow	AWD ECU Feed
3		10 Amp Red	CHMSL Brake Switch Feed
4		10 Amp Red	Ignition Switch Feed
5		20 Amp Yellow	Trailer Tow

INTEGRATED POWER MODULE (IPM)			
Cavity	Cartridge Fuse	Mini Fuse	Description
6		10 Amp Red	IOD Sw/ Pwr Mir/ Ocm Steering Cntrl Sdar/Hfm
7		30 Amp Green	IOD Sense1
8		30 Amp Green	IOD Sense2
9	40 Amp Green		Power Seats
10		20 Amp Yellow	CCN, Power Locks
11		15 Amp Lt Blue	Power Outlet

INTEGRATED POWER MODULE (IPM)			
Cavity	Cartridge Fuse	Mini Fuse	Description
12		20 Amp Yellow	Ign Run/ Acc Inverter
13		20 Amp Yellow	Pwr run/ Acc Outlet RR
14		10 Amp Red	IOD CCN/ Interior Lighting
15	50 Amp Red		RAD Fan Relay Battery Feed
16		15 Amp Lt. Blue	IGN Run/ Acc Cigar Ltr/Sunroof

INTEGRATED POWER MODULE (IPM)			
Cavity	Cartridge Fuse	Mini Fuse	Description
17		10 Amp Red	IOD Feed CVT Mod/ Mod_Wcm
18	40 Amp Green		ASD Relay Contact PWR Feed
19		20 Amp Yellow	PWR Amp 1 & Amp 2 Feed
20		15 Amp Lt. Blue	IOD Feed Radio
21		10 Amp Red	IOD Feed Intrus Mod/Siren

INTEGRATED POWER MODULE (IPM)			
Cavity	Cartridge Fuse	Mini Fuse	Description
22		10 Amp Red	IGN RUN Hvac/ Compass Sensor
23		15 Amp Lt. Blue	ENG ASD Relay Feed 3
24		25 Amp Natural	PWR Sun- roof Feed
25		10 Amp Red	Heated Mir- ror
26		15 Amp Lt. Blue	ENG ASD Relay Feed 2

INTEGRATED POWER MODULE (IPM)			
Cavity	Cartridge Fuse	Mini Fuse	Description
27		10 Amp Red	IGN RUN Only ORC Feed
28		10 Amp Red	IGN RUN ORC/OCM Feed
29			EMPTY
30		20 Amp Yellow	Heated Seats
31		10 Amp Red	Headlamp Washer Relay Control
32	30 Amp Pink		ENG ASD Control Feed 1

INTEGRATED POWER MODULE (IPM)			
Cavity	Cartridge Fuse	Mini Fuse	Description
33		10 Amp Red	ABS MOD/J1962 Conn/PCM
34	30 Amp Pink		ABS Valve Feed
35	40 Amp Green		ABS Pump Feed
36	30 Amp Pink		Headlamp Washer Control
37		25 Amp Natural	Spare

CAUTION!

- **When installing the Integrated Power Module cover, it is important to ensure the cover is properly positioned and fully latched. Failure to do so may allow water to get into the Integrated Power Module, and possibly result in a electrical system failure.**
- **When replacing a blown fuse, it is important to use only a fuse having the correct amperage rating. The use of a fuse with a rating other than indicated may result in a dangerous electrical system overload. If a properly rated fuse continues to blow, it indicates a problem in the circuit that must be corrected.**

VEHICLE STORAGE

If you will not be using your vehicle for more than 21 days, you may want to take steps to preserve your battery. You may:

- Disengage the mini-fuse in the Power Distribution Center labeled IOD (Ignition Off-Draw).
- Or, disconnect the negative cable from the battery.

REPLACEMENT BULBS

LIGHT BULBS — Inside	Bulb No.
Center Console Floor Lamp	T37
Climate Controls	6233137
Console Gear Selector	PC194
Dome Light (sedan)	T579
Dome Light / Sport Bar Lights (convertible)	T904
Instrument Cluster Illumination	74
Overhead Reading Light (Overhead Console)	T1037
Overhead Reading Light (Rearview Mirror)	T192
Rear Cargo	T906
Visor Vanity	6501966

All the inside bulbs are brass or glass wedge base. Aluminum base bulbs are not approved and should not be used for replacement.

LIGHTS BULBS — Outside	Bulb No.
Low Beam Headlight	9006XS
High Beam Headlight	9005XS
Front Park/Turn Signal/Side Marker Light	4157NAKX
Front Fog Light	9145
Center High Mounted Stop Light (CHMSL) (Sedan)	921-W16W
Center High Mounted Stop Light (CHMSL) (Convertible)	LED
Rear Tail/Stop	3157
Rear Turn Signal	3757A
Backup Light	3157-P27/7W
License Light	168

BULB REPLACEMENT

Headlights

CAUTION!

Do not touch the new headlight bulb with your fingers. Oil contamination will severely shorten bulb life.

1. Remove the headlight access cover splash shield, located in the front wheel well opening.
2. Disconnect the electrical connector.

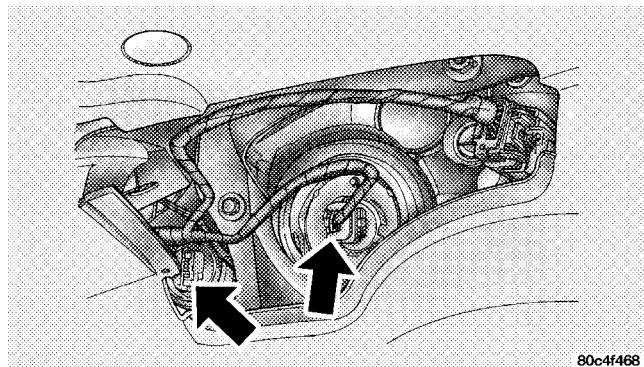

3. Rotate the socket to the left one quarter turn and replace the bulb.

Front Park/Turn Signal/Side Marker Lights

1. Remove the headlight access cover splash shield, located in the front wheel well opening.
2. Rotate the socket to the left one quarter turn to replace and replace the bulb.

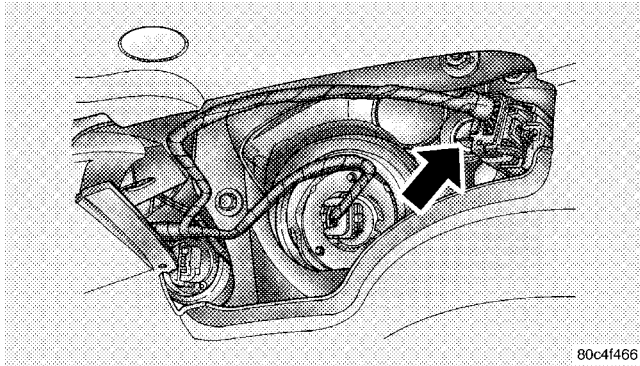

Front Fog Lights — If Equipped

1. Remove the fasteners attaching the lower splash shield to gain access to the fog light.
2. Twist and remove the bulb from the fog light housing.
3. Disconnect the electrical connector and replace bulb.

Tail/Stop, and Rear Turn Signal Lights

1. Remove the screw attaching the tail light housing and remove the housing from the vehicle.
2. Twist the bulb socket 1/4 turn to remove it from the housing.

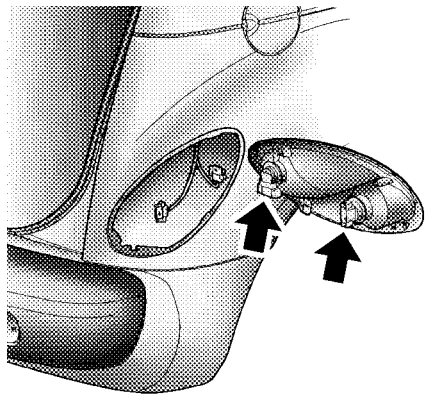

80c4f469

3. Pull the bulb out of the socket and replace.

Back Up Lights

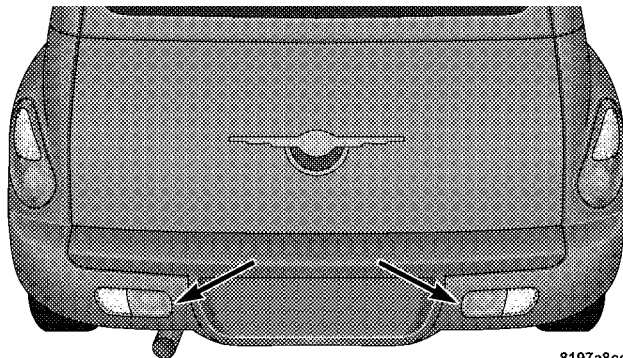

8197a8cc

Removing Backup Light Bulbs

1. To remove the backup lamp, you must take a fiber stick and slide it along the inboard side of the lamp and compress a spring clip to allow it to partially "pop" out to the secondary catch.
2. Fully compress the clip to get the lamp to come out completely.
3. Remove the socket from the housing.
4. Pull the bulb out of the socket and replace.

Center High Mounted Stop Light

1. Open the liftgate and remove the liftgate CHMSL cover.
2. Remove CHMSL lens from the housing by unlatching the two side latches.
3. Pull the bulb out of the socket and replace.

FLUIDS AND CAPACITIES

FLUIDS AND CAPACITIES		
	U.S.	Metric
Fuel (Approximate)	15 Gallons	56.7 Liters
Engine Oil-With Filter		
2.4 Liter Engines (Use API Certified SAE 5W-30 Engine Oil.)	5.0 qts	4.7 Liters
Cooling System *		
2.4 Liter Engines (Mopar® Antifreeze/Coolant 5 Year/100,000 Miles Formula), or equivalent.	6.5 qts	6.2 Liters
* Includes heater and coolant recovery bottle filled to MAX level.		

FLUIDS, LUBRICANTS AND GENUINE PARTS

ENGINE

FLUIDS, LUBRICANTS AND GENUINE PARTS	
Component	Fluids, Lubricants and Genuine Parts
Engine Coolant	Mopar® Antifreeze/Coolant 5 Year/100,000 Mile Formula HOAT (Hybrid Organic Additive Technology) or equivalent.
Engine Oil (2.4L Standard, 2.4L Standard Turbo)	Use API Certified SAE 5W-30 Engine Oil. Refer to your engine oil filler cap for correct SAE grade meeting DaimlerChrysler Material Standard MS-6395.
Engine Oil Filter	Non Turbo—Mopar® 4105409AB or equiv. Turbo—Mopar® 4781452BB or equiv.
Spark Plugs	2.4L Non Turbo — Champion® RE16MC, 040" Gap 2.4L Turbo — Champion® RE14MCC5,.050" Gap.
Fuel Selection	87 Octane for 2.4L Standard Turbo and 2.4L Standard Non Turbo Engines.

CHASSIS

FLUIDS, LUBRICANTS AND GENUINE PARTS	
Component	Fluids, Lubricants and Genuine Parts.
Automatic Transmission Fluid	Mopar® ATF+4 Automatic Transmission Fluid.
Manual Transmission Fluid	Mopar® ATF+4 Automatic Transmission Fluid MS9602.
Brake Master Cylinder	Mopar® DOT 3, SAE J1703 should be used. If DOT 3, SAE J1703 brake fluid is not available, then DOT 4 is acceptable. Use only recommended brake fluids or equivalent.
Power Steering Reservoir	Mopar® Power Steering Fluid +4 or Mopar® ATF+4 Automatic Transmission Fluid.

MAINTENANCE SCHEDULES

CONTENTS

<ul style="list-style-type: none"> ■ Emissions Control System Maintenance 434 ■ Maintenance Schedule 434 <ul style="list-style-type: none"> □ Schedule “B”—All Engines 437 	<ul style="list-style-type: none"> □ Schedule “A”—Non Turbo 448 □ Schedule “A”—Turbo 453
--	--

EMISSIONS CONTROL SYSTEM MAINTENANCE

The Scheduled Maintenance services listed in **bold type** must be done at the times or mileages specified to ensure the continued proper functioning of the emission control system. These, and all other maintenance services included in this manual, should be done to provide best vehicle performance and reliability. More frequent maintenance may be needed for vehicles in severe operating conditions, such as dusty areas and very short trip driving.

Inspection and service should also be done any time a malfunction is suspected.

NOTE: Maintenance, replacement, or repair of the emissions control devices and systems on your vehicle may be performed by any automotive repair establishment or individual using any automotive part that has been certified pursuant to U.S. EPA or, in the State of California, California Air Resources Board regulations.

MAINTENANCE SCHEDULE

There are three maintenance schedules that show **required** service for your vehicle.

First is Schedule “**B**”—**ALL ENGINES**. It is for vehicles that are operated under the conditions that are listed below and at the beginning of the schedule.

- Day and night temperatures are below 32° F (0° C).
- Stop and go driving.
- Extensive engine idling.
- Driving in dusty conditions.
- Short trips of less than 10 miles (16 km).
- More than 50% of your driving is at sustained high speeds during hot weather, above 90° F (32° C).
- Trailer towing.† ◇

- Taxi, police, or delivery service (commercial service). † ◇
- Off-road or desert operation.
- **If equipped for and operating with E-85 (ethanol) fuel.**

NOTE: If ANY of these apply to you then change your engine oil every 3,000 miles (5 000 km) or 3 months, whichever comes first, and follow schedule “B—All Engines” of the “Maintenance Schedules” section of this manual.

NOTE: IF ANY of these apply to you then flush and replace the engine coolant every 102,000 miles (170 000 km) or 60 months, whichever comes first, and follow schedule “B—All Engines” of the “Maintenance Schedules” section of this manual.

NOTE: Most vehicles are operated under the conditions listed for Schedule “B”—ALL ENGINES.

Second is Schedule “A”—**NON TURBO**. It is for vehicles that are not operated under any of the conditions listed under Schedule “B”—ALL ENGINES.

Third is Schedule “A”—**TURBO**. It is for vehicles that are not operated under any of the conditions listed under Schedule “B”—ALL ENGINES.

Use the schedule that best describes your driving conditions. Where time and mileage are listed, follow the interval that occurs first.

CAUTION!

Failure to perform the required maintenance items may result in damage to the vehicle.

At Each Stop for Fuel

- Check the engine oil level about 5 minutes after a fully warmed engine is shut off. Checking the oil level while the vehicle is on level ground will improve the accuracy of the oil level reading. Add oil only when the level is at or below the ADD or MIN mark.
- Check the windshield washer solvent and add if required.

Once a Month

- Check tire pressure and look for unusual wear or damage.
- Inspect the battery and clean and tighten the terminals as required.
- Check the fluid levels of coolant reservoir, brake master cylinder and transaxle and add as needed.

- Check all lights and all other electrical items for correct operation.
- Check rubber seals on each side of the radiator for proper fit.

At Each Oil Change

- Change the engine oil filter.
- Inspect the exhaust system.
- Inspect the brake hoses.
- Inspect the CV joints and front suspension components.
- Check the automatic transaxle fluid level.
- Check the manual transaxle fluid level and fill plug condition.
- Check the coolant level, hoses, and clamps.

SCHEDULE "B"—ALL ENGINES

Follow schedule "B"—All Engines if you usually operate your vehicle under one or more of the following conditions.

Change the automatic transmission fluid and filter every 60,000 miles (100 000 km) if the vehicle is usually operated under one or more of the conditions marked with an \diamond .

Change the manual transaxle fluid every 48,000 miles (80 000 km) if the vehicle is usually operated under one or more of the conditions marked with an \dagger .

- Day and night temperatures are below 32° F (0° C).
- Stop and go driving.
- Extensive engine idling.
- Driving in dusty conditions.

- Short trips of less than 10 miles (16.2 km).
- More than 50% of your driving is at sustained high speeds during hot weather, above 90° F (32° C).
- Trailer towing. $\dagger \diamond$
- Taxi, police, or delivery service (commercial service). $\dagger \diamond$
- Off-road or desert operation.
- **If equipped for and operating with E-85 (ethanol) fuel.**

NOTE: If ANY of these apply to you then change your engine oil every 3,000 miles (5 000 km) or 3 months, whichever comes first, and follow schedule "B—All Engines" of the "Maintenance Schedules" section of this manual.

438 SCHEDULE "B"—ALL ENGINES

NOTE: IF ANY of these apply to you then flush and replace the engine coolant every 102,000 miles (170 000 km) or 60 months, whichever comes first, and follow schedule "B—All Engines" of the "Maintenance Schedules" section of this manual.

If none of these apply to you, and your vehicle is equipped with a Non-Turbo Charged Engine then change your engine oil at every interval shown on

schedule "A"—NON TURBO in the maintenance schedule section of this manual.

If none of these apply to you, and your vehicle is equipped with a Turbo Charged Engine change your engine oil at every interval shown on schedule "A"—TURBO in the maintenance schedule section of this manual.

Miles (Kilometers)	3,000 (5 000)	6,000 (10 000)	9,000 (15 000)	12,000 (20 000)	15,000 (25 000)	18,000 (30 000)
Change engine oil and engine oil filter, if not replaced at 3 months.	X	X	X	X	X	X
Rotate tires.		X		X		X
Inspect the brake linings.				X		
Inspect the engine air cleaner filter , replace as necessary.*					X	
Inspect the Make-up air filter , replace as necessary.					X	

440 SCHEDULE "B"—ALL ENGINES

Miles (Kilometers)	21,000 (35 000)	24,000 (40 000)	27,000 (45 000)	30,000 (50 000)	33,000 (55 000)	36,000 (60 000)
Change engine oil and engine oil filter, if not replaced at 3 months.	X	X	X	X	X	X
Rotate tires.		X		X		X
Inspect the brake linings.		X				X
Replace the engine air cleaner filter .				X		
Replace the spark plugs .				X		
Inspect the tie rod ends and boot seals.				X		
Inspect the PCV valve and replace as necessary.*				X		
Replace the Make-up air filter .				X		
Adjust the generator drive belt tension.				X		

Miles (Kilometers)	39,000 (65 000)	42,000 (70 000)	45,000 (75 000)	48,000 (80 000)	51,000 (85 000)	54,000 (90 000)
Change engine oil and engine oil filter, if not replaced at 3 months.	X	X	X	X	X	X
Rotate tires.		X		X		X
Inspect the brake linings.				X		
Change the brake fluid. If vehicle is used for trailer towing.				X		
Inspect the engine air cleaner filter , replace as necessary.*			X			
Change the manual transaxle fluid.†				X		
Inspect the Make-up air filter . Replace as necessary.			X			

442 SCHEDULE "B"—ALL ENGINES

Miles (Kilometers)	57,000 (95 000)	60,000 (100 000)	63,000 (105 000)	66,000 (110 000)	69,000 (115 000)	72,000 (120 000)
Change engine oil and engine oil filter, if not replaced at 3 months.	X	X	X	X	X	X
Rotate tires.		X		X		X
Inspect the brake linings.		X				X
Replace the engine air cleaner filter .		X				
Replace the spark plugs and ignition cables .		X				
Inspect the tie rod ends and boot seals.		X				
Inspect the PCV valve and replace if necessary. Not required if previously changed. * ‡		X				
Replace the Make-up air filter .		X				
Adjust the generator drive belt tension.		X				
Change the automatic transaxle fluid and filter. ◇		X				
Flush and replace engine coolant at 60 months, if not done at 102,000 miles.		X				

Miles (Kilometers)	75,000 (125 000)	78,000 (130 000)	81,000 (135 000)	84,000 (140 000)	87,000 (145 000)	90,000 (150 000)
Change engine oil and engine oil filter, if not replaced at 3 months.	X	X	X	X	X	X
Rotate tires.		X		X		X
Inspect the brake linings.				X		
Inspect the engine air cleaner filter and replace as necessary.*	X					
Replace the engine air cleaner filter .						X
Replace the spark plugs .						X
Inspect the tie rod ends and boot seals.						X
Inspect the PCV valve and replace if necessary. Not required if previously changed. * ‡						X
Inspect the Make-up air filter , replace as necessary.	X					
Adjust the generator drive belt tension.						X
Replace the Make-up air filter .						X

444 SCHEDULE "B"—ALL ENGINES

Miles (Kilometers)	93,000 (155 000)	96,000 (160 000)	99,000 (165 000)	102,000 (170 000)	105,000 (175 000)
Change engine oil and engine oil filter, if not replaced at 3 months.	X	X	X	X	X
Rotate tires.		X		X	
Inspect the brake linings.		X			
Change the brake fluid. If vehicle is used for trailer towing.		X			
Inspect the engine air cleaner filter and replace as necessary.*					X
Change the manual transaxle fluid.†		X			
Replace the engine timing belt . *				X	
Flush and replace the engine coolant, if not replaced at 60 months.				X	
Inspect the Make-up air filter , replace as necessary.					X

Miles (Kilometers)	108,000 (180 000)	111,000 (185 000)	114,000 (190 000)	117,000 (195 000)	120,000 (200 000)
Change engine oil and engine oil filter, if not replaced at 3 months.	X	X	X	X	X
Rotate tires.	X		X		X
Inspect the brake linings.			X		
Replace the engine air cleaner filter. *					X
Inspect the tie rod ends and boot seals.					X
Replace the Make-up air filter.					X
Adjust the generator drive belt tension.					X
Change automatic transaxle fluid and filter. ◇					X
Inspect the PCV valve and replace if necessary. *‡					X
Flush and replace the engine coolant at 120 months, if not replaced at 102,000 miles.					X
Replace the spark plugs and ignition cables.					X

446 SCHEDULE "B"—ALL ENGINES

Miles (Kilometers)	123,000 (205 000)	126,000 (210 000)	129,000 (215 000)	132,000 (220 000)	135,000 (225 000)
Change engine oil and engine oil filter, if not replaced at 3 months.	X	X	X	X	X
Rotate tires.	X		X		X
Inspect the brake linings.			X		
Inspect the engine air cleaner filter and replace as necessary.*					X

Miles (Kilometers)	138,000 (230 000)	141,000 (235 000)	144,000 (240 000)	147,000 (245 000)	150,000 (250 000)
Change engine oil and engine oil filter, if not replaced at 3 months.	X	X	X	X	X
Rotate tires.	X		X		X
Inspect the brake linings.				X	
Replace the engine air cleaner filter. *					X
Replace the spark plugs.					X
Change the manual transaxle fluid. †			X		
Replace the Make-up air filter.					X
Inspect the PCV valve and replace if necessary. * ‡					X

* This maintenance is recommended by the manufacturer to the owner, but is not required to maintain the emissions warranty.

‡ This maintenance is not required if previously replaced.

† This maintenance is required only for police, taxi, limousine type operation, or trailer towing.

◇ This maintenance is required only for police, taxi, limousine type operation, or trailer towing.

Inspection and service should also be performed anytime a malfunction is observed or suspected. Retain all receipts.

448 SCHEDULE "A"—NON TURBO

SCHEDULE "A"—NON TURBO

Miles (Kilometers) [Months]	6,000 (10 000) [6]	12,000 (20 000) [12]	18,000 (30 000) [18]	24,000 (40 000) [24]	30,000 (50 000) [30]	36,000 (60 000) [36]
Change engine oil and engine oil filter.	X	X	X	X	X	X
Rotate tires.	X	X	X	X	X	X
Inspect the brake linings.			X			X
Replace the engine air cleaner filter .					X	
Replace the spark plugs .					X	
Inspect the tie rod ends and boot seals.					X	
Replace the Make-up air filter .					X	
Adjust the generator drive belt tension					X	

Miles (Kilometers) [Months]	42,000 (70 000) [42]	48,000 (80 000) [48]	54,000 (90 000) [54]	60,000 (100 000) [60]	66,000 (110 000) [66]
Change engine oil and engine oil filter.	X	X	X	X	X
Rotate tires.	X	X	X	X	X
Inspect the brake linings.			X		
Replace the engine air cleaner filter .				X	
Replace the spark plugs and ignition cables .				X	
Inspect the tie rod ends and boot seals.				X	
Inspect the PCV valve and replace, if necessary.*				X	
Flush and replace the engine coolant at 60 months, if not done at 102,000 miles.				X	
Replace the Make-up air filter .				X	
Adjust the generator drive belt tension.				X	

450 SCHEDULE "A"—NON TURBO

Miles (Kilometers) [Months]	72,000 (120 000) [72]	78,000 (130 000) [78]	84,000 (140 000) [84]	90,000 (150 000) [90]	96,000 (160 000) [96]	102,000 (170 000) [102]
Change engine oil and engine oil filter.	X	X	X	X	X	X
Rotate tires.	X	X	X	X	X	X
Inspect the brake linings.	X			X		
Replace the engine air cleaner filter .				X		
Replace the spark plugs .				X		
Replace the engine timing belt . *						X
Inspect the tie rod ends and boot seals.				X		
Inspect the PCV valve and replace if necessary. Not required if previously changed. * ‡				X		
Replace the Make-up air filter .				X		
Adjust the generator drive belt tension.				X		
Flush and replace the engine coolant, if not replaced at 60 months.						X

Miles (Kilometers) [Months]	108,000 (180 000) [108]	114,000 (190 000) [114]	120,000 (200 000) [120]	126,000 (210 000) [126]	132,000 (220 000) [132]	138,000 (230 000) [138]
Change engine oil and engine oil filter.	X	X	X	X	X	X
Rotate tires.	X	X	X	X	X	X
Inspect the PCV valve and replace if necessary. * ‡			X			
Replace the air cleaner filter .			X			
Flush and replace the engine coolant at 120 months, if not done at 102,000 miles.			X			
Replace the spark plugs and ignition cables .			X			
Replace the Make-up air filter .			X			

452 SCHEDULE "A"—NON TURBO

Miles (Kilometers) [Months]	144,000 (240 000) [144]	150,000 (250 000) [150]
Change engine oil and engine oil filter.	X	X
Rotate tires.	X	X
Inspect the PCV valve and replace if necessary. * ‡		X
Replace the air cleaner filter .		X

* This maintenance is recommended by the manufacturer to the owner but is not required to maintain the emissions warranty.

‡ This maintenance is not required if previously replaced.

Inspection and service should also be performed anytime a malfunction is observed or suspected. Retain all receipts.

SCHEDULE "A"—TURBO

Miles (Kilometers) [Months]	5,000 (8 000) [6]	10,000 (16 000) [12]	15,000 (24 000) [18]	20,000 (32 000) [24]	25,000 (40 000) [30]	30,000 (48 000) [36]
Change engine oil and engine oil filter.	X	X	X	X	X	X
Rotate tires.	X	X	X	X	X	X
Inspect the brake linings.				X		
Replace the engine air cleaner filter .						X
Replace the spark plugs .						X
Inspect the tie rod ends and boot seals.						X
Replace the Make-up air filter .						X
Adjust the generator drive belt tension.						X

454 SCHEDULE "A"—TURBO

Miles (Kilometers) [Months]	35,000 (56 000) [42]	40,000 (64 000) [48]	45,000 (72 000) [54]	50,000 (80 000) [60]	55,000 (88 000) [66]
Change engine oil and engine oil filter.	X	X	X	X	X
Rotate tires.	X	X	X	X	X
Inspect the brake linings.		X			
Flush and replace engine coolant at 60 months, if not replaced at 100,000 miles.				X	

Miles (Kilometers) [Months]	60,000 (96 000) [72]	65,000 (104 000) [78]	70,000 (112 000) [84]	75,000 (120 000) [90]	80,000 (128 000) [96]	85,000 (136 000) [102]
Change engine oil and engine oil filter.	X	X	X	X	X	X
Rotate tires.	X	X	X	X	X	X
Inspect the brake linings.	X				X	
Replace the engine air cleaner filter .	X					
Replace the spark plugs and ignition cables .	X					
Inspect the tie rod ends and boot seals.	X					
Inspect the PCV valve and replace if necessary. Not required if previously changed. * ‡	X					
Replace the Make-up air filter .	X					
Adjust the generator drive belt tension.	X					

456 SCHEDULE "A"—TURBO

Miles (Kilometers) [Months]	90,000 (144 000) [108]	95,000 (156 000) [114]	100,000 (160 000) [120]	105,000 (168 000) [126]
Change engine oil and engine oil filter.	X	X	X	X
Rotate tires.	X	X	X	X
Inspect the brake linings.			X	
Replace the engine air cleaner filter .	X			
Replace the spark plugs .	X			
Adjust the generator drive belt tension.	X			
Inspect the tie rod ends and boot seals.	X			
Inspect the PCV valve and replace if necessary. Not required if previously changed. * ‡	X			
Flush and replace the engine coolant if not done at 60 months.			X	
Replace the Make-up air filter .	X			
Replace the engine timing belt .			X	

Miles (Kilometers) [Month]	110,000 (177 000) [132]	115,000 (185 000) [138]	120,000 (193 000) [144]
Change engine oil and engine oil filter.	X	X	X
Rotate tires.	X	X	X
Inspect the PCV Valve and replace if necessary. *			X
Replace the engine air cleaner filter .			X
Replace the spark plugs and ignition cables .			X

* This maintenance is recommended by the manufacturer to the owner but is not required to maintain the emissions warranty.

‡ This maintenance is not required if previously replaced.

Inspection and service should also be performed anytime a malfunction is observed or suspected. Retain all receipts.

WARNING!

You can be badly injured working on or around a motor vehicle. Do only that service work for which you have the knowledge and the right equipment. If you have any doubt about your ability to perform a service job, take your vehicle to a competent mechanic.

IF YOU NEED CONSUMER ASSISTANCE

CONTENTS

■ Suggestions For Obtaining Service For Your Vehicle	461	□ In Mexico Contact	462
□ Prepare For The Appointment	461	□ Customer Assistance For The Hearing Or Speech Impaired (TDD/TTY)	463
□ Prepare A List	461	□ Service Contract	463
□ Be Reasonable With Requests	461	■ Warranty Information (U.S. Vehicles Only)	464
■ If You Need Assistance	461	■ Mopar® Parts	464
□ DaimlerChrysler Motors Corporation Customer Center	462	■ Reporting Safety Defects	464
□ DaimlerChrysler Canada Inc. Customer Center	462	□ In The 50 United States And Washington, D.C.	464
		□ In Canada	465

460 IF YOU NEED CONSUMER ASSISTANCE

■ Publication Order Forms465

■ Department Of Transportation Uniform Tire
Quality Grades467

□ Treadwear467

□ Traction Grades467

□ Temperature Grades468

SUGGESTIONS FOR OBTAINING SERVICE FOR YOUR VEHICLE

Prepare For The Appointment

If you're having warranty work done, be sure to have the right papers with you. Take your warranty folder. All work to be performed may not be covered by the warranty. Discuss additional charges with the service manager. Keep a maintenance log of your vehicle's service history. This can often provide a clue to the current problem.

Prepare A List

Make a written list of your vehicle's problems or the specific work you want done. If you've had an accident or work done that is not on your maintenance log, let the service advisor know.

Be Reasonable With Requests

If you list a number of items and you must have your vehicle by the end of the day, discuss the situation with the service advisor and list the items in order of priority. At many authorized dealers, you may obtain a rental vehicle at a minimal daily charge. If you need a rental, it is advisable to make these arrangements when you call for an appointment.

IF YOU NEED ASSISTANCE

The manufacturer and its authorized dealers are vitally interested in your satisfaction. We want you to be happy with our products and services.

Warranty service must be done by an authorized dealer. We strongly recommend that you take your vehicle to your authorized selling dealer. They know you and your vehicle best, and are most concerned that you get prompt and high quality service. The manufacturer's authorized dealers have the facilities, factory-trained technicians,

special tools, and the latest information to ensure your vehicle is fixed correctly and in a timely manner.

This is why you should always talk to your authorized dealer's service manager first. Most matters can be resolved with this process.

- If for some reason you are still not satisfied, talk to the general manager or owner of the authorized dealership. They want to know if you need assistance.
- If your authorized dealership is unable to resolve the concern, you may contact the Manufacturer's Customer Center.

Any communication to the Manufacturer's Customer Center should include the following information:

- Owner's name and address
- Owner's telephone number (home and office)
- Authorized dealership name

- Vehicle Identification Number (VIN)
- Vehicle delivery date and mileage

DaimlerChrysler Motors Corporation Customer Center

P.O. Box 21-8004

Auburn Hills, MI 48321-8004

Phone: (800) 992-1997

DaimlerChrysler Canada Inc. Customer Center

P.O. Box 1621

Windsor, Ontario N9A 4H6

Phone: (800) 465-2001

In Mexico contact:

Av. Prolongacion Paseo de la Reforma, 1240

Sante Fe C.P. 05109

Mexico, D. F.

In Mexico: (915) 729-1248 or 729-1240

Outside Mexico: (525) 729-1248 or 729-1240

Customer Assistance For The Hearing Or Speech Impaired (TDD/TTY)

To assist customers who have hearing difficulties, the manufacturer has installed special TDD (Telecommunication Devices for the Deaf) equipment at its Customer Center. Any hearing or speech impaired customer, who has access to a TDD or a conventional teletypewriter (TTY) in the United States, can communicate with the manufacturer by dialing 1-800-380-CHRY.

Service Contract

You may have purchased a service contract for your vehicle to help protect you from the high cost of unexpected repairs after your manufacturer's New Vehicle Limited Warranty expires. The manufacturer stands behind only the manufacturer's Service Contracts. If you purchased a manufacturer's Service Contract, you will receive Plan Provisions and an Owner Identification Card in the mail within three weeks of your vehicle delivery date. If you have any questions about your service

contract, call the manufacturer's Service Contract National Customer Hotline at 1-800-521-9922.

The manufacturer will not stand behind any service contract that is not the manufacturer's Service Contract. It is not responsible for any service contract other than the manufacturer's Service Contract. If you purchased a service contract that is not a manufacturer's Service Contract, and you require service after your manufacturer's New Vehicle Limited Warranty expires, please refer to your contract documents, and contact the person listed in those documents.

We appreciate that you have made a major investment when you purchased your vehicle. Your authorized dealer has also made a major investment in facilities, tools, and training to assure that you are absolutely delighted with your ownership experience. You'll be pleased with their sincere efforts to resolve any warranty issues or related concerns.

WARNING!

Engine exhaust, some of its constituents, and certain vehicle components contain, or emit, chemicals known to the State of California to cause cancer and birth defects or other reproductive harm. In addition, certain fluids contained in vehicles and certain products of component wear contain, or emit, chemicals known to the State of California to cause cancer and birth defects or other reproductive harm.

WARRANTY INFORMATION (U.S. Vehicles Only)

See the Warranty Information Booklet for the terms and provisions of DaimlerChrysler's warranties applicable to this vehicle.

MOPAR® PARTS

Mopar® fluids, lubricants, parts, and accessories are available from your authorized dealer. They will help you keep your vehicle operating at its best.

REPORTING SAFETY DEFECTS**In The 50 United States And Washington, D.C.**

If you believe that your vehicle has a defect that could cause a crash or cause injury or death, you should immediately inform the National Highway Traffic Safety Administration (NHTSA) in addition to notifying the manufacturer.

If NHTSA receives similar complaints, it may open an investigation, and if it finds that a safety defect exists in a group of vehicles, it may order a recall and remedy campaign. However, NHTSA cannot become involved in individual problems between you, your authorized dealer, and the manufacturer.

To contact NHTSA, you may either call the Auto Safety Hotline toll free at 1-888-327-4236 (TTY: 1-800-424-9153), or go to <http://www.safercar.gov>; or write to: Administrator, NHTSA, 400 Seventh Street, SW., Washington, D.C. 20590. You can also obtain other information about motor vehicle safety from <http://www.safercar.gov>.

In Canada

If you believe that your vehicle has a safety defect, you should contact the Customer Service Department immediately. Canadian customers who wish to report a safety defect to the Canadian government should write to: Transport Canada, Motor Vehicle Defect Investigations and Recalls, 2780 Sheffield Road, Ottawa, Ontario K1B 3V9.

PUBLICATION ORDER FORMS

To order the following manuals, you may use either the website or the phone numbers listed below. Visa, Mastercard, American Express, and Discover orders are accepted. If you prefer mailing your payment, please call for an order form.

NOTE: A street address is required when ordering manuals (no P.O. Boxes).

- *Service Manuals*

These comprehensive Service Manuals provide the information that students and professional technicians need in diagnosing/troubleshooting, problem solving, maintaining, servicing, and repairing DaimlerChrysler Corporation vehicles. A complete working knowledge of the vehicle, system, and/or components is written in straightforward language with illustrations, diagrams, and charts.

- *Diagnostic Procedure Manuals*

Diagnostic Procedure Manuals are filled with diagrams, charts and detailed illustrations. These practical manuals make it easy for students and technicians to find and fix problems on computer-controlled vehicle systems and features. They show exactly how to find and correct problems the first time, using step-by-step troubleshooting and drivability procedures, proven diagnostic tests and a complete list of all tools and equipment.

- *Owner's Manuals*

These Owner's Manuals have been prepared with the assistance of service and engineering specialists to acquaint you with specific DaimlerChrysler Corporation vehicles. Included are starting, operating, emergency and maintenance procedures as well as specifications, capabilities and safety tips.

Call toll free at:

- **1-800-890-4038 (U.S.)**
- **1-800-387-1143 (Canada)**

Or

Visit us on the Worldwide Web at:

- **www.techauthority.daimlerchrysler.com**
- **www.daimlerchrysler.ca/manuals**

DEPARTMENT OF TRANSPORTATION UNIFORM TIRE QUALITY GRADES

The following tire grading categories were established by the National Highway Traffic Safety Administration. The specific grade rating assigned by the tire's manufacturer in each category is shown on the sidewall of the tires on your vehicle.

All passenger car tires must conform to Federal safety requirements in addition to these grades.

Treadwear

The treadwear grade is a comparative rating, based on the wear rate of the tire when tested under controlled conditions on a specified government test course. For example, a tire graded 150 would wear 1-1/2 times as well on the government course as a tire graded 100. The relative performance of tires depends upon the actual

conditions of their use, however, and may depart significantly from the norm due to variations in driving habits, service practices, and differences in road characteristics and climate.

Traction Grades

The traction grades, from highest to lowest, are AA, A, B, and C. These grades represent the tire's ability to stop on wet pavement, as measured under controlled conditions on specified government test surfaces of asphalt and concrete. A tire marked C may have poor traction performance.

WARNING!

The traction grade assigned to this tire is based on straight-ahead braking traction tests, and does not include acceleration, cornering, hydroplaning, or peak traction characteristics.

Temperature Grades

The temperature grades are A (the highest), B, and C, representing the tire's resistance to the generation of heat and its ability to dissipate heat, when tested under controlled conditions on a specified indoor laboratory test wheel. Sustained high temperature can cause the material of the tire to degenerate and reduce tire life, and excessive temperature can lead to sudden tire failure. The grade C corresponds to a level of performance, which all passenger car tires must meet under the Federal Motor Vehicle Safety Standard No. 109. Grades B and A represent higher levels of performance on the laboratory test wheel, than the minimum required by law.

WARNING!

The temperature grade for this tire is established for a tire that is properly inflated and not overloaded. Excessive speed, under-inflation, or excessive loading, either separately or in combination, can cause heat buildup and possible tire failure.

INDEX

- ABS (Anti-Lock Brake System) 308
- Adding Engine Coolant (Antifreeze) 400
- Adding Fuel 340
- Adding Washer Fluid 218
- Additives, Fuel 338
- Air Cleaner, Engine (Engine Air Cleaner Filter) . . . 391
- Air Conditioner Maintenance 393
- Air Conditioning Controls 277
- Air Conditioning, Operating Tips 283
- Air Conditioning Refrigerant 393,394
- Air Conditioning System 277,393
- Air Pressure, Tires 322
- Airbag 55,90
- Airbag Deployment 66,101
- Airbag Light 70,104,116,234
- Airbag Maintenance 68,103
- Airbag, Side 65,100
- Alarm, Panic 26,32
- Alarm System (Security Alarm) 36,233
- Alignment and Balance 329
- Alterations/Modifications, Vehicle 7
- Antenna, Satellite Radio 276
- Antifreeze (Engine Coolant) 399,400,429,430
- Capacities 429
- Disposal 401
- Anti-Lock Brake System (ABS) 308
- Anti-Lock Warning Light 233
- Anti-Theft Security Alarm (Theft Alarm) 36
- Appearance Care 411
- Auto Down Power Windows 43
- Automatic Door Locks 21
- Automatic Transaxle 13,291,294,408
- Adding Fluid 408
- Filter 409
- Fluid and Filter Changes 409
- Fluid Level Check 408
- Interlock System 19,295
- Reset Mode 296

Shifting	297	Master Cylinder	406
Special Additives	410	Parking	305
Autostick	299	Warning Light	231
Back-Up Lights	427	Brakes	307,404
Ball Joints	395	Brake/Transmission Interlock	295
Battery	392	Break-In Recommendations, New Vehicle	115
Keyless Transmitter Replacement (RKE)	29,35	Bulb Replacement	424,425
Belts, Drive	388	Bulbs, Light	424
Belts, Engine	390	Calibration, Compass	238,247,248
Body Mechanism Lubrication	395	Capacities, Antifreeze (Engine Coolant)	429
Boot, Convertible Top	128,132	Capacities, Fluid	429
B-Pillar Location	317	Caps, Filler	
Brake Fluid	431	Fuel	340
Brake, Parking	305	Oil (Engine)	378,379,387
Brake System	307,404	Radiator (Coolant Pressure)	400
Anti-Lock (ABS)	308	Car Washes	411
Fluid Check	406	Carbon Monoxide Warning	339
Hoses	404		

Cargo Compartment	
Luggage Carrier	215
Carrier, Luggage	215
Catalytic Converter	389
Caution, Exhaust Gas	115
CD (Compact Disc) Player	251,259
CD (Compact Disc) Player Maintenance	277
Cellular Phone	138,277
Center High Mounted Stop Light	428
Chains, Tire	330
Changing A Flat Tire	360
Chart, Tire Sizing	314
Check Engine Light (Malfunction Indicator Light)	381
Child Restraint	72,107
Child Restraint Tether Anchors	77,111
Child Restraint with Automatic Belts	76
Child Safety Locks	22
Child Seat	78,112
Clean Air Gasoline	337
Cleaning	
Wheels	413
Climate Control	277
Clock	250,253,261
Clutch	406
Clutch Fluid	406
Coin Holder	208
Compact Disc (CD) Maintenance	277
Compact Spare Tire	325
Compass	234,235,238,248
Compass Calibration	238,247,248
Compass Variance	236
Computer, Trip/Travel	234,235
Console	208
Contract, Service	463
Convertible	123
Convertible Boot	128,132
Convertible Top	123

- Convertible Top Maintenance 416
- Convertible Top Manual Override 134,373
- Cool Down, Turbo 293
- Coolant (Antifreeze) 429,430
- Coolant Pressure Cap (Radiator Cap) 400
- Cooling System 398
 - Adding Coolant (Antifreeze) 400
 - Coolant Level 398,401
 - Disposal of Used Coolant 401
 - Drain, Flush, and Refill 399
 - Inspection 401
 - Points to Remember 402
 - Pressure Cap 400
 - Radiator Cap 400
 - Selection of Coolant (Antifreeze) 399
- Corrosion Protection 411
- Crankcase Emission Control System 390
- Cruise Light 229
- Cup Holder 208
- Customer Assistance 461
- Data Recorder, Event 70,105
- Dealer Service 383
- Deck Lid (Convertible) 39
- Deck Lid, Emergency Release Latch (Convertible) . . 41
- Deck Lid, Power Release (Convertible) 39
- Defroster, Rear Window 217
- Defroster, Windshield 116,279
- Delay (Intermittent) Wipers 192
- Diagnostic System, Onboard 380
- Dimmer Switch, Headlight 189
- Dipsticks
 - Automatic Transaxle 408
- Disposal
 - Antifreeze (Engine Coolant) 401
 - Engine Oil 387
- Door Locks 19
- Door Locks, Automatic 21

Door Opener, Garage	197	Emission Control System Maintenance	381,434
Downshifting	304	Engine	115,378,379
Drive Belts	388	Break-In Recommendations	115
Driver's Seat Back Tilt	167	Checking Oil Level	384
Driving		Coolant (Antifreeze)	398
On Slippery Surfaces	369	Cooling	398
Electric Rear Window Defrost	217	Exhaust Gas Caution	339
Electric Remote Mirrors	137	Fuel Requirements	337
Electrical Power Outlets	206	Jump Starting	367
Electronic Speed Control (Cruise Control)	194	Oil	384,429,430
Electronic Vehicle Information Center		Oil Change Interval	385
(EVIC)	234,235,240	Oil Filler Cap	378,379,387
Emergency Deck Lid Release Latch (Convertible)	41	Oil Filter	430
Emergency, In Case of		Oil Selection	386
Jacking	360	Oil Synthetic	387
Jump Starting	367	Operation	115
Towing	371	Overheating	358
Emergency Seat Back Release (Sedan)	40	Temperature Gauge	226
		Timing Belt	390

Ethanol	337	Fluid Level Checks	
Event Data Recorder	70,105	Automatic Transaxle	408
Exhaust Gas Caution	38,39,115,339,397	Brake	406
Exhaust System	397	Cooling System	398
		Power Steering	394
Fabric Care	413,414	Fluids	430
Filler Location Fuel	226,340	Fluids, Lubricants and Genuine Parts	430
Filters		Fog Light Service	426
Air Cleaner	391	Fog Lights	188,233
Automatic Transaxle	409	Folding Front Passenger Seat	167
Engine Fuel	391	Folding Rear Seat	171,173
Engine Oil	387,430	Folding Rear Seat (Convertible)	173
Flashers	358	Folding Rear Seat (Sedan)	171
Hazard Warning	358	Freeing A Stuck Vehicle	370
Flat Tire Stowage	367	Fuel	337,430
Flooded Engine Starting	293	Adding	340
Fluid, Brake	431	Additives	338
Fluid Capacities	429	Capacity	429
Fluid Leaks	117	Clean Air	337

Ethanol	337	Gasoline, Clean Air	337
Filler Cap (Gas Cap)	226,340	Gasoline (Fuel)	337,429
Filler Door (Gas Cap)	226	Gasoline, Reformulated	337
Filter	391	Gauges	
Gasoline	337	Coolant Temperature	226
Gauge	226	Fuel	226
Hoses	404	Odometer	229
Light	233	Tachometer	227
Materials Added	338	Gearshift	297
Methanol	337	General Information	18,163,336
Octane Rating	337	General Maintenance	384
Requirements	337	Glass Cleaning	415
Tank Capacity	429	Gross Axle Weight Rating	344
Fuel System Caution	341	Gross Vehicle Weight Rating	343
Fueling	340	Hands-Free Phone (UConnect™)	138
Fuses	419	Hazard Warning Flasher	358
Garage Door Opener (HomeLink®)	197	Head Restraints	169
Gas Cap (Fuel Filler Cap)	340,342,381		

Headlights	
Bulb Replacement	425
Cleaning	415
High Beam	189,234
High Beam/Low Beam Select Switch	189
Passing	190
Switch	186
Heated Seats	169
Hitches	
Trailer Towing	345
HomeLink® (Garage Door Opener) Transmitter	197
Hood Release	183
Hoses	403,404
Ignition	13
Key	13
Wiring System (Spark Plug Wires)	388
Ignition Key Removal	13
Immobilizer (Sentry Key)	15,37
Infant Restraint	73,107
Information Center, Vehicle	240
Inside Rearview Mirror	135
Instrument Cluster	223,226
Instrument Panel and Controls	222
Instrument Panel Cover	413,415
Instrument Panel Lens Cleaning	416
Integrated Power Module (Fuses)	419
Interior Appearance Care	413
Intermittent Wipers (Delay Wipers)	192
Introduction	4
Jack Location	361
Jack Operation	360,363
Jacking Instructions	363
Jump Starting	367
Key, Programming	17
Key, Replacement	16

Key, Sentry (Immobilizer)	15	Center Mounted Stop	428
Key-In Reminder	15	Daytime Running	187
Keyless Entry System (Convertible)	30	Dimmer Switch, Headlight	186
Keyless Entry System (Sedan)	24	Engine Temperature Warning	232
Keys	13	Fog	188,233,426
Lane Change and Turn Signals	230	Front Replacement	425
Lap/Shoulder Belts	45,82	Headlight Switch	186
Latches		Headlights	186
Hood	183	High Beam Indicator	234
Lead Free Gasoline	337	Instrument Cluster	186
Life of Tires	327	Lights On Reminder	187
Liftgate (Sedan)	37	Low Fuel	233
Light Bulbs	424,425	Malfunction Indicator (Check Engine)	229
Lights	117,184	Map Reading	184,185
Airbag	70,104,116,234	Oil Pressure	234
Anti-Lock	233	Rear Servicing	427
Back-Up	427	Seat Belt Reminder	232
Brake Warning	231	Security Alarm (Theft Alarm)	36
		Service	425

Theft Alarm (Security Alarm)	233	Maintenance, General	384
Tire Pressure Monitoring (TPMS)	332	Maintenance Procedures	384
Traction Control	312	Maintenance Schedule	
Turn Signal	186,189,230,426	Schedule "A"-Non Turbo	448
Voltage	230	Schedule "A"-Turbo	453
Warning (Instrument Cluster Description)	226	Schedule "B"	437
Loading Vehicle	342	Schedule "B"-All Engines	437
Tires	317	Maintenance Schedules	434
Locks		Malfunction Indicator Light (Check Engine)	229,381
Child Protection	22	Manual Override, Convertible Top	134,373
Door	19	Manual, Service	465
Power Door	20	Manual Transaxle	292,301,410
Steering Wheel	18	Downshifting	304
Low Tire Pressure System	332	Fluid Level Check	410
Lubrication, Body	395	Frequency of Fluid Change	410
Luggage Rack (Roof Rack)	215	Lubricant Selection	410
Lumbar Support	166	Map/Reading Lights	184,185
Maintenance Free Battery	392	Master Cylinder (Brakes)	406
		Methanol	337

Mini-Trip Computer	235	Oil, Engine	384,429
Mirrors	135	Capacity	429
Electric Remote	137	Change Interval	385
Outside	136	Checking	384
Rearview	135	Disposal	387
Vanity	138	Filter	387
Modifications/Alterations, Vehicle	7	Identification Logo	386
Monitor, Tire Pressure System	332	Materials Added to	387
Mopar Parts	383,464	Quality	386
MTBE/ETBE	337	Recommendation	386,429
Multi-Function Control Lever	186	Synthetic	387
 		Viscosity	387
New Vehicle Break-In Period	115	Oil Filter, Selection	388
 		Oil Pressure Light	234
Occupant Restraints (Convertible)	81	Onboard Diagnostic System	380,381
Occupant Restraints (Sedan)	44	Opener, Garage Door (HomeLink®)	197
Octane Rating, Gasoline (Fuel)	337	Operator Manual (Owner's Manual)	4
Odometer	229	Outside Air Intake	284
Trip	229,230	Overdrive	298

Overheating, Engine	358	Seats	165
Owner's Manual (Operator Manual)	4,465	Steering	310,394
Paint Care	411	Steering, Checking	394
Panel Rear Shelf	210	Sunroof	204
Panic Alarm	26,32	Windows	42
Parking Brake	305	Power Steering Fluid	394,431
Passenger Seat Back Tilt (Easy Entry System)	168	Pregnant Women and Seat Belts	54,89
Passing Light	190	Preparation for Jacking	362
Personal Settings	244	Pretensioners	
Pets	80,114	Seat Belts	53,88
Phone, Cellular	138	Programmable Electronic Features	244
Phone, Hands-Free (UConnect™)	138	Programming Transmitters (Remote Keyless Entry)	27,33
Placard, Tire and Loading Information	317	Radial Ply Tires	324
Power		Radiator Cap (Coolant Pressure Cap)	400
Deck Lid Release	39	Radio Broadcast Signals	250
Distribution Center (Fuses)	419	Radio Operation	251,259,277
Door Locks	20	Radio, Satellite	273
Outlet (Auxiliary Electrical Outlet)	206		

- Radio (Sound Systems) 251,259
- Rear Liftgate (Sedan) 37
- Rear Seat, Folding 171,173,175,177
- Rear Seat Removal 181
- Rear Shelf Panel 210
- Rear Window 43
- Rear Window Defroster 217
- Rear Window Features 217
- Rear Wiper/Washer 217
- Recorder, Event Data 70,105
- Recreational Towing 356
- Reformulated Gasoline 337
- Refrigerant 394
- Reminder, Seat Belt 54,89
- Remote Keyless Entry (Convertible) 30
- Remote Keyless Entry (Sedan) 24
- Replacement Bulbs 424
- Replacement Keys 16
- Replacement Parts 383
- Replacement Tires 328
- Reporting Safety Defects 464
- Restraints, Child 72,78,107,112
- Restraints, Infant 73,107
- Roof Rack (Luggage Rack) 215
- Rotation, Tires 331
- Safety Checks Inside Vehicle 116
- Safety Checks Outside Vehicle 117
- Safety Defects, Reporting 464
- Safety Information, Tire 313
- Safety Tips 115
- Satellite Radio 273
- Satellite Radio Antenna 276
- Schedule, Maintenance 434
- Seat Belt Maintenance 416
- Seat Belt Reminder 54,89
- Seat Belts
- Adjustable Shoulder Belt 52

Adjustable Upper Shoulder Anchorage	52	Power	165
And Pregnant Women	54,89	Rear Folding	171,173,175,177
Child Restraint	72,107	Rear Folding (Convertible)	173
Front Seat	45,82	Rear Folding (Sedan)	171
Pretensioners	53,88	Removal	181
Rear Seat	45,82	Seatback Release	167,168
Reminder	232	Tilting	167,168
Untwisting Procedure	52,88	Tumbling Rear (Convertible)	177
Seat Belts (Convertible)	81	Tumbling Rear (Sedan)	175
Seat Belts (Sedan)	44	Security Alarm (Theft Alarm)	36
Seats	164	Selection of Coolant (Antifreeze)	399
Adjustment	164	Sentry Key (Immobilizer)	15,37
Cleaning	414	Sentry Key Programming	17
Easy Entry	168	Service and Maintenance	434
Emergency Seat Back Release (Sedan)	40	Service Assistance	461
Folding Front Passenger	167	Service Contract	463
Head Restraints	169	Service Manuals	465
Heated	169	Setting the Clock	250,253,261
Lumbar Support	166	Settings, Personal	244

Severe Service	437	Steering	
Shift Speeds, Manual Transaxle	304	Linkage	395
Shoulder Belts	45,82	Power	310,394
Side Airbag	65,100	Tilt Column	193
Side Window Demisters (Defrosters)	285	Wheel Lock	18
Slippery Surfaces, Driving On	369	Storage	209,423
Snow Chains (Tire Chains)	330	Stuck, Freeing	370
Snow Tires	330	Sun Roof	204
Spare Tire	325,361	Sun Visor Extension	138
Spark Plugs	388	Supplemental Restraint System - Airbag	55,90
Speed Control (Cruise Control)	194,229	Synthetic Engine Oil	387
Speedometer	226		
Speedometer and Odometer	223	Tachometer	227
Starting	291,292	Temperature Gauge, Engine Coolant	226,359
Automatic Transmission	291	Tether Anchor, Child Restraint	77,111
Engine Fails to Start	293	Theft Alarm (Security Alarm)	36
Manual Transmission	292	Theft System (Security Alarm)	36
Starting and Operating	291,292	Tilt Steering Column	193
Starting Procedures	291	Tire and Loading Information Placard	317

Tire Identification Number (TIN)	316	Radial	324
Tire Markings	313	Replacement	328
Tire Safety Information	313	Rotation	331
Tires	117,321,467	Safety	313,321
Aging (Life of Tires)	327	Sizes	314
Air Pressure	321	Snow Tires	330
Alignment	329	Spare Tire	361
Chains	330	Spinning	326
Changing	360	Tread Wear Indicators	327
Compact Spare	325	Tongue Weight/Trailer Weight	348
Flat Changing	367	Top Cover	128
General Information	321	Towing	343
High Speed	324	Disabled Vehicle	371
Inflation Pressures	322	Guide	347
Jacking	360	Recreational	356
Life of Tires	327	Weight	347
Load Capacity	317,318	Traction	370
Pressure Monitor System (TPMS)	227,332	Traction Control	311
Quality Grading	467	Traction Control Switch	311

- Trailer Towing 343
 Cooling System Tips 355
 Hitches 345
 Minimum Requirements 349
 Trailer and Tongue Weight 348
 Wiring 353
Trailer Towing Guide 347
Trailer Weight 347
Transaxle 294
 Additives 410
 Automatic 13,291,294,408
 Autostick 299
 Filter 409
 Maintenance 408
 Manual 14,292,301
 Operation 294
 Overdrive 298
Transmission
 Range Indicator 227
Transmitter Battery Service (Remote Keyless
Entry) 29,35
Transmitter, Garage Door Opener (HomeLink®) . . . 197
Transmitter Programming (Remote Keyless
Entry) 27,33
Transporting Pets 80,114
Tread Wear Indicators 327
Trip Computer 235
Trip Odometer 229
Trip Odometer Reset Button 230
Trunk Lid, Deck Lid (Convertible) 39
Tumbling Rear Seat (Convertible) 177
Tumbling Rear Seat (Sedan) 175
Turbo Cool Down 293
Turn Signals 189,230
UConnect™ (Hands-Free Phone) 138
Understanding Your Instrument Panel 222
Uniform Tire Quality Grades 467

Universal Transmitter	197	Washer, Rear	217
Unleaded Gasoline	337	Washers, Windshield	191
Untwisting Procedure, Seat Belt	52,88	Washing Vehicle	411
Upholstery Care	413	Wheel Alignment and Balance	329
		Wheel and Wheel Trim	413
Vacuum/Vapor Harnesses	403	Wheel and Wheel Trim Care	413
Vanity Mirrors	138	Wind Buffeting	44,205
Variance, Compass	236	Window Fogging	284
Vehicle Identification Number (VIN)	6	Windows	42
Vehicle Loading	318,342	Windshield Washers	190,191
Vehicle Modifications/Alterations	7	Windshield Wipers	190,396
Vehicle Storage	423	Wiper Blade Replacement	396
Vehicle Theft Alarm (Security Alarm)	36	Wiper, Rear	217
		Wipers, Intermittent	192
Warning Lights (Instrument Cluster Description)	226	YES Essentials® Fabric Cleaning Procedure	414
Warnings and Cautions	6		
Warranty Information	464		
Washer, Adding Fluid	218		

