

VRX610

clarion®

Owner's manual & Installation manual
Mode d'emploi et manuel d'installation
Manual de instrucciones y de instalación

VRX610

6.5" MONITOR & FM/AM RADIO WITH
CD/MD CHANGER CONTROL

•
MONITEUR DE 6,5 POUÇES ET RADIO FM/AM
AVEC COMMANDE DE CHANGEUR
DE CD/MD

•
MONITOR DE 6,5-PULGADAS Y RADIO FM/AM
CON MANDO PARA EL CAMBIADOR DE
CD/MD

Clarion Co., Ltd.

All Rights Reserved. Copyright © 2001: Clarion Co., Ltd.
Printed in China / Imprimé en Chine / Impreso en China /

2001/2 (IT-K)

QC-6700B
280-7653-00

clarion®

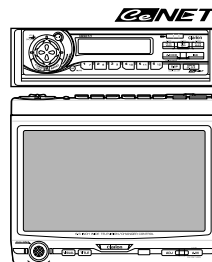

Thank you for purchasing the Clarion VRX610.

- * This owner's manual is for the VRX610.
- * Please read this owner's manual in its entirety before operating this equipment.
- * After reading this manual, be sure to keep it in a handy place (e.g., glove compartment).
- * Check the contents of the enclosed warranty card and keep it carefully with this manual.
- * This manual includes the operating procedures of the CD changer, MD changer, TV tuner and digital sound processor (DSP) connected via the CeNET cable. The CD changer, MD changer, TV tuner and DSP have their own manuals, but no explanations for operating them are described.

Contents

1. PRECAUTIONS.....	4	Tuning.....	20
WARNING.....	4	Seek tuning.....	20
INFORMATION FOR USERS.....	4	Manual tuning.....	20
2. CONTROLS.....	5	Recalling a preset station.....	20
3. NOMENCLATURE.....	6	Manual memory.....	21
Names of Buttons.....	6	Auto store.....	21
JOYSTICK Operation.....	7	Preset scan.....	21
4. MODE DISPLAY.....	8	Instant station recall (ISR).....	21
Display common to each mode.....	8	CD Changer Operations.....	22
TITLE LIST mode display.....	8	CD changer functions.....	22
RADIO mode display.....	9	Pausing play.....	22
CD/MD Changer mode display.....	10	Displaying CD titles.....	22
TV mode display.....	11	Selecting a CD.....	22
5. REMOTE CONTROL.....	12	Selecting a track.....	22
Inserting the Batteries.....	12	Fast-forward/Fast-backward.....	23
Functions of Remote Control Unit Buttons.....	13	Top function.....	23
6. DCP.....	14	Scan play.....	23
Removing the DCP.....	14	Disc scan play.....	23
Attaching the DCP.....	14	Repeat play.....	23
7. CAUTIONS ON HANDLING.....	15	Disc repeat play.....	23
LCD panel/Generalities.....	15	Random play.....	23
Cleaning.....	15	Disc random play.....	23
8. OPERATIONS.....	16	MD Changer Operations.....	24
Basic Operations.....	16	MD changer functions.....	24
Turning on and off the power.....	16	Pausing play.....	24
Selecting a mode.....	16	Switching disc titles and track titles.....	24
Adjusting the volume.....	16	Scrolling titles.....	24
Switching the display.....	16	Selecting an MD.....	24
Showing a mode display.....	17	Selecting a track.....	24
Opening and turning the display.....	17	Fast-forward/fast-backward.....	24
Turning on and off the monitor.....	17	Top function.....	24
Mute.....	17	Scan play.....	25
Setting the Z-enhancer.....	17	Disc scan play.....	25
Adjusting the Z-enhancer.....	18	Repeat play.....	25
Adjusting the bass and treble.....	18	Disc repeat play.....	25
Adjusting the balance and fader.....	18	Random play.....	25
Turning on/off the loudness.....	19	Disc random play.....	25
Radio Operations.....	20		
FM reception.....	20		
Changing the reception area.....	20		
Listening to the radio.....	20		

4. MODE DISPLAY

The Color LCD Display and the Information Panel on the main unit show the following displays, providing information about the mode and functions operated.

Display common to each mode

COLOR LCD DISPLAY

INFORMATION PANEL

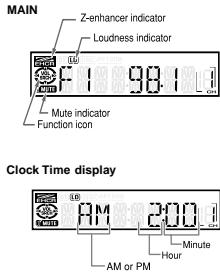
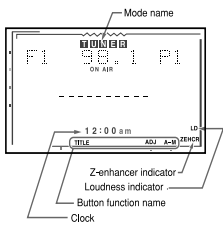

TITLE LIST mode display

COLOR LCD DISPLAY

INFORMATION PANEL

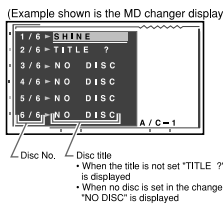

Contents	
TV Operations.....	26
TV functions.....	26
Watching TV.....	26
Watching a video.....	26
Tuning.....	26
Seek tuning.....	26
Manual tuning.....	26
Recalling a preset station.....	26
Manual memory.....	27
Auto store.....	27
Preset scan.....	27
Switching the VTR system between.....	27
NTSC and PAL.....	27
Setting the TV diver.....	27
Adjusting the brightness and tone of color.....	28
Changing over TV display size.....	28
Rear Vision Camera.....	29
Monitoring the rear vision camera.....	29
Operation of External Visual Devices (VISUAL Mode).....	29
Switching to Composite Screen.....	29
Other Functions.....	30
Always turning on the button illumination on the operation panel.....	30
Entering titles.....	30
Title list play.....	30
Clock Adjustment.....	31
Triggered audio mute for cellular telephones.....	31
DSP operations.....	32
DSP control function.....	32
DSP functions.....	32
Operations common to each mode.....	32
Output adjustment of auto loudness, subwoofer and playback band.....	32
Selecting the standard mode or the professional mode.....	33
Wooler level adjustment.....	33
Standard mode/Setting the listening position.....	33
Selection of listening position.....	33
Detail Adjustment of listening position.....	33
Standard mode/G.EQ operations.....	34
G.EQ effect ON/OFF.....	34
Calling G.EQ BASIC Pattern/USER Pattern.....	34
Setting and storing G.EQ Properties/ Memory into USER Pattern.....	34
Standard mode/DSF operations.....	35
DSF effect ON/OFF.....	35
Calling DSF BASIC Pattern/USER Pattern.....	35
Setting and storing DSF Properties/ Memory into USER Pattern.....	35
Professional mode/VSE operations.....	36
VSE effect ON/OFF.....	36
Calling VSE BASIC Pattern/USER Pattern.....	36
Setting and storing VSE Properties/ Memory into USER Pattern.....	36
Professional mode/PEQ operations.....	37
Calling PEQ BASIC Pattern/USER Pattern.....	37
Setting and storing PEQ Properties/ Memory into USER Pattern.....	37
9. IN CASE OF DIFFICULTY.....	39
10. ERROR DISPLAYS.....	41
11. SPECIFICATIONS.....	42
Installation and Wire connection manual.....	43

1. PRECAUTIONS

WARNING

For your safety, the driver should not watch the TV or operate the controls while driving. Please note that watching and operating the TV while driving are prohibited by law in some countries. Also, while driving, keep the volume to a level at which external sounds can be heard.

- When the inside of the car is very cold and the heater, moisture may form on the disc (CD/MD) or the optical parts of the player and proper playback may not be possible. If moisture forms on the disc (CD/MD), wipe it off with a soft cloth. If moisture forms on the optical parts of the player, do not use the player for about one hour. The condensation will disappear naturally allowing normal operation.
- Driving on extremely bumpy roads which cause severe vibration may cause the sound to skip.
- This unit uses a precision mechanism. Even in the event that trouble arises, never open the case, disassemble the unit, or lubricate the rotating parts.
- TV broadcast reception
 - When receiving the TV broadcasts, the strength of the signals changes since the car is moving, so in some cases it may not be possible to receive clear pictures.
 - TV signals are strongly linear, so reception is affected by buildings, mountains and other obstacles.
 - Such external factors such as electric train lines, a high voltage lines, and signal devices may disturb the picture or cause noise.
 - If the reception is poor, switch to a station with good reception.

This equipment has been tested and found to comply with the limits for a Class B digital device, pursuant to Part 15 of the FCC Rules. These limits are designed to provide reasonable protection against harmful interference in a residential installation. This equipment generates, uses, and can radiate radio frequency energy and, if not installed and used in accordance with the instructions, may cause harmful interference to radio communications. However, there is no guarantee that interference will not occur in a particular installation. If this equipment does cause harmful interference to radio or television reception, which can be determined by turning the equipment off and on, the user is encouraged to consult the dealer or an experienced radio/TV technician for help.

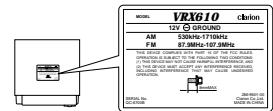

INFORMATION FOR USERS:
CHANGES OR MODIFICATIONS TO THIS PRODUCT NOT APPROVED BY THE MANUFACTURER WILL VOID THE WARRANTY AND WILL VIOLATE FCC APPROVAL.

Be sure to unfold and read the next page. / Veuillez déplier et vous référer à la page suivante. / Cercóiese de desplegar y de leer la página siguiente.

2. CONTROLS / COMMANDES / CONTROLES

Main unit / Unité principale / Unidad principal

With the Display closed / Avec l'afficheur fermé / Con el visualizador cerrado

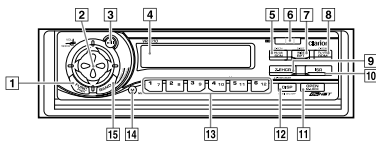

With the Display open / Avec l'afficheur ouvert / Con el visualizador abierto

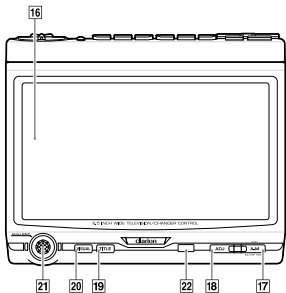

Note: Be sure to unfold this page and refer to the front diagrams as you read each chapter.
Remarque: Veuillez déplier cette page et vous référer aux schémas quand vous lisez chaque chapitre.
Nota: Cuando lea los capítulos, despliegue esta página y consulte los diagramas.

3. NOMENCLATURE

Names of Buttons

Note:
• Be sure to read this chapter referring to the front diagrams of chapter "2. CONTROLS" on page 5 (unfold).

With the display closed

- 1 POWER button
- 2 SEARCH button
- 3 PLAY/PAUSE button
- 4 Information Panel
- 5 PS (Preset scan)/AS (Auto store) button
- 6 DCP RELEASE lever
- 7 WIDE button
- 8 TV/VTR button
- 9 Z-EHCR (Z-enhancer) button
- 10 ISR button
- 11 OPEN button
- 12 M. LOCK(Monitor lock) button
- 13 DISP (Display) button
- 14 MONI ON/OFF button
- 15 PRESET buttons (1 to 6)
- 16 DIRECT buttons (1 to 6)
- 17 MUTE button
- 18 BAND button

With the display open

- 19 Color LCD display
- 20 A-M (Audio-Mode) button
- 21 ADJ (Adjust) button
- 22 TITLE button
- 23 VISUAL button
- 24 JOYSTICK
- 25 Remote Control Infrared Sensor

JOYSTICK Operation

Note:
• Many settings/procedures have to be performed by using the JOYSTICK [24]. Be sure to read this chapter in order to operate it properly.

● Selecting an item in the menu

Select an item displayed in the menu by operating the JOYSTICK [24] upward or downward.

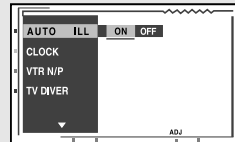

● Setting an option for the selected item

When the setting options for an item are listed on the right of the display, you can choose the desired option by operating the JOYSTICK [24] leftward or rightward. Then, press the center of the JOYSTICK [24] to set your choice.



● When "push NEXT" is displayed next to the menu item

1. Press the ENT at the center of the JOYSTICK [24] to select the item and show the setting display for this item.
2. Operate the JOYSTICK [24] upward or downward to select the desired setting option, then press ENT at the center of the JOYSTICK [24] to set your choice.

● Returning to the previous mode

Select the item "MENU" by operating the JOYSTICK [24] leftward or rightward, then press the ENT at the center of the JOYSTICK [24].

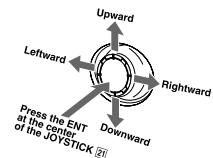
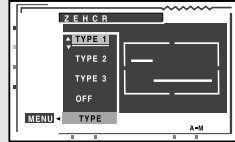

RADIO mode display

COLOR LCD DISPLAY

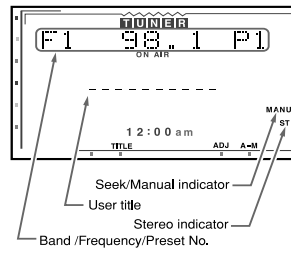

INFORMATION PANEL

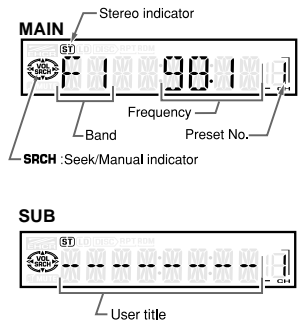

CD/MD Changer mode display

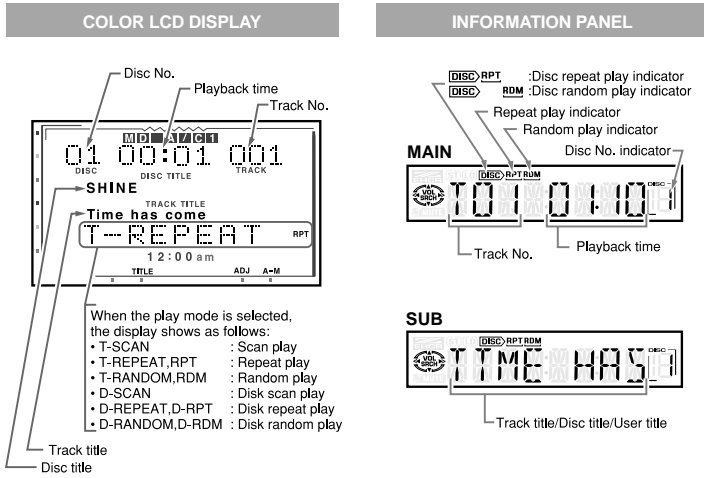

TV mode display

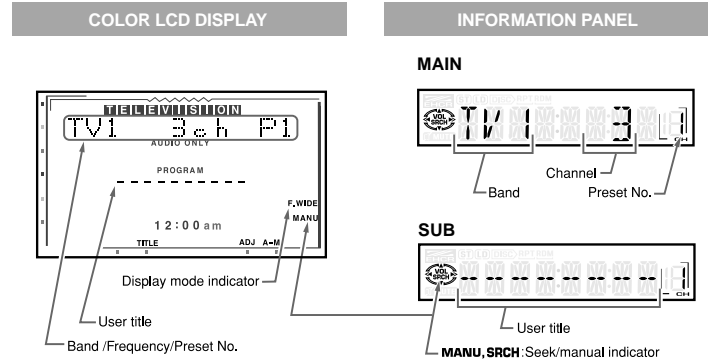

5. REMOTE CONTROL

Remote control unit

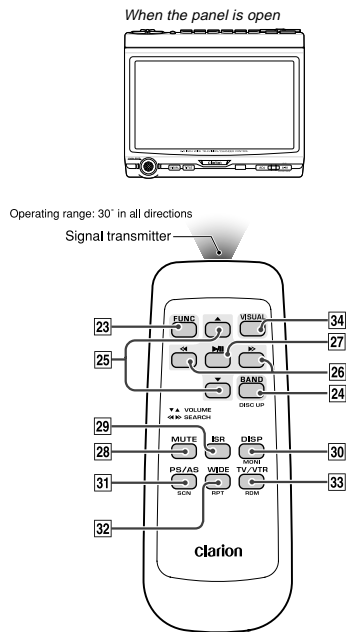

Inserting the Batteries

1. Turn the remote control unit over, then slide the rear cover in the direction of the arrow.
2. Insert the AA (SUM-3, IECR-6/1.5V) batteries that came with the remote control unit facing in the directions shown in the figure, then close the rear cover.

Notes:

- Using batteries improperly can cause them to explode. Take note of the following points:
- When replacing batteries, replace both batteries with new ones.
 - Do not short-circuit, disassemble or heat batteries.
 - Do not dispose of batteries into fire or flames.
 - Dispose of spent batteries properly.

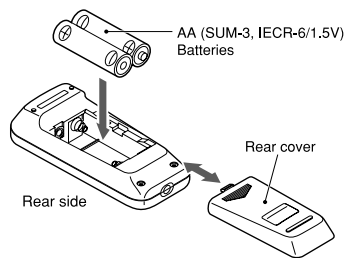

Functions of Remote Control Unit Buttons

Button	Mode	Radio	CD changer MD changer	TV
23	FUNC	Switches among Radio, CD changer, MD changer and TV.		
24	BAND DISC UP TOP	Switches reception band.	Moves to the next disc in increasing order.	Switches reception band.
25	VOLUME	Increases and decreases volume (in all modes).		
26	SEARCH	Moves preset channels up and down.	Moves tracks up and down. When pressed and held for 1 second: Fast-forward/ Fast-backward.	Moves preset channels up and down.
27	PLAY/PAUSE	No function.	Switches between playback and pause.	No function.
28	MUTE	Turns mute on and off.		
29	ISR	ISR on and off.		
30	DISP MONI	Turns on and off the monitor.		
31	PS/AS SCN	Preset scan. When pressed and held for 2 seconds: Auto store.	Scan play. When pressed and held for 1 second: Disc scan play.	Preset scan. When pressed and held for 2 seconds: Auto store.
32	WIDE RPT	No function.	Repeat play. When pressed and held for 1 second: Disc repeat play.	Switches TV display size. Switches the VISUAL mode.
33	TV/VTR RDM	No function.	Random play. When pressed and held for 1 second: Disc random play.	Switches between TV and VTR.
34	VISUAL	Switches the VISUAL mode.		

Notes:

- The remote control unit does not work when the panel is closed.
- Some of the corresponding buttons on the main unit and remote control unit have different functions.

6. DCP

The control panel can be detached to prevent theft. When detaching the control panel, store it in the DCP (DETACHABLE CONTROL PANEL) case to prevent scratches.

We recommend taking the DCP with you when leaving the car.

Removing the DCP

1. Turn the power off.
2. Deeply push in the DCP RELEASE lever  to release the DCP/Operation Panel.

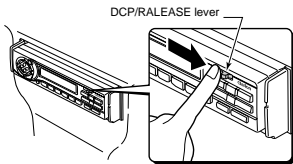

3. Pull the DCP toward you and remove it.

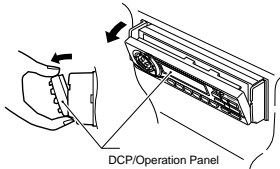

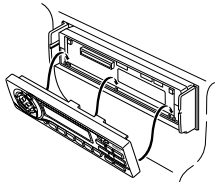

Attaching the DCP

1. Hold the DCP/Operation Panel with its rear side facing the main unit and, as shown in the figure below, put the lower edge of the panel onto the corresponding edge of the main unit.

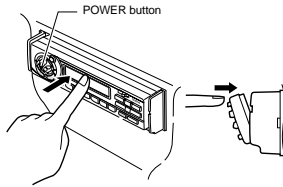

2. Lock the DCP/Operation Panel at the upper center until a click is heard.



3. Press the power button  to turn on the power .

* The unit will not accept any key inputs for 1 second after the DCP has been reattached.

CAUTION

- The DCP can easily be damaged by shocks. After removing it, be careful not to drop it or subject it to strong shocks.
- If the Operation Panel is kept open, the DCP may drop due to vibration of the car. This results in damage to the DCP. So close the Operation Panel or remove the DCP to store into the case.
- The connector connecting the main unit and the DCP is an extremely important part. Be careful not to damage it by pressing on it with fingernails, screwdrivers, etc.

Note:

- If the DCP is dirty, wipe off the dirt with a soft, dry cloth only.

7. CAUTIONS ON HANDLING

LCD panel/Generalities

For a longer service life, be sure to read the following cautions.

- Be sure to store the LCD panel inside the main unit when parking the car outdoors for long period of time. The LCD panel will operate properly in a temperature range of 0 to 60°C.
- Don't allow any liquids on the set from drinks, umbrellas etc. Doing so may damage the internal circuitry.
- Do not disassemble or modify the set in any way. Doing so may result in damage.
- Do not draw the LCD panel out and use it as a tray. Also, subjecting the LCD panel to shocks may result in breakage, deformation or other damage.
- Do not let cigarettes burn the display. Doing so may damage or deform the cabinet.
- If a problem should occur, have the set inspected at your store of purchase.
- Do not insert objects or poke in the space between the LCD panel and the main unit when the panel is tilted.
- Do not place anything on the display when the panel is tilted.
- The remote controller may not work if the remote control sensor is exposed to direct sunlight.
- In extremely cold weather, the display movement may slow down and the display may darken, but this is not a malfunction. The display will work normally when the temperature increases.
- Small black and shiny spots inside the LCD panel are normal for LCD products.
- The LCD panel may stop temporarily when it opens or closes, when the engine stops or when it is cold.

Cleaning

Cleaning the cabinet

Use a soft, dry cloth and gently wipe off the dirt. For tough dirt, apply some neutral detergent diluted in water to a soft cloth, wipe off the dirt gently, then wipe again with a dry cloth.

Do not use benzene, thinner, car cleaner, etc., as these substances may damage the cabinet or cause the paint to peel. Also, leaving rubber or plastic products in contact with the cabinet for long periods of time may cause stains.

Cleaning the LCD panel

The LCD panel tends to collect dust, so wipe it off occasionally with a soft cloth. The surface is easily scratched, so do not rub it with hard objects.

8. OPERATIONS

Basic Operations

Note: Be sure to read this chapter referring to the front diagrams of chapter "2. CONTROLS" on page 5 (unfold).

CAUTION

When the unit is turned on, starting and stopping the engine with its volume raised to the maximum level may harm your hearings. Be careful about adjusting the volume.

Note:

- Use this unit after starting the engine.



Turning on and off the power

Note:

• Be careful about using this unit for a long time without running the engine. If you drain the car's battery too far, you may not be able to start the engine and this can reduce the service life of the battery.

1. Press the POWER button [1].
2. The illumination and display on the unit light up. The unit automatically remembers its last operation mode and will automatically switch to display that mode.
3. Press and hold the POWER button [1] for 1 second or longer to turn off the power for the unit.

Note:

• About the "SYSTEM CHECK"

The confirmation of connected equipment must be performed for this unit only when the wiring connection is complete and power is turned on to the unit first. When the power is supplied, "SYSTEM" and "PUSH PWR" appear alternately in the display. Press the POWER button [1], the system check starts inside the unit. When "COMPLETE" appears, press once again the POWER button [1].

Selecting a mode

1. Press the FUNC button [1] to change the mode of operation.
2. Each time you press the FUNC button [1], the mode of operation changes in the following order:

Radio mode → CD changer mode → MD changer mode → TV mode → Radio mode...

- * External equipment not connected with CeNET is not selected.

Adjusting the volume

Operate the VOLUME button [2] in the direction of the arrows ▲ (up) or ▼ (down) to adjust the volume;

▲: Increases the volume.

▼: Decreases the volume.

- * The volume level indicated in the display is in a range from 0 (minimum) to 33 (maximum).

CAUTION

While driving, keep the volume at a level at which external sounds can be heard.

Switching the display

When the panel is closed:

Press the DISP button [12] to select the desired display.

Each time you press the DISP button [12], the display switches in the following order:

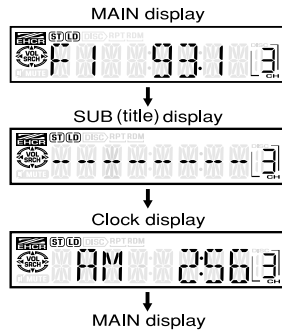

Notes:

- Once selected, the preferred display becomes the default display. When a function adjustment such as volume is made, the display momentarily switches to that function's display, then returns back to the preferred display several seconds after the adjustment.

Basic Operations

- If a title has been input, it is shown in the SUB display. If no title has been input, "-----" appears in the display. To input a title, refer to the subsection "Entering titles" in "Other Functions" section.
- Some special characters of the title, will not be displayed on the Information Panel of the DCP. In this case, those characters will only be left blank.

Showing a mode display

When the panel is open:

Press the TITLE button [9] to show the Title List display. In the Title List display, the titles of items stored in the PRESET buttons [13] 1 to 6 are listed.

- * For detailed information, refer to the section "Title list play".

Opening and turning the display

Notes:

- Do not place any object on the open display.
- Do not drop any object on the movable part.
- Do not expose the display to shocks.

1. Press the OPEN button [11] to open the Color LCD display [16].

- * If the Color LCD display [16] is left horizontally in the open position for 10 seconds or longer, it is automatically drawn in.

2. Turn the Color LCD display [16] upwards to a good view angle.

When the monitor is turned upwards, a picture appears in the display. The Information Panel [4] display disappears.

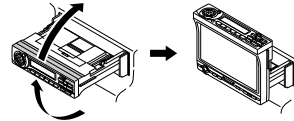

CAUTION

Do not turn the display unless it is completely open.

When adjusting the angle of the display be careful no to let your fingers get caught by the panel or instrument panel of the vehicle.

3. To store the Color LCD display [16] in the source unit, turn it to the horizontal position until a click is heard.

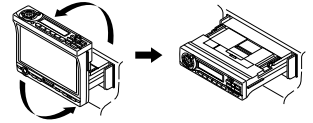

Turning on and off the monitor

Pressing the DISP button [12] turns the monitor on and off.

- * When a button is pressed or during security monitoring, the monitor-off mode is canceled.

Mute

Each time you press the MUTE button [14], mute is turned on and off.

"MUTE" appears when mute is turned on.

Setting the Z-enhancer

This unit comes with 3 types of sound tone effect stored in memory. Select the one you prefer.

* The factory default setting is "Z-EHCR OFF". When a Z-enhancer comes on (1-3), "Z-EHCR" appears in the display.

- "Z-EHCR 1" (Z-Enhancer 1): Setting emphasizing bass.
- "Z-EHCR 2" (Z-Enhancer 2): Setting emphasizing treble.
- "Z-EHCR 3" (Z-Enhancer 3): Setting emphasizing bass and treble.
- "Z-EHCR OFF" (Z-Enhancer off): Neither bass nor treble are emphasized by the Z-enhancer.

Note:

- Incapable of operation when connecting DSP (DPH7500z/7700z).

When the panel is closed:

Each time you press the Z-EHCR button [9], the tone effect changes in the following order:

"Z-EHCR 1" → "Z-EHCR 2" → "Z-EHCR 3" → "Z-EHCR OFF" → "Z-EHCR 1"...

When the panel is open:

1. Press the A-M button [17] to change into the AUDIO-MODE display.
2. Operate the JOYSTICK [21] upward or downward to select "Z-EHCR". Press the ENT at the center of the JOYSTICK [21] to change into the Z-enhancer selecting display.
3. Operate the JOYSTICK [21] upward or downward to select out of:
"TYPE 1" (Z-Enhancer 1) ↔ "TYPE 2" (Z-Enhancer 2) ↔ "TYPE 3" (Z-Enhancer 3) ↔ "OFF" (Z-Enhancer off),
and press the ENT at the center of the JOYSTICK [21] to set a desired Z-enhancer.
4. When the setting is finished, operate the JOYSTICK [21] rightward or leftward to move the cursor to the "MENU". Then press the ENT at the center of the JOYSTICK [21] to return to the AUDIO-MODE display.

* To return from the AUDIO-MODE display to the STANDARD display, press the A-M button [17] once again.

Adjusting the Z-enhancer**Note:**

* This function is enabled only when the panel is open.

1. Press the A-M button [17] to change into the AUDIO-MODE display.
2. Operate the JOYSTICK [21] upward or downward to select "Z-EH LVL" level. Press the ENT at the center of the JOYSTICK [21] to change into the Z-enhancer adjusting display.
3. Operate the JOYSTICK [21] upward or downward to adjust the Z-enhancer level.
 - * When Z-Enhancer 1 is selected, you can adjust the bass in the range of ±2.
 - * When Z-Enhancer 2 is selected, you can adjust the treble in the range of ±2.
 - * When Z-Enhancer 3 is selected, you can adjust the bass and treble in the range of ±2.
4. When the adjustment is finished, operate the JOYSTICK [21] rightward or leftward to move the cursor to "MENU". Then press the ENT at the center of the JOYSTICK [21] to return to the AUDIO-MODE display.

Adjusting the bass and treble**Notes:**

- * This function is enabled only when the panel is open.
- * This function can be adjusted only when the Z-enhancer is OFF.

1. Press the A-M button [17] to change into the AUDIO-MODE display.
2. Operate the JOYSTICK [21] upward or downward to select "BAS/TRE". Then press the ENT at the center of the JOYSTICK [21] to change into the BASS/TREBLE adjusting display.
3. Operate the JOYSTICK [21] rightward or leftward to adjust the "BASS" or "TREBLE".
4. Operate the JOYSTICK [21] upward or downward to adjust a level (adjustment range: from -6 to 6).
5. When the adjustment is finished, operate the JOYSTICK [21] rightward or leftward to move the cursor to "MENU". Then press the ENT at the center of the JOYSTICK [21] to return to the AUDIO-MODE display.

Adjusting the balance and fader**Note:**

* This function is enabled only when the panel is open.

1. Press the A-M button [17] to change into the AUDIO-MODE display.
2. Operate the JOYSTICK [21] upward or downward to select "BAL/FAD". Then press the ENT at the center of the JOYSTICK [21] to change into the BAL/FAD adjusting display.
3. Operate the JOYSTICK [21] rightward or leftward to select "BALANCE" or "FADER".
4. Operate the JOYSTICK [21] upward or downward to make an adjustment.
Adjusting range of the balance: L13 to R13
Adjusting range of the fader: front 12 / rear 12
5. When the adjustment is finished, operate the JOYSTICK [21] rightward or leftward to move the cursor to "MENU". Then press the ENT at the center of the JOYSTICK [21] to return to the AUDIO-MODE display.

Turning on/off the loudness

The loudness effect emphasizes the bass and treble to create a natural sound tone. When you are listening to music at a low volume, it is recommended to use the loudness effect.

* This function is enabled only when the panel is open.

1. Press the A-M button [17] for 1 second or longer to select Loudness ON. The "LD" indicator lights in the display.
2. Press the A-M button [17] for 1 second or longer to select Loudness OFF. The "LD" indicator goes off.

Note:

* When using a sold separately digital sound processor (DPH7500z/7700z), a feature called auto loudness is selected. This function is different from the loudness effect. For further details on the auto loudness feature, refer to the subsection "Output adjustment of auto loudness, subwoofer and playback band".

Radio Operations

FM reception

For enhanced FM performance the **MAGI-TUNE**® tuner includes signal actuated stereo control, Enhanced Multi AGC, Impulse noise reduction circuits and Multipath noise reduction circuits.

Changing the reception area

This unit is initially set to USA frequency intervals of 10kHz for AM and 200kHz for FM. When using it outside the USA, the frequency reception range can be switched to the intervals below.

● Setting the reception area

While pressing DISP button [2], each time you press and hold the number "6" of the PRESET buttons [13] for 2 seconds or longer, the reception area switches from inside the USA to outside the USA or from outside the USA to inside the USA.

* Any station preset memories are lost when the reception area is changed.

Listening to the radio

1. Press the FUNC button [1] and select the RADIO mode.
2. Press the BAND button [5] and select the radio band. Each time the button is pressed, the radio reception band changes in the following order:
FM1 → FM2 → FM3 → AM → FM1...
3. Press the right or left side of the SEARCH button [2] to tune in the desired station.

Tuning

There are 3 types of tuning mode available, seek tuning, manual tuning and preset tuning.

Seek tuning

1. Press the BAND button [5] and select the desired band. (FM or AM)
* If "MANU" is lit in the display (or when the panel is closed, if the indicator "SRCH" is not lit) press and hold the BAND button [5] for 1 second or longer. "MANU" in the display goes off (or when the panel is open the indicator "SRCH" lights) and seek tuning is now available.

2. Press the right or left side of SEARCH button [2] to automatically seek a station. When the right side of SEARCH button [2] is pressed, the station is sought in the direction of higher frequencies; if the left side of SEARCH button [2] is pressed, the station is sought in the direction of lower frequencies.

Manual tuning

There are 2 ways available: Quick tuning and step tuning.

When you are in the step tuning mode, the frequency changes one step at a time. In quick tuning mode, you can quickly tune the desired frequency.

1. Press the BAND button [5] and select the desired band. (FM or AM)
* If "MANU" is not lit in the display (or when the panel is closed, if the indicator "SRCH" is lit), press and hold the BAND button [5] for 1 second or longer. "MANU" appears in the display (or when the panel is closed, the indicator "SRCH" goes off) and manual tuning is now available.
2. Tune into a station.
● **Quick tuning:**
Press and hold the right or left side of the SEARCH button [2] for 1 second or longer to tune in a station.
● **Step tuning:**
Press the right or left side of the SEARCH button [2] to manually tune in a station.

Recalling a preset station

A total of 24 preset positions (6-FM1, 6-FM2, 6-FM3, 6-AM) exists to store individual radio stations in memory. Pressing the corresponding PRESET buttons [13] recalls the stored radio frequency automatically.

1. Press the BAND buttons [5] and select the desired band. (FM or AM)
2. Press the corresponding PRESET buttons [13] to recall the stored station.
* Press and hold one of the PRESET buttons [13] for 2 seconds or longer to store that station into preset memory.

Radio Operations

Manual memory

1. Press the BAND button [5] and select the desired band. (FM or AM)
2. Select the desired station with seek tuning, manual tuning, or preset tuning.
3. Press and hold one of the PRESET buttons [13] for 2 seconds or longer to store the current station into preset memory.

Auto store

Auto store is a function for storing up to 6 stations that are automatically tuned in sequentially. If 6 receivable stations cannot be received, a previously stored station remains unoverwritten at the memory position.

1. Press the BAND button [5] and select the desired band. (FM or AM)
2. Press and hold the PS/AS button [5] for 2 seconds or longer. The stations with good reception are stored automatically to the preset channels.

Preset scan

Preset scan receives the stations stored in preset memory in order. This function is useful when searching for desired station in memory.

1. Press the PS/AS button [5].
2. When the desired station is tuned in, press the PS/AS button [5] again to continue receiving that station.

Note:

• Be careful not to press and hold PS/AS button [5] for 2 seconds or longer, otherwise the auto store function engages and the unit starts storing stations.

Instant station recall (ISR)

Instant station recall is a special radio preset that instantly accesses a favorite radio station at a touch of a button. The ISR function even operates with the unit in other modes.

● ISR memory

1. Select the station that you wish to store in ISR memory.
2. Press and hold ISR button [10] for 2 seconds or longer.

● Recalling a station with ISR

In any mode, press ISR button [10] to turn on the radio function and tune the selected radio station. "ISR" appears in the display. Press ISR button [10] again to return to the previous mode.

CD Changer Operations

CD changer functions

When an optional CD changer is connected through the CeNET cable, this unit controls all CD changer functions. This unit can control a total of 2 changers (MD and/or CD).

Press the FUNC button [1] and select the CD changer mode to start play. If 2 CD changers are connected, press the FUNC button [1] to select the CD changer for play.

* If "NO MAG" appears in the display, insert the magazine into the CD changer. "LOADING" appears in the display while the player loads (checks) the magazine.

* If "NO DISC" appears in the display, eject the magazine and insert discs into each slot. Then, reinsert the magazine back into the CD changer.

CAUTION

CD-ROM discs cannot be played in the CD changer.

Pausing play

1. Press the PLAY/PAUSE button [3] to pause play. "PAUSE" appears in the display.
2. To resume play, press the PLAY/PAUSE button [3] again.

Displaying CD titles

This unit can display title data for CD-text CDs and user titles input with this unit.

Each time you press and hold the DISP button [12] for 1 second or longer, the title display changes in the following order.

When the panel is closed:

User title (disc) → CD-text title (disc) → CD-text title (track) → User title (disc)...

When the panel is open:

User title (disc) → CD-text title (disc & track) → User title (disc)...

Note:

* If the CD playing is not a CD-text CD or no user title has been input, "-----" appears in the display.

● Scrolling a CD-text title

When a CD-text title is longer than 16 characters (8 characters when the panel is closed), you can scroll the display as follows.

When the panel is closed:

1. Display the CD-text title (disc or track).
2. Press and hold the BAND button [15] for 1 second or longer. The titles scroll.

When the panel is open:

1. Display the CD-text title (disc & track).
2. Press and hold the TITLE button [19] for 1 second or longer to scroll the disc title.
3. To scroll the track title, press for 1 second or longer the TITLE button [19] within 30 seconds after scrolling the disc title.

Notes:

- If the disc title is shorter than 16 characters, the track titles begin to scroll immediately.
- If the track title is shorter than 16 characters, the track titles does not scroll.

Selecting a CD

Each of the DIRECT buttons [13] corresponds to a disc loaded into the magazine.

● Selecting a disc from 1 to 6

Press the corresponding DIRECT buttons (1 to 6) [13] to select the desired disc.

● Selecting a disc from 7 to 12 (only when a 12 disc CD changer is used.)

Press the corresponding DIRECT buttons (7 to 12) [13] for 1 second or more, then select the desired disc.

Selecting a track

● Track-up

1. Press the right side of the SEARCH button [2] to move ahead to the beginning of the next track.
2. Each time you press the right side of the SEARCH button [2], the track advances ahead to the beginning of the next track.

● Track-down

1. Press the left side of the SEARCH button [2] to move back to the beginning of the current track.
2. Press the left side of the SEARCH button [2] twice to move to the beginning of the previous track.

Fast-forward/Fast-backward

● Fast-forward

Press and hold the right side of the SEARCH button [2] for 1 second or longer.

● Fast-backward

Press and hold the left side of the SEARCH button [2] for 1 second or longer.

Top function

The top function plays from the first track (track No. 1) of the disc.

● When playing a disc 1 to 6

Press the DIRECT buttons [13] (1 to 6) with the same number as the CD playing.

● When playing a disc 7 to 12 (only when a 12 disc CD changer is used.)

Press the DIRECT buttons [13] (7 to 12) with the same number as the CD playing for 1 second or longer.

Scan play

The scan play locates and plays the first 10 seconds of each track on a disc automatically. This function continues on the disc until it is cancelled or the mode is changed.

* The scan play is useful when you want to select a desired track.

1. Press the SCN button [5] to start scan play.
2. Press the SCN button [5] again to cancel the scan play. Current track continues to play.

Disc scan play

The disc scan play locates and plays the first 10 seconds of the first track on each disc in the currently selected CD changer. This function continues automatically until it is cancelled or the mode is changed.

* The disc scan play is useful when you want to select a desired CD.

1. Press the SCN button [5] for 1 second or longer to start disc scan play.
2. Press the SCN button [5] again to cancel disc scan play. Normal disc play continues on the current track.

CD Changer Operations

Repeat play

The repeat play continuously plays the current track. This function continues automatically until it is cancelled or the mode is changed.

1. Press the RPT button [7], to make repeat play starts. "RPT" lights in the display.
2. To cancel repeat play, press the RPT button [7] again. "RPT" goes off from the display and the unit returns to normal play.

Disc repeat play

After all tracks in the current disc have been played, the disc repeat play automatically replays the current disc over from the first track. This function continues automatically until it is cancelled or the mode is changed.

1. When you press the RPT button [7] for 1 second or longer, disc repeat play starts. "D-RPT" lights in the display.
2. To cancel disc repeat play, press the RPT button [7] again. "D-RPT" goes off from the display and the unit returns to normal play from the track being played.

Random play

The random play selects and plays individual tracks on the disc in no particular order. This function continues automatically until it is cancelled or the mode is changed.

1. When you press the RDM button [8], random play starts. "RDM" lights in the display.
2. To cancel random play, press the RDM button [8] again. "RDM" goes off from the display and the unit returns to normal play.

Disc random play

The disc random play selects and plays individual tracks or discs automatically in no particular order. This function continues automatically until it is cancelled or the mode is changed.

1. When you press the RDM button [8] for 1 second or longer, disc random play starts. "D-RDM" lights in the display.
2. To cancel disc random play, press the RDM button [8] again. "D-RDM" goes off from the display and the unit returns to normal play from the track being played.

MD Changer Operations

MD changer functions

When an optional MD changer is connected through the CeNET cable, this unit controls all MD changer functions. This unit can control a total of 2 changers (MD and/or CD).

Press the FUNC button [1] and select the MD changer mode to start play. If 2 MD changers are connected, press the FUNC button [1] to select the MD changer for play.

* If "NO DISC" appears in the display, load MDs into the MD changer.

Pausing play

1. Press the PLAY/PAUSE button [3] to pause play. "PAUSE" appears in the display.
2. To resume play, press the PLAY/PAUSE button [3] again.

Switching disc titles and track titles

This unit can display disc titles and track titles already entered on MDs. Titles up to 128 characters long can be displayed by scrolling the titles.

* Titles cannot be entered for MDs with this unit.

When the panel is closed:

1. Press the DISP button [12] to show the SUB display. The disc title or track title is displayed.
2. Each time you press and hold the DISP button [12] for 1 second or longer, the display toggles between the disc title and the track title.

When the panel is open:

Both disc and track titles are displayed.

Scrolling titles

When a title is longer than 16 characters (or 8 characters if the panel is closed), you can scroll through it with the following operation.

When the panel is closed:

1. Display the MD title (disc or track).
2. Press the BAND button [15] for 1 second or longer. The display scrolls through the title.

When the panel is open:

1. Press the TITLE button [19] for 1 second or longer to scroll through the disc title.
2. To scroll the track title, press for 1 second or longer the TITLE button [19] within 30 seconds after scrolling the disc title.

Notes:

- When the disc title is within 16 characters, the title is scrolled immediately.
- If the track title is shorter than 16 characters, the track titles does not scroll.

Selecting an MD

Each of the DIRECT buttons [13] corresponds to an MD loaded into the MD changer.

Press the DIRECT buttons [13] (1 to 6) and select the desired MD.

Selecting a track

● Track-up

1. Press the right side of the SEARCH button [2] to move ahead to the beginning of the next track.
2. Each time you press the right side of the SEARCH button [2], the track advances ahead to the beginning of the next track.

● Track-down

1. Press the left side of the SEARCH button [2] to move back to the beginning of the current track.
2. Press the left side of the SEARCH button [2] twice to move to the beginning of the previous track.

Fast-forward/Fast-backward

● Fast-forward

Press and hold the right side of the SEARCH button [2] for 1 second or longer.

● Fast-backward

Press and hold the left side of the SEARCH button [2] for 1 second or longer.

Top function

The top function plays from the first track (track No. 1) of the disc.

Press the DIRECT buttons [13] (1 to 6) with the same number that the MD playing.

* If an MD is not loaded in a slot of the MD changer, pressing the DIRECT buttons [13] corresponding to its disc number is invalid.

MD Changer Operations

Scan play

The scan play locates and plays the first 10 seconds of each track on a disc automatically. This function continues on the disc until it is cancelled or the mode is changed.

* The scan play is useful when you want to select a desired track.

1. When you press the SCN button [5], scan play starts.
2. Press the SCN button [5] again to cancel the play. Current track continues to play.

Disc scan play

The disc scan play locates and plays the first 10 seconds of the first track on each disc in the currently selected MD changer. This function continues automatically until it is cancelled or the mode is changed.

* The disc scan play is useful when you want to select a desired MD.

1. When you press the SCN button [5] for 1 second or longer, disc scan play starts.
2. To cancel disc scan play, press the SCN button [5] again. Normal disc play continues on the current track.

Repeat play

The repeat play continuously plays the current track. This function continues automatically until it is cancelled or the mode is changed.

1. When you press the RPT button [7], repeat play starts. "RPT" lights in the display.
2. To cancel repeat play, press the RPT button [7] again. "RPT" goes off from the display and the unit returns to normal play.

Disc repeat play

After all the tracks on the current disc have been played, the disc repeat play automatically replays the current disc over from the first track. This function continues automatically until it is cancelled or the mode is changed.

1. When you press the RPT button [7] for 1 second or longer, disc repeat play starts. "D-RPT" lights in the display.
2. To cancel disc repeat play, press the RPT button [7] again. "D-RPT" goes off from the display and the unit returns to normal play from the track being played.

Random play

The random play selects and plays individual tracks on the disc in no particular order. This function continues automatically until it is cancelled or the mode is changed.

1. When you press the RDM button [8], random play starts. "RDM" lights in the display.
2. To cancel random play, press the RDM button [8] again. "RDM" goes off from the display and the unit returns to normal play.

Disc random play

The disc random play selects and plays individual tracks or discs automatically in no particular order. This function continues automatically until it is cancelled or the mode is changed.

1. When you press the RDM button [8] for 1 second or longer, random play starts. "D-RDM" lights in the display.
2. To cancel random play, press the RDM button [8] again. "D-RDM" goes off from the display and the unit returns to normal play from the track being played.

TV Operations

TV functions

When an optional TV tuner is connected through the CeNET cable, this unit controls all TV tuner functions. To watch TV requires a TV tuner.

⚠ WARNING

For your safety, the driver should not watch the TV or operate the controls while driving. Please note that watching and operating the TV while driving are prohibited by law in some countries.

Watching TV

Notes:

• For your safety, this unit has a safety function which turns off the picture when the car is moving, so only the audio can be heard. The picture can only be watched when the car is stopped and the parking break is applied.

1. Press the FUNC button [1] and select the TV mode.
2. Press the BAND button [5] to select the desired TV band (TV1 or TV2). Each time the button is pressed, the input selection toggles between TV1 and TV2.
3. Press the right or left side of the SEARCH button [2] to tune in the desired TV station.

Watching a video

The TV tuner has a VTR input terminal to which 1 external device can be connected. Connect a 12V video cassette player (VCP) or video cassette recorder (VCR) to the TV tuner input terminal.

1. Press the RDM button [8] and select the VTR.
2. To return to the TV broadcast, press the RDM button [8] again.

Tuning

There are 3 types of tuning mode available, seek tuning, manual tuning and preset tuning.

Seek tuning

1. Press the BAND button [5] and select the desired TV band (TV1 or TV2).
 - * If "MANU" is lit in the display (or when the panel is closed, if the indicator "SRCH" is not lit),

press and hold the BAND button [5] for 1 second or longer. "MANU" in the display goes off (or when the panel is closed, the indicator "SRCH" lights) and seek tuning is now available.

2. Press the right or left side of the SEARCH button [2] to automatically seek a station. Press the right side of the SEARCH button [2] to automatically tune up the frequency band to the next available TV station; press the left side to automatically tune down.

Manual tuning

There are 2 ways available: Quick tuning and step tuning. When you are in the step tuning mode, the frequency changes one step at a time. In quick tuning mode, you can quickly tune the desired frequency.

1. Press the BAND button [5] and select the desired band. (TV1 or TV2)
 - * If "MANU" is not lit in the display (or when the panel is closed, if the indicator "SRCH" is lit), press and hold the BAND button [5] for 1 second or longer. "MANU" appears in the display (or when the panel is closed, the indicator "SRCH" goes off) and manual tuning is now available.
2. Tune into a station.

● Quick tuning:

Press and hold the right or left side of the SEARCH button [2] for 1 second or longer to tune in a station.

● Step tuning:

Press the right or left side of the SEARCH button [2] to manually tune in a station.

Note:

• Manual tuning is cancelled if you do not operate the unit for 7 seconds longer.

Recalling a preset station

A total of 12 TV stations can be stored (6-TV1 and 6-TV2). This allows you to select your favorite TV stations and store them in memory for later recall.

1. Press the BAND button [5] and select the desired TV band. (TV1 or TV2)
2. To recall a stored TV station, press the desired PRESET buttons [3] to select that station.
 - * Press and hold one of the PRESET buttons [3] for 2 seconds or longer to store the current station into the preset memory.

TV Operations

Manual memory

1. Select the desired station with seek tuning, manual tuning or preset tuning.
2. Press and hold one of the PRESET buttons [3] for 2 seconds or longer to store the current station to that preset memory.

Auto store

Auto store selects 6 TV stations automatically and stores each one into a preset memory.

If there are not 6 stations with good reception, stations previously stored in memory remain and only the strong stations are stored into memory.

1. Press the BAND button [5] and select the desired TV band. (TV1 or TV2)
2. Press and hold the AS/PS button [5] for 2 seconds or longer. The stations with good reception are automatically stored to the PRESET buttons [3].

Preset scan

Preset scan allows the user to view each preset position before it automatically advances to the next preset. This function is useful for searching for desired TV station in memory.

1. Press the AS/PS button [5].
2. When the desired channel is received, press the AS/PS button [5] again.

Switching the VTR system between NTSC and PAL

* This function is enabled only when the panel is open.

Switch to the VTR mode you use.

1. Press the ADJ button [8] to switch to the adjustment selection display.
2. Operate the JOYSTICK [2] upward or downward to move the cursor to "VTR N/P".
3. Operate the JOYSTICK [2] rightward or leftward to move the cursor to select "NTSC" or "PAL".
4. Press the ENT at the center of the JOYSTICK [2] to set the selected VTR mode.

Setting the TV diver

* This function is enabled only when the panel is open.

* Normally use the TV diver with the "ON" position. You can change the reception setting for the TV antenna connected to the TV tuner.

1. Press the ADJ button [8] to switch to the adjustment selection display.
2. Operate the JOYSTICK [2] upward or downward to select "TV DIVER".
3. Operate the JOYSTICK [2] rightward or leftward to select "ON" or "OFF" and press the ENT at the center of the JOYSTICK [2] to set the selected reception setting.
 - ON:
Sets reception emphasizing the visual.
 - OFF:
Sets the diver setting to OFF.
4. Press the ADJ button [8] return to the previous mode.

TV Operations

Adjusting the brightness and tone of color

Notes:

- This operation is available only when the car is stopped and the parking brake is applied.
- This function is not available when the display is stored.
- The HUE setting can be adjusted only when the NTSC mode is selected.

1. Press the ADJ button [18] to switch to the adjustment selection display.
2. Operate the JOYSTICK [21] upward or downward to select the option "MONI ADJ" (by moving the cursor).
3. Press the ENT at the center of the JOYSTICK [21].
4. Operate the JOYSTICK [21] rightward or leftward to select "BRIGHT", "COLOR" or "HUE" (by moving the cursor).
 - "BRIGHT":
Adjust the brightness of the display.
 - "COLOR":
Adjusts the color saturation.
 - "HUE":
Adjusts the tone of color (red is emphasized or green is emphasized.)
5. Operate the JOYSTICK [21] upward or downward to adjust a level.
6. When the adjustment is made, operate the JOYSTICK [21] rightward or leftward to move the cursor to "MENU". Then press the ENT at the center of the JOYSTICK [21] to return to the adjustment selection display.

Changing over TV display size

- * This function is available only when the panel is open.

Press the WIDE button [7] to change over the TV display size. Each time you press the WIDE button [7], the TV display size changes in the following order:

"NORMAL" → "WIDE" → "F. WIDE" → "CINEMA" → "NORMAL"

- "NORMAL": (normal display)

There is a black area at both right and left ends of a display. In case of normal TV broadcasting (4:3), the image can be shown without being cut or deformed.

- "WIDE": (wide mode)

The image at right and left ends in a display elongates horizontally.

- "F. WIDE": (full wide mode)

The whole image elongates horizontally.

- "CINEMA": (cinema mode)

The image at both top and bottom in a display disappears.

Notes:

- When a normal 4:3 size image, not being a wide one, is viewed by displaying it fully on a wide TV display in a wide mode or a full-wide mode, a part of the peripheral image will be lacking or deformed. In deference to the intention of producer, an original image can be viewed in a normal mode.
- During superimposed display, it becomes a full-wide mode.

Rear Vision Camera

Monitoring the rear vision camera

The rear vision camera can be connected to this unit. For the power supply of the camera, mount the power box sold separately (CAA-147).

Notes:

- This function is not available when the display is stored.

Operation of External Visual Devices (VISUAL Mode)

External visual devices such as DVD and VTR devices can be connected to the DIN 8-pin terminal, and the image and sound can then be played using VISUAL mode.

Notes:

- While driving, the image of the VISUAL Mode is turned OFF and only sound is played.
 - Images can only be played when the vehicle is stationary with the parking brake ON.
1. With the panel open, push VISUAL button [20] to switch from radio, TV, CD/MD changer mode to VISUAL mode.
 2. To exit VISUAL Mode and return to the previous mode, press VISUAL button [20] again.
 - * The image format played in VISUAL mode can be set to NTSC or PAL format. The setting method is the same as for the TV. Please refer to the TV explanation.
 - * In VISUAL mode, the picture quality can be adjusted. The setting method is the same as for the TV. Please refer to the TV explanation.

Switching to Composite Screen

- * The display panel can be switched to a composite screen to lock the monitor or to view a video CD.
1. When the panel is open, press the OPEN/M.LOCK button [11] to switch to the composite screen.
 2. When the panel is open and the composite screen is shown, press the OPEN/M.LOCK button [11] again to return to the previous screen.

Other Functions

Always turning on the button illumination on the operation panel

Note:

* The following operation is enabled when the panel is open.

The button illumination on the operation panel when the display is turned upward, can be switched between "ON" and "OFF".

● "ON": Button illumination on the operation panel turns on for 5 seconds;

● "OFF": Button illumination is always on when the power is turned on;

1. When the panel is open, press the ADJ button [18] to show the adjustment selection display.
2. Operate the JOYSTICK [21] upward or downward and select "AUTO ILL" to show "ON" and "OFF" in the menu bar.
3. Operate the JOYSTICK [21] rightward or leftward to select either position to be set and press the ENT at the center of the JOYSTICK [21] for setting.
4. Press the ADJ button [18] to return to the previous mode.
 - * To set "ON" again, switch "OFF" to "ON" manually.

Entering titles

Titles up to 10 characters long can be stored in memory and displayed. The numbers of titles that can be entered for each mode are as follows.

Mode	Number of titles
Radio mode	30 titles
TV mode	15 titles

CD changer mode	Number of titles
CDC655z connected	60 titles
CDC655Tz connected	100 titles
CDC1255z connected	50 titles

* You cannot enter titles with the unit in Seek, Preset Scan, Auto store (TUNER, TV), Scan, Repeat or Random (CD changer, MD changer) mode. Cancel each of those operations before entering titles.

1. Press the FUNC button [1] to select the mode you want to enter a title (CD changer or TV).
2. Select and play a CD in the CD changer or tune in to a TV station for which you want to enter the title.
3. If you press and hold the TITLE button [19] for 1 second or longer, the display switches to the title input mode display.

4. Operate the JOYSTICK [21] upward or downward, rightward or leftward and move the cursor to the character to be entered. Press the ENT at the center of the JOYSTICK [21].

* When the cursor is at the lower/upper limit of the display, operate the JOYSTICK [21] upward or downward, the character string of the following line appears.

"-->" : Space
 "<--" : Backspace
 "--|--" : Centering

5. Repeat the step 4 to enter the complete title.
6. Press and hold the ENT at the center of the JOYSTICK [21] for 2 seconds or longer to store the title into memory and cancel title input mode.

Title list play

You can display a list of titles, then select the disc or broadcast station to listen to from that list.

* You can not display a title list with the unit in Seek, Preset Scan, Auto store (Tuner or TV), Scan, Repeat or Random (CD changer or MD changer) mode. Cancel those operation modes before to display a title list.

1. With the unit in radio, CD/MD changer, TV, press the TITLE button [19]. A title list is displayed. The following functions can be carried out in a title list display.

● **TUNER:** A title of a channel stored in the presets 1 to 6 or a channel number is displayed.

● **CD/MD changer:** DISC titles for discs 1 to 6 are displayed (By changing over a display page in case of 12-CD changer, disc 7 to 12 can be displayed). When there is not any disc in a changer, "-----" is displayed.

● **TV:** A title of a channel stored in the presets 1 to 6 or a channel number is displayed.

2. Operate the JOYSTICK [21] upward or downward to select one of the items 1 to 6. Press ENT at the center of the JOYSTICK [21] to reproduce the selected broadcast station or disc.

* In case of 12-CD changer, move the cursor to disc 6 and then operate the JOYSTICK [21] downward to change over to a list display of discs 7 to 12.

3. Press the TITLE button [19] again to return to the STANDARD display.

Other Functions

Clock Adjustment

1. Press the ADJ button [18] to display the adjustment selection display.
2. Move the JOYSTICK [21] up or down to select CLOCK, then press ENT at the center of the JOYSTICK [21] to display the clock adjustment display.
3. Move the JOYSTICK [21] left or right to select HR or MIN, then move the JOYSTICK [21] up or down to adjust the time.
 - * The time is displayed in 12-hour format.
4. Pressing ENT at the center of the JOYSTICK [21] when the cursor is above HR or MIN saves the adjusted value in memory and simultaneously returns the display to the previous display (adjustment selection display).

To cancel clock adjustment before completion, use the JOYSTICK [21] to move the cursor to MENU, then press ENT at the center of the JOYSTICK [21].

Triggered audio mute for cellular telephones

This unit requires special wiring to mute the audio signal automatically when a cellular telephone rings in the car.

* This function is not compatible with all cellular telephones. Contact your local authorized Clarion dealer for information on proper installation and compatibility.

DSP operations

DSP control function

If the DSP (DPH7500z/7700z), sold separately, is connected to this unit using the CeNET cable, all the functions of the DSP can be controlled.

* When the DSP is connected, an external amplifier is required.

* DSP control can all be operated only when the panel is open.

DSP functions

There are 2 modes available in DPH7500z/7700z, standard mode and professional mode. Choose one of them and adjust the sound field and the sound quality.

● Functions common to each mode:

Such as auto loudness, subwoofer etc.

● Standard mode:

Adjustment using the graphic equalizer function and the DSP function.

● Professional mode:

Adjustment using the space equalizer function and the parametric equalizer function.

* When the standard mode is selected, adjustment for the professional mode cannot be made. On the contrary, when the professional mode is selected, adjustment for the standard mode cannot be made.

* For details on functions of each mode, refer to the owner's manual supplied with the DPH7500z/7700z.

* Hereafter the graphic equalizer is referred to as a G.EQ, the space equalizer referred to as VSE and the parametric equalizer referred to as P.EQ.

Operations common to each mode

Output adjustment of auto loudness, subwoofer and playback band

1. Press the ADJ button [18] to switch to the adjustment selection display.

2. Operate the JOYSTICK [21] upward or downward to select "SOUND" and press the ENT at the center of the JOYSTICK [21] to change into the Sound adjustment display. In the Sound adjustment display "A.LD LEVEL", "W.OUT", "W.LPF", "HPF", "T.TONE" are listed.

Operate the JOYSTICK [21] rightward or leftward to select an item to be adjusted.

3. To make an adjustment on:

● Auto loudness adjustment

Operate the JOYSTICK [21] upward or downward to adjust an auto loudness level (0 to 10).

● Woofer out adjustment

Select woofer output out of "STEREO", "MONO", or "OFF".

Operate the JOYSTICK [21] upward or downward to select a desired item, and then press the ENT at the center of the JOYSTICK [21] to set it.

● Woofer LPF adjustment

Select woofer LPF slope out of "50Hz", "80Hz", "120Hz".

Operate the JOYSTICK [21] upward or downward to select a desired item, and then press the ENT at the center of the JOYSTICK [21] to set it.

● HPF adjustment

Select HPF slope out of "50Hz", "80Hz", "120Hz", or "OFF".

Operate the JOYSTICK [21] upward or downward to select a desired item, and then press the ENT at the center of the JOYSTICK [21] to set it.

● Test Tone Output

Select Test Tone Output

Operate the JOYSTICK [21] upward or downward to select a desired item, and then press the ENT at the center of the JOYSTICK [21] to produce a test tone.

4. After adjustment (setting), operate the JOYSTICK [21] rightward or leftward to move the cursor to "MENU" and press the ENT at the center of the JOYSTICK [21] to return to the adjustment selection display.
5. Press the ADJ button [18] again to return to the STANDARD display.

Selecting the standard mode or the professional mode

* The factory default setting is "STD".

1. Press the ADJ button [18] to switch to the adjustment selection display.
2. Operate the JOYSTICK [21] upward or downward to select "DSF/EQ", "STD" and "PRO" items are displayed in the menu bar.
3. Operate the JOYSTICK [21] rightward or leftward to select a desired mode and press the ENT at the center of the JOYSTICK [21] to set the mode thus selected.
4. After setting, press the ADJ button [18] again to return to the STANDARD display.

Woofer level adjustment

You can adjust an output sound level of subwoofer.

1. Press the A-M button [17] to show the AUDIO-MODE display.
2. Operate the JOYSTICK [21] upward or downward to select "W-VOL" and press the ENT at the center of the JOYSTICK [21] to show the woofer level adjusting display.
3. Operate the JOYSTICK [21] upward or downward to adjust the level (0 to 14).
4. After adjustment, operate the JOYSTICK [21] rightward or leftward to select "MENU" and press the ENT at the center of the JOYSTICK [21]; return to the AUDIO-MODE display.

DSP operations

Standard mode/Setting the listening position

Selection of listening position

1. Press the A-M button [17] to show the AUDIO-MODE display.
2. Operate the JOYSTICK [21] upward or downward to select "POSITION", "SELECT" and "DETAIL" are displayed in the menu bar.
3. Operate the JOYSTICK [21] rightward or leftward to select "SELECT", and press the ENT at the center of the JOYSTICK [21] to show Position selecting display.
4. Operate the JOYSTICK [21] upward or downward and press the ENT at the center of the JOYSTICK [21] to select a desired position.
5. Operate the JOYSTICK [21] rightward or leftward to move the cursor to "MENU", and press the ENT at the center of the JOYSTICK [21] to return to the AUDIO-MODE display.

Detail adjustment of listening position

1. Press the A-M button [17] to show the AUDIO-MODE display.
2. Operate the JOYSTICK [21] upward or downward to select "POSITION", "SELECT" and "DETAIL" are displayed in the menu bar.
3. Operate the JOYSTICK [21] rightward or leftward to select "DETAIL", and press the ENT at the center of the JOYSTICK [21] to show Position Detail adjusting display.
4. Operate the JOYSTICK [21] rightward or leftward to select "BALANCE" or "FADER".
5. Operate the JOYSTICK [21] upward or downward to make an adjustment.
6. Operate the JOYSTICK [21] rightward or leftward to move the cursor to "MENU", and press the ENT at the center of the JOYSTICK [21] to return to the AUDIO-MODE display.

Standard mode/G.EQ operations

Note:

* The adjustment made in standard mode is not reflected in the adjustment in professional mode. Respectively, the adjustment made in professional mode is not reflected in the adjustment in standard mode.

G.EQ effect ON/OFF

* The factory default setting is "ON".

1. Press the A-M button [17] to show the AUDIO-MODE display.
2. Operate the JOYSTICK [21] upward or downward to select "EQ ON/OFF". "ON" and "OFF" items are displayed in the menu bar.
3. Operate the JOYSTICK [21] rightward or leftward to select "ON" or "OFF" and press the ENT at the center of the JOYSTICK [21] to set it.
4. After the setting, press the A-M button [17] again to return to the STANDARD display.

Note:

* If the G.EQ effect is set to OFF, the adjustment made in "G.EQ operations" is not reflected in the music source.

Calling G.EQ BASIC Pattern/USER Pattern

1. Press the A-M button [17] to show the AUDIO-MODE display.
2. Operate the JOYSTICK [21] upward or downward to select "EQ MODE". "BASIC" and "USER" items are displayed in the menu bar.
3. Operate the JOYSTICK [21] rightward or leftward to select the item thus called, and press the ENT at the center of the JOYSTICK [21] to show BASIC pattern selecting display or USER pattern selection/memory display.
4. In the Pattern selecting display, operate the JOYSTICK [21] rightward or leftward to select P1 to P6, and press the ENT at the center of the JOYSTICK [21] to call corresponding G.EQ pattern. In this display, pressing the No. button in correspondence to the PRESET button [13] can also call the G.EQ pattern.
 - * After selecting P1 to P6 by the JOYSTICK [21], press ENT at the center of the JOYSTICK [21] for 2 seconds or longer to copy the selected pattern to the USER pattern.
 - * Operate the JOYSTICK [21] rightward or leftward to select "EDIT", and press the ENT at the center of the JOYSTICK [21] to show G.EQ adjusting display, in which the properties of currently selected pattern can be adjusted.

ing display, in which the properties of currently selected pattern can be adjusted.

* By pressing the BAND button [15] in BASIC pattern selecting display or USER pattern selection/memory display you can switch between the two patterns, BASIC and USER.

5. Operate the JOYSTICK [21] rightward or leftward to select "MENU", and press the ENT at the center of the JOYSTICK [21] to return to the AUDIO-MODE display.

Setting and storing G.EQ Properties/Memory into USER Pattern

1. Repeat the steps 1 to 3 of the previous procedure (Calling G.EQ BASIC Pattern/USER Pattern) to show BASIC pattern selecting display or USER pattern selection/memory display.
2. Operate the JOYSTICK [21] leftward and rightward to select "EDIT", and press the ENT at the center of the JOYSTICK [21] to show the G.EQ adjusting display.
3. When some frequency to be adjusted is selected by operating the JOYSTICK [21] rightward or leftward in the G.EQ adjusting display, a gain setting value at the selected frequency is displayed.
4. Operate the JOYSTICK [21] upward or downward to adjust the G.EQ GAIN.
 - * By pressing the PRESET buttons [13] once in the G.EQ adjusting display, the setting value for currently stored USER pattern is obtained.
5. After making adjustments to a desired pattern by repeating the operations of items 3 and 4, operate the JOYSTICK [21] rightward or leftward to move the cursor to "RTN", and press the ENT at the center of the JOYSTICK [21] to change over to the BASIC/USER pattern selection/memory display.
6. Operate the JOYSTICK [21] rightward or leftward in the BASIC/USER pattern selection/memory display to select USER memory P1 to P6 to be stored, and press the ENT at the center of the JOYSTICK [21] for 2 seconds or longer to store the adjusted G.EQ pattern to the USER memory.
 - * By pressing the PRESET button [13] 1 to 6 for 2 seconds or longer in the G.EQ adjusting display, the G.EQ pattern can be stored in the USER memory.
7. To set a title of the stored USER pattern, operate the JOYSTICK [21] rightward or leftward to select "TITLE" and press the ENT at the center of the JOYSTICK [21] to change into the Title Input display.
 - *For title inputting method, refer to the section "Entering titles".

8. Operate the JOYSTICK [21] rightward or leftward to select "MENU" and press the ENT at the center of the JOYSTICK [21] to change into the AUDIO-MODE display.

Standard mode/DSF operations

DSF effect ON/OFF

* The factory default setting is "ON".

1. Press the A-M button [17] to show the AUDIO-MODE display.
2. Operate the JOYSTICK [21] upward or downward to select "DSF ON/OFF". "ON" and "OFF" items are displayed in the menu bar.
3. Operate the JOYSTICK [21] rightward and leftward to select "ON" or "OFF" and press the ENT at the center of the JOYSTICK [21] to set it.

Note:

* If the DSF effect is set to OFF, the adjustment made in "DSF operations" is not reflected in the music source.

Calling DSF BASIC Pattern/USER Pattern

1. Press the A-M button [17] to show the AUDIO-MODE display.
2. Operate the JOYSTICK [21] upward or downward to select "DSF MODE". "BASIC 1", "BASIC 2" and "USER" items are displayed in the menu bar.
3. Operate the JOYSTICK [21] rightward or leftward to select the item thus called, and press the ENT at the center of the JOYSTICK [21] to show BASIC pattern selecting display or USER pattern selection/memory display.
4. In the pattern selecting display, operate the JOYSTICK [21] rightward or leftward to select P1 to P6, and press the ENT at the center of the JOYSTICK [21] to call corresponding DSF mode. In this display, pressing the No. button in correspondence to the PRESET buttons [13] can also call the DSF mode.
 - * After selecting P1 to P6 by operating the JOYSTICK [21], press the ENT at the center of the JOYSTICK [21] for 2 seconds or longer to copy the selected pattern to the USER pattern.
 - * Operate the JOYSTICK [21] rightward or leftward to select "EDIT", and press the ENT at the center of the JOYSTICK [21] to show DSF adjusting display, in which the properties of currently selected pattern can be adjusted.

- * By pressing the BAND button [15] in BASIC pattern selecting display or USER pattern selection/memory display you can switch between the two patterns, BASIC and USER.
5. Operate the JOYSTICK [21] rightward or leftward to select "MENU", and press the ENT at the center of the JOYSTICK [21] to return to the AUDIO-MODE display.

Setting and storing DSF Properties/Memory into USER Pattern

1. Repeat the steps 1 to 3 of the previous procedure (Calling DSF BASIC Pattern/USER Pattern) to show BASIC pattern selecting display or USER pattern selection/memory display.
2. Operate the JOYSTICK [21] upward or downward to select "EDIT", and press the ENT at the center of the JOYSTICK [21] to show the DSF adjusting display.
3. Select an item to be adjusted by operating the JOYSTICK [21] rightward or leftward in the DSF adjusting display.
 - "EF" → EFFECT
 - "DL" → DELAY
 - "R.M" → REAR MIX
 - "R.S" → ROOM SIZE
 - "LV" → LIVENESS
 - "R.T" → REVERB TIME
 - "HI" → HIGH
4. Operate the JOYSTICK [21] upward or downward to set each adjusting value.
 - * By pressing the PRESET buttons [13] once in the DSF adjusting display, the setting value for currently stored USER pattern is obtained.
5. After making adjustments to a desired pattern by repeating the operations of items 3 and 4, operate the JOYSTICK [21] rightward or leftward to move the cursor to "RTN", and press the ENT at the center of the JOYSTICK [21] to change over to the BASIC/USER pattern selection/memory display.
6. Operate the JOYSTICK [21] rightward or leftward in the BASIC/USER pattern selection/memory display to select USER memory P1 to P6 to be stored, and press the ENT at the center of the JOYSTICK [21] for 2 seconds or longer to store the adjusted DSF pattern to the USER memory.
 - * By pressing the PRESET buttons [13] 1 to 6 for 2 seconds or longer in the DSF adjusting display, the DSF pattern can be stored in the USER memory.

DSP operations

- To set a title of the stored USER pattern, operate the JOYSTICK [21] rightward or leftward to select "TITLE" and press the ENT at the center of the JOYSTICK [21] to change into the Title Input display.
*For title inputting method, refer to the section "Entering titles".
- Operate the JOYSTICK [21] rightward or leftward to select "MENU" and press the ENT at the center of the JOYSTICK [21] to change into the AUDIO-MODE display.

Professional mode/VSE operations

Note:

- The adjustment made in professional mode is not reflected in the adjustment in standard mode. On the contrary, the adjustment made in standard mode is not reflected in the adjustment in professional mode.

VSE effect ON/OFF

- The factory default setting is "ON".
- Press the A-M button [17] to show the AUDIO-MODE display.
 - Operate the JOYSTICK [21] upward or downward to select "VSE ON/OFF". "ON" and "OFF" items are displayed in the menu bar.
 - Operate the JOYSTICK [21] rightward or leftward to select "ON" or "OFF" and press the ENT at the center of the JOYSTICK [21] to set it.

Note:

- If the VSE effect is set to OFF, the adjustment made in "VSE operations" is not reflected in the music source.

Calling VSE BASIC Pattern/USER Pattern

- Press the A-M button [17] to show the AUDIO-MODE display.
- Operate the JOYSTICK [21] upward or downward to select "VSE MODE". "BASIC" and "USER" items are displayed in the menu bar.
- Operate the JOYSTICK [21] rightward or leftward to select the item thus called, and press the ENT at the center of the JOYSTICK [21] to show BASIC pattern selecting display or USER pattern selection/memory display.
- In the pattern selecting display, operate the JOYSTICK [21] rightward or leftward to select P1 to P6, and press the ENT at the center of

the JOYSTICK [21] to call corresponding VSE pattern. In this display, pressing the No. button in correspondence to the PRESET buttons [13] can also call the VSE pattern.

- After selecting P1 to P6 by operating the JOYSTICK [21] rightward or leftward, press the ENT at the center of the JOYSTICK [21] for 2 seconds or longer to copy the selected pattern to the USER pattern.
 - Operate the JOYSTICK [21] rightward or leftward to select "EDIT", and press the ENT at the center of the JOYSTICK [21] to show the VSE adjusting display, in which the properties of currently selected pattern can be adjusted.
 - By pressing the BAND button [15] in BASIC pattern selecting display or USER pattern selection/memory display you can switch between the two patterns, BASIC and USER.
- Operate the JOYSTICK [21] rightward or leftward to select "MENU", and press the ENT at the center of the JOYSTICK [21] to return to the AUDIO-MODE display.

Setting and storing VSE Properties/Memory into USER Pattern

- Repeat the steps 1 to 3 of the previous procedure (Calling VSE BASIC Pattern/USER Pattern) to show BASIC pattern selecting display or USER pattern selection/memory display.
- Operate the JOYSTICK [21] upward or downward to select "VSE EDIT", and press the ENT at the center of the JOYSTICK [21] to show the VSE adjusting display.
- Select an item to be adjusted by operating the JOYSTICK [21] rightward or leftward in the VSE adjusting display.
"DIFF" → DIFFUSE
"C.WD" → CAR WIDTHTH
"C.LG" → CAR LENGTH
- Operate the JOYSTICK [21] upward or downward to set each adjusting value.
* By pressing the PRESET buttons [13] once in the VSE adjusting display, the setting value for currently stored USER pattern is obtained.
- After making adjustments to a desired pattern by repeating the steps 3 and 4, operate the JOYSTICK [21] rightward or leftward to move the cursor to "RTN", and press the ENT at the center of the JOYSTICK [21] to change over to the BASIC/USER pattern selection/memory display.
- Operate the JOYSTICK [21] rightward or leftward in the BASIC/USER pattern selection/memory display to select USER memory P1 to P6 to be stored, and press the ENT at the center of the

DSP operations

JOYSTICK [21] for 2 seconds or longer to store the adjusted VSE pattern to the USER memory.

- By pressing the PRESET buttons [13] 1 to 6 for 2 seconds or longer in the VSE adjusting display, the VSE pattern can be stored in the USER memory.

- To set a title of the stored USER pattern, operate the JOYSTICK [21] rightward or leftward to select "TITLE" and press the ENT at the center of the JOYSTICK [21] to change into the Title Input display.
*For title inputting method, refer to the section "Entering titles".
- Operate the JOYSTICK [21] rightward or leftward to select "MENU" and press the ENT at the center of the JOYSTICK [21] to change into the AUDIO-MODE display.

Professional mode/P.EQ operations

P.EQ effect ON/OFF

- The factory default setting is "ON".

- Press the A-M button [17] to show the AUDIO-MODE display.
- Operate the JOYSTICK [21] upward or downward to select "P.EQ ON/OFF", "ON" and "OFF" items are displayed in the menu bar.
- Operate the JOYSTICK [21] rightward or leftward to select "ON" or "OFF" and press the ENT at the center of the JOYSTICK [21] to set it.

Note:

- If the P.EQ effect is set to OFF, the adjustment made in "P.EQ operations" is not reflected in the music source.

Calling P.EQ BASIC Pattern/USER Pattern

- Press the A-M button [17] to show the AUDIO-MODE display.
- Operate the JOYSTICK [21] upward or downward to select "P.EQ MODE". "BASIC" and "USER" items are displayed in the menu bar.
- Operate the JOYSTICK [21] rightward or leftward to select the item thus called, and press the ENT at the center of the JOYSTICK [21] to show BASIC pattern selecting display or USER pattern selection/memory display.
- In the pattern selecting display, operate the JOYSTICK [21] rightward or leftward to select

P1 to P6, and press the ENT at the center of the JOYSTICK [21] to call corresponding P.EQ pattern. In this display, pressing the No. button in correspondence to the PRESET buttons [13] can also call the P.EQ pattern.

- After selecting P1 to P6 by operating the JOYSTICK [21], press the ENT at the center of the JOYSTICK [21] for 2 seconds or longer to copy the selected pattern to the USER pattern.
 - Operate the JOYSTICK [21] rightward or leftward to select "EDIT", and press the ENT at the center of the JOYSTICK [21] to show P.EQ adjusting display, in which the properties of currently selected pattern can be adjusted.
 - By pressing the BAND button [15] in BASIC pattern selecting display or USER pattern selection/memory display you can switch between the two patterns, BASIC and USER.
- Operate the JOYSTICK [21] rightward or leftward to select "MENU", and press the ENT at the center of the JOYSTICK [21] to return to the AUDIO-MODE display.

Setting and storing P.EQ Properties/Memory into USER Pattern

- In the Basic adjustment display or in the User setting display, press the A-M button [17] to show the AUDIO-MODE display.
- Operate the JOYSTICK [21] upward or downward to select "EDIT", and press the ENT at the center of the JOYSTICK [21] to show the P.EQ adjusting display.
- Select an item to be adjusted by operating the JOYSTICK [21] rightward or leftward in the P.EQ adjusting display.
- Operate the JOYSTICK [21] upward or downward to set each adjusting value.
* By pressing the PRESET buttons [13] once in the P.EQ adjusting display, the setting value for currently stored USER pattern is obtained.
- After making adjustments to a desired pattern by repeating the operations of items 3 and 4, operate the JOYSTICK [21] rightward or leftward to move the cursor to "RTN", and press the ENT at the center of the JOYSTICK [21] to change over to the BASIC/USER pattern selection/memory display.
- Operate the JOYSTICK [21] rightward or leftward in the BASIC/USER pattern selection/memory display to select USER memory P1 to P6 to be stored, and press the ENT at the center of the JOYSTICK [21] for 2 seconds or longer to store the adjusted P.EQ pattern to the USER memory.

DSP operations

* By pressing the PRESET buttons **[1]** 1 to 6 for 2 seconds or longer in the P.EQ adjusting display, the P.EQ pattern can be stored in the USER memory.

- To set a title of the stored USER pattern, operate the JOYSTICK **[2]** rightward or leftward to select "TITLE" and press the ENT at the center of the JOYSTICK **[2]** to change into the Title Input display.

*For title inputting method, refer to the section "Entering titles".

- Operate the JOYSTICK **[2]** rightward or leftward to select "MENU" and press the ENT at the center of the JOYSTICK **[2]** to change into the AUDIO-MODE display.

9. IN CASE OF DIFFICULTY

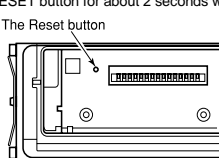
	Problem	Cause	Measure
GENERAL	Power does not turn on. (No sound is produced.)	Fuse is blown.	Replace with a fuse of the same amperage. If the fuse blows again, consult your store of purchase.
		Incorrect wiring.	Consult your store of purchase.
	Nothing happens when buttons are pressed. Display is not accurate.	The microprocessor has malfunctioned due to noise, etc.	Turn off the power, then press the RELEASE lever [6] and remove the DCP. Press the RESET button for about 2 seconds with a thin rod. The Reset button 
		DCP or main unit connectors are dirty.	Wipe the dirt off with a soft cloth moistened with cleaning alcohol.
The remote controller does not work.	The display is not open.	The remote controller does not work unless the display is open.	
	Direct rays of the sun fall on the light-receptive part of the remote controller.	When direct rays of the sun fall on the light-receptive part of the remote controller, it may not work.	
	The batteries of the remote controller unit are dead or there is no battery in the remote controller unit.	Check the batteries of the remote controller unit.	
TV	The image is not displayed.	The parking brake is not pulled.	Check that the parking brake is applied.
	The display is dark.	The brightness control is too low.	Adjust the brightness properly.
		The operating condition is not good.	The temperature inside the vehicle may be 0°C or less. Set to an appropriate temperature (25°C or so) and check it again.
		The headlight of the vehicle is lit.	The display is made dark at night to prevent the glare (When the headlight of the vehicle is lit in the daytime, the display gets dark).
	The color of the display is light or a shade of color is not good.	The color is not adjusted adequately.	Check that COL and HUE are adjusted properly.
When the VTR is connected, the image is disturbed.	Improper NTSC/PAL setting	Set the NTSC/PAL properly according to the VTR.	

	Problem	Cause	Measure
TV	When the TV tuner is connected, the image gets unclear.	Bad receiving condition	A radio wave may not reach sufficiently due to obstruction of mountains or buildings. Check it again at a place where a radio wave can be received properly.
	The TV tuner has a double or triple image.	Bad receiving condition	It may be under the influence of radio wave reflected by mountains or buildings. Check it again after changing place or direction.
	The TV tuner has spots or stripes in the image.	Presence of jamming	It may be under the influence from automobiles, streetcar, power cable, neon sign, and so forth. Check it again after changing place.
	There are red, green, and blue points in the display.		This is not a failure, but a phenomenon peculiar to a liquid crystal panel (The LCD panel is produced according to technology with very high precision. Note that, though there are effective pixels of 99.99% or more, pixel missing or normally lit pixels account for 0.01%).

10. ERROR DISPLAYS

If an error occurs, one of the following displays is displayed. Take the measures described to eliminate the problem.

	Error Display	Cause	Measure
CD	ERROR 2	A CD is caught inside the CD deck and is not ejected.	This is a failure of CD deck's mechanism and consult your store of purchase.
	ERROR 3	A CD cannot be played due to scratches, etc.	Replace with a non-scratched, non-warped-disc.
	ERROR 6	A CD is loaded upside-down inside the CD deck and does not play.	Eject the disc then reload it properly.
CD CHANGER	ERROR 2	A CD inside the CD changer is not loaded.	This is a failure of CD changer's mechanism and consult your store of purchase.
	ERROR 3	A CD inside the CD changer cannot be played due to scratches, etc.	Replace with a non-scratched, non-warped-disc.
	ERROR 6	A CD inside the CD changer cannot be played because it is loaded upside-down.	Eject the disc then reload it properly.
MD CHANGER	ERROR H	Displayed when the temperature in the MD changer is too high and playback has been stopped automatically.	Lower the surrounding temperature and wait for a while to cool off MD changer.
	ERROR 2	An MD inside the MD changer is not loaded.	This is a failure of MD changer's mechanism and consult your store of purchase.
	ERROR 3	An MD inside the MD changer cannot be played due to scratches, etc.	Replace with a non-scratched, non-warped-disc.
	ERROR 6	An MD inside the MD changer cannot be played because it is loaded upside-down.	Eject the disc then reload it properly.
		Displayed when a non-recorded MD is loaded in the MD changer.	Load a pre-recorded MD in the MD changer.

If an error display other than the ones described above appears, press the RESET button. If the problem persists, turn off the power and consult your store of purchase.

11. SPECIFICATIONS

FM Tuner

Frequency Range:
87.9 MHz to 107.9 MHz

Usable Sensitivity:
11 dBf

50dB Quieting Sensitivity:
17 dBf

Alternate Channel Selectivity:
75 dB

Stereo Separation(1 kHz):
35 dB

Frequency Response(+/-3 dB):
30 Hz to 15 kHz

AM Tuner

Frequency Range:
530 kHz to 1710 kHz

Usable Sensitivity:
25 μ V

Audio Amplifier

Rated power output:
17 W \times 4 (20 Hz to 20 kHz, 1%, 4 Ω)

Maximum power output: 40 W \times 4 (EIAJ)

Speaker impedance: 4 Ω (4 to 8 Ω)

Input/Output

Video input:
1.0 +/- 0.2 Vp-p (input impedance 75 Ω)

Audio output: min.200mVrms

LCD Monitor

Screen Size:
6.5-inch wide type (142 mm Width \times 78 mm Height)

Display method: Transmission type TN liquid crystal display

Drive method: TFT (thin-film transistor) active matrix driving

Pixels:
280,800 (1200 \times 234)

General

Power source voltage:
14.4 V DC (10.8 to 15.6 V allowable)

Ground:
Negative

Current consumption:
4.0 A (1 W)

Auto Antenna Rated Current:
500 mA less

Dimensions of the Main Unit:
178 (W) \times 50 (H) \times 157 (D)mm
7(W) \times 1-15/16(H) \times 6-3/16(D)inches

Weight of the Main Unit:
1.7 kg

Dimensions of the Remote Control Unit:
44 (W) \times 110 (H) \times 27 (D)mm
1-3/4(W) \times 4-5/16(H) \times 1-1/16(D)inches

Weight of the Remote Control Unit:
30 g (including battery)

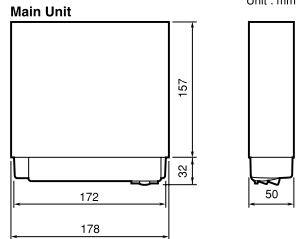

Notes:

- Specifications comply with EIAJ Standards.
- Specifications and design are subject to change without notice for further improvement.

Clarion

VRX610

Installation and Wire connection manual

Contents

1.	BEFORE STARTING.....	43
2.	PACKAGE CONTENTS.....	43
3.	GENERAL CAUTIONS.....	44
4.	CAUTIONS ON INSTALLATION.....	44
5.	INSTALLING THE MAIN UNIT.....	45
6.	REMOVING THE MAIN UNIT.....	47
7.	CAUTIONS ON WIRING.....	48
8.	WIRE CONNECTION	49
9.	SAMPLE SYSTEMS.....	51

1. BEFORE STARTING

1. This set is exclusively for use in cars with a negative ground 12 V power supply.
2. Read these instructions carefully.
3. Be sure to disconnect the battery "⊖" terminal before starting. This is to prevent short circuits during installation. (Figure 1)

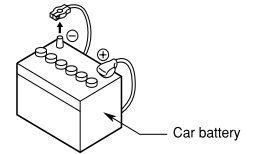

Figure 1

2. PACKAGE CONTENTS

① Main unit	Cord clamp
② Manuals	Spacer
Owner's manual & Installation manual	Special screw
Warranty card	⑥ Universal mounting bracket
③ Power supply lead	⑦ Remote control unit
④ Bag for accessories of the main unit (No. 1)	⑧ Battery
Flat head screw (M5 \times 8).....4	(for remote control unit)
Sems hexagonal bolt (M5 \times 8).....5	⑨ Outer Escutcheon
⑤ Bag for accessories of the main unit (No. 2)	⑩ DCP Case
Hook plate.....2	

3. GENERAL CAUTIONS

1. Do not open the case. There are no user serviceable parts inside. If you drop anything into the unit during installation, consult your dealer or an authorized CLARION service centre.
2. Use a soft, dry cloth to clean the case. Never use a rough cloth, thinner, benzene, or alcohol, etc. For tough dirt, apply a little cold or warm water to a soft cloth and wipe off the dirt gently.

4. CAUTIONS ON INSTALLATION

1. Prepare all articles necessary for installing the main unit before starting.
2. This model is used with the LCD panel slid forwards (shell loading system). On some types of cars, the LCD panel may touch the dashboard or shift lever, in which case it cannot be installed. Check that the set will not hamper operation of the shift lever before choosing the place of installation. (Figure 2)
3. Install the unit within 30° of the horizontal plane. (Figure 3)
4. If you have to do any work on the car body, such as drilling holes, consult your car dealer beforehand.
5. Use the enclosed screws for installation. Using other screws can cause damage. (Figure 4)
6. The source unit has mounting screw holes for NISSAN (N marks) and TOYOTA (T marks) vehicles, and for Clarion installation kit (C marks).
When you use a mounting kit sold separately, affix the screws to the ● marks above according to the type of the vehicle. (Figure 5)

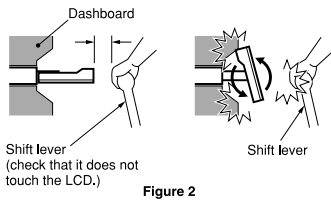

Figure 2

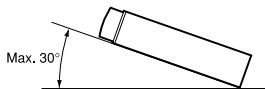

Figure 3

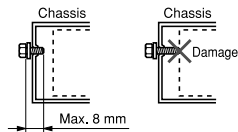

Figure 4

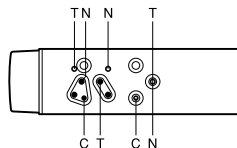

Figure 5

5. INSTALLING THE MAIN UNIT

■ Universal Mount

1. Place the universal mounting bracket into the instrument panel, use a screwdriver to bend each stopper of the universal mounting bracket inward, then secure the stopper as shown in Figure 6.
2. Wire as shown in Section 8.
3. Insert the main unit into the universal mounting bracket until it locks.
4. Mount the outer escutcheon so that all the hooks are locked.

Notes:
 1) Some car models require special mounting kits for proper installation. Consult your Clarion dealer for details.
 2) Fasten the front stopper securely to prevent the main unit from coming loose.

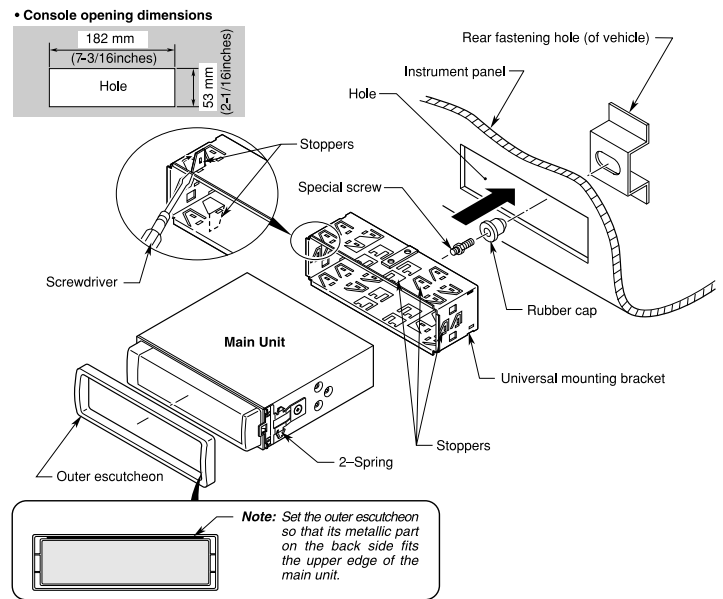

Figure 6

■ Fixed Mount (TOYOTA, NISSAN and other ISO/DIN equipped vehicles)

This unit is designed for fixed installation in the dashboard.

If the vehicle is equipped with a factory-installed radio, install the main unit with the parts and screws marked (*). (Figure 8)

If the vehicle is not equipped with a factory-installed radio, obtain an installation kit to install the main unit in the following procedure.

1. Remove the screws from both side of the main unit. Then, at either side, lift the leaf spring until the engaging claws are released from the holes, and slide the spring to the direction of arrow to remove it. Repeat the

same for the other side to remove the springs from the both sides. (Figure 7)

2. Secure the mounting brackets to the chassis as shown in Figure 8. Holes are pre-tapped for TOYOTA and NISSAN vehicles; modification, such as drilling new holes, of the mounting brackets may be required for other models.
3. Wire as shown in Section 8.
4. Secure the unit in the dashboard, and then reassemble the dashboard and the centre panel.

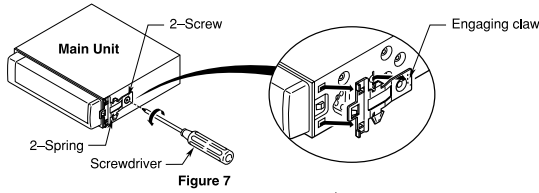

Figure 7

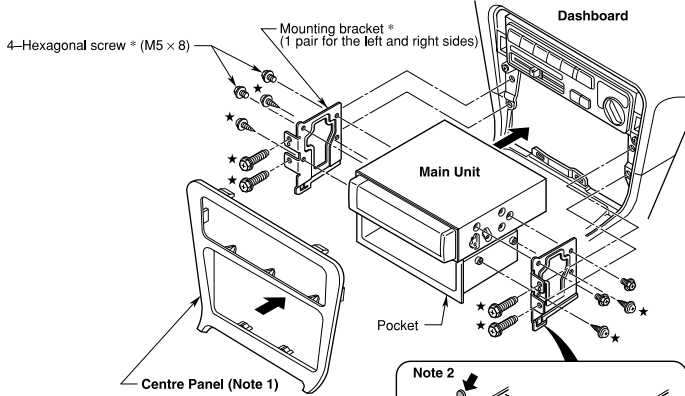

Figure 8

*: The parts and screws with this mark are used to install radio or included in the installation kit.

★: The screws with this mark are originally attached to the vehicle.

Note 1: In some cases, the centre panel may require some modification (trimming, filling, etc.).

Note 2: If a hook on the installation bracket interferes with the unit, bend and flatten it with a nipper or a similar tool.

6. REMOVING THE MAIN UNIT

1. When the rear of the main unit has been secured with the method shown in Figure 6 unfasten the special screw.
2. Remove the outer escutcheon.
3. Insert the hook plate between the spring and the universal mounting bracket, fit tab (B) of

the spring into hole (A) of the hook plate, then pull the main unit out by the hook plate. (Insert both the right and left edges of the hook plate.) (Figure 9)

Note: Keep the hook plate. You cannot remove the main unit without disengaging the hook plate.

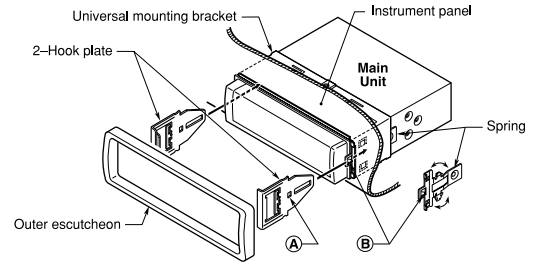

Figure 9

7. CAUTIONS ON WIRING

1. Be sure to turn the power off before wiring.
2. Be particularly careful where you route the wires.
Keep them well away from the engine, and exhaust pipe, etc. Heat may damage the wires.
3. If the fuse should blow, check to see if the wiring is correct.
If it is, replace the fuse with a new one with the same amperage rating as the original.
4. When any fuse is to be replaced, pull out the fuse (15A) at the rear of the main unit and put in a new one (Fig.10).

Rear view of the Main unit

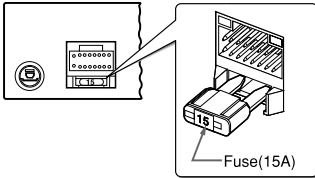

Figure 10

CAUTION

After the connection, fix the lead by a clamp or insulation tape for protection.

5. When connecting the ground lead, fasten the ground lead (black) securely to a clean metal plate on the car. (Figure 11)
If the set is insufficiently grounded, it may not operate or there may be noise.

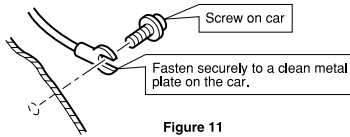
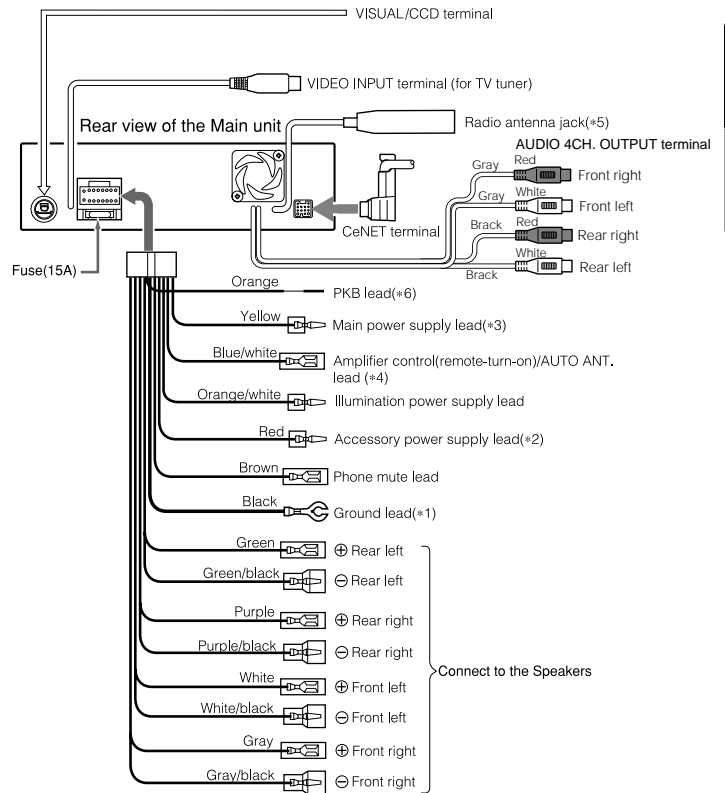

Figure 11

8. WIRE CONNECTION



- * 1: Connect securely to the metal part of the vehicle with a screw, etc.
- * 2: Connect to the power supply terminal which can be turned on and off by the ignition switch.
- * 3: Connect to the power supply terminal where the power is always supplied regardless of whether the ignition switch is turned on or off.
- * 4: Connect to the remote turn-on lead of amplifiers.
- * 5: Use the attached extension lead when necessary.
- * 6: Connect the terminal to the lead wire on the lamp side of the parking brake lamp switch. After connection, apply the parking brake, then check that the TV displays an image.
 - If the PKB lead is not connected to the side brake, some units may not operate.

■ Connecting the Accessories

• Connection to the external amplifier

The external amplifier can be connected to the AUDIO 4CH. OUTPUT terminal (RCA pin jack) on the main unit. In other words, it can be connected provided the DSP is connected.

• Connection to the security camera for vehicle

The rear vision camera for vehicle can be connected to the system expansion terminal on the main unit. For detailed information, refer to the instruction sheet or manual for the rear vision camera.

Notes:

• A power supply box (sold separately) is required for connection of the main unit and the security camera.

• Connection to the DSP

When the DSP is connected, use the CeNET connector. The external amplifier is required when connecting the DSP.

• If the specified lead of the cellular phone is connected to the phone mute lead of the source unit, the audio mute is available when the cellular telephone is used.

• TV Tuner

When the TV TUNER is to be connected, connect the CeNET connector and RCA PIN (yellow). For detailed information, refer to the instruction manual of the TV TUNER.

* When you connect the PKB lead TV TUNER, also connect it to the Main unit. (The TV TUNER will not operate with the PKB lead connected to the TV TUNER only.)

9. SAMPLE SYSTEMS

■ Sample System 1

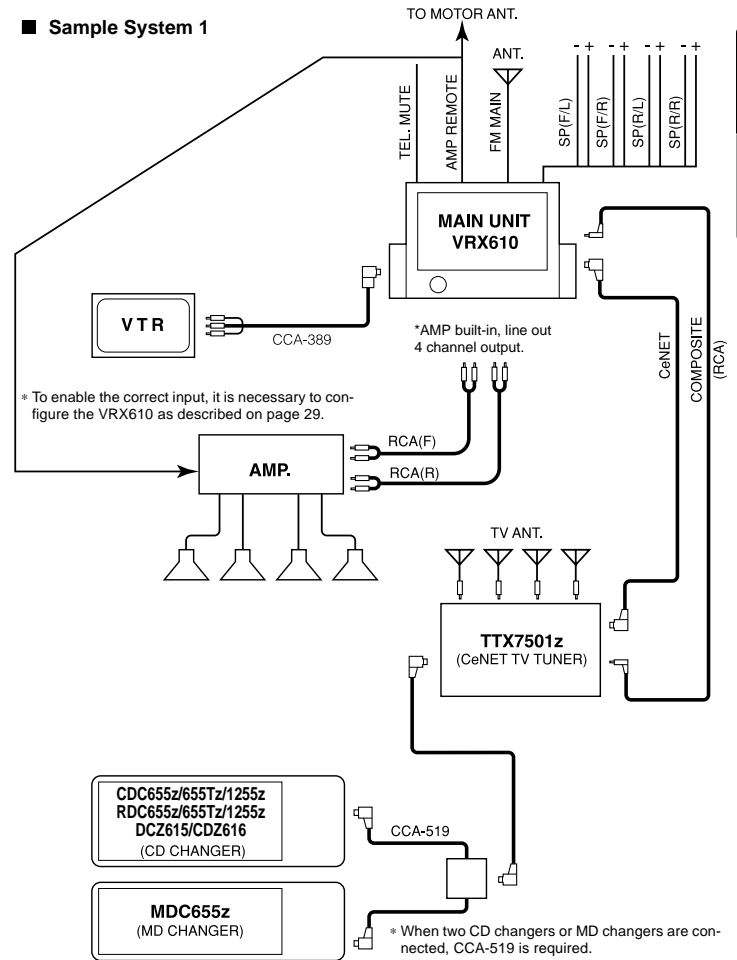

■ Sample System 2

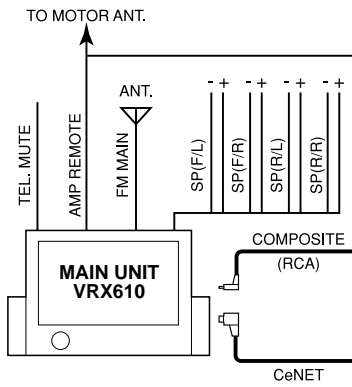

* AMP built-in, Line out 4channel output.

* To enable the correct input, it is necessary to configure the VRX610 as described on page 29.

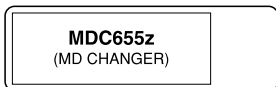

* When two CD changers or MD changers are connected, CCA-519 is required.

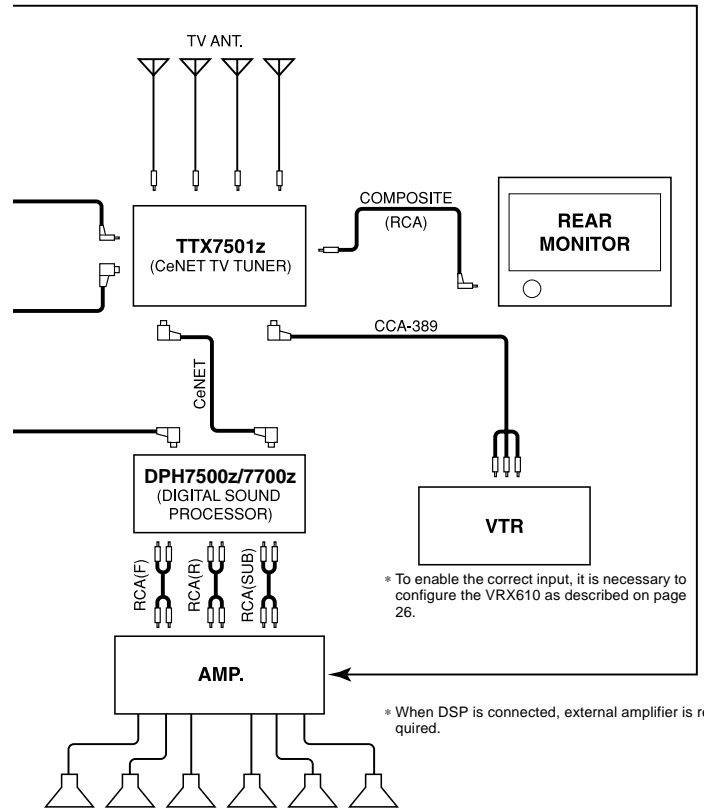

* To enable the correct input, it is necessary to configure the VRX610 as described on page 26.

* When DSP is connected, external amplifier is required.

Memo

English

Installation and Wire
connection manual