



Assembly and Instruction Manual



U. S. & foreign patents pending

Round Fireplace
model 5068 Series



Introduction

Your fireplace is a versatile unit that can be used as either a fireplace or a wood/charcoal burning grill. In addition, with the fire starter attachment, the starting of wood is simplified and more convenient. Follow these instructions for assembly and read carefully, particularly the safety statements. The safety alert symbol,  is a universally recognized symbol used to identify safety information about hazards that can result in personal injury. When this symbol is used you should pay particularly close attention to what is written. Review these instructions before beginning assembly or use of your fireplace.

NOTE: Extreme heat from fire may cause paint to burn off. To help restore look and protect steel, use a wire brush to clean parts then repaint with high temperature paint. Two layers of logs maximum recommended.

FOLLOW INSTRUCTIONS AND WARNINGS TO AVOID FIRE, SERIOUS INJURY OR DEATH.

▲ WARNING

- Outdoor use only. Never use in enclosed area. Use in unventilated areas will endanger your life.
- Keep away from all combustible materials including gasoline and other flammable liquids and vapors.
- Use on a level, noncombustible surface only. Keep away from house, garage, balconies, or eave overhangs.
- Keep out of the reach of children.
- Be sure screen is in place while in use and do not use in windy conditions.
- Do not overfill firebox or use to burn leaves and trash.
- Exercise the same care you would with an open fire.
- Never leave unit unattended when hot or in use.
- Completely extinguish fire before leaving.
- Use gloves when handling or moving. Ashes can remain warm for a long time after extinguishing.
- Dispose of cold ashes properly.
- Do not modify in any way nor use with parts not expressly approved by Coleman.

Contact local authorities regarding possible burn restrictions before using product.

When using fire starter, in addition to the above:

- Always inspect propane cylinder and starter connection for damage, dirt, and debris before attaching cylinder.
- Always attach or detach cylinder outdoors away from flame, pilot lights, other ignition sources and only when fireplace is cool to touch.
- Light fire starter only without lid and screen and with no wood or charcoal in box.
- Use 16.4 oz. (465g) cylinders only. Do not connect to bulk propane tank.
- Never refill disposable cylinders.

Fireplace Parts Check List

• Check package for all parts needed for assembly.

- | | |
|---|---|
| <input type="checkbox"/> 1. Handle (3 pieces) | <input type="checkbox"/> 8. Axle End Caps (2 pieces) |
| <input type="checkbox"/> 2. Lid | <input type="checkbox"/> 9. Axle |
| <input type="checkbox"/> 3. Screen Assy. (8 pieces) | <input type="checkbox"/> 10. Hardware |
| <input type="checkbox"/> 4. Firebox | <input type="checkbox"/> 11. Damper |
| <input type="checkbox"/> 5. Leg Assembly (4 pieces) | <input type="checkbox"/> 12. Grill |
| <input type="checkbox"/> 6. Grate | <input type="checkbox"/> 13. Firestarter & Bracket (optional) |
| <input type="checkbox"/> 7. Wheels | |

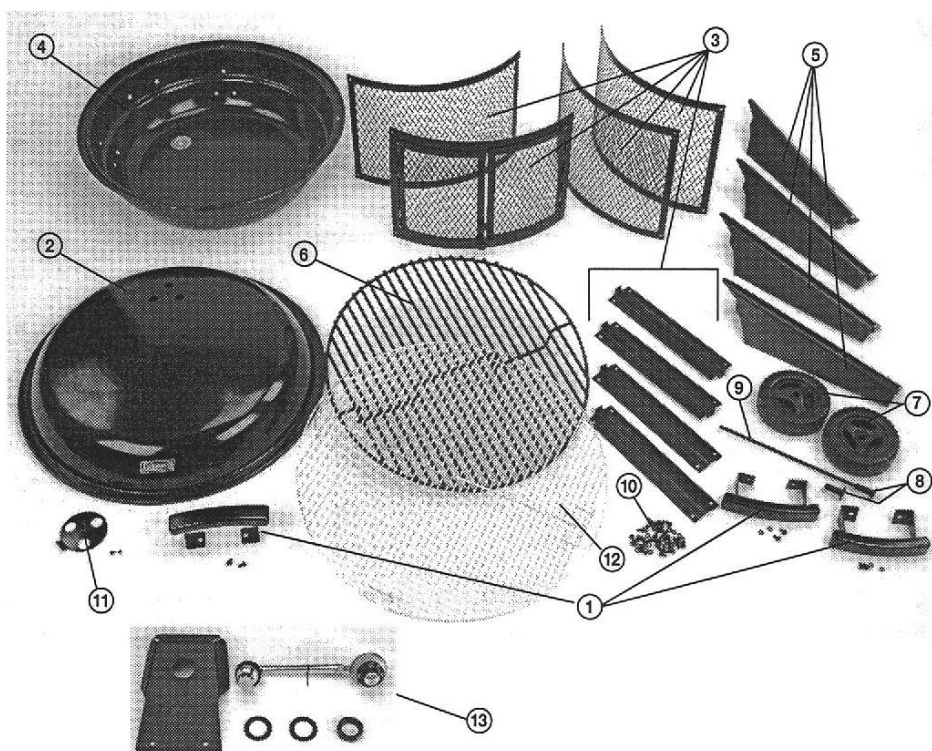

• Check all items for shipping damage. Call Coleman at 1-800-835-3278 or TDD: 316-832-8707 if you have any problems.

Assembly

1. Carefully unpack all parts from shipping box.

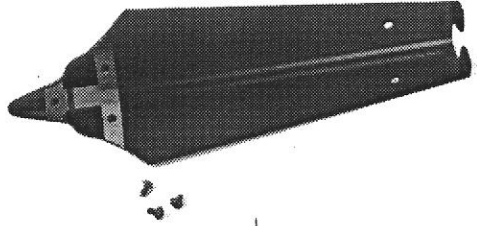

2. Assemble Legs to Firebox as shown below. Each Leg is held by 3 bolts. Install washers on bolts and fasten to leg.

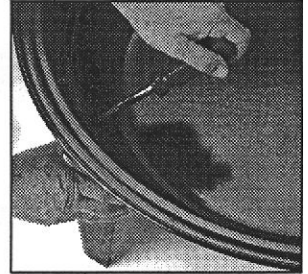
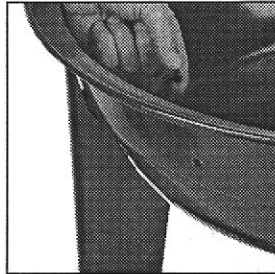
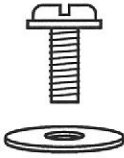

NOTE: Legs with Axle hole located opposite plug in firebox.

3. Assemble Wheels and Axle to Legs as shown below. Make sure indented area in center of wheel is pointing out. Attach Axle End Caps as shown and tap lightly with hammer to secure Wheels to Axle. Do not drive Axle End Caps on too far which would cause wheels to bind on leg. Allow about 1/8" clearance between wheel and leg.

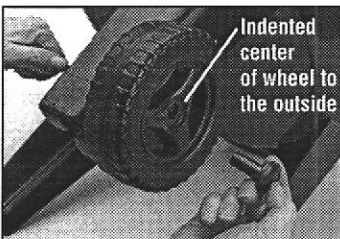
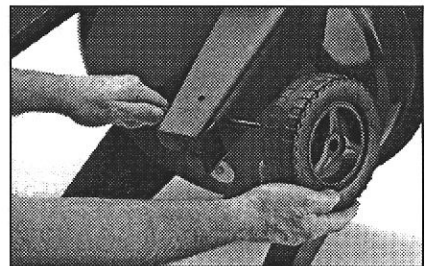
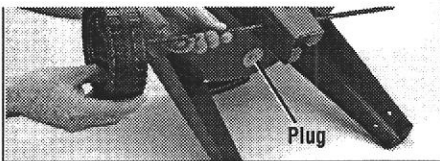
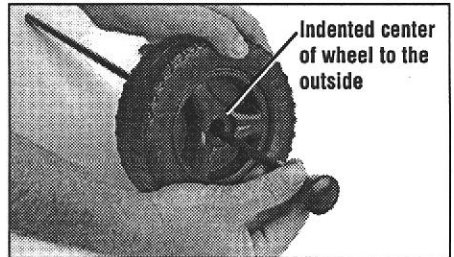

4. Assemble Handles to Firebox and Lid. If your unit has a fire starter, the Firestarter Bracket must be installed.

WITH FIRE STARTER

A. Install Bracket with Handle.

NOTE: Position Handle with longest portion of its Leg towards bottom of Firebox

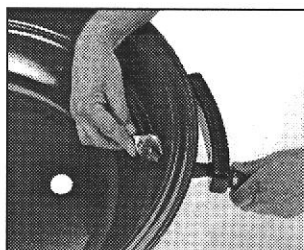
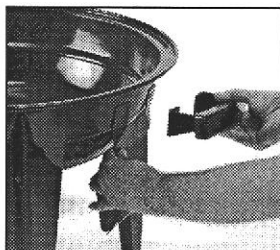
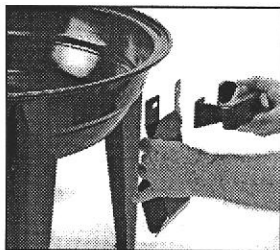
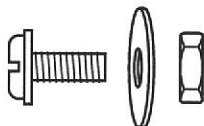

B. Install other Handle to Firebox and Handle to Lid.

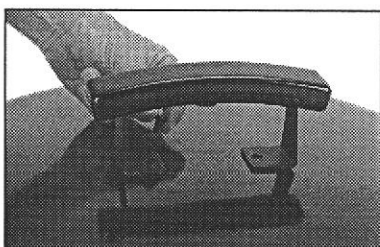
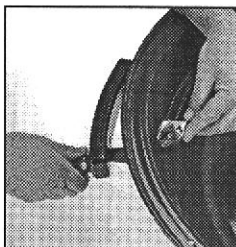

C. Install Damper to Lid.

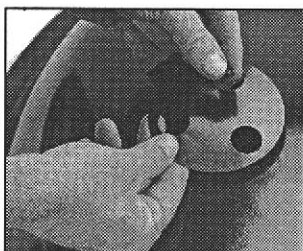

D. Install Fire Starter.

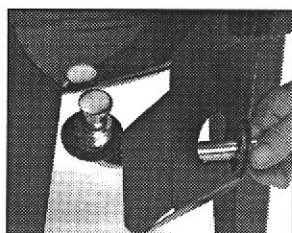
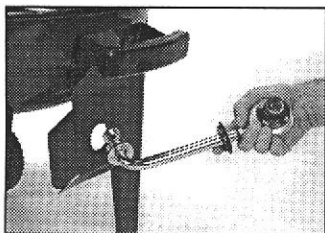

WITH FIRE STARTER (cont.)

D. Install Fire Starter. (cont.)

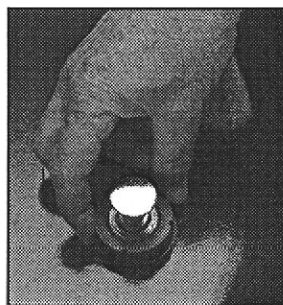
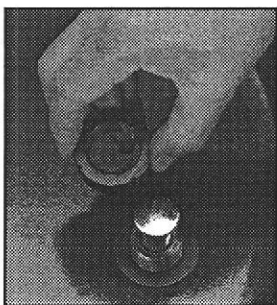
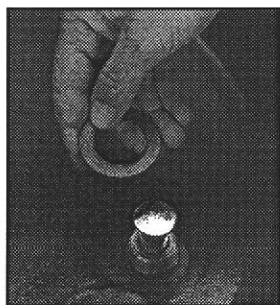

WITHOUT FIRE STARTER

A. Install Bracket with Handle.

NOTE: Position Handle with longest portion of its Leg towards bottom of Firebox.

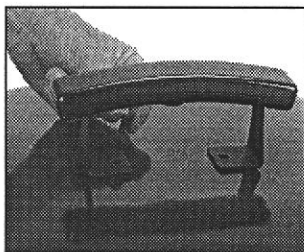
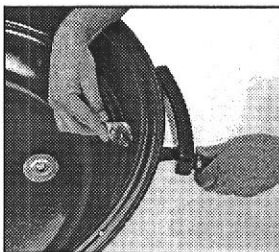
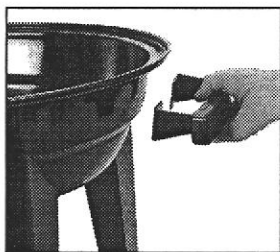
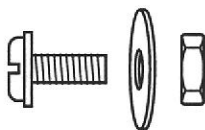

B. Install Damper to Lid.

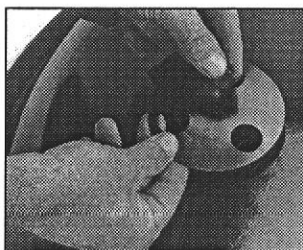

5. Assemble Fireplace Screen as shown below.

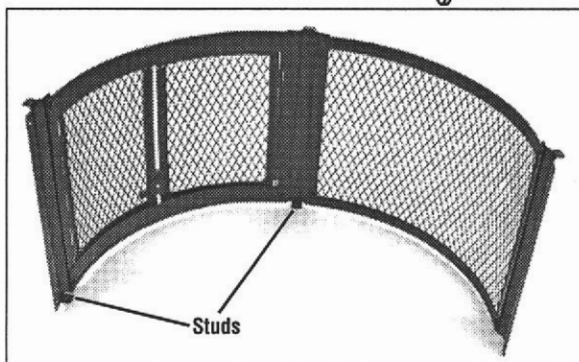
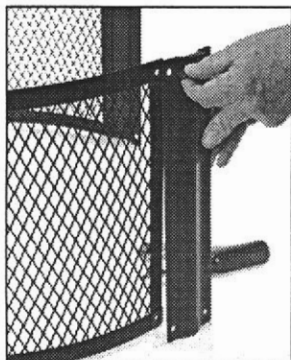
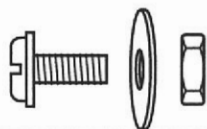

NOTE: Posts with studs must be attached to door. The studs go towards bottom.

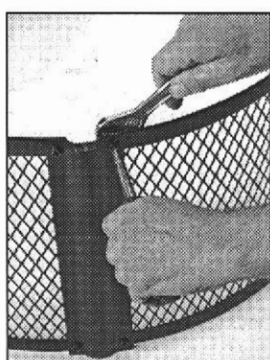
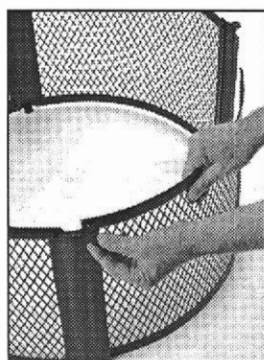
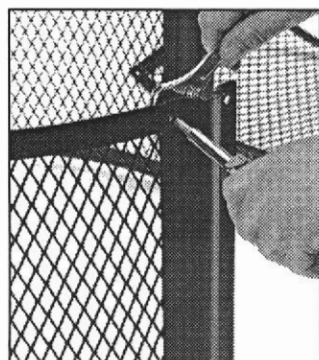

6. Place wood Grate in Fireplace.



7. Place Screen into Fireplace. Make sure studs on Screen seat in holes of Firebox.

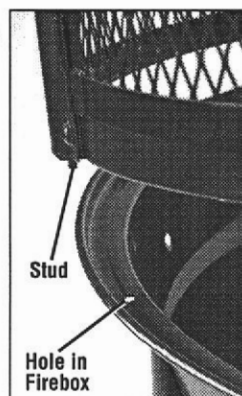

8. Place Lid on top of Screen.

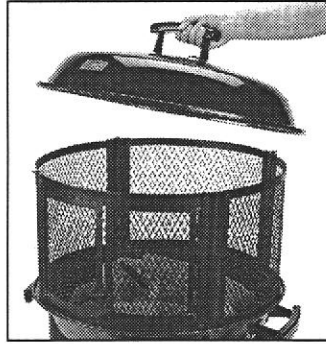

Set Up and Use

AS A FIREPLACE

⚠ WARNING

Never leave unit unattended when hot or in use. Keep out of reach of children. Outdoor use only. Never use in enclosed area. Use in unventilated areas will endanger your life.

1. Place unit on a level, noncombustible surface. Keep well away from house, garage, balconies or eave overhangs.

2. Make sure Valve is turned "OFF".

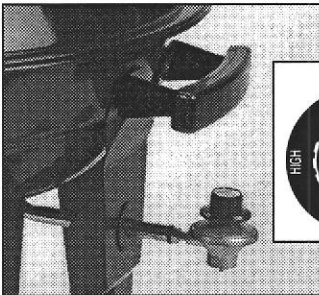

⚠ WARNING

- Always inspect propane cylinder and starter connection for damage, dirt, and debris before attaching cylinder.
- Always attach or detach cylinder outdoors away from flame, pilot lights, other ignition sources and only when fireplace is cool to touch.

3. Attach 16.4 oz propane cylinder to Control Valve.

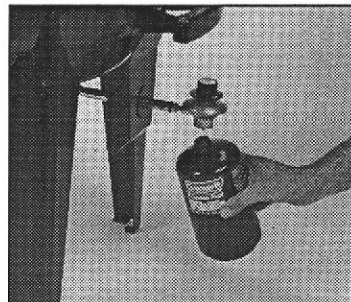

- 4.** Hold match next to Burner; push and turn Control Knob counterclockwise. Adjust Knob to desired flame level.

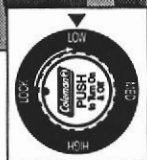
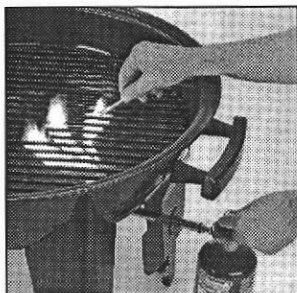
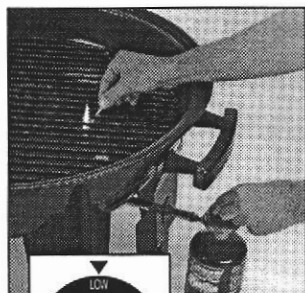

- 5.** Place Screen into Fireplace. Make sure studs on Screen seat in holes of Firebox.

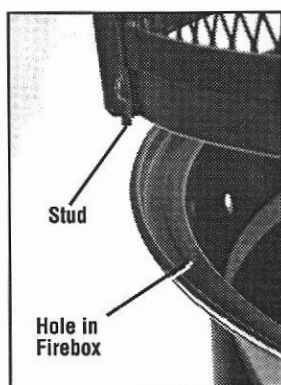

- 6.** Add wood as desired.

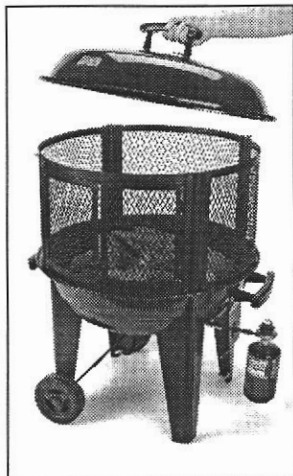
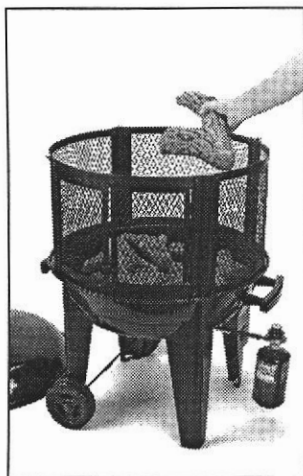

Set Up and Use

AS A GRILL

⚠ WARNING

Never leave unit unattended when hot or in use. Keep out of reach of children. Outdoor use only. Never use in enclosed area. Use in unventilated areas will endanger your life.

1. Place unit on a level, noncombustible surface. Keep well away from house, garage, balconies or eave overhangs.
2. Make sure Valve is turned "OFF".

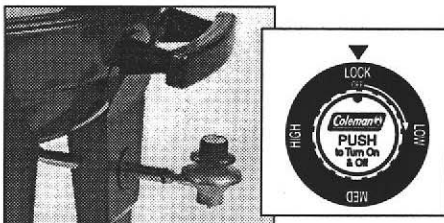

⚠ WARNING

- Always inspect propane cylinder and starter connection for damage, dirt, and debris before attaching cylinder.
- Always attach or detach cylinder outdoors away from flame, pilot lights, other ignition sources and only when fireplace is cool to touch.

3. Attach 16.4 oz propane cylinder to Control Valve.

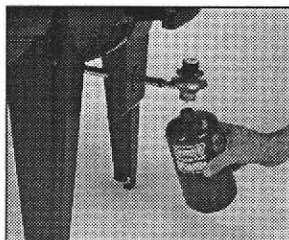

4. Hold match next to Burner; push and turn Control Knob counterclockwise. Adjust Knob to desired flame level.

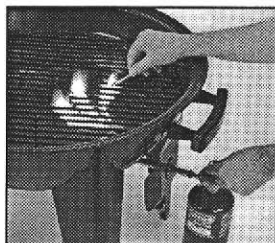
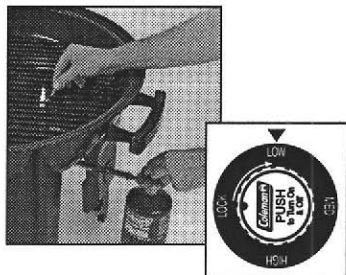

(continued on page 12)

Set Up and Use (Cont.)

AS A GRILL

5. Add charcoal as desired.

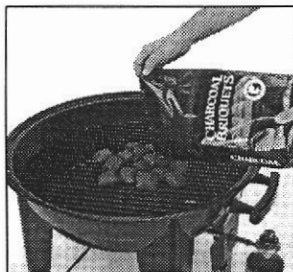

6. Turn propane off after charcoal starts.



7. Install Grill.

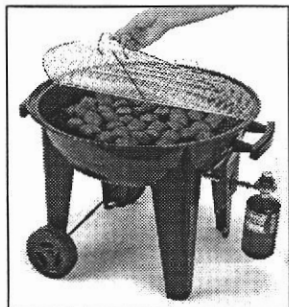

8. Damper on Lid can be adjusted to control air flow if you prefer to grill using Lid.

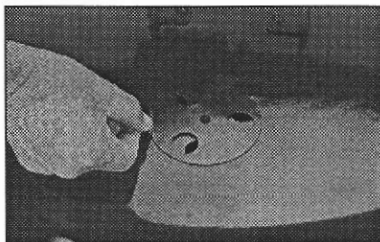

Set Up and Use

AS A FIREPLACE OR GRILL WITHOUT FIRE STARTER

⚠ WARNING

Never leave unit unattended when hot or in use. Keep out of reach of children. Outdoor use only. Never use in enclosed area. Use in unventilated areas will endanger your life.

1. Place unit on a level, noncombustible surface. Keep well away from house, garage, balconies or eave overhangs.
2. Place wood or charcoal in unit.
3. Install Screen if using as Fireplace.
4. Ignite using match and charcoal lighter fluid or newspaper.

After Use

1. Completely extinguish fire before leaving.

▲ WARNING

To avoid burns – use heavy gloves to remove screen, grate or grill.

2. Extinguish fire by removing screen assembly and placing lid over firebox.
3. Do not use water to douse the fire as this may crack the finish.
4. Dispose of cold ashes properly.
5. Be careful – fire may be out but firebox can still be hot.
Handle carefully.

Storage

1. Store in covered enclosure or place a cover over entire unit.

Parts List

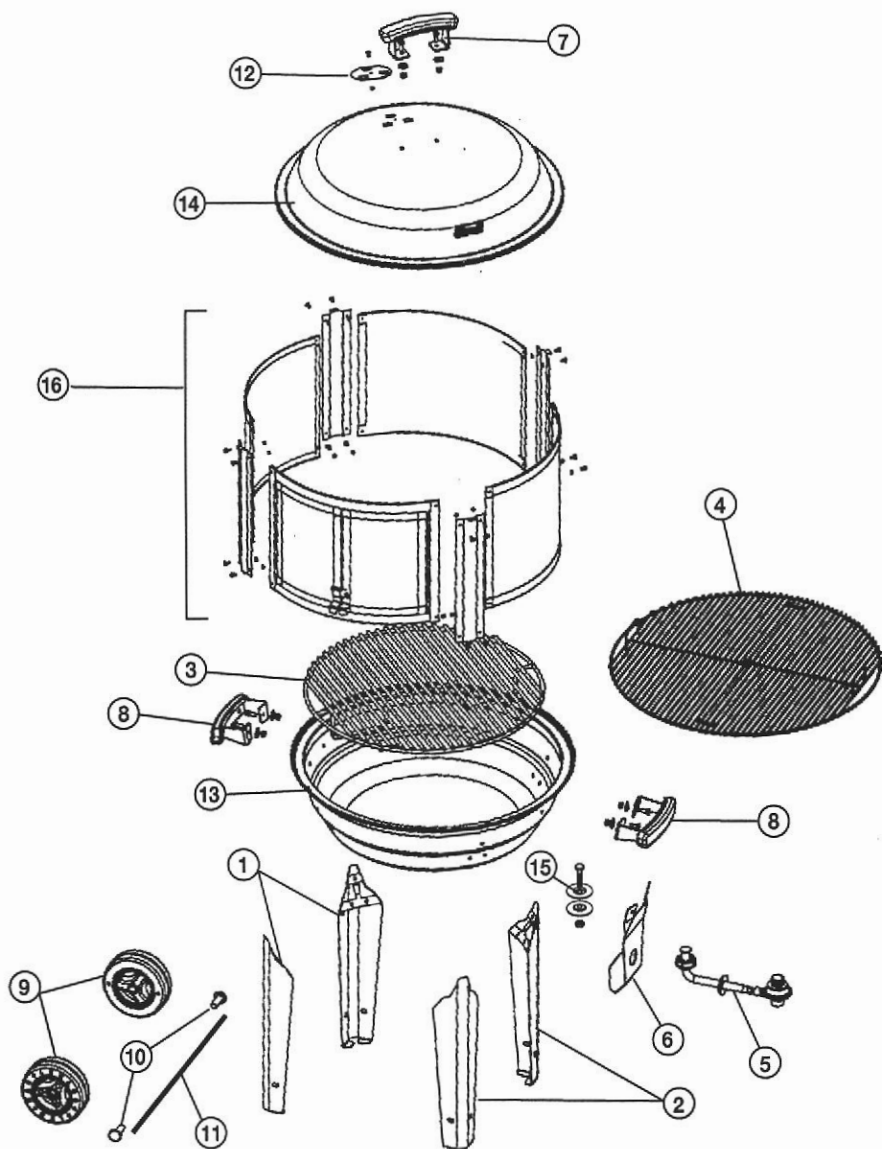

I.D. NO.	PART NO.	DESCRIPTION
1	5068-2011	Leg Assembly - Black model (w/Axle holes)
	5068-2221	Leg Assembly - Stainless Steel model (w/Axle holes)
2	5068-2021	Leg Assembly - Black model (w/o Axle holes)
	5068-2201	Leg Assembly - Stainless Steel model (w/o Axle holes)
3	5068-3111	Wood/Charcoal Grate
4	5068-3201	Cooking Grate - Black model
	5068-3211	Cooking Grate - Stainless Steel model
5	5068-5201	Firestarter (optional)
6	5068-1611	Firestarter Bracket - Black model (optional)
	5068-5211	Firestarter Bracket - Stainless Steel model (optional)
7	5068-3811	Lid Handle - Black model
	5068-3821	Lid Handle - Stainless Steel model
8	5068-3911	Handles - Black model
	5068-3501	Handles - Stainless Steel model
9	5068-2401	Wheels - Black model
10	5068-4501	Axle End Caps
11	5068-5511	Axle - Black model
	5068-5501	Axle - Stainless Steel model
12	5068-1171	Damper
13	5068-1211	Firebox (w/o Handles)
14	5068-5011	Lid (w/o Damper)
15	5068-5801	Plug w/hardware
16	5068-4011	Screen Assembly - Black model
	5068-2501	Screen Assembly - Stainless Steel model
17	5068-2701	Hardware - Black model
	5068-2551	Hardware - Stainless Steel model

Coleman Limited 7-Year Warranty

Coleman will repair or replace, at its option, this product or any component found to be defective in materials or workmanship within seven years of the original retail purchase.

This warranty is valid for the original retail purchaser from the date of initial retail purchase and is not transferable. Keep the original sales receipt. Proof of purchase is required to obtain warranty performance. Coleman dealers, service centers, or retail stores offering Coleman products do not have authority to alter, modify or in any way change the terms or conditions of this warranty.

WHAT IS NOT COVERED

- Cost of shipment to Coleman
- Normal wear and tear, including chips, scratches, abrasion, discoloration or fading from use or exposure to sunlight
- Damage caused by misuse, abuse, neglect, alterations, repairs by unauthorized persons, use of non-Coleman accessories or parts, or failure to follow recommended care or maintenance instructions
- Products used for commercial purposes or in profit or non-profit instructional or rental operations
- Mantles, generators, light bulbs, batteries or fuel
- CONSEQUENTIAL DAMAGES, INCIDENTAL DAMAGES, OR EXPENSES, INCLUDING DAMAGES TO PROPERTY. SOME STATES/PROVINCES DO NOT ALLOW THE EXCLUSION OR LIMITATION OF INCIDENTAL OR CONSEQUENTIAL DAMAGES, SO THE ABOVE LIMITATION OR EXCLUSION MAY NOT APPLY TO YOU.

IMPLIED WARRANTIES

Any implied warranties, either statutory or otherwise, including implied warranties of merchantability and fitness for a particular purpose, shall be limited to the duration and terms of the express warranties set forth in this limited warranty. Some states/provinces do not allow limitations on how long an implied warranty lasts, so the above limitation may not apply to you.

HOW TO OBTAIN WARRANTY PERFORMANCE

Take the product to an authorized Coleman Service Center. If one is not conveniently located, attach a tag to the product which includes your name, address, telephone number and description of the problem. Include a copy of the original sales receipt. Carefully package the product and send prepaid either by U.P.S. or Parcel Post, **INSURED** to: USA: The Coleman Company Inc., 3600 N. Hydraulic, Wichita, KS 67219, or CANADA: The Canadian Coleman Co., Ltd., 5975 Falbourne Street, Mississauga, Canada L5R 3V8. Please do not mail products with fuel in tanks, or with disposable propane cylinders. Remove glass globes from lanterns.

If you are located outside the United States or Canada, return this product to the place you purchased it, or to any other retailer seller of similar Coleman products, and request warranty assistance. If you are unable to obtain warranty assistance, then you may call any of the following Coleman offices for further assistance:

www.coleman.com



The Canadian Coleman Co., Ltd.
5975 Falbourne Street,
Mississauga, Canada L5R 3V8
1 800 387-6161

The Coleman Co., Inc.
3600 N. Hydraulic
Wichita, KS 67219 U.S.A.
1-800-835-3278
TDD: 316-832-8707