

D-Link Quick Installation Guide



D-Link DFM-562E
External Modem

Before Your Begin

If you purchased this Modem to make your Internet connection with PC, you must have an established Internet account from an Internet Service Provider (ISP).

Check Your Package Contents

These are the items included with your D-Link 562E purchase:



- D-Link DFM-562E External Modem



- CD-ROM (containing Manual and Q.I.G.)



- 9V AC, 0.8A Power Adapter



- Phone Cable



- RS-232 (9Pin) Cable



Using a power supply with a different voltage rating will damage and void the warranty for this product.

If any of the above items are missing, please contact your reseller.

1

Hardware Installation

Please unplug the telephone Line and plug the telephone line into the socket on the back of the modem marked LINE.

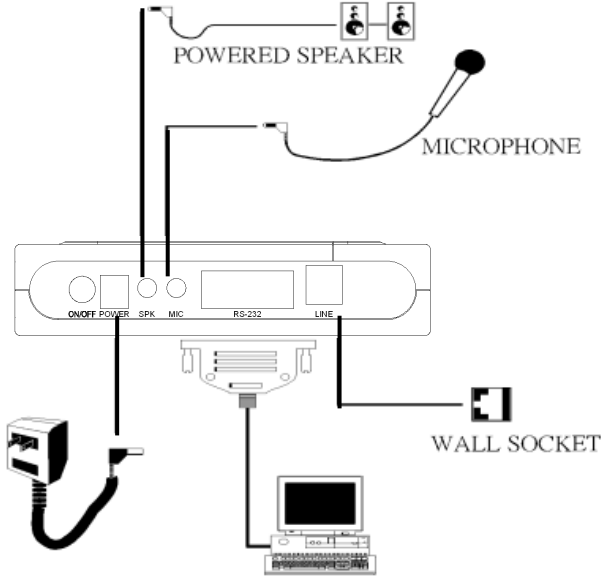

External Modem Diagram

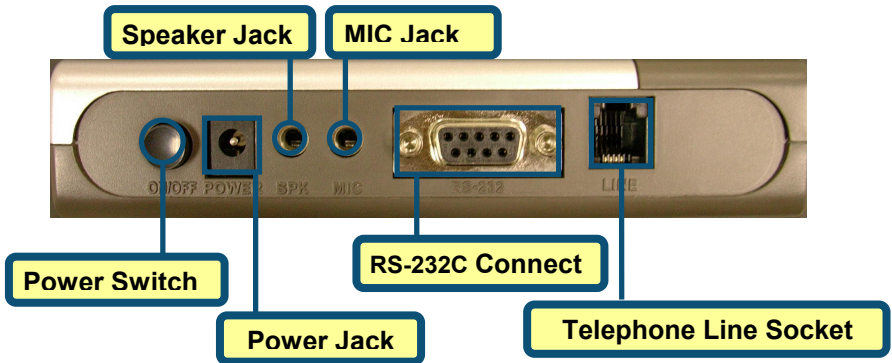

2

Install Drivers

2.1 Windows 98/ME

When the system was complete, windows will detect the modem automatic, please click **Cancel**. Then insert the driver CD supplied

Click **Install Drivers**



After system will auto Install Modem.

Please click **Close** to end the window

Click **CLOSE**



2.1 Windows 98/ME (continue)



Click **Modems**

Check Modem Model No. For **D-Link DFM-562E External Modem**.

If correct the installation is complete then click **OK** to exit.

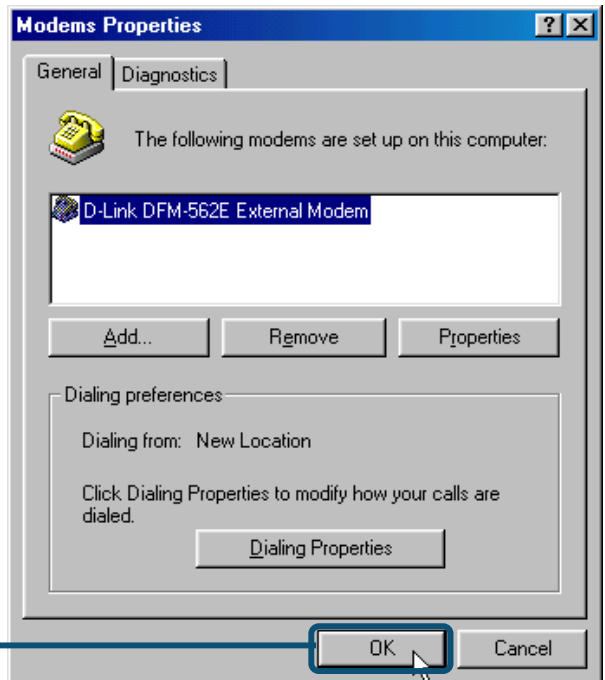

Click **OK**

2.2 Windows 2000



Click **Yes** ignore the message.

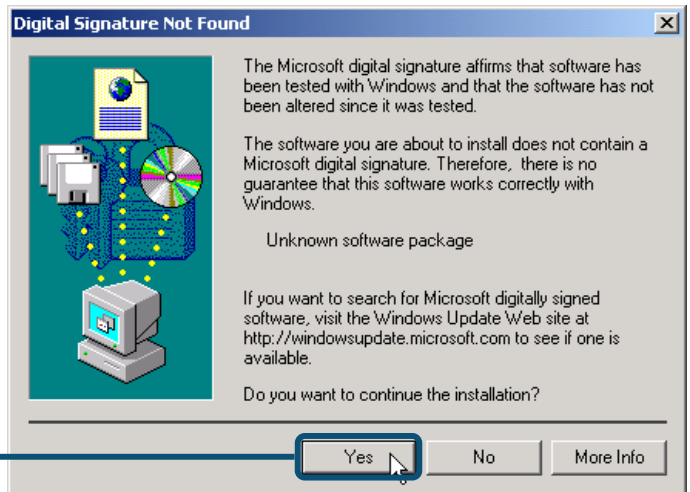

Click **Yes** ignore the message.

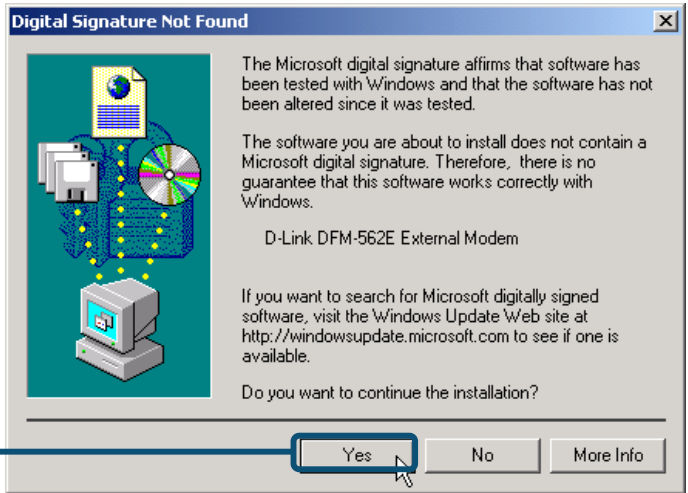

After system will auto Install Modem.

Please click **Close** to end the window



2.2 Windows 2000(continue)

Please select **Start / Settings / Control Panel** and double-click on the **Phone and Modem Options** icon.

Click **Phone and Modem Options**



Check Modem Model No. For **D-Link DFM-562E External Modem**.

If installation is complete then click **OK** to exit.

Click **OK**

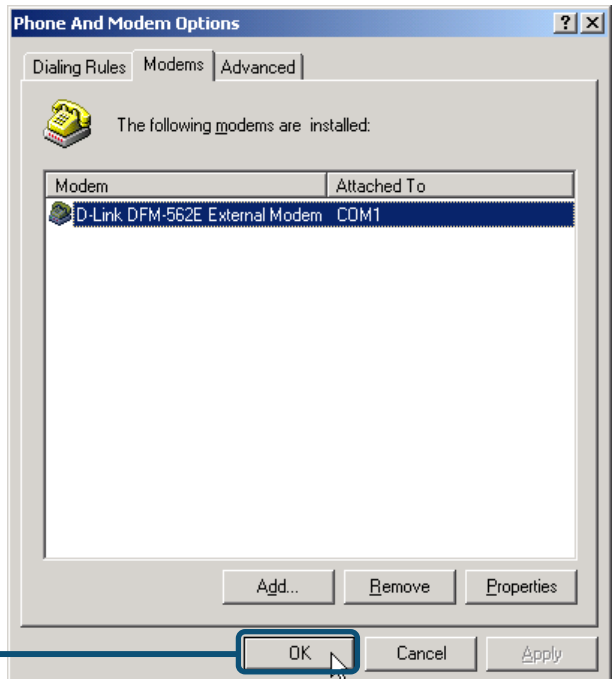

2.3 Windows XP

When the system was complete, windows will detect the modem automatic, please click **Cancel**. Then insert the driver CD supplied

Click **Install Drivers**



Click **Continue Anyway**

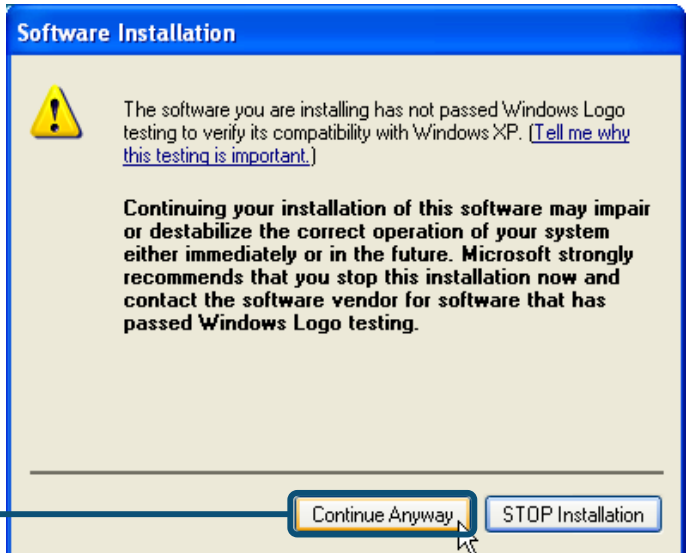

Select the **Install the software automatically [Recommended]** then click **Next** to search for the driver.



Click **Next**

Click **Continue Anyway** to skip the warning message.

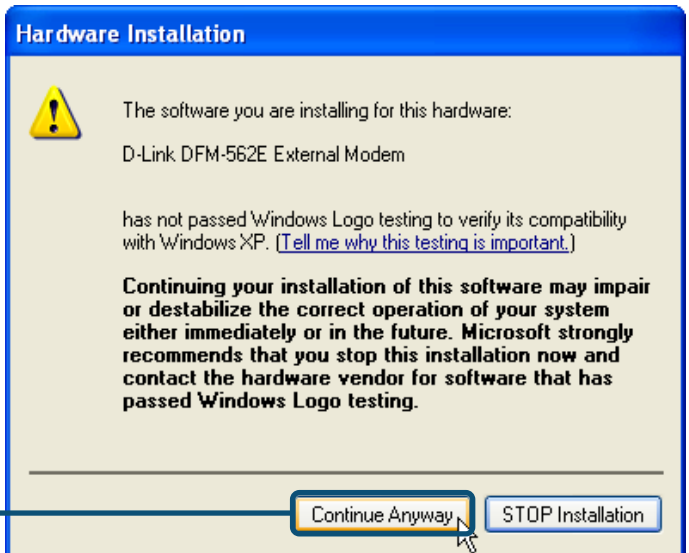

Click **Continue Anyway**

Install complete

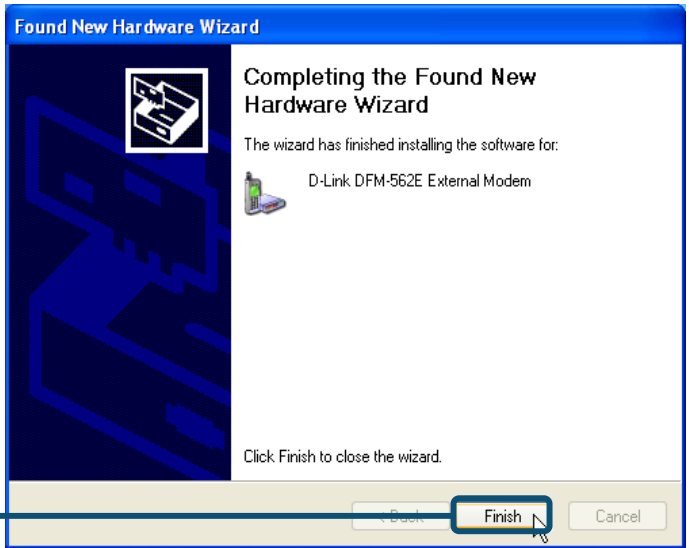

Click **Finish**

Please click **Close** to end the window



Click **CLOSE**

2.3 Windows XP(continue)

Please select **Start / Settings / Control Panel** and double-click on the **Phone and Modem Options** icon.

Click **Phone and Modem Options**

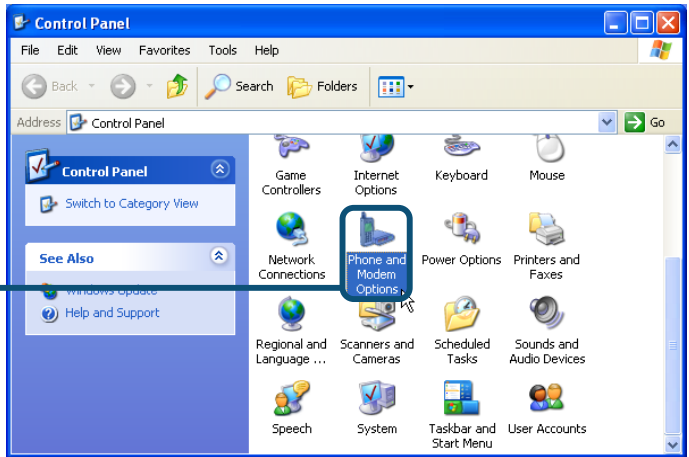

Check Modem Model No. For **D-Link DFM-562E External Modem**.

If installation is complete then click **OK** to exit.

Click **OK**

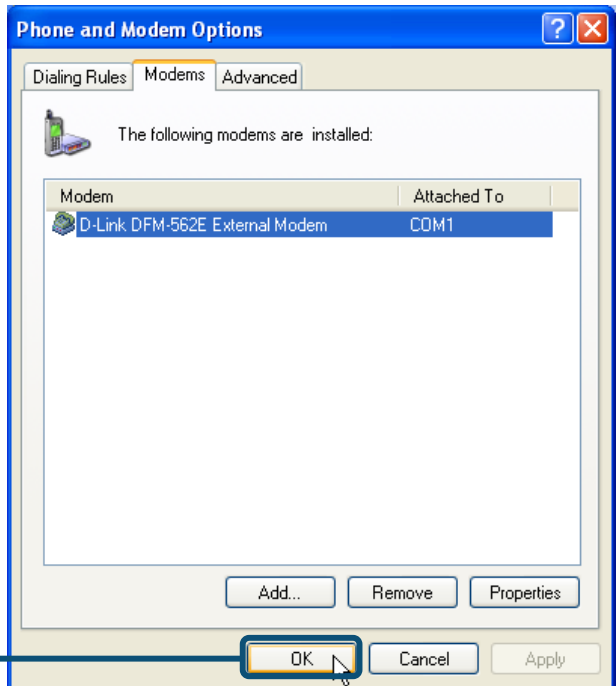

Technical Support

You can find software updates and user documentation on the D-Link website.

D-Link provides free technical support for customers within the United States and within Canada for the duration of the warranty period on this product.

U.S. and Canadian customers can contact D-Link technical support through our website, or by phone.

Tech Support for customers within the United States:

D-Link Technical Support over the Telephone:

(877) 453-5465

24 hours a day, seven days a week.

D-Link Technical Support over the Internet:

<http://support.dlink.com>

[email:support@dlink.com](mailto:support@dlink.com)

Tech Support for customers within Canada:

D-Link Technical Support over the Telephone:

(800) 361-5265

Monday to Friday 8:30am to 9:00pm EST

D-Link Technical Support over the Internet:

<http://support.dlink.ca>

[email:support@dlink.ca](mailto:support@dlink.ca)

D-Link[®]
Building Networks for People

D-Link Quick Installation Guide

D-Link DFM-562E
External Modem



Vor dem Start

Wenn Sie dieses Modem erworben haben, um mit Ihrem Computer eine Internetverbindung zu nutzen, müssen Sie über einen Account bei einem Internet-Dienstanbieter verfügen.

Lieferumfang überprüfen

Die folgenden Artikel gehören zum Lieferumfang des D-Link 562E:



• D-Link DFM-562E External Modem



• CD-ROM (mit Handbuch und Kurzanleitung für die Installation)



• Netzteil 9 V, 0.8 A



• Telefonkabel



• RS-232-Kabel, 9-polig

 Die Verwendung Netzteils mit abweichender Spannung führt zur Beschädigung des Geräts und zum

Sollte eines dieser Teile fehlen oder beschädigt sein, wenden Sie sich bitte an Ihren Fachhändler.

1

Hardware-Installation

Ziehen Sie das Telefonkabel aus der Telefonsteckdose, und verbinden Sie es mit dem mit „LINE“ gekennzeichneten Anschluss an der Rückseite des Modems.



Diagramm für externes Modem



2 Treiber installieren

2.1 Windows 98/Me

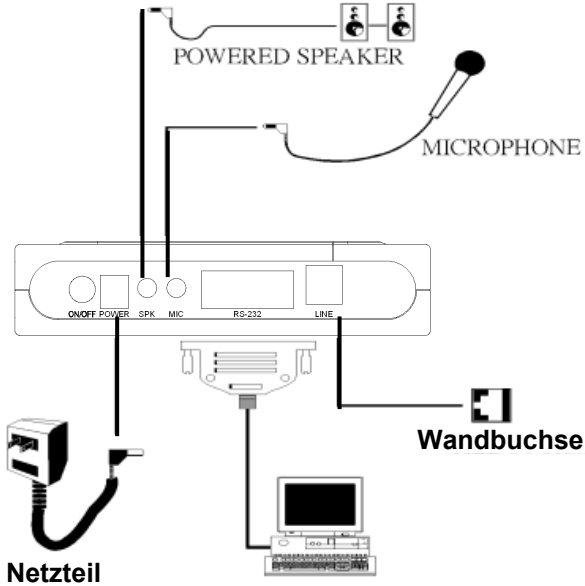
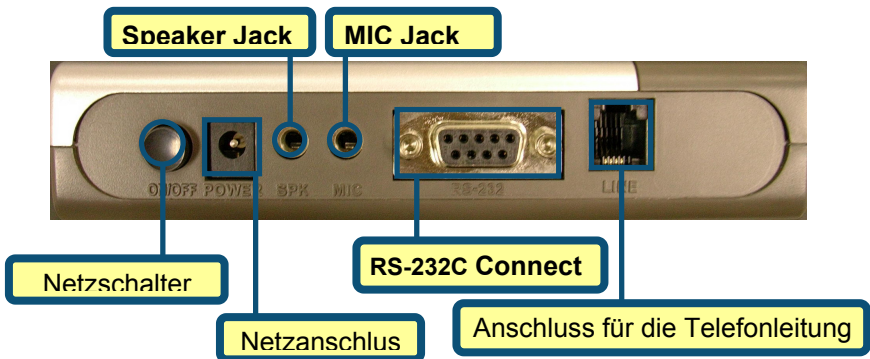
Windows erkennt das Modem automatisch. Klicken Sie auf **Abbrechen**. Legen Sie die mitgelieferte Treiber-CD ein



Das Modem wird automatisch installiert

Klicken Sie auf **CLOSE** (Schließen).



2.1 Windows 98/Me (Fortsetzung)



Klicken Sie auf
Modems.

Überprüfen Sie, ob die richtige Modem-Modell-Nr. **D-Link DFM-562E External Modem** angezeigt wird.

Stimmt diese überein, ist die Installation abgeschlossen. Klicken Sie auf **OK**.

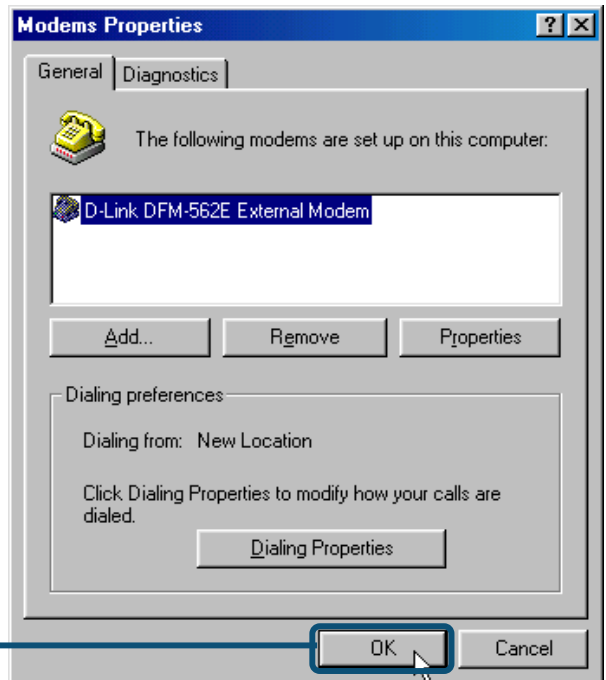

Klicken Sie
auf **OK**.

2.2 Windows 2000



Klicken Sie auf **Install Drivers** (Treiber installieren).

Klicken Sie auf **Ja**, um die Nachricht zu ignorieren.

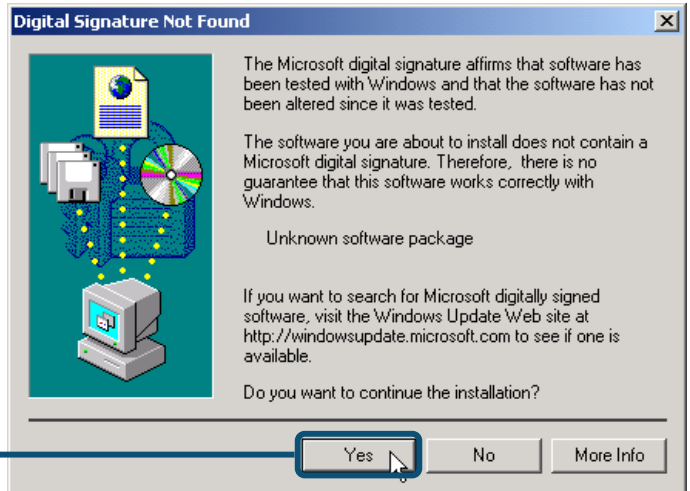

Klicken Sie auf **Ja**.

Klicken Sie auf **Ja**,
um die Nachricht
zu ignorieren.

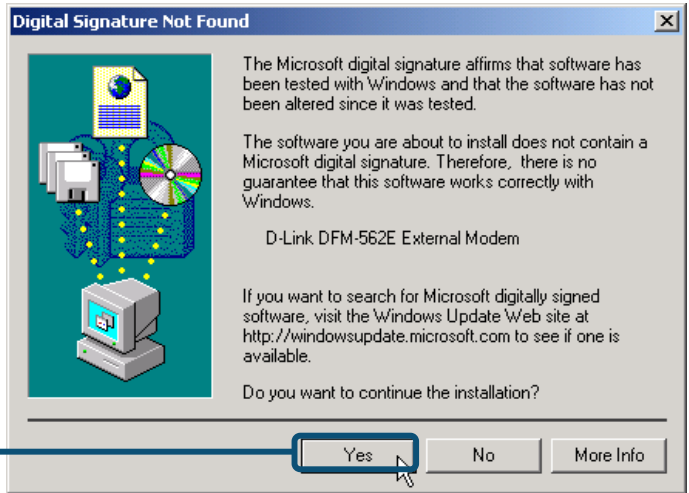

Klicken
Sie auf **Ja**.

Das Modem wird
automatisch installiert.

Klicken Sie auf **Close**
(Schließen), um das
Fenster zu schließen.



Klicken Sie
auf **CLOSE**
(Schließen).

2.2 Windows 2000 (Fortsetzung)

Wählen Sie **Start > Einstellungen > Systemsteuerung**.

Doppelklicken Sie auf das Symbol **Telefon- und Modemoptionen**.

Klicken Sie auf **Telefon- und Modemoptionen**.



Überprüfen Sie, ob die richtige Modem-Modell-Nr. **D-Link DFM-562E External Modem** angezeigt wird. Wenn die Installation abgeschlossen ist, klicken Sie auf **OK**.

Klicken Sie auf **OK**.

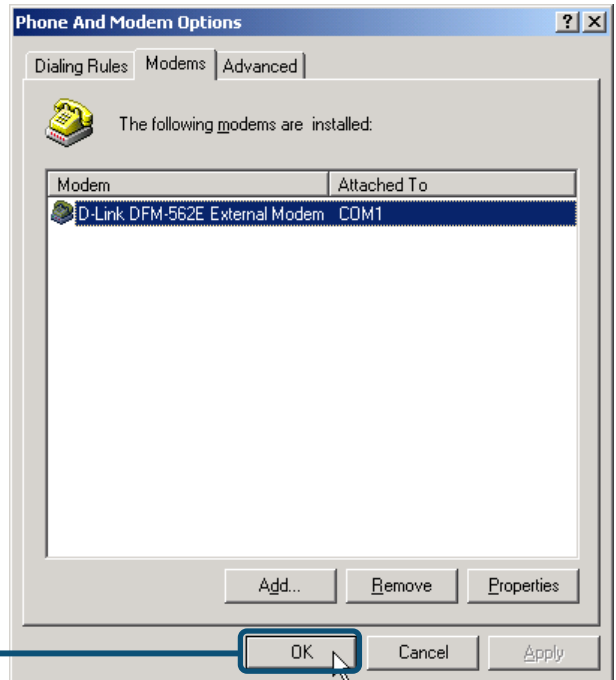

2.3 Windows XP

Windows erkennt das Modem automatisch. Klicken Sie auf **Abbrechen**. Legen Sie die mitgelieferte Treiber-CD ein

Klicken Sie auf **Install Drivers** (Treiber installieren).



Software Installation



The software you are installing has not passed Windows Logo testing to verify its compatibility with Windows XP. ([Tell me why this testing is important.](#))

Continuing your installation of this software may impair or destabilize the correct operation of your system either immediately or in the future. Microsoft strongly recommends that you stop this installation now and contact the software vendor for software that has passed Windows Logo testing.

Continue Anyway

STOP Installation

Klicken Sie auf **Installation fortsetzen**.

Wählen Sie **Software automatisch installieren (empfohlen)**, und klicken Sie dann auf **Weiter**, um den Treiber zu suchen.

Klicken Sie auf **Weiter**.



Klicken Sie auf **Installation fortsetzen**, um die Warnmeldung zu ignorieren.

Klicken Sie auf **Weiter**.

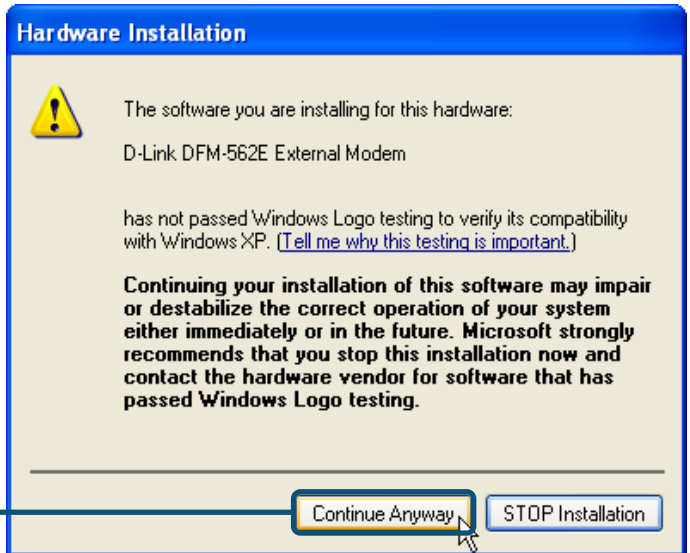

Installation
abgeschlossen

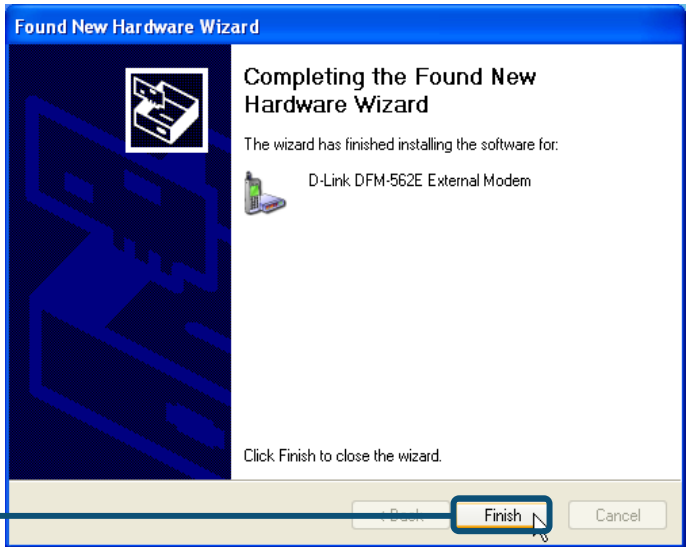

Klicken Sie
auf **Fertig
stellen.**

Klicken Sie auf
Schließen, um das
Fenster zu schließen.



Klicken Sie auf
Schließen.

2.3 Windows XP (Fortsetzung)

Klicken Sie auf **Start > Einstellungen > Systemsteuerung**.

Doppelklicken Sie nun auf das Symbol **Telefon- und Modemoptionen**.

Klicken Sie auf **Telefon- und Modemoptionen**.

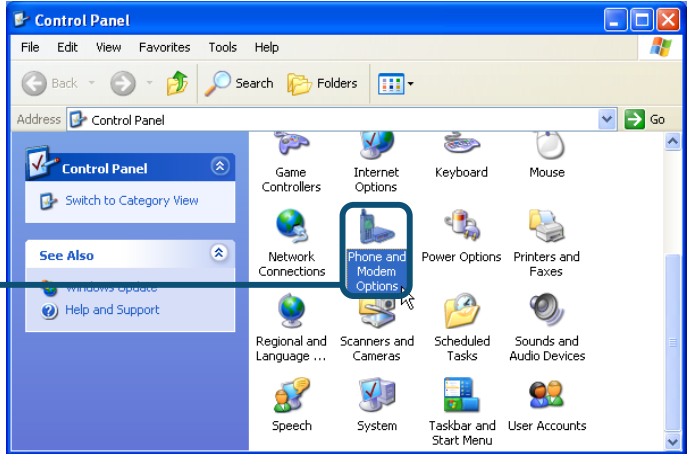

Überprüfen Sie, ob die richtige Modem-Modell-Nr. **D-Link DFM-562E External Modem** angezeigt wird.

Wenn die Installation abgeschlossen ist, klicken Sie auf **OK**.

Klicken Sie auf **OK**.

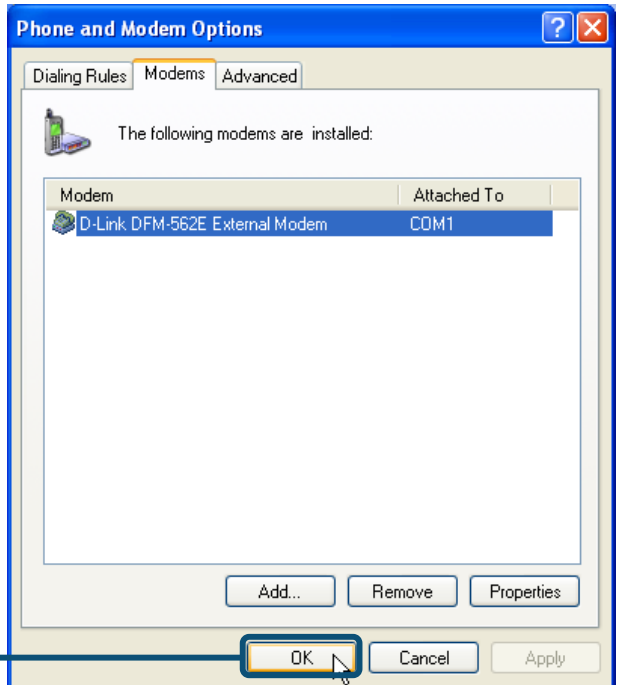

Technische Unterstützung

Aktualisierte Versionen von Software und Benutzerhandbuch finden Sie auf der Website von **D-Link** unter www.dlink.de

D-Link bietet kostenfreie technische Unterstützung für Kunden in Deutschland, Österreich, der Schweiz und in Osteuropa.

Unsere Kunden können technische Unterstützung über unsere Website oder telefonisch anfordern.

Technische Unterstützung von D-Link per Telefon:
00800 7250 4000

Telefonische technische Unterstützung erhalten Sie montags bis donnerstags von 08.00 bis 19.00 Uhr, freitags von 08.00 bis 17.00 Uhr.

Technische Unterstützung von D-Link im Internet:
www.dlink.de

D-Link[®]
Building Networks for People

D-Link Quick Installation Guide



Modem externe
DFM-562E D-Link

Avant de commencer

Si vous avez acheté ce modem pour pouvoir vous connecter à l'internet à partir de votre PC, il vous faut un compte internet auprès d'un fournisseur de services internet (ISP).

Vérifiez le contenu de l'emballage

Voici les éléments que doit contenir l'emballage du DFM-562E D-Link :



- Modem externe DFM-562E D-Link



- CD-ROM (contenant le manuel et le guide d'installation rapide)



- Adaptateur secteur 9V AC, 0.8A



- Câble téléphonique



- Câble RS 232 (9 points)



L'alimentation du modem sous une tension différente de la tension nominale endommagera ce produit et annulera la garantie

Si l'un des éléments ci-dessus manque, contactez votre revendeur.

1

Installation du matériel

Débranchez la ligne téléphonique et branchez-la sur la prise marquée LINE qui se trouve à l'arrière du modem.



Schéma d'installation du modem externe



2

Installation des pilotes

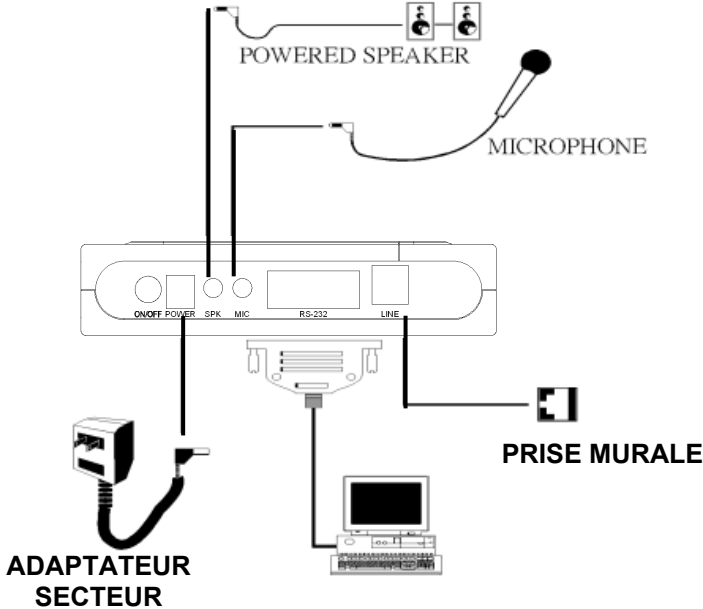
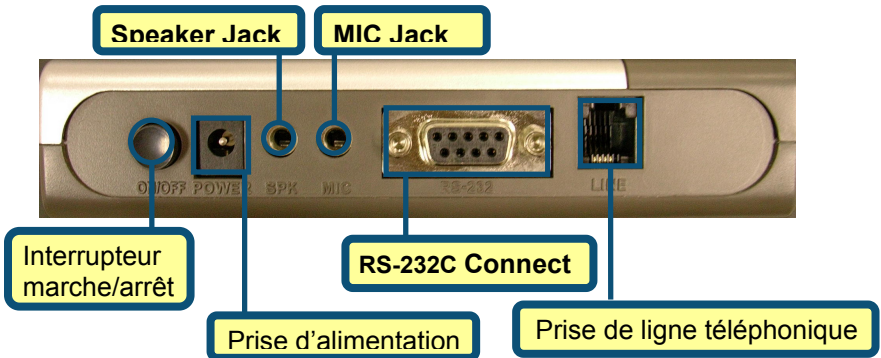
2.1 Windows 98/ME

Une fois le matériel installé, Windows détecte automatiquement le modem. Cliquez sur **Annuler**. Puis mettez le CD fourni dans le lecteur de CD-ROM.

Cliquez sur **Install Drivers**



Le système installe automatiquement le modem.

Cliquez sur **CLOSE** pour fermer la fenêtre.

Cliquez sur **CLOSE**



2.1 Windows 98/ME (suite)

Cliquez sur
Modems



Vérifiez le numéro de modèle
du **modem externe**
DFM-562E D-Link.

S'il est correct, c'est que
l'installation est terminée.
Cliquez sur **OK** pour quitter.

Cliquez
sur **OK**



2.2 Windows 2000

D-Link
Building Networks for People

Easy Way to Internet
56K Analog Connection
DFM-562E

WORKS WITH WINDOWS
FOR DESKTOPS
HIGH PERFORMANCE

56K External Data/Fax/Voice
Modem

Install Drivers
View Quick Install Guide (PDF)
View Manual (PDF)
Install BVRP
Install Adobe Acrobat Reader

CLOSE

Cliquez sur **Install Drivers**

Digital Signature Not Found

The Microsoft digital signature affirms that software has been tested with Windows and that the software has not been altered since it was tested.

The software you are about to install does not contain a Microsoft digital signature. Therefore, there is no guarantee that this software works correctly with Windows.

Unknown software package

If you want to search for Microsoft digitally signed software, visit the Windows Update Web site at <http://windowsupdate.microsoft.com> to see if one is available.

Do you want to continue the installation?

Yes No More Info

Cliquez sur **Oui** pour ignorer le message

Cliquez sur **Oui**

Cliquez sur **Oui** pour ignorer le message

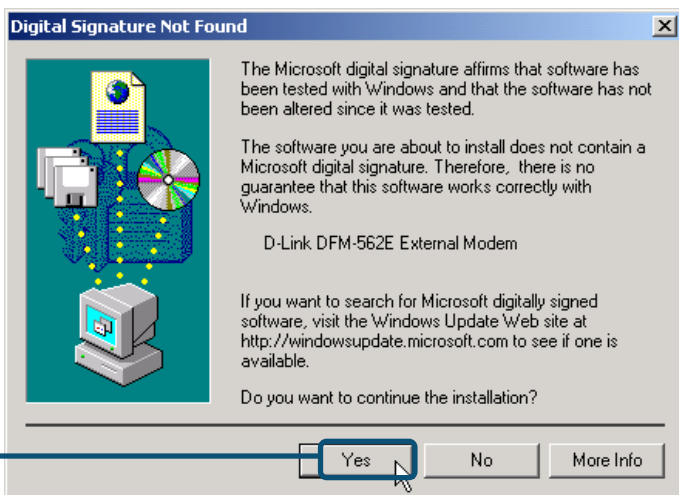

Cliquez sur **Oui**

Le système installe automatiquement le modem.

Cliquez sur **CLOSE** pour fermer la fenêtre.



Cliquez sur **CLOSE**

2.2 Windows 2000(suite)

Sélectionnez **Démarrer / Paramètres / Panneau de configuration** et double-cliquez sur l'icône **Options de modems et téléphonie**.

Cliquez sur **Options de modems et téléphonie**



Vérifiez le numéro de modèle du **modem externe DFM-562E D-Link**.

S'il est correct, c'est que l'installation est terminée. Cliquez sur **OK** pour quitter.

Cliquez sur **OK**

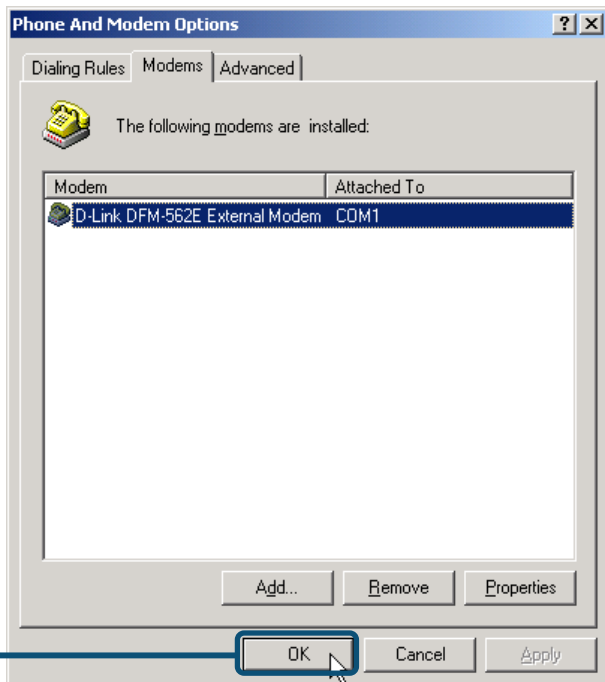

2.3 Windows XP

Une fois le matériel installé, Windows détecte automatiquement le modem. Cliquez sur **Annuler**. Puis mettez le CD fourni dans le lecteur de CD-ROM.

Cliquez sur **Install Drivers**



Cliquez sur **Continuer**



Sélectionnez l'option **Installer le logiciel automatiquement [recommandé]**, puis cliquez sur **Suivant** pour rechercher le pilote.



Cliquez sur **Suivant**

Cliquez sur **Continuer** pour sauter le message d'avertissement.



Cliquez sur **Continuer**

L'installation est terminée.

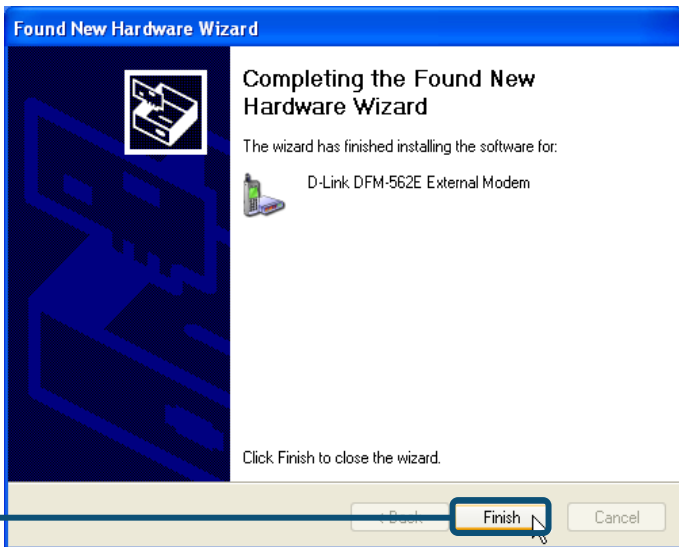

Cliquez sur
Terminer

Cliquez sur **CLOSE** pour fermer la fenêtre.



Cliquez sur
CLOSE

2.3 Windows XP (suite)

Sélectionnez **Démarrer / Paramètres / Panneau de configuration** et double-cliquez sur l'icône **Options de modems et téléphonie**.

Cliquez sur **Options de modems et téléphonie**

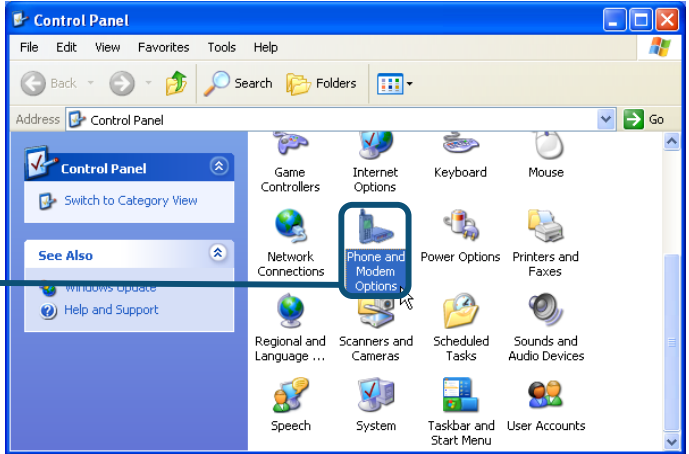

Vérifiez le numéro de modèle du **modem externe DFM-562E D-Link**.

S'il est correct, c'est que l'installation est terminée. Cliquez sur **OK** pour quitter.

Cliquez sur **OK**

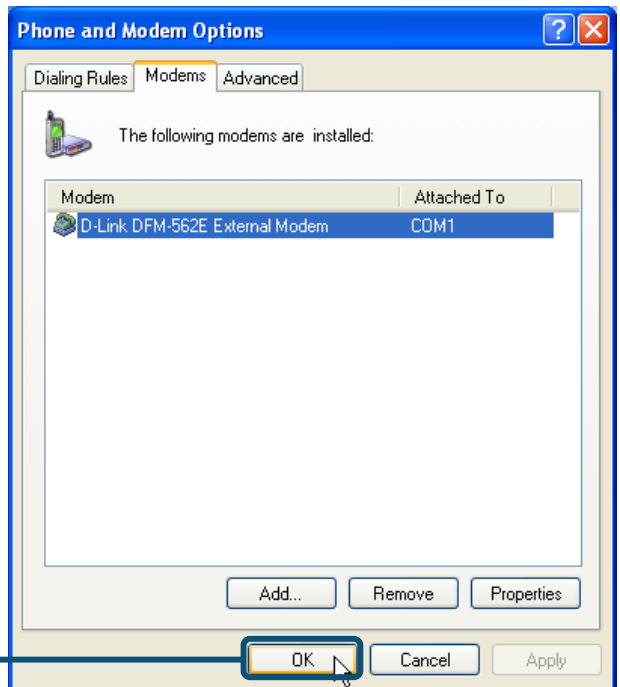

Assistance technique

Vous trouverez la documentation et les logiciels les plus récents sur le site web **D-Link**.

Le service technique de **D-Link** est gratuit pour les clients aux Etats-Unis durant la période de garantie.

Ceux-ci peuvent contacter le service technique de **D-Link** par notre site internet ou par téléphone.

Assistance technique D-Link par téléphone :
0 820 0803 03

Assistance technique D-Link sur internet :
Web : <http://www.dlink.fr>
E-mail : support@dlink.fr

D-Link®
Building Networks for People

D-Link Quick Installation Guide

D-Link DFM-562E
External Modem



Antes de empezar

Si se ha adquirido este módem Para establecer una conexión Internet con un PC, Se ha de disponer de una cuenta Internet con un proveedor de servicios Internet (ISP).

Comprobar el contenido del paquete

Éstos son los artículos incluidos en el D-Link 562E:



- D-Link DFM-562E External Modem



- CD-ROM (contiene manual y guía de instalación rápida)



- Adaptador de alimentación 9V AC, 0.8A



- Cable telefónico



- Cable RS-232 (9Pin)



El uso de una fuente de alimentación con distinto voltaje puede ser perjudicial y anular la garantía de este

Si falta alguno de estos componentes, por favor contacte con su proveedor.

1

Instalar el hardware

Desconectar la línea telefónica y conectarla en la ranura del panel trasero del módem, marcada como LINE.



Diagrama módem externo



2

Instalar controladores

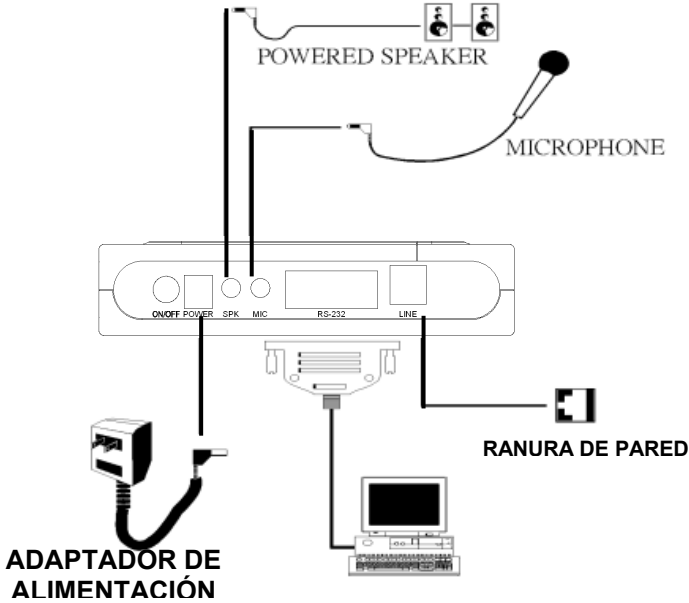
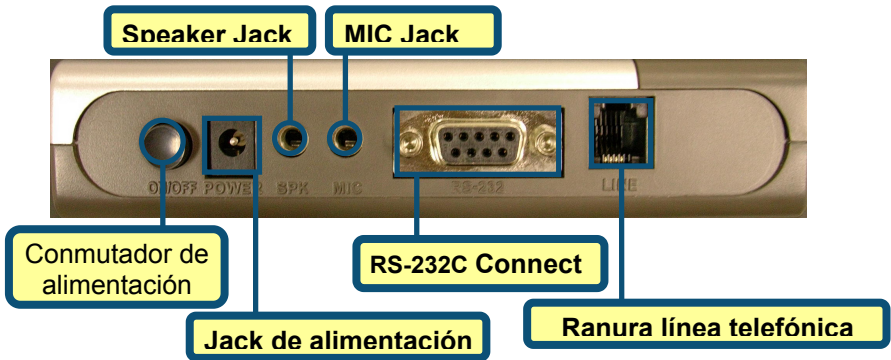
2.1 Windows 98/ME

Cuando el sistema esté completo, Windows detectará automáticamente el módem; hacer click en **Cancel**. Después, introducir el CD suministrado.

Hacer click en **Install Drivers**



El sistema instalará automáticamente el módem.

Hacer click en **Close** para cerrar la ventana.

Hacer click en **CLOSE**

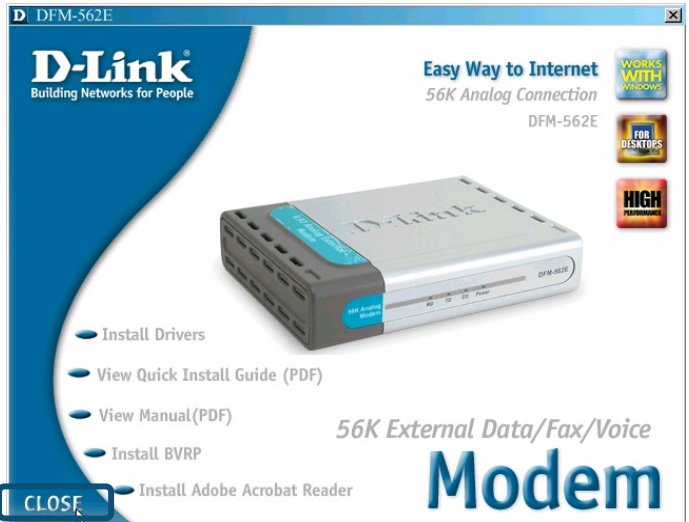

2.1 Windows 98/ME (continuación)

Hacer click en **Modems**



Comprobar el nº de modelo del módem **D-Link DFM-562E External Modem**.

Si es correcto, la instalación ha finalizado, hacer click en **OK** para salir.

Hacer click en **OK**

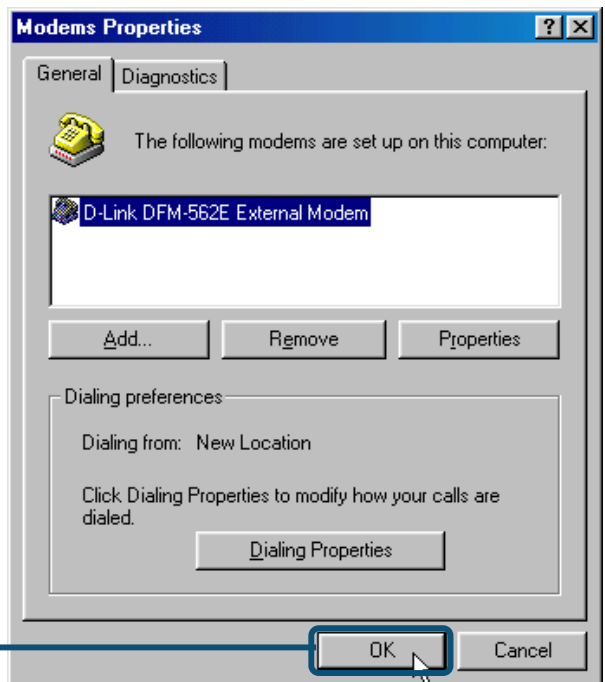

2.2 Windows 2000



Hacer click en **Install Drivers**

Hacer click en **Yes** para ignorar el mensaje.

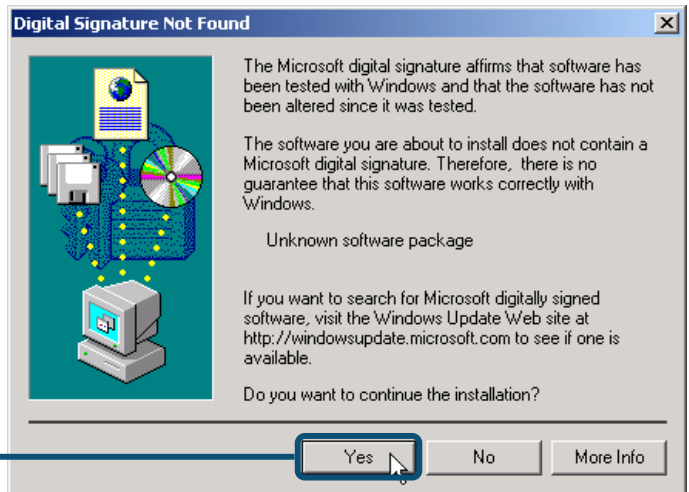

Hacer click en **Yes**

Hacer click en **Yes** para ignorar el mensaje.

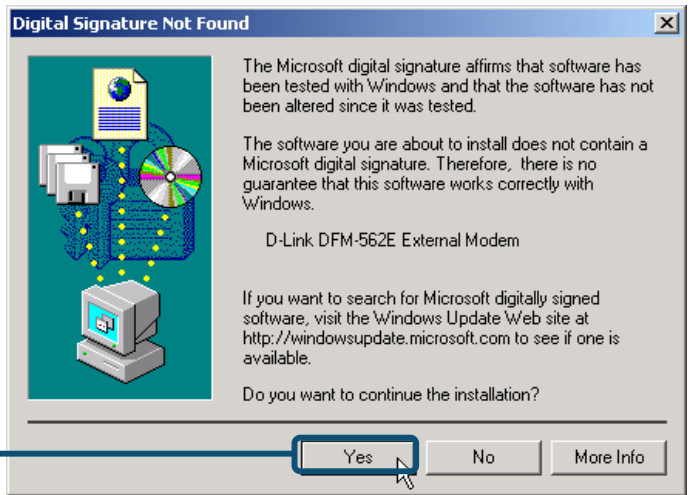

Hacer click en **Yes**

El sistema instalará automáticamente el módem.

Hacer click en **Close** para cerrar la ventana.



Hacer click en **CLOSE**

2.2 Windows 2000 (continuación)

Seleccionar **Start / Settings / Control Panel** y hacer doble click en el icono **Phone and Modem Options**.

Hacer click en **Phone and Modem Options**



Comprobar el nº de modelo del módem **D-Link DFM-562E External Modem**.

Si la instalación ha finalizado, hacer click en **OK** para salir.

Hacer click en **OK**

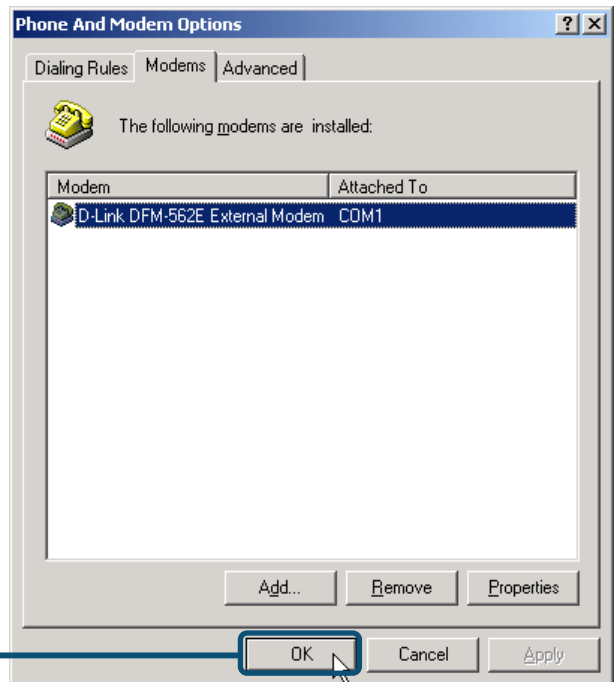

2.3 Windows XP

Cuando el sistema esté completo, Windows detectará automáticamente el módem; hacer click en **Cancel**. Después, introducir el CD suministrado.

Hacer click en **Install Drivers**



Hacer click en **Continue Anyway**

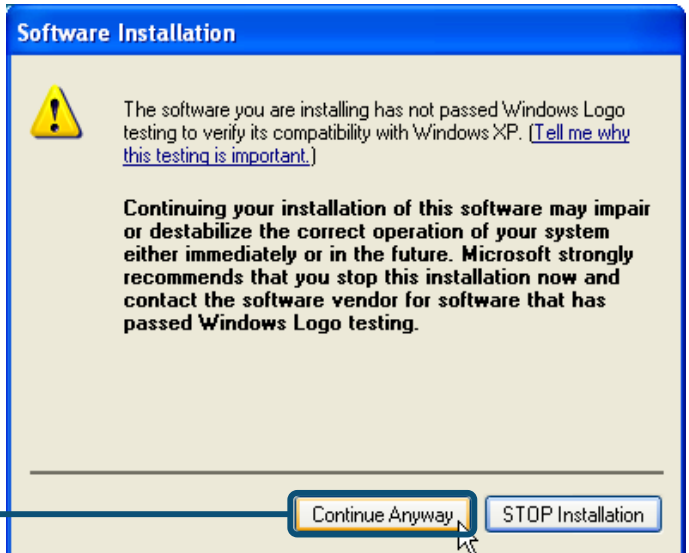

Seleccionar **Install the software automatically [Recommended]**, después hacer click en **Next** para buscar el controlador.

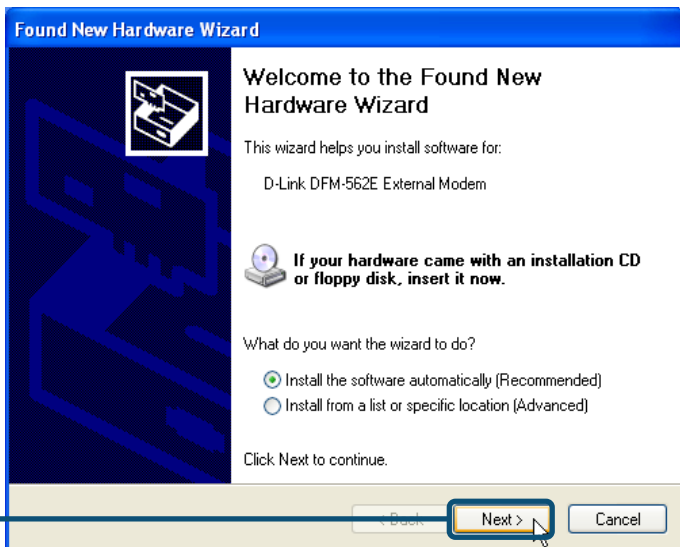

Hacer click en **Next**

Hacer click en **Continue Anyway** para obviar el mensaje de advertencia.



Hacer click en **Continue Anyway**

Completar la instalación

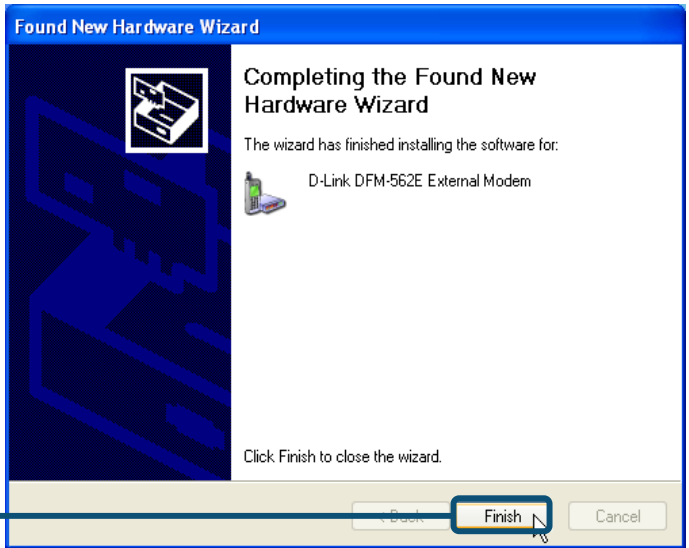

Hacer click en **Finish**

Hacer click en **Close** para cerrar la ventana



Hacer click en **CLOSE**

2.3 Windows XP (continuación)

Seleccionar **Start / Settings / Control Panel** y hacer doble click en el icono **Phone and Modem Options**.

Hacer click en **Phone and Modem Options**

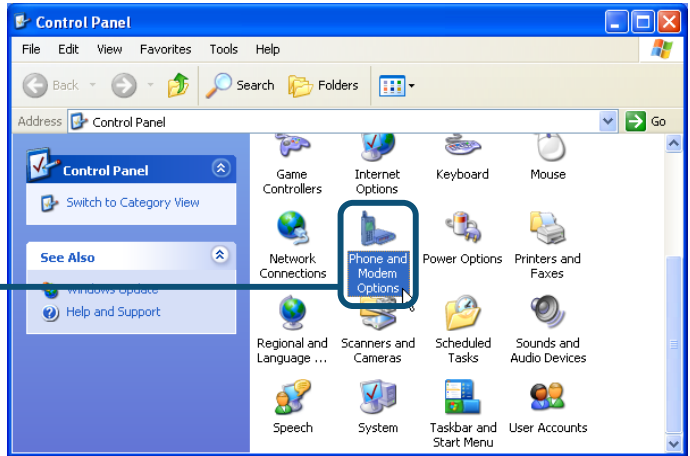

Comprobar el n° de modelo del módem **D-Link DFM-562E External Modem**.

Si la instalación ha finalizado, hacer click en **OK** para salir.

Hacer click en **OK**

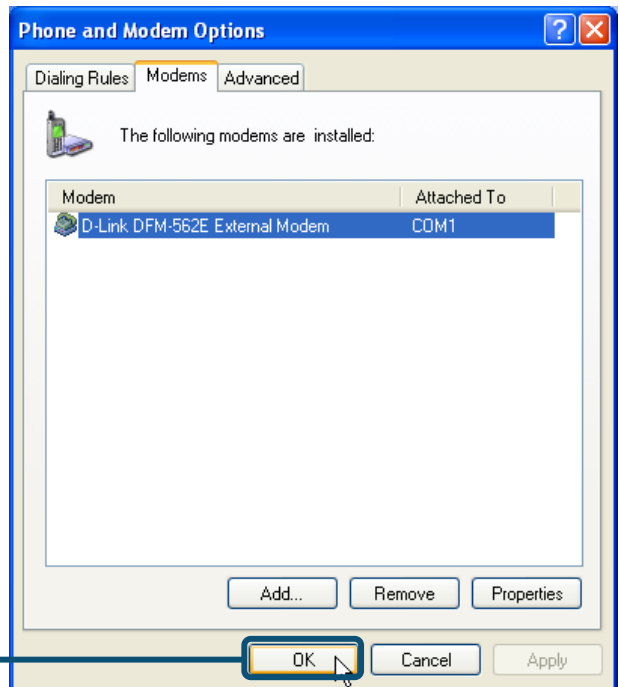

Asistencia Técnica

Puede encontrar el software más reciente y documentación para el usuario en el sitio web de **D-Link** .

D-Link ofrece asistencia técnica gratuita para clientes dentro de España durante el periodo de garantía del producto.

Los clientes españoles pueden ponerse en contacto con la asistencia técnica de **D-Link** a través de nuestro sitio web o por teléfono.

Asistencia Técnica de D-Link por teléfono:

93-4090775

de lunes a viernes desde las 9:00 hasta las 14:00 y de las 15:30 hasta las 18:30

Asistencia Técnica de D-Link a través de Internet:

<http://www.dlink.es/supporto/main/view.html>

email: soporte@dlink.es

D-Link[®]
Building Networks for People

D-Link Quick Installation Guide

Modem esterno
D-Link DFM-562E



Prima di cominciare

Se si desidera utilizzare il Modem per connettersi a Internet da un PC, è necessario richiedere un account Internet a un Internet Service Provider (ISP).

Contenuto del pacchetto

Il pacchetto del modem D-Link 562E include i seguenti componenti:



• Modem esterno D-Link DFM-562E



• CD-ROM (con manuale utente e manuale rapido d'installazione.)



• Trasformatore 9V CA, 0.8A



• Cavo telefonico



• Cavo RS-232 (9Pin)



L'utilizzo di un trasformatore differente può danneggiare il dispositivo e compromettere la garanzia

Se uno dei componenti dovesse risultare mancante, contattare il rivenditore.

1

Installazione hardware

Disconnettere la linea telefonica e connetterla al connettore LINE posto sul pannello posteriore del modem.

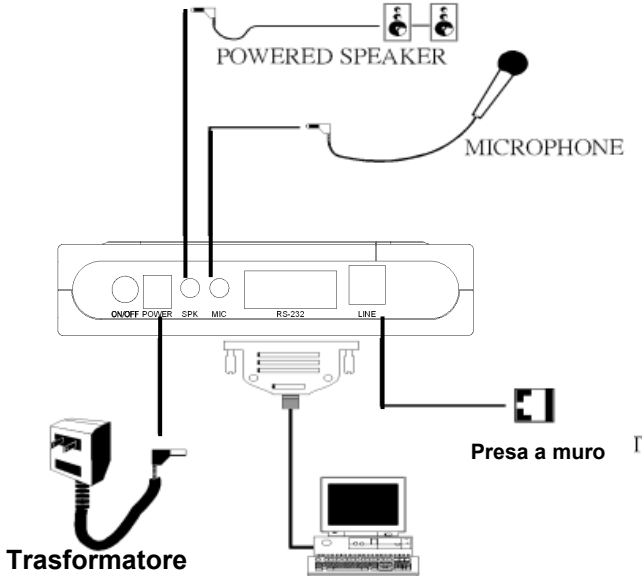

Schema del modem esterno

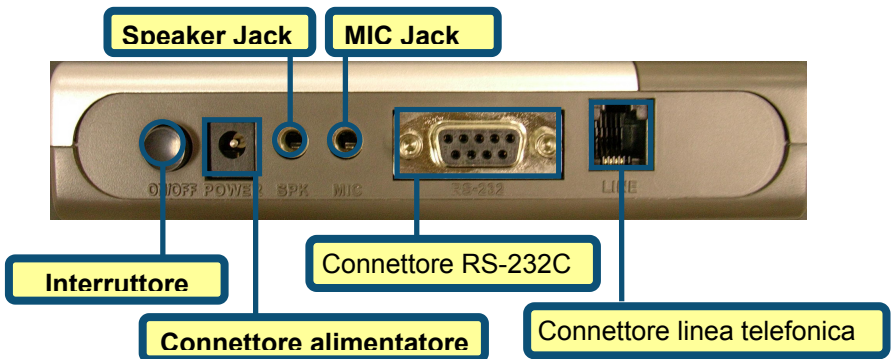

2

Installazione dei driver

2.1 Windows 98/ME

Quando il sistema è completo, Windows individua automaticamente il modem. Cliccare su **Cancel** e inserire il CD dei driver

Cliccare su **Install Drivers**



Il sistema installa automaticamente il Modem.

Cliccare su **Close** per chiudere la finestra

Cliccare su **CLOSE**



2.1 Windows 98/ME (continua)



Verificare il numero di modello per il modem esterno **D-Link DFM-562E**.

Se è corretto, l'installazione è completa. Cliccare su **OK** per uscire.

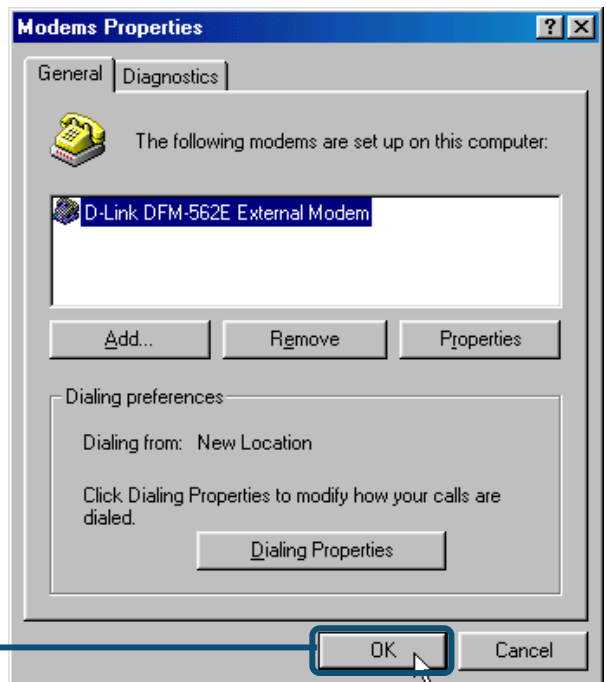

2.2 Windows 2000



Cliccare su **Si** per ignorare il messaggio.

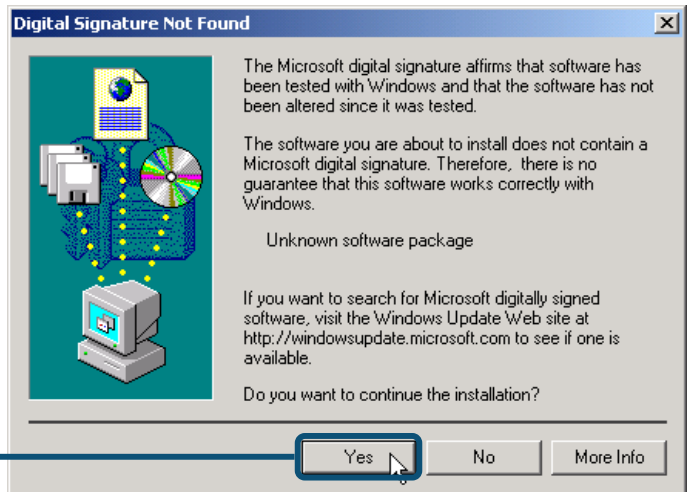

Cliccare su **Si** per ignorare il messaggio.

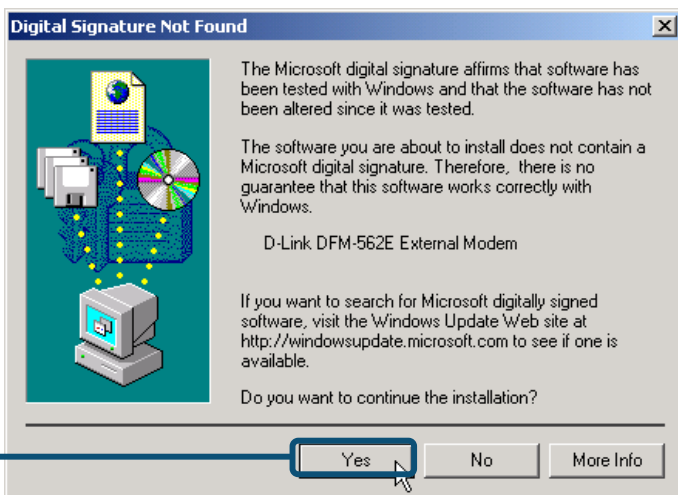

Cliccare su **Si**

Il sistema installa automaticamente il modem.

Cliccare su **Close** per chiudere la finestra



Cliccare su **CLOSE**

2.2 Windows 2000(continua)

Selezionare **Start / Impostazioni / Pannello di Controllo**. Fare doppio clic sull'icona **Opzioni Telefono e Modem**.

Cliccare su **Opzioni Telefono e Modem**



Verificare il numero di modello per il modem esterno **D-Link DFM-562E**. Se l'installazione è completa, cliccare su **OK** per uscire.

Cliccare su **OK**

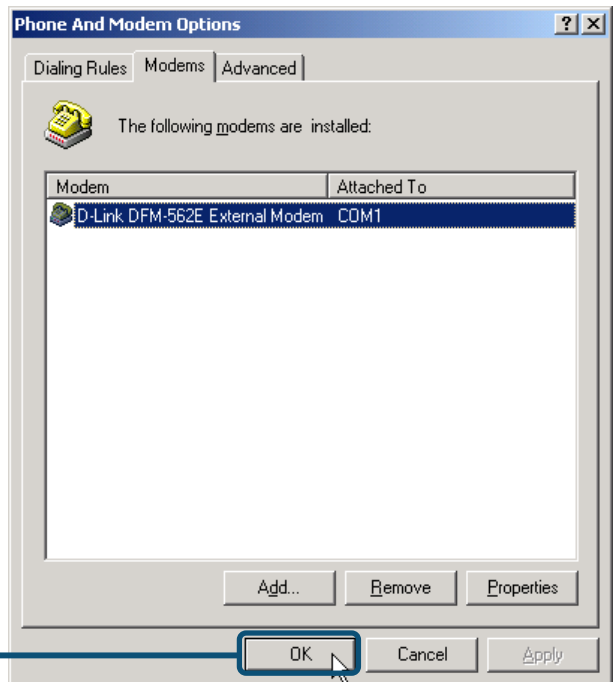

2.3 Windows XP

Quando il sistema è completo, windows individua automaticamente il modem. Cliccare su **Cancel** e inserire il CD dei driver fornito con il dispositivo

Cliccare su **Install Drivers**



Cliccare su **Continua**

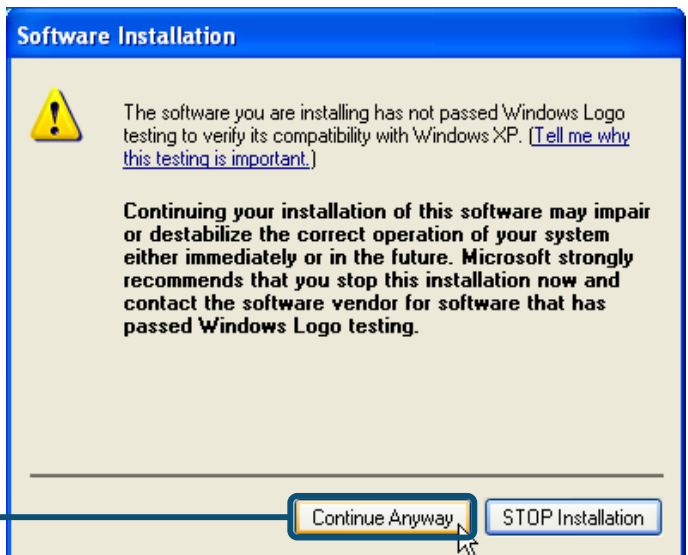

Selezionare **Installa Automaticamente il [Raccomandato]** Cliccare su **Avanti** per avviare la ricerca del driver.



Cliccare su **Avanti**

Cliccare su **Continua** per ignorare il messaggio.



Cliccare su **Continua**

L'installazione è
terminata

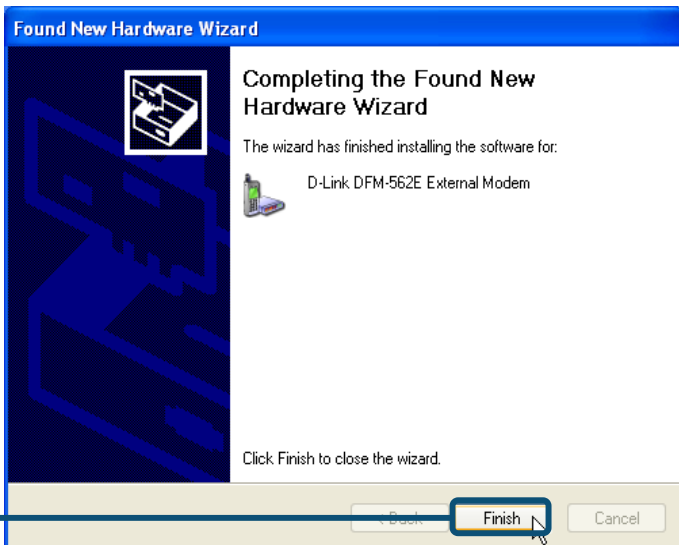

Cliccare su **Fine**

Cliccare su
Close per chiudere
la finestra



Cliccare su **CLOSE**

2.3 Windows XP (continua)

Selezionare **Start / Impostazioni / Pannello di Controllo**. Fare doppio clic sull'icona **Opzioni Telefono e Modem**.

Cliccare su **Opzioni Telefono e Modem**

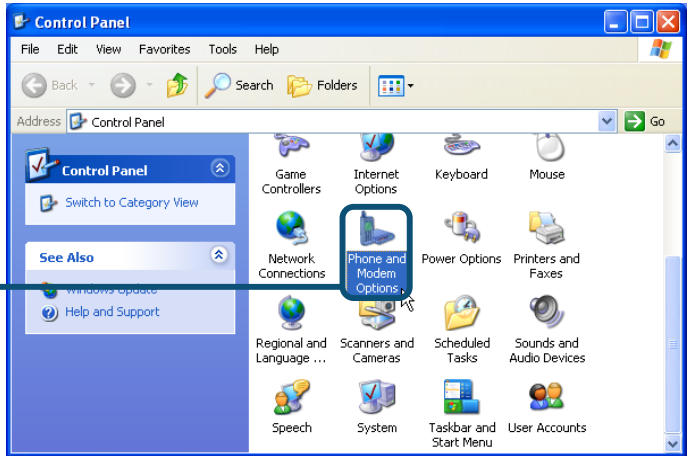

Verificare il numero di modello per il modem esterno **D-Link DFM-562E**. Se l'installazione è completa, cliccare su **OK** per uscire

Cliccare su **OK**

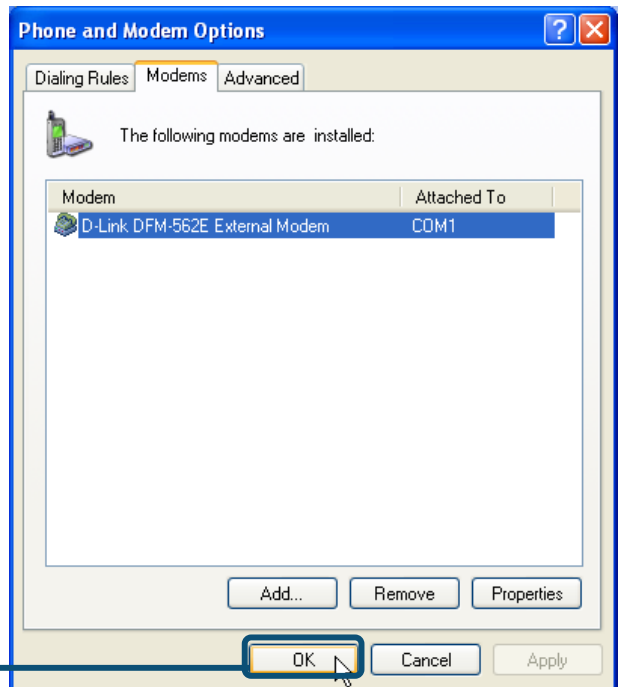

Supporto tecnico

Le ultime versioni del software e la documentazione aggiornata sono disponibili al sito **D-Link**.

D-Link fornisce un supporto tecnico gratuito ai clienti residenti in Italia per tutto il periodo di validità della garanzia del prodotto.

I clienti residenti in Italia possono contattare il supporto tecnico **D-Link** telefonicamente o attraverso il Web.

Supporto tecnico D-Link telefonico:

02-39607160

dal Lunedì al Venerdì dalle ore 9.00 alle ore 19.00 con orario continuato

Supporto tecnico D-Link via Internet:

<http://www.dlink.it/supporto/main/view.html>

email: tech@dlink.it

D-Link[®]

Building Networks for People

D-Link Quick Installation Guide



D-Link DFM-562E
внешний модем

Прежде чем начать

Если вы планируете использовать данный модем для соединения компьютера с Интернет, то вы должны иметь учетную запись у вашего провайдера Интернет.

Проверьте содержимое комплекта

Следующие компоненты включены в поставку D-Link 562E:



- Внешний модем D-Link DFM-562E



- CD-ROM (содержит руководство пользователя и руководство по быстрой установке)



- Адаптер питания 9V AC, 0.8A



- Телефонный кабель



- Кабель RS-232 (9Pin)



Используй-
ание источника
питания с
другими характеристиками
и напряжением может
повлечь выход из строя
устройства и потерю
гарантии

Если что-либо из перечисленного отсутствует, обратитесь к вашему поставщику.

1

Установка оборудования

Отключите телефонную линию и вставьте телефонный шнур в разъем, помеченный как LINE на задней панели устройства.

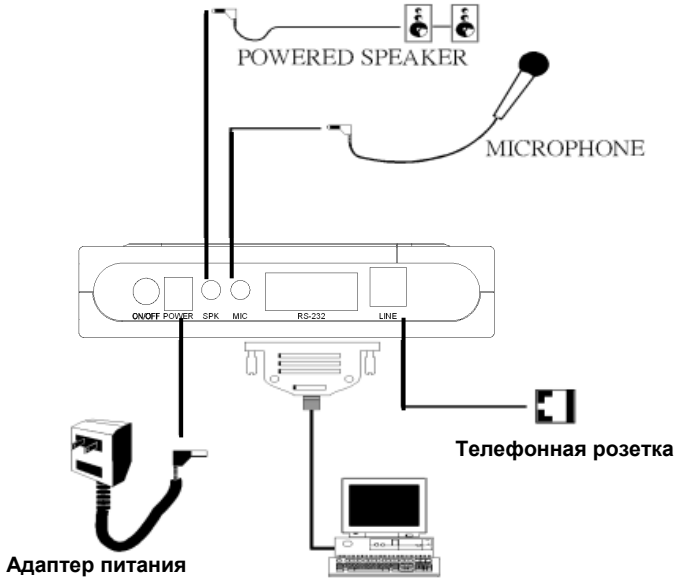

Подключение внешнего модема



2

Установка драйверов

2.1 Windows 98/ME

После загрузки Windows обнаружит модем автоматически, нажмите **Отмена**. Затем вставьте компакт-диск с драйверами

Нажмите **Install Drivers**



Затем система автоматически установит драйвера.

Нажмите **Close** для выхода

Нажмите **CLOSE**



2.1 Windows 98/ME (продолжение)

Нажмите
Modems



Проверьте модель
установленного модема
**D-Link DFM-562E External
Modem.**

Если установка завершена
корректно, нажмите **OK** для
выхода.

Нажмите
OK

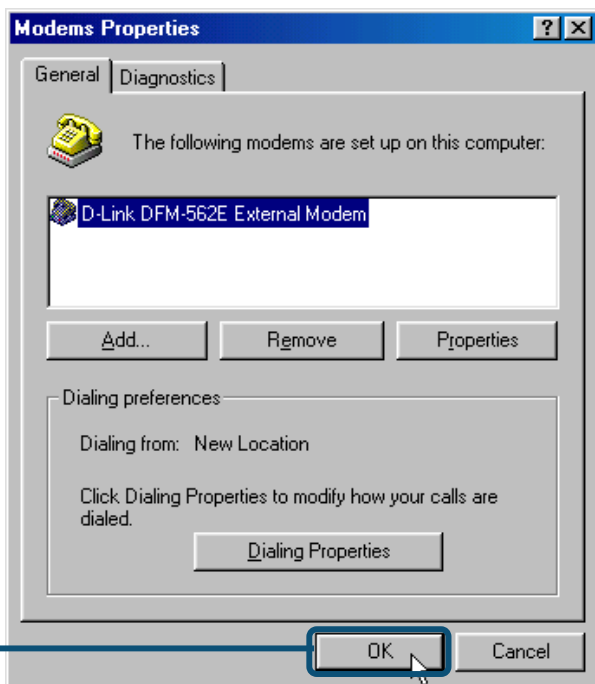

2.2 Windows 2000



Нажмите **Yes** и игнорируйте сообщение



Нажмите **Yes** и игнорируйте сообщение

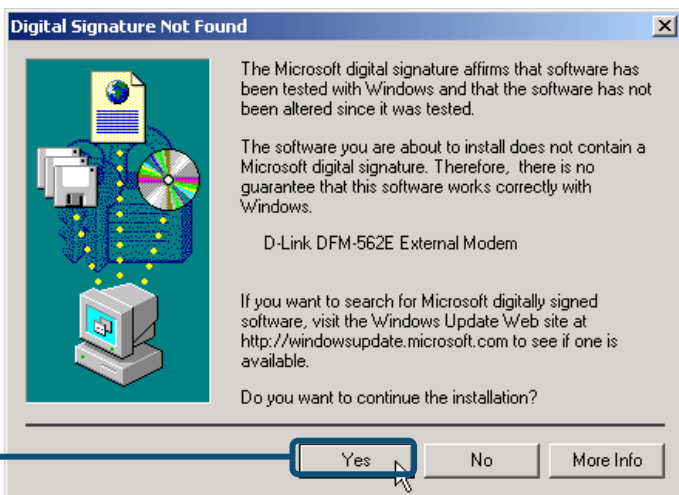

Нажмите **Yes**

Затем система автоматически установит модем.

Нажмите **Close** для выхода



Нажмите **CLOSE**

2.2 Windows 2000(продолжение)

Выберите **Пуск\Настройки\ Панель Управления**. Затем дважды кликните на значке **Телефон и Модем**.

Нажмите **Phone and Modem Options**



Проверьте модель установленного модема **D-Link DFM-562E External Modem**.

Если установка завершена корректно, нажмите **OK** для выхода.

Нажмите **OK**

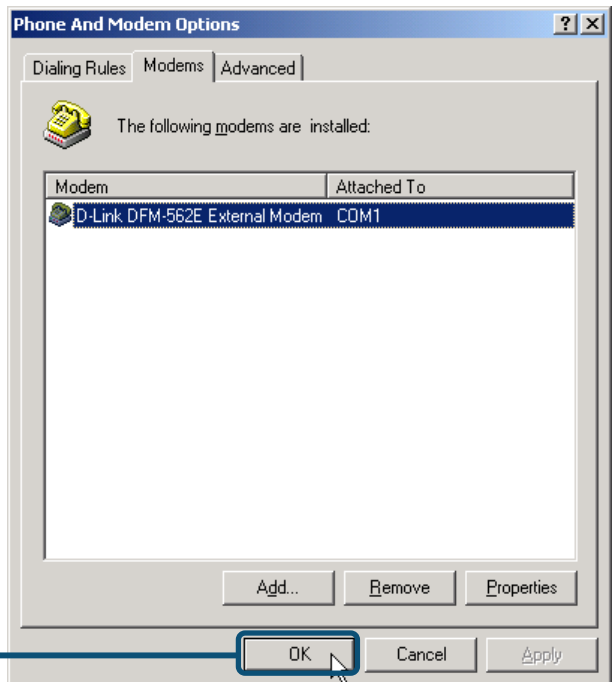

2.3 Windows XP

После загрузки Windows обнаружит модем автоматически, нажмите **Отмена**. Затем вставьте компакт-диск с драйверами

Нажмите **Install Drivers**



Нажмите **Continue Anyway**



Выберите **Установить драйвера автоматически [Рекомендуется]** затем нажмите **Далее** для поиска драйверов.

Нажмите **Next**



Нажмите **Continue Anyway** для пропуска предупреждающего сообщения.

Нажмите **Continue**



Установка
завершена

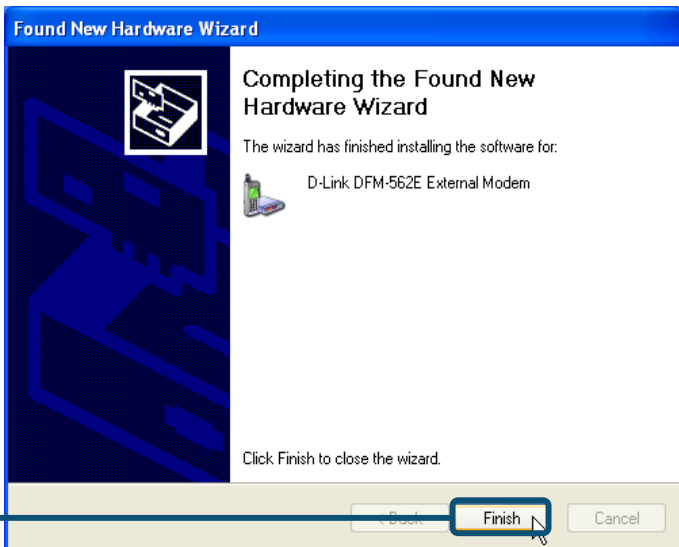

Нажмите
Finish

Нажмите **Close** для
выхода



Нажмите
CLOSE

2.3 Windows XP (продолжение)

Выберите **Пуск**
Настройки | **Панель**
Управления. Затем
дважды кликните на
значке **Телефон и**
Модем.

Нажмите
Phone and
Modem

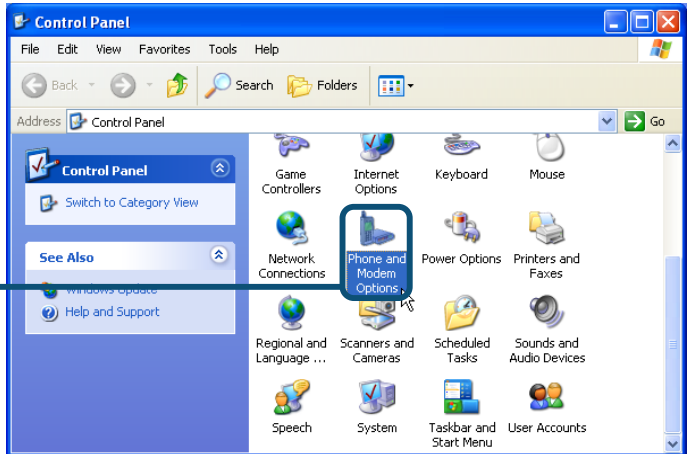

Проверьте модель
установленного модема
D-Link DFM-562E
External Modem.

Если установка
завершена корректно,
нажмите **OK** для
выхода.

Нажмите **OK**

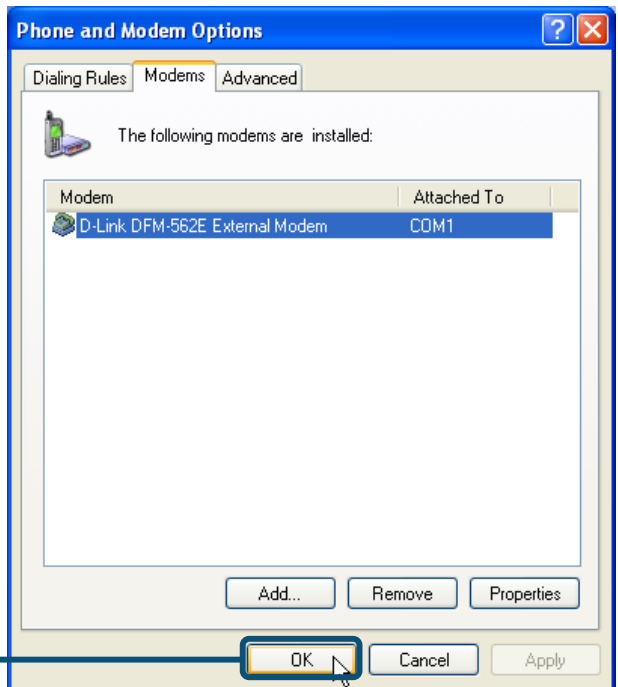

Техническа поддръжка

Вы можете найти последнюю версию программного обеспечения и документацию по продуктам на сайте **D-Link**

D-Link обеспечивает бесплатную техническую поддержку клиентов в течение гарантийного срока изделия.

Клиенты могут связаться со службой технической поддержки **D-Link** через наш web-сайт, или по телефону.

Телефоны службы технической поддержки D-Link:

+7 (095) 744 00 99

Техническая Поддержка D-Link через Internet:

support@dlink.ru

D-Link[®]
Building Networks for People