

DAEWOO PLASMA

PLASMA DISPLAY USER'S MANUAL

DP - 42 G M
DP - 42 S M
DP - 42 W M

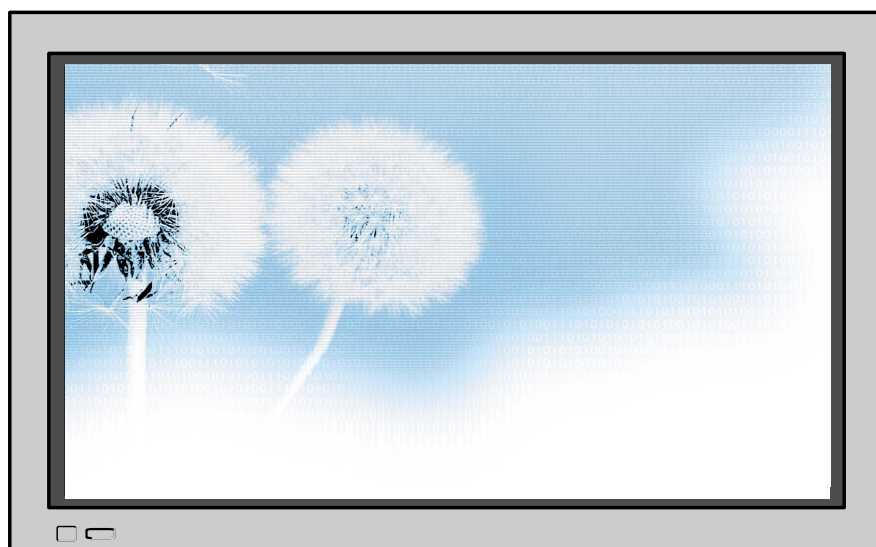

**Proper use guarantees
product life.**

**Before using the product, be advised
that you read this owner's manual well
and try to operate it.**

- Product Warranty is included -

DAEWOO ELECTRONICS CO., LTD.

Features

- **42" super-wide, 3.15" Ultra Slim Wall-mounting Monitor**

DAEWOO PLASMA opens new TV era with advanced plasma technology – 3.15 inches ultra slim Monitor. Light weight of only 66Lbs allows installing in narrow space.

- **DVD Direct Connection / Outstanding Picture Quality Digital Broadcasts Receive (SD Grade)**

DVD can be directly connected to the unit so that you can view clear digital images. You can enjoy even high quality images. by connecting digital broadcasting receiver with which digital broadcasts can be viewed.

- **PC Direct Connection**

PC can be connected to the PDP without a separate device, and can be used as a monitor so that the effect of presentation gets maximized, making it more popular in various events and exhibitions.

- **PDP Monitor with Minimized Noise**

Although PDP Monitor had an outstanding picture quality, there was a problem with the noise caused by cooling fan until now. DAEWOO PLASMA does not need cooling fan any more since it adopts self air circulation method with excellent heat transfer, eliminating the fan noise.

- **160° Wide-Angle Viewing Area**

- **Flat Panel with No Distortion and Color Blurring**

Since Plasma TV has no problems such as distortion, blurring, flickering unlike existing CRT type, you can enjoy Home Theater with super speaker.

- **Various Video Control**

- 11 Languages OSD - 20 Step screen zooming function - Full-screen still function
- Various aspect ratio (16:9, Panorama, Normal, Enlarge LB, Enlarge LBS)

- **3 Way 6 Speaker Stereo Sound System**

- **Worldwide : NTSC, PAL, SECAM / Free Volt (100-240V 50/60Hz)**

**This Owner's Manual presents safety precautions and how to use the product.
After reading it thoroughly, use the product safely.
Keep this manual where the user can see it easily.**

Failure to comply with warnings and cautions for the safe use of electric appliances may cause fire or human injury.

FCC RF INTERFERENCE STATEMENT

NOTE :

This equipment has been tested and found to comply with the limits for a Class B digital device, pursuant to Part 15 of the FCC Rules. These limits are designed to provide reasonable protection against harmful interference in a residential installation.

This equipment generates, uses and can radiate radio frequency energy and, if not installed and used in accordance with the instructions, may cause harmful interference to radio communications. However, there is no guarantee that interference will not occur in a particular installation.

If this equipment does cause harmful interference to radio or television reception which can be determined by turning the equipment off and on, the user is encouraged to try to correct the interference by one or more of the following measures.

- Reorient or relocate the receiving antenna.
- Increase the separation between the equipment and receiver.
- Connect the equipment into an outlet on a circuit different from that to which the receiver is connected.
- Consult the dealer or an experienced radio, TV technical for help.
- Only shielded interface cable should be used.

Finally, any changes or modifications to the equipment by the user not expressly approved by the grantee or manufacturer could void the users authority to operate such equipment,

Safety Precautions

Always obey all safety messages.

- All the safety and operating instructions should be read before the product is operated. If anything strange happens, unplug this product from the wall outlet.
- Do not disassemble or replace any parts of the monitor. Refer to a qualified service personnel for repair.

WARNING

You can be killed or seriously injured if you do not follow instructions.

Power

During a lightning storm, or when it is left unattended and unused for a long period of time, unplug it from the wall outlet.

It can result in fire.

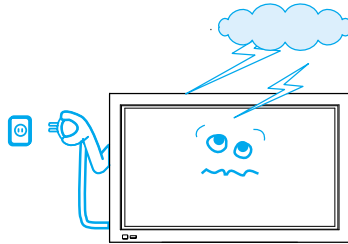

When unplugging your monitor, always grip plug firmly and pull straight out from the receptacle.

It can result in fire or electric shock due to damaged power cord.

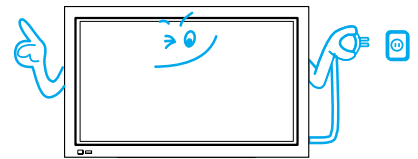

This product must be properly grounded.

- Improper grounding may cause malfunction or electric shock.
- When proper grounding is not possible, install circuit breaker.
- Do not ground to gas pipe, water pipe, lightning rod, and telephone line.



During a lightning storm, unplug the monitor from the wall outlet, and do not touch the antenna.

It can cause fire or electric shock.

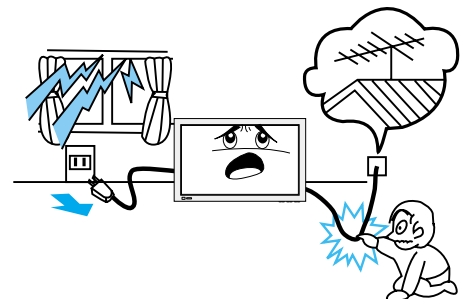

Installation

Do not use this product in the neighborhood of a bath or shower.

It can result in electric shock or fire.

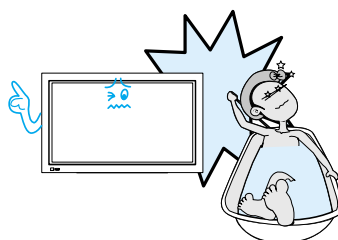

Do not place this monitor on an unstable cart, stand, or table

It may cause the product and cart to overturn, damaging equipment or causing possible injury.

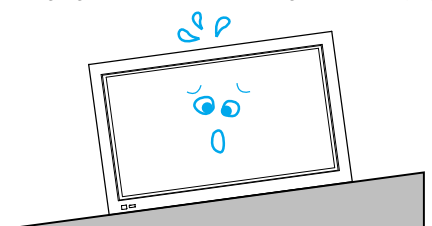

While Using Monitor

Do not open cover (or back) because high voltage is present within the monitor's enclosure.

It may cause electric shock.

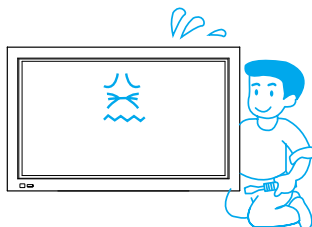

Never push objects of any kind into this product through openings at the back of monitor.

It may cause fire or electric shock.

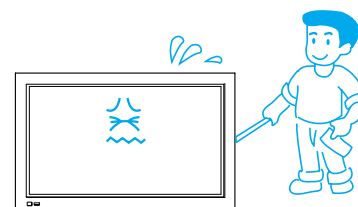

No objects filled with liquids, such as vases, shall be placed on the monitor.

Spilled liquids may cause electric shock or fire.

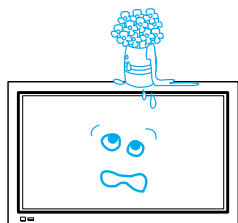

Do not allow children to play or hang on the monitor.

These actions may tip it over, causing personal injury.

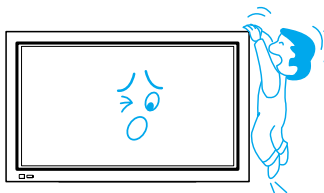

Do not place candle or lighted cigarette on the monitor.

If these fall into the inside of the monitor, it may cause fire or explosion.

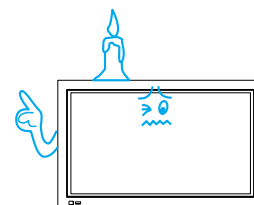

Do not disassemble batteries, and do not allow children to swallow them.

Heavy metal may contaminate environment, and can be harmful or detrimental to human health. (When children swallow the batteries, go to hospital and consult with a doctor.)

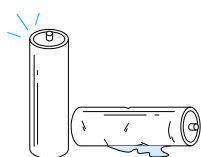

Do not spray water to the monitor or wipe with damp cloth.

It may cause electric shock or fire.

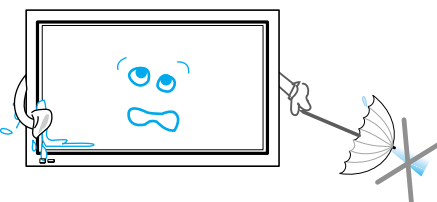

Unplug the monitor from the wall outlet when smoke or strange smell occurs, then refer servicing to a service personnel.

In the case of continuous use, it may cause fire or electric shock.

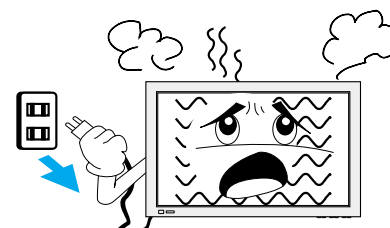

Safety Precautions

Always obey all safety messages.

- All the safety and operating instructions should be read before the product is operated.

CAUTION

You can be injured or this product or any other your property can be damaged if you don't follow instructions.

Power

When moving your monitor, remove the power plug, antenna, and cables, and be sure to move it by more than two people..

Failure to follow this instruction can result in electric shock or personal injury.

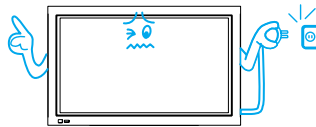

Do not touch the power plug with wet hands when plugging or unplugging.

It can result in a risk of electric shock.

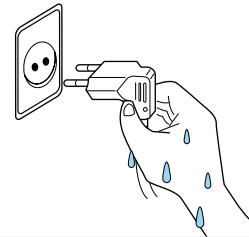

Installation

Do not install where there is oil, smog, moist, and dust

It may cause malfunction.

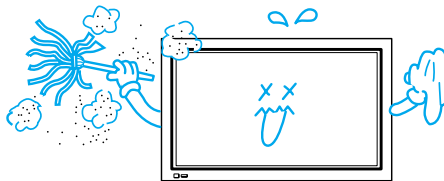

Do not install the product where it will be exposed to the direct sunlight, and the product should not be near heat sources such as radiators, stoves, etc.

It may cause malfunction.

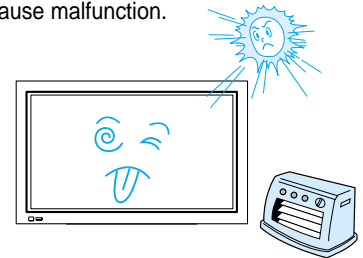

For proper ventilation, separate the product from the wall, and keep a distance of more than 4" .

Due to the increase of temperature inside the Monitor, it may cause fire.

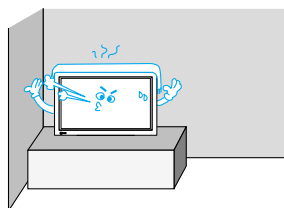

Do not place the monitor where ventilation is not ensured.

Due to the increase of temperature inside the Monitor, it may cause fire.

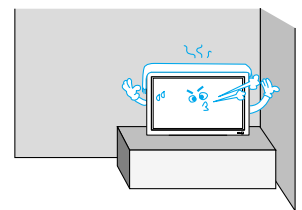

If you wish to install this product on the wall or ceiling, refer to the professional.

Failure to do so may cause damage to product and injury to human.



When using an outside antenna system, do not install it in the vicinity of overhead power lines.

When antenna touches such power lines, it may cause electric shock.

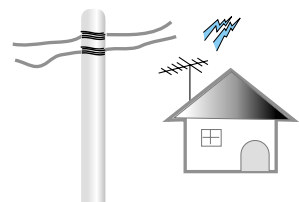



During Use



CAUTION

You can be injured or this product or any other your property can be damaged if you do not follow instructions.

Do not wipe the monitor using a cloth damped with chemicals (benzene, thinner, etc.).

Monitor appearance may be marred. (Unplug the power plug and wipe with soft cloth.)

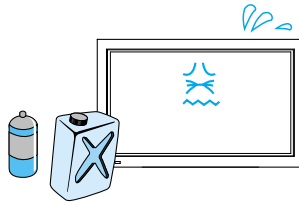

Do not place the monitor near magnetic, speakers, or telephones.

It can cause a change in the color tone of the screen.

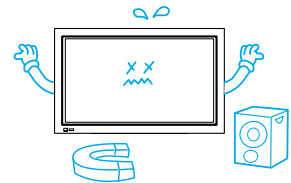

Do not place heavy objects or heat sources on the power cord.

It may damage the power cord, causing fire or electric shock.

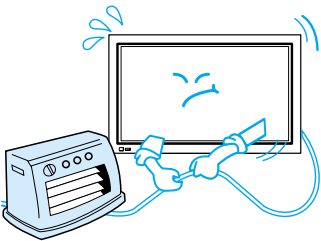

Do not place any object or cover on the monitor.

In an event of improper ventilation, the monitor will be overheated causing fire.

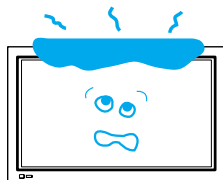

When watching the TV, the distance between the Monitor screen and your eye should be as 5~7 times as the diagonal distance of the Monitor.

Watching the TV for a long time may hurt your eye sight.

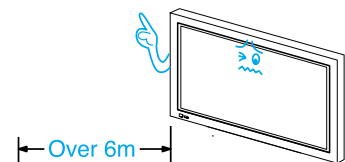

When cleaning of the inside of the monitor is required, consult to the qualified service personnel.

When the monitor is not cleaned for a long period of time, dust in it may cause fire or malfunction.



When the monitor is placed on a cart or table, the front side of the Monitor should not project outward.

Unbalance may cause the monitor to drop, resulting in personal injury or equipment malfunction and damage.

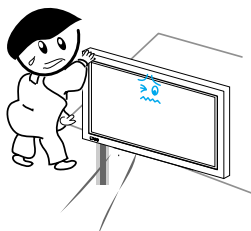

Do not grip speakers when moving the monitor attached with speakers.

When moving the monitor while gripping speakers, speakers may be fallen away from the monitor due to its weight, causing personal injury.

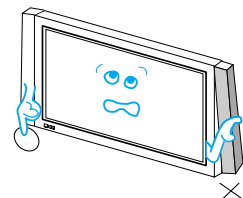

Checking Accessories



Note

Check to be sure that the following items are packed with your Monitor.

Supplied Accessories

Remote Control

1 UNIT

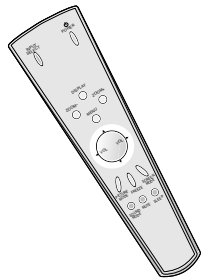

Batteries (AAA)

2 UNITS

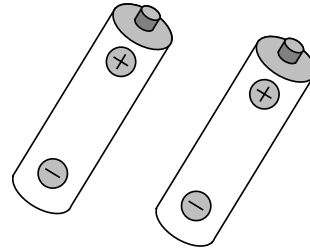

AC Cable

1 UNIT

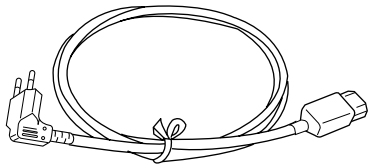

PC(15pin) Cable

1 UNIT

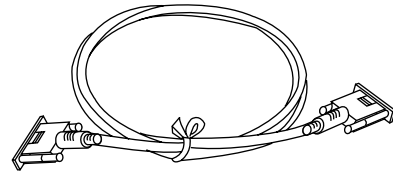

A/V Cable

2 UNITS

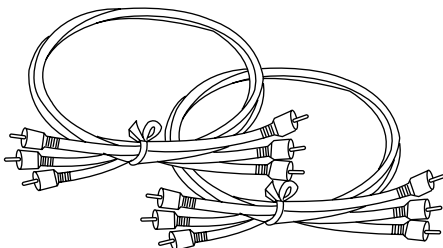

Audio Cable

1 UNIT

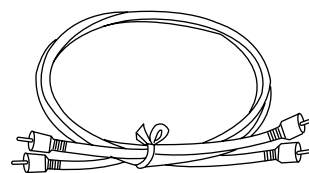



Note

The following items are optional accessories. Refer purchasing optional accessories from Daewoo Electronics Local Dealer or the dealer from where you purchased the unit.

Optional Accessories

Speakers

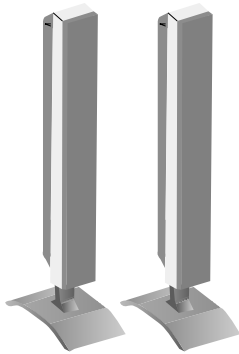

DSP-SP20/SP21/SP22

- Speaker Main Unit
Dimension : 3.94(W) x 24.72(H) 3.27(D)inch
- Including Speaker Stand
Dimension : 6.69(W) x 28.7(H) x 7.64(D)inch
- Audio Amplifier : 8W + 8W
- Impedance : 8Ω
- Weight : 16.53Lbs

Table Top Stand

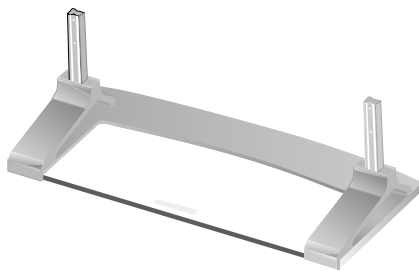

DSP-ST20/ST21/ST22

- Dimension : 26.26(W) x 9.37(H) x 12.60(D)inch
- Weight : 15.43Lbs

Wall Mounting Unit

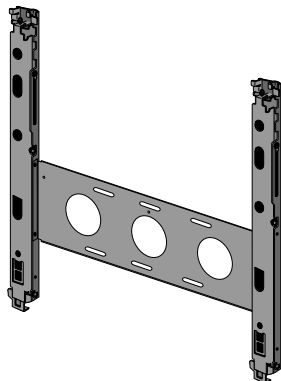

DSP-HG10

- Variable Angles : 0°, 10°, 15°, 20°
Speaker Main Unit
- Dimension : 23.66(W) x 23.31(H) x 1.38(D)inch
Including Stand
- Weight : 9.92Lbs.





CONTENTS

PREPARATION

- 4 • Safety Precautions
- 12 • Panel Controls
- 13 • Remote control

BASICS

- 14 • Installation Instructions
- 15 • Connecting Speaker to PDP

CONNECTION

- 16 • Watching Digital Broadcasts
- 18 • Watching Cable Broadcasts
- 20 • Watching Satellite Broadcasts
- 22 • Watching a DVD Image
- 24 • Watching a VCR Image
- 26 • Watching a Camcorder/Game Console Image
- 28 • Connecting PC

APPLICATION

- 31 • Selecting Auto Picture Mode
- 34 • Adjusting Screen Size
- 36 • Adjusting Screen Position and Size
- 38 • Enlarging Screen Size
- 40 • Watching a Still Image
- 41 • Adjusting Auto Sound Mode
- 42 • Customizing Sound Mode
- 44 • Selecting INPUT SIGNAL
- 46 • Checking the Current Input Signal
- 47 • Selecting MENU Background Screen and Languages
- 49 • Setting Sleep Timer

MISC.

- 50 • Before Requesting Service
- 51 • SPECIFICATIONS

Panel Controls

Front Panel, Back Panel, Remote Control

* Parts having same names in Plasma Display and Remote Control would function in exactly the same way.

Front

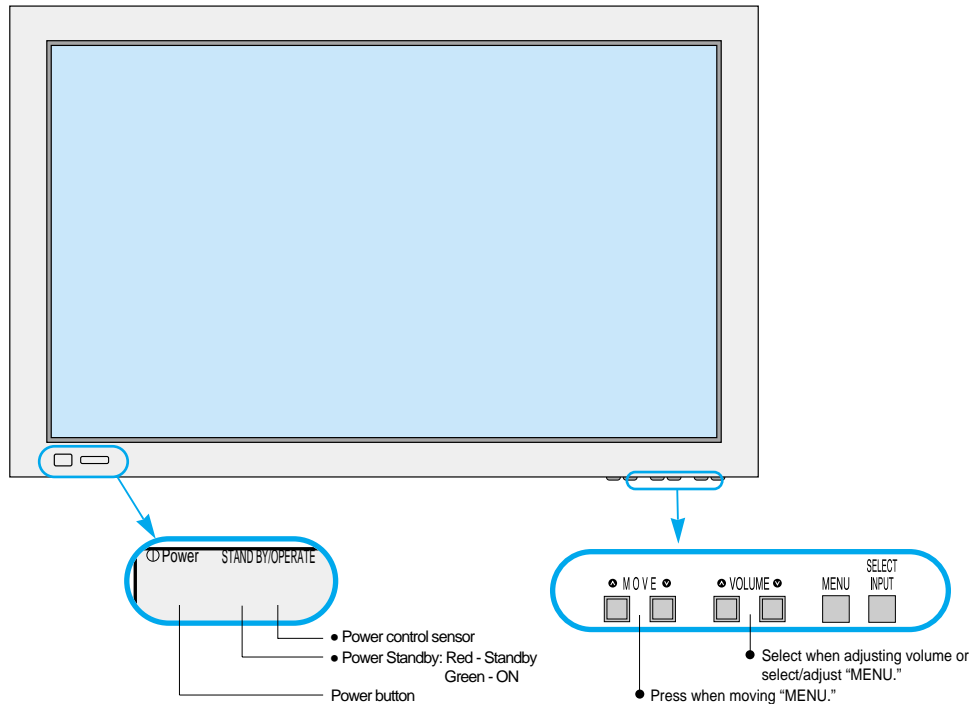

Rear

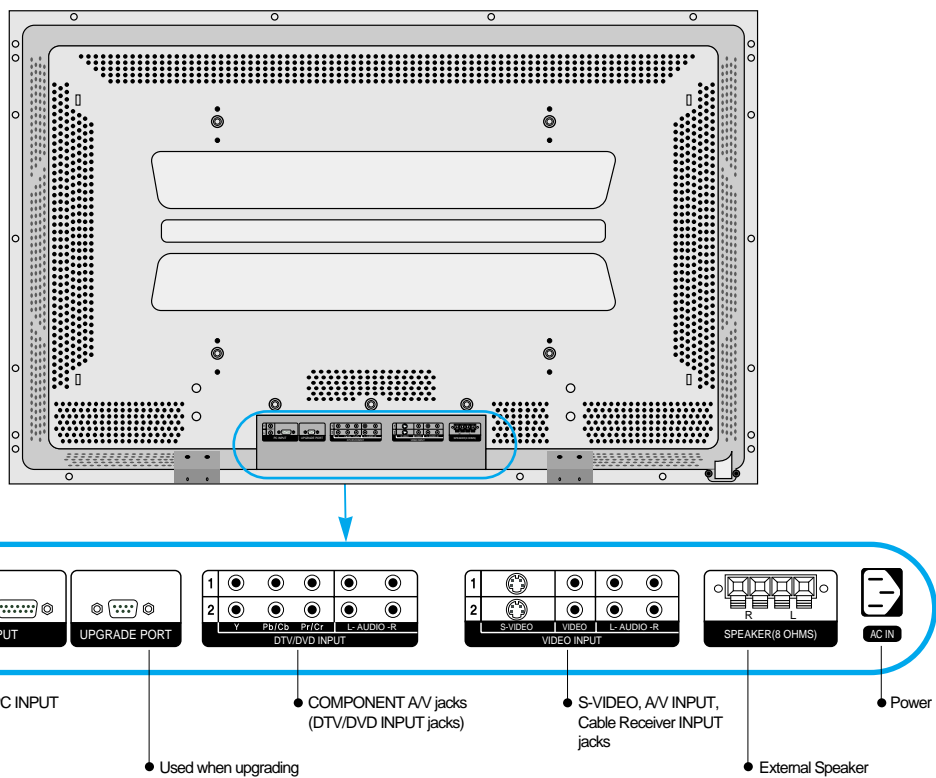

Remote Control



Note

- Use two “AAA” batteries.
- Be sure to use replacement batteries of the same type as the original ones.
- The life of a battery depends on how much it has been used.

* The number in () indicates the page in which the function of each button is explained in detail.

Input Select button 44
Used to select a desired input. Every press of the button cycles through the five different modes: Video 1 → Video 2 → PC → Component 1 → Component 2

ZOOM button 38
Used to zoom the screen. To enlarge, press the (+) button, and to return to the previous condition, press the (-) button. (ZOOM Mode: Zoom 0~20)

Menu Select button 32
Select Menu by pressing ▲(Up), ▼(Down), ◀(Left), ▶(Right) buttons.

Screen Select button 31
Every press of the button cycles through the four different modes: Normal → Cinema → Dynamic → User.

Sound Mode button 41
Every press of the button cycles through the five different modes: Normal → Movie → Music → News → User.

Mute button
Mutes sound.

Power button 16
Pressing the Power button of the Monitor allows the Display to be standby. (Red light is shown in the Remote Control Sensor.) At this time, if you press the Power button of the Remote Control, the Display is turned ON (Green light in the Sensor).

Display button 46
Indicates the current state and resolution.

Menu button 42
Use to display a desired menu.

Volume button 32
Adjusts the volume.

Aspect Ratio 34
Adjusts the size of the screen (normal, 16:8, etc.)

Still 40
Used to view a still picture during watching moving images. (Sound can be heard.)

Sleep Timer 49
Each time you press this button, a different input mode appears. The sequence is as follows: 15 Min. → 30 Min. → 60 Min. → 90 Min. → 120 Min. → OFF After the time is selected, it automatically becomes stand-by state.

■ When Using Remote Control:

- Be sure not to allow the Remote Control to drop or to become wet.
- Keep it away from hot or moist locations.



■ Installing the Batteries in your Remote Control:

- To remove the cover, slide it outwards while pressing it down.
- Place two batteries in the remote control by properly orienting them, then close the cover.

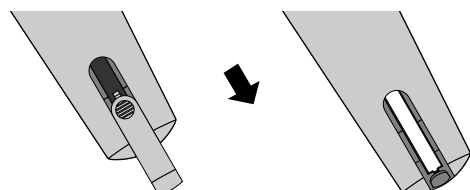

Installation Instructions

When Using the Stand

- * When installing PDP Main Unit, be sure it is done by more than 2 professionals.
- * For detailed installation information, refer to the User's Manual, "STAND".

1 Take out the STAND from the package.

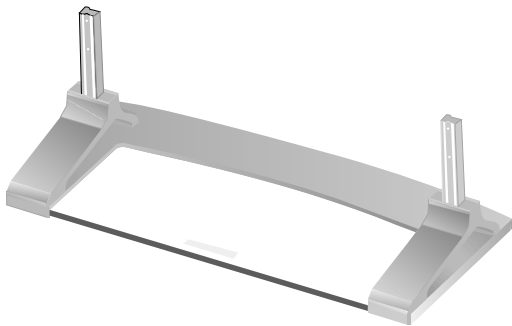

2 Smoothly fit the Stand to the Plasma Display Panel

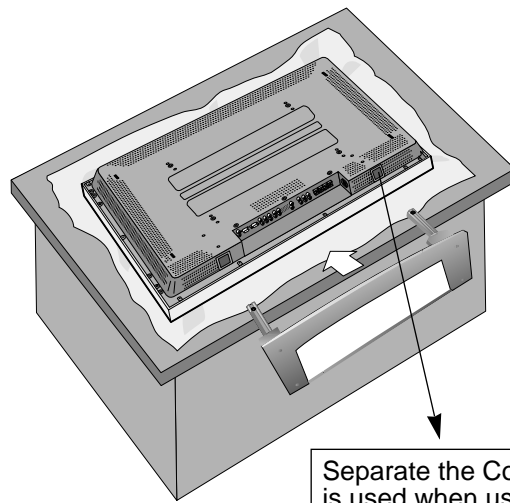

Separate the Cover Stand. (It is used when using for wall mounting, so store it.)

3 Engage the assembled stand with 4 screws (M5) enclosed.

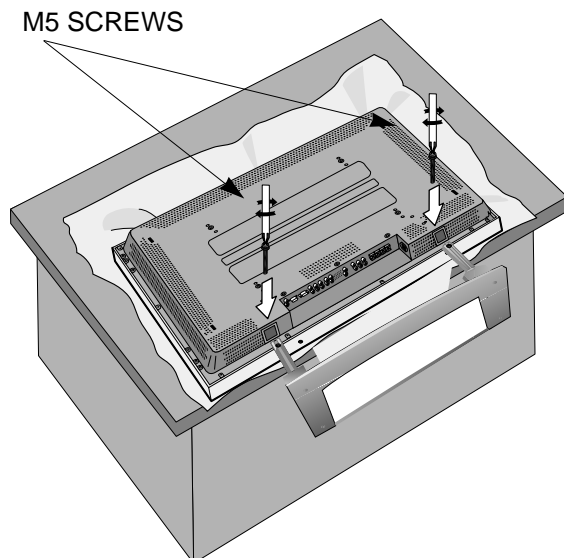

4 Erect the Display

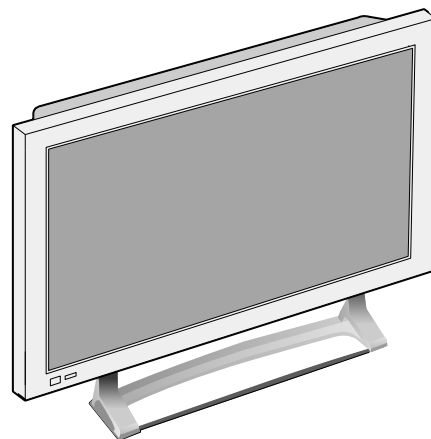

(Assembled Picture)

Connecting the Speaker to the PDP

1 Connecting the Speaker to the Stand

Be sure to check if there is a sponge attached to the surface on which the speaker is contacted.

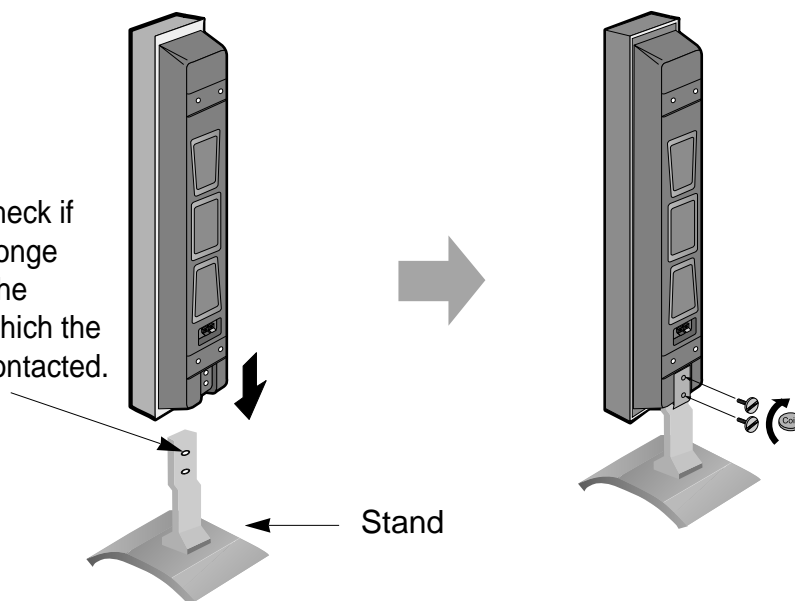

- By using a (-) driver or coin, fasten the special screw securely.

2 Connecting the Speaker Cable

- Connect one set (two cables) of the cable to the terminals on the back of the speaker in the way that red cable is for (+) terminal and black cable for (-) terminal.

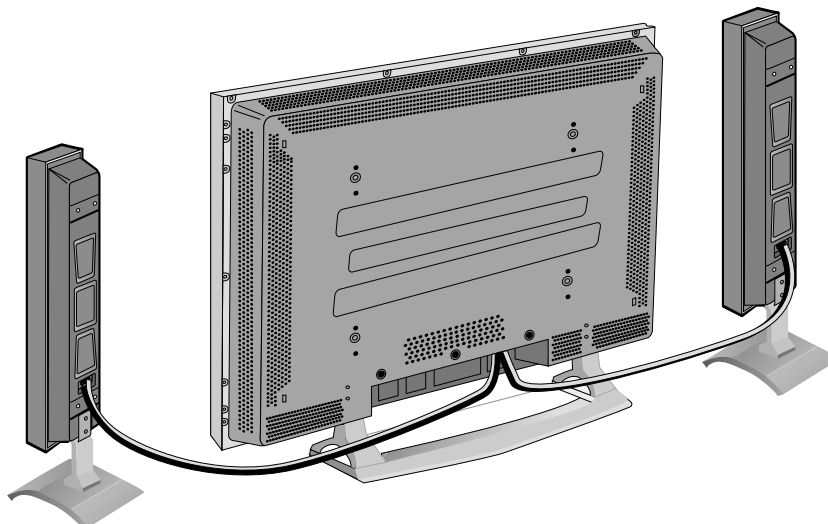

Watching Digital Broadcasts

Watching Digital Broadcasts

- To watch digital broadcasts:
 - Purchase a separate digital Broadcasting Receiver (SET-TOP BOX)
 - Connect the PDP to a Cable Broadcasting Receiver that is provided by a company which re-transmits digital broadcasts.

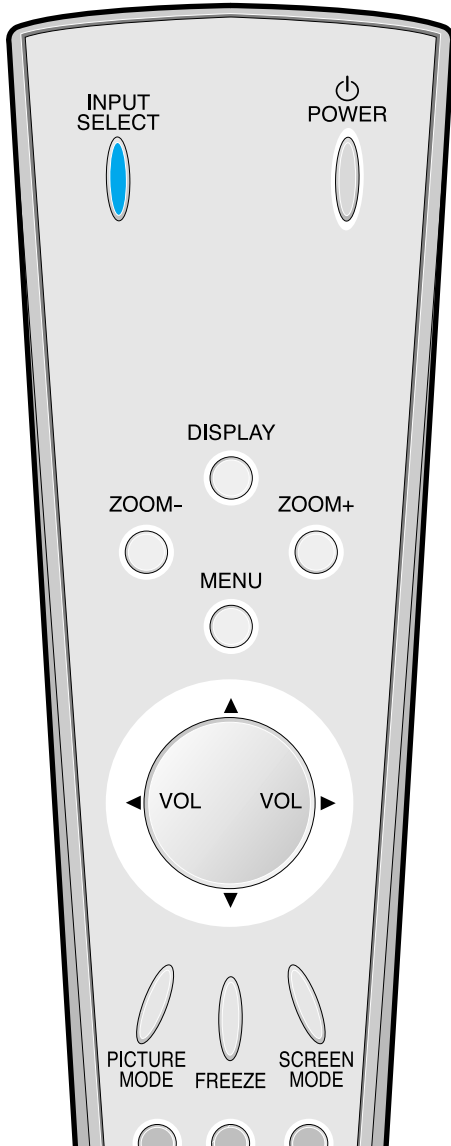

1 Connect a Digital Broadcasting Receiver to the PDP

- Prepare A/V Cables supplied.
- Connect the cables from the Digital TV Receiver output terminal to the PDP (Component 1, 2) input terminal.
- When connecting the cables, be sure to match the cable colors.

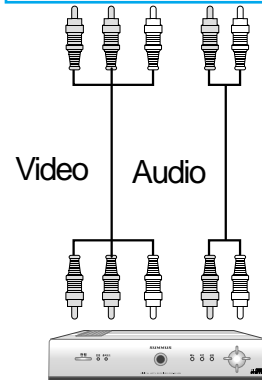
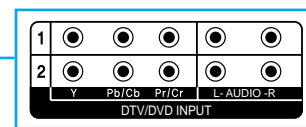
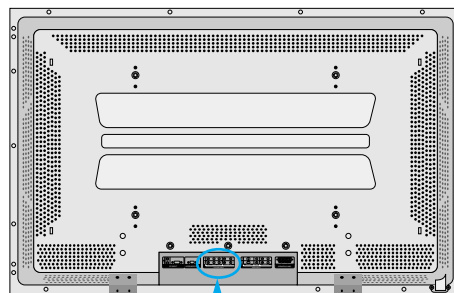

Digital Broadcasting Receiver (Set-Top Box)

2 Press the Power Buttons

- Press the Power buttons of the PDP and the Receiver.



3 Input Select

INPUT
SELECT



- Select [Component 1 or Component 2] by pressing the INPUT SELECT button of the Remote Control or the PDP unit.
- Each time you press the INPUT SELECT button, different input modes appear. The sequence is as follows: Component 1 → Component 2 → Video 1 → Video 2 → PC.

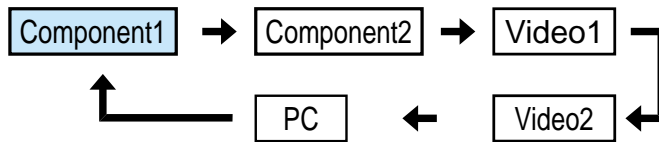

4 Select a Desired Channel and Function

- Select a desired channel and function by using the Remote Control of Digital Broadcasting Receiver.



NOTES:

- 1) You can select INPUT SELECT while you are using OSD(Menu).
Sequence: [Menu] → [Input] → [Component 1 or 2 (DTV/DVD)]
- 2) Digital Broadcasting signals available: 1080i(60Hz), 720p(60Hz), 480p(60Hz)
- 3) Antenna Connection:
Apartment : Check if community antenna receives digital broadcasts.
Private Houses: Set the indoor/outdoor UHF antenna to the direction of the digital broadcasting transmitting company.
- 4) For detailed connection method, refer to the Owner's Manual of Digital Broadcasting Receiver.
- 5) What is a component? : Signal with which brightness and color signals are separated, producing a sharp screen.
- 6) If the Digital Broadcasting Receiver has PC Output terminal (D-sub15pin), connect to 'PC INPUT' at the back panel of the PDP. When watching the PDP by PC Input, some undesired signals may be seen at the top and bottom area of the screen. In this case, select [Menu] → [Screen] → [Vertical Size] to adjust.

Watching Cable Broadcasts

Watching Cable Broadcasts

- To watch cable broadcasts, subscribe to your local Cable TV Broadcasting, and then, connect the digital set-top box for cable TV to the PDP as shown below.

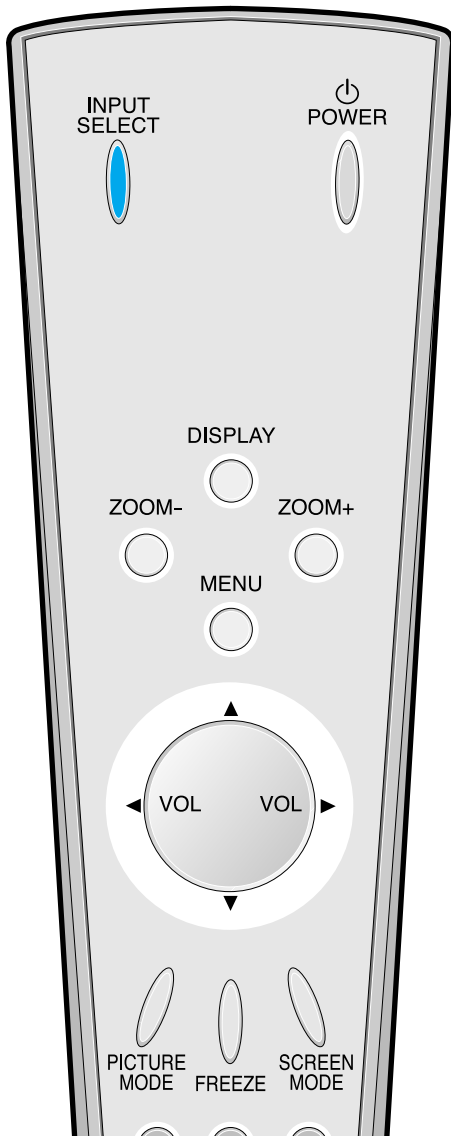

1 Connect a CABLE Broadcasting Receiver to the PDP.

- Prepare the AV connecting cable.
- Connect the receiver(Output) to PDP(Video Input) as shown below.
- When connecting to an external AV source, be sure to match the colors.

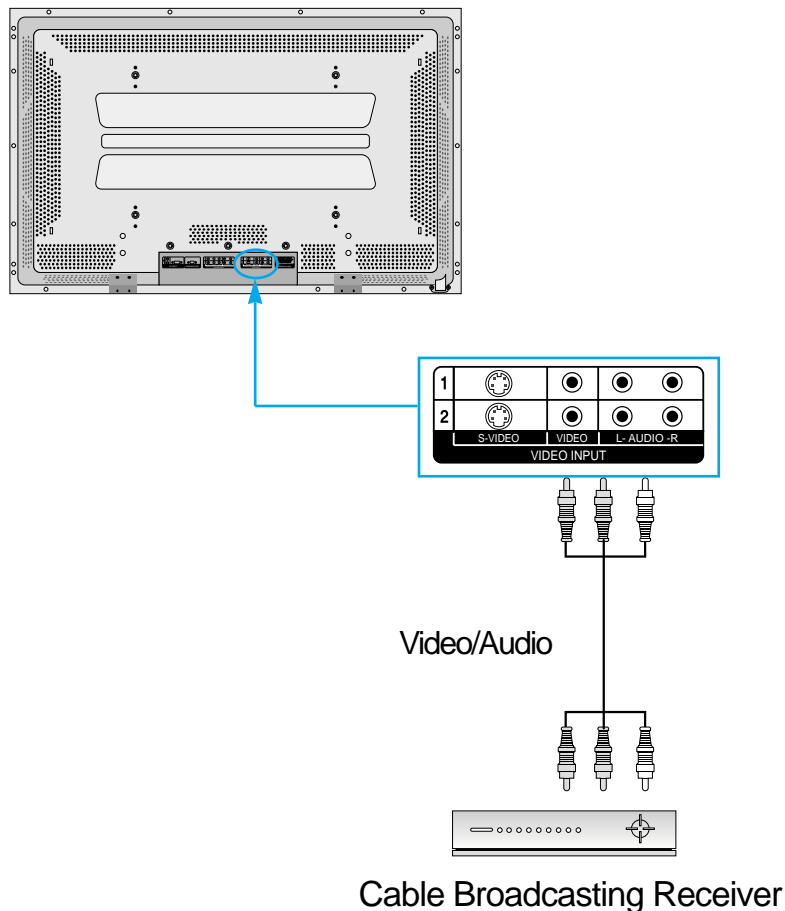

2 Press the Power Buttons

- Turn the PDP and the Receiver ON.

3 Input Select

INPUT
SELECT



- Select [Video 1 or Video 2] by pressing the INPUT SELECT button of the Remote Control or the PDP unit.
- Each time you press the INPUT SELECT button, different input modes appear. The sequence is as follows: Video 1 → Video 2 → PC → Component 1 → Component 2.

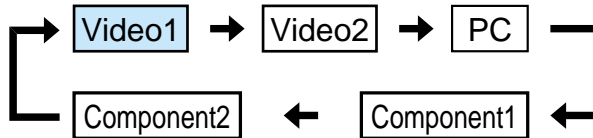

4 Select a Desired Channel and Function

- Select a desired channel and function by using the Remote Control of the Cable Broadcasting Receiver.



NOTES:

* If your local cable company re-transmits digital broadcasts, you may watch normal broadcasts and digital broadcasts simultaneously. For detailed information, refer to your local satellite company.

Watching Satellite Broadcasts

Watching Satellite Broadcasts

- To watch satellite broadcasting, subscribe to a Digital Satellite Broadcasting, then connect the digital set-top box for satellite broadcasting to the PDP as shown below.

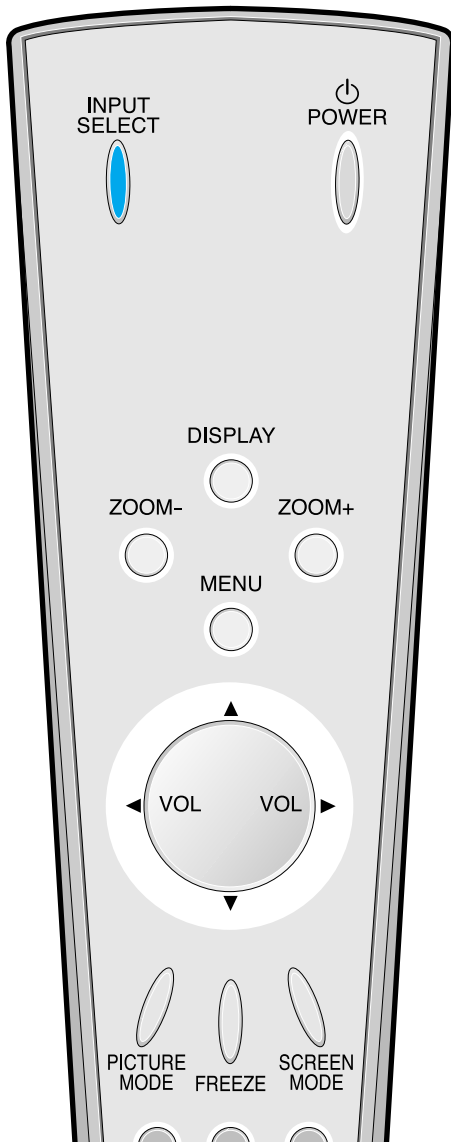

1 Connect a Satellite Broadcasting Receiver to the PDP.

- Prepare the AV connecting cable.
- Connect the receiver(Output) to PDP(Video Input) as shown below.
- When connecting to an external AV source,

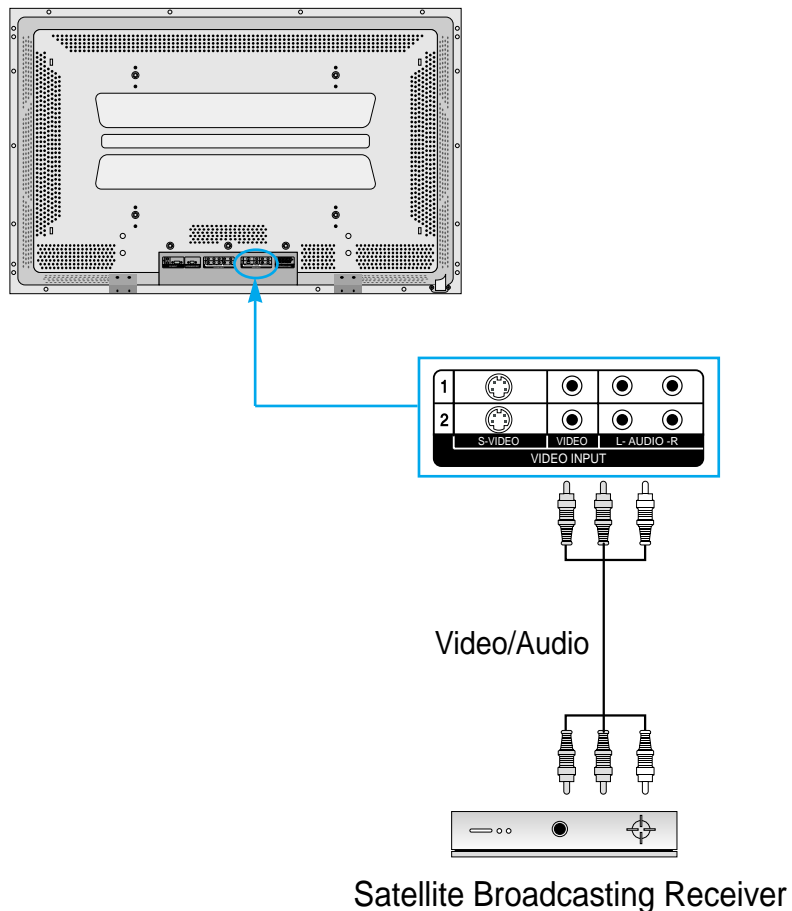

2 Press the Power Buttons

- Turn the PDP and the Receiver ON.



3 Input Select

INPUT
SELECT



- Select [Video 1 or Video 2] by pressing the INPUT SELECT button of the Remote Control or PDP unit.
- Each time you press INPUT SELECT button, a different input mode appears. The sequence is as follows: Video 1 -> Video 2 -> PC -> Component 1 -> Component 2.

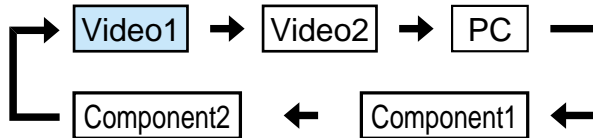

4 Select a Desired Channel and Function

- Select a desired channel and function by using the Remote Control of the Satellite Broadcasting Receiver.



NOTES:

* Picture quality of the Digital Satellite broadcasts is SD grade, and its aspect ratio is 16:9.

Watching a DVD Image

Watching a DVD Image

- Component Input is set to 480i and 480p mode.
- Connect the cable from the DVD Video Output (Y, Pb/Cb, Pr/Cr) to the Component Input at the back PDP, and connect the cable from DVD Audio output (Left, Right) to the Audio Input at the back of PDP.

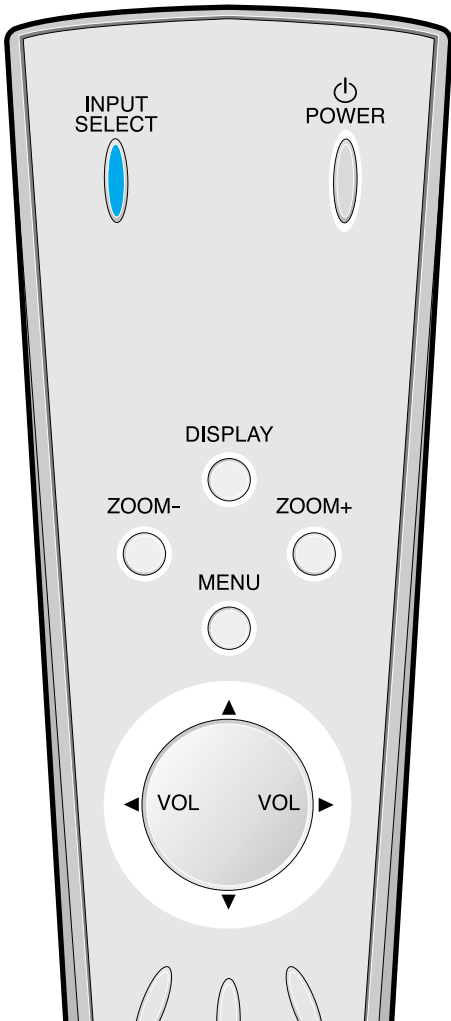

1 Connect a DVD Player to the PDP.

- Prepare the AV cable.
- Connect the DVD(Output) to the PDP(Component or Video Input) pas shown below.
- When connecting to an external AV source, match the colors.

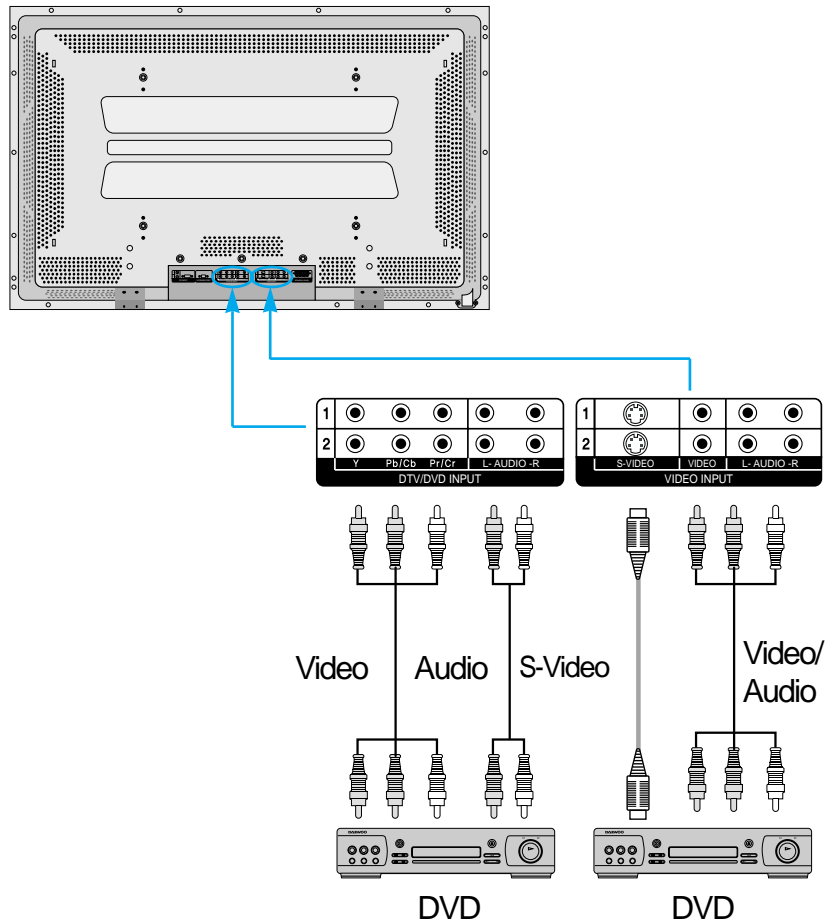

2 Press the Power Buttons

- Turn the PDP and the DVD ON.



3 Input Select

INPUT
SELECT

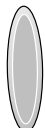

- Select [Component 1 or Component 2, Video1, Video2] by pressing the INPUT SELECT button of the Remote Control or the PDP unit.
- Each time you press the INPUT SELECT button, a different input mode appears. The sequence is as follows: Component 1 → Component 2 → Video 1 → Video 2 → PC.

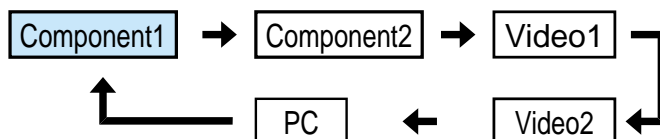

4 Select a Desired Title and Function

- Select a desired title and function by using the Remote Control of the DVD.



NOTES:

- 1) Y/Cb/Cr, which stands for DVD Player's Output Terminal, can also be written as Y/B-Y/R-Y, Y/Pb/Pr depending on the kinds of DVD devices.
- 2) The way of connecting the DVD to the PDP is as follows:
Y ↔ Y Cb ↔ Pb, B-Y, Cr ↔ Pr, R-Y
- 3) The DVD output can be made by Video, S-Video and or Component Video depending on the DVD devices. There are various output modes, so be sure to check when to purchase it.
- 4) When connecting S-Video and normal Video simultaneously, only S-Video will be displayed on the screen.

Watching a VCR Image

Watching a VCR Image

- Video can use either the normal video terminal or the S-video terminal.

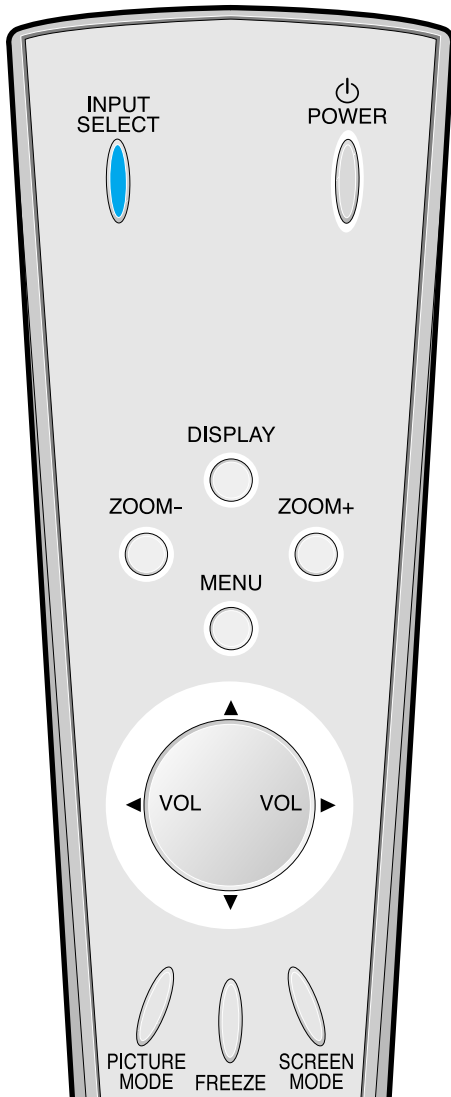

1 Connect a VCR to the PDP.

- Prepare the AV cable.
- Connect the Video(Output) to PDP(Video Input) as shown below.

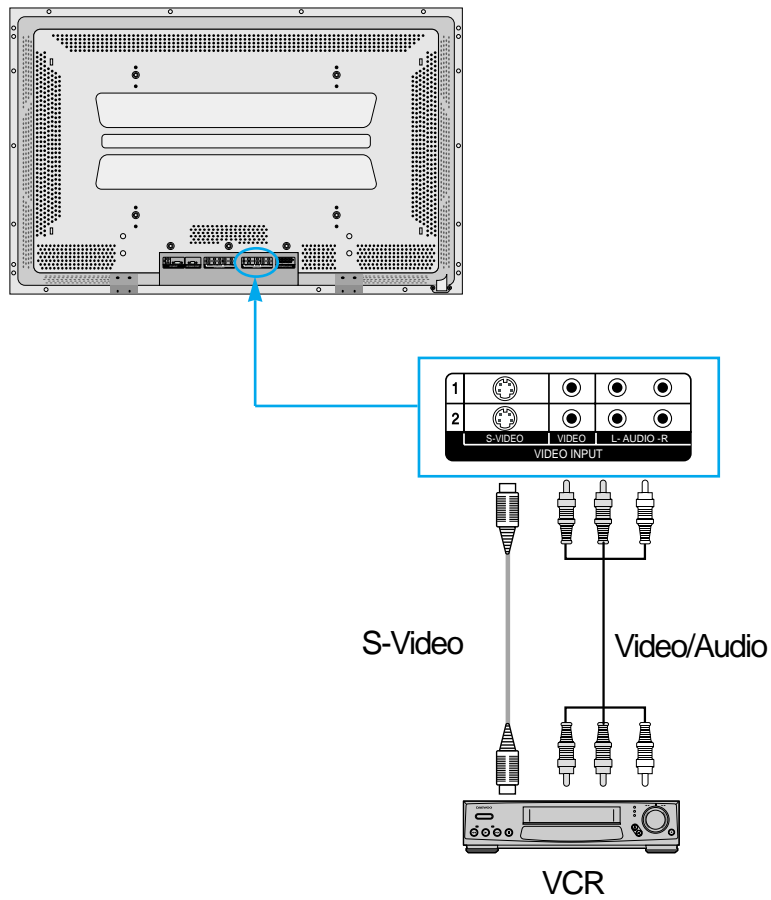

2 Press the Power Buttons

- Turn the PDP and the VCR ON.

3 Input Select

INPUT
SELECT



- Select [Video 1 or Video 2] by pressing the INPUT SELECT button of Remote Control or PDP unit.
- Each time you press the INPUT SELECT button, a different input mode appears. The sequence is as follows: Video 1 → Video 2 → PC → Component 1 → Component 2.

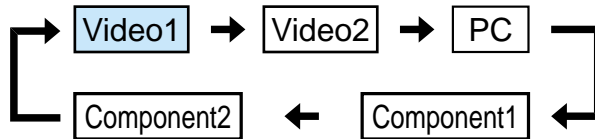

4 Select a Desired Title and Function

- Select a desired title and function by using the Remote Control of the VCR.



NOTES:

- 1) When connecting a Video, the S-Video terminal provides a better image than the normal Video terminal.
- 2) When connecting to the normal video terminal, connect 3 color AV cables (video, left audio, right audio) to the PDP; for the S-Video terminal, connect the Audio terminal (Left, Right) in the same way, and connect the Video terminal by the S-Video cable (sold separately).
- 3) When connecting the normal Video terminal and the S-Video simultaneously, the S-Video terminal is selected. This can be checked by the [Display] button of the Remote Control.

Watching a Camcorder/Game Console Image

Watching a Camcorder/Game Console Image

- Enjoy images recorded by camcorder or the game console after connecting to the PDP.

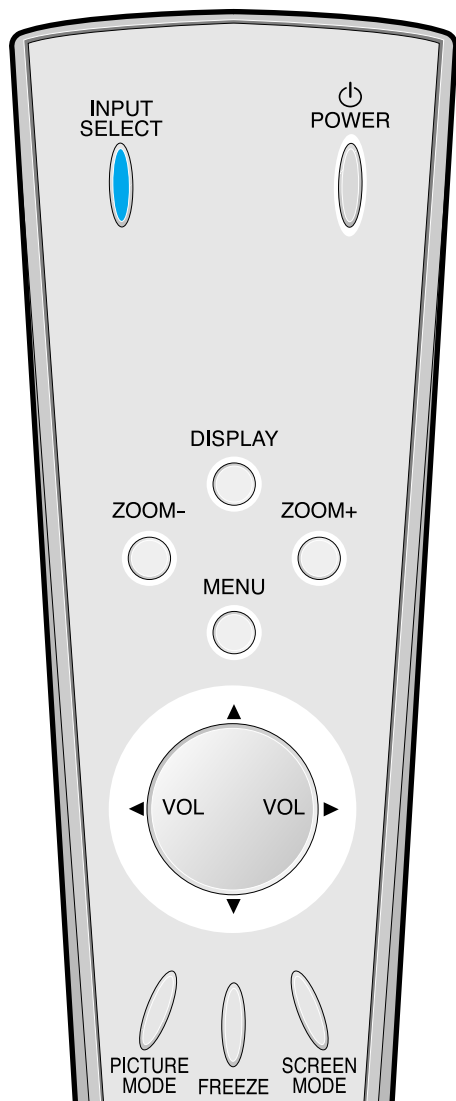

1 Connect a Camcorder/Game Console to the PDP.

- Prepare the AV cable.
- Connect the Video(Output) to the PDP(Video Input) as shown below.
- When connecting to an external AV source, match the colors.

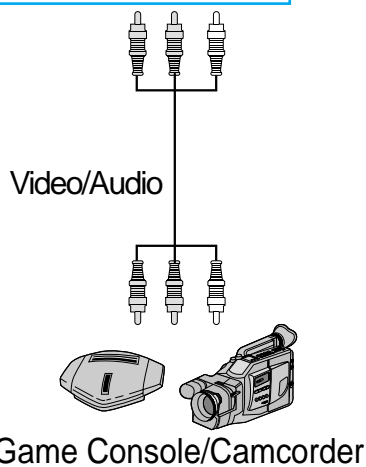
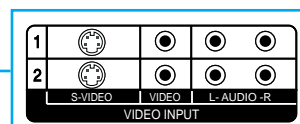
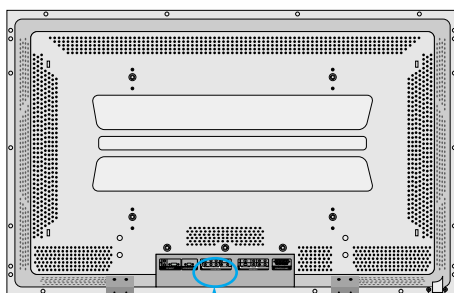

2 Press the Power Buttons

- Turn the PDP and the Camcorder/Game Console ON.

3 Input Select

INPUT
SELECT

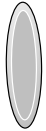

- Select [Video 1 or Video 2] by pressing the INPUT SELECT button of the Remote Control or the PDP unit.
- Each time you press the INPUT SELECT button, a different input mode appears. The sequence is as follows: Video 1 → Video 2 → PC → Component 1 → Component 2.

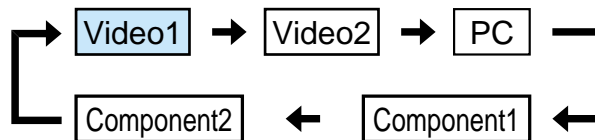

4 Select a Desired Title and Function

- Select a desired title and function by using the Remote Control of the VCR.



NOTES:

- 1) When connecting a Video, the S-Video terminal provides a better image than the normal Video terminal.
- 2) When connecting to the normal video terminal, connect 3 color AV cables (video, left audio, right audio) to the PDP; for the S-Video terminal, connect the Audio terminal (Left, Right) in the same way, and connect the Video terminal by S-Video cable(sold separately).

Connecting PC

Connecting PC

- DAEWOO PLAZMA supports resolution of VGA, SVGA, XGA, SXGA, UXGA.
- Before connecting a PC to the PDP, be sure to adjust the resolution of PC.
- This product is not supported by Plug and Play, so select Standard Monitor when setting PC monitor.

1 Before connecting to the PDP, set the resolution of the PC.

- Go to SETUP-CONTROL PANEL-DISPLAY PROPERTIES in Window Screen.
- Choose the SETTINGS tab in the DISPLAY Menu.
- In the SETTINGS Menu, select 640x480 or 800x600.

2 Connect the PC to the PDP.

- Prepare the PC cable (D-sub 15pin) and the PC audio cable(Sold separately).
- Connect the PC(Output) to thePDP(Input) as shown below.

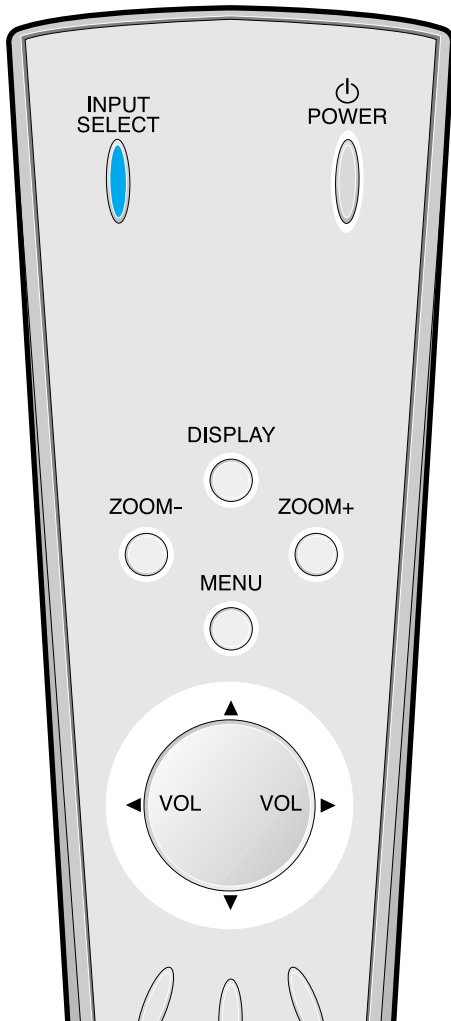
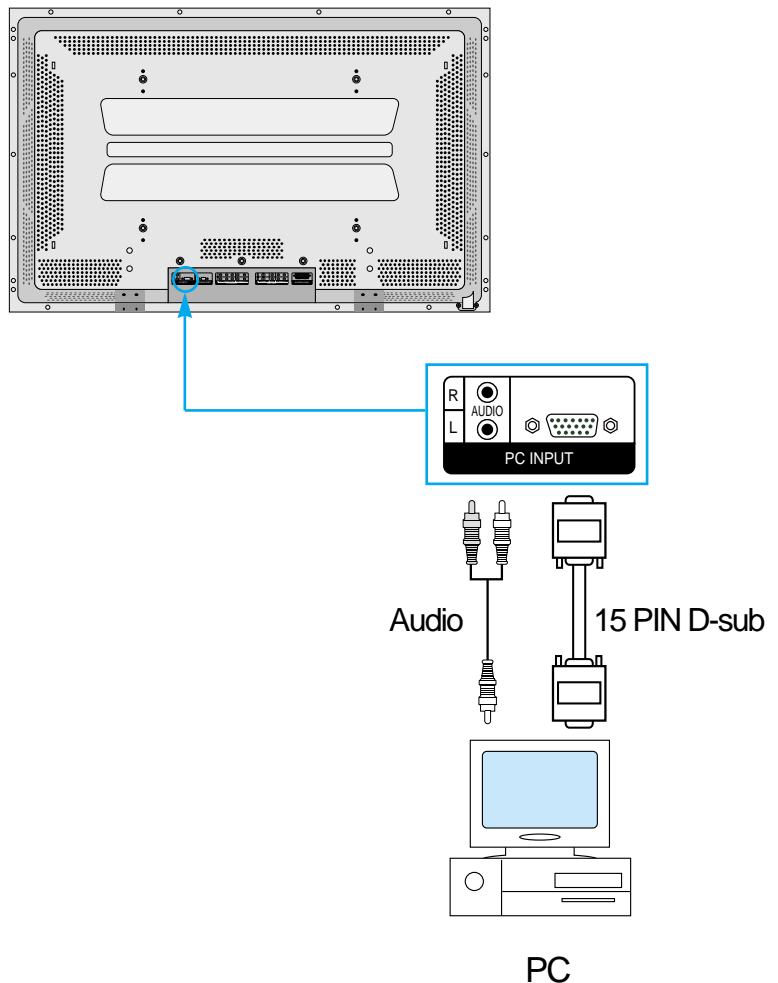



3 Press the Power button.

- Turn on the PDP and the PC.

4 Input Select

INPUT
SELECT



- Select [PC] by pressing the INPUT SELECT button of the Remote Control or PDP unit.
- Each time you press the INPUT SELECT button, a different input mode appears. The sequence is as follows:
PC → Component 1 → Component 2 → Video 1 → Video 2.

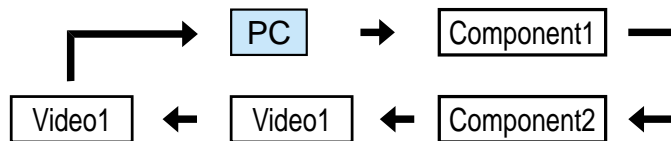

5 Enjoy Dynamic Ultra Screen Monitor by Using PC's Keyboard or Mouse.



NOTES:

- 1) The resolution of the PC monitor is best at 640 x 480 (VGA).
- 2) If there is a [Vertical Frequency] setting menu in the [Display] Menu of the PC, adjust the frequency to 60Hz.
- 3) If the PC resolution is too high, it may be hard to read letters. Select a suitable resolution.

PC Input Resolution Available in PDP

Resolution	Horizontal Frequency(KHz)	Vertical Frequency(Hz)	Remark
640x350	31.469	70.1	IBM
	37.861	85.1	VESA
640x400	24.823	56.4	NEC
	30.48	60.0	PGA
	31.469	70.1	IBM (DOS)
	37.861	85.1	VESA
640x480	31.469	59.9	DOS
	35	66.7	Macintosh
	37.861	72.8	VESA
	37.5	75.0	VESA
	39.375	75.0	IBM
	43.269	85.0	VESA
720x400	31.47	60.1	VGA
	31.469	70.1	IBM
	37.927	85.1	VESA
720x480	31.54	60.0	480P
720x576	15.63	25.0	PAL
800x600	35.156	56.3	VES
	35.16	57.2	VESA
	37.879	60.3	VESA
	48.077	72.2	VESA
	46.875	75.0	VESA
	53.674	85.1	VESA
832x624	49.726	74.0	Macintosh
1024x768	48.193(48.077)	59.3(59.8)	Macintosh (OAK)
	48.363	60.0	VESA
	53.95	66.1	XGA
	56.476	70.1	HP & VESA
	60.241	74.9(74.6)	Macintosh
	60.023	75.0	VESA
	68.677	85.0	VESA
	80.66	100.0	Fujitsu
1152x864	70.84	84.0	SUN
	54	60.0	VAX
	63.851	70.0	VESA
	67.5	75.0	VESA
1152x900	77.094	85.0	VESA
	61.796	66.0	SUN
	71.713	76.0	SUN
1280x720	45	60.0	720P
1280x960	60	60.0	VESA
	75	75.0	VESA
	85.938	85.0	VESA
1280x1024	46.433	43.4	VESA
	63.981	60.0	VESA
	70.66	66.5	VAX
	74.88	70.0	NEC
	78.125	72.0	HP & HITA
	78.855	74.0	Sony & NEC
	79.976	75.0	VESA
	81.13	76.1	SUN
91.416	85.0	VESA	
1600x1200	62.5	48.0	VESA
	75	60.0	VESA
	81.25	65.0	VESA
	87.5	70.0	VESA
	93.75	75.0	VESA
	100	80.0	VESA

Selecting Auto Picture Mode

1 Selecting Picture Mode

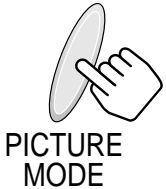

- Press the [PICTURE MODE] on the Remote Control.
- Pressing the [PICTURE MODE] first time will display the current PICTURE MODE.

Selecting Auto Picture Mode

- Select the Picture modes that are automatically set depending on the kinds of pictures, and enjoy them.

2 Each Press of the Button Will Select One of Four Picture Modes.

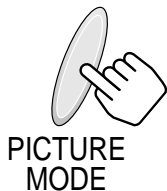

- Each time you press the button, a different Picture mode appears. The sequence used is as follows:

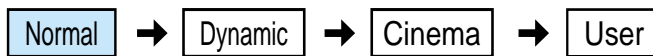

- * Normal : For a highly defined image in a normally bright room
- * Dynamic: For a clear-cut image emphasizing high contrast for sports viewing
- * Cinema: For a movie
- * User: Allows the user to customize settings as desired.

3 Menu on the Screen Will Disappear.

- After selecting a desired Picture mode, the menu on the screen will disappear.
- Normal, Dynamic, and Cinema Modes are factory preset values. If you want to customize the Picture modes, refer to the following page.



NOTES:

- * Normal, Dynamic, and Cinema Modes are factory preset values.
- * When adjusting sub-menus while you are in Normal, Dynamic, and Cinema Modes, the Picture Mode will be automatically converted to User Mode, and the adjustments will be made.
- * Pressing of the [INITIALIZATION] button in the [Utility] Menu will allow for the Brightness, Contrast, etc. to return to the factory preset values.
- * The SHARP Menu adjusts the picture sharpness.
- * Adjusting the Color Temperature makes the mood warm or cold.

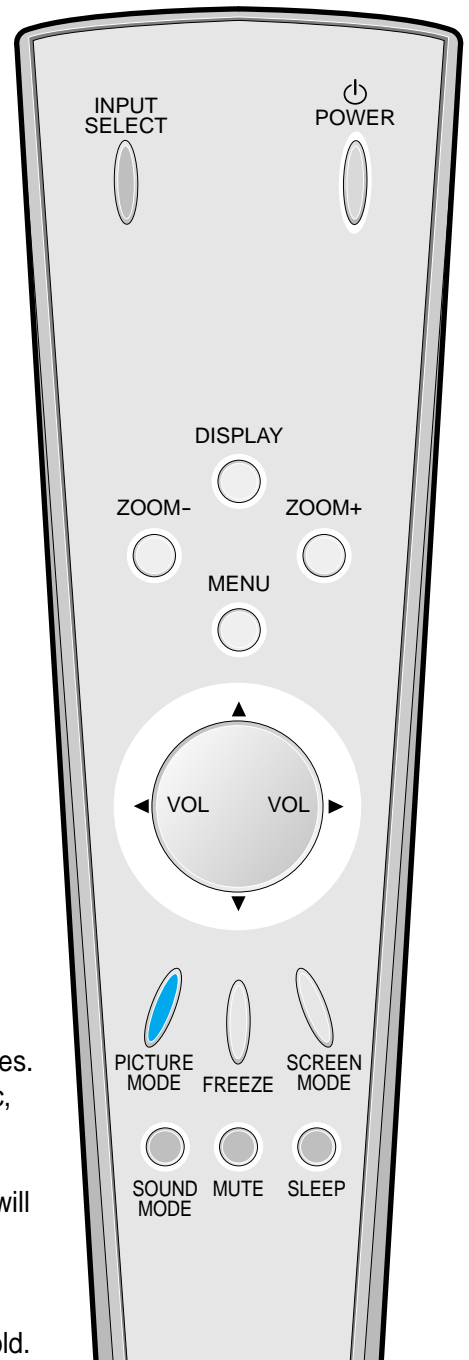

Customizing Picture

Customizing Picture

- You can adjust the color tone and brightness to your preference.

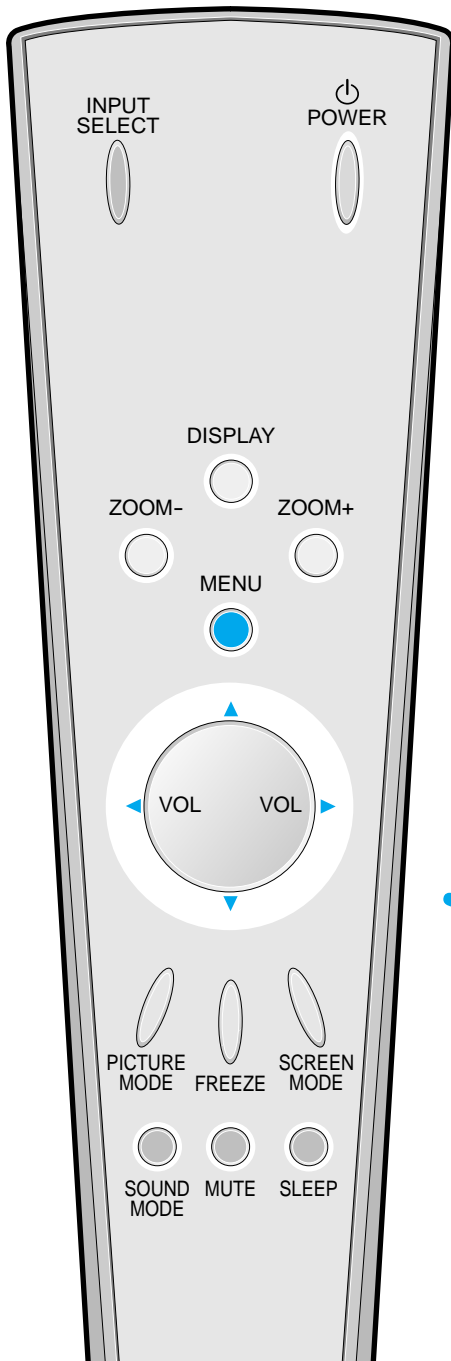

1 Press the MENU Button.

- The MENU shown below will display on the screen.

MENU

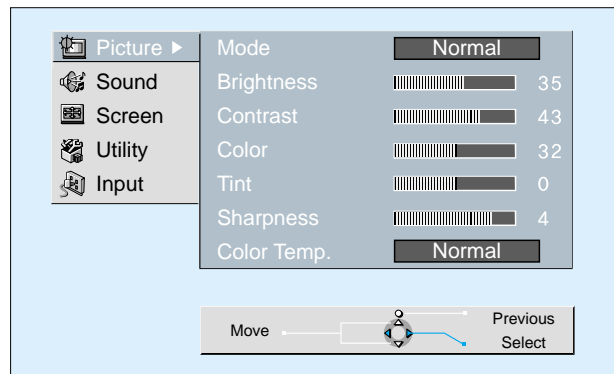

2 Press the ▲/▼ Button.

- After selecting [Picture] by the ▲/▼ buttons, press the ► button that will display the following.

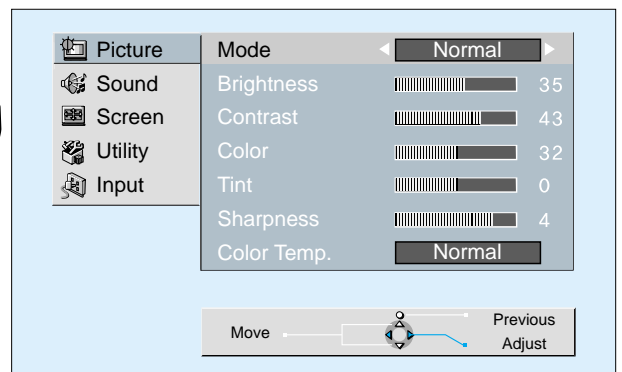
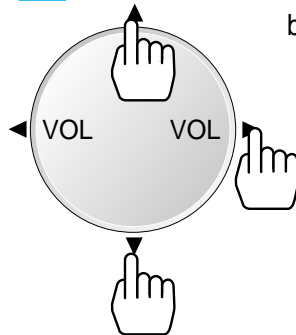

3 Select the Custom Mode.

- Select [User] by the ◀/▶ buttons.

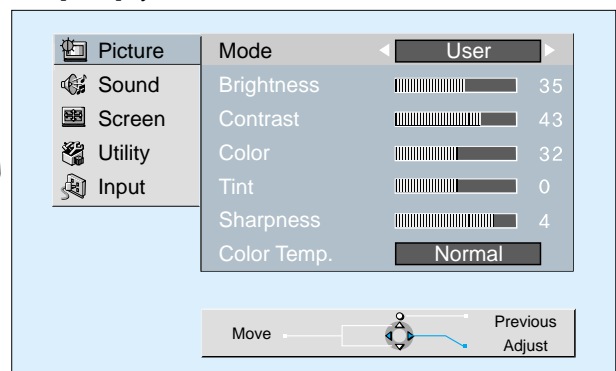
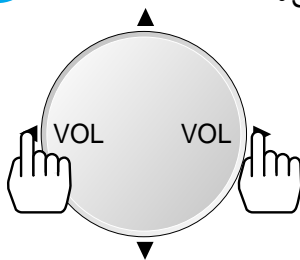

4 Select User Mode Adjustments

- While you are in [Picture Mode – User], press the ▲/▼ buttons to select a specific adjustment item.

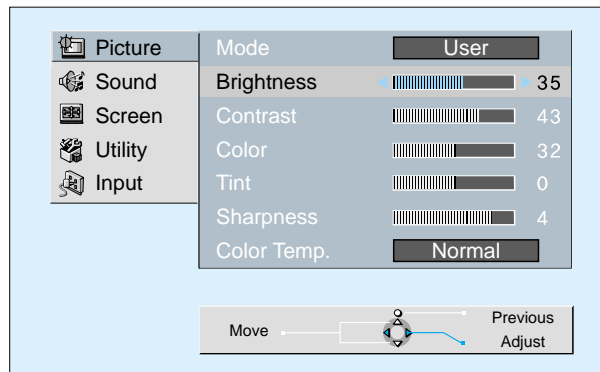
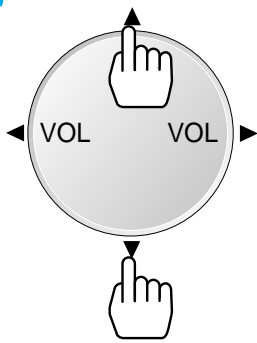

5 Picture Condition Adjustments

- Press the ◀/▶ buttons to adjust the picture at your preference.

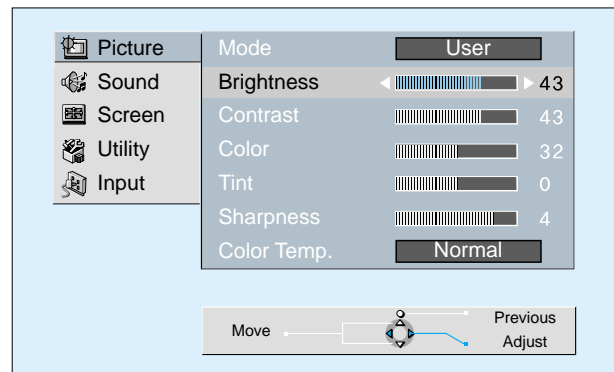
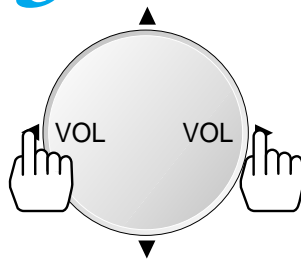

NOTES:

- * While you are in the PC INPUT mode, you can only adjust brightness, contrast, sharpness and color temperature.
- * When you adjust Brightness, Contrast, Color, Tint in DTV or PC mode, the picture is adjusted finely.
- * Adjusted Values are memoried in each mode separately.

Adjusting Screen Size

Adjusting Screen Size

- You can adjust screen size or aspect ratio as desired.

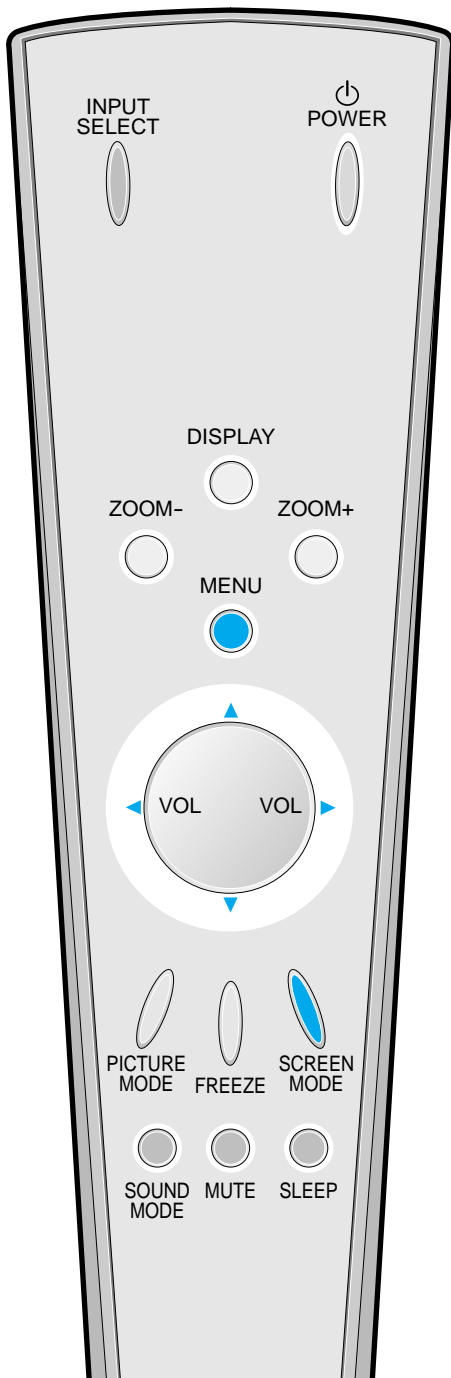

1 Press the SCREEN MODE Button.

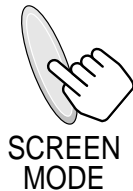

- Each time you press the SCREEN MODE button on the Remote Control, a different SCREEN MODE appears. The sequence used is as follows:
- The MENU shown below will display on the screen.

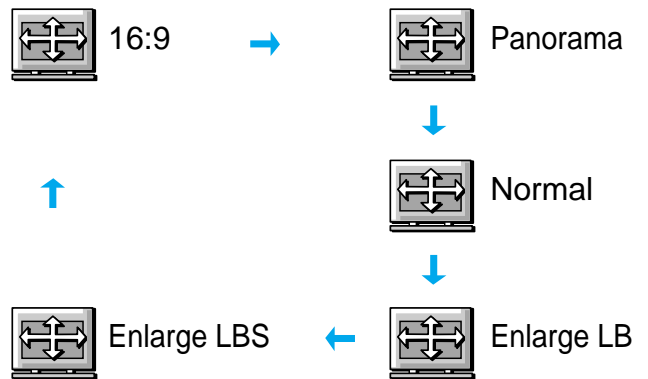

NOTES:

- When the INPUT SIGNAL is [DTV in COMPONENT 1 or COMPONENT 2], only the aspect ratios of 16:9 and 4:3(Normal) will be applied by Input signal. Etc) If input signal is 16:9, PDP displays in 16:9 mode.
- The digital broadcasting (720p, 1080i) is fixed at the aspect ratio of 16:9.
- Displaying a picture in a normal mode (4:3) for a long time may cause phosphor of the PDP to be burned.
- 16:9 : Theater-like 16:9 picture formats
 - Panorama : 16:9 picture formats with panorama effect
 - Normal : Displays pictures of normal size (i.e., a 4:3 aspect ratio)
 - Enlarge LB : Enlarges the screen as to fill the black part of up and down.
 - Enlarge LBS : Enlarges the screen, and shifts up as to see the subtitles in case you are watching video with subtitles.



1 Press the MENU Button.

• Press the [MENU] button on the Remote Control.

MENU

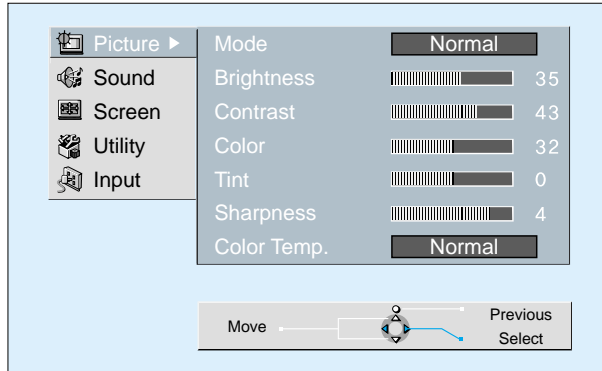

Adjusting from MENU Screen

2 Select "Screen".

• Press the Channel ▲/▼ buttons to select "Screen."

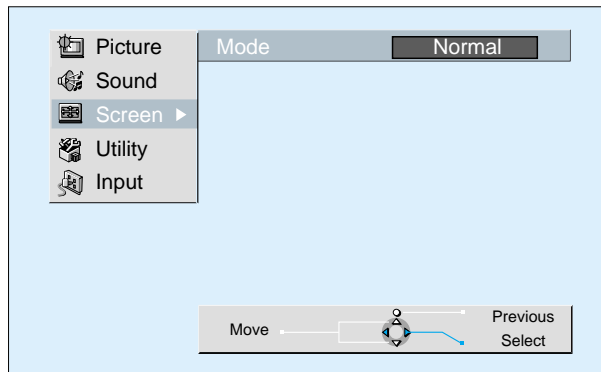
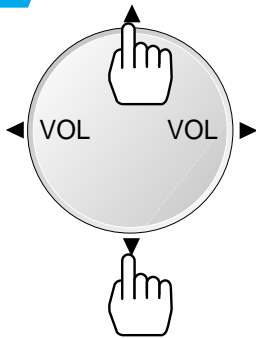

3 Select the Screen Size.

• Press the Volume ◀/▶ buttons to select "Screen Size".

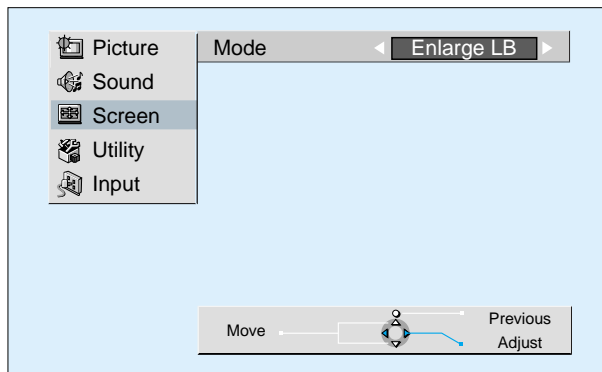
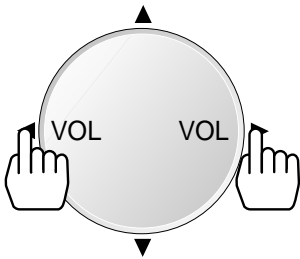

Adjusting Screen Position and Size

Adjusting Screen Position and Size

- You can adjust the screen position and size as desired.
- This function is only used when adjusting the screen position and size on the PDP monitor by using the PC input signal.



1 Press the MENU Button.

- The MENU screen as shown below will appear.

MENU

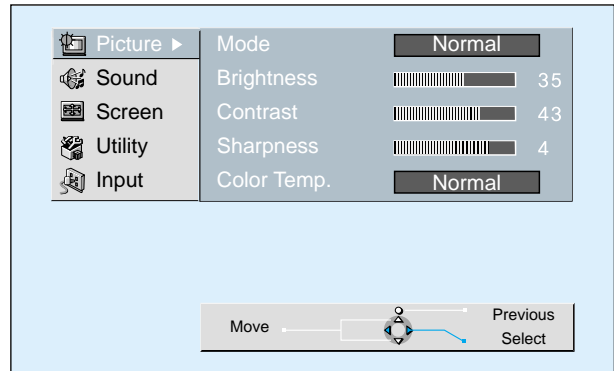

2 Press the ▲/▼ Button.

- Press the ▲/▼ buttons to select 'Screen'.

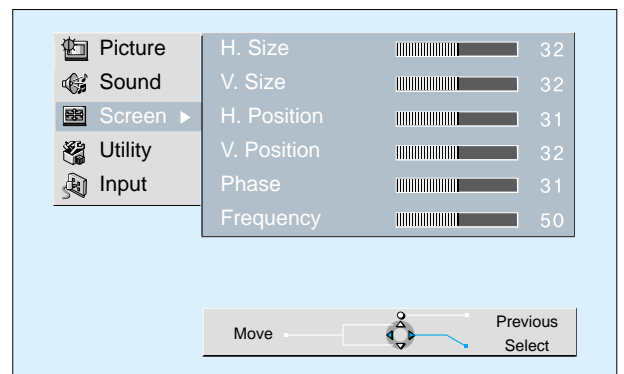
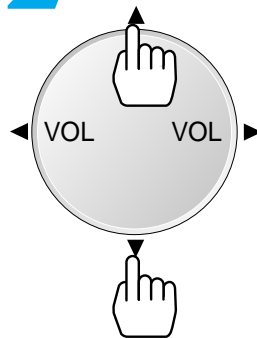



3 Press the Volume ◀/▶ Buttons.

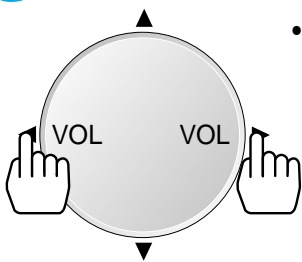

- Press the Volume ◀/▶ buttons to select “Screen”.
- While you are in ‘Screen’ mode, press the ▲ or ▼ button to select a desired item, and then, adjust the value by pressing ◀ or ▶.

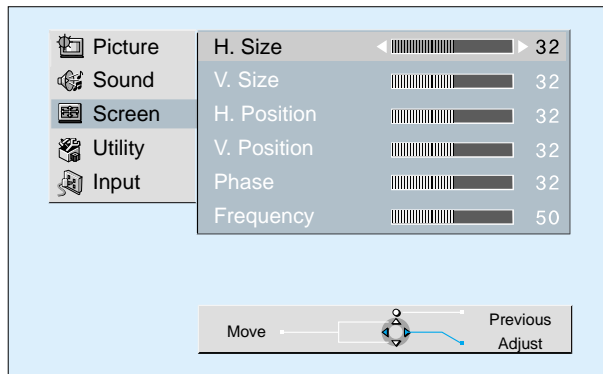

NOTES:

- 1) Horizontal/Vertical size and position values can be adjusted only in the [PC] input mode.
- 2) H. Size: As the value increases, the screen width increases
- 3) V. Size: As the value increases, the screen height increases.
- 4) H. Position: Increasing value moves screen to the right.
As the value increases, the screen moves to the right.
- 5) V. Position: Increasing value moves screen up.
As the value increases, the screen moves up.
- 6) Phase: When there are zitter or blurring in image, adjust this value.
- 7) Frequency: When there are zitter or blurring in image, adjust this value.

Enlarging Screen Size

Enlarging Screen Size

- You can view enlarged size of the screen with this function

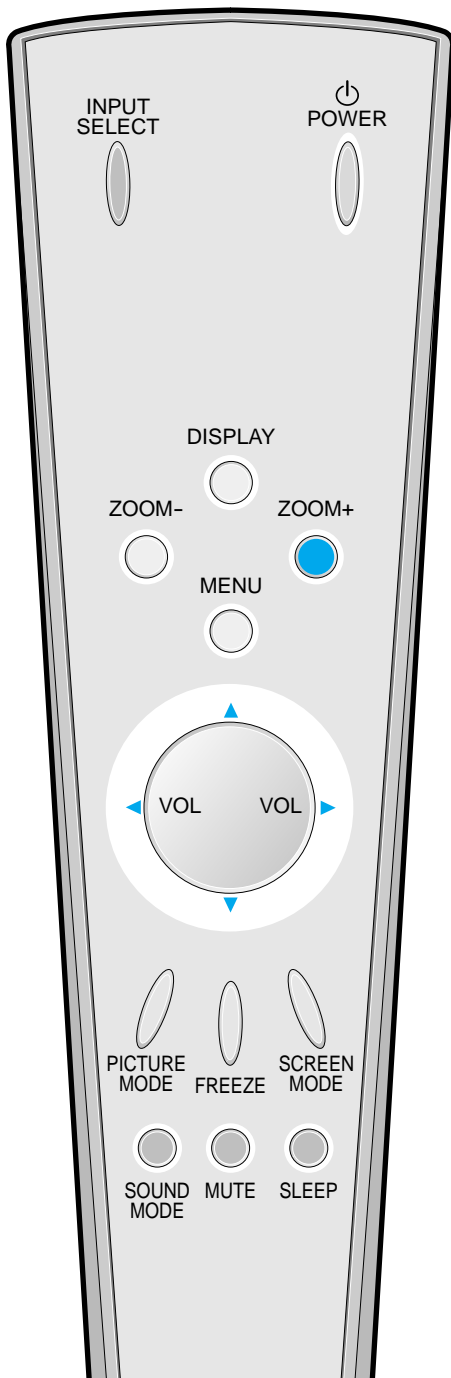

1 Press the 'ZOOM+' Button.

ZOOM+



- Press the 'ZOOM+' button to show currently selected screen size.
- Each time you press the 'ZOOM+' button, the screen size will increase stepwise in 0 ~ 20 scale.
- To reduce the screen size, press the [ZOOM-] button.

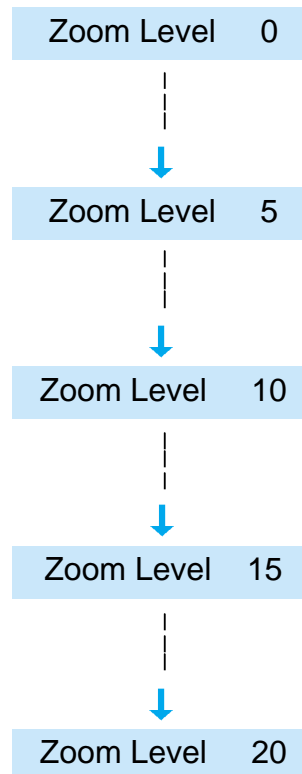
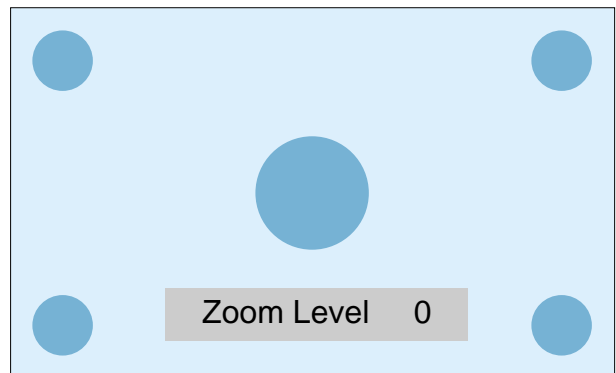

2 Move the Screen Position.

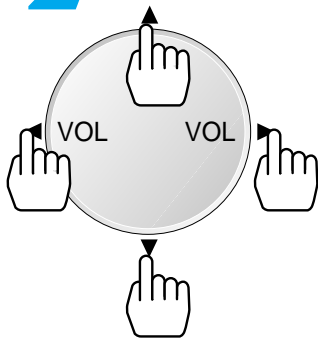

- While you are in the 'Zoom' mode, press the ▲/▼, ◀/▶ buttons to move screen stepwise up/down, left/right, respectively.

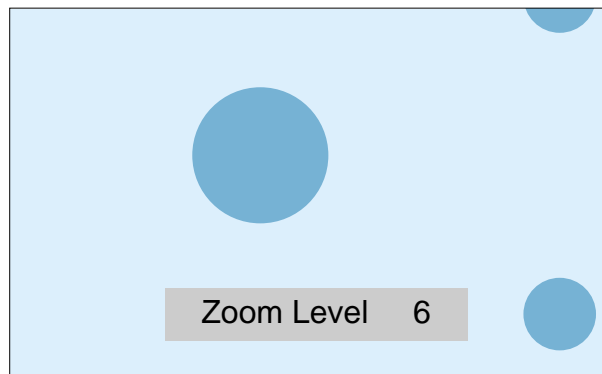

NOTES:

- * When the screen is enlarged, the pixel of the screen can become thick and dim.
- * When only subtitle of zoom level remains, you can scroll the image.
If subtitle of zoom level disappears, press zoom key, and scroll the image.

Watching a Still Image

Watching a Still Image

- You can view still images temporarily with this function. However, displaying the same images such as still images for a long time may cause after-image lagging.

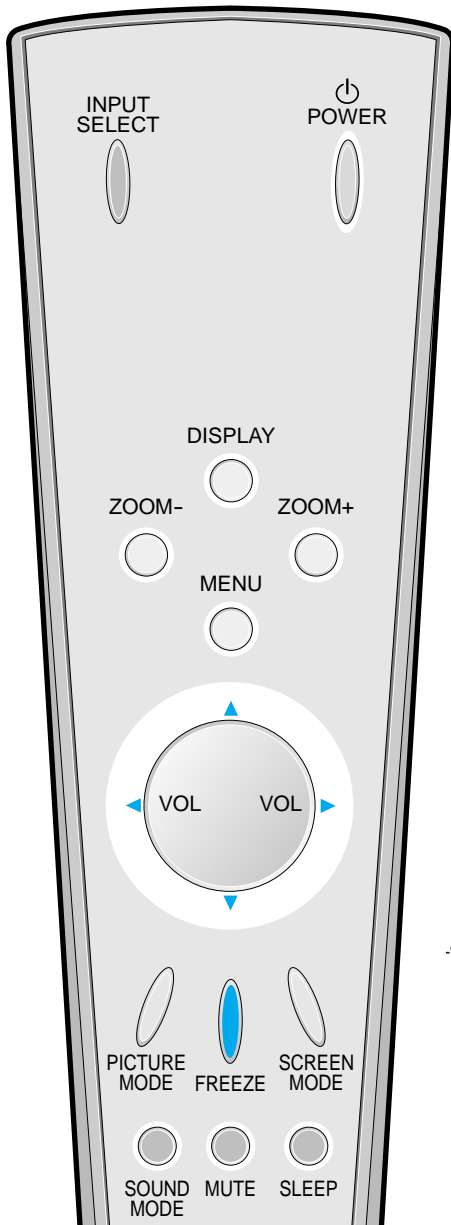

1 Press the 'FREEZE' Button.

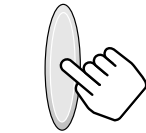

FREEZE

- If you wish to freeze a picture, press the 'FREEZE' button. You can still hear the sound.
- Press FREEZE button to cancel the 'FREEZE' function.
- To view the enlarged images, press the [ZOOM+] button.

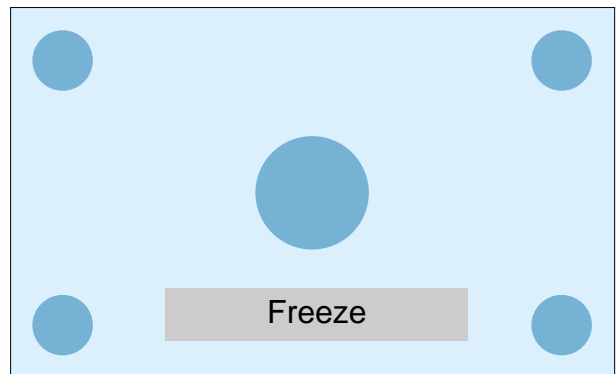

2 Move the Screen Position.

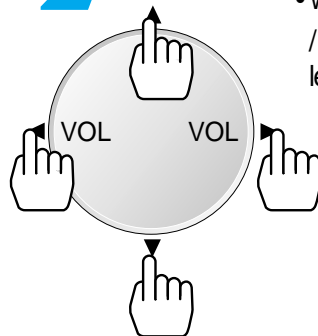

- While you are in 'FREEZE' mode, press the ▲/▼, ◀/▶ buttons to move screen stepwise up/down and left/right.

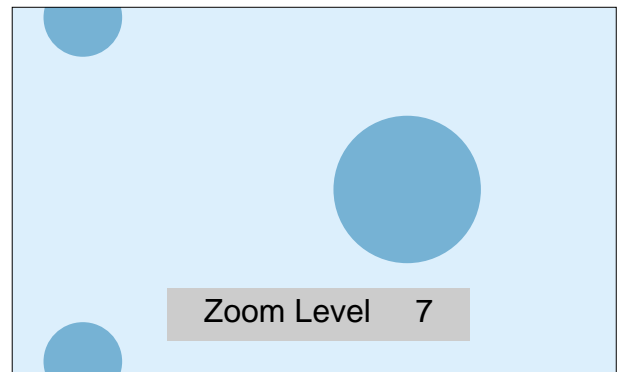

NOTES:

- Displaying the same images such as still images for a long time may cause after image lagging.
- In this case, such "after image" may become less noticeable if moving images are later displayed for a long time.
- However, an after-image may become a permanent one, damaging the Plasma Display; therefore, avoid displaying the same images for a long time.

Adjusting Auto Sound Mode

1 Select SOUND Mode.



- Press the [SOUND MODE] on the Remote Control.
- Press of the [SOUND MODE] for the first time will display the current SOUND MODE.

Adjusting Auto Sound Mode

- Enjoy various sound modes by selecting your favorite Sound Mode depending on the kinds of moving pictures.

2 Every Press of the Button Changes Modes.



- Each time you press the button, a different sound mode appears. The sequence used is as follows:

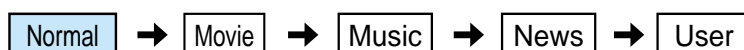

- * Normal : Suitable for watching any motion picture
- * Movie : Select this mode to simulate being at a movie theater
- * Music : Ideal for listening to music
- * News : Allows human voice to be heard more clearly
- * User : Allows the user to adjust as desired.

3 MENU will Disappear.

- After selecting a desired SOUND Mode, on-screen menu will disappear in about 2~3 seconds.
- Normal, Movie, Music, News Modes are factory preset values. If you want to customize the sound modes at your preference, refer to the following page.

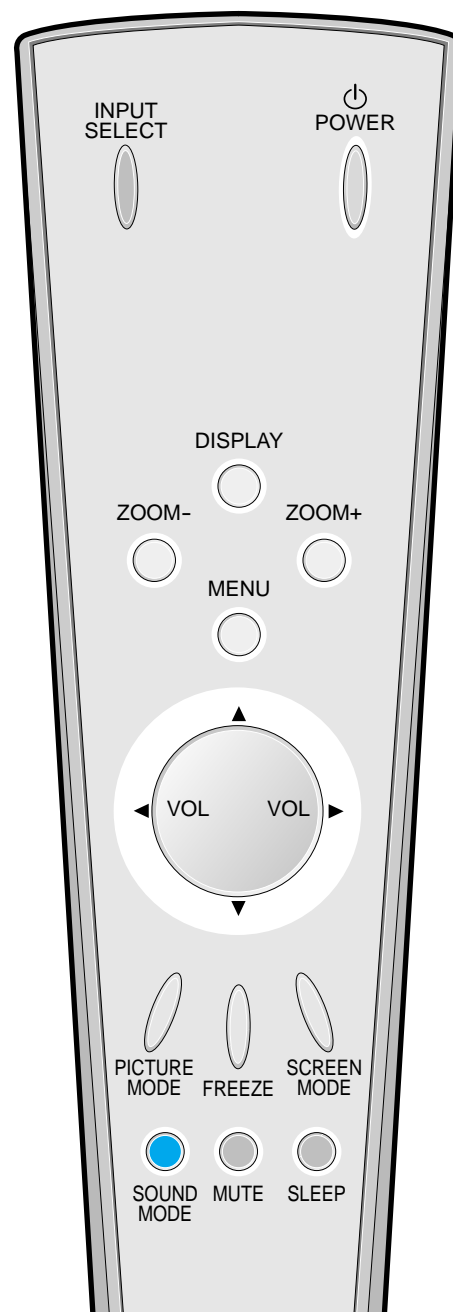

Customizing Sound Mode

Customizing Sound Mode

- This feature allows the user to adjust at his preference.



1 Press the MENU Button.

- The MENU Screen as below will be displayed.

MENU

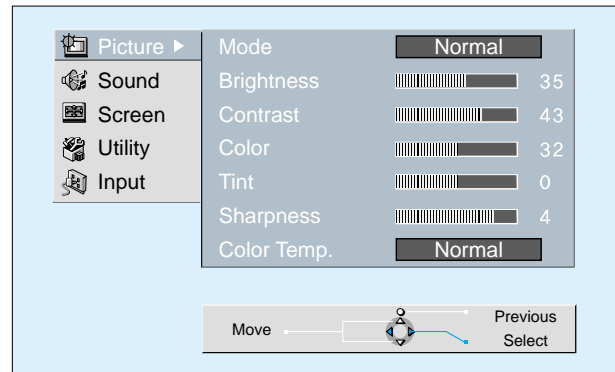

2 Press the ▲/▼ Button.

- Select [SOUND] by the ▲/▼ buttons, then press the ► button to display the following.

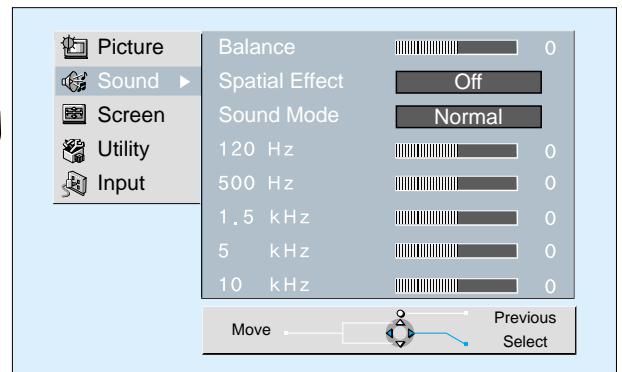
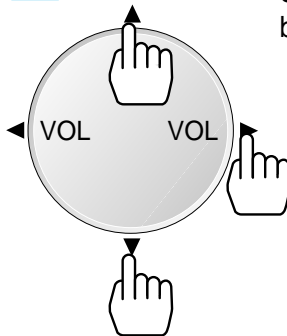

3 Select SOUND BALANCE.

- Select [SOUND BALANCE] by the ◀/▶ buttons, then adjust it.
- Sound balance is best at '0'.
- Sound Balance: Adjusts sound balance of left and right speaker.

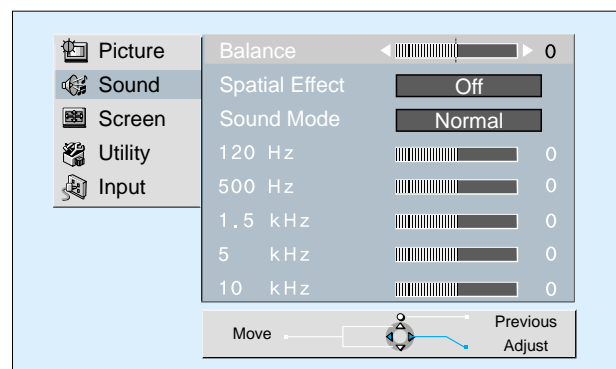
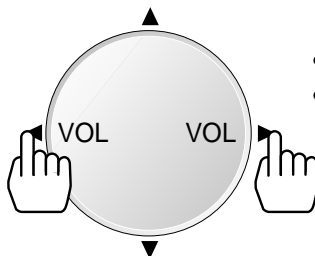

4 Select the Spatial Effect Mode.

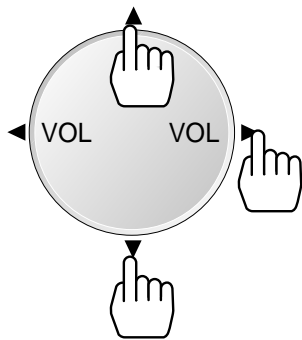

- Select Spatial Effect by pressing the ▲/▼ buttons, then select ON/OFF by pressing the ► button.
- Spatial Effect: Used to feel grotesque by emphasizing stereo effect.

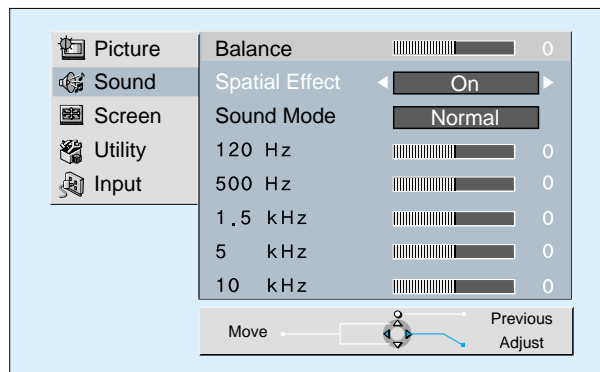

5 Select the SOUND Mode.

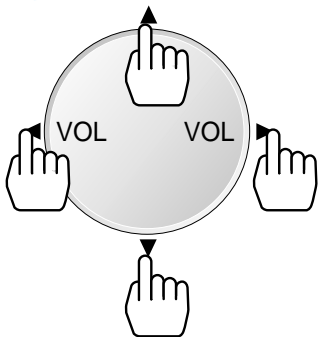

- Select the Sound Mode by pressing the ▲/▼ buttons, then adjust it by pressing the ◀/▶ buttons.

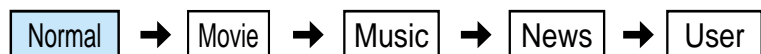
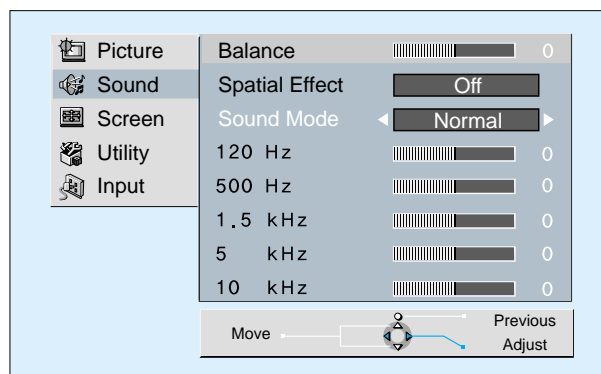

- * Normal : Suitable for watching any motion picture
- * Movie : Select this mode to simulate being at a movie theater
- * Music : Suitable for listening to music
- * News : Allows human voice to be heard more clearly
- * User : Allows the user to adjust as desired.



NOTES:

- 1) Custom Mode : Used as an Equalizer with which the user can adjust the sound frequency as desired.
- 2) If you modify the sound frequency in auto Sound Mode (News, Movie, Music, etc.), it is automatically switched to the User Mode.
- 3) Low sound is emphasized as the frequency is lowered to 120 Hz, and high sound as raised to 10 KHz.
- 4) When INPUT is MONO and if you make connection to the Left Audio Input, you can hear from both speakers.

Selecting INPUT SIGNAL

INPUT SIGNAL

- Used to select INPUT signal of external device connected to the PDP.



1 Press the INPUT SELECT Button.

INPUT SELECT

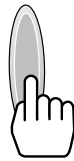

- Press the [INPUT SELECT] button on the Remote Control or the PDP Display to select [COMPONENT 1] or [COMPONENT 2].
- Each time you press the [input select] button, a different screen mode appears. The sequence used is as follows: COMPONENT 1 → COMPONENT 2 → VIDEO 1 → VIDEO 2

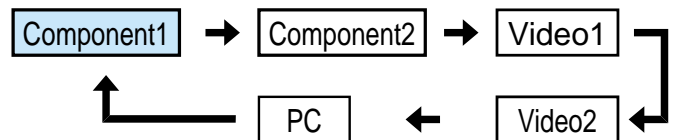
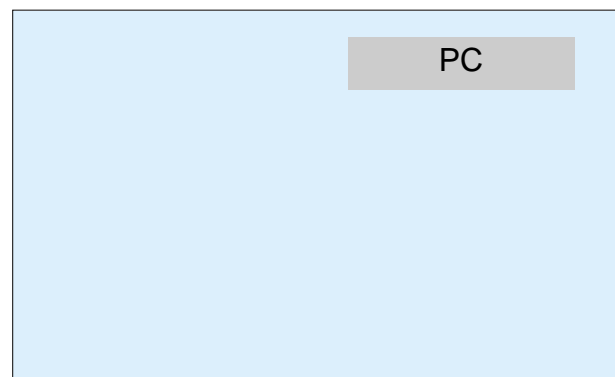

NOTES:

- * If an external device is not connected or INPUT signal is not applied, Warning Message (“No Signal”) would be displayed.
- * In this case, check if external device is connected and or terminal connection is properly done.



1 Press the MENU Button.

• Press the [MENU] button on the Remote Control.

MENU

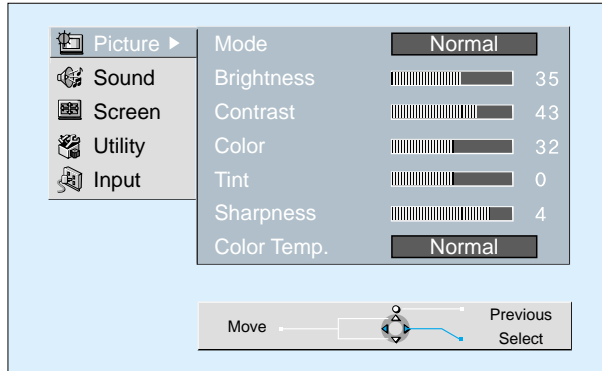

Adjusting from the MENU Screen

2 Select INPUT.

• Select [INPUT] by the ▲/▼ button.

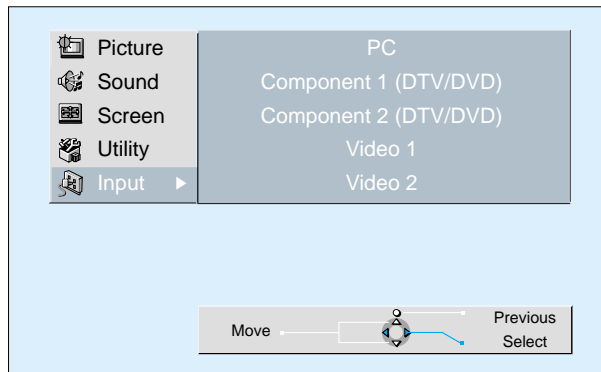
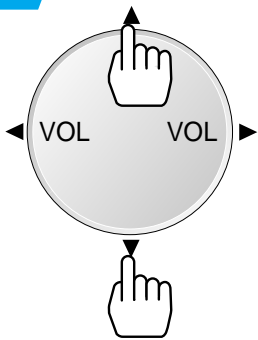

3 Select INPUT SIGNAL.

• Select [INPUT SIGNAL] by the ▲/▼ buttons, then press the ► button.

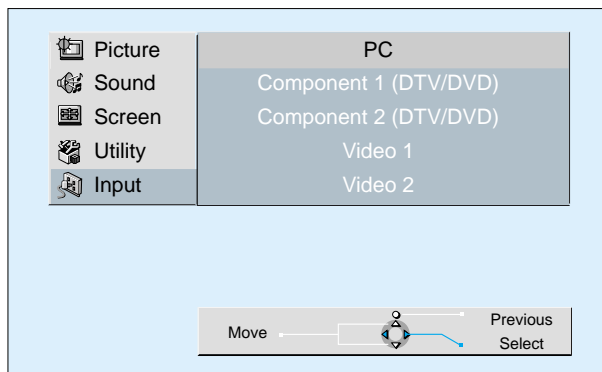
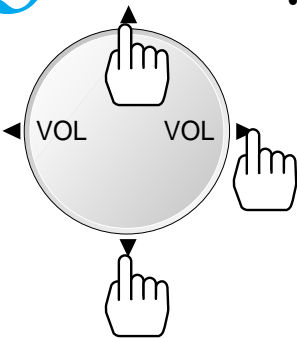

Checking the Current Input Signal

Checking the Current Input Signal

- Used to check the INPUT signal mode, resolution, frequency, etc. of the current screen.



1 Press the DISPLAY Button.

- Press the [DISPLAY] button on the Remote Control.

DISPLAY

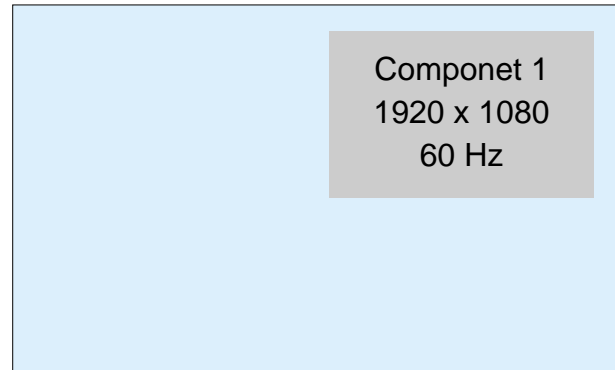

1. If you watch Digital Broadcasts:

Componet 1 — Displays which input terminal is used, and indicates the input signal mode.
 1920 x 1080 — Indicates the horizontal and vertical resolution of the current INPUT signal.
 60 Hz — Indicates the frequency of the current INPUT signal.

2. If you watch DVD image:

Componet 2 — Displays which input terminal is used, and indicates the signal mode.
 YUV 60 Hz — Indicates the mode and frequency of the current INPUT signal.

3. If you watch VCR image:

Video 1 — Displays which input terminal is used, and indicates the signal mode.
 NTSC 60 Hz — Indicates the mode and frequency of the current INPUT signal.



NOTES:

- 1) DAEWOO PLASMA can receive NTSC, PAL, SECAM, etc.
- 2) "1920 x 1080" displayed in the INPUT signal does not indicate the resolution of the monitor, but the signal that is sent by Digital Broadcasting Receiver.

Selecting MENU Background Screen and Language

1 Press the MENU Button.

- The MENU screen will be displayed as below.

MENU

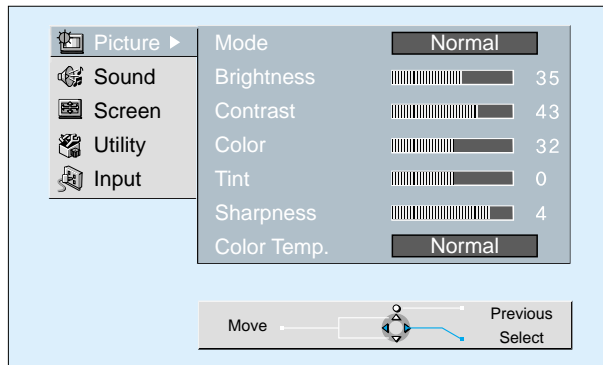

Selecting Languages

- Used to select transparency of the background screen and language used in MENU.

2 Press the ▲/▼ Button.

- Select [Utility] by the ▲/▼ button.

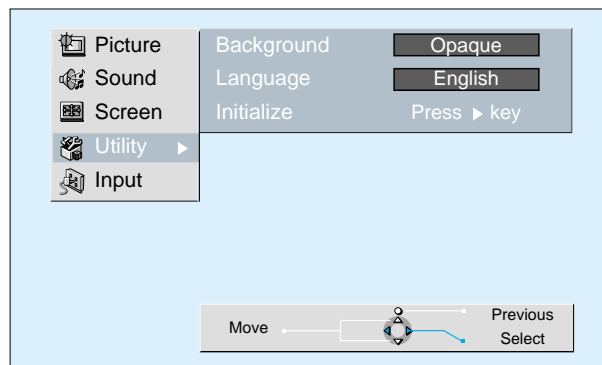
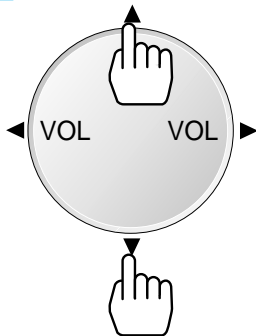

3 Select the MENU Background Screen.

- Select the [MENU Background Screen] by pressing the ▶ button.
- Every press of the ▶ button while you are in the [MENU Background Screen] would switch between Transparent/Opaque.

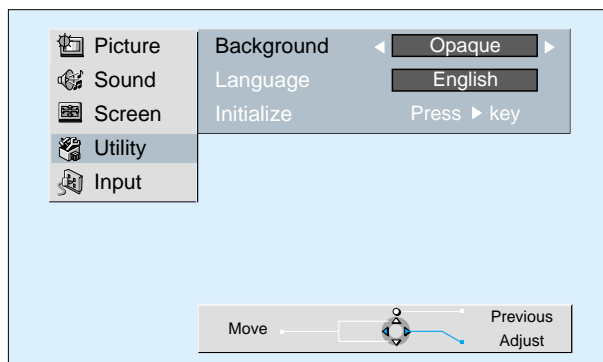
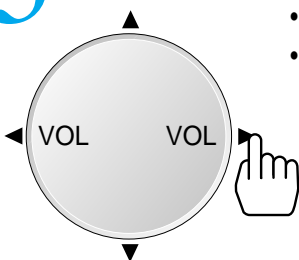

Selecting MENU Background Screen and Languages

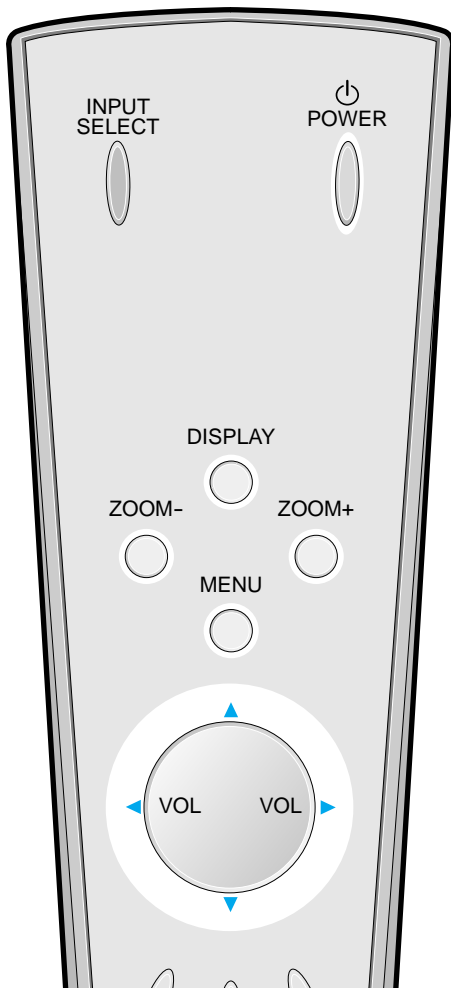

4 Select MENU LANGUAGE SELECT by the ▲/▼ Button.

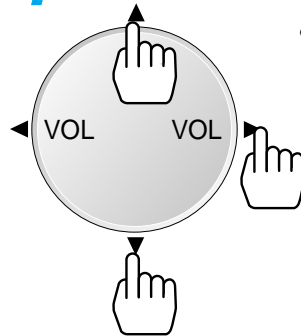

- Select LANGUAGE by the ▲/▼ button.
- Every press of the ► button while you are in the [LANGUAGE] mode would cycle through the different languages.

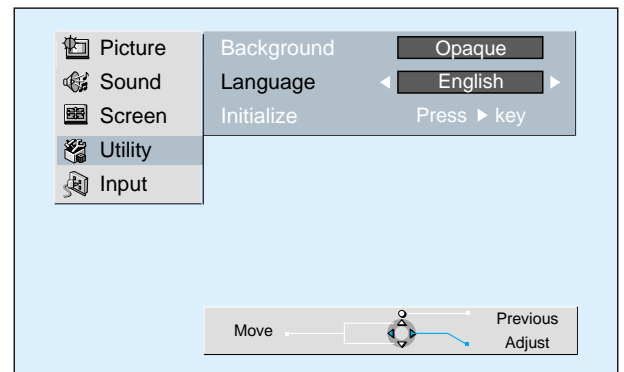

NOTES:

- * When Power is turned ON first time, 'SELECT LANGAUGE' Mode will be displayed, then, select a desired language by ► button. (Displayed only once)

Back to Initialization

- You can restore the values of the adjustment/setting made in the MENU to factory settings.

5 INITIALIZATION will Start.

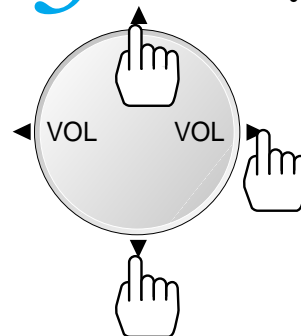

- Select [INITIALIZATION] by the ▲/▼ buttons, then press the ► button to start initialization.

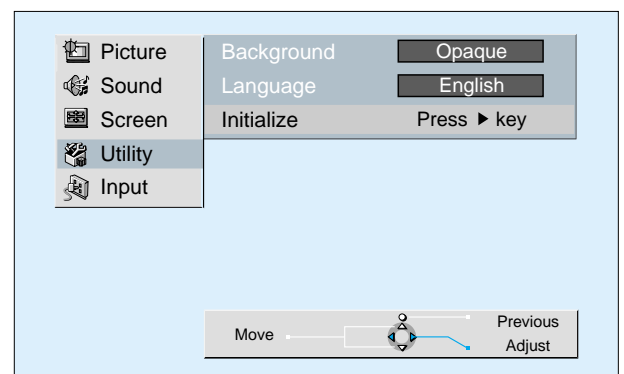

When [INITIALIZATION] is completed:

- * When [INITIALIZATION] is completed, those values that have been set in the User Mode of [SCREEN MODE] and [SOUND MODE] will be returned to the factory preset values.
- * When you try to initialize, be advised that you should think it over.
- * The items in the [SCREEN] Menu in PC INPUT are also initialized (i.e., H. Size, V. Size, H. Position, V. Position, Phase, Frequency, etc.)
- * Language, volume, OSD background, input mode are not initialized.

Setting Sleep Timer

1 Press the SLEEP Button.



- Press the [SLEEP] button on the Remote Control.
- Pressing the [SLEEP] button first time will display the current setting for SLEEP TIMER.
- To cancel the SLEEP TIMER, press the ► Sleep button to select 'OFF'.

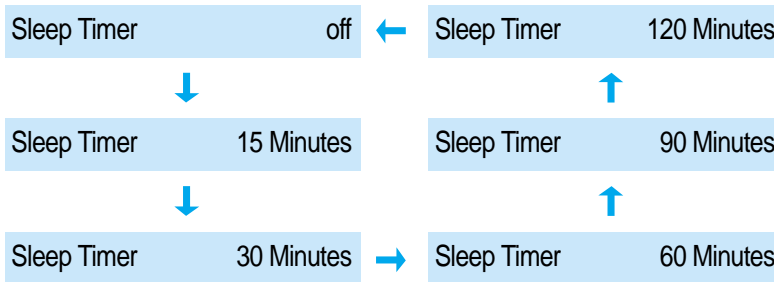
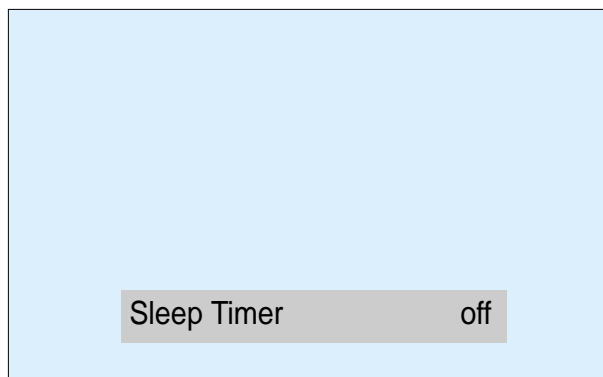

Setting Sleep Timer

- SLEEP TIMER turns the Monitor off after a preset time.

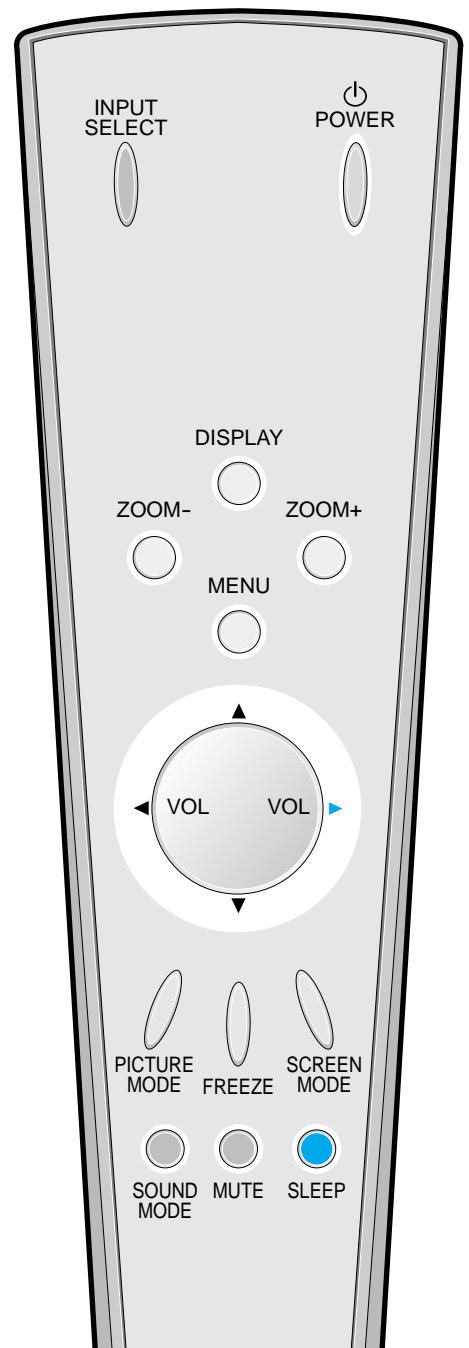

NOTES:

- 1) On-screen information disappears if you do not take any action for about two seconds after pressing the SLEEP button.
- 2) If you turn the Monitor off after setting SLEEP, the setting is erased.

Before Requesting Service

Before requesting for a service, check the following points once again.

S
t
o
p
p
s

• **Remote control does not function properly.**

- Check for any obstacle between the Remote Control and the Display.
- Check for dead batteries and incorrect battery orientation.
- Check if the Remote Control is the right one.

C
h
e
c
k
s

A
c
t
i
o
n

- Remove any obstacle between the Remote Control and the Display.
- Replace batteries and use the correct polarity (+) or (-) of the batteries.
- Use the pertinent Remote Control proper to the model.

• **The Display makes a snapping sound.**

- Check if the pictures and sound are normal.
- This sound is produced due to variations in room temperature.
- This sound does not indicate that the Display has a problem if the pictures and sound can be viewed and heard properly.

• **There are empty spots at the top and the bottom area of the screen.**

- Check if the screen size of an image is wider than 16:9 aspect ratio (theater screen size).
- When video screen is wider than 16:9 aspect ratio, you may see dark areas at the top and the bottom of the screen.

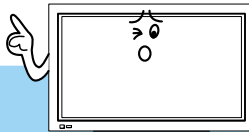
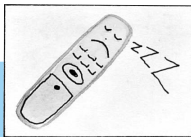

Before Requesting for a Service

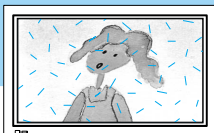

S
t
o
p
p
s

• **There are spots on the screen or screen rolls.**

- Check if your product is affected by any interference from automobiles, high-voltage transmission lines, neon signs or other potential sources.

C
h
e
c
k
s

A
c
t
i
o
n

• **Screen size is suddenly changed.**

- The screen size of a video image may not be matched to the size of the dark initial screen.
- Check by using other video tape.

SPECIFICATIONS

In the event that the product has been submerged in the water in rainy season:

Immediately wash it with clean water, and dry it in a shadow place, then call for service from the nearest Daewoo Service Center. Never plug the Power Cord since there is risk of electric shock and damage of the product.



DISPLAY UNIT

Model	DP-42GM, DP-42SM, DP-42WM
Diagonal Size	106cm (42")
Screen Aspect Ratio	16 : 9
Display Resolution	853(H) X 480(V) dots
Pixel Pitch	1.08(H) X 1.08(V) mm
Output Color	16,770,000 Colors
Contrast Ratio	3000 : 1
Video Signal	NTSC, PAL, SECAM, PAL-M/N, NTSC4.43
Dimension	40.91(W) X 24.72(H) X 3.15(D) inches.
Weight	66.14Lbs
Power Consumption	320W
Power Requirement	AC 100-240V, 50/60Hz, 3.2-1.3A

* Appearance and specifications of this product are subject to change for improving the product without prior notice.

INPUT/OUTPUT TERMINAL

INPUT/OUTPUT	ITEMS	VIDEO	AUDIO
EXTERNAL INPUT	COMPONENT INPUT	DTV/DVD ONLY (Y, Pb/Cb, Pr/Cr), 2 sets	(LEFT/RIGHT) 2 sets
	VIDEO INPUT	two RCA jacks	(LEFT/RIGHT)
	S-VIDEO INPUT	two 4 pin Mini DIN jack	2 sets
	Computer(PC)	one 15 pin D-sub jack (R, G, B, H, V)	(LEFT/RIGHT) 2 sets
AUDIO OUTPUT	SPEAKER OUTPUT(sold separately)	16W (two 8W)	

Model Name	Front Mask Color
DP-42GM	Dark Gray
DP-42SM	Silver
DP-42WM	White Pearl