

DJ-20 8" Jointer

(Model 37-365X, 37-680 and 37-680X)



PART NO. A06586 - 08-23-04
Copyright © 2004 Delta Machinery



To learn more about DELTA MACHINERY
visit our website at: www.deltamachinery.com.

For Parts, Service, Warranty or other Assistance,

please call **1-800-223-7278** (In Canada call **1-800-463-3582**).

TABLE OF CONTENTS

IMPORTANT SAFETY INSTRUCTIONS2
SAFETY GUIDELINES3
GENERAL SAFETY RULES4
ADDITIONAL SPECIFIC SAFETY RULES5
FUNCTIONAL DESCRIPTION7
CARTON CONTENTS8
ASSEMBLY9-13
OPERATION14-22
TROUBLESHOOTING22
MAINTENANCE22-24
SERVICE27
ACCESSORIES27
WARRANTY27
SERVICE CENTER LOCATIONSback cover

IMPORTANT SAFETY INSTRUCTIONS

▲ WARNING Read and understand all warnings and operating instructions before using any tool or equipment. When using tools or equipment, basic safety precautions should always be followed to reduce the risk of personal injury. Improper operation, maintenance or modification of tools or equipment could result in serious injury and property damage. There are certain applications for which tools and equipment are designed. Delta Machinery strongly recommends that this product NOT be modified and/or used for any application other than for which it was designed.

If you have any questions relative to its application DO NOT use the product until you have written Delta Machinery and we have advised you.

Online contact form at www.deltamachinery.com

Postal Mail: Technical Service Manager
Delta Machinery
4825 Highway 45 North
Jackson, TN 38305

Information regarding the safe and proper operation of this tool is available from the following sources:

Power Tool Institute
1300 Sumner Avenue, Cleveland, OH 44115-2851
www.powertoolinstitute.org

National Safety Council
1121 Spring Lake Drive, Itasca, IL 60143-3201

American National Standards Institute, 25 West 43rd Street, 4 floor, New York, NY 10036 www.ansi.org
ANSI 01.1 Safety Requirements for Woodworking Machines, and

the U.S. Department of Labor regulations www.osha.gov

SAVE THESE INSTRUCTIONS!

SAFETY GUIDELINES - DEFINITIONS

It is important for you to read and understand this manual. The information it contains relates to protecting YOUR SAFETY and PREVENTING PROBLEMS. The symbols below are used to help you recognize this information.

- ▲ DANGER** Indicates an imminently hazardous situation which, if not avoided, will result in death or serious injury.
- ▲ WARNING** Indicates a potentially hazardous situation which, if not avoided, could result in death or serious injury.
- ▲ CAUTION** Indicates a potentially hazardous situation which, if not avoided, may result in minor or moderate injury.
- CAUTION** Used without the safety alert symbol indicates potentially hazardous situation which, if not avoided, may result in property damage.

CALIFORNIA PROPOSITION 65

▲ WARNING **SOME DUST CREATED BY POWER SANDING, SAWING, GRINDING, DRILLING, AND OTHER CONSTRUCTION ACTIVITIES** contains chemicals known to cause cancer, birth defects or other reproductive harm. Some examples of these chemicals are:

- lead from lead-based paints,
- crystalline silica from bricks and cement and other masonry products, and
- arsenic and chromium from chemically-treated lumber.

Your risk from these exposures varies, depending on how often you do this type of work. To reduce your exposure to these chemicals: work in a well ventilated area, and work with approved safety equipment, always wear **MSHA/NIOSH** approved, properly fitting face mask or respirator when using such tools.

GENERAL SAFETY RULES



⚠ WARNING READ AND UNDERSTAND ALL WARNINGS AND OPERATING INSTRUCTIONS BEFORE USING THIS EQUIPMENT. Failure to follow all instructions listed below, may result in electric shock, fire, and/or serious personal injury or property damage.

IMPORTANT SAFETY INSTRUCTIONS

- 1. FOR YOUR OWN SAFETY, READ THE INSTRUCTION MANUAL BEFORE OPERATING THE MACHINE.** Learning the machine's application, limitations, and specific hazards will greatly minimize the possibility of accidents and injury.
- 2. WEAR EYE PROTECTION. ALWAYS USE SAFETY GLASSES.** Also use face or dust mask if cutting operation is dusty. Everyday eyeglasses are NOT safety glasses. **USE CERTIFIED SAFETY EQUIPMENT.** Eye protection equipment should comply with ANSI Z87.1 standards, hearing equipment should comply with ANSI S3.19 standards, and dust mask protection should comply with MSHA/NIOSH certified respirator standards. Splinters, air-borne debris, and dust can cause irritation, injury, and/or illness.
- 3. WEAR PROPER APPAREL.** Do not wear loose clothing, gloves, neckties, rings, bracelets, or other jewelry which may get caught in moving parts. Non-slip footwear is recommended. Wear protective hair covering to contain long hair.
- 4. DO NOT USE THE MACHINE IN A DANGEROUS ENVIRONMENT.** The use of power tools in damp or wet locations or in rain can cause shock or electrocution. Keep your work area well-lit to prevent tripping or placing arms, hands, and fingers in danger.
- 5. MAINTAIN ALL TOOLS AND MACHINES IN PEAK CONDITION.** Keep tools sharp and clean for best and safest performance. Follow instructions for lubricating and changing accessories. Poorly maintained tools and machines can further damage the tool or machine and/or cause injury.
- 6. CHECK FOR DAMAGED PARTS.** Before using the machine, check for any damaged parts. Check for alignment of moving parts, binding of moving parts, breakage of parts, and any other conditions that may affect its operation. A guard or any other part that is damaged **should be properly repaired or replaced.** Damaged parts can cause further damage to the machine and/or injury.
- 7. KEEP THE WORK AREA CLEAN.** Cluttered areas and benches invite accidents.
- 8. KEEP CHILDREN AND VISITORS AWAY.** Your shop is a potentially dangerous environment. Children and visitors can be injured.
- 9. REDUCE THE RISK OF UNINTENTIONAL STARTING.** Make sure that the switch is in the "OFF" position before plugging in the power cord. In the event of a power failure, move the switch to the "OFF" position. An accidental start-up can cause injury.
- 10. USE THE GUARDS.** Check to see that all guards are in place, secured, and working correctly to prevent injury.
- 11. REMOVE ADJUSTING KEYS AND WRENCHES BEFORE STARTING THE MACHINE.** Tools, scrap pieces, and other debris can be thrown at high speed, causing injury.
- 12. USE THE RIGHT MACHINE.** Don't force a machine or an attachment to do a job for which it was not designed. Damage to the machine and/or injury may result.
- 13. USE RECOMMENDED ACCESSORIES.** The use of accessories and attachments not recommended by Delta may cause damage to the machine or injury to the user.
- 14. USE THE PROPER EXTENSION CORD.** Make sure your extension cord is in good condition. When using an extension cord, be sure to use one heavy enough to carry the current your product will draw. An undersized cord will cause a drop in line voltage, resulting in loss of power and overheating. See the Extension Cord Chart for the correct size depending on the cord length and nameplate ampere rating. If in doubt, use the next heavier gauge. The smaller the gauge number, the heavier the cord.
- 15. SECURE THE WORKPIECE.** Use clamps or a vise to hold the workpiece when practical. Loss of control of a workpiece can cause injury.
- 16. FEED THE WORKPIECE AGAINST THE DIRECTION OF THE ROTATION OF THE BLADE, CUTTER, OR ABRASIVE SURFACE.** Feeding it from the other direction will cause the workpiece to be thrown out at high speed.
- 17. DON'T FORCE THE WORKPIECE ON THE MACHINE.** Damage to the machine and/or injury may result.
- 18. DON'T OVERREACH.** Loss of balance can make you fall into a working machine, causing injury.
- 19. NEVER STAND ON THE MACHINE.** Injury could occur if the tool tips, or if you accidentally contact the cutting tool.
- 20. NEVER LEAVE THE MACHINE RUNNING UNATTENDED. TURN THE POWER OFF.** Don't leave the machine until it comes to a complete stop. A child or visitor could be injured.
- 21. TURN THE MACHINE "OFF", AND DISCONNECT THE MACHINE FROM THE POWER SOURCE** before installing or removing accessories, before adjusting or changing set-ups, or when making repairs. An accidental start-up can cause injury.
- 22. MAKE YOUR WORKSHOP CHILDPROOF WITH PADLOCKS, MASTER SWITCHES, OR BY REMOVING STARTER KEYS.** The accidental start-up of a machine by a child or visitor could cause injury.
- 23. STAY ALERT, WATCH WHAT YOU ARE DOING, AND USE COMMON SENSE. DO NOT USE THE MACHINE WHEN YOU ARE TIRED OR UNDER THE INFLUENCE OF DRUGS, ALCOHOL, OR MEDICATION.** A moment of inattention while operating power tools may result in injury.
- 24. THE DUST GENERATED** by certain woods and wood products can be injurious to your health. Always operate machinery in well-ventilated areas, and provide for proper dust removal. Use wood dust collection systems whenever possible.

ADDITIONAL SAFETY RULES FOR JOINTERS

⚠ WARNING FAILURE TO FOLLOW THESE RULES MAY RESULT IN SERIOUS INJURY.

1. **DO NOT OPERATE THIS MACHINE** until it is completely assembled and installed according to the instructions. A machine incorrectly assembled can cause serious injury.
2. **OBTAIN ADVICE** from your supervisor, instructor, or another qualified person if you are not thoroughly familiar with the operation of this machine. Knowledge is safety.
3. **FOLLOW ALL WIRING CODES** and recommended electrical connections to prevent shock or electrocution.
4. **KEEP KNIVES SHARP** and free from rust and pitch. Dull or rusted knives work harder and can cause kickback.
5. **TIGHTEN THE INFEED/OUTFEED TABLES** before starting the machine. Loss of control of the workpiece can cause serious injury.
6. **PROPERLY SECURE THE BLADES IN THE CUTTERHEAD** before turning the power "ON". Loose blades may be thrown out at high speeds.
7. **NEVER TURN THE MACHINE "ON"** before clearing the table of all objects (tools, scraps of wood, etc.). Flying debris can cause serious injury.
8. **NEVER TURN THE MACHINE "ON"** with the workpiece contacting the cutterhead. Kickback can occur.
9. **AVOID AWKWARD OPERATIONS AND HAND POSITIONS.** A sudden slip could cause a hand to move into the cutterhead.
10. **KEEP ARMS, HANDS, AND FINGERS** away from the cutterhead to prevent severe injury.
11. **NEVER MAKE CUTS** deeper than 1/8" (3.2mm) to prevent kickback.
12. **NEVER JOINT OR PLANE A WORKPIECE** that is shorter than 10" (254mm), narrower than 3/4" (19.0MM), or less than 1/2" (12.7mm) thick. Jointing smaller workpieces can place your hand in the cutterhead causing severe injury.
13. **USE HOLD-DOWN/PUSH BLOCKS** for jointing or planing any workpiece lower than the fence. Jointing or planing small workpieces can result in kickback and severe injury.
14. **HOLD THE WORKPIECE FIRMLY** against the table and fence. Loss of control of the workpiece can cause kickback and result in serious injury.
15. **NEVER PERFORM "FREE-HAND" OPERATIONS.** Use the fence to position and guide the workpiece. Loss of control of the workpiece can cause serious injury.
16. **DO NOT** attempt to perform an abnormal or little-used operation without study and the use of adequate hold-down/push blocks, jigs, fixtures, stops, etc.
17. **DO NOT FEED A WORKPIECE** into the outfeed end of the machine. The workpiece will be thrown out of the opposite end at high speeds.
18. **DO NOT FEED A WORKPIECE** that is warped, contains knots, or is embedded with foreign objects (nails, staples, etc.) to prevent kickback.
19. **MAINTAIN THE PROPER RELATIONSHIP OF INFEED AND OUTFEED TABLE SURFACES** and cutterhead knife path. Loss of control of the workpiece can cause serious injury.
20. **PROPERLY SUPPORT LONG OR WIDE WORKPIECES.** Loss of control of the workpiece can cause injury.
21. **NEVER PERFORM LAYOUT, ASSEMBLY, OR SET-UP WORK** on the table/work area when the machine is running. A sudden slip could cause a hand to move into the cutterhead. Severe injury can result.
22. **TURN THE MACHINE "OFF"**, disconnect the machine from the power source, and clean the table/work area before leaving the machine. **LOCK THE SWITCH IN THE "OFF" POSITION** to prevent unauthorized use. Someone else might accidentally start the machine and cause injury to themselves.
23. **ADDITIONAL INFORMATION** regarding the safe and proper operation of power tools (i.e. a safety video) is available from the Power Tool Institute, 1300 Sumner Avenue, Cleveland, OH 44115-2851 (www.powertoolinstitute.com). Information is also available from the National Safety Council, 1121 Spring Lake Drive, Itasca, IL 60143-3201. Please refer to the American National Standards Institute ANSI O1.1 Safety Requirements for Woodworking Machines and the U.S. Department of Labor OSHA 1910.213 Regulations.

SAVE THESE INSTRUCTIONS.
Refer to them often
and use them to instruct others.

POWER CONNECTIONS

A separate electrical circuit should be used for your machines. This circuit should not be less than #12 wire and should be protected with a 20 Amp time lag fuse. If an extension cord is used, use only 3-wire extension cords which have 3-prong grounding type plugs and matching receptacle which will accept the machine's plug. Before connecting the machine to the power line, make sure the switch (s) is in the "OFF" position and be sure that the electric current is of the same characteristics as indicated on the machine. All line connections should make good contact. Running on low voltage will damage the machine.

⚠ DANGER DO NOT EXPOSE THE MACHINE TO RAIN OR OPERATE THE MACHINE IN DAMP LOCATIONS.

MOTOR SPECIFICATIONS

Your machine is wired for 120/240 volt, 60 HZ alternating current. Before connecting the machine to the power source, make sure the switch is in the "OFF" position.

GROUNDING INSTRUCTIONS

⚠ DANGER THIS MACHINE MUST BE GROUNDED WHILE IN USE TO PROTECT THE OPERATOR FROM ELECTRIC SHOCK.

1. All grounded, cord-connected machines:

In the event of a malfunction or breakdown, grounding provides a path of least resistance for electric current to reduce the risk of electric shock. This machine is equipped with an electric cord having an equipment-grounding conductor and a grounding plug. The plug must be plugged into a matching outlet that is properly installed and grounded in accordance with all local codes and ordinances.

Do not modify the plug provided - if it will not fit the outlet, have the proper outlet installed by a qualified electrician.

Improper connection of the equipment-grounding conductor can result in risk of electric shock. The conductor with insulation having an outer surface that is green with or without yellow stripes is the equipment-grounding conductor. If repair or replacement of the electric cord or plug is necessary, do not connect the equipment-grounding conductor to a live terminal.

Check with a qualified electrician or service personnel if the grounding instructions are not completely understood, or if in doubt as to whether the machine is properly grounded.

Use only 3-wire extension cords that have 3-prong grounding type plugs and matching 3-conductor receptacles that accept the machine's plug, as shown in Fig. A.

Repair or replace damaged or worn cord immediately.

2. Grounded, cord-connected machines intended for use on a supply circuit having a nominal rating less than 150 volts:

If the machine is intended for use on a circuit that has an outlet that looks like the one illustrated in Fig. A, the machine will have a grounding plug that looks like the plug illustrated in Fig. A. A temporary adapter, which looks like the adapter illustrated in Fig. B, may be used to connect this plug to a matching 2-conductor receptacle as shown in Fig. B if a properly grounded outlet is not available. The temporary adapter should be used only until a properly grounded outlet can be installed by a qualified electrician. The green-colored rigid ear, lug, and the like, extending from the adapter must be connected to a permanent ground such as a properly grounded outlet box. Whenever the adapter is used, it must be held in place with a metal screw.

NOTE: In Canada, the use of a temporary adapter is not permitted by the Canadian Electric Code.

⚠ DANGER IN ALL CASES, MAKE CERTAIN THE RECEPTACLE IN QUESTION IS PROPERLY GROUNDED. IF YOU ARE NOT SURE HAVE A QUALIFIED ELECTRICIAN CHECK THE RECEPTACLE.

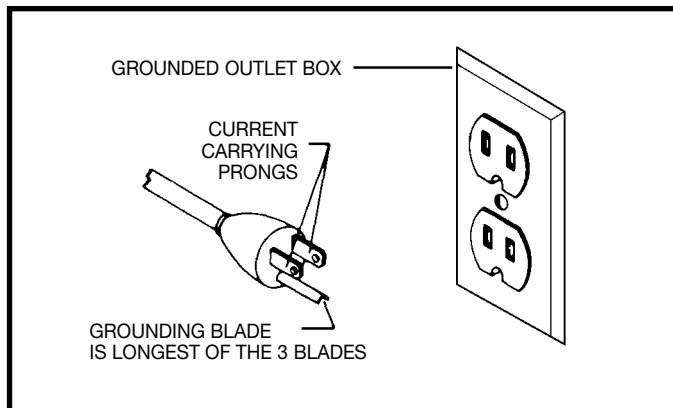

Fig. A

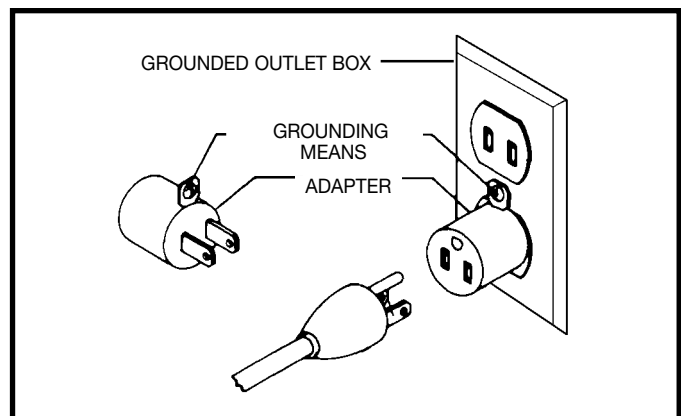

Fig. B

3. Grounded, cord-connected machines intended for use on a supply circuit having a nominal rating between 150 - 250 volts, inclusive:

If the machine is intended for use on a circuit that has an outlet that looks like the one illustrated in Fig. C, the machine will have a grounding plug that looks like the plug illustrated in Fig. C. Make sure the machine is connected to an outlet having the same configuration as the plug. No adapter is available or should be used with this machine. If the machine must be re-connected for use on a different type of electric circuit, the re-connection should be made by qualified service personnel; and after re-connection, the machine should comply with all local codes and ordinances.

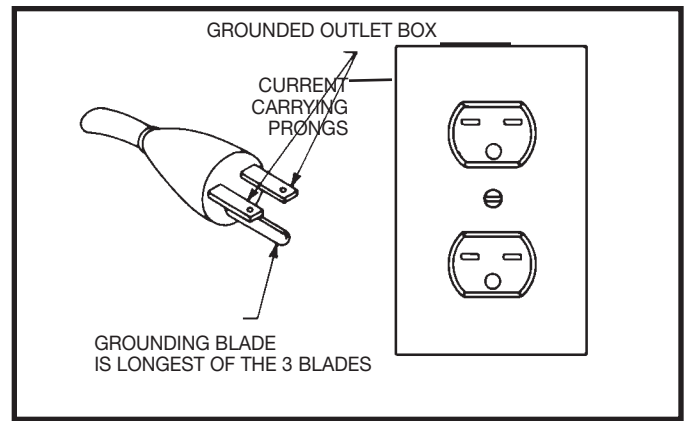

Fig. C

EXTENSION CORDS

⚠ WARNING Use proper extension cords. Make sure your extension cord is in good condition and is a 3-wire extension cord which has a 3-prong grounding type plug and matching receptacle which will accept the machine’s plug. When using an extension cord, be sure to use one heavy enough to carry the current of the machine. An undersized cord will cause a drop in line voltage, resulting in loss of power and overheating. Fig. D-1 or D-2, shows the correct gauge to use depending on the cord length. If in doubt, use the next heavier gauge. The smaller the gauge number, the heavier the cord.

MINIMUM GAUGE EXTENSION CORD			
RECOMMENDED SIZES FOR USE WITH STATIONARY ELECTRIC MACHINES			
Ampere Rating	Volts	Total Length of Cord in Feet	Gauge of Extension Cord
0-6	120	up to 25	18 AWG
0-6	120	25-50	16 AWG
0-6	120	50-100	16 AWG
0-6	120	100-150	14 AWG
6-10	120	up to 25	18 AWG
6-10	120	25-50	16 AWG
6-10	120	50-100	14 AWG
6-10	120	100-150	12 AWG
10-12	120	up to 25	16 AWG
10-12	120	25-50	16 AWG
10-12	120	50-100	14 AWG
10-12	120	100-150	12 AWG
12-16	120	up to 25	14 AWG
12-16	120	25-50	12 AWG
12-16	120	GREATER THAN 50 FEET NOT RECOMMENDED	

Fig. D-1

MINIMUM GAUGE EXTENSION CORD			
RECOMMENDED SIZES FOR USE WITH STATIONARY ELECTRIC MACHINES			
Ampere Rating	Volts	Total Length of Cord in Feet	Gauge of Extension Cord
0-6	240	up to 50	18 AWG
0-6	240	50-100	16 AWG
0-6	240	100-200	16 AWG
0-6	240	200-300	14 AWG
6-10	240	up to 50	18 AWG
6-10	240	50-100	16 AWG
6-10	240	100-200	14 AWG
6-10	240	200-300	12 AWG
10-12	240	up to 50	16 AWG
10-12	240	50-100	16 AWG
10-12	240	100-200	14 AWG
10-12	240	200-300	12 AWG
12-16	240	up to 50	14 AWG
12-16	240	50-100	12 AWG
12-16	240	GREATER THAN 100 FEET NOT RECOMMENDED	

Fig. D-2

FUNCTIONAL DESCRIPTION

FOREWORD

Delta Model 37-365X, 37-680 and 37-680X are 8" precision jointers with a cutting capacity of 8" (203mm) width, 5/8" depth (16mm max.) and 5/8" (16mm) rabbeting. Unit includes; heavy-duty 1-1/2 hp, 120/240 volt motor, fence, three-knife cutterhead, cutterhead guard, and push blocks.

CARTON CONTENTS

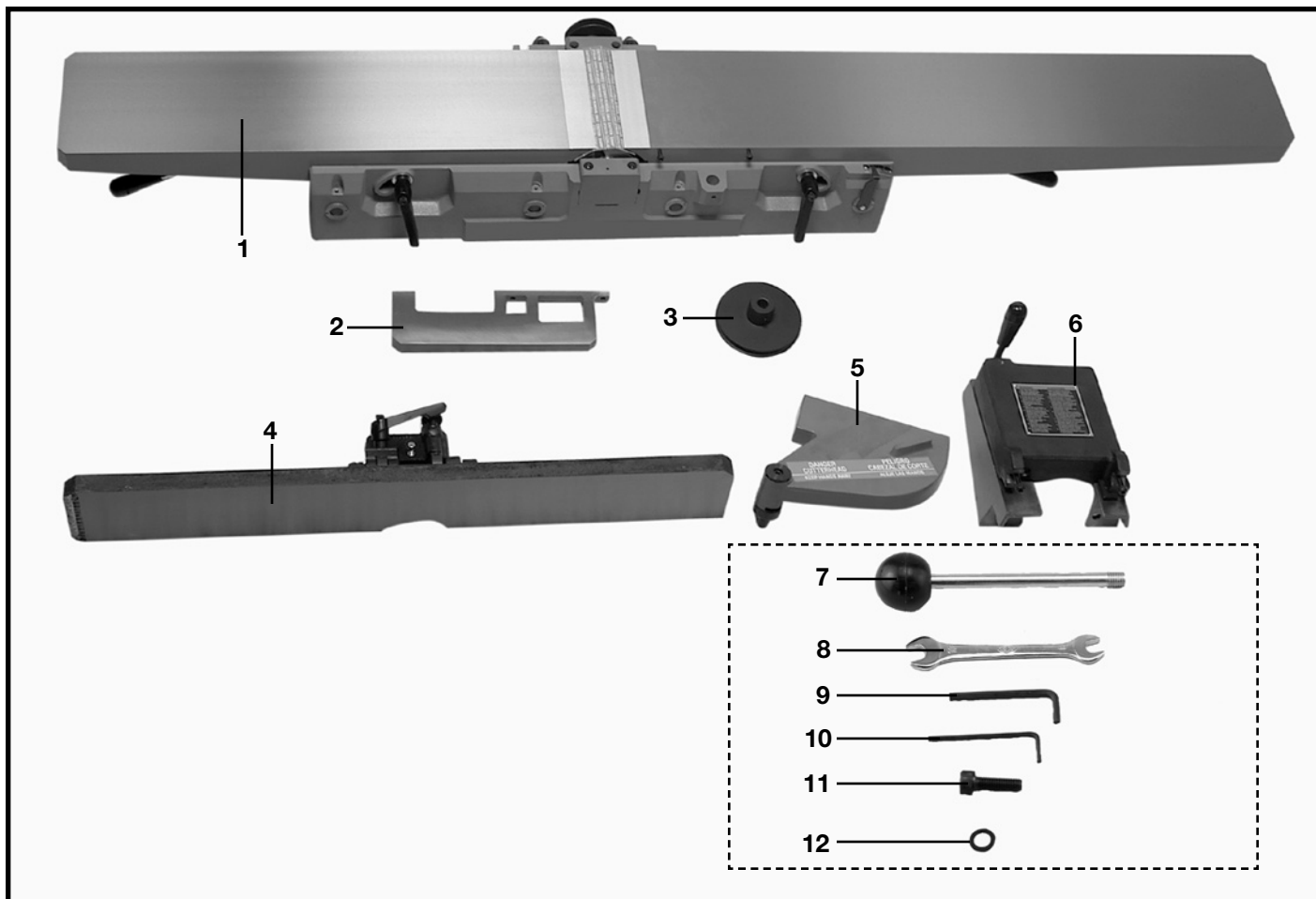

Fig. 2

1. Jointer
2. Rabbeting Ledge
3. Motor Pulley
4. Fence
5. Cutterhead Guard
6. Fence Carriage Assembly
7. Fence Tilting Handle
8. 10x13mm Open End Wrench
9. 4mm Hex Wrench
10. 2.5mm Hex Wrench
11. M8x1.25x25mm Socket Head Screw (8)
12. M8.1 Lockwasher (8)

UNPACKING AND CLEANING

Carefully unpack the machine and all loose items from the shipping container(s). Remove the protective coating from all unpainted surfaces. This coating may be removed with a soft cloth moistened with kerosene (do not use acetone, gasoline or lacquer thinner for this purpose). After cleaning, cover the unpainted surfaces with a good quality household floor paste wax.

NOTICE: THE MANUAL COVER PHOTO ILLUSTRATES THE CURRENT PRODUCTION MODEL. ALL OTHER ILLUSTRATIONS ARE REPRESENTATIVE ONLY AND MAY NOT DEPICT THE ACTUAL COLOR, LABELING OR ACCESSORIES AND MAY BE INTENDED TO ILLUSTRATE TECHNIQUE ONLY.

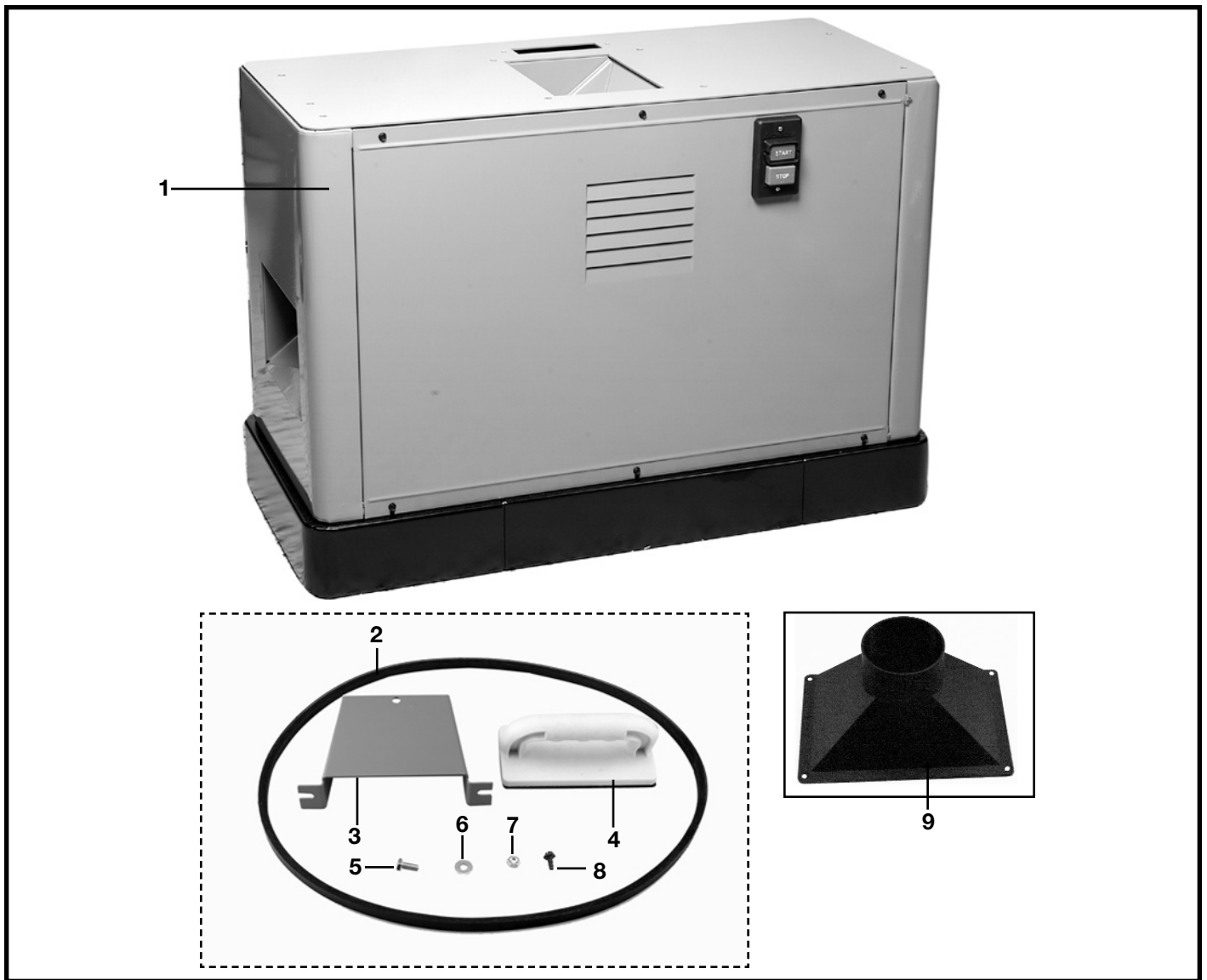

Fig. 3

- | | |
|-----------------------------------|-----------------------------------|
| 1. Stand, Motor, and Electricals | 6. 1/4" Flat Washer (2) |
| 2. Belt | 7. 1/4-20 Hex Nut (2) |
| 3. Cutterhead Pulley/Belt Guard | 8. #10-16x1/2" Hex Head Screw (4) |
| 4. Push Blocks (2) | 9. Dust chute |
| 5. 1/4-20x5/8" Hex Head Screw (2) | |

ASSEMBLY

ASSEMBLY TOOLS REQUIRED

- * 4mm hex head wrench (supplied)
- * 6 and 8 mm hex head wrenches (not supplied)

- * Phillips head screwdriver (not supplied)
- * 12 mm wrench for motor bolts (not supplied)

ASSEMBLY TIME ESTIMATE

Assembly time will take about two hours.

CAUTION THE JOINTER IS EXTREMELY HEAVY. HAVE TWO OR MORE PEOPLE HELP LIFT AND MOVE MACHINE AROUND DURING ASSEMBLY.

JOINTER TO STAND

NOTE: THE MOTOR IS BOLTED TO THE TOP OF THE STAND AND MUST BE ATTACHED TO THE MOTOR MOUNTING BRACKETS.

1. Turn stand upside down as shown in Fig. 4B.
2. Remove the six screws (C) Fig. 4A. Then remove back panel (E) from the stand.
3. Remove the four bolts that attach the motor (A) Fig 4B to the stand. **NOTE: SAVE THESE BOLTS AS THEY WILL BE USED TO ATTACH THE MOTOR TO THE MOUNTING BRACKETS.**
4. Align the holes in the motor mounting plate with the four holes (B) Fig. 4B in the two motor mounting brackets (C). Attach the motor to the motor mounting brackets with the hardware that was removed in STEP 2. **NOTE: MAKE SURE THAT MOTOR SHAFT (D) FIG 4C IS FACING OUT OF THE OPENING IN THE MOTOR CABINET AS SHOWN.**
5. Turn the stand over so that it is resting on its base as shown in Fig. 4C.
6. Line up the eight holes (B) Fig. 5A, on the top of the stand with the eight threaded holes on the bottom of the jointer base (shown in Fig. 5) and fasten the jointer to the stand using the eight M8x1.25x25mm socket head cap screws and M8.1 lockwashers supplied.

NOTE: THE OUTFEED END OF THE JOINTER FIG. 5 MUST BE POINTING TOWARD THE END OF THE STAND WITH DUST CHUTE (D) FIG. 5A.

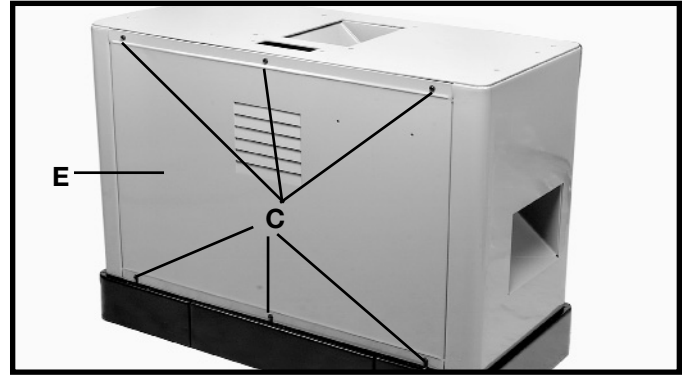

Fig. 4A

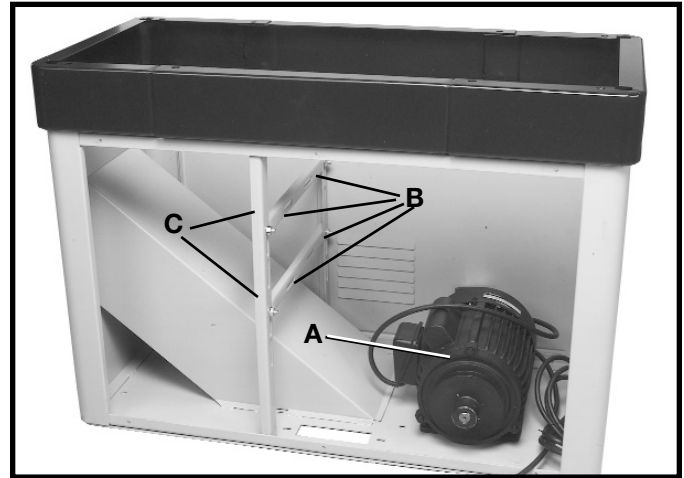

Fig. 4B

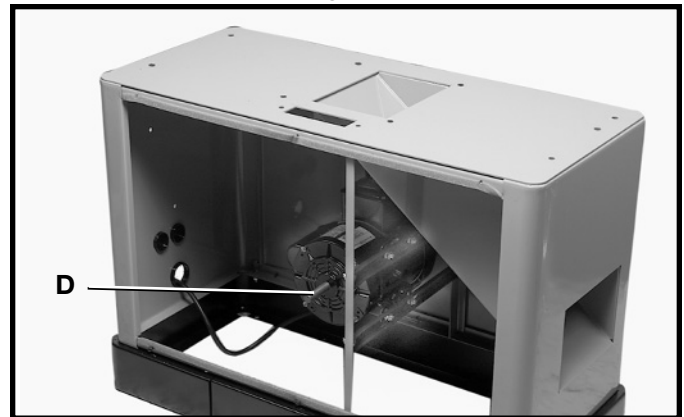

Fig. 4C

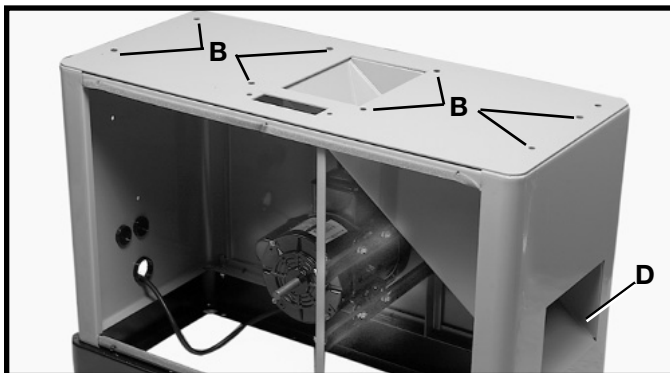

Fig. 5A

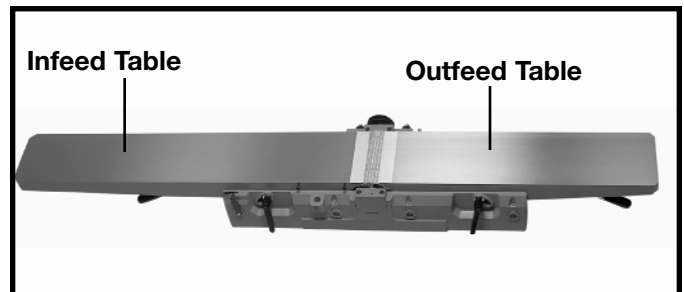

Fig. 5

ASSEMBLING MOTOR PULLEY

Assemble motor pulley (K) Fig. 7A, to motor shaft with the hub of the pulley in the outer position as shown. Make certain key (L) is inserted in the keyway of the pulley and motor shaft, then tighten set screw (M) using the 2.5 mm hex wrench (not shown). **NOTE: THE KEY (P) FIG. 7, FOR THE MOTOR PULLEY, IS TAPED TO THE MOTOR HOUSING.**

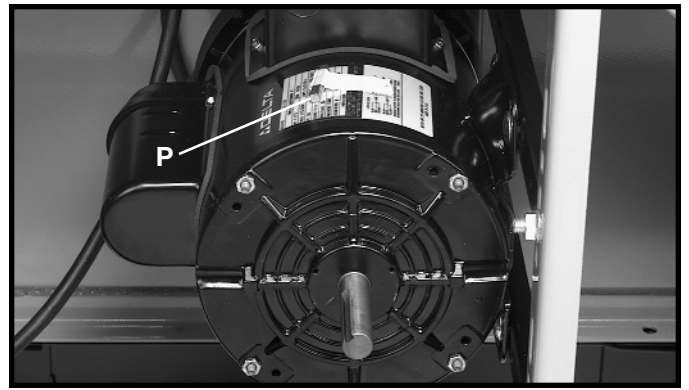

Fig. 7A

ASSEMBLING BELT AND ALIGNING PULLEYS

1. Place belt (A) Fig. 8, in groove of cutterhead pulley (B) and motor pulley (C).
2. Make certain the motor pulley (C) Fig. 8, is properly aligned with cutterhead pulley (B) by placing a straight edge (D) Fig. 8, onto the face of each pulley as shown.
3. If an adjustment is needed, the motor pulley can be moved in or out on the motor shaft, or the motor can be shifted by loosening motor mounting screws, two of which are shown at (E) Fig. 8. After adjustments are made, tighten motor mounting hardware and motor pulley set screw.

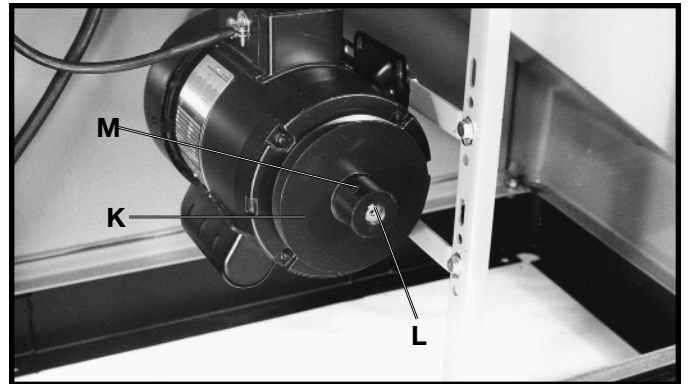

Fig. 7

ADJUSTING BELT TENSION

1. Correct belt tension is obtained when there is approximately 1" deflection at the center span of the belt using light finger pressure.
2. If an adjustment is required, the motor can be raised or lowered to obtain the correct belt tension.
3. Tighten motor mounting hardware after tension is applied, making sure alignment of the pulleys is not disturbed.
4. Re-attach back panel of stand which was removed in **STEP 1** of "JOINTER TO STAND".

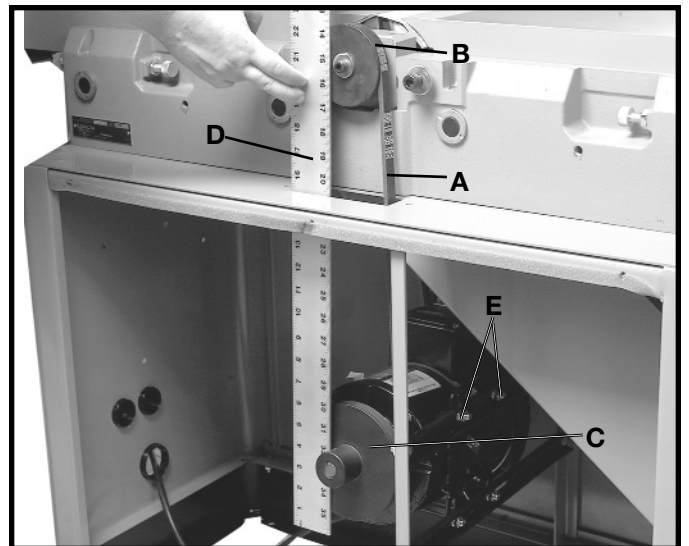

Fig. 8

ASSEMBLING CUTTERHEAD PULLEY/BELT GUARD

1. Align the two holes in the cutterhead pulley/belt guard (A) Fig. 10 with the two holes (B) in the top of the stand.
2. Place a 1/4" flat washer on an 1/4-20x5/8" hex head screw, and insert the screw through the hole in the cutterhead pulley/guard (A) and the hole (B) in the top of the stand. Thread a 1/4-20 hex nut onto the screw and tighten securely. Repeat this process for the remaining hole in the cutterhead pulley/belt guard.

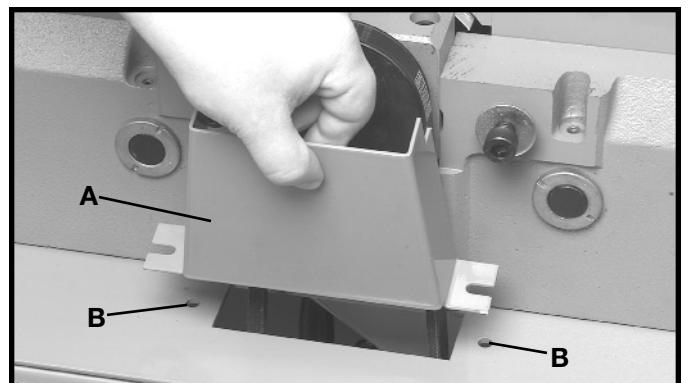

Fig. 10

ASSEMBLING FENCE CARRIAGE ASSEMBLY

1. Remove the two M10x1.5x30mm hex socket head screws (A) Fig. 11, and 10mm flat washers from the back of the jointer base at location (C).
2. Align the two holes (B) Fig. 11, in the fence carriage assembly, with the two tapped holes (C) in the back of the jointer base. Insert the M10x1.5x30mm hex socket head screw with a 10mm flat washer, through the hole in the fence carriage assembly and thread the screw into the tapped hole in the back of the Jointer base. Repeat this process for the remaining hole in the fence carriage assembly and the tapped hole in the back of the Jointer base. **NOTE: THE TOP SURFACE (D) FIG. 12, OF THE FENCE CARRIAGE ASSEMBLY MUST BE LEVEL WITH THE TOP SURFACE (E) OF THE OUTFEED TABLE.** Once the fence carriage assembly is level with the outfeed table, tighten the two screws (A) Fig. 11 securely with an 8mm hex wrench.

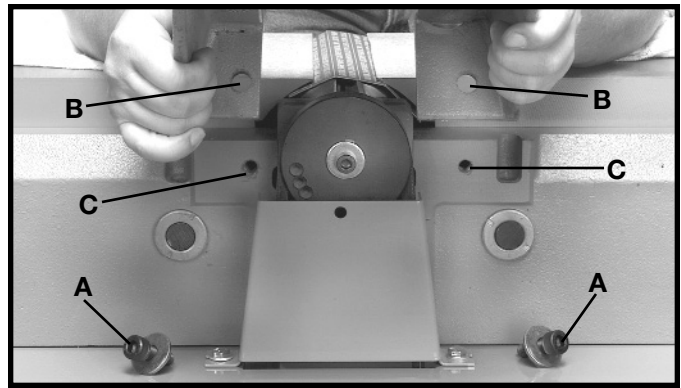

Fig. 11

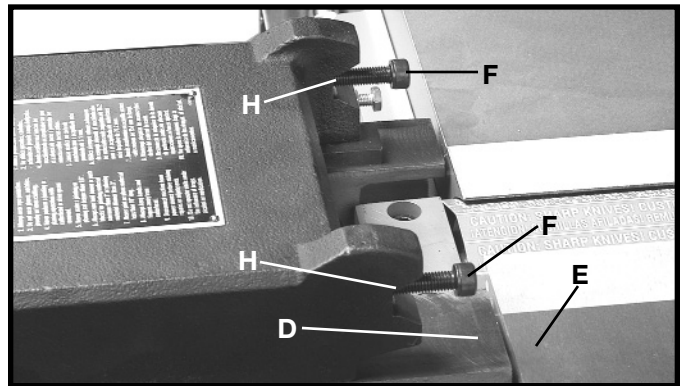

Fig. 12

ASSEMBLING FENCE

1. Remove the two M8x1.25x30mm hex socket head screws (F) Fig. 12.
2. Align the two holes, one of which is shown at (G) Fig. 13, in the fence with the two holes (H) Fig. 12, in the fence carriage assembly. Insert the screw through the hole in the fence and thread the screw into the tapped hole in the fence carriage assembly and tighten securely with a 6mm hex wrench. Repeat this process for the remaining hole in the fence and fence carriage assembly.
3. Thread the fence tilting handle (A) Fig. 14, into the tapped hole (B) in the fence.

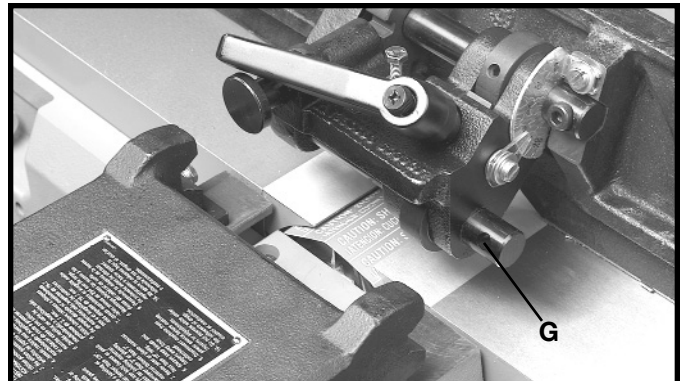

Fig. 13

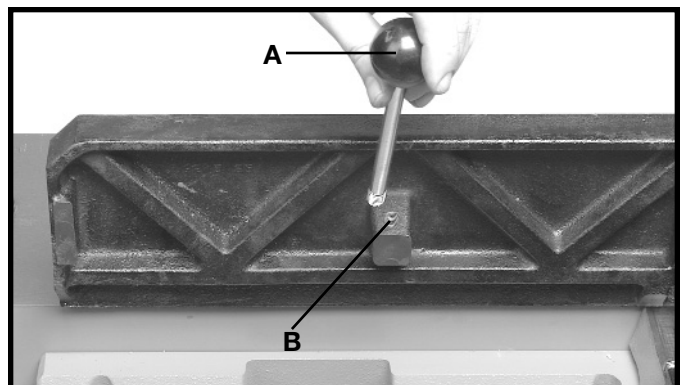

Fig. 14

ASSEMBLING RABBETING LEDGE

1. Remove the two M6x1x20mm socket head screws (C) Fig. 15 from hole location (B) in the front of the Jointer.
2. Align the two holes (A) Fig. 15, in the rabbeting ledge, with the two holes (B) in the front of the Jointer. Insert the screw through the hole (A) in the rabbeting ledge and thread the screw into the tapped hole (B) in the front of the Jointer. Make sure the rabbeting ledge is level with the infeed table. Tighten screw (C) securely. Repeat this process for the remaining hole in the rabbeting ledge and the front of the Jointer.

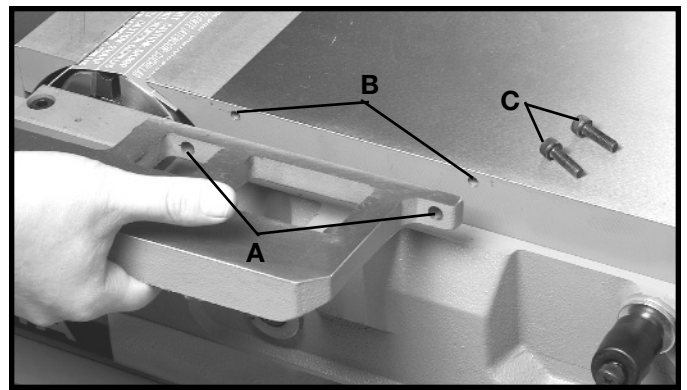

Fig. 15

ASSEMBLING CUTTERHEAD GUARD

Loosen set screw (A) Fig. 16. Insert post (B) of the cutterhead guard into hole in infeed table and tighten set screw (A) against the flat on post (B).

⚠ CAUTION MAKE CERTAIN THAT GUARD OPERATES FREELY AND DOES NOT BIND OR HANG-UP. ALWAYS CHECK GUARD OPERATION BEFORE TURNING ON JOINTER.

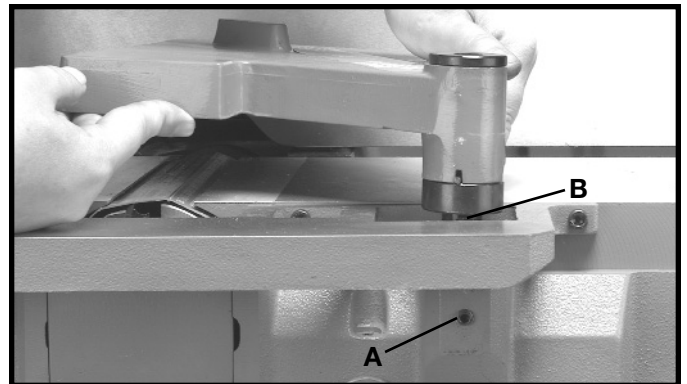

Fig. 16

ASSEMBLING DUST CHUTE

The jointer stand has a built-in dust chute (A) Fig. 16A. If this machine is to be used with a dust collection system, the supplied dust collector connector (B) Fig. 16A, can be fastened to jointer stand (C) with four #10-16x1/2" hex head screws (not shown).

A standard 4" dust collection hose can be attached to dust collector connector.

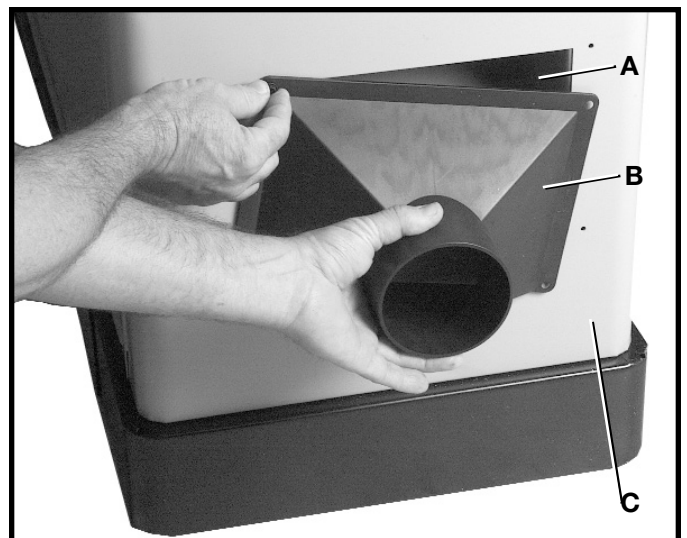

Fig. 16A

OPERATION

OPERATIONAL CONTROLS AND ADJUSTMENTS

STARTING AND STOPPING JOINTER

To turn the machine **“ON”**, push the green start button (A) Fig. 17. To turn the machine **“OFF”**, push the red stop button (B).

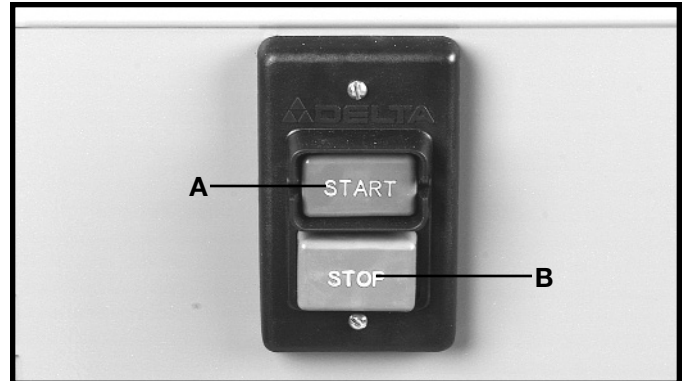

Fig. 17

LOCKING SWITCH IN THE “OFF” POSITION

IMPORTANT: When the tool is not in use, the switch should be locked in the **“OFF”** position to prevent unauthorized use, using a padlock (C) Fig. 18 with a 3/16" diameter shackle.

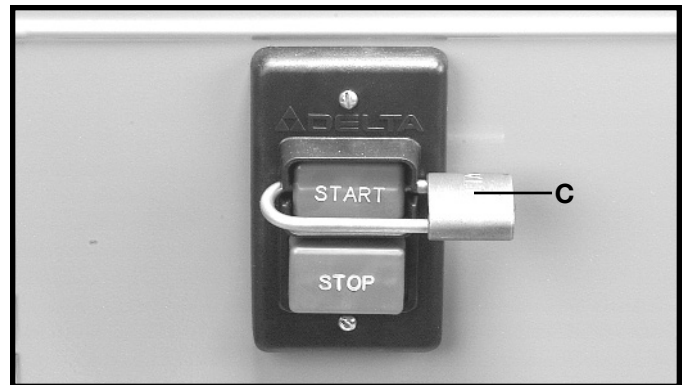

Fig. 18

INFEED TABLE ADJUSTMENTS

To raise or lower the infeed table (see Fig. 4A), loosen table lock handle (A) Fig. 19, and move the table raising and lowering hand lever (B) up or down until the table is at the desired position and tighten table lock handle (A). **NOTE:** The table lock handle (A) can be repositioned by pulling out the handle and repositioning it on the serrated nut located underneath the handle.

The depth of cut of the infeed table (position of table in relationship with the cutting circle) can be read with the pointer and scale (G) Fig. 19.

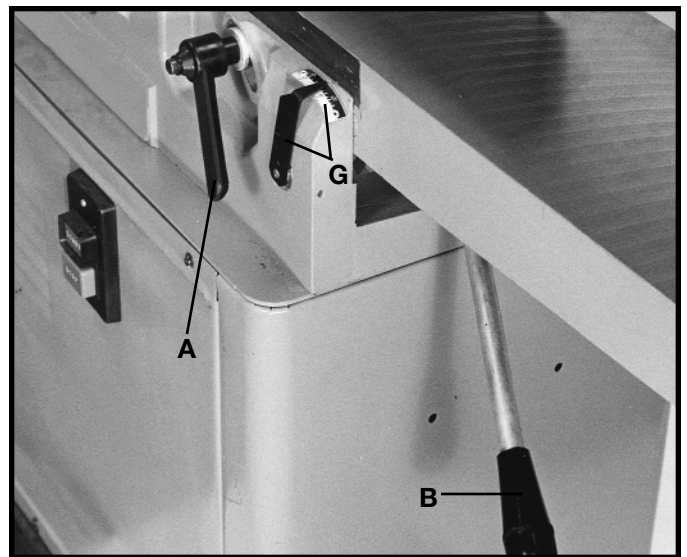

Fig. 19

INFEED TABLE POSITIVE STOPS

⚠ WARNING DISCONNECT MACHINE FROM POWER SOURCE.

Positive stops are provided to limit the height of the infeed table. The positive stops can be set by loosening lock nuts (C) and (D) Fig. 20, and turning the two adjusting screws (E) and (F). We recommend that the height of the infeed table be adjusted so that the table, at its highest point, will be 1/2mm (.020") below the highest point of the knives. This is an important feature of your jointer which enables you to rapidly position the infeed table for a finish or final cut.

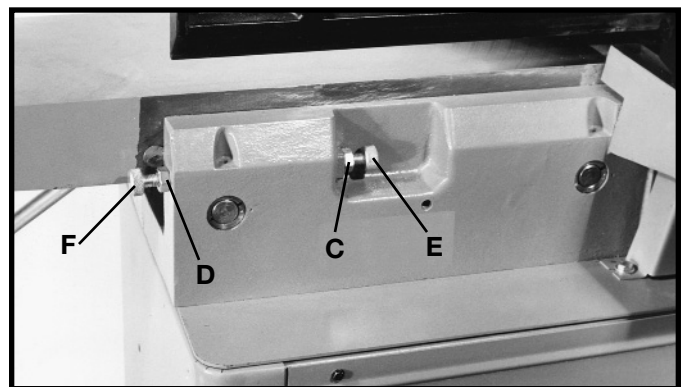

Fig. 20

OUTFEED TABLE ADJUSTMENTS

⚠ WARNING DISCONNECT MACHINE FROM POWER SOURCE.

The outfeed table must be exactly level with the knives when the knives are at their highest point of revolution. To move the outfeed table, loosen table lock handle (A) Fig. 21, and move the table raising and lowering hand lever (B) up or down until the table is level with the knives. It may be necessary to loosen the two locknuts (C) and (D) Fig. 22, and the two adjusting screws (E) and (F) when moving the table up or down. When the outfeed table is exactly level with the knives at their highest point of revolution, tighten table lock handle (A) Fig. 21, and turn adjusting screw (E) Fig. 22, until it bottoms. Then tighten lock nut (C). Screw (F) is also a positive stop for the lower limit of the outfeed table. We suggest that this stop also be tightened with locknut (D), when the outfeed table is set level with the knives. This will prevent the outfeed table from accidentally being lowered.

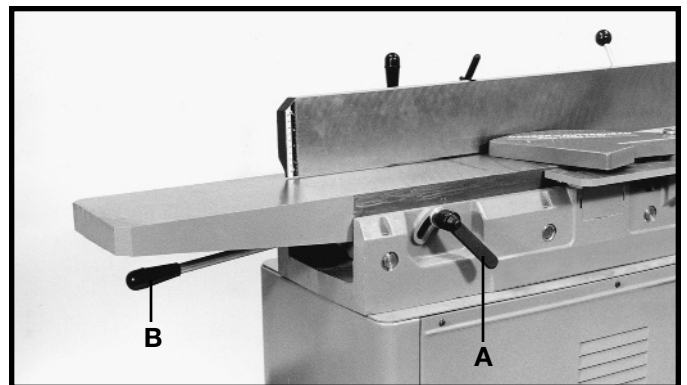

Fig. 21

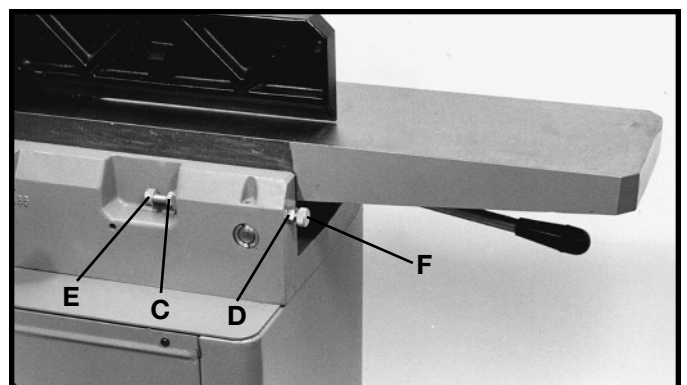

Fig. 22

KNIFE ADJUSTMENTS

In order to do accurate work, the knives must be exactly level with the outfeed table. To check and adjust, proceed as follows:

⚠ WARNING DISCONNECT MACHINE FROM POWER SOURCE.

1. Loosen infeed table lock lever and lower infeed table as described under section "INFEED TABLE ADJUSTMENTS".
2. Remove cutterhead guard (C) Fig. 23.
3. Place a steel straight edge on the outfeed table, extending over the cutterhead as shown in Fig. 24.
4. Carefully rotate the cutterhead by hand. The knives should just touch the straight edge.
5. If the knife is high or low at either end, slightly turn the four screws (D) Fig. 25, in the knife locking bar clockwise to loosen using the wrench (E) supplied. Then adjust the height of the knife by turning the knife raising screws (F) Fig. 26, counterclockwise to lower and clockwise to raise the knife.

⚠ WARNING CARE MUST BE TAKEN WHEN HANDLING THE KNIVES, AS THE CUTTING EDGES ARE VERY SHARP. WEAR PROTECTIVE GLOVES WHEN HANDLING THE KNIVES.

If the knife is to be lowered it will be necessary to carefully push down on the knife with a scrap piece of wood, after screws (F) have been turned counterclockwise to achieve desired depth. Tighten four screws (D) Fig. 25, by turning them counterclockwise, after adjustment is made.

6. Repeat these procedures for adjusting the remaining two knives if necessary, and replace cutterhead guard removed in **STEP 2**.
7. If the knives are set too low, the result will be as shown in Fig. 27, and the finished surface will be curved.
8. If the knives are set too high, the work will be gouged, curved, or bowed at the end of the cut, as shown in Fig. 28.
9. As a final check, run a piece of work slowly over the knives for 6 to 8 inches. The wood should rest firmly on both tables as shown in Fig. 29, with no open spaces under the finished cut.

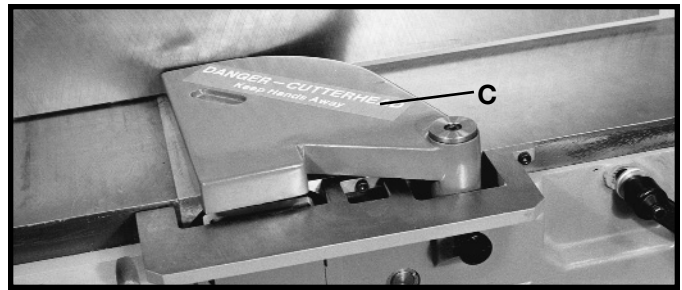

Fig. 23

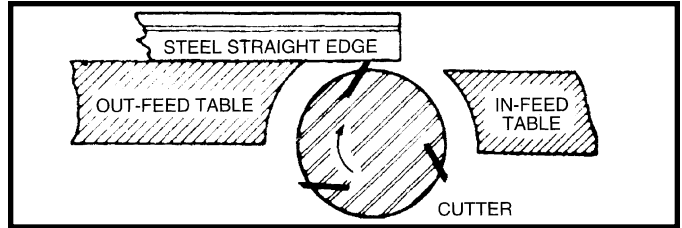

Fig. 24

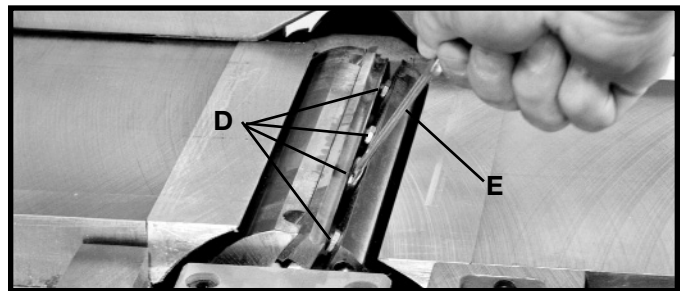

Fig. 25

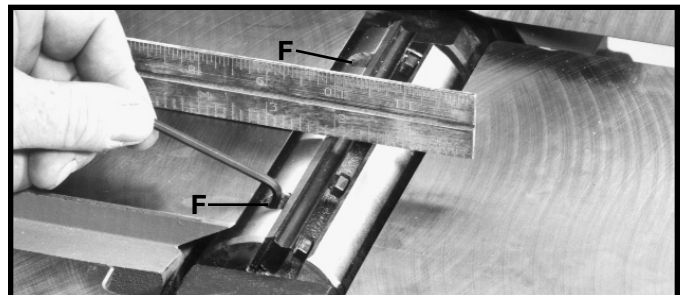

Fig. 26

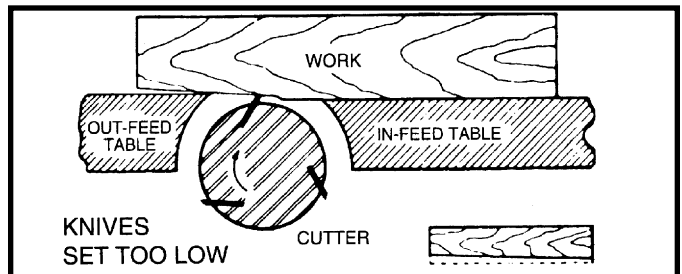

Fig. 27

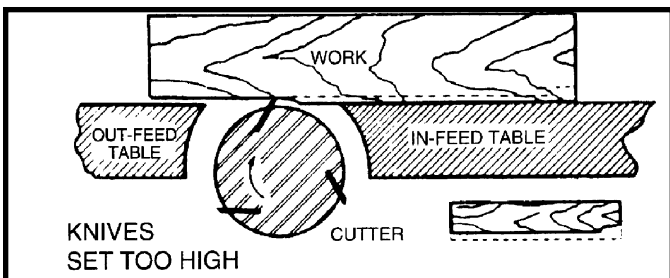

Fig. 28

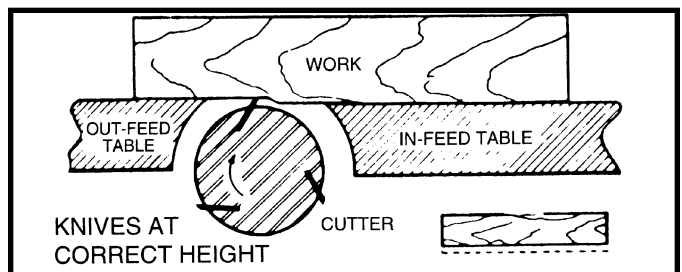

Fig. 29

FENCE OPERATION

The fence can be moved across the table by loosening lock lever (A) Fig. 30, move the fence to the desired position, and tighten lock lever (A) securely. As the fence is moved across the table, the sliding portion of the fence bracket (F) guards the cutterhead in back of the fence as shown.

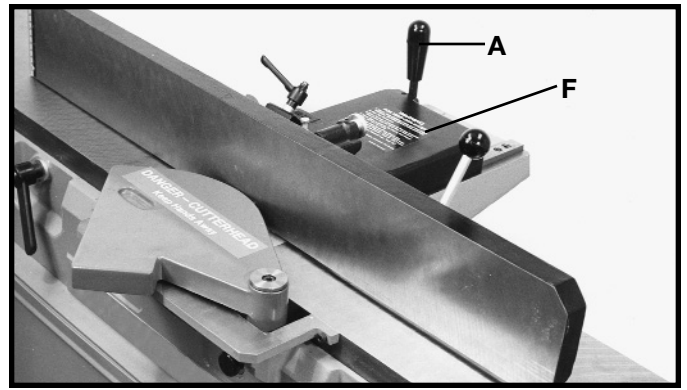

Fig. 30

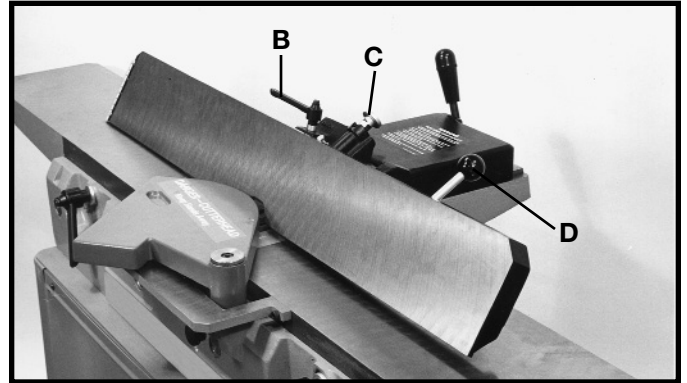

Fig. 31

To tilt the fence to the right or left, loosen handle (B) Fig. 31, pull out plunger (C) and using the fence tilting lever (D), move the fence to the desired angle and tighten handle (B) securely. **NOTE:** The handle (B) Fig. 31, is spring-loaded and can be repositioned by pulling out the handle and repositioning it on the serrated nut located underneath the handle. **IMPORTANT:** When cutting a bevel, we suggest that whenever possible the fence be tilted toward the table, as shown in Fig. 32. The fence will then form a V-shape with the tables, and the work is easily pressed into the pocket while passing it across the knives.

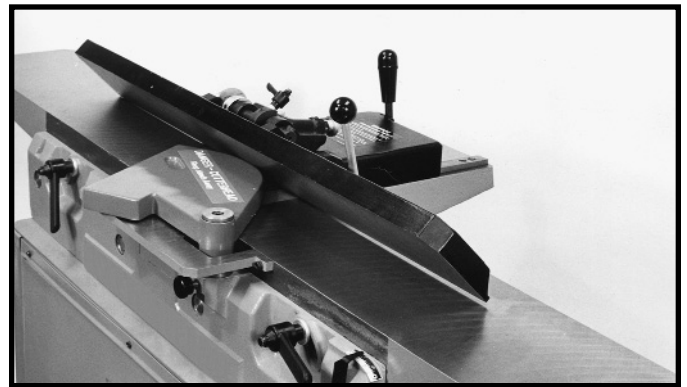

Fig. 32

ADJUSTING FENCE POSITIVE STOPS

The fence on your jointer is equipped with positive stops at the most used fence positions of 90 degrees and 45 degrees right and left. To check and adjust the positive stops, proceed as follows:

⚠ WARNING **DISCONNECT MACHINE FROM POWER SOURCE.**

1. Position the fence 90 degrees to the table by making sure end of plunger (A) Fig. 33, is engaged in notch in index collar (B), as shown, and tighten lockhandle (C).

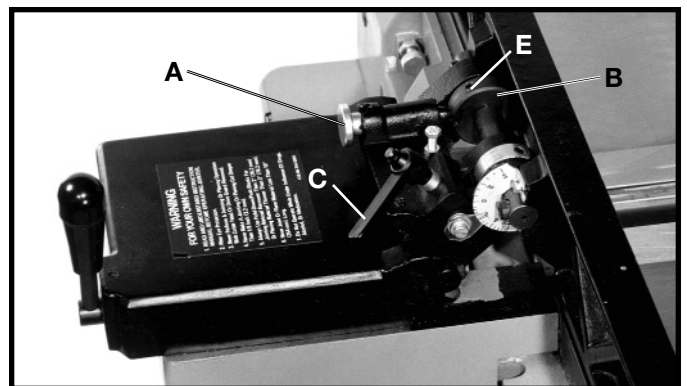

Fig. 33

2. Using a square (D) Fig. 34, check to see if the fence is at 90 degrees to the table, as shown.
3. If the fence is not at 90 degrees to the table, loosen set screw (E) in the index collar (B), Fig. 33, and loosen the fence locking handle (C). Move the fence until you are certain it is at 90 degrees to the table and tighten locking handle (C) and set screw (E).

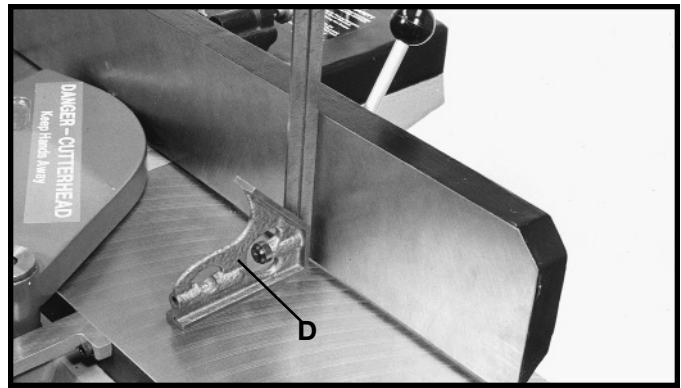

Fig. 34

4. Tilt the fence inward as far as possible and using a combination square (F) Fig. 35, check to see if the fence is tilted inward 45 degrees, as shown. If an adjustment is necessary, loosen locknut (H) Fig. 36, and turn adjusting screw (J) in or out until the fence is 45 degrees to the table, and tighten locknut (H). Then tighten lock handle (C).

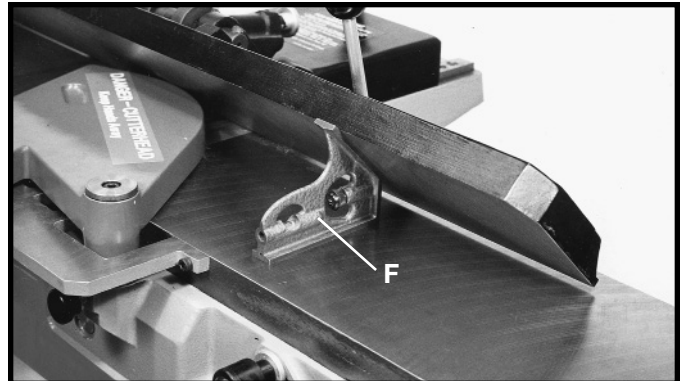

Fig. 35



Fig. 36

5. Tilt the fence outward as far as possible and using a combination square (K) Fig. 37, check to see if the fence is tilted outward 45 degrees, as shown. If an adjustment is necessary, loosen lock handle (C) Fig. 37. Loosen locknut (L) and turn adjusting screw (M) until the fence is at 45 degrees to the table. Then tighten locknut (L) and lock handle (C).

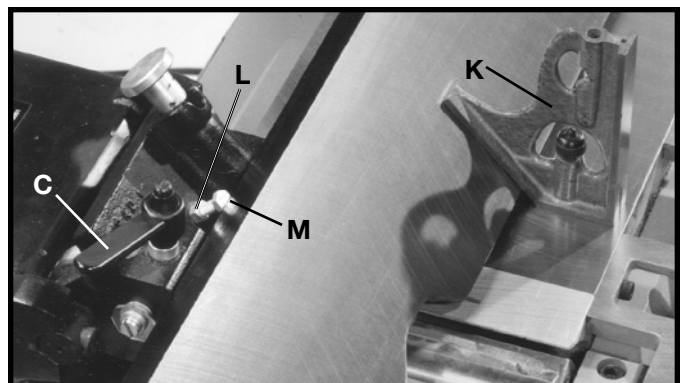

Fig. 37

CUTTERHEAD ROTATION

⚠ WARNING The rotation of the cutterhead must be in a clockwise direction when viewed from the left side of the machine; that is, the knives must be rotating toward the infeed table from the top. If the cutterhead rotation is incorrect, disconnect the machine from the power source and proceed as follows:

Single Phase Machines – Interchange leads T5 and T8 in the motor junction box.

Three Phase Machines – Interchange any two of the three incoming power lines.

The following directions will give the beginner a start on jointer operations. Use scrap pieces of lumber to check settings and to get the feel of the operations before attempting regular work.

CAUTION THE KNIVES ON THE JOINTER WILL NOT WEAR EVENLY BY FEEDING THE WOOD THROUGH THE SAME SPOT ON THE TABLE EVERY TIME. FEED THE WOOD THROUGH THE JOINTER AT DIFFERENT SPOTS ON THE TABLE WHEN POSSIBLE, TO HELP ELIMINATE UNEVEN WEAR OF THE KNIVES.

⚠ WARNING ALWAYS USE CUTTERHEAD GUARD AND KEEP HANDS AWAY FROM CUTTERHEAD. ALWAYS USE PUSH BLOCKS WHENEVER POSSIBLE. NEVER MAKE JOINTING AND PLANING CUTS DEEPER THAN 1/8" IN ONE PASS.

MACHINE USE

PLACEMENT OF HANDS DURING FEEDING

At the start of the cut, the left hand holds the work firmly against the infeed table and fence, while the right hand pushes the work toward the knives. After the cut is underway, the new surface rests firmly on the outfeed table as shown in Fig. 38. The left hand should then be moved to the work on the outfeed table, at the same time maintaining flat contact with the fence. The right hand presses the work forward, and before the right hand reaches the cutterhead, it should be moved to the work on the outfeed table.

⚠ WARNING NEVER PASS HANDS DIRECTLY OVER THE CUTTERHEAD.

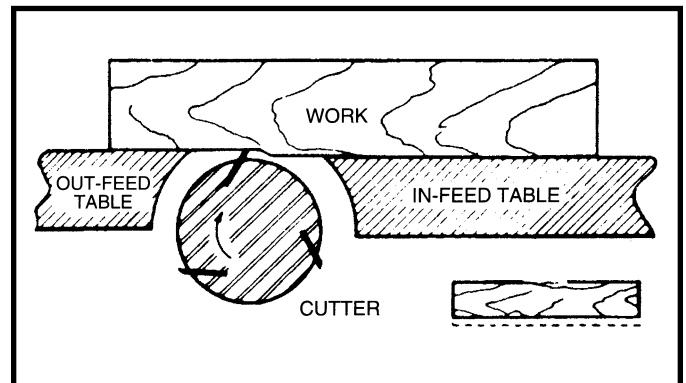

Fig. 38

JOINTING AN EDGE

This is the most common operation for the jointer, these cuts are made to square an edge of a workpiece. Set the guide fence square with the table. Depth of cut should be the minimum required to obtain a straight edge. Hold the best face of the piece firmly against the fence throughout the feed as shown in Fig. 39.

CAUTION MAXIMUM DEPTH OF CUT SHOULD NOT BE MORE THAN 1/8" IN ONE PASS.

CAUTION DO NOT PERFORM JOINTING OPERATIONS ON MATERIAL SHORTER THAN 10 INCHES, NARROWER THAN 3/4 INCH, OR LESS THAN 1/2 INCH THICK (REFER TO FIG. 40).



Fig. 39

SURFACING

Surfacing is identical to the jointing operation except for the position of the workpiece. For surfacing, the major flat surface of the workpiece is placed on the infeed table of the jointer with the narrow edge of the workpiece against the fence, as shown in Fig. 41. The workpiece is moved from the infeed table, across the cutterhead to the outfeed table establishing a flat surface on the workpiece.

WARNING ALWAYS USE PUSH BLOCKS WHEN PERFORMING SURFACING OPERATIONS AND NEVER PASS YOUR HANDS DIRECTLY OVER THE CUTTERHEAD.

CAUTION MAXIMUM DEPTH OF CUT SHOULD NOT BE MORE THAN 1/8" IN ONE PASS.

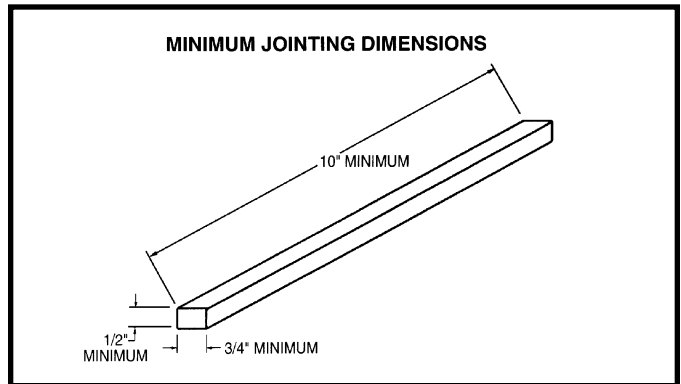

Fig. 40

BEVELING

To cut a bevel, lock the fence at the required angle and run the work across the knives while keeping the work firmly against the fence and tables. Several passes may be necessary to arrive at the desired result. When the angle is small, there is little difference whether the fence is tilted to the right or left. However, at greater angles approaching 45 degrees, it is increasingly difficult to hold the work properly when the fence is tilted to the right. The advantage of the double-tilting fence is appreciated under such conditions. When tilted to the left, the fence forms a V-shape with the tables, as shown in Fig. 42, and the work is easily pressed into the pocket while passing it across the knives. If the bevel is laid out on the piece in such direction that this involves cutting against the grain, it will be better to tilt the fence to the right.

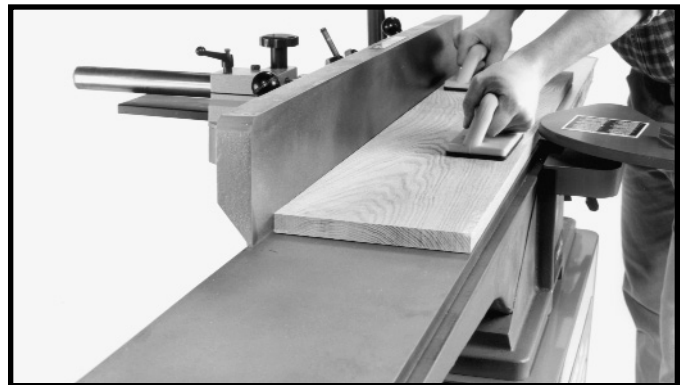

Fig. 41



Fig. 42

TAPER CUTS

One of the most useful jointer operations is cutting an edge to a taper. This method can be used on a wide variety of work. Tapered legs of furniture are a common example. Instead of laying the piece on the infeed table, lower the forward end of the work onto the outfeed table. Do this very carefully, as the piece will span the knives, and they will take a "bite" from the work with a tendency to kick back unless the piece is firmly held. Now push the work forward as in ordinary jointing. The effect is to surface off all the stock in front of the knives, to increasing depth, leaving a tapered surface. The ridge left by the knives when starting the taper may be removed by taking a very light cut according to the regular method for jointing, with the infeed table raised to its usual position. Practice is required in this operation, and the beginner is advised to make trial cuts on waste material. Taper cuts over part of the length and a number of other special operations can easily be done by the experienced craftsman.

CUTTING A RABBET

When making a rabbet cut, as shown in Fig. 43, the cutter-head guard must be removed.

⚠ CAUTION AFTER THE RABBET CUT IS COMPLETED, BE CERTAIN GUARD IS REPLACED.

1. Adjust the fence so that the distance between the end of the knives and the fence is equal to the width of the rabbet.
2. Lower the infeed table an amount equal to the depth of the rabbet. If the rabbet is quite deep, it may be necessary to cut it in two or more passes. In that event, the table is lowered an amount equal to about half the depth of the rabbet for the first pass, then lowered again to proper depth to complete the cut.



Fig. 43

SURFACING WARPED PIECES

If the wood to be surfaced is dished or warped, take light cuts until the surface is flat. Avoid forcing such material down against the table; excessive pressure will spring it while passing the knives, and it will spring back and remain curved after the cut is completed.



Fig. 44

SURFACING SHORT OR THIN WORK

⚠ CAUTION WHEN SURFACING SHORT OR THIN PIECES, ALWAYS USE PUSH BLOCKS TO MINIMIZE ALL DANGER TO THE HANDS. Fig. 44, illustrates using the Delta Push Blocks properly.

⚠ CAUTION DO NOT PERFORM SURFACING OPERATIONS ON MATERIAL SHORTER THAN 10 INCHES, NARROWER THAN 3/4 INCH, WIDER THAN 8 INCHES, OR LESS THAN 1/2 INCH THICK (REFER TO FIG. 45).

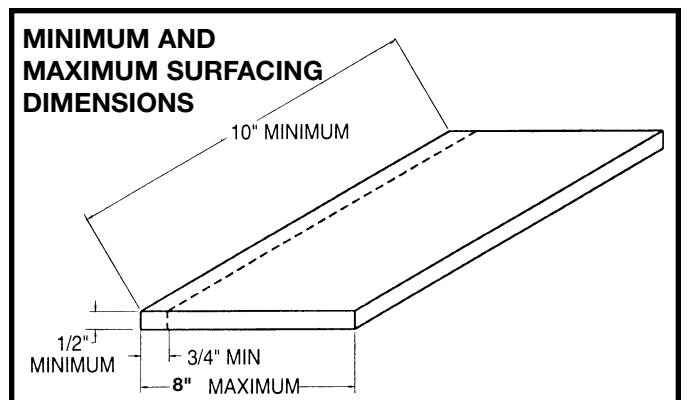

Fig. 45

DIRECTION OF GRAIN

Avoid feeding work into the jointer against the grain as shown in Fig. 46. The result will be chipped and splintered edges. Feed with the grain as shown in Fig. 47, to obtain a smooth surface.

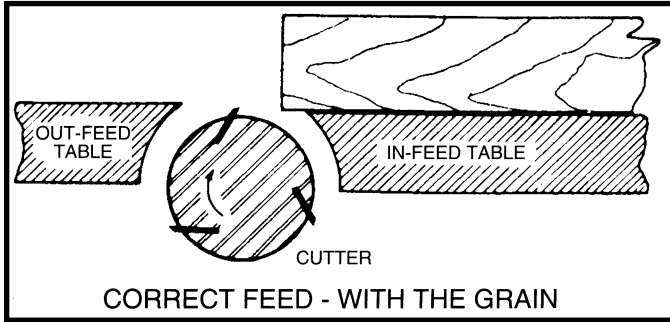

Fig. 47

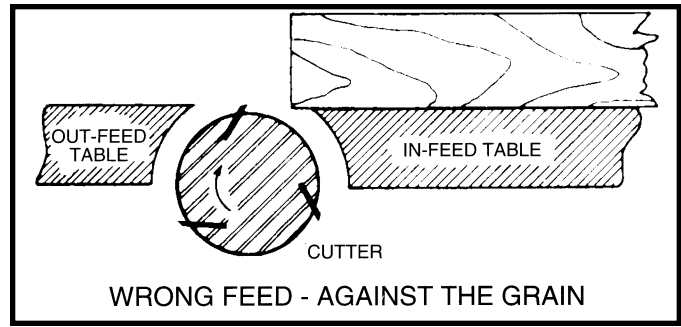

Fig. 46

TROUBLESHOOTING

For assistance with your tool, visit our website at www.deltamachinery.com for a list of service centers or call the DELTA Machinery help line at 1-800-223-7278 (In Canada call 1-800-463-3582).

MAINTENANCE

KEEP MACHINE CLEAN

Periodically blow out all air passages with dry compressed air. All plastic parts should be cleaned with a soft damp cloth. NEVER use solvents to clean plastic parts. They could possibly dissolve or otherwise damage the material.

▲WARNING Wear ANSI Z87.1 safety glasses while using compressed air.

FAILURE TO START

Should your machine fail to start, check to make sure the prongs on the cord plug are making good contact in the outlet. Also, check for blown fuses or open circuit breakers in the line.

LUBRICATION

Apply household floor paste wax to the machine table and extension table or other work surface weekly.

PROTECTING CAST IRON FROM RUST

To clean and protect cast iron tables from rust, you will need the following materials: 1 pushblock from a jointer, 1 sheet of medium Scotch-Brite™ Blending Hand Pad, 1 can of WD-40®, 1 can of degreaser, 1 can of TopCote® Aerosol. Apply the WD-40 and polish the table surface with the Scotch-Brite pad using the pushblock as a holddown. Degrease the table, then apply the TopCote® accordingly.

After considerable use, the knives will become dull and it will not be possible to do accurate work. Unless badly damaged by running into metal or other hard material, the knives may be sharpened as follows:

WHETTING KNIVES

▲WARNING DISCONNECT MACHINE FROM POWER SOURCE.

Use a fine carborundum stone, cover it partly with paper as indicated in Fig. 48 to avoid marking the table. Lay the stone on the infeed table, lower the table and turn the cutterhead forward until the stone lies flat on the bevel of the knife as shown. Hold the cutterhead from turning, and whet the beveled edge of the knife, stroking lengthwise by sliding the stone back and forth across the table. Do the same amount of whetting on each of the three knives.

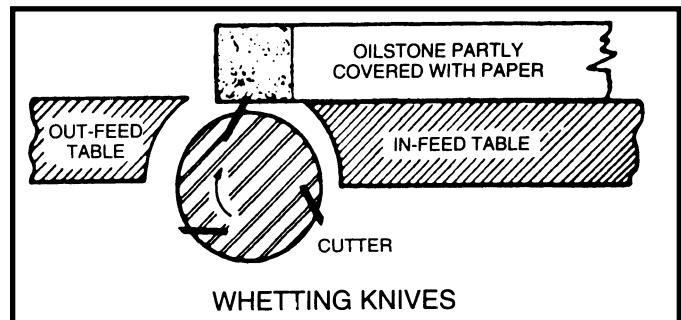

Fig. 48

REMOVING, REPLACING, AND RESETTING KNIVES

If the knives are removed from the cutterhead for replacement or sharpening, care must be used in removing, replacing, and resetting them.

⚠ WARNING **DISCONNECT MACHINE FROM POWER SOURCE.**

1. Move the fence to the rear and remove the cutterhead guard.

⚠ WARNING **BE EXTREMELY CAREFUL THAT YOUR HANDS DO NOT COME IN CONTACT WITH THE KNIVES. THE KNIVES ARE VERY SHARP. WEAR PROTECTIVE GLOVES WHEN HANDLING THE KNIVES.**

2. Using wrench (A) Fig. 49, slightly loosen the four locking screws (B) in each knife slot by turning the screws (B) clockwise. Loosen screws (B) Fig. 49, further and remove knife and knife locking bar.
3. Fig. 50, shows the knife (C) and knife locking bar (D) removed from the cutterhead. Remove the remaining two knives and locking bars, in the same manner.
4. Using wrench (E) Fig. 50, lower the two knife adjustment blocks to the bottom of the cutterhead by turning screws (F) counterclockwise in all three slots of the cutterhead.
5. Before assembling knives make certain the knives and locking bars are thoroughly clean and free of gum and pitch.
6. Place the knife locking bars (D) Fig. 50, and knives (C) into each slot in the cutterhead.

⚠ WARNING **CARE MUST BE TAKEN WHEN INSERTING THE KNIVES AS THE CUTTING EDGES ARE VERY SHARP. WEAR PROTECTIVE GLOVES WHEN HANDLING THE KNIVES.**

7. Push the knife down as far as possible and turn each screw (B) Fig. 49, counterclockwise just enough to hold the knife in position. Replace the remaining two knives in the same manner.

⚠ WARNING **KNIVES MUST BE INSTALLED CORRECTLY AS SHOWN IN FIG. 51.**

8. The knives are adjusted correctly when the cutting edge of the knife extends out .015" from the cutterhead diameter.
9. Carefully rotate the cutterhead (G) Fig. 52, until the round portion of the cutterhead is on top as shown.
10. Place a .015" feeler gage (H) Fig. 52, on the cutterhead and using a straight edge (J) on the rear table adjust the height of the rear table until it is .015" above the cuttinghead diameter, as shown.
11. Lock the rear table in position and remove the feeler gage.

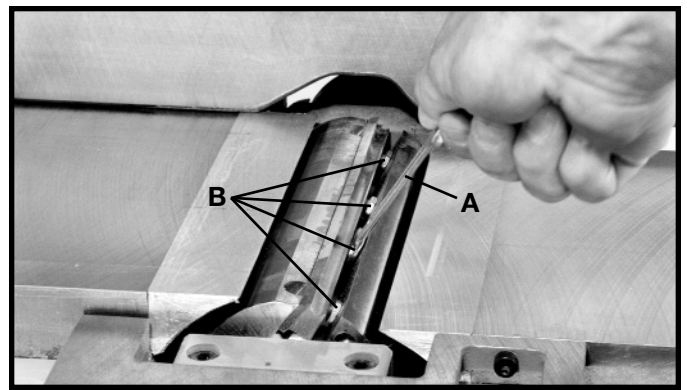

Fig. 49

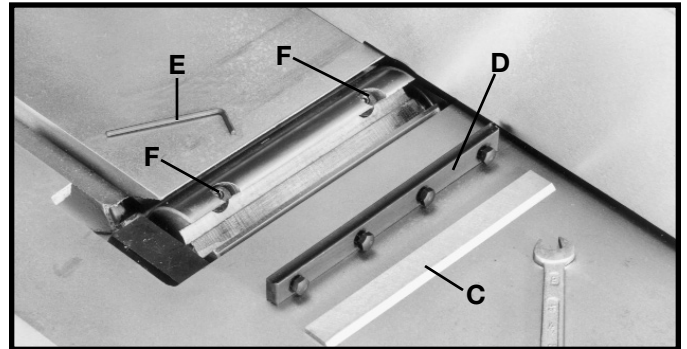

Fig. 50

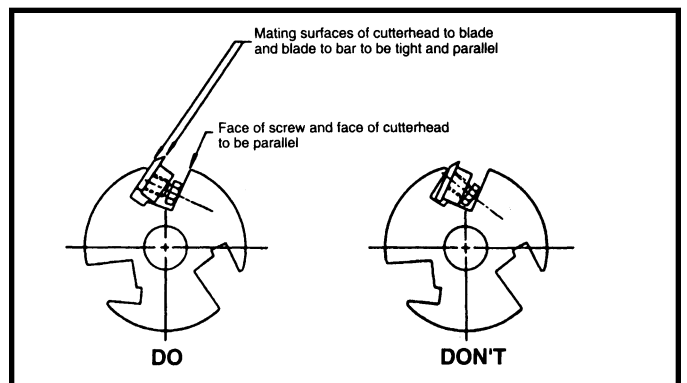

Fig. 51

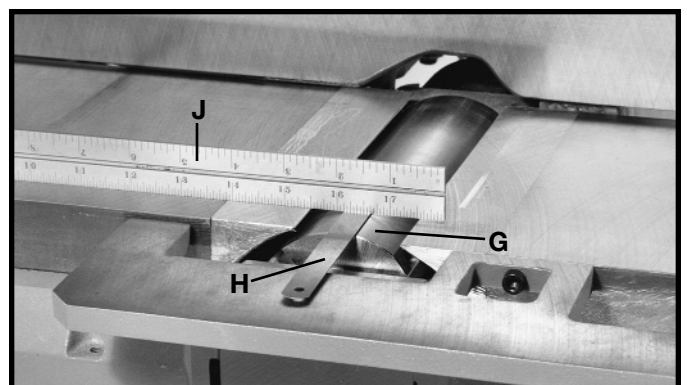

Fig. 52

12. Lower the infeed table and place a straight edge (J) Fig. 53, on the outfeed table extending over the cutterhead as shown.
13. Rotate the cutterhead by hand until the knife is at its highest point at each end of the cutterhead. To raise the knife, use wrench (E) Fig. 53, and turn raising screw clockwise until the knife just touches the straight edge (J) on each end and center of the cutterhead when the knife is at its highest point. When you are certain the knife is adjusted properly, tighten the four locking screws (B) Fig. 49, by turning them counterclockwise.
14. Adjust the remaining two knives in the same manner. **MAKE CERTAIN THAT ALL KNIVES ARE SECURELY FASTENED IN CUTTERHEAD BEFORE TURNING ON POWER.**
15. Replace cutterhead guard.

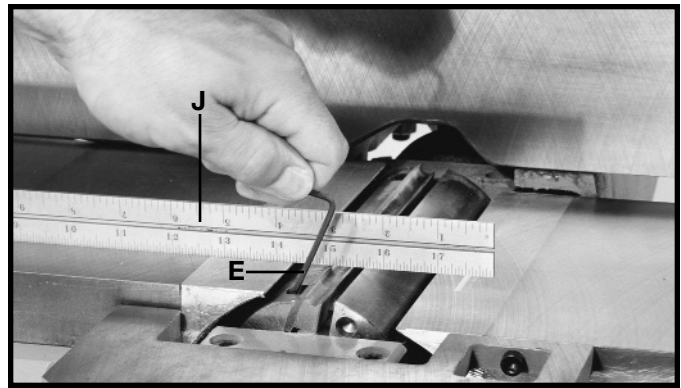
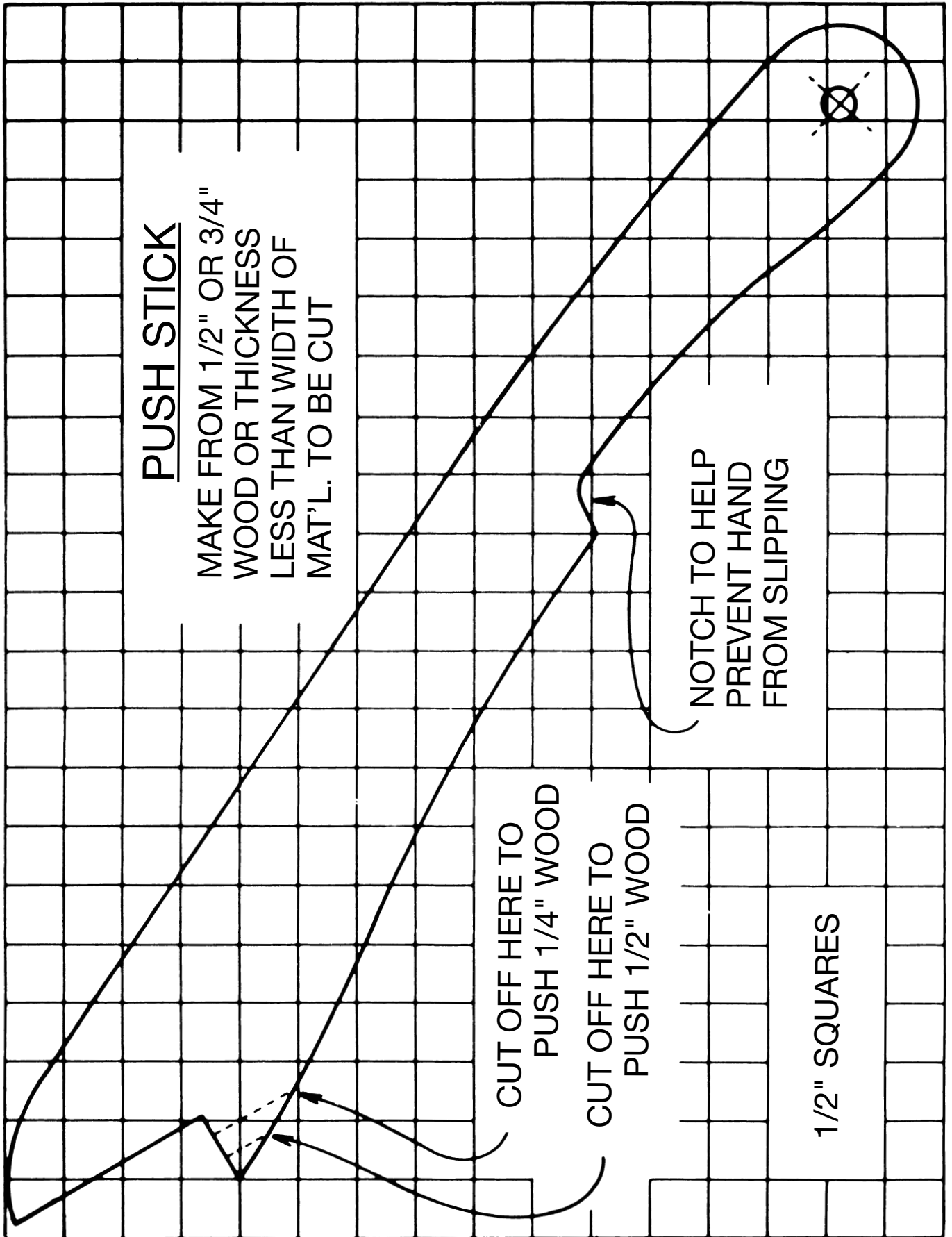

Fig. 53

CONSTRUCTING A PUSH STICK

⚠ CAUTION Narrow pieces of stock that are close to 10 inch minimum length should be handled with a push stick and push block. The diagram below is a pattern for a push stick.



NOTES

SERVICE



PARTS, SERVICE OR WARRANTY ASSISTANCE

All Delta Machines and accessories are manufactured to high quality standards and are serviced by a network of Porter-Cable • Delta Factory Service Centers and Delta Authorized Service Stations. To obtain additional information regarding your Delta quality product or to obtain parts, service, warranty assistance, or the location of the nearest service outlet, please call 1-800-223-7278 (In Canada call 1-800-463-3582).

ACCESSORIES

A complete line of accessories is available from your Delta Supplier, Porter-Cable • Delta Factory Service Centers, and Delta Authorized Service Stations. Please visit our Web Site www.deltamachinery.com for a catalog or for the name of your nearest supplier.

▲ WARNING Since accessories other than those offered by Delta have not been tested with this product, use of such accessories could be hazardous. For safest operation, only Delta recommended accessories should be used with this product.

WARRANTY



Two Year Limited New Product Warranty

Delta will repair or replace, at its expense and at its option, any new Delta machine, machine part, or machine accessory which in normal use has proven to be defective in workmanship or material, provided that the customer returns the product prepaid to a Delta factory service center or authorized service station with proof of purchase of the product within two years and provides Delta with reasonable opportunity to verify the alleged defect by inspection. For all refurbished Delta product, the warranty period is 180 days. Delta may require that electric motors be returned prepaid to a motor manufacturer's authorized station for inspection and repair or replacement. Delta will not be responsible for any asserted defect which has resulted from normal wear, misuse, abuse or repair or alteration made or specifically authorized by anyone other than an authorized Delta service facility or representative. Under no circumstances will Delta be liable for incidental or consequential damages resulting from defective products. This warranty is Delta's sole warranty and sets forth the customer's exclusive remedy, with respect to defective products; all other warranties, express or implied, whether of merchantability, fitness for purpose, or otherwise, are expressly disclaimed by Delta.

PORTER-CABLE • DELTA SERVICE CENTERS (CENTROS DE SERVICIO DE PORTER-CABLE • DELTA)

Parts and Repair Service for Porter-Cable • Delta Machinery are Available at These Locations
(Obtenga Refaccion de Partes o Servicio para su Herramienta en los Siguientes Centros de Porter-Cable • Delta)

ARIZONA

Tempe 85282 (Phoenix)
2400 West Southern Avenue
Suite 105
Phone: (602) 437-1200
Fax: (602) 437-2200

CALIFORNIA

Ontario 91761 (Los Angeles)
3949A East Guasti Road
Phone: (909) 390-5555
Fax: (909) 390-5554

San Diego 92111
7638 Clairemnot Blvd.
Phone: (858) 277-9595
Fax: (858) 277-9696

San Leandro 94577 (Oakland)
3039 Teagarden Street
Phone: (510) 357-9762
Fax: (510) 357-7939

COLORADO

Arvada 80003 (Denver)
8175 Sheridan Blvd., Unit S
Phone: (303) 487-1809
Fax: (303) 487-1868

FLORIDA

Davie 33314 (Miami)
4343 South State Rd. 7 (441)
Unit #107
Phone: (954) 321-6635
Fax: (954) 321-6638

Tampa 33609
4538 W. Kennedy Boulevard
Phone: (813) 877-9585
Fax: (813) 289-7948

GEORGIA

Forest Park 30297 (Atlanta)
5442 Frontage Road,
Suite 112
Phone: (404) 608-0006
Fax: (404) 608-1123

ILLINOIS

Addison 60101 (Chicago)
400 South Rohlwing Rd.
Phone: (630) 424-8805
Fax: (630) 424-8895

Woodridge 60517 (Chicago)
2033 West 75th Street
Phone: (630) 910-9200
Fax: (630) 910-0360

MARYLAND

Elkridge 21075 (Baltimore)
7397-102 Washington Blvd.
Phone: (410) 799-9394
Fax: (410) 799-9398

MASSACHUSETTS

Franklin 02038 (Boston)
Franklin Industrial Park
101E Constitution Blvd.
Phone: (508) 520-8802
Fax: (508) 528-8089

MICHIGAN

Madison Heights 48071 (Detroit)
30475 Stephenson Highway
Phone: (248) 597-5000
Fax: (248) 597-5004

MINNESOTA

Minneapolis 55429
5522 Lakeland Avenue North
Phone: (763) 561-9080
Fax: (763) 561-0653

MISSOURI

North Kansas City 64116
1141 Swift Avenue
Phone: (816) 221-2070
Fax: (816) 221-2897

St. Louis 63119
7574 Watson Road
Phone: (314) 968-8950
Fax: (314) 968-2790

NEW YORK

Flushing 11365-1595 (N.Y.C.)
175-25 Horace Harding Expwy.
Phone: (718) 225-2040
Fax: (718) 423-9619

NORTH CAROLINA

Charlotte 28270
9129 Monroe Road, Suite 115
Phone: (704) 841-1176
Fax: (704) 708-4625

OHIO

Columbus 43214
4560 Indianola Avenue
Phone: (614) 263-0929
Fax: (614) 263-1238

Cleveland 44125
8001 Sweet Valley Drive
Unit #19
Phone: (216) 447-9030
Fax: (216) 447-3097

OREGON

Portland 97230
4916 NE 122 nd Ave.
Phone: (503) 252-0107
Fax: (503) 252-2123

PENNSYLVANIA

Willow Grove 19090
(Philadelphia)
520 North York Road
Phone: (215) 658-1430
Fax: (215) 658-1433

TEXAS

Carrollton 75006 (Dallas)
1300 Interstate 35 N, Suite 112
Phone: (972) 446-2996
Fax: (972) 446-8157

Houston 77043
4321 Sam Houston Parkway,
West
Suite 180
Phone: (713) 983-9910
Fax: (713) 983-6645

WASHINGTON

Auburn 98001(Seattle)
3320 West Valley HWY, North
Building D, Suite 111
Phone: (253) 333-8353
Fax: (253) 333-9613

Authorized Service Stations are located in many large cities. Telephone **800-438-2486** or **731-541-6042** for assistance locating one. Parts and accessories for Porter-Cable-Delta products should be obtained by contacting any Porter-Cable-Delta Distributor, Authorized Service Center, or Porter-Cable-Delta Factory Service Center. If you do not have access to any of these, call **800-223-7278** and you will be directed to the nearest Porter-Cable-Delta Factory Service Center. Las Estaciones de Servicio Autorizadas están ubicadas en muchas grandes ciudades. Llame al **800-438-2486** ó al **731-541-6042** para obtener asistencia a fin de localizar una. Las piezas y los accesorios para los productos Porter-Cable-Delta deben obtenerse poniéndose en contacto con cualquier distribuidor Porter-Cable-Delta, Centro de Servicio Autorizado o Centro de Servicio de Fábrica Porter-Cable-Delta. Si no tiene acceso a ninguna de estas opciones, llame al **800-223-7278** y le dirigirán al Centro de Servicio de Fábrica Porter-Cable-Delta más cercano.

CANADIAN PORTER-CABLE • DELTA SERVICE CENTERS

ALBERTA

Bay 6, 2520-23rd St. N.E.
Calgary, Alberta
T2E 8L2
Phone: (403) 735-6166
Fax: (403) 735-6144

BRITISH COLUMBIA

8520 Baxter Place
Burnaby, B.C.
V5A 4T8
Phone: (604) 420-0102
Fax: (604) 420-3522

MANITOBA

1699 Dublin Avenue
Winnipeg, Manitoba
R3H 0H2
Phone: (204) 633-9259
Fax: (204) 632-1976

ONTARIO

505 Southgate Drive
Guelph, Ontario
N1H 6M7
Phone: (519) 767-4132
Fax: (519) 767-4131

QUÉBEC

1515 ave.
St-Jean Baptiste, Suite 160
Québec, Québec
G2E 5E2
Phone: (418) 877-7112
Fax: (418) 877-7123

1447, Begin
St-Laurent, (Montréal),
Québec
H4R 1V8
Phone: (514) 336-8772
Fax: (514) 336-3505

The following are trademarks of PORTER-CABLE • DELTA (Las siguientes son marcas registradas de PORTER-CABLE • DELTA S.A.) (Les marques suivantes sont des marques de fabricant de la PORTER-CABLE • DELTA): Auto-Set®, BAMMER®, B.O.S.S.®, Builder's Saw®, Contractor's Saw®, Contractor's Saw II™, Delta®, DELTACRAFT®, DELTAGRAM™, Delta Series 2000™, DURATRONIC™, Emc²™, FLEX®, Flying Chips™, FRAME SAW®, Grip Vac™, Homecraft®, INNOVATION THAT WORKS®, Jet-Lock®, JETSTREAM®, 'kickstand®, LASERLOC®, MICRO-SET®, Micro-Set®, MIDI LATHE®, MORTEN™, NETWORK™, OMNIJIG®, POCKET CUTTER®, PORTA-BAND®, PORTA-PLANE®, PORTER-CABLE®&(design), PORTER-CABLE®PROFESSIONAL POWER TOOLS, PORTER-CABLE REDEFINING PERFORMANCE™, Posi-Matic®, Q-3®&(design), QUICKSAND®&(design), QUICKSET™, QUICKSET II®, QUICKSET PLUS™, RIPTIDE™&(design), SAFE GUARD II®, SAFE-LOC®, Sanding Center®, SANDTRAP®&(design), SAW BOSS®, Sawbuck™, Sidekick®, SPEED-BLOC®, SPEEDMATIC®, SPEEDTRONIC®, STAIR EASE®, The American Woodshop®&(design), The Lumber Company®&(design), THE PROFESSIONAL EDGE®, THE PROFESSIONAL SELECT®, THIN-LINE™, TIGER®, TIGER CUB®, TIGER SAW®, TORQBUSTER®, TORQ-BUSTER®, TRU-MATCH™, TWIN-LITE®, UNIGUARD®, Unifence®, UNIFEEDER™, Unihead®, Uniplane™, Unirip®, Unisaw®, Univise®, Versa-Feeder®, VERSA-PLANE®, WHISPER SERIES®, WOODWORKER'S CHOICE™.

Trademarks noted with ™ and ® are registered in the United States Patent and Trademark Office and may also be registered in other countries. Las Marcas Registradas con el signo de ™ y ® son registradas por la Oficina de Registros y Patentes de los Estados Unidos y también pueden estar registradas en otros países.