

Use & Care Guide
IQ-Touch™ Front-Load Washer

Guide d'utilisation et d'entretien
Laveuse à chargement frontal IQ-Touch^{MC}

Guía de uso y cuidado
Lavadora de carga frontal IQ-Touch^{MC}

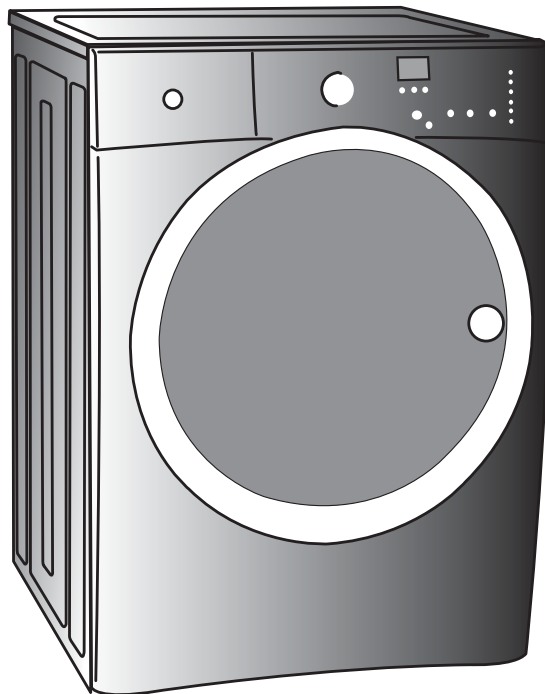

 **Electrolux**

Please read and save this guide

Thank you for choosing **Electrolux**, the new premium brand in home appliances. This *Use & Care Guide* is part of our commitment to customer satisfaction and product quality throughout the service life of your new appliance.

We view your purchase as the beginning of a relationship. To ensure our ability to continue serving you, please use this page to record important product information.

Keep a record for quick reference

Purchase date

Electrolux model number

Electrolux serial number

NOTE

Registering your product with Electrolux enhances our ability to serve you. You can register online at **www.electroluxappliances.com** or by dropping your Product Registration Card in the mail.

Questions?

For toll-free telephone support in the U.S. and Canada: **1-877-4ELECTROLUX (1-877-435-3287)**

For online support and product information visit **<http://www.electroluxappliances.com>**

Table of contents

Finding information.....	2	• Options	19
SAFETY	3-5	• Washer Features.....	20
Features.....	6	Cycle Chart.....	21
Operating Instructions.....	7-18	Stain Removal Guide.....	22-23
• Getting Started	7	• Stain Removal Procedures	22
• Normal Operating Sounds.....	7	• Stain Removal Suggestions.....	23
• Operating Your Washer.....	8-13	Care & Cleaning.....	24-27
• Cycle Selection.....	14-17	Solutions to Common Problems	28-31
• Washing/Rinsing Temperature.....	17-18	• Common Washing Problems.....	28-29
• Spin Speed	18	• Service Prevention Checklist.....	30-31
• Soil Level	18	Warranty Information.....	32

Important Safety Instructions

Recognize safety symbols, words and labels

Your safety and the safety of others is very important.

We have provided many important safety messages in the Use and Care Guide, Installation Instructions and on your appliance. Always read and obey all safety messages.

Safety items throughout this manual are labeled with a WARNING or CAUTION based on the risk type as described below:

 **WARNING** This symbol alerts you to situations that may cause serious body harm, death or property damage.

 **CAUTION** This symbol alerts you to situations that may cause bodily injury or property damage.

NOTE

The instructions appearing in this *Use and Care Guide* are not meant to cover every possible condition and situation that may occur. Common sense and caution must be practiced when installing, operating and maintaining any appliance.

WARNING

For your safety the following information in this manual must be followed to minimize the risk of fire or explosion or to prevent property damage, personal injury or death.

Do not store or use gasoline or other flammable vapors and liquids in the vicinity of this or any other appliance.

WHAT TO DO IF YOU SMELL GAS:

- Do not try to light any appliance.
- Do not touch any electrical switch; do not use any phone in your building.
- Clear the room, building or area of all occupants.
- Immediately call your gas supplier from a neighbor's phone. Follow the gas supplier's instructions.
- If you cannot reach your gas supplier, call the fire department.

Installation and service must be performed by a qualified installer, service agency or the gas supplier.

Save these instructions for future reference.



WARNING

To reduce the risk of fire, electrical shock, or injury to persons when using this washer, comply with the basic warnings listed below. Failure to comply with these warnings could result in serious personal injuries.

You can be killed or seriously injured if you don't follow these Important Safety Instructions:

PREVENT FIRE

- Do not wash items that have been previously cleaned in, soaked in, or spotted with gasoline, cleaning solvents, kerosene, cooking oils, waxes, etc. Do not store these items on or near the washer. These substances give off vapors or chemical reactions that could ignite or explode.
- Do not put oily or greasy rags or clothing on top of the washer. These substances give off vapors that could ignite the materials.
- Do not add gasoline, cleaning solvents, or other flammable or explosive substances to the wash water. These substances give off vapors that could ignite or explode.
- Under certain conditions, hydrogen gas may be produced in a hot water system that has not been used for 2 weeks or more. **HYDROGEN GAS IS EXPLOSIVE.** If the hot water system has not been used for such a period, before using the washer, turn on all hot water faucets and let the water flow from each for several minutes. This will release any accumulated hydrogen gas. Hydrogen gas is flammable; do not smoke or use an open flame during this time.
- Do not store or use gasoline or other flammable vapors or liquids in the vicinity of this or any other appliance.
- Failure to comply with these warnings could result in fire, explosion, serious bodily injury and/or damage to the rubber or plastic parts of the washer.

PROTECT CHILDREN

- Do not allow children to play on or in the washer. Close supervision of children is necessary when the washer is used near children. As children grow, teach them the proper, safe use of all appliances.
- Destroy the carton, plastic bag and other packing materials after the washer is unpacked. Children might use them for play. Cartons covered with rugs, bedspreads or plastic sheets can become airtight chambers.
- Keep laundry products out of children's reach. To prevent personal injury, observe all warnings on product labels.
- Before the washer is removed from service or discarded, remove the washer door to prevent accidental entrapment.
- Failure to comply with these warnings could result in serious personal injuries.

Important Safety Instructions, continued

PREVENT INJURY

- To prevent shock hazard and assure stability during operation, the washer must be installed and electrically grounded by a qualified service person in accordance with local codes. Installation instructions are packed in the washer for installer's reference. Refer to **INSTALLATION INSTRUCTIONS** for detailed grounding procedures. If the washer is moved to a new location, have it checked and reinstalled by a qualified service person.
- To prevent personal injury or damage to the washer, the electrical power cord of the washer must be plugged into a properly grounded and polarized 3-prong outlet. The third grounding prong must never be removed. Never ground the washer to a gas pipe. Do not use an extension cord or an adaptor plug.
- Follow package directions when using laundry products. Incorrect usage can produce poisonous gas - resulting in serious injury or death.
- Do not combine laundry products for use in 1 load unless specified on the label.
- Do not mix chlorine bleach with ammonia or acids such as vinegar.

WARNING

FIRE/ELECTRICAL SHOCK HAZARD

Avoid fire hazard or electrical shock. Do not use an adaptor plug or extension cord or remove grounding prong from electrical power cord. Failure to follow this warning can cause serious injury, fire or death.

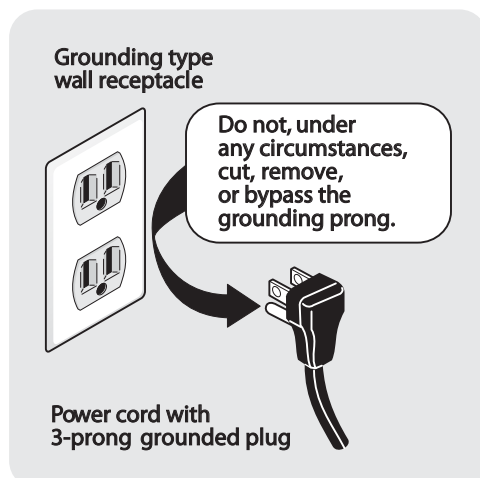

PREVENT INJURY AND DAMAGE TO THE WASHER

To prevent serious personal injury and damage to the washer:

- All repairs and servicing must be performed by an authorized servicer unless specifically recommended in this **Use & Care Guide**. Use only authorized factory parts.
- Do not tamper with controls.
- Do not install or store the washer where it will be exposed to the weather.
- Do not install on carpet. Install washer on a solid floor. It may be necessary to reinforce the floor to prevent vibration or movement.
- To reduce the risk of electric shock, disconnect this appliance from the power supply before attempting any user maintenance. Turning the controls to the OFF position does not disconnect this appliance from the power supply.
- To prevent injury, do not reach into the washer while parts are moving. Before loading, unloading or adding items, push in the cycle selector knob and allow the drum to coast to a complete stop before reaching inside.
- This washer is equipped with an electrical overload protector. The motor will stop if it becomes overheated. The washer will automatically restart after a cool down period of up to 30 minutes, if the washer has not been manually turned off during this time.
- Failure to comply with these warnings could result in serious personal injuries.

WARNING

HARMFUL VAPOR HAZARD

Do not use or mix liquid chlorine bleach with other household chemicals such as toilet cleaners, rust removers, acid or products containing ammonia. These mixtures can produce dangerous fumes which can cause serious injury or death.



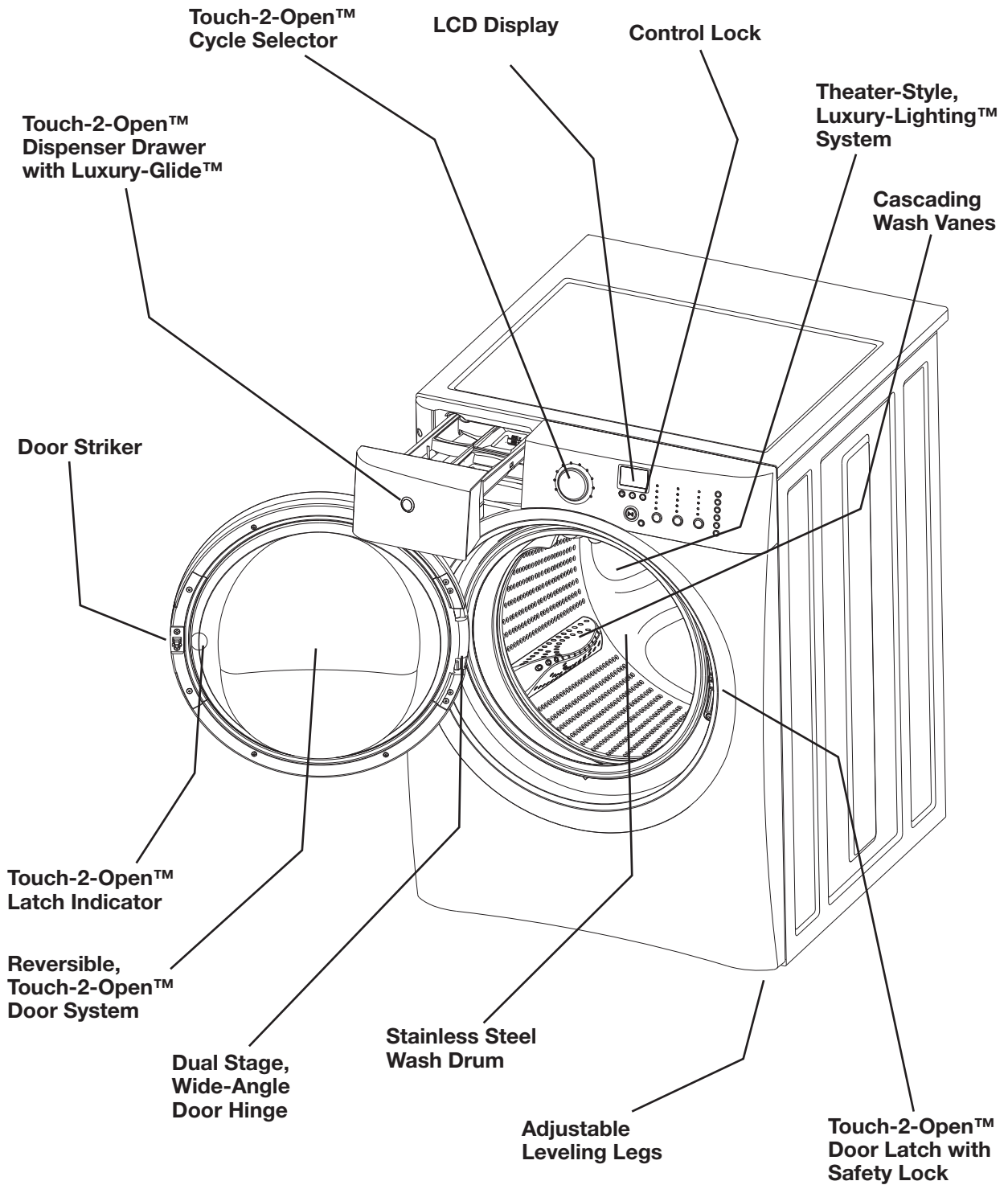

As an ENERGY STAR® Partner, Electrolux Major Appliances has determined that this product meets the ENERGY STAR® guidelines for energy efficiency.

Getting Started

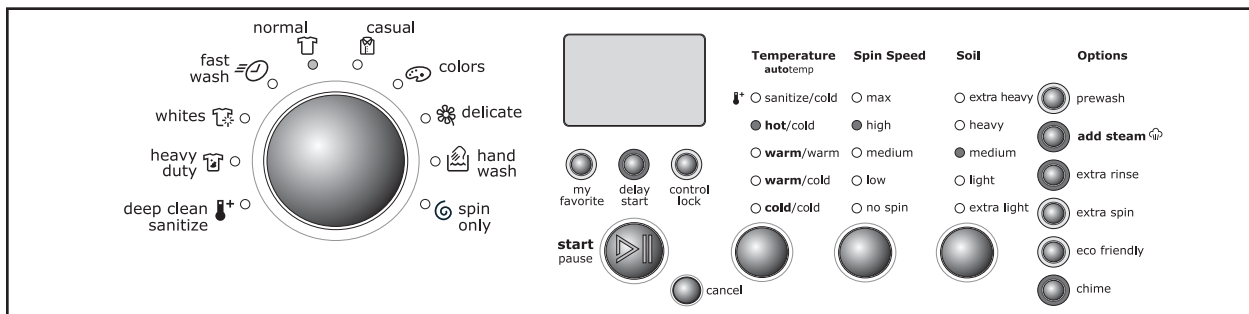

To run your washer, follow these basic steps:

1. Sort laundry into loads that can be washed together. (See page 8.)
2. Prepare items for washing. (See page 8.)
3. Pretreat stains and heavy soil. (See page 9.)
4. Add laundry load to the washer. (See page 9.)
5. Add laundry products to the dispenser. (See page 10-11.)
6. Select the appropriate cycle and settings for the load. (See page 12.)
7. Start the washer. (See pages 12-13.)

Normal Operating Sounds

You may or may not hear the following sounds from your new washer:

- A. DRAIN HOSE** The washer has a flexible drain hose to carry water from the washer to the stand pipe of your home. You will hear water flowing into your stand pipe. This is a normal part of the operation of the washer.
- B. WATER VALVES/DISPENSER** As water enters the dispenser system, it is common to hear a water flowing sound. This normal sound will vary slightly based on the water pressure in your home.
- C. DOOR LOCK** Your washer is equipped with a door lock with an electric solenoid. There will be a clicking sound as the washer door is being locked or unlocked.
- D. DRAIN PUMP** Your washer is equipped with a high velocity drain pump. It is normal to hear humming and gurgling sounds as water is pumped from the washer. Both of these sounds are normal and indicate that your pump is functioning correctly.
- E. HIGH SPEED MOTOR** A powerful motor is used to drive the drum to high spin speeds to extract water from your load. You will hear a sound associated with these higher spin speeds. This sound is normal and will vary slightly as the spin speed varies with load size and cycle selected.

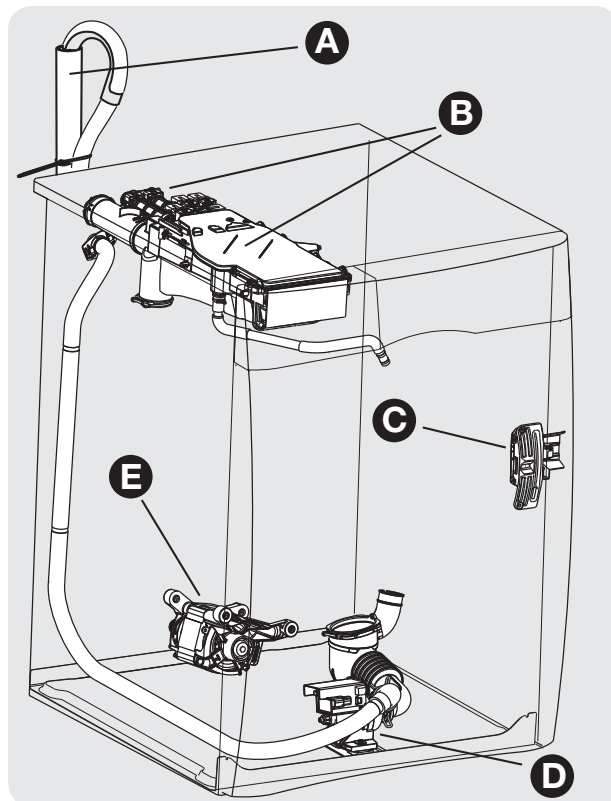

Operating Your Washer

BEFORE USING YOUR WASHER

Read the important instructions in this section of the *Use and Care Guide* before operating your washer.

WARNING

To reduce the risk of fire, electric shock or injury to persons, read the IMPORTANT SAFETY INSTRUCTIONS in this *Use and Care Guide* before operating your washer.

OPERATING YOUR WASHER

1. Sort laundry into loads that can be washed together.

Sort items by recommended cycle and water temperature.

Separate white, light and colorfast items from dark and non-colorfast items.

Separate items that shed lint from items that attract lint. Casual, synthetic, knit, and corduroy items will pick up lint from towels, rugs, and chenille bedspreads.

Separate heavily soiled items from lightly soiled items.

Separate lacy, sheer, loosely knit, or delicate items from durable items.

Do not machine wash items containing fiberglass. Small particles of fiberglass left in the drum may transfer to fabrics in other loads and cause skin irritation.

2. Prepare items for washing.

Empty pockets.

Brush off lint and dirt. Shake out rugs and beach towels.

Close zippers, fasten hooks, tie strings and sashes, and remove non-washable trims and ornaments.

Mend rips and tears to prevent further damage during washing.

Turn knit items inside out to prevent pilling.

Place delicate and small items such as bras, hosiery and baby socks in a mesh bag.

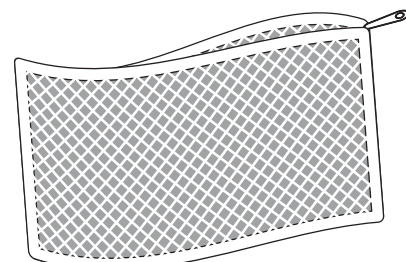
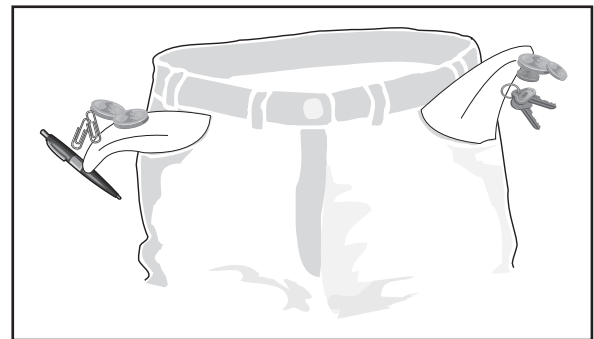
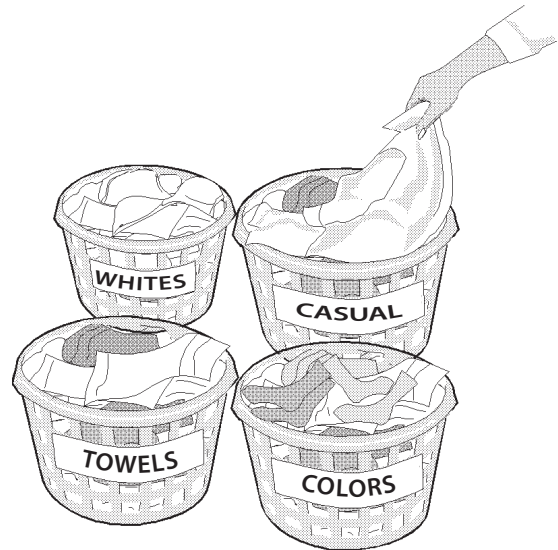

(Mesh bag not included.)

OPERATING YOUR WASHER, continued

3. Pretreat stains and heavy soil.

See **Stain Removal Guide** in this guide for safe, successful stain removal instructions.

4. Add laundry load to washer.

Combine large and small items in a load.

Load large items first. Large items should not be more than half the total wash load.

Washing single items such as a sweater, towel or jeans is inefficient and may cause an out-of-balance load. Add 1 or 2 similar items to help balance the load.

Wash a single heavy item such as a king-sized comforter, bedspread or sleeping bag separately.

The washer can be fully loaded, but the items should not be tightly packed. The door should close easily.

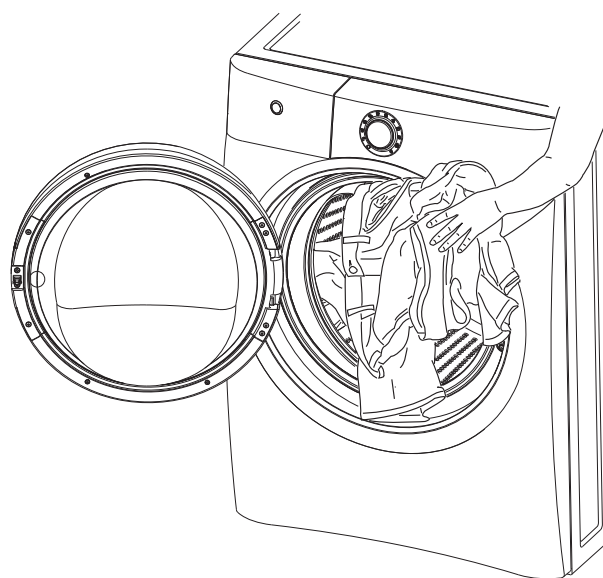
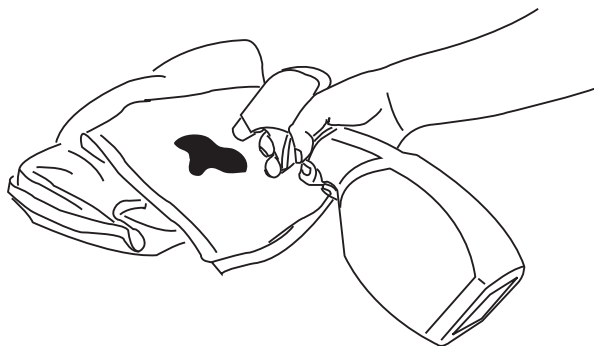

OPERATING YOUR WASHER, continued

5. Add laundry products to the dispenser.

**For best results**

Use a low-sudsing, high efficiency detergent to prevent oversudsing in front load washers. Look for this symbol on the detergent label: 

Detergent, liquid chlorine bleach and liquid fabric softener will be dispensed at the proper times in the cycle. To unlatch the dispenser drawer push on the dispenser drawer latch indicator. To close and latch the dispenser drawer push the drawer in until you hear a slight click with the drawer face flush to the pane.

 **IMPORTANT**

Open and close the dispenser drawer slowly. Closing the drawer too quickly could result in early dispensing of the bleach or fabric softener.

Use the cap or scoop provided by the detergent manufacturer to measure the amount recommended. Detergent dosage may need to be adjusted for water temperature, water hardness, load size and soil level.

Liquid Detergent 

Add the recommended amount of a high efficiency liquid detergent to the **“Main Wash - liquid only”** cup. Do not exceed the **MAX** fill line. Liquid detergent can also be added directly to the **“Main Wash”** chamber when not using the **“Pre-Wash”** option.

**NOTE**

From time to time you may see water in the **“Main Wash - liquid only”** chamber. This is part of the normal operation of the washer.

Powder Detergent 

To use a high efficiency powder detergent, remove the **“Main Wash - liquid only”** cup and add the powder directly to the **“Main Wash”** detergent chamber.

 **IMPORTANT**

Save the liquid cup insert for future use. **DO NOT** discard it while you are using powder detergent.

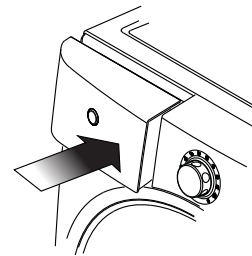
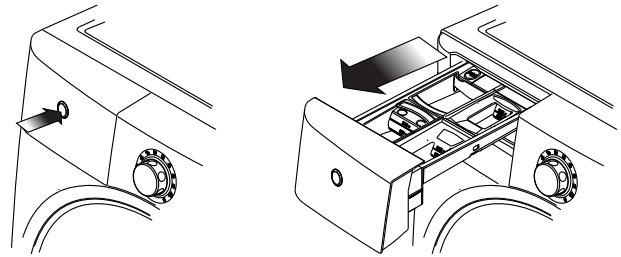

Insert liquid cup when using liquid detergent.

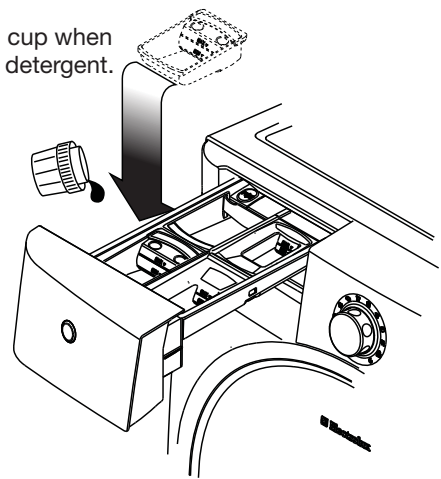

Remove liquid cup when using powder detergent! **DO NOT** pour powder detergent into liquid cup. It will not dispense correctly!

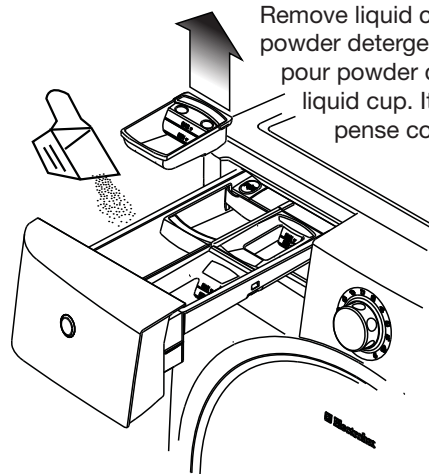

OPERATING YOUR WASHER, continued

Other Wash Products

Color-safe bleach, water conditioner, detergent booster and enzyme products may be added with the detergent. Put liquid products with liquid detergent in the **“Main Wash - liquid only”** detergent cup or powder products with powder detergent in the **“Main Wash”** detergent chamber.

▶ IMPORTANT

Do not mix liquids and powders.

Detergent for Prewash

For heavily soiled or stained loads, select the **prewash** option and add the recommended amount of detergent to the **“Pre-Wash”** detergent cup.

NOTE

From time to time you may see water in the **“Main Wash - liquid only”**, **“Liquid Bleach”** and **“Fabric Softener”** chambers. This is part of the normal operation of the washer.

Liquid Chlorine Bleach

If desired, add liquid chlorine bleach to the chamber labeled **“Liquid Bleach”** and marked with this symbol . Fill to the **MIN** line for small loads or the **MAX** line for large loads. **DO NOT** fill above the maximum fill line.

Add color-safe bleach with the detergent.

▶ IMPORTANT

To prevent fabric damage, do not overfill the **“Liquid Bleach”** chamber or pour liquid chlorine bleach directly onto the load.

Liquid Fabric Softener

If desired, pour the recommended amount of liquid fabric softener into the chamber labeled **“Fabric Softener”** and marked with this symbol . Fill to the **MIN** line for small loads or the **MAX** line for large loads. **DO NOT** fill above the maximum fill line.

NOTE

To prevent staining, do not overfill the **“Fabric Softener”** chamber or pour liquid fabric softener directly on the wash load.

Use of a fabric softener-dispensing ball is not recommended in tumble action washers.

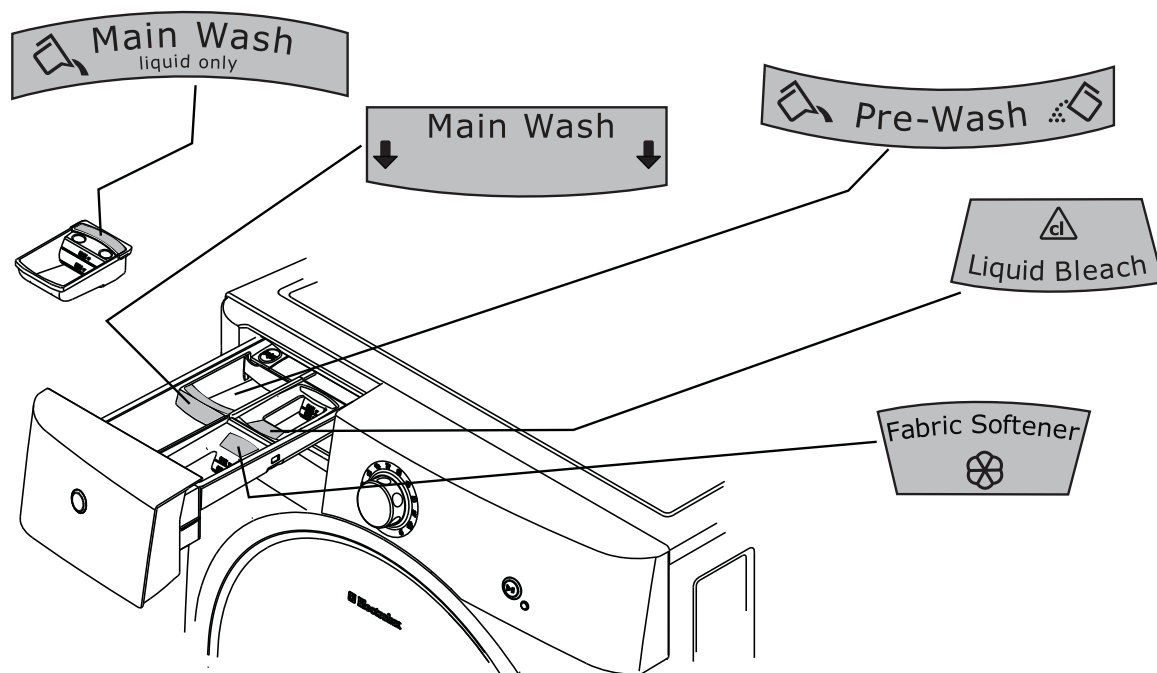

OPERATING YOUR WASHER, continued

6. Select the appropriate cycle and settings for the load.

Turn the cycle selector knob in either direction to select the cycle desired. The indicator for that cycle will be illuminated. See the “Cycle Selection” section in this guide for descriptions of each cycle.

The estimated cycle time, suitable wash and rinse water temperatures, final spin speed, soil level, and options for each cycle will be indicated for the cycle selected. See the “Cycle Settings” and “Washer Settings Chart” in this guide for descriptions and available settings for each cycle.

To change the settings, press the **temperature**, **spin speed**, **soil**, and **options** buttons to scroll to the desired settings.

To select or delete an **option**, press the button for that **option**. The indicator will light when the **option** has been selected. It will no longer be lighted when the **option** has been deleted.

NOTE

To provide the best care for your laundry, not every setting or option is available with every cycle. If a setting or option is not available for the cycle selected, the indicator will not light.

Adjustments to a cycle will be remembered and recalled each time that cycle is selected in the future.

To return to factory default settings, press and hold the **spin speed** and **soil** buttons at the same time for 5 seconds.

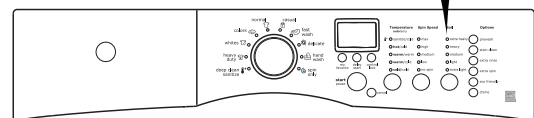
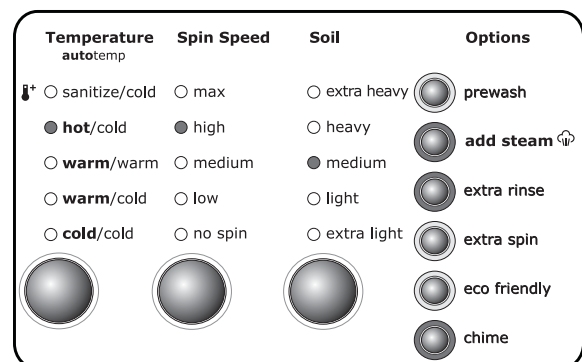
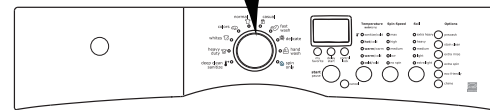
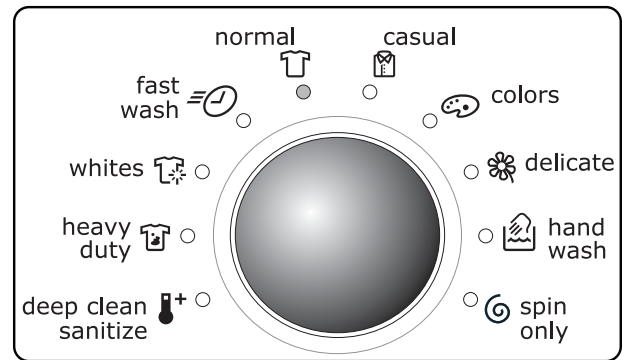

OPERATING YOUR WASHER, continued

7. Start the washer.

Close the door and press **start**. The washer will not operate with the door open and **DOOR OPEN** will be displayed.

Select **delay start** to delay the beginning of the cycle for up to 14 hours if desired.

As a safety measure, the door will automatically lock during the entire wash cycle.

To add a forgotten item to the washer any time during the wash portion of the cycle, press **pause**. When the door unlocks, open the door, add the item, close the door and press **start** to resume the cycle.

If changes to the settings or options are attempted after the cycle starts, you will hear several beeps when the buttons are pressed. To change the settings or options, press **pause**, make the new selections and press **start** again.

To change the cycle once the cycle has begun, press **cancel**, select a new cycle, and press **start** again. Just turning the cycle selector knob will not change the cycle.

To stop the cycle, press **cancel**.



NOTE

If the cycle is interrupted during spin, the door lock will not release until the tub has stopped spinning. **DO NOT** force open the door.

A signal will sound at the end of the cycle if the **chime** option has been selected.

Remove items from the washer when the cycle ends and place in dryer, line dry or dry flat as directed on the fabric care label.

Excess wrinkling, color transfer or odors may develop in items left in the washer after the cycle has ended, if not removed promptly.



CAUTION

ENTRAPMENT and TIP-OVER HAZARD
An open door could entice children to hang on the door or crawl inside the washer. If there are no small children present, you may leave the door ajar to prevent mildew and odor build up.

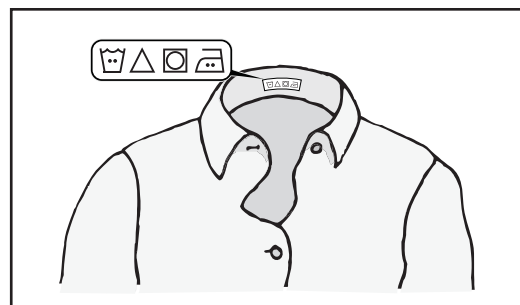
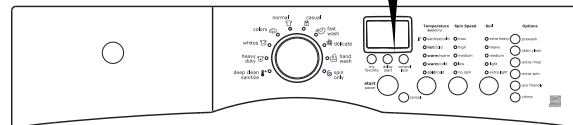
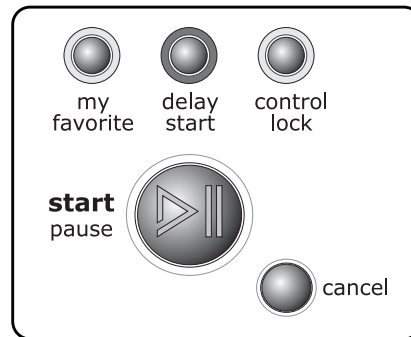

For best results

Follow the fabric care label instructions on items to be washed.

Cycle Selection

Turn the cycle selector in either direction to the cycle desired. The indicator for that cycle will be illuminated. Press on the cycle selector knob to extend it or return it flush to the console.

For best results
Follow the fabric care label instructions on items to be washed.

To change the selection after the cycle begins, press **cancel** before making another choice. Just turning the knob to another selection will not change the cycle.

NORMAL

The **normal** cycle provides 9-21 minutes of reversing tumble wash action for most loads. All **water temperatures** except **sanitize/cold**, all **spin speeds**, **soil** levels and **options** are available with this cycle.

COLORS

The **colors** cycle provides 5-20 minutes of reversing tumble wash action for mixed color loads. **Warm/cold** or **cold/cold** water **temperatures**, all **spin speeds**, **soil** levels and **options** except **add steam** (on select models) are available with this cycle.

WHITES

The **whites** cycle provides 9-21 minutes of reversing tumble wash action for whiter cottons. The use of liquid chlorine bleach is recommended. **Hot/cold** water, all **spin speeds**, **soil** levels, and **options** are available with this cycle.

HEAVY DUTY

The **heavy duty** cycle provides 9-21 minutes of reversing tumble wash action for heavily soiled sturdy items such as jeans. For best soil and stain removal, use the hottest water safe for the fabrics being washed. All **water temperatures** except **sanitary/cold**, all **spin speeds** and **options**, and all **soil** levels except **light** and **extra light** are available with this cycle.

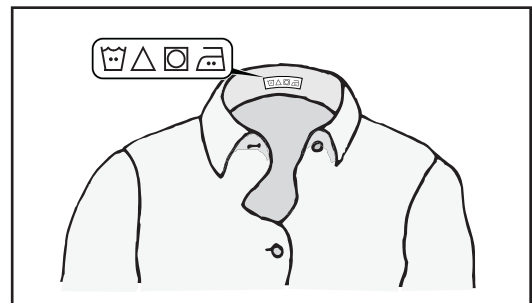
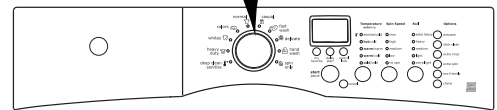
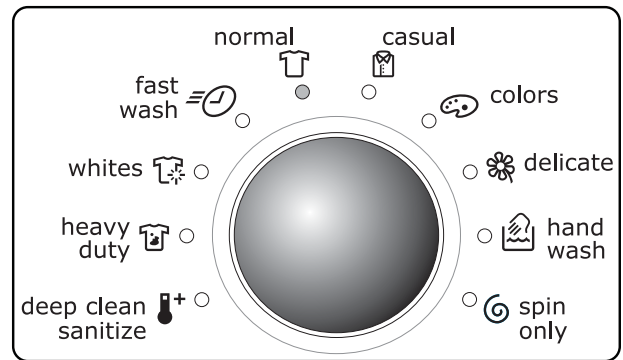

Temperature autotemp	Spin Speed	Soil	Options
<input type="radio"/> sanitize/cold	<input type="radio"/> max	<input type="radio"/> extra heavy	<input type="radio"/> prewash
<input checked="" type="radio"/> hot/cold	<input checked="" type="radio"/> high	<input type="radio"/> heavy	<input checked="" type="radio"/> add steam 
<input type="radio"/> warm/warm	<input type="radio"/> medium	<input checked="" type="radio"/> medium	<input type="radio"/> extra rinse
<input type="radio"/> warm/cold	<input type="radio"/> low	<input type="radio"/> light	<input type="radio"/> extra spin
<input type="radio"/> cold/cold	<input type="radio"/> no spin	<input type="radio"/> extra light	<input type="radio"/> eco friendly
<input type="radio"/>	<input type="radio"/>	<input type="radio"/>	<input type="radio"/> chime

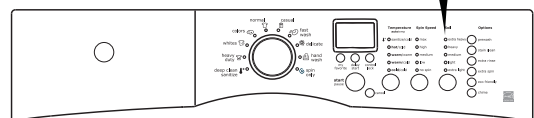

Cycle Selection, continued

DEEP CLEAN SANITIZE

Use the **deep clean sanitize** cycle to clean and sanitize heavily soiled, colorfast fabrics including towels, bedding, and children's clothing. Very hot water, all **spin speeds**, all **soil** levels except **light** and **extra light**, and all **options** except **prewash**, **eco friendly** and **stain clean** are available with this cycle.

It is recommended that you set your water heater to 120° F (49° C) or higher to ensure proper performance during this cycle. If the setting is lower or the load is extra large, the cycle time will be extended by 30 minutes or more.

The **deep clean sanitize** cycle will kill 99.9% of bacteria with no carryover of bacteria between loads. No bleach or harsh chemicals are needed, but higher temperatures are required. Please check fabric care labels to prevent damage.

NOTE

This cycle has been certified by NSF International, an independent third party testing and certification organization dedicated to public health, safety and environmental protection.

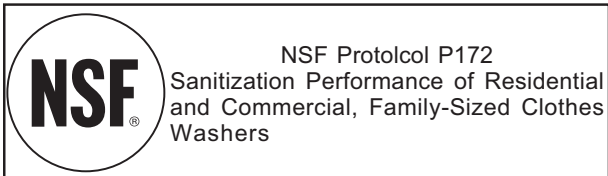

The wash water is heated by an internal boost heater to a maximum of 152° F (67° C) as the load tumbles for up to 4 hours. Cold water is added to cool down the load prior to drain and spin.

NOTE

If the voltage at your outlet is under 110 v, the internal heater may not adequately heat the wash water. If the cycle is interrupted while the water is heating, the final temperature of the wash water may be lower and sanitation may be reduced.

As a precaution, the washer door is locked once the water temperature reaches 130° F (55° C). If the cycle is cancelled during the wash phase and the water temperature is greater than 150° F (66° C), an automatic cool down and drain will occur before the door can be opened.

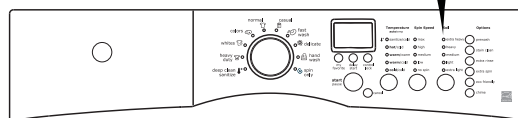
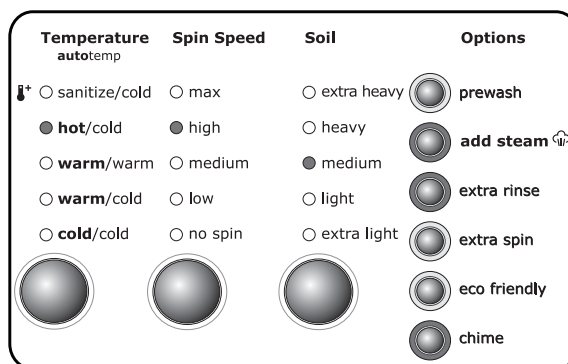
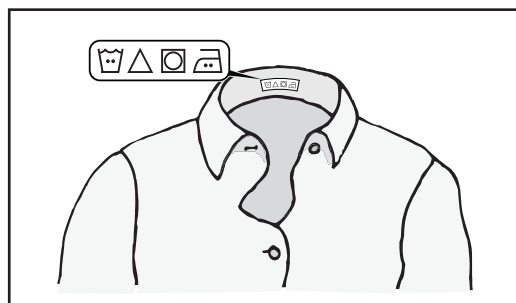
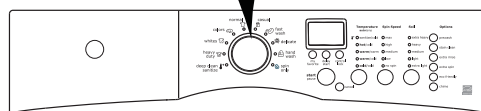
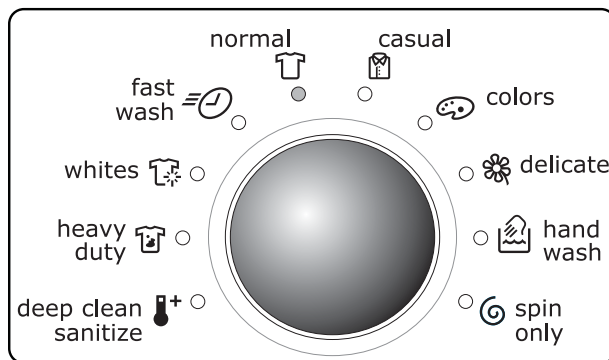

Cycle Selection, continued

CASUAL

The **casual** cycle provides 5-20 minutes of reversing tumble action for cottons and blends with a permanent press or no-iron finish. To minimize wrinkling, the **warm/warm** and **sanitize/cold temperatures** are not available with this cycle. All **spin speeds**, **soil** levels, and **options** are available.

FAST WASH

The **fast wash** cycle provides 5-11 minutes of reversing tumble action to quickly wash small, lightly soiled loads in 18 minutes. All water **temperatures** except **sanitize/cold**, all **spin speeds**, and all **soil** levels except **extra heavy** and **heavy** are available with this cycle. The **eco friendly** and **add steam** (on select models) **options** are also available.

DELICATE

The **delicate** cycle provides 6-12 minutes of gentle reversing tumble action for knits and delicates. All water **temperatures** except **hot/cold** and **sanitize/cold**, all **spin speeds**, all **soil** levels except **heavy** and **extra heavy**, and the **eco friendly**, **stain clean** (on select models), and **extra rinse options** are available with this cycle.

HAND WASH

The **hand wash** cycle provides 5-11 minutes of intermittent gentle tumbling for items labeled “Hand Washable”. All water **temperatures** except **hot/cold** and **sanitize/cold**, all **spin speeds**, all **soil** levels except **heavy** and **extra heavy**, and the **eco friendly** and **extra rinse options** are available with this cycle.

SPIN ONLY

Use the **spin only** cycle anytime you want to drain water from the washer and spin out the load or as a follow-up to the **no spin** selection. Select the **spin speed** appropriate for the load.

To add a cold water rinse prior to the spin, select the **extra rinse option**.

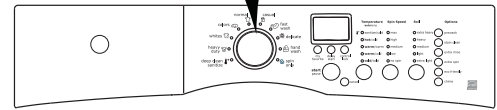
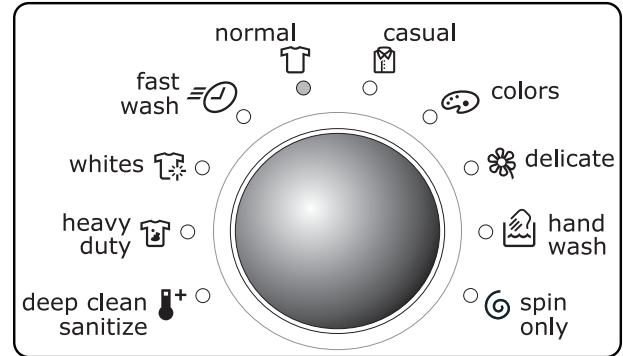

Temperature autotemp	Spin Speed	Soil	Options
<input type="radio"/> sanitize/cold	<input type="radio"/> max	<input type="radio"/> extra heavy	<input type="radio"/> prewash
<input checked="" type="radio"/> hot/cold	<input type="radio"/> high	<input type="radio"/> heavy	<input type="radio"/> add steam 
<input type="radio"/> warm/warm	<input type="radio"/> medium	<input checked="" type="radio"/> medium	<input type="radio"/> extra rinse
<input type="radio"/> warm/cold	<input type="radio"/> low	<input type="radio"/> light	<input type="radio"/> extra spin
<input type="radio"/> cold/cold	<input type="radio"/> no spin	<input type="radio"/> extra light	<input type="radio"/> eco friendly
			<input type="radio"/> chime

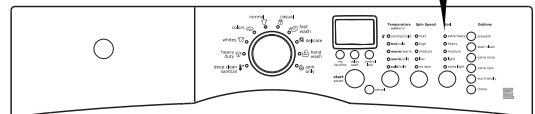

Cycle Selection, continued

MY FAVORITE

To program a cycle with your preferred water **temperature, spin speed, soil level and options**, press and hold the **my favorite** button for 3 seconds.

To use that customized cycle to wash future loads, simply press the **my favorite** button and the selected cycle, water **temperature, spin speed, soil level and options** will be indicated.

Your personalized cycle can be changed by repeating the **my favorite** procedure.

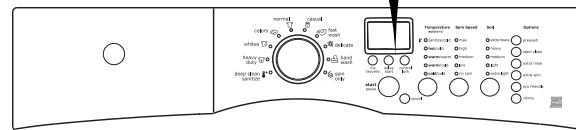
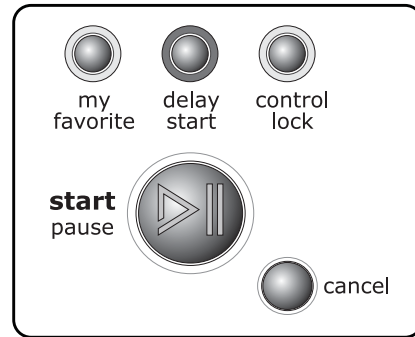

Washing/Rinsing Temperature

The appropriate washing temperature will automatically be indicated for the cycle selected.



For best results

Follow the fabric care label instructions on items to be washed.

To change the temperature, press the **temperature** button to scroll to the desired setting. Select a wash water temperature according to fiber content, colorfastness and soil level. A cold water rinse saves energy and reduces wrinkling.

To protect your fabrics, not all **temperatures** are available with every cycle. The indicator will not light if the setting is not available with that cycle.

The **temperature** selected for the cycle will be remembered and recalled each time that cycle is selected in the future.

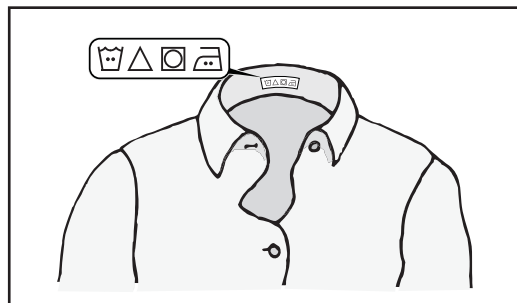

NOTE

To change the **temperature** once the cycle has begun, press the **pause** button, make the new selection and press **start** again.

All wash water **temperatures** are automatically regulated to maximize detergent effectiveness and improve washing performance. The water heater setting and its distance from the washer, water usage in other parts of the home, and seasonally low ground water temperature in some geographic areas can affect water temperature.

18 Operating Instructions

Temperature, continued

SANITIZE/COLD

This setting sanitizes heavily soiled colorfast fabrics such as towels, bedding, and children's clothing by killing 99.9% of bacteria using wash water heated with a boost heater to 152° F (67° C). Cold water is used to cool and rinse the load. This setting is only available with the **deep clean sanitize** cycle.

HOT/COLD

Use this setting for heavily soiled white or colorfast cottons and blends.

WARM/COLD

Use this setting for normally soiled white or colorfast cottons or blends.

WARM/WARM

Use this setting for washable woolens or when a warm water rinse is desired.

COLD/COLD

Use this setting for lightly soiled non-colorfast items, knits, delicates, and hand washables.

Spin Speed

Max, high, medium, and low spin speeds are available for each cycle. The **spin speed** and/or duration of final spin vary from cycle to cycle.

Increasing the **spin speed** will extract more water, decrease drying time and conserve energy. Decreasing the **spin speed** will reduce wrinkling.

Use **no spin** to omit the final spin at the end of the cycle. The load will be very wet. Remove items from the wash drum to drip dry or select the **spin only** cycle to remove excess water at a more convenient time.

Soil Level

Adjust the wash time in 3-minute increments based on the soil level of each load. **Normal, heavy, extra heavy, light** and **extra light** Soil levels are available.

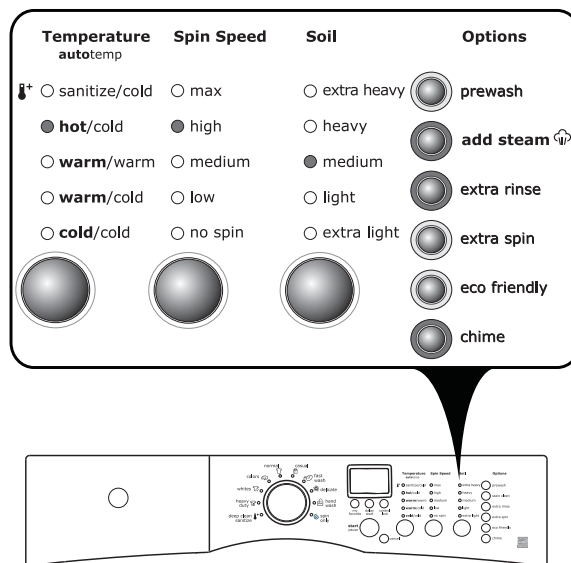

Options

Suitable options will automatically be indicated when the cycle is selected.

To add **options**, press the corresponding **options** buttons to illuminate the selections desired. To delete **options**, press the **options** buttons again and the indicator lights will turn off.

To protect your fabrics, not all **options** are available with every cycle. The indicator will not light if the **option** is not available with that cycle. Occasionally, two options in the same cycle will conflict with each other, like **extra spin** and **eco friendly**. When this happens, the option selected first will cause the conflicting option to not be selectable.



NOTE

To change the **options** once the cycle has begun, press the **pause** button, make the new selections and press **start** again.

All **options** selected for the cycle, except **add steam** (on select models) will be remembered and recalled each time that cycle is selected in the future. To prevent unintentional and accidental exposure of delicate material to unexpected steam, the **add steam option** (on select models) will not be remembered and must be reselected each time.



NOTE

The **add steam** option (on select models) will be retained and recalled if it is selected and saved in the **my favorite cycle**.

PREWASH

Select this **option** to add a short initial wash period to a cycle. Heavily soiled and stained loads will prewash for approximately 5 minutes. The water will drain and the load will automatically advance to the regular wash cycle.

See step 5 in “Operating Your Washer” section in this guide for details on adding detergent to the dispenser.

ADD STEAM (on select models)

Select this option to add approximately 20 minutes of tumbling in steam during the wash cycle. It is recommended for heavily soiled loads to help enhance the release of tough stains from fabrics after initial agitation. It is available with all cycles except **colors**, **delicates**, **hand wash** and **spin only**.



NOTE

- Steam may not necessarily be visible inside drum during a steam wash cycle.
- Steam may not be present during entire steam wash cycle.

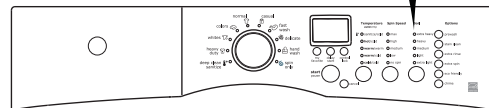
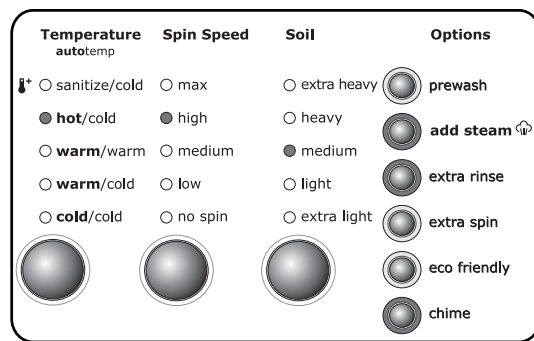

IMPORTANT

- If steam is selected, rinse temperatures will be elevated.
- If washer is paused during a steam wash cycle, the door will remain locked due to higher temperature in drum. DO NOT force open - it will unlock upon cooling.
- During a steam cycle you may notice steam exiting from the rear vent of the washer - this is normal and not cause for alarm.

STAIN CLEAN (on select models)

Use the **stain clean option** to add a 5-minute soak in the middle of the wash portion of the **heavy duty**, **whites**, **colors**, **normal**, **casual**, and **delicate** cycles.

EXTRA RINSE

Use this **option** when additional rinsing is desired to remove excess dirt and detergent. It is recommended for heavily soiled loads or if household members have sensitive skin. **Extra rinse** occurs before the final rinse when the liquid fabric softener is dispensed.

EXTRA SPIN

Use this **option** to add minutes to the final spin at the selected **Spin Speed**. This will improve water extraction, decrease drying time and save energy.

ECO FRIENDLY

The **eco friendly** option reduces the hot and warm water temperature a few degrees to save energy. It is available with all cycles except **deep clean sanitize** and **spin only**.

CHIME

A chime will sound at the end of the cycle when this **option** is selected. The signal has an adjustable volume level or can be turned off.

Washer Features

DELAY START

Use **delay start** with any cycle to select a wash time convenient to your schedule or during off peak energy hours. The start of the cycle can be delayed for up to 14 hours. The delay time selected will be displayed as 30, 60, or 90 minutes or 2 through 14 hours.

CONTROL LOCK

To lock the controls between cycles, press and hold the **control lock** button for 5 seconds. Repeat to unlock the controls when you are ready to operate the washer. Use this feature to reduce the likelihood of accidental operation by children.

STATUS DISPLAY

The estimated total cycle time will be displayed when the cycle is selected. The time may increase if water pressure is low, oversudsing occurs or the load becomes unbalanced. The approximate time remaining will be displayed during the cycle.

A situation where oversudsing has been detected by the washer will result in the washer automatically adding up to 4 extra rinses to attempt to clear the suds. Each extra rinse the washer performs to clear the suds will add 5 minutes to the cycle display time. If an excessive amount of detergent has been added and additional rinsing has not corrected the issue, **TOD MUCH DETERGENT** will be displayed.

DRUM LIGHT

The drum light will come on whenever the door is opened to illuminate the drum during loading and unloading. Closing the door turns off the light. The drum light will automatically turn off if the door is left open more than 3 minutes.

REVERSIBLE DOOR

Your washer is equipped with a reversible door. The door can be hinged on the right or left side.

NOTE

For step-by-step instructions on **DOOR REVERSAL**, refer to the *Installation Instructions* supplied with this washer.

SYSTEM CLEAN

To clean and freshen the washer, perform the **SYSTEM CLEAN** cycle. If you wish to begin the cycle, press **select** when prompted. This maintenance cycle uses hot water and two rinses to remove residue that may cause odor. See **Inside Routine Cleaning (Preventative)** for detailed information about the **SYSTEM CLEAN** cycle.

NOTE

The washer will automatically prompt you to run the **SYSTEM CLEAN** cycle every 50 cycles. You may press the **cancel** button to manually perform the cycle at another time.

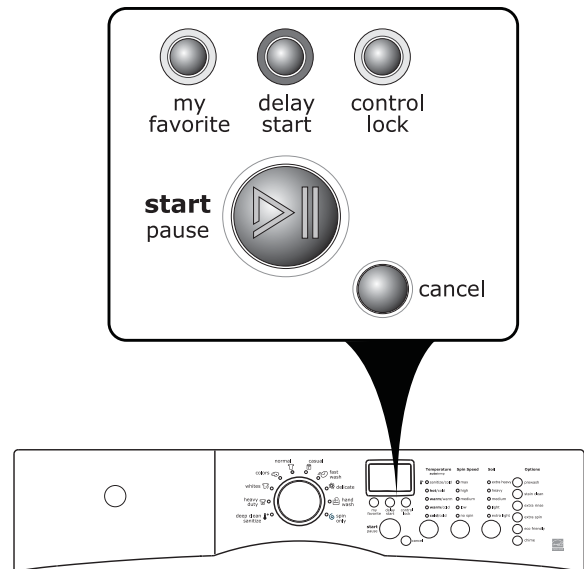

STATUS DISPLAY

The following will also be displayed at the appropriate times during the cycle:

DOOR LOCK	RINSING
PREWASHING	DRAINING
WASHING	SPINNING
ADDING STEAM	CYCLE COMPLETE

Washer Settings Chart

These **Temperature, Spin Speeds, Soil** levels and **Options** are available with the following cycles:

	deep clean sanitize 	heavy duty 	whites 	colors 	normal 	casual 	fast wash 	delicate 	hand wash 	spin only 
Estimated Cycle Duration**	144 min	57 min	52 min	31 min	52 min	31 min	18 min	31 min	31 min	08 min

Temperature

sanitize/cold	✓*									
hot/cold		✓	✓*		✓	✓	✓			
warm/warm		✓			✓		✓	✓	✓	
warm/cold		✓*		✓	✓*	✓*	✓*	✓	✓	
cold/cold		✓		✓*	✓	✓	✓	✓*	✓*	✓

Spin Speed

max	✓*	✓*	✓*	✓	✓*	✓	✓*	✓	✓	✓*
high	✓	✓	✓	✓*	✓	✓*	✓	✓	✓	✓
medium	✓	✓	✓	✓	✓	✓	✓	✓*	✓	✓
low	✓	✓	✓	✓	✓	✓	✓	✓	✓*	✓
no spin	✓	✓	✓	✓	✓	✓	✓	✓	✓	✓

Soil

extra heavy	✓	✓	✓	✓	✓	✓				
heavy	✓	✓	✓	✓	✓	✓				
medium	✓*	✓*	✓*	✓*	✓*	✓*	✓	✓*	✓*	
light			✓	✓	✓	✓	✓	✓	✓	
extra light			✓	✓	✓	✓	✓*	✓	✓	

Options

delay start	✓	✓	✓	✓	✓	✓	✓	✓	✓	✓
extra spin	✓	✓	✓	✓	✓	✓				
extra rinse	✓	✓	✓	✓	✓	✓		✓	✓	✓
prewash		✓	✓	✓	✓	✓				
eco friendly		✓	✓	✓	✓	✓	✓	✓	✓	
add steam (select models)	✓	✓	✓		✓	✓	✓			
stain clean (select models)		✓	✓	✓	✓	✓		✓		
chime	✓	✓	✓	✓	✓	✓	✓	✓	✓	✓

* Factory presets

✓ Available selections

**Estimated cycle duration is based on factory settings and does not include water fill times, out-of-balance, or oversudsing conditions.

Stain Removal Procedures

SAFE STAIN REMOVAL PROCEDURES

To reduce the risk of fire or serious injury to persons or property, comply with the basic warnings listed below:

- Read and comply with all instructions on stain removal products.
- Keep stain removal products in their original labeled containers and out of children's reach.
- Thoroughly wash any utensils used.
- Do not combine stain removal products, especially ammonia and chlorine bleach. Dangerous fumes can result.
- Never wash items which have been previously cleaned in, washed in, soaked in or spotted with gasoline, dry cleaning solvents or other flammable or explosive substances because they give off vapors that could ignite or explode.
- Never use highly flammable solvents, such as gasoline, inside the home. Vapors can explode on contact with flames or sparks.

FOR SUCCESSFUL STAIN REMOVAL:

- Remove stains promptly.
- Determine the kind of stain, then follow the recommended treatment in the stain removal chart on the next page.
- To pretreat stains, use a prewash product, liquid detergent, or a paste made from powder detergent and water.
- Use cold water on unknown stains because hot water can set stains.
- Consult care label instructions for treatments to avoid on specific fabrics.
- Check for colorfastness by testing stain remover products on an inside seam.
- Rinse and wash items after stain removal.



WARNING

HARMFUL VAPOR HAZARD

Do not use or mix liquid chlorine bleach with other household chemicals such as toilet cleaners, rust removers, acid or products containing ammonia. These mixtures can produce dangerous fumes which can cause serious injury or death.



For best results

Follow the fabric care label instructions on items to be washed.

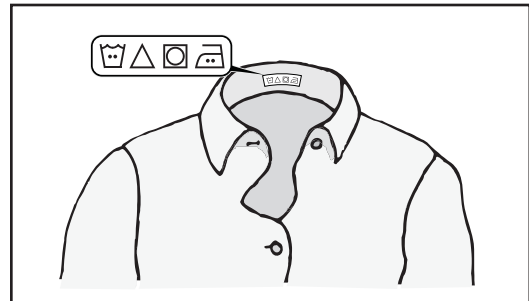

Stain Removal Suggestions

STAIN	TREATMENT
Adhesive tape, chewing gum, rubber cement	Apply ice. Scrape off excess. Place stain face down on paper towels. Saturate with prewash stain remover or nonflammable dry cleaning fluid.
Baby formula, dairy products, egg	Use product containing enzymes to pretreat or soak stains. Soak for 30 minutes or more. Wash.
Beverages (coffee, tea, soda, juice, alcoholic beverages)	Pretreat stain. Wash using cold water and bleach safe for fabric.
Blood	Rinse with cold water. Rub with bar soap. Or, pretreat or soak with product containing enzymes. Wash using bleach safe for fabric.
Candle wax, crayon	Scrape off surface wax. Place stain face down between paper towels. Press with warm iron until wax is absorbed. Replace paper towels frequently. Treat remaining stain with prewash stain remover or nonflammable dry cleaning fluid. Hand wash to remove solvent. Wash using bleach safe for fabric.
Chocolate	Pretreat or soak in warm water using product containing enzymes. Wash using bleach safe for fabric.
Collar or cuff soil, cosmetics	Pretreat with prewash stain remover or rub with bar soap.
Dye transfer on white fabric	Use packaged color remover. Wash using bleach safe for fabric.
Grass	Pretreat or soak in warm water using product containing enzymes. Wash using bleach safe for fabric.
Grease, oil, tar (butter, fats, salad dressing, cooking oils, car grease, motor oils)	Scrape residue from fabric. Pretreat. Wash using hottest water safe for fabric. For heavy stains and tar, apply nonflammable dry cleaning fluid to back of stain. Replace towels under stain frequently. Rinse thoroughly. Wash using hottest water safe for fabric.
Ink	Some inks may be impossible to remove. Washing may set some inks. Use prewash stain remover, denatured alcohol or nonflammable dry cleaning fluid.
Mildew, scorch	Wash with chlorine bleach if safe for fabric. Or, soak in oxygen bleach and hot water before washing. Badly mildewed fabrics may be permanently damaged.
Mud	Brush off dry mud. Pretreat or soak with product containing enzymes.
Mustard, tomato	Pretreat with prewash stain remover. Wash using bleach safe for fabric.
Nail polish	May be impossible to remove. Place stain face down on paper towels. Apply nail polish remover to back of stain. Repeat, replacing paper towels frequently. Do not use on acetate fabrics.
Paint, varnish	WATER BASED: Rinse fabric in cool water while stain is wet. Wash. Once paint is dry, it cannot be removed. OIL BASED AND VARNISH: Use solvent recommended on can label. Rinse thoroughly before washing.
Perspiration	Use prewash stain remover or rub with bar soap. Rinse. Wash using nonchlorine bleach in hottest water safe for fabric.
Rust, brown or yellow discoloration	Use rust remover safe for fabric. Do not use chlorine bleach because it may intensify discoloration.
Shoe polish	LIQUID: Pretreat with a paste of powder detergent and water. PASTE: Scrape residue from fabric. Pretreat with prewash stain remover or nonflammable dry cleaning fluid. Rinse. Rub detergent into dampened area. Wash using bleach safe for fabric.
Tomato	Pretreat with prewash stain remover. Wash using bleach safe for fabric.
Urine, vomit, mucus, feces	Pretreat or soak in product containing enzymes. Wash using bleach safe for fabric.
Wine	Pretreat or soak in cold water. Wash in hottest water and bleach safe for fabric

Inside Routine Cleaning (Preventative)

To help prevent odors, mold or mildew, leave the door open for a few hours after use, or whenever the washer is not in use.

⚠ CAUTION

ENTRAPMENT and TIP-OVER HAZARD
An open door could entice children to hang on the door or crawl inside the washer. If there are no small children present, you may leave the door ajar to prevent mildew and odor build up.

TO REFRESH OR CLEAN INSIDE OF WASHER

To clean and freshen the washer, perform the **SYSTEM CLEAN** cycle. For best results use the **SYSTEM CLEAN** cycle once a month. To begin the cycle, press **select** when prompted during automated reminder mode or manually select the cycle by following these directions:

1. Wake up the washer by pressing any button, rotate cycle knob to the **hand wash** cycle, press the **start** button and then the **cancel** button.
2. Wake up the washer again by pressing any button, then immediately and simultaneously press and hold both the **eco friendly** and **control lock** buttons for 5 seconds, or until the LCD display changes.

➡ IMPORTANT

Items left in washer while performing the **SYSTEM CLEAN** cycle will cause a severe out-of-balance situation that could damage the washing machine.

If installed, remove the “**MAIN WASH - LIQUID ONLY**” cup from the dispenser. **REMOVE ALL ITEMS FROM WASH DRUM** before filling the “**MAIN WASH**” detergent chamber with one (1) cup of liquid chlorine bleach **OR** one (1) pouch of TIDE® WASHING MACHINE CLEANER. **DO NOT** use both. Press **start** to begin.



For best results

Immediately follow up with a **Spin Only** cycle. Select **Extra Rinse** on **Max** spin speed with no detergent or bleach to help clear any residual bleach left after the **SYSTEM CLEAN** cycle.



NOTE

If the **SYSTEM CLEAN** cycle is cancelled or paused during the cycle, the washer will go through 2 rinse cycles to clean the drum of any residual bleach before unlocking the door.

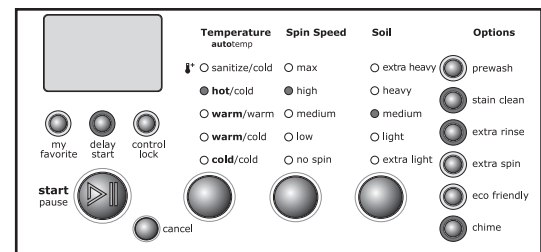
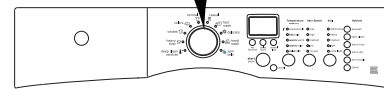
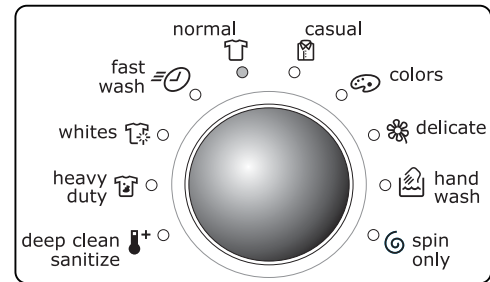

REMOVE “LIQUID ONLY”
DISPENSER CUP

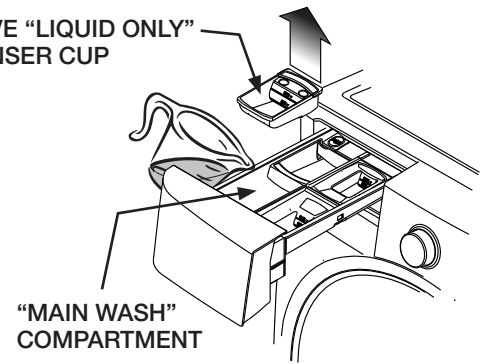

⚠ WARNING

HARMFUL VAPOR HAZARD

Do not use or mix liquid chlorine bleach with other household chemicals such as toilet cleaners, rust removers, acid or products containing ammonia. These mixtures can produce dangerous fumes which can cause serious injury or death.



Other Inside Routine Cleaning (Preventative)

CLEANING DISPENSER DRAWER AREA

NOTE

Detergent and fabric softener may build up in the dispenser drawer. Residue should be removed once or twice a month.

- Remove the drawer by pulling the drawer out until it stops.
- Reach back into the left rear corner of the drawer cavity and press down firmly on the lock tab. Pull out the drawer.
- Remove the insert from the prewash, bleach, and fabric softener compartments.
- Rinse the drawer and inserts with hot tap water to remove traces of accumulated powders and liquids. Large amounts of fabric softener residue may indicate improper dilution or more frequent cleaning is required.
- To clean the drawer opening, use a small brush to clean the recess. Remove all residue from the upper and lower parts of the recess.
- Replace the insert by pressing it in place until you hear a slight click. Return the dispenser drawer.

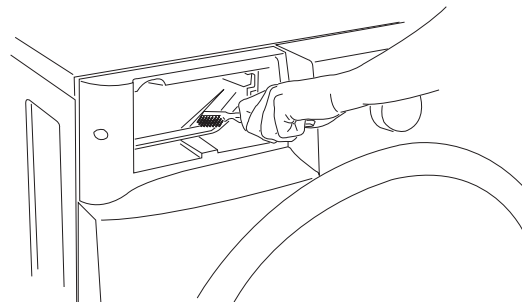
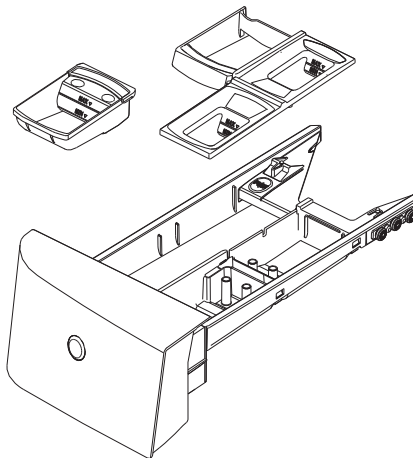
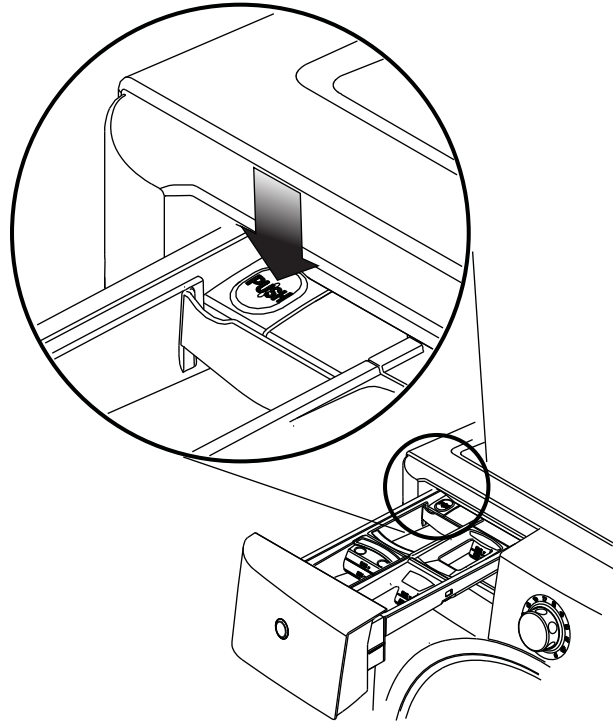

DAILY PREVENTATIVE MAINTENANCE

- Remove items from the washer as soon as the cycle ends. Excess wrinkling, color transfer, and odors may develop in items left in the washer.
- If there are no small children or pets present, you may leave the door ajar when the washer is not in use.
- Leave the dispenser drawer open slightly at the end of the wash day.
- Dry around the washer door opening, flexible gasket, and door glass. These areas should always be clean to ensure a water tight seal.
- When extremely soiled items have been washed, a dirty residue may remain on the drum. Remove this by wiping the drum with a nonabrasive household cleanser. Rinse thoroughly with water.
- Periodically, wipe dry the folds in the bottom of the flexible gasket to remove lint and other debris.

Inside Cleaning (Aggressive)

In cases where **SYSTEM CLEAN** cycle along with care and cleaning of rubber gasket folds isn't done, and severe odor, mold, mildew, or residue buildup have developed, follow the below cleaning procedure to help alleviate the problem.

CLEANING PROCEDURE - Washer Drum

Ensure the wash tub is empty (or no clothes load). Open the detergent drawer and pour eight (8) cups of bleach into the "MAIN WASH" detergent compartment. Select **SYSTEM CLEAN** cycle as described previously in *Inside Routine Cleaning (Preventative)*.

Upon cycle completion inspect the interior of the washer to see if the odor/residue has been eliminated. If any additional cleaning is required, repeat the above procedure. This may take several cycles depending on the severity of the odor/residue. You may observe some remaining discoloration due to the long term effects of this residue.

For especially contaminated areas visible inside the drum (including the front rubber seal), these areas might be more effectively cleaned by spraying a Bleach Cleaner on a scrub brush, soft sponge, or towel and scrubbing.

➔ IMPORTANT

Always wear rubber or latex gloves and protect floor and clothing from damage.

If odor is still left after bleach cycle(s) and bleach cleaner, open the detergent drawer and pour one (1) pouch of TIDE® WASHING MACHINE CLEANER in detergent drawer. Select **SYSTEM CLEAN** cycle as above and start the washer.



For best results

Immediately follow up with a **Spin Only** cycle. Select **Extra Rinse** on **Max** spin speed with no detergent or bleach to help clear any residual bleach left after the **SYSTEM CLEAN** cycle.

➔ IMPORTANT

See *Inside Routine Cleaning (Preventative)* for future cleaning maintenance which is necessary to avoid repeating issues.



NOTE

If the **SYSTEM CLEAN** cycle is cancelled or paused during the cycle, the washer will go through 2 rinse cycles to clean the drum of any residual bleach before unlocking the door.

REMOVE "LIQUID ONLY"
DISPENSER CUP

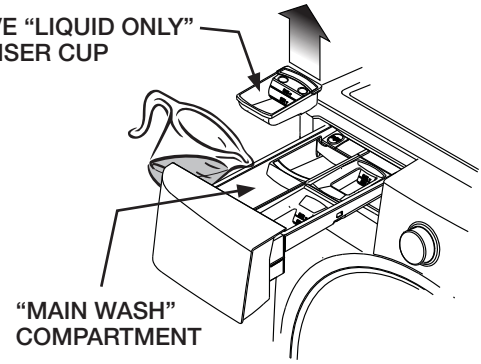

"MAIN WASH"
COMPARTMENT



WARNING

HARMFUL VAPOR HAZARD

Do not use or mix liquid chlorine bleach with other household chemicals such as toilet cleaners, rust removers, acid or products containing ammonia. These mixtures can produce dangerous fumes which can cause serious injury or death.



Outside Routine Cleaning

- When washing is completed, wipe top and sides of washer with a damp cloth. Turn water faucets off to prevent pressure build-up in the hoses.
- Clean the cabinet with mild soap and water. Never use harsh, gritty or abrasive cleansers
- If the cabinet becomes stained, clean with diluted chlorine bleach (1 part bleach to 8 parts water). Rinse several times with clear water.
- Remove glue residue from tape or labels with a mixture of warm water and mild detergent. Or, touch residue with the sticky side of tape.
- When cleaning chrome parts use a window cleaner with ammonia or mild soap and water.
- Before moving the washer, place a strip of cardboard or thin fiberboard under the front leveling legs to prevent damage to the floor.

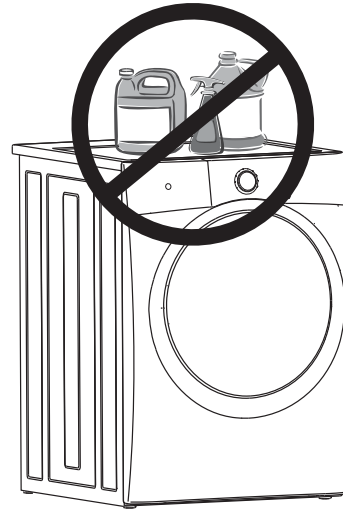

➔ IMPORTANT

Do not store or place laundry products on top of washer at any time. They can damage the finish or controls.

Winterizing Instructions

➔ IMPORTANT

If the washer is stored in an area where freezing can occur or moved in freezing temperatures, follow these winterizing instructions to prevent damage to the washer:

1. Turn off water supply faucets.
2. Disconnect hoses from water supply and drain water from hoses. Vacuum out each water supply inlet with a waterproof utility vac to ensure water valves are completely drained. Damage will occur if water in water inlet valves are allowed to freeze.
3. Plug electrical cord into a properly grounded electrical outlet.
4. Add 1 gallon (3.8 L) nontoxic recreational vehicle (RV) antifreeze to empty wash drum. Close door.
5. Select the **spin only** cycle. Press **start** and let the washer drain for 1 minute to drain out all the water. Not all of the RV antifreeze will be expelled.
6. Press **cancel**, unplug electrical power cord, dry off drum interior and close door.
7. Remove dispenser drawer. Drain any water in compartments and dry compartments. Replace drawer.
8. Store washer in an upright position.
9. To remove antifreeze from washer after storage, run empty washer through a complete cycle using detergent. Do not add wash load.



Follow **WINTERIZING INSTRUCTIONS** for cold weather storage and care.



Common Washing Problems

Many washing problems involve poor soil and stain removal, residues of lint and scum, and fabric damage. For satisfactory washing results, follow these suggestions provided by The Soap and Detergent Association.

PROBLEM	POSSIBLE CAUSES	SOLUTIONS	PREVENTIVE MEASURES
Blue stains	<ul style="list-style-type: none"> • Undiluted liquid detergent or fabric softener dispensed directly onto fabric. 	<ul style="list-style-type: none"> • If caused by detergent, mix 1 cup (240 ml) white vinegar with 1 quart (.95 L) water in a plastic container. Soak item 1 hour. Rinse. • If caused by fabric softener, rub stains with bar soap. Wash. 	<ul style="list-style-type: none"> • Avoid overfilling detergent and fabric softener compartments of dispenser.
Discoloration, graying	<ul style="list-style-type: none"> • Not enough detergent. • Wash water temperature too low. • Incorrect sorting. 	<ul style="list-style-type: none"> • Rewash with correct amount of detergent and hottest water safe for fabric. • Add bleach safe for fabric. 	<ul style="list-style-type: none"> • Sort items by soil level and color. • Use correct amount of detergent, hottest water and bleach safe for fabric.
Greasy, oily stains	<ul style="list-style-type: none"> • Not enough detergent. • Undiluted liquid fabric softener poured directly on fabric. 	<ul style="list-style-type: none"> • Treat with prewash stain remover or liquid detergent. • Increase detergent and water temperature. Rewash. • Rub fabric softener stains with bar soap. 	<ul style="list-style-type: none"> • Use correct amount of detergent and hottest water safe for fabric. • Do not pour liquid fabric softener directly on fabric. See Operating Your, step 5.
Holes, tears, or snags	<ul style="list-style-type: none"> • Incorrect use of chlorine bleach. • Unfastened zippers, hooks, buckles. • Rips, tears and broken threads. • Overloading the washer. • Degradation of fabric. 	<ul style="list-style-type: none"> • May be irreversible if rips, tears and seams cannot be mended. 	<ul style="list-style-type: none"> • Never pour chlorine bleach directly on fabric. • Check condition of items before washing. See Operating Your, steps 2 and 5.
Lint	<ul style="list-style-type: none"> • Incorrect sorting. • Tissues left in pocket. • Overloading the washer. • Not enough detergent. • Undissolved detergent has left a residue resembling lint. • Static cling is attracting lint. • Load washed too long. 	<ul style="list-style-type: none"> • Reduce load size. Rewash using correct water temperature, water level, and amount of detergent. • Add nonprecipitating water conditioner to wash water to remove detergent residue. • Add liquid fabric softener to final rinse. • Dry load in dryer. • Remove lint with lint brush or roller. 	<ul style="list-style-type: none"> • See Operating Your, steps 1 and 2. • Do not overload washer. • Use correct temperature and amount of detergent, water and wash time.
Pilling (Fibers ball up and cling to fabric.)	<ul style="list-style-type: none"> • Pilling is normal with synthetic and permanent press fabrics. This is due to abrasion from normal wear. 	<ul style="list-style-type: none"> • Use a lint brush or shaver to remove pills. 	<ul style="list-style-type: none"> • Use fabric softener in the washer to lubricate fibers. • When ironing, use spray starch or fabric finish on collars and cuffs. • Turn items inside out to reduce abrasion.
Residue or powder on dark items; Stiff, harsh fabrics.	<ul style="list-style-type: none"> • Undissolved detergent. • Some granular detergents can combine with hard water minerals to form a residue. • Overloading the washer. 	<ul style="list-style-type: none"> • Rewash load. 	<ul style="list-style-type: none"> • Increase water temperature using hottest water safe for fabric. • Do not overload washer. • Use liquid detergent or use nonprecipitating water conditioner with powder detergent.
Wrinkling	<ul style="list-style-type: none"> • Overloading the washer. • Incorrect wash cycle for wash load. 	<ul style="list-style-type: none"> • Reduce load size. • Rinse in cold water with liquid fabric softener using the casual or delicate cycle. 	<ul style="list-style-type: none"> • Do not overload washer. • Remove items from washer as soon as cycle is completed. • Use liquid fabric softener.

Common Washing Problems, continued

PROBLEM	POSSIBLE CAUSES	SOLUTIONS	PREVENTIVE MEASURES
Yellow buildup of body soil on synthetic fabrics	<ul style="list-style-type: none"> • Agitation time too short. • Wash water temperature too low. • Not enough detergent. 	<ul style="list-style-type: none"> • Soak in detergent booster or product containing enzymes. • Wash in hottest water safe for fabric using casual cycle. • Increase detergent. • Add bleach safe for fabric or treat with color remover. 	<ul style="list-style-type: none"> • Select correct wash cycle. • Use correct amount of detergent. • Wash synthetics frequently using hot or warm water.
Yellow or brown rust stains	<ul style="list-style-type: none"> • Iron or manganese in water supply, water pipes, or water heater. 	<ul style="list-style-type: none"> • To restore discolored load of whites, use rust remover safe for fabric. • Do not use chlorine bleach to remove rust stains. It may intensify discoloration. 	<ul style="list-style-type: none"> • Use nonprecipitating water softener. • Before washing, run hot water for a few minutes to clear lines. • Drain water heater occasionally. • For an ongoing problem, install an iron filter in your water supply system.
Residue stains / build-up, mold or mildew stains in gasket	<ul style="list-style-type: none"> • Moisture in the washer. • Use of non-HE detergent. • Overdosing detergent. • Overloading wash drum. • Leaving a wet load set in washer. • Cold water washes which may not completely dissolve and remove detergents. 	<ul style="list-style-type: none"> • Perform SYSTEM CLEAN cycle • Scrub gasket with Comet™ Spray Gel Mildew Stain Remover using brush to remove stains. • Use only HE (high efficiency detergent) along with recommended dosage. • Remove wash load immediately upon cycle completion. 	<ul style="list-style-type: none"> • Run dehumidifier in laundry room. • Avoid overfilling detergent and fabric softener compartments of dispenser. • Dry the inside of washer and gasket after every run.
Residue stains / build-up, mold or mildew stains in dispenser drawer	<ul style="list-style-type: none"> • Moisture in the washer. • Use of non-HE detergent. • Overdosing detergent. 	<ul style="list-style-type: none"> • Remove dispenser drawer and wipe dispenser and inserts with combination of ¾ cup liquid chlorine bleach and one gallon hot water. Rinse well, and repeat if necessary. Return drawer to location. NOTE: Wear rubber of latex gloves. Protect floor and clothing from bleach damage. • Use only HE (high efficiency detergent) along with recommended dosage. 	<ul style="list-style-type: none"> • Avoid overfilling detergent and fabric softener compartments of dispenser.
Water in fold of flexible gasket	<ul style="list-style-type: none"> • Result of washing and part of normal operation. 	<ul style="list-style-type: none"> • At the end of each wash, dry inside of gasket fold with clean dry towel all around gasket. 	
Odor	<ul style="list-style-type: none"> • Moisture in the washer. • Use of non-HE detergent. • Overdosing detergent. • Leaving a wet load remain in washer. • Cold water washes which may not completely dissolve and remove detergents. 	<ul style="list-style-type: none"> • Perform SYSTEM CLEAN cycle. • At the end of each wash, dry inside of gasket fold with clean, dry towel all around gasket. • Use only HE (high efficiency detergent) along with recommended dosage. • Remove wash load immediately upon cycle completion. • Pour one cup liquid chlorine bleach in standpipe; let remain a day and flush with water. 	<ul style="list-style-type: none"> • Leave door and dispenser drawer open for a few hours after use or whenever washer is not in use.

Service Prevention Checklist

Before calling for service, review this list. It may save both time and expense. The list includes common occurrences that are not the result of defective workmanship or materials in this washer.

OCCURRENCE	POSSIBLE CAUSE	SOLUTION
NOISE		
High pitch “jet engine” noise.	A certain amount of motor whine is normal during the spin cycle.	
Rattling and clanking noise.	Foreign objects such as coins or safety pins may be in drum or pump.	Stop washer and check drum. If noise continues after washer is restarted, objects may be in pump. Call your authorized servicer.
	Belt buckles and metal fasteners are hitting wash drum.	To prevent unnecessary noise and damage to drum, fasten fasteners and turn items inside out.
Thumping sound.	Heavy wash loads may produce a thumping sound. This is usually normal. If sound continues, washer is probably out of balance.	Stop washer and redistribute wash load.
Vibrating noise.	Washer is not resting firmly on floor.	Move washer so it rests firmly on floor. Adjust leveling legs. See INSTALLATION INSTRUCTIONS for details.
	Shipping bolts and foam block have not been removed during installation.	See INSTALLATION INSTRUCTIONS for removing shipping bolts and foam block.
	Wash load unevenly distributed in drum.	Stop washer and rearrange wash load.
OPERATING		
Washer does not start.	Electrical power cord may not be plugged in or connection may be loose.	Make sure plug fits tightly in wall outlet.
	House fuse blown, circuit breaker tripped, or a power outage has occurred.	Reset circuit breaker or replace fuse. Do not increase fuse capacity. If problem is a circuit overload, have it corrected by a qualified electrician. If problem is a power outage, call local electric company.
	Water supply faucets are not turned on.	Turn on water supply faucets.
	Motor is overheated. Washer motor will stop if it becomes overheated.	It will automatically restart after a cool down period of up to 30 minutes (if washer has not been manually turned off).
	Washer door is not completely closed.	Close door completely.
Washer won't spin.	Load is too small.	Add 1 or 2 similar items to help balance the load.
Residue left in drum.	Heavily soiled items.	Wipe drum with a nonabrasive household cleanser, then rinse. Shake or brush excess dirt and sand from items before washing
LCD displays DEMO MODE .	Washer has been programmed to temporarily perform a repeating demo cycle.	To return to the factory default settings, select RESET in set prefs under the options scroll buttons.
Door hesitates to open after pressing Touch-2-Open latch.	Water on bellows may have dried, leaving residue on door glass during extended non-use or vacation.	Clean residue from door glass and wipe front of bellows opening with warm water and soap.
		If issue persists, wipe front of bellows opening with Lemon Pledge® spray or wipes.

Avoid Service Checklist, continued

OCCURRENCE	POSSIBLE CAUSE	SOLUTION
WATER		
Water collects in folds of the bellows at the end of the cycle.	This is a result of the washing action and is part of the normal operation of the washer.	
Water collects in bleach and fabric softener compartments.	This is a result of the siphoning action and is part of the normal operation of the washer.	Water may be removed by removing the dispenser drawer (see Care and Cleaning in this guide) and draining water into the empty drum or sink.
Wash load too wet after spin.	Washer is overloaded.	Do not overload washer. See Operating Your Washer, step 4.
	Load is too small.	Add 1 or 2 similar items to help balance the load.
	Load is out of balance.	Rearrange load to allow proper spinning.
	Drain hose is kinked.	Straighten drain hose.
Water does not enter washer or it enters slowly.	Water supply is not adequate in area.	Check another faucet in the house. Wait until water supply and pressure increase.
	Water supply faucets are not completely open.	Fully open hot and cold faucets.
	Water is being used elsewhere in the house. Water pressure must be at least 30 psi (260 kPa).	Avoid running water elsewhere while washer is filling.
	Water inlet hoses are kinked.	Straighten hoses.
Warm or hot water is not hot enough.	Hot water heater is set too low or is a distance from washer.	Measure hot water temperature at nearby faucet with candy or meat thermometer. Water temperature should be at least 120°F (49°C). Adjust water heater as necessary.
	Hot water is being used elsewhere in the house.	Avoid using hot water elsewhere before or during washer use. There may not be enough hot water available for proper cleaning. If problem persists, your hot water system may be unable to support more than 1 use at a time.
Water in washer does not drain or drains slowly.	Drain hose is kinked or clogged.	Clean and straighten the drain hose.
	Drain hose standpipe is too tall. Maximum standpipe height is 8' (2.4 m).	Reduce standpipe height to less than 8' (2.4 m). See INSTALLATION INSTRUCTIONS.
	House drain pipes are clogged.	Unclog drain pipes. Contact plumber if necessary.
Water leaks.	Fill hose connection is loose at faucet or washer.	Check and tighten hose connections. Install rubber sealing washers provided.
Oversudsing.	Wrong detergent.	Run rinse cycle. Use a low-sudsing, high efficiency detergent.
	Too much detergent.	Run rinse cycle. Use less detergent in future loads.
Incorrect wash and rinse temperatures.	Hot and cold water hoses are connected to wrong supply faucets.	Connect hot water hose to hot water faucet and cold water hose to cold water faucet.
Water is entering washer but tub does not fill.	Drain hose standpipe is too low. Standpipe must be a minimum of 23.6" (60 cm) high to prevent siphoning.	Increase standpipe height to at least 23.6" (60 cm). See INSTALLATION INSTRUCTIONS.

Your appliance is covered by a one year limited warranty. For one year from your original date of purchase, Electrolux will repair or replace any parts of this appliance that prove to be defective in materials or workmanship when such appliance is installed, used, and maintained in accordance with the provided instructions. In addition, your appliance is covered by an additional one year, parts only, limited warranty. During the 2nd year from your original date of purchase, Electrolux will pay for parts needed for this appliance that have proven to be defective in materials or workmanship when your appliance is installed, used, and maintained in accordance with the provided instructions.

Exclusions

This warranty does not cover the following:

1. Products with original serial numbers that have been removed, altered or cannot be readily determined.
2. Product that has been transferred from its original owner to another party or removed outside the USA or Canada.
3. Rust on the interior or exterior of the unit.
4. Products purchased "as-is" are not covered by this warranty.
5. Products used in a commercial setting.
6. Service calls which do not involve malfunction or defects in materials or workmanship, or for appliances not in ordinary household use or used other than in accordance with the provided instructions.
7. Service calls to correct the installation of your appliance or to instruct you how to use your appliance.
8. Expenses for making the appliance accessible for servicing, such as removal of trim, cupboards, shelves, etc., which are not a part of the appliance when it is shipped from the factory.
9. Service calls to repair or replace appliance light bulbs, air filters, water filters, other consumables, or knobs, handles, or other cosmetic parts.
10. Pickup and delivery costs; your appliance is designed to be repaired in the home.
11. Surcharges including, but not limited to, any after hour, weekend, or holiday service calls, tolls, ferry trip charges, or mileage expense for service calls to remote areas, including the state of Alaska.
12. Damages to the finish of appliance or home incurred during transportation or installation, including but not limited to floors, cabinets, walls, etc.
13. Damages caused by: services performed by unauthorized service companies; use of parts other than genuine Electrolux parts or parts obtained from persons other than authorized service companies; or external causes such as abuse, misuse, inadequate power supply, accidents, fires, or acts of God.

DISCLAIMER OF IMPLIED WARRANTIES; LIMITATION OF REMEDIES

CUSTOMER'S SOLE AND EXCLUSIVE REMEDY UNDER THIS LIMITED WARRANTY SHALL BE REPAIR OR REPLACEMENT AS PROVIDED HEREIN. **CLAIMS BASED ON IMPLIED WARRANTIES, INCLUDING WARRANTIES OF MERCHANTABILITY OR FITNESS FOR A PARTICULAR PURPOSE, ARE LIMITED TO ONE YEAR OR THE SHORTEST PERIOD ALLOWED BY LAW, BUT NOT LESS THAN ONE YEAR.** ELECTROLUX SHALL NOT BE LIABLE FOR CONSEQUENTIAL OR INCIDENTAL DAMAGES SUCH AS PROPERTY DAMAGE AND INCIDENTAL EXPENSES RESULTING FROM ANY BREACH OF THIS WRITTEN LIMITED WARRANTY OR ANY IMPLIED WARRANTY. SOME STATES AND PROVINCES DO NOT ALLOW THE EXCLUSION OR LIMITATION OF INCIDENTAL OR CONSEQUENTIAL DAMAGES, OR LIMITATIONS ON THE DURATION OF IMPLIED WARRANTIES, SO THESE LIMITATIONS OR EXCLUSIONS MAY NOT APPLY TO YOU. THIS WRITTEN WARRANTY GIVES YOU SPECIFIC LEGAL RIGHTS. YOU MAY ALSO HAVE OTHER RIGHTS THAT VARY FROM STATE TO STATE.

If You Need Service

Keep your receipt, delivery slip, or some other appropriate payment record to establish the warranty period should service be required. If service is performed, it is in your best interest to obtain and keep all receipts. Service under this warranty must be obtained by contacting Electrolux at the addresses or phone numbers below.

This warranty only applies in the USA, Puerto Rico and Canada. In the USA and Puerto Rico, your appliance is warranted by Electrolux Major Appliances North America, a division of Electrolux Home Products, Inc. In Canada, your appliance is warranted by Electrolux Canada Corp. Electrolux authorizes no person to change or add to any obligations under this warranty. Obligations for service and parts under this warranty must be performed by Electrolux or an authorized service company. Product features or specifications as described or illustrated are subject to change without notice.

USA

1-877-435-3287

Electrolux Major Appliances North America
North America
P.O. Box 212378
Augusta, GA 30907

Canada

1-800-265-8352

Electrolux Canada Corp.
5855 Terry Fox Way
Mississauga, Ontario, Canada
L5V 3E4