

**FUJIFILM**

DIGITAL CAMERA

# *FinePix F401*



**digital**  
Tools for the imagination.

**Exif Print**



Getting Ready

**1**

Basic Photography

**2**

Advanced Features  
Photography

**3**

Advanced Features  
Playback

**4**

Settings

**5**

Connection

**6**

**OWNER'S MANUAL**

This manual will show you how to use your FUJIFILM DIGITAL CAMERA FinePix F401 correctly. Please follow the instructions carefully.

BL00156-200 (1)



# Warning

To prevent fire or shock hazard, do not expose the unit to rain or moisture.

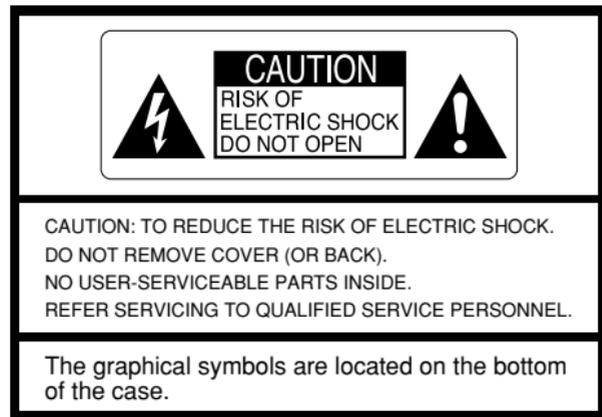

This symbol is intended to alert the user to the presence of uninsulated “dangerous voltage” within the product’s enclosure that may be of sufficient magnitude to constitute a risk of electric shock to persons.



This symbol is intended to alert the user to the presence of important operating and maintenance (servicing) instructions in the literature accompanying the appliance.

## For customers in the U.S.A.

### FCC Statement

This device complies with part 15 of the FCC Rules. Operation is subject to the following two conditions: (1) This device may not cause harmful interference, and (2) this device must accept any interference received, including interference that may cause undesired operation.

## CAUTION

This equipment has been tested and found to comply with the limits for a Class B digital device, pursuant to Part 15 of the FCC Rules. These limits are designed to provide reasonable protection against harmful interference in a residential installation. This equipment generates, uses, and can radiate radio frequency energy and, if not installed and used in accordance with the instructions, may cause harmful interference to radio communications. However, there is no guarantee that interference will not occur in a particular installation. If this equipment does cause harmful interference to radio or television reception, which can be determined by turning the equipment off and on, the user is encouraged to try to correct the interference by one or more of the following measures:

- Reorient or relocate the receiving antenna.
- Increase the separation between the equipment and receiver.
- Connect the equipment into an outlet on a circuit different from that to which the receiver is connected.

— Consult the dealer or an experienced radio/TV technician for help.

You are cautioned that any changes or modifications not expressly approved in this manual could void the user’s authority to operate the equipment.

### Notes on the Grant:

To comply with Part 15 of the FCC rules, this product must be used with a Fujifilm-specified ferrite-core USB cable and DC supply cord.

## For customers in Canada

### CAUTION

This Class B digital apparatus complies with Canadian ICES-003.

**Please read the Safety Notes (→P.108) and make sure you understand them before using the camera.**

# Contents

Warning .....	2
Preface .....	6
Camera Features and Accessories .....	7
Nomenclature/Attaching the strap .....	8

## 1 Getting Ready

LOADING THE BATTERY AND SmartMedia™ .....	11
CHARGING THE BATTERY .....	14
Using the AC Power Adapter .....	14
SWITCHING ON AND OFF • .....	
SETTING THE DATE AND TIME .....	15
Changing the date and time .....	17

## 2 Basic Photography

BASIC OPERATION GUIDE .....	18
<b>MODE</b> .....	
TAKING PICTURES (A AUTO MODE) .....	21
Viewfinder Lamp Display .....	25
Number of Available Frames .....	26
USING AF/AE LOCK .....	27
FRAMING GUIDELINE FUNCTION .....	29

### MODE

USING THE ZOOM .....	30
----------------------	----

### MODE

4    MACRO (CLOSE-UP) PHOTOGRAPHY .....	31
---	----

FLASH .....	32
Auto Flash Mode (no icon) .....	32
Red-Eye Reduction .....	33
Forced Flash .....	33
Suppressed Flash .....	34
Slow Synchro .....	34

### MODE

VIEWING YOUR IMAGES (PLAYBACK) .....	35
Fast Forwarding Images .....	35
MULTI-FRAME PLAYBACK .....	36
PLAYBACK ZOOM .....	37
Saving Trimmed Images .....	38
ERASING SINGLE FRAME .....	39

## 3 Advanced Features Photography

### MODE

SELECTING A AUTO OR M MANUAL .....	41
PHOTOGRAPHY MENU OPERATION/ PHOTOGRAPHY MENU OPTIONS .....	42

### PHOTOGRAPHY MENU

SETTING QUALITY MODE (NO. OF RECORDED PIXELS FOR STILL IMAGES) .....	44
SELF-TIMER PHOTOGRAPHY .....	45
CONTINUOUS SHOOTING .....	47
Top 4-frame Continuous Shooting .....	48
Final 4-frame Continuous Shooting .....	48

SENSITIVITY .....	49
EV (EXPOSURE COMPENSATION) .....	50
WHITE BALANCE (SELECTING THE LIGHT SOURCE) .....	51

### MODE

MOVIE (VIDEO) .....	52
Resolution settings for movies .....	55

## 4 Advanced Features Playback

### MODE

PLAYING BACK MOVIES (VIDEO) .....	56
-----------------------------------	----

### PLAYBACK MENU

ERASING SINGLE • ALL FRAMES/ FORMATTING .....	58
PROTECTING IMAGES FRAME/ALL .....	62
HOW TO SPECIFY PRINT OPTIONS (DPOF) ...	66
DPOF SET FRAME .....	67
RECORDING VOICE MEMOS .....	71

### MODE

PLAYING BACK VOICE MEMOS .....	74
--------------------------------	----

## 5 Settings

ADJUSTING THE MONITOR BRIGHTNESS .....	76
ADJUSTING THE VOLUME .....	77
USING SET-UP .....	78
SET-UP Menu Options (Date/time setting, etc.) ...	79

### SET-UP

POWER SAVE .....	80
------------------	----

## 6 Connection

IN CONNECTION .....	81
CONNECTING AT DSC MODE .....	82
CONNECTING AT PC CAMERA MODE .....	84
DISCONNECTING FROM THE PC (Important — always use this procedure.) .....	86

System Expansion Options .....	88
Accessories Guide .....	89
Notes on Using Your Camera Correctly .....	91
Notes on the Power Supply .....	92
Notes on Using the Battery (NP-60) .....	92
AC Power Adapter .....	94
Notes on the SmartMedia™ .....	95
Warning Displays .....	97
Troubleshooting .....	100
Explanation of Terms .....	103
Specifications .....	105
Safety Notes .....	108
EC Declaration of Conformity .....	111

# Preface

## ■ Test Shots Prior to Photography

For particularly important photographs (such as weddings and overseas trips), always take a test photograph and view the image to make sure that the camera is functioning normally.

- Fuji Photo Film Co., Ltd. cannot accept liability for any incidental losses (such as the costs of photography or the loss of income from photography) incurred as a result of faults with this product.

## ■ Notes on Copyright

Images recorded using your digital camera system cannot be used in ways that infringe copyright laws without the consent of the owner, unless intended only for personal use. Note that some restrictions apply to the photographing of stage performances, entertainments and exhibits, even when intended purely for personal use. Users are also asked to note that the transfer of memory cards containing images or data protected under copyright laws is only permissible within the restrictions imposed by those copyright laws.

## ■ Liquid Crystal

If the LCD monitor or display panel is damaged, take particular care with the liquid crystal in the monitor or panel. If any of the following situations arise, take the urgent action indicated.

- If liquid crystal comes in contact with your skin  
Wipe the area with a cloth and then wash thoroughly with running water and soap.
  - If liquid crystal gets into your eye  
Flush the affected eye with clean water for at least 15 minutes and then seek medical assistance.
  - If liquid crystal is swallowed
- 6** Flush your mouth thoroughly with water. Drink large

quantities of water and induce vomiting. Then seek medical assistance.

## ■ Notes on Electrical Interference

If the camera is to be used in hospitals or aircrafts, please note that this camera may cause interference to other equipment in the hospital or aircraft. For details, please check with the applicable regulations.

## ■ Handling Your Digital Camera

This camera contains precision electronic components. To ensure that images are recorded correctly, do not subject the camera to impact or shock while an image is being recorded.

## ■ Trademark Information

- IBM PC/AT is a registered trademark of International Business Machines Corp. of the U.S.A.
- iMac and Macintosh are registered trademarks of Apple Computer, Inc.
- Microsoft, Windows, and the Windows logo are trademarks, or registered trademarks of Microsoft Corporation in the United States and/or other countries. Windows is an abbreviated term referring to the Microsoft Windows Operating System.
- \* The "Designed for Microsoft Windows XP" logo refers to the camera and the driver only.
- SmartMedia is a trademark of Toshiba Corporation.
- Other company or product names are trademarks or registered trademarks of the respective companies.

## ■ Exif Print (Exif ver. 2.2)

Exif Print Format is a newly revised digital camera file format that contains a variety of shooting information for optimal printing.

# Camera Features and Accessories

## Camera Features

- 2.1 million effective pixels
- 1/2.7-inch Super CCD provides high quality images with 2304 × 1728 (4.0 million) recorded pixels
- High-performance 3× optical zoom
- Compact and lightweight aluminum-magnesium alloy body
- Quick, responsive operation with a 2.5-second startup and 1.3 seconds between shots.
- Auto focus with macro function
- Manual photography mode lets you set your own photography settings.
- High-sensitivity photography (Ⓜ mode only)
- Image checking function automatically plays back the image for about 2 seconds after you take a picture.
- Maximum 3.6× seamless digital zoom
- Playback zoom function (up to 14.4×)
- Continuous shooting function
- Movie shooting function (with sound)
- Voice Memo function for easy photography information recording
- 1.5-inches 114,000-pixels low-temperature polysilicon TFT LCD monitor
- Recharge or connect to your PC simply by placing the FinePix F401 in its cradle (sold separately)
- Easy high-speed image file transfer via the USB connection
- Conforms to "Design for Camera File system" standard and Exif ver 2.2 for digital cameras
  - \* "Design for Camera File system" standard and Exif format are formulated by the Japanese Electronic and Information Association (JEITA)

## Accessories

### ● SmartMedia (16MB, 3.3V) (1)

- Supplied with:
- Anti-static case (1)
  - Index label (1)

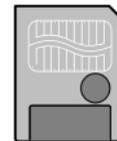

### ● NP-60 Rechargeable Battery (1)

Soft case included



### ● Strap (1)

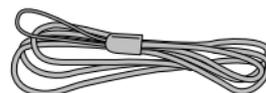

### ● AC-5VS/AC-5VHS AC Power Adapter (1)

Approx. 2 m (6.6 ft.) connection cord

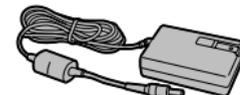

### ● USB Interface Set (1)

- CD-ROM: Software for FinePix EX (1)
- FinePix F401 Special USB cable with Noise Suppression core (1)
- Software Quick Start Guide (1)

### ● Owner's Manual (this manual) (1)

# Nomenclature

\* Refer to the pages in parentheses for information on using the camera features.

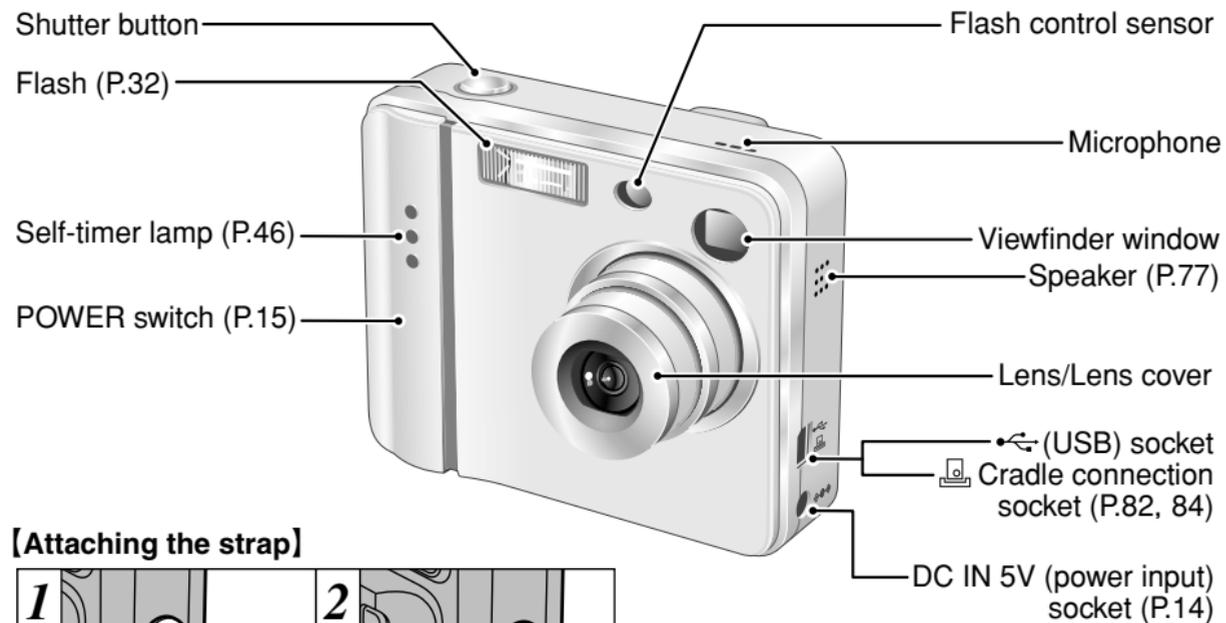

## Attaching the strap

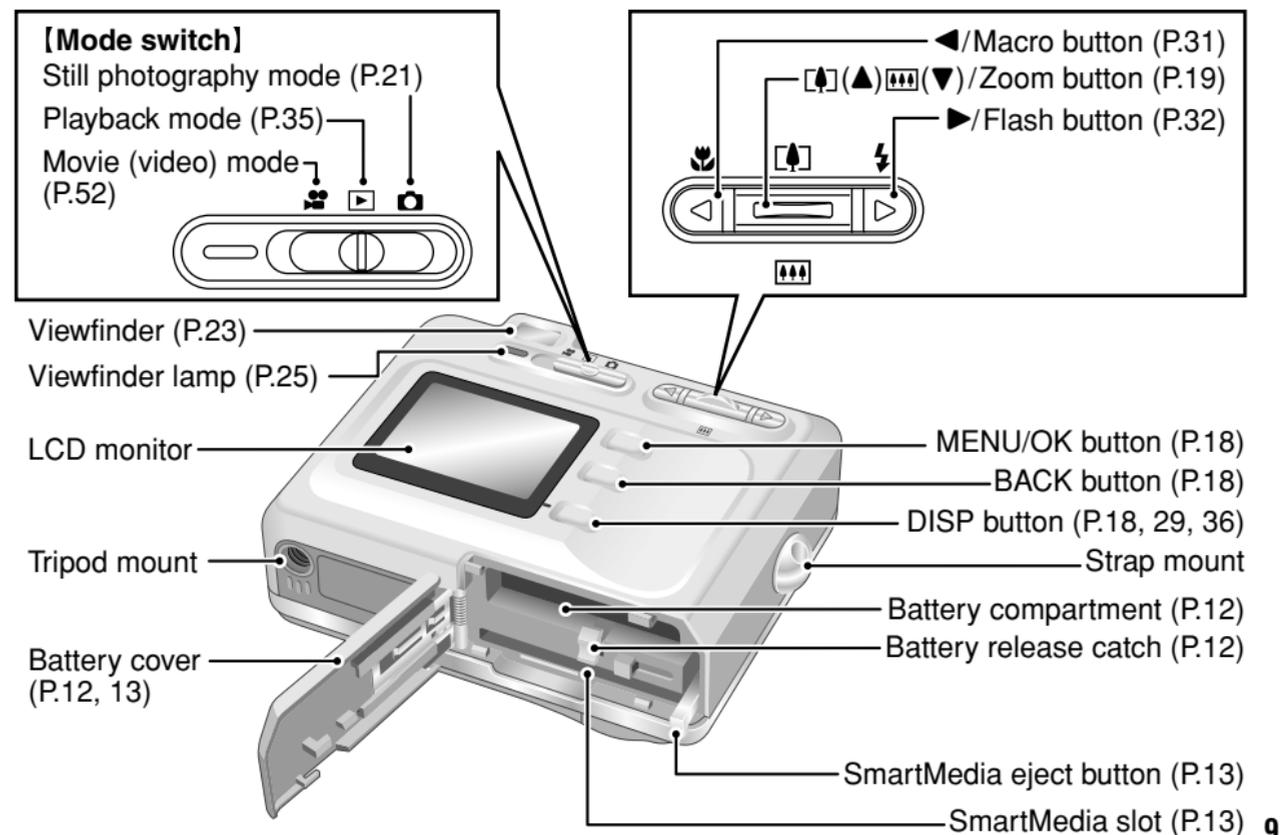
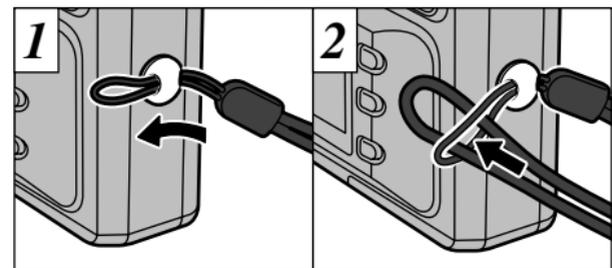

## Nomenclature (Sample display)

### Example of LCD Monitor Text Display: Still photography mode

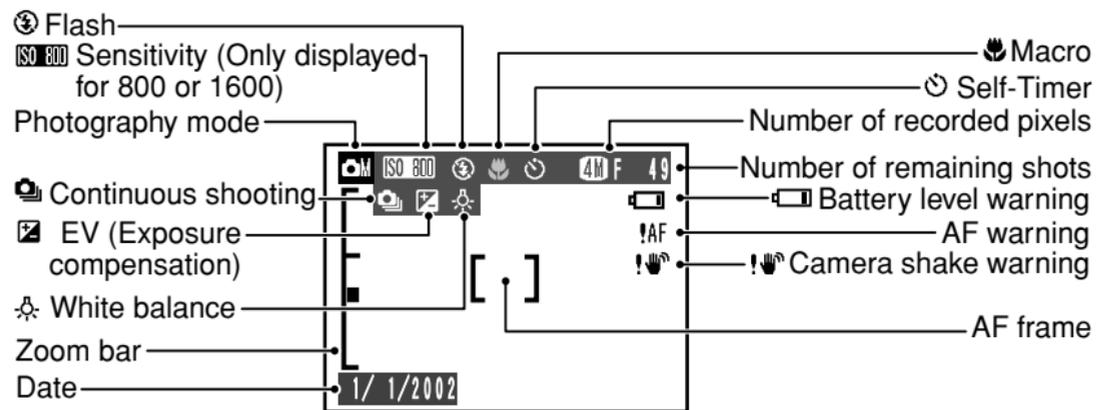

### Example of LCD Monitor Text Display: Playback mode

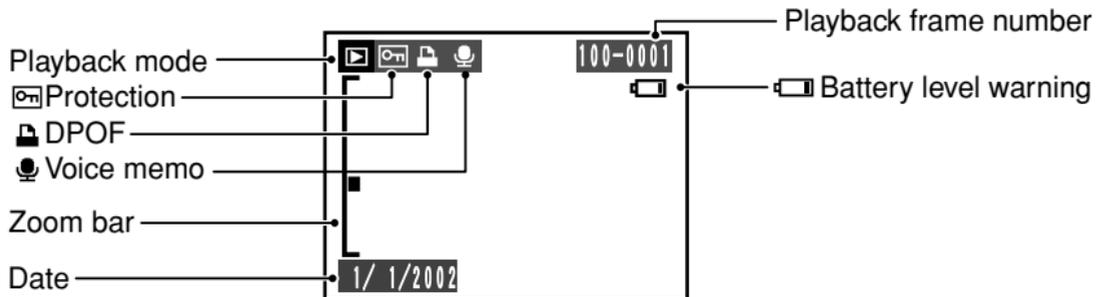

## 1 Getting Ready

## LOADING THE BATTERY AND SmartMedia™

### Compatible Batteries

Use only the special Rechargeable Battery NP-60. The use of other brands of rechargeable battery could cause faults or damage to the camera.

#### NP-60 Rechargeable Battery (1)

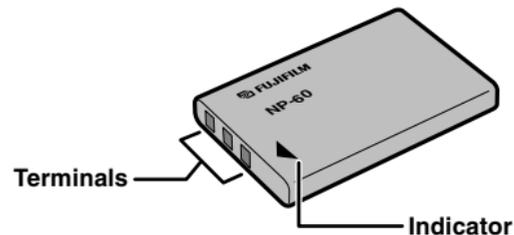

- ⚠ The battery is not fully charged at shipment and must be charged up before being used.
- ⚠ Do not stick labels onto the battery as this could cause the battery to become jammed inside the camera.
- ⚠ See P.92-93 for note on the battery.

### SmartMedia™ (sold separately)

#### Only use 3.3V SmartMedia

- MG-4S ( 4MB), MG-16SW ( 16MB, ID)
- MG-8S ( 8MB), MG-32SW ( 32MB, ID)
- MG-16S (16MB), MG-64SW ( 64MB, ID)
- MG-32S (32MB), MG-128SW (128MB, ID)
- MG-64S (64MB)

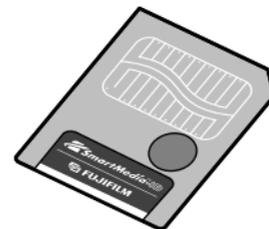

- ⚠ Image files cannot be recorded or erased if a write-protect sticker is affixed to the SmartMedia.
- ⚠ Operation of this camera is only guaranteed when it is used with FUJIFILM SmartMedia.
- ⚠ Some 3.3V SmartMedia are labelled as "3V" or "ID" cards.
- ⚠ See P.95-96 for note on SmartMedia.

## LOADING THE BATTERY AND SmartMedia™

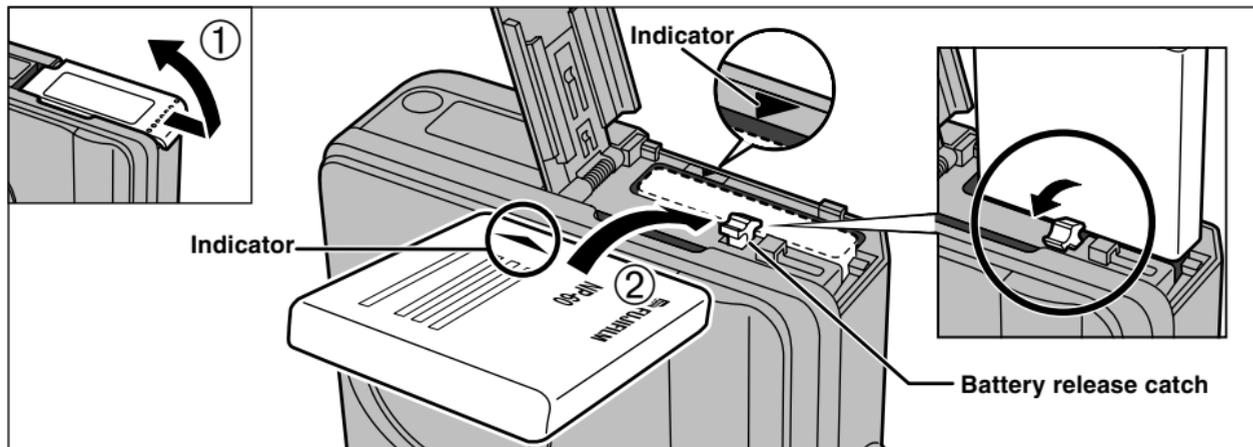

- 1 Slide the battery cover out to open it.
- 2 Hold the battery so that the arrow markings are aligned, use your finger to pull the battery release catch in the direction shown and insert the battery. Check that the battery is locked in place.

⚠ Do not apply excessive force to the battery cover.

Never open the battery cover while the camera is still switched on. This could damage the SmartMedia or corrupt the image files on the SmartMedia.

### ◆ To remove the battery ◆

Open the battery cover and pull the battery release catch in the direction indicated to release the battery.

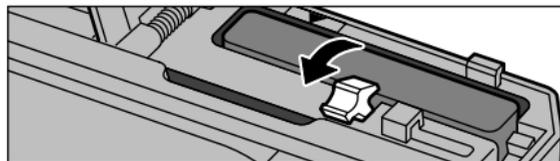

⚠ Always switch the camera off when removing the battery.

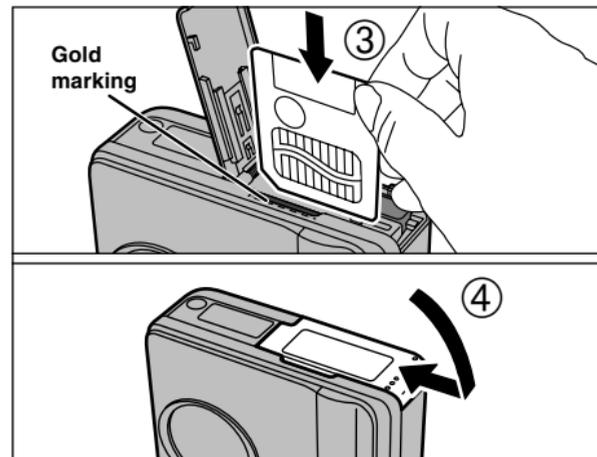

- 3 Align the contact area (the gold-colored section) on the SmartMedia with the gold marking on the SmartMedia slot and firmly push the SmartMedia all the way into the slot.
- 4 Close the battery cover.

- ⚠ If you open the battery cover while the camera is switched on, the camera automatically switches off to protect the data on the SmartMedia.
- ⚠ The SmartMedia will not slide fully into the slot if it is inserted facing the wrong way. Be careful not to apply undue force to the SmartMedia.
- ⚠ To protect the SmartMedia, always store it in the special anti-static case.

### ◆ To remove the SmartMedia ◆

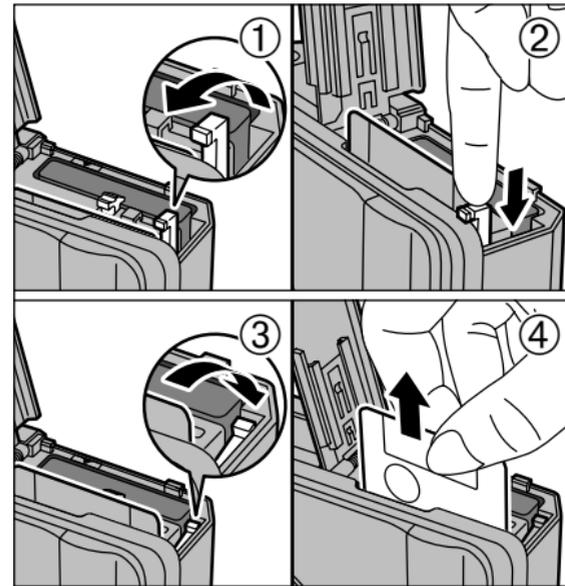

Open the battery cover, pull the SmartMedia eject button up ① and push it down ②. Then fold the SmartMedia eject button back down to its original position ③. Grip the SmartMedia and pull it out ④.

## CHARGING THE BATTERY

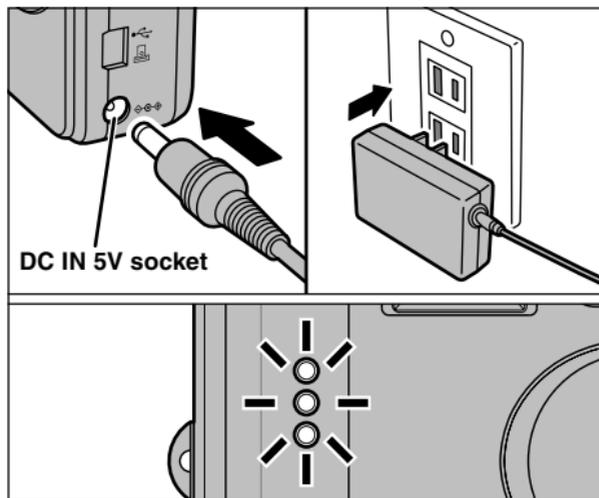

Check that the camera is switched off. Plug the AC power adapter connector into the DC IN 5V socket on the camera and then plug the adapter itself into the main power outlet.

The self timer lamp lights (blue) and battery charging begins. When charging is completed, the self-timer lamp switches off.

A fully discharged battery takes roughly 3 hours to fully recharge (at an ambient temperature of

14 +21°C to +25°C (+70°F to +77°F)).

## Using the AC Power Adapter

Use the AC power adapter to avoid losing power at inconvenient times, such as when you are downloading photographed images to your computer. Using the AC power adapter also allows you to take pictures and play back images without worrying about depleting the battery.

### ● Compatible AC power adapters AC-5VS/AC-5VHS/AC-5VH

- ⚠ Use only the FUJIFILM products listed above.
- ⚠ See P.94 for notes on using the AC power adapter.
- ⚠ Only connect or disconnect the AC power adapter when the camera is switched off.  
Connecting or disconnecting the AC power adapter while the camera is switched on temporarily interrupts the power supply to the camera, so that images or movies being shot at the time are not recorded. Failing to switch the camera off first can also result in damage to the SmartMedia or malfunctions during PC connection.
- ⚠ Charging times increase at low temperatures.
- ⚠ If the self-timer lamp flashes during charging, a charging error has occurred and the battery cannot be charged. If this occurs, see P.100.
- ⚠ Switching the camera on during charging interrupts the charging.
- ⚠ You can charge the battery more quickly by using the BC-60 Battery Charger (sold separately) (►P.89).
- ⚠ The shape of the plug and socket-outlet depends on the country of use.

## SWITCHING ON AND OFF · SETTING THE DATE AND TIME \* See P.78-79 for information on selecting the language.

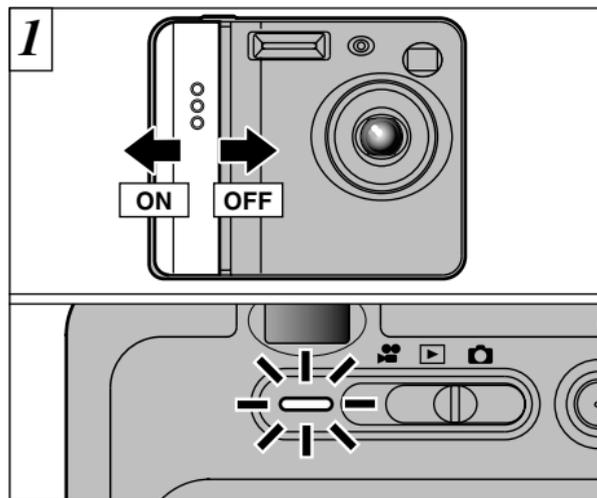

Slide the POWER switch to turn the camera on and off. When you switch the camera on, the viewfinder lamp lights (green).

If the "📷/📷" mode is selected, the lens cover opens and the lens slides out. Avoid pressing on the lens so as not to damage precision components. Obstructing the lens will cause a malfunction or fault and the "ZOOM ERROR" or "FOCUS ERROR" message will appear. Take care also not to get fingerprints on the camera lens as this will result in impaired image quality in your shots.



When you first switch the camera on, the date is cleared. Press the "MENU/OK" button to set the date and time.

- ⚠ To set the date and time later, press the "BACK" button.
- ⚠ If you do not set the date and time, this confirmation screen will appear each time you switch the camera on.
- ⚠ When you switch the camera on, the self timer lamp lights for about 5 seconds.
- ⚠ If you load the battery while the camera's POWER switch is set to ON, the viewfinder lamp/self timer lamp lights briefly. This is normal and does not indicate a fault.

1

15

## SWITCHING ON AND OFF • SETTING THE DATE AND TIME



- ① Use “◀” and “▶” to select Year, Month, Day, Hour or Minute.
- ② Press “▲(▲)” or “▼(▼)” to set the number.

- ⚠ If you hold down “▲(▲)” or “▼(▼)”, the numbers change continuously.
- ⚠ When the time displayed passes “12:00”, the AM/PM setting automatically switches.

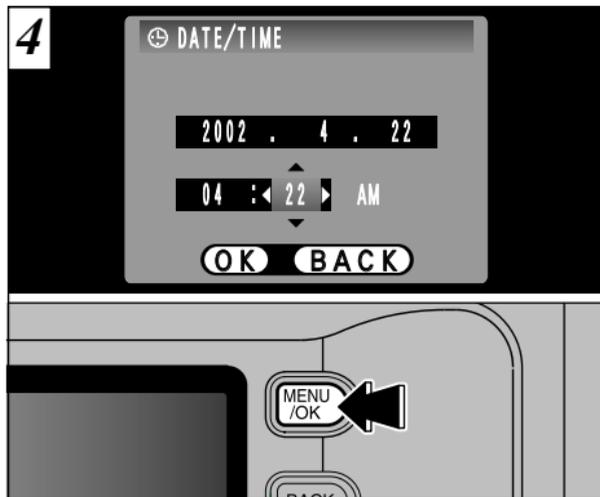

Once you have set the date and time, press the “MENU/OK” button. Pressing the “MENU/OK” button switches the camera to Photography or Playback mode.

- ⚠ To set the time, press the “MENU/OK” button when the time is at zero seconds.
- ⚠ If at least 2 hours have passed since the AC power adapter was connected or the battery inserted and the date and time set, then those settings will be maintained for roughly 5 hours even when the camera has no power supply (when the AC power adapter is disconnected and the battery is removed).

## Changing the date and time



### To change the date and time:

- ① Press the “MENU/OK” button.
- ② Use “◀” or “▶” to select “OPTION” and then use “▲(▲)” or “▼(▼)” to select “SET-UP”.
- ③ Press the “MENU/OK” button.
- ④ Select “DATE/TIME” and press “▶”.

See P.16 for information on setting the date and time.

### ◆ Checking the remaining battery charge ◆

Switch the camera on and check that no battery level warning (◻, ◻ or ◻) is displayed on the LCD monitor. If no icon is displayed, there is ample charge left in the battery.

- ◻ **Lit white:**  
The battery is approximately half charged.
- ◻ **Lit red:**  
Battery charge low. Replace or recharge the battery as it will run out shortly.
- ◻ **Blinking red:**  
The battery is exhausted. The display will shortly go blank and the camera will stop working. Replace or recharge the battery.

⚠ The above estimates are for the photography modes. In Playback mode, the transition from “◻” to “◻” may take less time.

### ◆ Power Save Function ◆

If the camera is not used in any way for approx. 30 seconds when the camera functions are enabled, this function temporarily switches features such as the LCD monitor off to reduce power consumption (→P.80). If the camera is then left unused for a further period (2 minutes or 5 minutes), the Power Save function automatically switches the camera off. To switch the camera back on, slide the Power switch to the side to turn the camera off briefly and then turn it back on.

This section describes the camera's functions.

**● Switching between still photography, playback and movies**  
Slide the Mode switch to select the mode.

Still image: Still photography.  
▶ Playback: Photographed image playback and recording sound.  
Movie: Movie photography.

**● Menu display and confirmation**  
Displays the menu screen when you are shooting or playing back images. You also press this button to confirm a menu selection.

**● BACK**  
Press this button to stop a procedure midway through.

**● Display selector**  
You can use this button to select the LCD monitor display.  
When shooting:  
Switches the LCD monitor on and off or displays the framing guides.  
During playback:  
Switches text display on and off or selects multi-frame playback.

**● Main actions performed by “[▲] (▲)”, “[▼] (▼)”, “◀” and “▶”**  
When the Mode switch is set to “📷”:

Zoom  
Switches Macro (🌿) on and off.  
Sets the flash (⚡).

When the Mode switch is set to “▶”:

Playback zoom, start/stop movie or sound playback.  
Change frame or (in a movie) frame advance.

When the Mode switch is set to “🎥”:

Zoom

## ●Using the Menus

**MENU /OK** ① Display the menu.  
Press the "MENU/OK" button.

② Select a menu option.  
Press the "◀" or "▶" button.

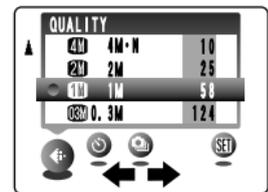

③ Select a setting.  
Press the button upward (▲) or downward (▼).

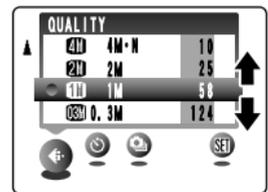

④ Confirm your selection.  
Press the "MENU/OK" button.

**BACK**  
Press this button to stop a procedure midway through.

In the Owner's Manual, black triangles are used to indicate up, down (▲, ▼) and left, right (◀, ▶) respectively.

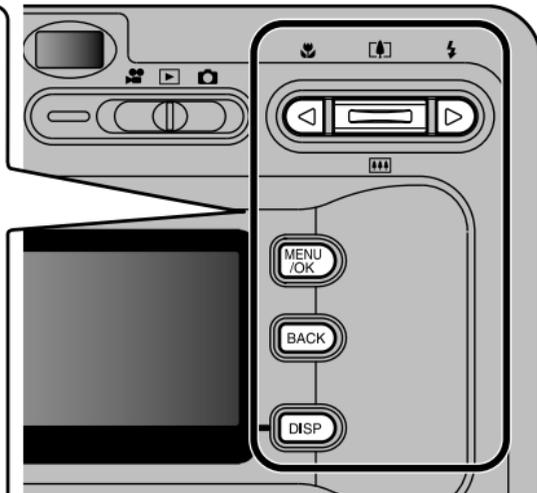

## ◆ Displaying the On-screen Help ◆

Instructions for the next step in the procedure are displayed at the bottom of the LCD monitor. Press the button indicated.

**DISP ZOOM**  
**OK TRIMMING**

Press the "DISP" button to use the zoom or the "MENU/OK" button to trim the image.



## MODE TAKING PICTURES (CAMERA AUTO MODE)

You've read the chapter on getting ready and the camera is now set up and ready to take pictures. The Basic Photography section explains the three basic steps of "taking pictures", "viewing pictures" and "erasing pictures". Master the basic steps by actually trying them out on the camera as you go.

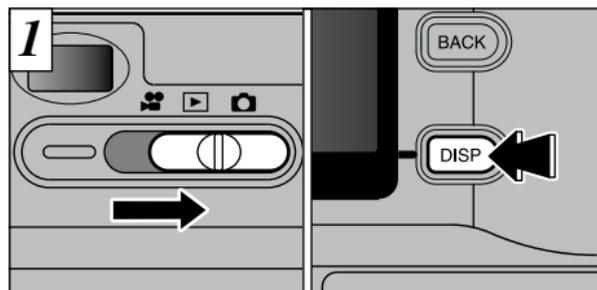

Set the Mode switch to "CAMERA".  
When you are taking shots using the viewfinder, you can make the battery last longer by pressing the "DISP" button to switch the LCD monitor off. (Note that you cannot switch the LCD monitor off in Macro mode.)

● **Photography range:** Approx. 60 cm (2 ft.) to infinity

⚠ If a "[! CARD ERROR]", "[! WRITE ERROR]", "[! READ ERROR]" or "[! CARD NOT INITIALIZED]" message appears, see P.97, 98.

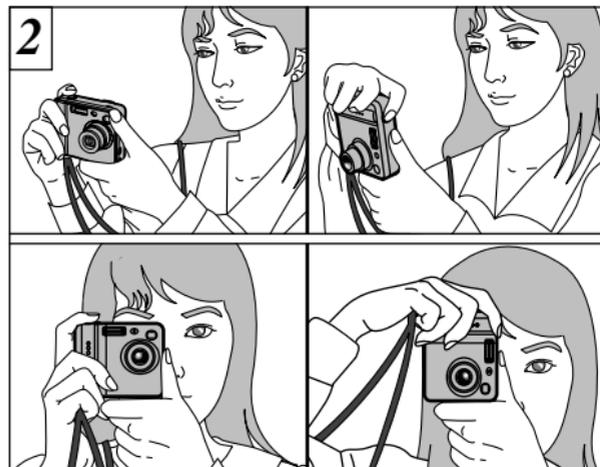

Brace your elbows against your sides and hold the camera with both hands. Position the thumb of your right hand so that it is handy for using the zoom.

- ⚠ For subjects closer than 60 cm (2 ft.), use Macro photography (→P.31).
- ⚠ Use the viewfinder to take pictures (switch the LCD monitor off) to make the battery last longer.
- ⚠ The image will be blurred if the camera moves when taking the picture (camera shake). Use a tripod to avoid camera shake, particularly for shots in dark locations when the flash is set to Suppressed Flash mode.

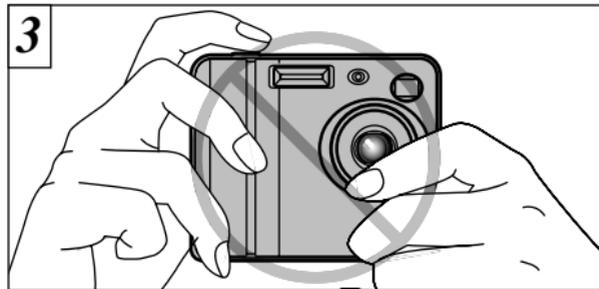

Take care to hold the camera so that your fingers or the strap do not cover the lens, flash or flash control sensor. If the lens, flash or flash control sensor is obscured by your fingers or the camera strap, you may not be able to obtain the correct brightness (exposure) for your shot.

- ⚠ There may be some unevenness in the brightness at the lower edge of the LCD monitor. This is normal and does not indicate a fault. This does not affect the photographed image.
- ⚠ Check that the lens is clean. If it is dirty, clean the lens as described on P.91.
- ⚠ If you use the flash in very dusty conditions or when it is snowing, white dots may appear in the image due to the flash reflecting off the dust particles or snowflakes. Try taking the shot with the flash switched off.

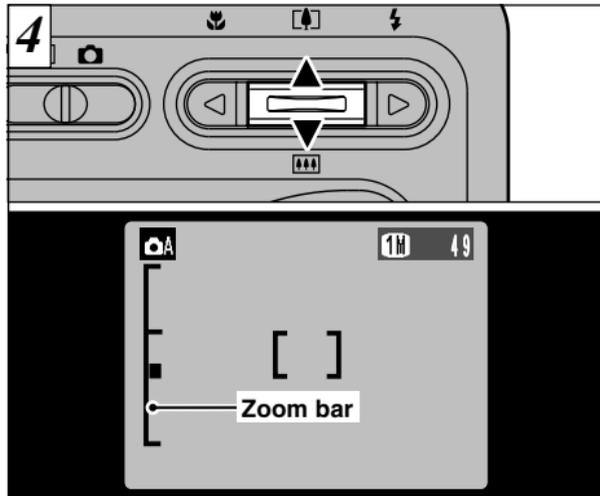

To zoom in on the subject, press “▲” (TELE). To zoom out, press “▼” (WIDE). A “zoom bar” appears on the LCD monitor when you zoom in or out.

- **Optical zoom focal length (35mm camera equivalent)**  
Approx. 38 mm-114 mm (1.5 in. to 4.5 in.)  
Maximum zoom scale: 3×

- ⚠ Zooming stops briefly when the camera switches between optical zoom and digital zoom (P.30). Press the same zoom button again to switch zoom modes.

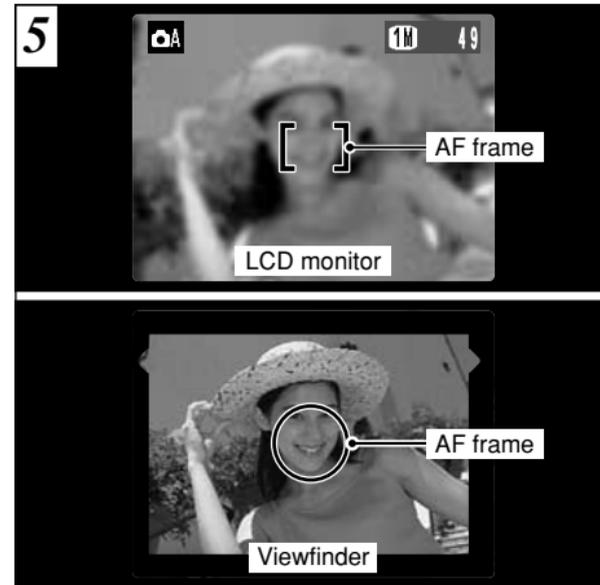

Using the viewfinder or LCD monitor, frame your shot so that the subject fills the entire AF (Auto Focus) frame.

- ⚠ If your subject is not in the center of the picture, use AF/AE lock to take the picture (P.27).

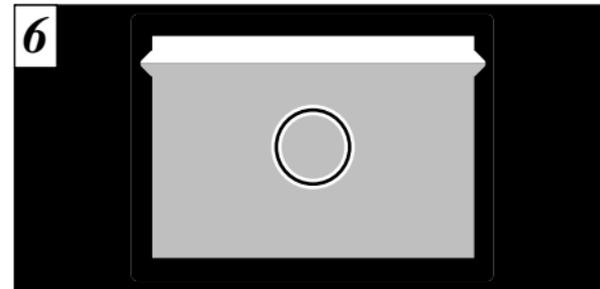

When you are using the viewfinder to take a picture at a distance of 0.6 m to 1.5 m (2.0 ft. to 4.9 ft.), only the shaded area in the figure is photographed.

- ⚠ To center the photographed area accurately, you should use the LCD monitor to take the shot.
- ⚠ In some conditions it may be difficult to see your subject clearly on the LCD monitor (such as in sunny weather outdoors or when you are shooting dimly lit scenes). In such situations, use the viewfinder to take the shot.
- ⚠ The image shown on the LCD monitor before you take the shot may differ in its brightness, color, etc. from the image actually recorded. If necessary, play back the recorded image to check it (P.35).

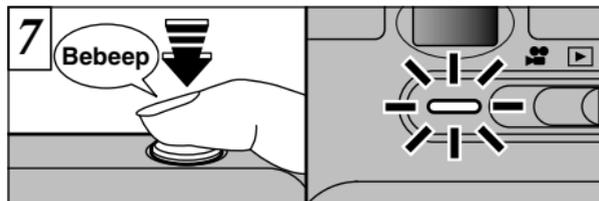

When you press the shutter button down halfway, the camera emits a short double-beep and focuses on your subject (the viewfinder lamp (green) changes from blinking to steady). At that point, the AF frame on the LCD monitor becomes smaller and the camera sets the shutter speed and aperture.

- ! If the camera does not emit a short double-beep and “!AF” appears on the LCD monitor, the camera cannot focus.
- ! When you press the shutter button down halfway, the image on the screen freezes temporarily. However, this image is not the recorded image.
- ! If “!AF” is displayed on the screen (e.g. the shot is too dark for the camera to focus), try standing about 2 m (6.6 ft.) from your subject to take the picture.

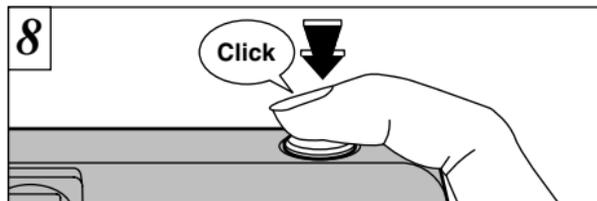

If you press the shutter button down fully without releasing it, the camera makes a clicking noise and takes the picture. The camera then records the photographed image.

- ! You can adjust the volume of the camera operation noises (“bebeep” and “click”) or switch them off altogether in the SET-UP menu (→P.78, 79).
- ! There is a slight delay between the shutter button being pressed and the shot being taken. If necessary, play back the shot to check the image.
- ! If you press the shutter button down fully in one motion, the shot is taken without the AF frame changing.
- ! When you take a picture, the viewfinder lamp lights orange (camera not ready) before switching back to green to indicate that the camera is again ready for shooting.
- ! The viewfinder lamp flashes orange while the flash is charging. If the LCD monitor is switched on, the screen may go dark for a moment. This is normal and does not indicate a fault.
- ! See P.97-99 for information on the warning displays.

## Viewfinder Lamp Display

Display	Status
Lit green	Ready to shoot.
Blinking green	AF/AE operating or camera shake/AF warning (ready to shoot).
Blinking green and orange alternately	Recording data to the SmartMedia (ready to shoot).
Lit orange	Recording data to the SmartMedia (not ready to shoot).
Blinking orange	Charging the flash (flash will not fire).
Blinking red	<ul style="list-style-type: none"> <li>• SmartMedia-related warning. The SmartMedia is not loaded, is not formatted, is incorrectly formatted or has a write-protect sticker attached. SmartMedia full. SmartMedia fault.</li> <li>• Lens operation error.</li> </ul>

\* Detailed warning messages are displayed on the LCD monitor (→P.97-99).

### Subjects Not Suitable for Autofocus

Though the FinePix F401 uses an accurate autofocus mechanism, it may have difficulty focusing or not be able to focus at all on the types of subject and situation listed below. In such cases, the image may be out of focus.

- Very shiny subjects such as a mirror or car body.
- Subjects photographed through glass.
- Subjects that do not reflect well, such as hair or fur.
- Subjects with no substance, such as smoke or flames.
- When the subject is dark.
- When there is very little contrast between the subject and the background (such as white walls or subjects dressed in the same color as the background).
- Subjects moving at high speed.
- When something other than your subject is close to the AF frame, has contrasting areas of light and dark and is either closer or further away than your subject (as when you photograph someone against a background with strongly contrasting elements).

For subjects of this type, use AF/AE lock (→P.27).

## MODE TAKING PICTURES (A AUTO MODE)

### Number of Available Frames

The number of available shots is displayed on the LCD monitor.

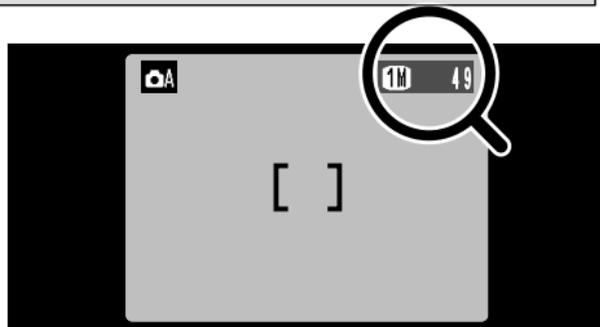

- See P.44 for information on changing the resolution.
- The default resolution "1M" set at shipment is 1M.

### Standard number of shots per SmartMedia

Because the amount of data recorded varies depending on the subject, the number of available shots may not decrease when recording ends, or may decrease by 2 frames. The discrepancy between the standard number of available shots and the actual number of available shots increases in proportion to the capacity of the SmartMedia.

Quality	4M 4M • F	4M 4M • N	2M 2M	1M 1M	0.3M 0.3M
No. of recorded pixels	2304 × 1728		1600 × 1200	1280 × 960	640 × 480
Image Data Size	Approx. 1.6MB	Approx. 790KB	Approx. 390KB	Approx. 320KB	Approx. 130KB
MG-4S (4MB)	2	4	9	12	30
MG-8S (8MB)	4	9	19	25	61
MG-16S/SW (16MB)	9	19	39	49	122
MG-32S/SW (32MB)	20	39	79	99	247
MG-64S/SW (64MB)	40	79	159	198	497
MG-128SW (128MB)	81	159	319	398	997

\* Number of available shots displayed on the camera for a new SmartMedia formatted in the camera.

## MODE USING AF/AE LOCK



In a shot with this type of composition, the subjects (two people in this case) are not in the AF frame. If the shot is taken at this point, the subjects will not be in focus.



Move the camera slightly so that one of the subjects in the AF frame.

Continued on next page...

### ◆ AF (Autofocus)/AE (Auto exposure) Lock ◆

On the FinePix F401, when you press the shutter button down half way, the focus and exposure settings are fixed (AF/AE lock). If you want to focus on a subject that is off to one side of the image or if you want to set the exposure before you compose the final shot, lock the AF and AE settings and then compose and shoot your picture to get the best results.



Without moving the camera, press the shutter button down halfway (AF/AE lock). Check that the AF frame on the LCD monitor has shrunk and the green viewfinder lamp has stopped flashing and is now lit.



Continue to hold the shutter button down halfway. Move the camera back to the original image and then fully press down on the shutter button.

- 🔧 You can reapply the AF/AE lock as many times as you like before releasing the shutter.
- 🔧 The AF/AE lock operates in all photography modes and can be used to ensure excellent results.

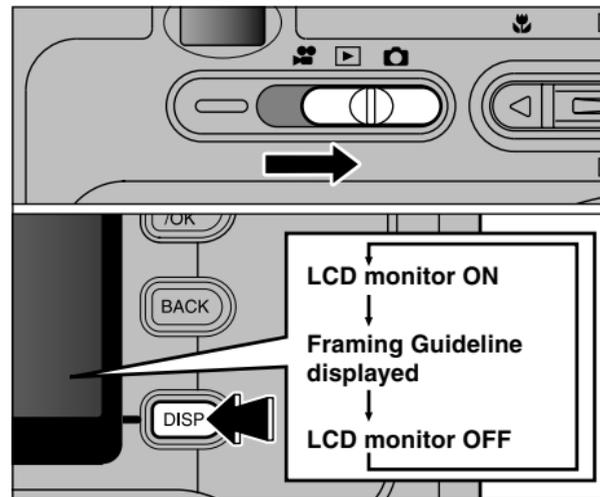

You can select the Framing Guideline function in the “📷” still photography mode. The LCD monitor display changes each time you press the “DISP” button. Press the “DISP” button until “Framing Guideline” appears.

- 🔧 The framing guideline is not recorded on the image.
- 🔧 The lines in the scene frame roughly divide the recorded pixels into three equal parts horizontally and vertically. When the image is printed, the resulting print may be shifted slightly from the scene frame.

Scene

Use this frame when you want to position your main subject in the center of the frame or when you want to align your shot with the horizon. This feature provides a clear guide to the subject size and the overall balance of the shot so that you get exactly the shot you want.



◆ Important ◆

Always use the AF/AE lock to compose your picture. Failing to use the AF/AE lock may result in the image being out of focus.

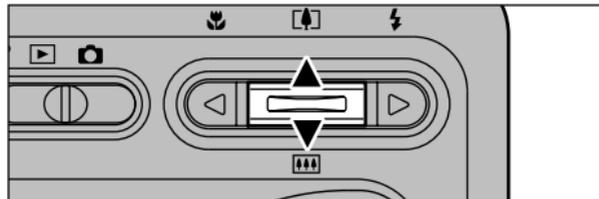

You can operate the optical zoom using the zoom buttons. You can also use the digital zoom when the resolution setting is “2M”, “1M”, “0.3M” or “MOVIE” (320 or 160). However, this only applies when you are using the LCD monitor to take pictures.

● **Digital zoom focal distance (35mm camera equivalent)**

- 2M: Approx. 114 mm to 164 mm  
Maximum zoom scale: 1.44x
- 1M: Approx. 114 mm to 205 mm  
Maximum zoom scale: 1.8x
- 0.3M: Approx. 114 mm to 410 mm  
Maximum zoom scale: 3.6x
- 320: Approx. 38 mm to 137 mm  
Maximum zoom scale: 3.6x
- 160: Approx. 38 mm to 274 mm  
Maximum zoom scale: 7.2x

- ⚠ You cannot use the digital zoom for resolutions of “1M”.
- ⚠ The digital zoom cannot be used in high-sensitivity photography (ISO 800, 1600).
- ⚠ See P.44, 55 for information on changing the file size setting.

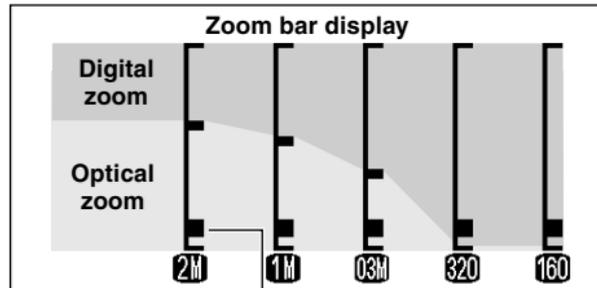

The position of the “■” on the zoom bar indicates the current zoom setting.

- If the “■” is above the dividing line, the digital zoom is being used. If it is below the line, the optical zoom is being used.
- Press “[▲]” or “[▼]” to move the “■”.
- When you switch between digital zoom and optical zoom, the “■” stops moving. Press the button for the same direction again to start the “■” moving again.
- ⚠ If the image goes out of focus when you use the zoom, press the shutter button down halfway to refocus.
- ⚠ The optical zoom is equivalent to approximately 38 mm-114 mm on a 35 mm camera.

Selecting Macro mode allows you to take close-up shots.

● **Effective Photography Range:**

Approx. 10 cm to 80 cm (3.9 in. to 31.5 in.).

- ⚠ Macro photography is automatically cancelled in the following situations:
  - When you have switched photography modes.
  - When the camera is switched off.
- ⚠ When you set the mode, the “🌸” icon is briefly displayed larger.
- ⚠ To fire the flash, press “▶” and select “⚡” Forced Flash or “S” Slow Synchro (P.33, 34). However, in some cases the correct brightness (exposure) may not be obtained.
- ⚠ If you are shooting in a dark location (when the “👉” camera shake warning icon is displayed), use a tripod to prevent camera shake.

If you use the viewfinder to take a picture in Macro mode, the field visible through the viewfinder does not match the field actually photographed because the viewfinder and lens are in different positions. Accordingly, you should use the LCD monitor to take pictures in Macro mode.

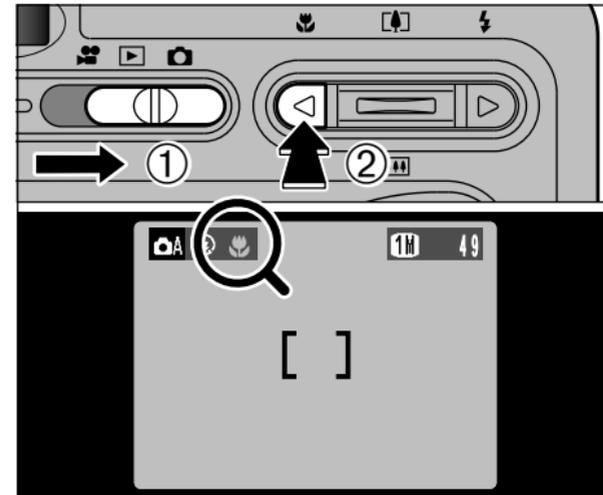

- ① Set the Mode switch to “📷”.
- ② Press the “🌸” Macro button (◀). The “🌸” icon appears on the LCD monitor indicating that you can take close-up shots.  
To cancel Macro mode, press the “🌸” Macro button (◀) again.
- ⚠ The LCD monitor automatically switches on.
- ⚠ You cannot switch the LCD monitor off.
- ⚠ When you cancel Macro mode, the LCD monitor remains on.

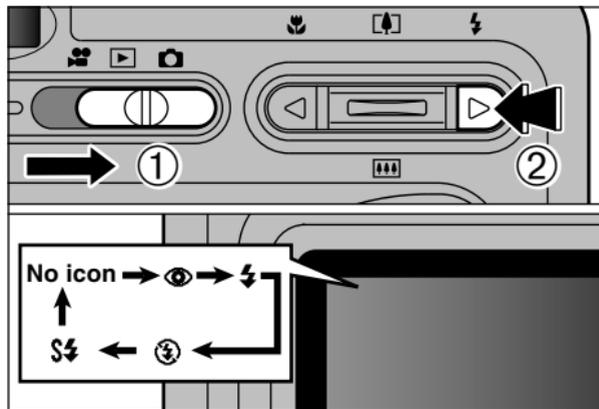

### Auto Flash Mode (no icon)

Use this mode for ordinary photography. The flash fires automatically as required by the shooting conditions.

- ⚠ The flash charging time may increase if the charge remaining in the battery is low.
- ⚠ When you take a shot using the flash, you may see the video image disappear and the screen go dark as the flash charges. The viewfinder lamp flashes orange while the flash is charging.

You can choose from 5 flash modes according to the type of shot.

- ① Set the Mode switch to “”.
- ② The flash setting changes each time you press the “” Flash button (). The last flash mode displayed is selected.

#### ● Effective flash range (for AUTO)

Wide-angle: Approx. 0.4 m to 3.5 m (1.3 ft. to 11.5 ft.)

Telephoto : Approx. 0.4 m to 2 m (1.3 ft. to 6.6 ft.)

- ⚠ The selected flash icon is briefly displayed larger.
- ⚠ If you use the flash in very dusty conditions or when it is snowing, white dots may appear in the image due to the flash reflecting off the dust particles or snowflakes. Try taking the shot with the flash switched off.



### Red-Eye Reduction

Use this mode to ensure that the subject's eyes appear natural when photographing people in low-light conditions.

The flash fires a pre-flash just before the picture is taken and then fires again to take the actual picture.

#### ◆ Red-Eye Effect ◆

When you use the flash to photograph people in low-light conditions, their eyes sometimes appear red in the picture. This is caused by the light of the flash reflecting off the inside of the eye. Use Red-Eye Reduction flash to effectively minimize the likelihood of the red-eye effect.

Take the following measures to make Red-Eye Reduction more effective:

- Get the subjects to look at the camera.
- Get as close as possible to the subjects.



### Forced Flash

Use this mode to photograph backlit scenes, such as a subject against a window or in the shade of a tree, or to obtain the correct colors when you are shooting under lighting such as fluorescent tubes. In this mode, the flash fires in bright as well as dark conditions.



### ⓘ Suppressed Flash

Use this mode for photography using indoor lighting, for shots taken through glass, and for photography in venues such as theaters or at indoor sporting events where the distance is too great for the flash to be effective. When you use Suppressed Flash, the Automatic White Balance function (➡P.104) operates so that natural colors are captured along with the ambience of the available light.

- ⚠ If you are shooting in Suppressed Flash mode in dark conditions, use a tripod to prevent camera shake.
- ⚠ See P.25, 97 for information on the camera shake warning.



### ⓘ Slow Synchro

This is a flash mode that uses a slow shutter speed (slowest shutter speed: 1/4 sec.). This allows you to take pictures of people at night that clearly show both your subjects and the night time backdrop.

- ⚠ The image may be overexposed when you shoot bright scenes.
- ⚠ Because a slow shutter speed is used, a tripod should be used to prevent camera shake.

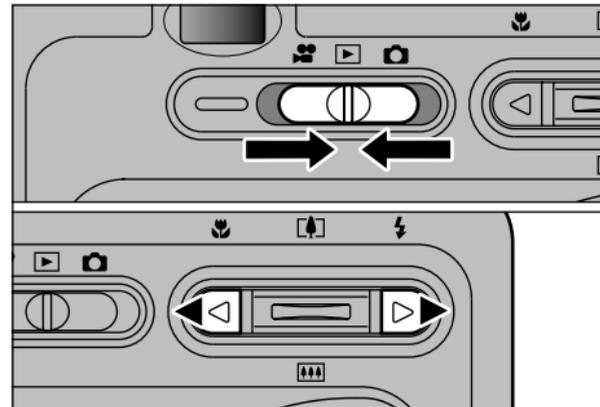

Set the Mode switch to “▶”. You can “◀” and “▶” button to move forward and backward respectively through your images.

- ⚠ When you set the Mode switch to “▶”, the last image shot is displayed.
- ⚠ If the lens is extended during playback, the camera retracts the lens as a protective measure if the camera is not used for approximately 6 seconds.

#### ◆ Images That Can be Viewed on the FinePix F401 ◆

You can use this camera to view (excluding some uncompressed data) images recorded on a FinePix F401 or images recorded onto a 3.3V SmartMedia using a FUJIFILM FinePix series, MX series and DX series digital camera.

### Fast Forwarding Images

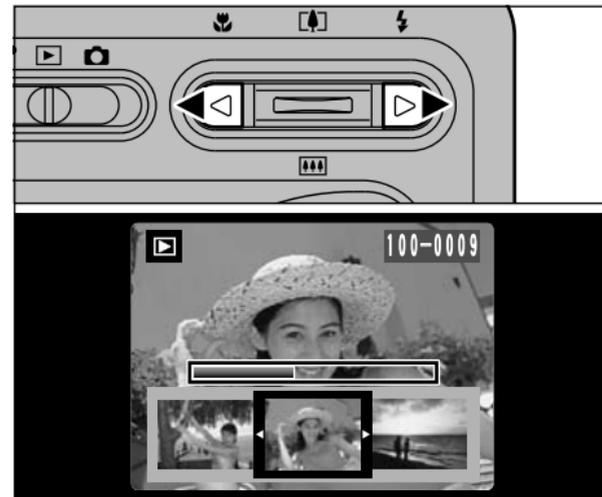

You can fast forward through the frames by holding down “◀” or “▶” button for about 1 second during playback.

- ⚠ A progress bar is displayed to show the approximate playback position on the SmartMedia.

## MODE MULTI-FRAME PLAYBACK

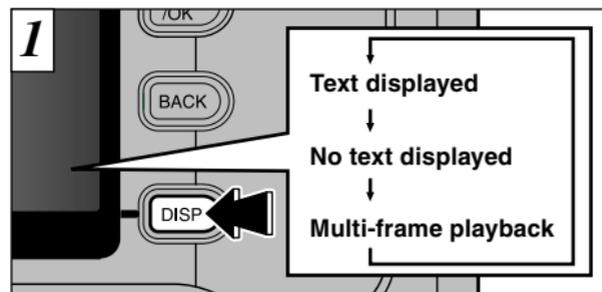

In playback mode, the display shown on the LCD monitor switches each time you press the “DISP” button. Press the “DISP” button until the multi-frame playback screen (9 frames) appears.

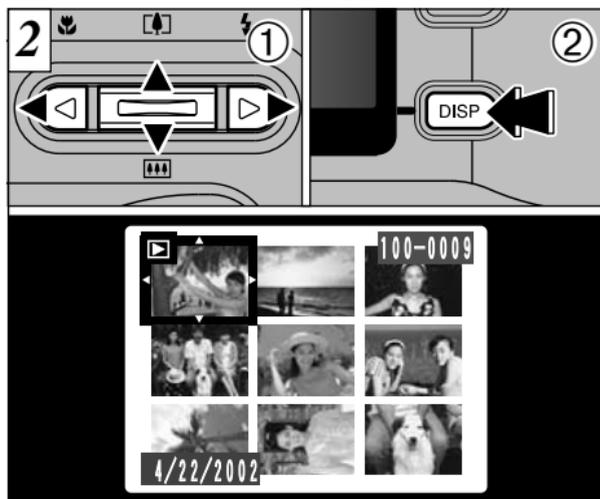

- 1 Select a frame by using “◀”, “▶”, “[▲]” and “[▼]” button to move the cursor (the orange box) to the desired frame. Press the “[▲]” or “[▼]” button several times to switch to the previous page or the next page.
- 2 You can enlarge the selected image by pressing the “DISP” button again.

- ⚠ The LCD monitor text display disappears after approximately 3 seconds.
- ⚠ Playback zoom cannot be used with multi-frame playback.

## MODE PLAYBACK ZOOM

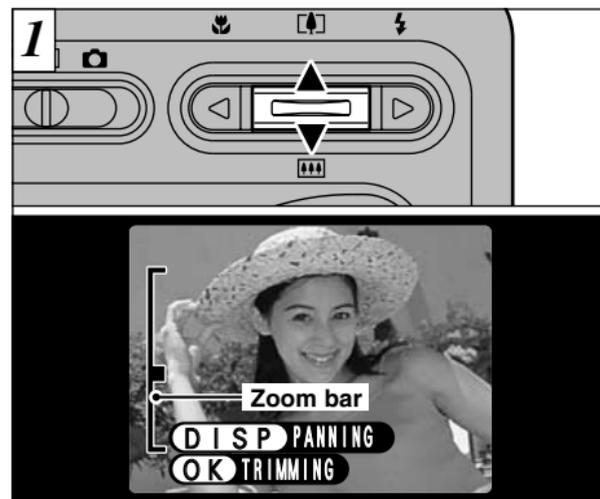

Pressing the “[▲]” or “[▼]” button during single-frame playback zooms in (enlarges) or out on a still image. When you use this function, a zoom bar is displayed. On-screen help is also displayed at the bottom of the screen.

### ● Zoom scales:

- 4M 2304 × 1728 pixel images: Max. 14.4×
- 2M 1600 × 1200 pixel images: Max. 10×
- 1M 1280 × 960 pixel images: Max. 8×
- 0.8M 640 × 480 pixel images: Max. 4×

- ⚠ Pressing the “◀” or “▶” button during zooming cancels zooming and moves to the next image.



After you have zoomed in on your image,

- 1 Press the “DISP” button.
- 2 Use “[▲]” “[▼]” and “◀▶” to zoom in on different parts of the image.
- 3 Press the “DISP” button again to revert to zoomed display.

- ⚠ Press the “BACK” button to return to normal unscaled display.

**Saving Trimmed Images**

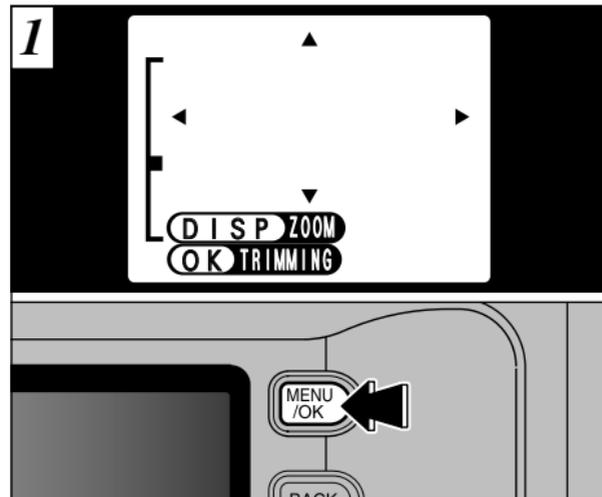

After using playback zoom, press the “MENU/OK” button to trim the image.

The size of the saved image varies depending on the zoom scale. In 0.3M mode, “OK TRIMMING” is displayed in yellow. At recorded pixels below 0.3M, “OK TRIMMING” is no longer displayed.



Check the size of the image being saved and then press the “MENU/OK” button. The trimmed image is added as a separate file in the last frame.

**Image Sizes**

2M	Best for prints
1M	Good for prints
0.3M	“OK TRIMMING” is displayed in yellow since the quality is too low for printing.

\* Lower than 0.3M: “OK TRIMMING” is no longer displayed and images cannot be saved trimmed as the quality is not suitable for printing.

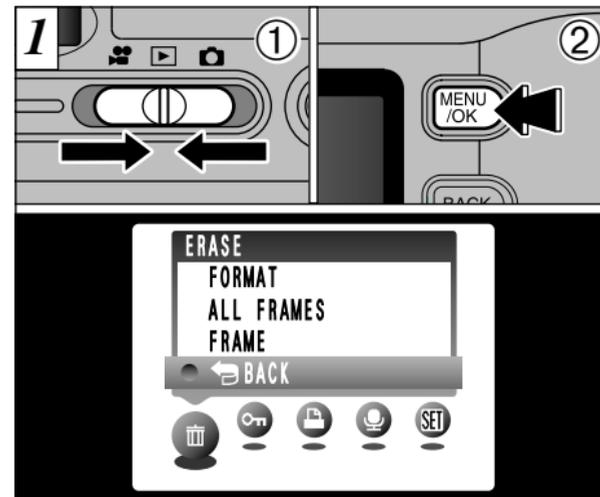

- 1 Set the Mode switch to “▶”.
- 2 Press the “MENU/OK” button to display the Menu screen on the LCD monitor.

! To revert to image playback without erasing the image, select “BACK” and press the “MENU/OK” button.

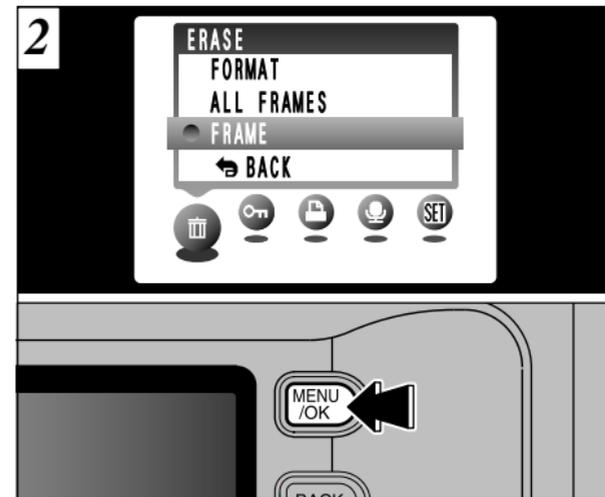

Select “FRAME” in the “ERASE” menu and press the “MENU/OK” button. See P.58 for more information on “ALL FRAMES” and “FORMAT”.

## MODE ERASING SINGLE FRAME

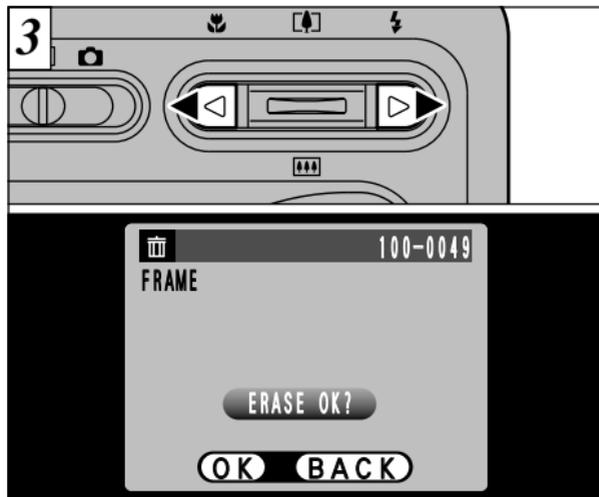

Press “◀” or “▶” to view the frame (individual file) you want to erase.

⚠ Press the “BACK” button to cancel frame erasing.

Note that mistakenly erased images cannot be recovered. You should copy important files that you do not want to be erased to your computer or another media.

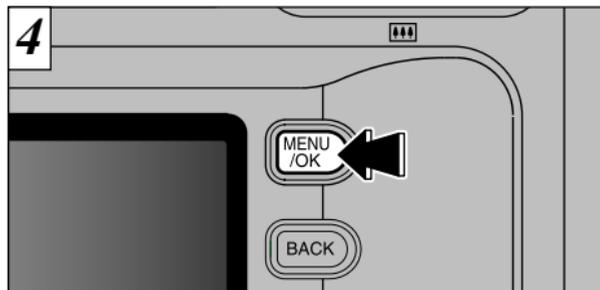

Pressing the “MENU/OK” button erases the frame (individual file) displayed. When erasing is complete, the next image appears and the “ERASE OK?” message is displayed.

To erase another frame, repeat steps 3 and 4.

## 3 Advanced Features Photography

## MODE SELECTING AUTO OR MANUAL

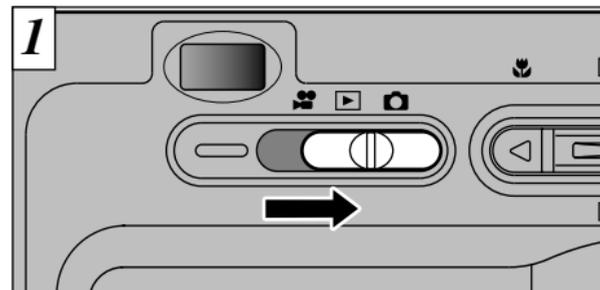

Set the Mode switch to “”.

⚠ See P.52 for information on shooting movies.

### AUTO

This is the easiest mode for taking pictures and can be used in a wide range of conditions.

### MANUAL

This mode allows you to specify your own brightness, white balance and sensitivity settings.

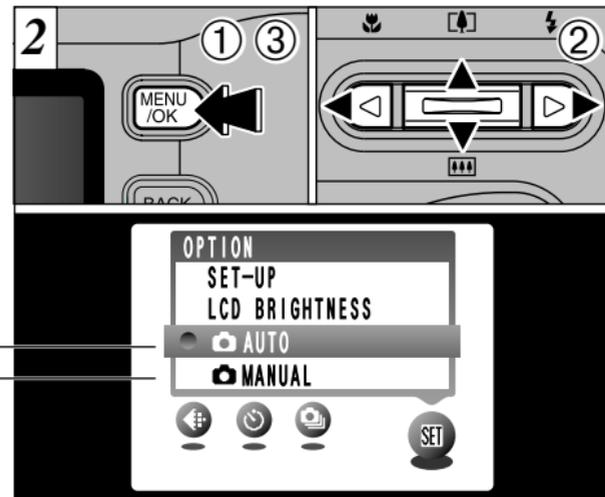

- ① Press the “MENU/OK” button to display the menu.
- ② Use “◀” or “▶” to select “” OPTION and then use “ (▲)” or “ (▼)” to select “ AUTO” or “ MANUAL”.
- ③ Press the “MENU/OK” button to confirm the selection.

# PHOTOGRAPHY MENU OPERATION/PHOTOGRAPHY MENU OPTIONS

## Photography Menu Operation

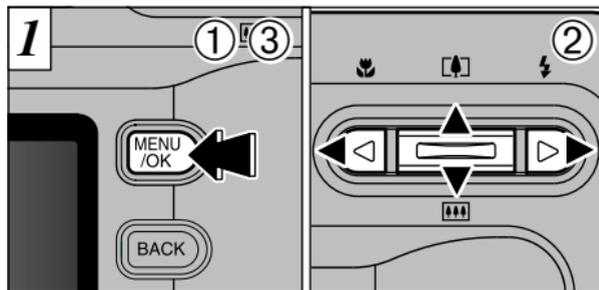

- 1 Press the “MENU/OK” button to display the menu.
- 2 Use “◀” and “▶” to select the menu item and “▲(↑)” and “▼(↓)” to change the setting.
- 3 Press the “MENU/OK” button to confirm the selection.

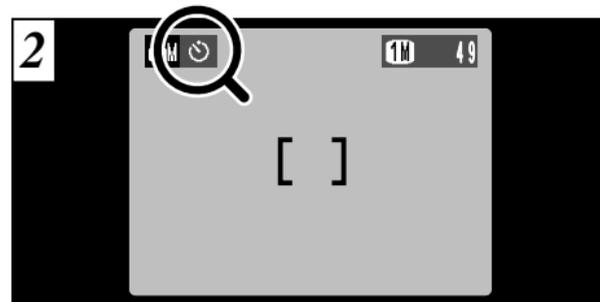

When you enable the setting, an icon appears in the top-left corner of the LCD monitor.

The settings available in the menu screen differ depending on the still image mode.

## Photography Menu Options

WB White balance	EV	ISO Sensitivity
Available modes CAM		
Default setting: AUTO	Default setting: 0	Default setting: 200
See P.51 for details.	See P.50 for details.	See P.49 for details.

In “CAM” (Manual) mode:  
Pressing “◀” or “▶” once more in the resolution and sensitivity settings jumps to the previous page or the next page.

Quality	Self-timer photography	Continuous shooting	Option
Available modes CAM, CAM, CAM			
Default setting: 10 (CAM), 820 (CAM)	Default setting: OFF	Default setting: OFF	—
See P.44, 55 for details.	See P.45 for details.	See P.47 for details.	See P.78 for details.

## ◀ SETTING QUALITY MODE (NO. OF RECORDED PIXELS FOR STILL IMAGES)

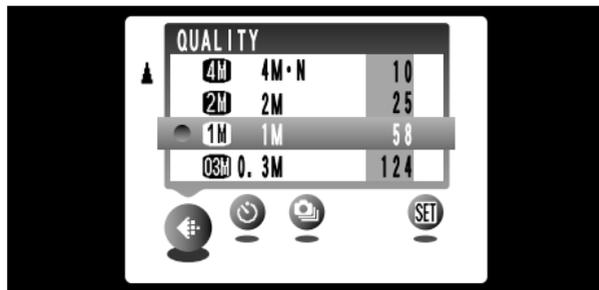

This mode can be selected in the “**CA**”, “**CM**” still image modes.

You can choose from 5 settings. Use the table on the right as a guide for selecting the best setting for the shot you want to take.

Use	Quality Mode
Printing ↑ ↓ Internet	4M 4M • F (2304 × 1728)
	4M 4M • N (2304 × 1728)
	2M 2M (1600 × 1200)
	1M 1M (1280 × 960)
	0.3M 0.3M (640 × 480)

### <Examples>

- To print at A5 size or larger

→ 4M 4M • F or 4M 4M • N

\* Select “F” (FINE) for better image quality and “N” (NORMAL) to increase the number of available shots.

In most cases, the “N” (NORMAL) setting provides more than adequate image quality.

- To print at A6 (postcard) to A5 size → 2M 2M
- To print at A7 (half postcard) to A6 size → 1M 1M
- For an image attached to E-mail or used on a website → 0.3M 0.3M

- See P.55 for information on the resolution setting for Movie mode.

The numbers to the right of each setting show the number of available shots.

When you change the resolution, the number of available shots also changes.



## SELF-TIMER PHOTOGRAPHY

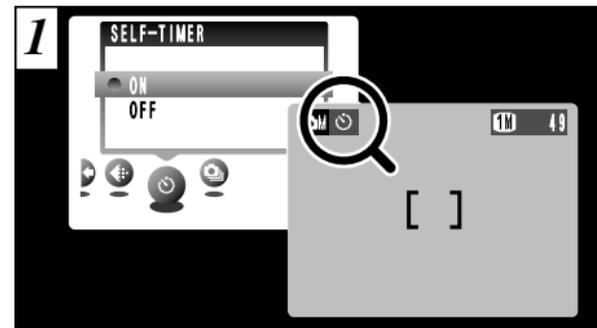

This mode can be selected in the “**CA**”, “**CM**” still image modes.

When you set the self-timer to “ON”, “**⌚**” appears on the LCD monitor.

In this mode, a timer runs for roughly 10 seconds before the shutter is released. Use this mode for shots such as photographs of yourself.

- The self timer is automatically switched off in the following situations:
  - When shooting ends
  - When you switch to “**CA**” or “**CM**” mode
  - When you change the Mode switch setting
  - When the camera is switched off.
- You can also use the AF/AE lock (→P.27).
- Be careful not to stand in front of the camera when you press the shutter button as this can cause focusing or exposure metering errors.

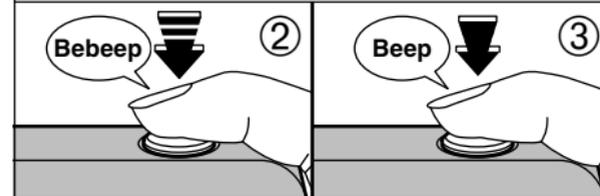

- Position the AF frame over your subject.
- Press the shutter button down half way to set the focus.
- Without releasing the shutter button, press it down fully. The self-timer then starts running.

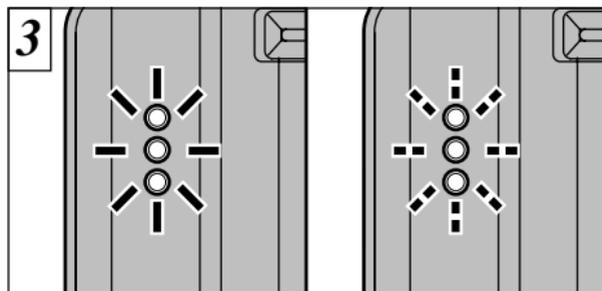

The self timer lamp lights for 5 seconds and then starts flashing. 5 seconds later the camera makes a clicking noise and takes the picture.

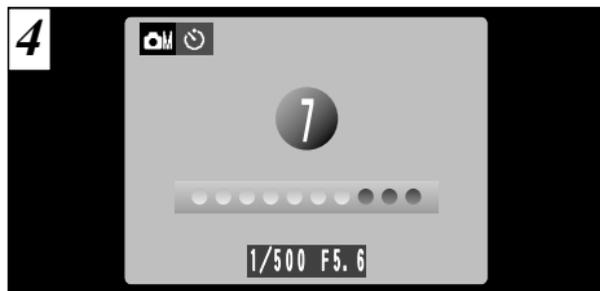

Until the picture is taken, a countdown appears on the LCD monitor. Self-timer mode is automatically cancelled after each shot.

46 To stop the self-timer once it has started running, press the "BACK" button.

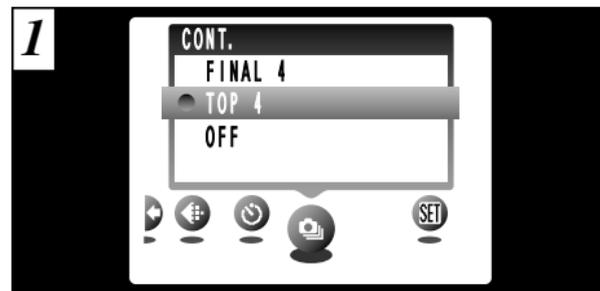

This mode can be selected in the "📷A", "📷M" still image modes. Select the continuous shooting mode you want to use. See P.48 for more information on continuous shooting modes.

- ! "SHOOTING" appears on the LCD monitor during shooting.
- ! You cannot use the flash in this mode.
- ! The speed of continuous shooting remains the same regardless of the resolution setting.
- ! The shots should be taken using the viewfinder.
- ! The results of the shot are displayed even when "POSTVIEW" is set to OFF (→P.79).
- ! The time required to record a file is approximately 8 seconds in "📷" mode (for TOP or FINAL 4-frame continuous shooting).

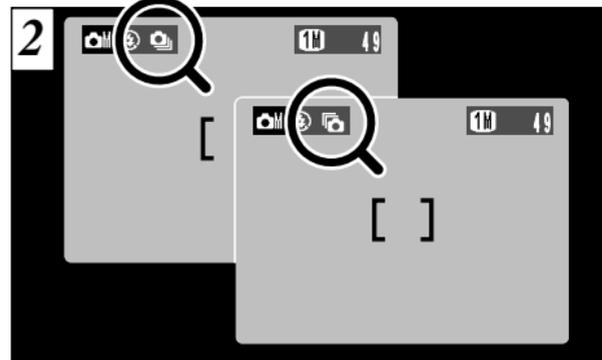

When Top 4-frame continuous shooting is set to ON, the "📷" icon appears on the LCD monitor. When Final 4-frame continuous shooting is set to ON, "📷" appears on the LCD monitor. Continuous shooting continues while the shutter button is pressed down fully.

- ! The focus and exposure are determined for the first frame and cannot be changed during shooting.
- ! If there is insufficient available space on the SmartMedia to take the maximum number of continuous shots, the number of shots that can be recorded is taken.

## Top 4-frame Continuous Shooting



In this mode, you can shoot up to 4 frames at intervals as short as 0.3 seconds. When you take the shots, the photographed images are displayed and automatically recorded.

## Final 4-frame Continuous Shooting

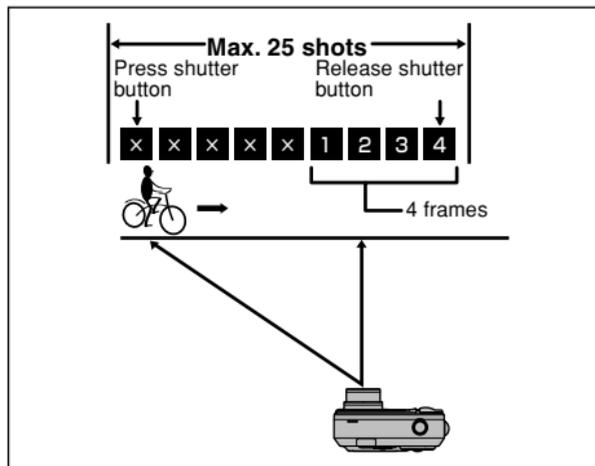

This mode allows you to release the shutter up to 25 times (at intervals as short as 0.3 seconds) and record the last 4 frames. If you take your finger off the shutter button before 25 shots have been taken, the camera records the final 4 frames shot before you released the shutter button. If there is insufficient capacity on the SmartMedia, the number of shots that could be recorded just before the shutter button was released is taken.

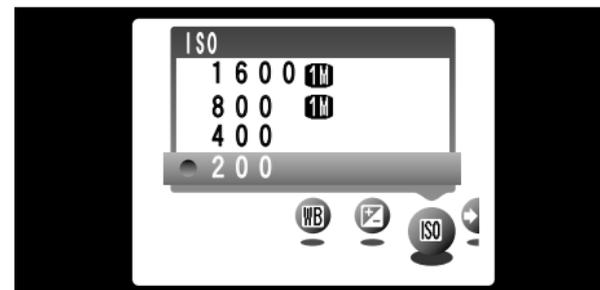

This mode can be selected in the “M” photography mode. Use this setting when you want to take bright pictures indoors without using a flash or when you want to use a fast shutter speed (to prevent camera shake, etc.).

● **Settings:** 200 (standard), 400, 800, 1600

- ⚠ While selecting a higher sensitivity setting will allow you to take pictures in darker locations, it will also increase the amount of speckling in your images. Streaking may also be visible in shots of scenes such as the night sky. Choose the sensitivity setting that best suits the conditions.
- ⚠ When you specify a high sensitivity, the amount of noise (interference) in the image shown on the LCD monitor before the shot is taken increases. However, this is normal and does not indicate a fault.
- ⚠ The digital zoom cannot be used in high-sensitivity photography.

If you select a photography mode other than “M” when a high sensitivity setting is selected, the resolution reverts to the setting specified just before the sensitivity was set.

## High-sensitivity photography (800 or 1600)

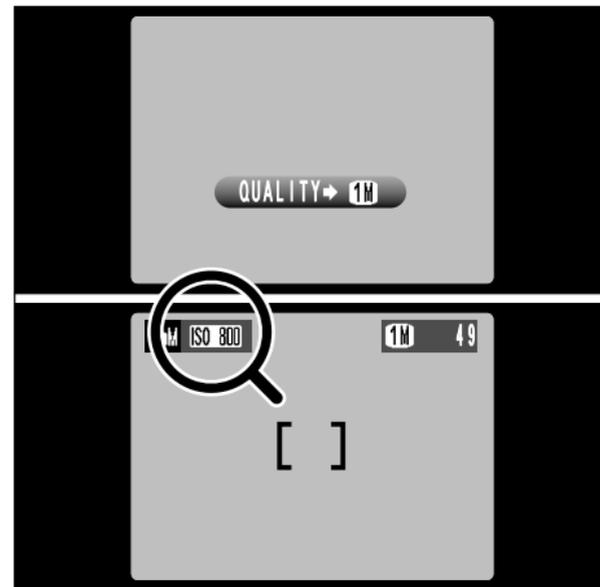

When a high sensitivity (800 or 1600) is set, “ISO 800” or “ISO 1600” appears on the LCD monitor and the resolution is automatically set to “1M”. If you try to select a resolution other than “1M” when a high sensitivity setting is selected, “ISO 800” or “ISO 1600” flashes and the resolution remains unchanged.

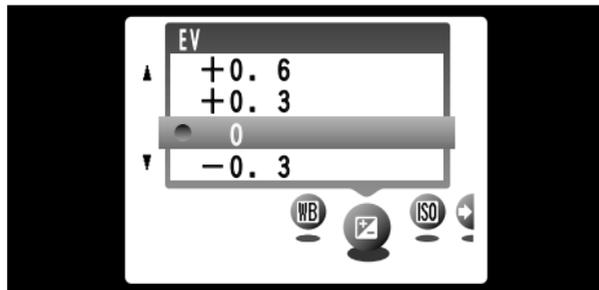

This mode can be selected in the “M” photography mode.

Use the Brightness setting to obtain the optimum image brightness (exposure) when the subject is much brighter or darker than the background.

- **Correction range:** 13 steps  
(–2.1 EV to +1.5 EV in 0.3 EV increments)  
See P.103 for more information on EV.

The Brightness setting is disabled in the following situations:

- When the flash is used in Auto or Red-Eye Reduction mode.
- When dark scenes are shot in Forced Flash mode.

### ◆ Subjects for Which Exposure Adjustment is Particularly Effective ◆

#### Guide to using + (positive) compensation

- Copying of printed text (black characters on white paper) (+1.5 EV)
- Backlit portraits (+0.6 EV to +1.5 EV)
- Very bright scenes (such as snowfields and highly reflective subjects (+0.9 EV)
- Shots made up predominantly of sky. (+0.9 EV)

#### Guide to using – (negative) compensation

- Spotlit subjects, particularly against dark backgrounds (–0.6 EV)
- Copying of printed text (white characters on black paper) (–0.6 EV)
- Scenes with low reflectivity, such as shots of pine trees or dark foliage (–0.6 EV)

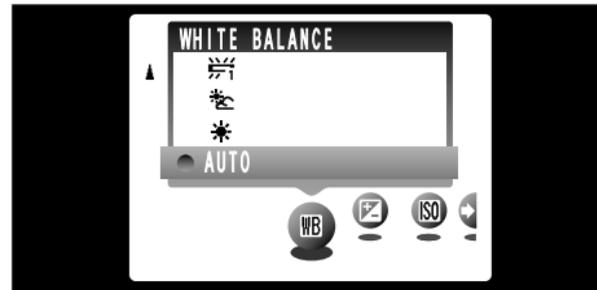

This mode can be selected in the “M” photography mode.

Change the white balance setting when you want to take a picture with the white balance fixed for the surroundings and lighting when the picture is taken.

In AUTO mode, the correct white balance may not be obtained for subjects such as close-ups of people’s faces and shots taken under a special light source. In such situations, select the correct white balance for the light source. See P.104 for information on the white balance.

AUTO: Automatic adjustment  
(Shooting to show the ambience of the light source)

- : Shooting outdoors in fine weather
- : Shooting in shade
- : Shooting under “Daylight” fluorescent lamps
- : Shooting under “Warm White” fluorescent lamps
- : Shooting under “Cool White” fluorescent lamps
- : Shooting in incandescent light

\* When the flash fires, the white balance set for the flash is used. To achieve a particular desired effect, set the flash mode to Suppressed Flash (→P.34).

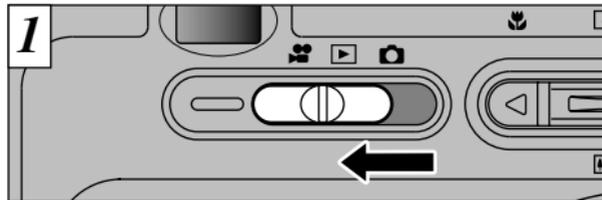

1 Set the Mode switch to “**MOVIE**”.

This mode allows you to shoot movies up to 120 seconds (at the **320** setting) or 480 seconds (at the **160** setting) with sound. (See P.55 for information on resolution settings.)

- **Movie format:** Motion JPEG (→P.103)
  - 320** (320 × 240 pixels)
  - 160** (160 × 120 pixels)
  - selectable
  - 10 frames per second
  - With monaural sound

- ⚠ Because the audio is recorded as you shoot, take care not to cover the microphone with your finger (→P.8).
- ⚠ Depending on the available space on the SmartMedia, the available shooting time per movie may be shorter.
- ⚠ You cannot switch the LCD monitor off in this mode.

It may not be possible to play back your movie on other cameras.

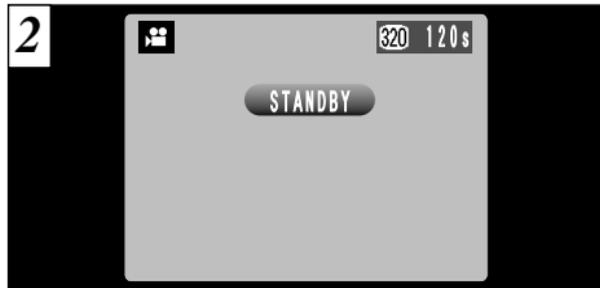

2 The available shooting time and the “**STANDBY**” message are shown on the LCD monitor.

■ **SmartMedia standard shooting time**

SmartMedia Capacity	Quality	
	<b>320</b>	<b>160</b>
MG-4S (4MB)	Approx. 24 sec.	Approx. 83 sec.
MG-8S (8MB)	Approx. 49 sec.	Approx. 169 sec.
MG-16S/SW (16MB)	Approx. 98 sec.	Approx. 5.6 min.
MG-32S/SW (32MB)	Approx. 199 sec.	Approx. 11.3 min.
MG-64S/SW (64MB)	Approx. 6.7 min.	Approx. 22.8 min.
MG-128SW (128MB)	Approx. 13.4 min.	Approx. 45.6 min.

\* The available shooting time displayed on the camera for a new SmartMedia formatted in the camera.

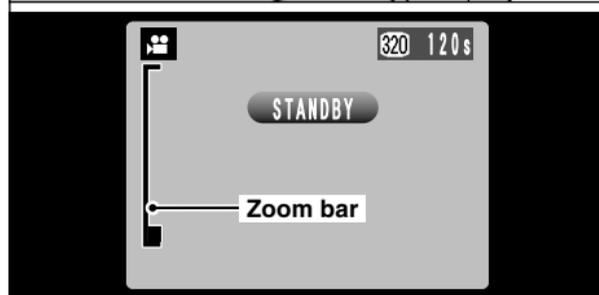
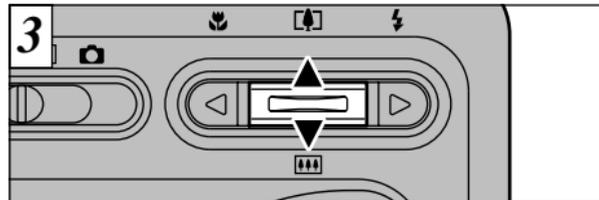

3 In Movie (video) mode, the lens is fixed at the wide-angle setting and only the digital zoom can be used. You can use the “**[L]**(▲)” and “**[R]**(▼)” zoom buttons to zoom in and out. A “zoom bar” appears on the LCD monitor.

- **Digital zoom focal distance (35mm camera equivalent)**
  - 320**: Approx. 38 mm to 137 mm  
Maximum zoom scale: 3.6×
  - 160**: Approx. 38 mm to 274 mm  
Maximum zoom scale: 7.2×

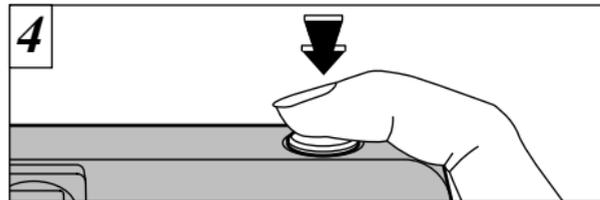

4 Press the shutter button down fully to start shooting the movie.

- ⚠ If the brightness of the subject changes while you are shooting a movie, the sound of the aperture operating may be recorded in the movie.
- ⚠ Camera operation noises may be recorded during movie shooting.
- ⚠ You do not need to hold down the shutter button.
- ⚠ The focus is fixed at 2 m (6.6 ft.) to infinity.
- ⚠ The focus and white balance are fixed during shooting, but the exposure varies automatically to suit the scene being shot.
- ⚠ The image shown on the LCD monitor before you take the shot may differ in its brightness, color, etc. from the image shown on the monitor during movie recording.

The white balance is set automatically when you press the shutter button down fully.



During shooting, a timer in the top-right corner of the LCD monitor counts down the remaining time.

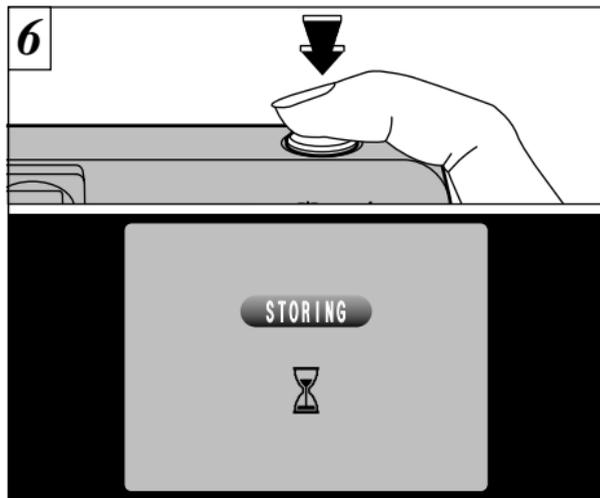

If you press the shutter button once more during shooting, shooting ends and the movie is recorded onto the SmartMedia.

- ⚠ The time required to record a 120 second movie (roughly 20 MB) is approximately 14 seconds.
- ⚠ If you end shooting immediately after you start shooting, only 1 second of movie is shot.

### Resolution settings for movies

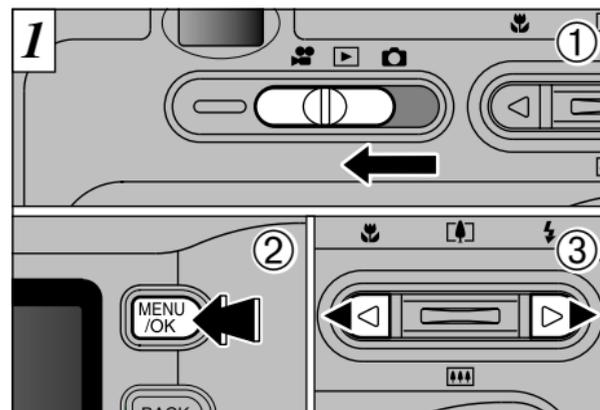

- ① Set the Mode switch to "MOVIE".
- ② Press the "MENU/OK" button to display the menu screen.
- ③ Press "←" or "→" to select "QUALITY". You can select 2 levels of quality. For better image quality, select "320", and for longer photography time, select "160".

	Movie Size	Maximum shooting time
320	320 × 240	120 sec.
160	160 × 120	480 sec.

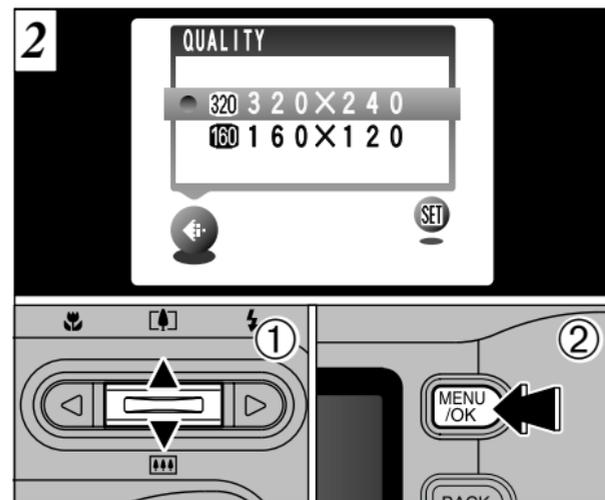

- ① Use "▲" and "▼" to change the quality setting.
- ② Press "MENU/OK" button to confirm your selection.

⚠ Once the remaining time runs out, movie recording automatically stops and the movie is stored on the SmartMedia.

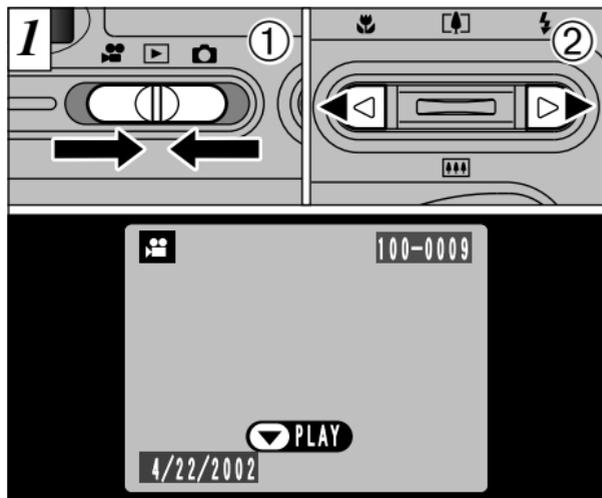

- ① Set the Mode switch to “”.
- ② Press “” or “” to select a movie file.

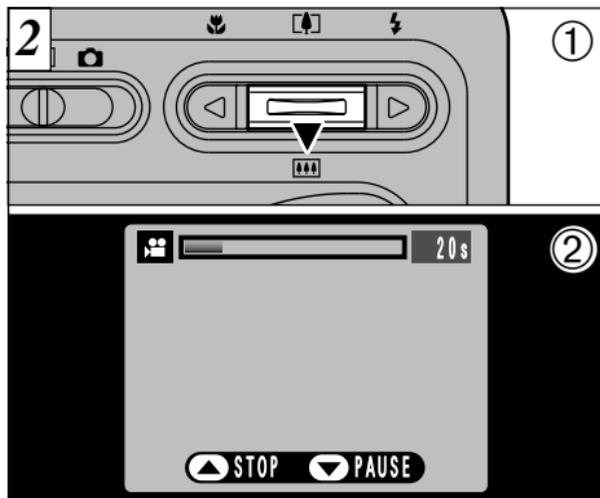

- ① Press “ (▶)” to play the movie.
- ② The LCD monitor shows the playback time and a playback progress bar.

⚠ Movies cannot be played back using multi-frame playback. Use the “DISP” button to select normal playback.

- ⚠ Take care not to block the speaker.
- ⚠ If the sound is difficult to hear, adjust the volume (→P.77).
- ⚠ If the subject of the movie is very bright, white streaks may appear on the image during playback. This is normal and is not a fault.

### ■ Controlling Movie Playback

	Control	Description
Playback		The movie automatically stops when playback ends.
Pause/Resume		Pauses the movie during playback. Press this button again to resume playback.
Stop		Stops playback. * Press “” or “” while movie playback is stopped to go back to the previous file or advance to the next file respectively.
Fast forward/Rewind	 Rewind      Fast forward	Press these during playback to skip forwards or backwards through the movie.
Skip playback	 When paused	<ul style="list-style-type: none"> <li>• Each time you press “” or “” when the movie is paused, the movie advances or goes back one frame.</li> <li>• Hold down the button to move through the frames quickly.</li> </ul>

\* Refer to the Software Quick Start Guide (provided) for information on playing back movies on your PC.

### ◆ Compatible movie files ◆

You can use the FinePix F401 to play back movie files recorded on a FinePix F401 or movie files (10 fps) up to 120 seconds long shot at 320 × 240 pixels on a FUJIFILM digital camera and then recorded on a 3.3 Volt SmartMedia. Movies recorded using a FinePix F601/S602 cannot be played back on this camera.

## PLAYBACK MENU ERASING SINGLE • ALL FRAMES/FORMATTING

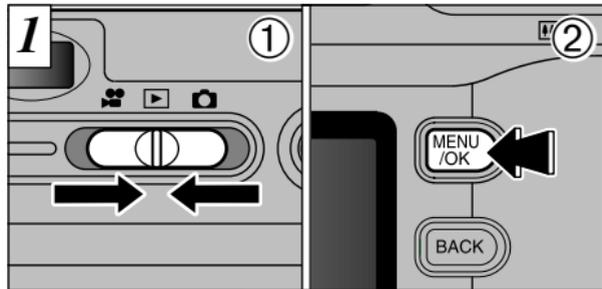

- 1 Set the Mode switch to “▶”.
- 2 Press the “MENU/OK” button to view the menu screen.

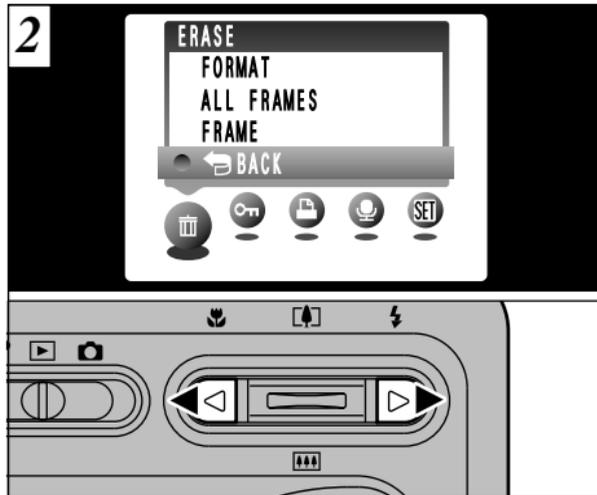

Use “◀▶” to select “” ERASE.

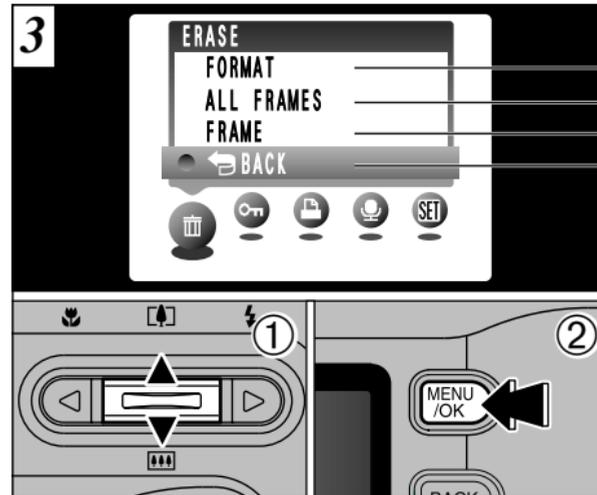

- 1 Use “ (▲)” or “ (▼)” to select “FRAME”, “ALL FRAMES” or “FORMAT”.
- 2 Press “MENU/OK” button to confirm your selection.

### FORMAT

Formatting erases all the files. The SmartMedia is initialized for use in the camera. You should copy important files that you do not want to be erased to your computer or another media.

### ALL FRAMES

Erases all unprotected files. You should copy important files that you do not want to be erased to your computer or another media.

### FRAME

Erase only the selected file.

### BACK

Returns to playback without erasing any files.



## FRAME



- ① Use “◀” and “▶” to select the file to be erased.
- ② Press the “MENU/OK” button to erase the currently displayed file.

To erase another image, repeat steps ① and ②. When you have finished erasing images, press the “BACK” button.

- ⚠ The file for which “[I PROTECTED FRAME]” was displayed cannot be erased. Remove the protection.

## ALL FRAMES

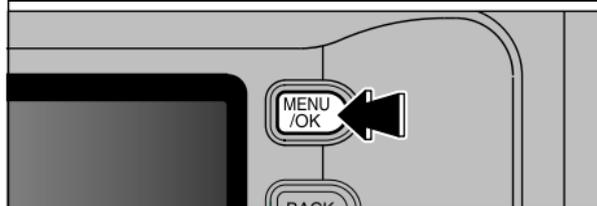

Pressing the “MENU/OK” button erases all the unprotected files.

If the “[DPOF SPECIFIED. ERASE OK ?]” or “[DPOF SPECIFIED. ERASE ALL OK ?]” message appears, press the “MENU/OK” button once more to erase the image.

## FORMAT



Pressing the “MENU/OK” button erases all the files and initializes the SmartMedia. Formatting erases protected files also.

- ⚠ If the “[I CARD ERROR]”, “[I WRITE ERROR]”, “[I READ ERROR]” or “[I CARD NOT INITIALIZED]” message appears, refer to P.97, 98 before formatting the SmartMedia and take the appropriate measures.

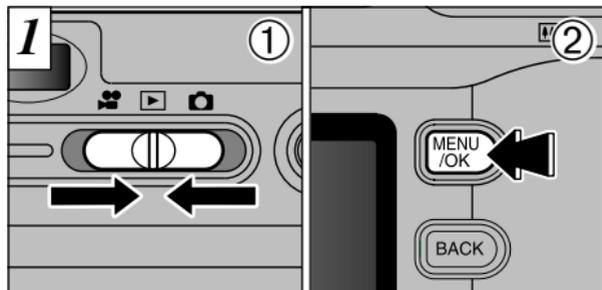

- ① Set the Mode switch to “▶”.
- ② Press the “MENU/OK” button to view the menu screen.

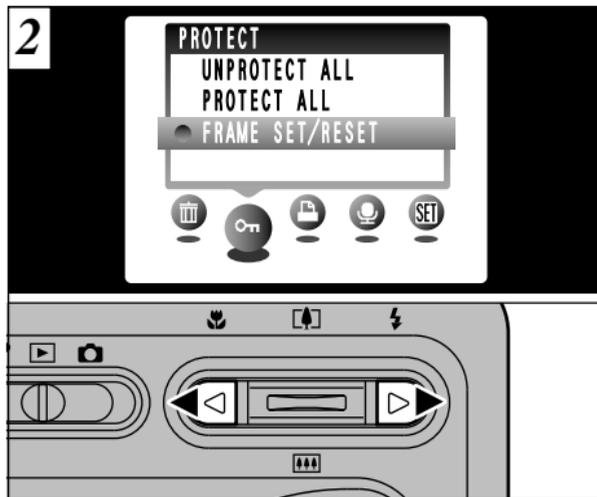

Use “◀” or “▶” to select “” PROTECT.

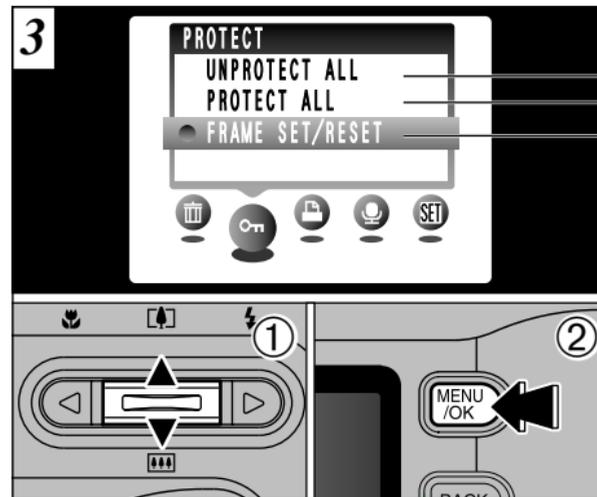

- ① Press “ (▲)” or “ (▼)” to select “UNPROTECT ALL”, “PROTECT ALL” or “FRAME SET/RESET”.
- ② Press “MENU/OK” button to confirm your selection.

#### UNPROTECT ALL

Removes the protection from all the files.

#### PROTECT ALL

Protects all the files.

#### FRAME SET/RESET

Protects or unprotects only the selected file.

Protection is a setting that prevents images from being accidentally erased. However, “FORMAT” erases all images, regardless of a “PROTECT ALL” setting (→P.61).

**FRAME SET/RESET**

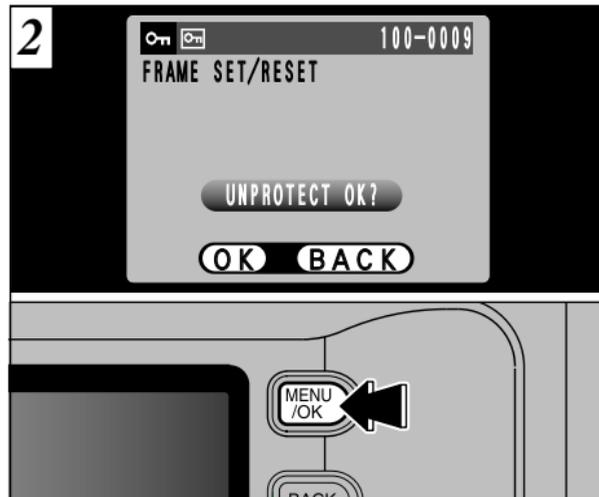
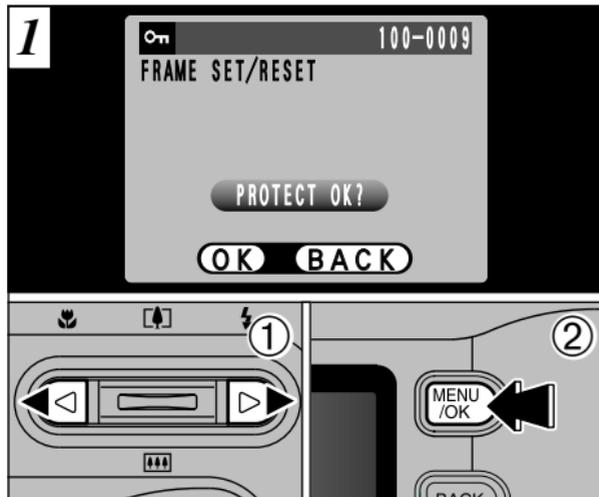

- ① Press “◀” or “▶” to select the file to be protected.
  - ② Press the “MENU/OK” button to protect the file currently displayed.
- To protect another file, repeat steps ① and ②.  
To finish protecting files, press the “BACK” button.

To remove the protection, press the “MENU/OK” button again.

**PROTECT ALL**



Press the “MENU/OK” button to protect all the files.

**UNPROTECT ALL**



Press the “MENU/OK” button to unprotect all the files.



DPOF stands for Digital Print Order Format and refers to a format that is used for recording printing specifications for images shot using a digital camera on media such as SmartMedia. The recorded specifications include information on which frames are to be printed.

This section gives a detailed description of how to order your prints with the FinePix F401. On the FinePix F401, you can specify only one print per image in the DPOF settings.

- \* Note that some printers do not support date and time imprinting or specification of the number of prints.
- \* Note that the warnings shown below may be displayed while you are specifying the prints.

DPOF SPECIFIED. ERASE OK ?

DPOF SPECIFIED. ERASE ALL OK ? (→P.60)

When you erase the image, the DPOF setting for that image is deleted at the same time.

RESET DPOF OK ? (→P.70)

If you load a SmartMedia that contains frames specified for printing on another camera, those print specifications are all reset and replaced by the new print specifications.

! DPOF FILE ERROR (→P.99)

Up to 999 frames can be specified on the same SmartMedia.

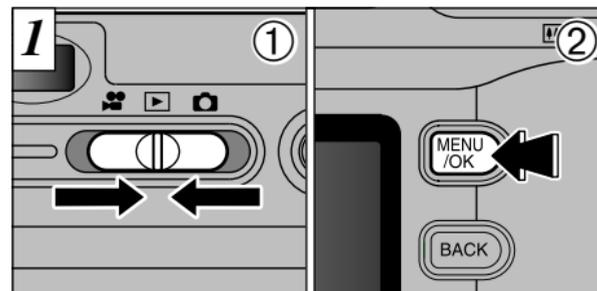

- ① Set the Mode switch to “P”.
- ② Press the “MENU/OK” button to display the menu screen.

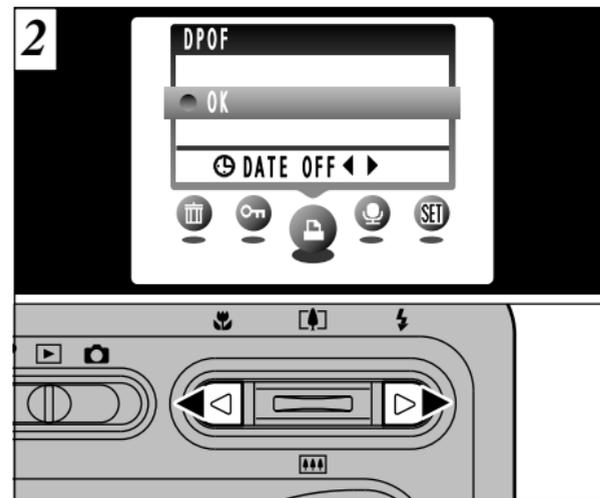

Use “◀▶” to select “P” DPOF.

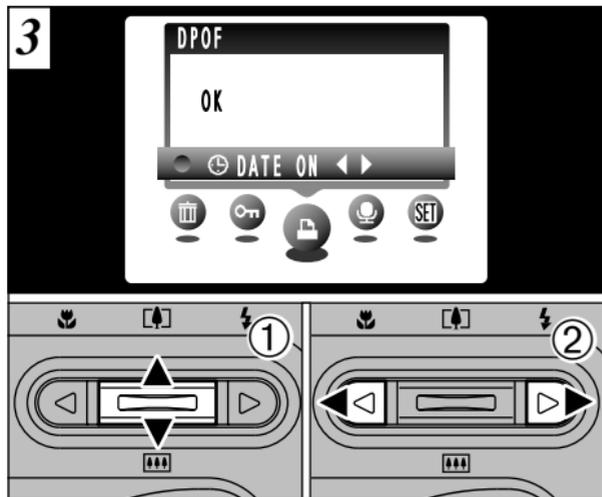

- ① Press “[▲]” or “[▼]” to select “DATE”.
- ② Use “◀” and “▶” to select “DATE ON” or “DATE OFF”.

The selected setting is then valid for all frames with DPOF settings.

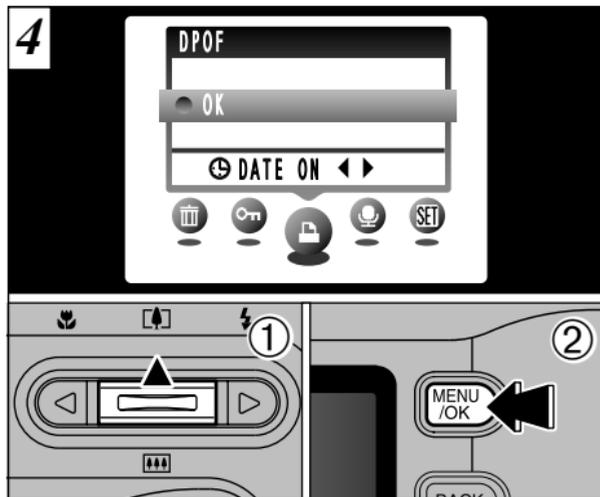

- ① Press “[▲]” to select “OK”.
- ② Press the “MENU/OK” button.

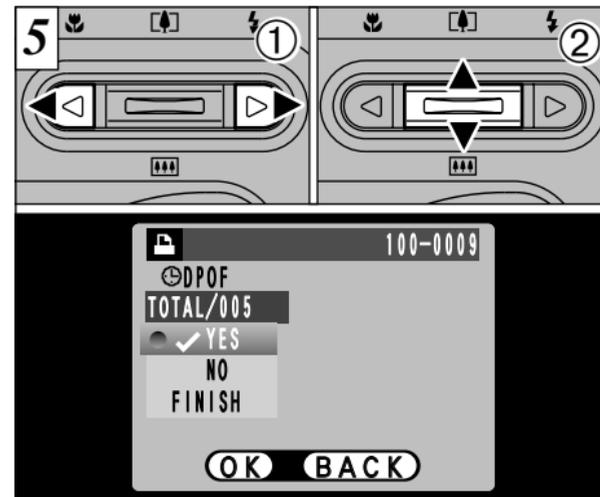

- ① Use “◀” or “▶” to display the frame for which you want to specify DPOF settings.
- ② Press “[▲]” or “[▼]” to set “YES” for the frame to be printed and then press the “MENU/OK” button or “▶”.

To specify more DPOF settings, repeat steps ① and ②.

- ⚠ DPOF settings cannot be specified for movies.
- ⚠ “TOTAL” shows the total number of frames for which prints have been ordered.



**When you have finished the settings, always select “FINISH” and press the “MENU/OK” button.**

If you press the “BACK” button, no DPOF settings are specified.

- ⚠ You can only specify one print per frame in the DPOF settings. Note also that you can specify prints for up to 999 frames on the same SmartMedia.

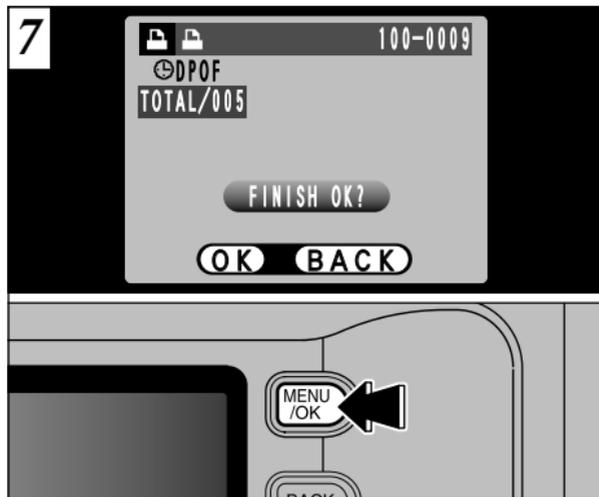

Pressing the “MENU/OK” button confirms the DPOF settings.  
Pressing the “BACK” button returns you to the settings screen **5**.

Pressing the “MENU/OK” button confirms all the settings.

◆ DPOF settings cannot be changed. ◆



If you select a frame for which DPOF settings have already been specified, the “RESET DPOF OK?” message appears.  
Pressing the “MENU/OK” button erases all of the DPOF settings already specified for each frame. You must then specify the DPOF setting for each frame again.

- ⚠ Press the “BACK” button to leave the previous settings unchanged.
- ⚠ During playback, check that the “” icon is displayed for the previous settings.

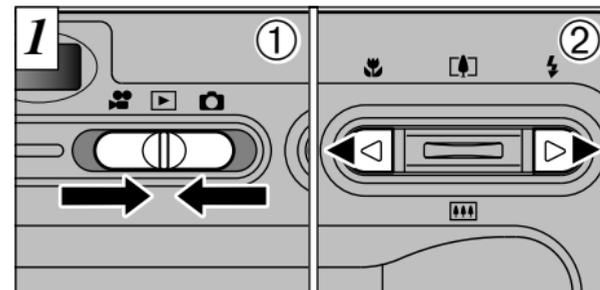

- ① Set the Mode switch to “▶”.
- ② Use “◀” and “▶” to select the image (still image) to which you want to add a voice memo.

- ⚠ You can also add voice memos to images (still images) shot on other cameras, provided they can be played back on this camera.
- ⚠ Voice memos cannot be added to movies.



- ① Press the “MENU/OK” button to display the menu screen.
- ② Use “◀▶” to select “” VOICE MEMO.
- ③ Press the “MENU/OK” button.

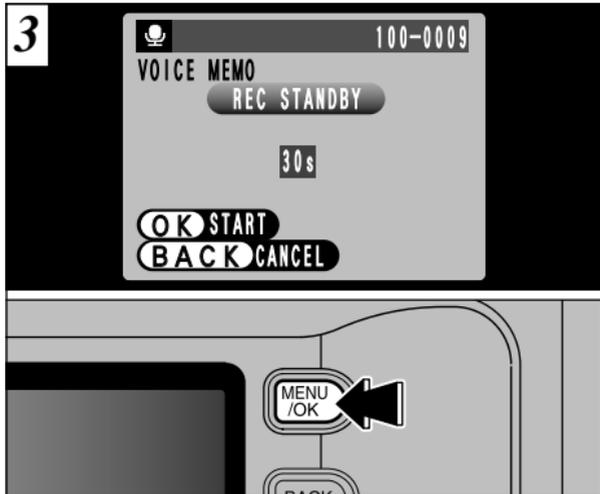

The “**REC STANDBY**” message appears on the LCD monitor. Recording begins when you press the “MENU/OK” button.

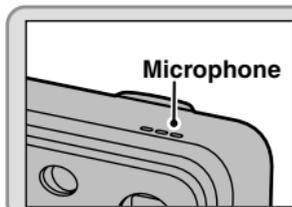

Face the microphone as you record the voice memo. Hold the camera roughly 20 cm (7.9 in.) away for the best results.

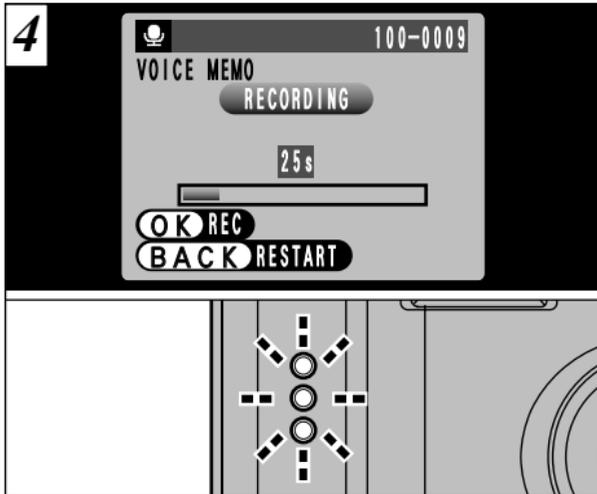

During recording, the remaining time is shown on the LCD monitor and the self-timer lamp flashes.

When the time remaining reaches 5 seconds, the self-timer lamp starts flashing quickly.

 To end your comment during recording, press the “MENU/OK” button.



When you have recorded 30 seconds of comment, the “**FINISH**” message appears on the LCD monitor.

**To finish:** Press the “MENU/OK” button.

**To re-record your comment:** Press the “BACK” button.

◆ When the image already has a voice memo ◆

If you select an image that already has a voice memo, a screen appears in which you can select whether or not to rerecord the caption.

## MODE PLAYING BACK VOICE MEMOS

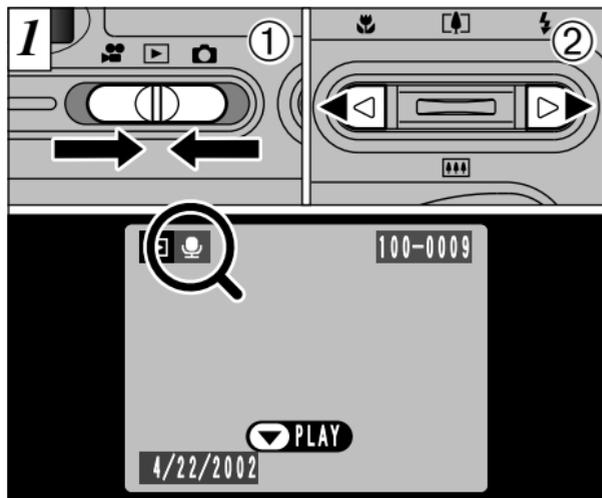

- ① Set the Mode switch to "▶".
- ② Use "◀" or "▶" to select an image file that has a voice memo.

⚠ You cannot play back voice memos using multi-frame playback. Use the "DISP" button to revert to normal playback.

The "🎤" icon is displayed.

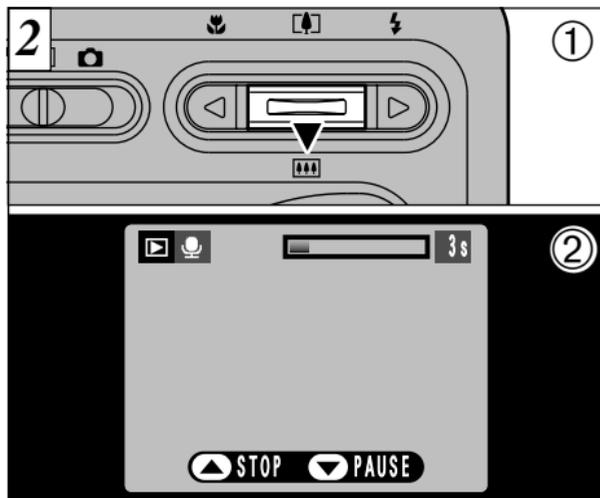

- ① Press "▶(🎤)" to play the voice memo.
- ② The LCD monitor shows the playback time and a playback progress bar.

⚠ Take care not to block the speaker.

⚠ If the sound is difficult to hear, adjust the volume (→P.77).

## ■ Playing back voice memos

	Control	Description
Playback		The voice memo automatically stops when playback ends.
Pause/Resume		Pauses the voice memo during playback. Press this button again to resume playback.
Stop		Stops playback. * Press "◀" or "▶" while voice memo playback is stopped to go back to the previous file or advance to the next file respectively.
Fast forward/Rewind	 Rewind      Fast forward	Press these during playback to skip forwards or backwards through the voice memo. * These buttons do not function while playback is paused.

\* Refer to the Software Quick Start Guide (provided) for information on playing back voice memos on your PC.

### ◆ Compatible voice memo files ◆

The FinePix F401 can play voice memo files recorded on a FinePix F401 and voice memo files up to 30 seconds long that were recorded on a FUJIFILM digital camera and stored on a 3.3V SmartMedia.

## SET ADJUSTING THE MONITOR BRIGHTNESS

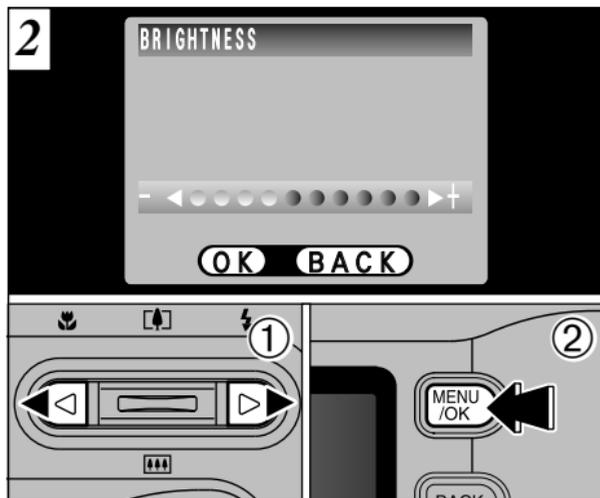
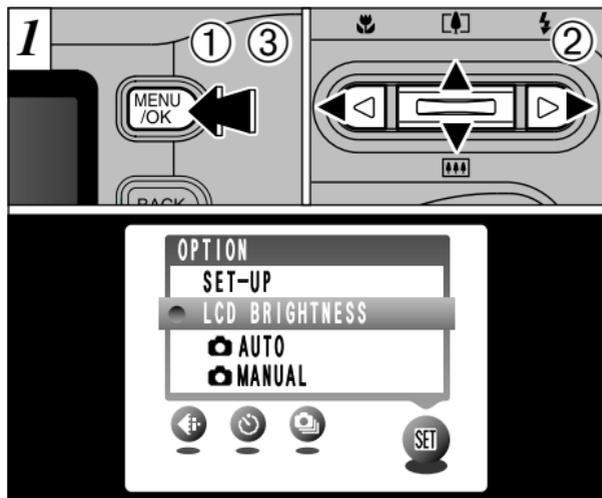

- ① Use “◀” or “▶” to adjust the LCD monitor brightness.
- ② Press the “MENU/OK” button.

⚠ To exit this procedure without changing the settings, press the “BACK” button.

## SET ADJUSTING THE VOLUME

The volume can only be adjusted in ▶ mode.

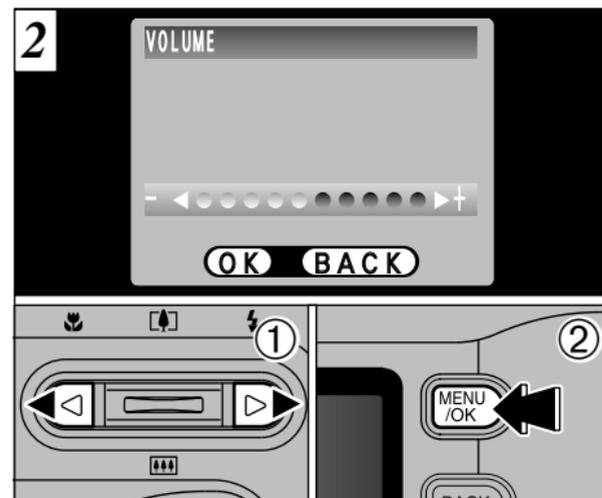
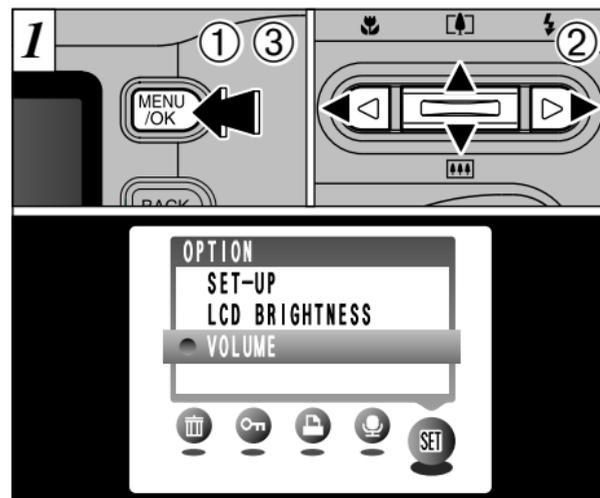

- ① Press “◀” or “▶” to adjust the speaker volume.
- ② Press the “MENU/OK” button.

⚠ To exit this procedure without changing the settings, press the “BACK” button.

## SET USING SET-UP

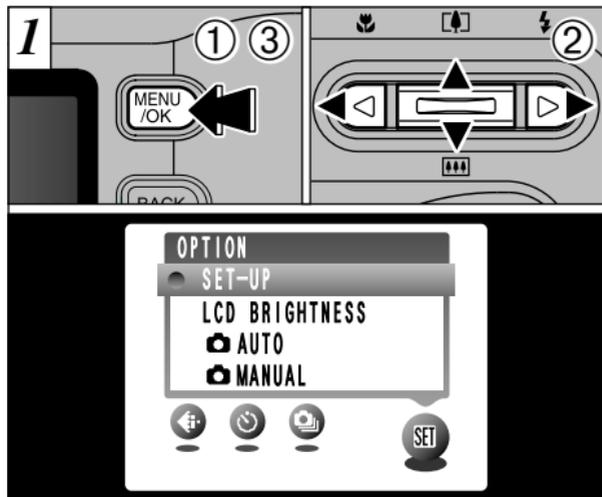

- ① Press “ (▲)” or “ (▼)” to select a menu option and then press “” or “” to change the setting.
- ② Press the “MENU/OK” button.

Press “” for “DATE/TIME” or “RESET ALL”.

You can set in any mode.

- ① Press the “MENU/OK” button to display the menu screen.
- ② Press “” or “” to select “” OPTION and then press “ (▲)” or “ (▼)” to select “SET-UP”.
- ③ Press the “MENU/OK” button.

78 The screen shown is for still photography.

## ■ SET-UP Menu Options (Date/time setting, etc.)

Settings	Display	Factory default	Explanation
POSTVIEW	ON/OFF	ON	This option specifies whether or not an image checking screen (photography results) is displayed after you take a shot. The photography results are displayed for about 2 seconds and then automatically recorded. In continuous shooting, the photography results are displayed for a set time before being automatically recorded even if this option is set to “OFF”.
POWER SAVE	2MIN/5MIN/OFF	2MIN	Use this option to specify whether the camera’s power consumption is reduced and the camera is subsequently switched off automatically when it is not being used. See P.80 for details.
USB MODE	DSC/PC CAM	DSC	See P.81 for details.
DATE/TIME	SET	—	Use this option to correct the date or time. See P.16 for details.
LCD	ON/OFF	ON	Use this option to specify whether the LCD monitor is automatically switched ON or OFF when the Mode switch is set to “”.
SOUND	LOW/HIGH/OFF	LOW	This option allows you to set the volume of the beep emitted when the camera controls are used.
LANGUAGE	ENGLISH/FRANCAIS/DEUTSCH	ENGLISH	Select English, French or German as the language used for screen display.
RESET ALL	OK	—	This resets all camera settings (including the photography and playback menu settings) other than the date and time to the factory default values set at shipment. When you press “”, a confirmation screen appears. To proceed, press the “MENU/OK” button again.

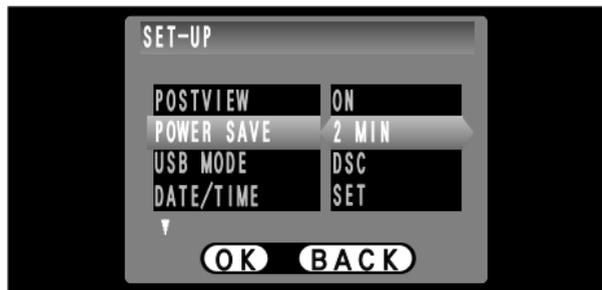

Once you enable this function, the monitor is temporarily switched off to reduce power consumption (Sleep mode) if the camera is not used for about 30 seconds. If the camera is then left unused for a further time (2 minutes or 5 minutes), it is automatically switched off. Use this function when you want to get the maximum possible running time from the battery.

⚠ Power Save is disabled when the camera is connected to a USB port.

The Sleep function does not operate when the LCD monitor is switched off or when the camera is in Setup or Playback mode. However, if the camera controls are not used for some time (2 minutes or 5 minutes), the camera automatically switches off.

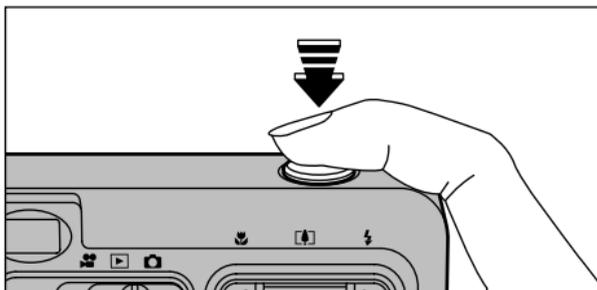

When the camera is in sleep mode, pressing the shutter button down halfway brings the camera back to full operational mode. This is a useful feature as it allows you to take pictures more quickly than switching the camera off and then on again. You can also take a picture by pressing the shutter button all the way down.

◆ **To restore power to the camera** ◆

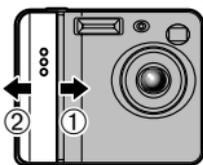

Use the power switch to turn the camera off briefly ① and then on again ②.

⚠ Operation can also be restored by pressing buttons other than the shutter button.

The “Connection” section explains how to connect the camera to your computer using the special USB cable and describes the functions you can use once the camera and computer are connected. **Refer also to the Software Quick Start Guide booklet.**

If the power cuts out during data transmission, the data cannot be transmitted correctly. Always use the AC power adapter when connecting the camera to a computer.

**The first time you connect the camera to your computer**

You must install all the software before connecting the camera to your computer. Refer also to the Software Quick Start Guide booklet.

**DSC (Mass storage device) Mode**

This mode provides a simple way to read images from a SmartMedia and store images on to a SmartMedia (⇒P.82).

**PC CAM (camera) Mode**

This function allows you to conduct videoconferencing sessions between PCs connected to the Internet. This function can also be used to record video on a PC (⇒P.84).

⚠ **Videoconferencing (“PictureHello”) is not supported on Macintosh computers.**  
 ⚠ The PC Camera function cannot be used on Mac OS X (including the Classic environment). Use a Mac OS version between 8.6 and 9.2.



CD-ROM  
(Software for FinePix EX)



Software Quick Start Guide

## CONNECTING AT DSC MODE

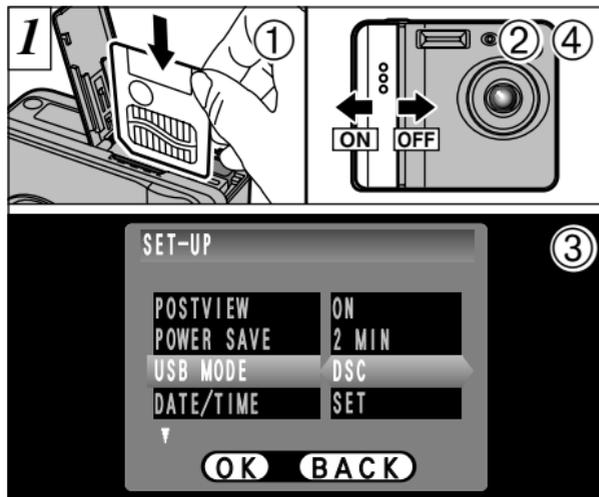

- 1 Load a SmartMedia containing photographed images into your camera. Plug the AC power adapter connector into the DC IN 5V socket on the camera and then plug the adapter itself into the main power outlet.
- 2 Slide the POWER switch to the side to turn the camera on.
- 3 Set the "USB MODE" setting in the SET-UP menu to "DSC" (⇒P.78, 79).
- 4 Slide the POWER switch to the side to turn the camera off.

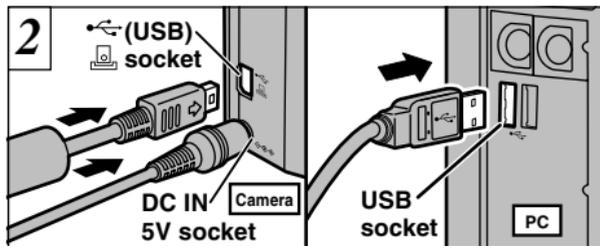

- 1 Switch your PC on.
- 2 Use the special FinePix F401 USB cable to connect the camera to your computer.
- 3 Switch the camera on.

If you are using a Windows PC, the driver settings are specified automatically when installation is completed. No further action is required.  
\* If your PC fails to recognize the camera, refer to the Software Quick Start Guide.

Always use the prescribed procedure when disconnecting or switching off the camera (⇒P.86).

- ! On Windows XP and Mac OS X, you must specify the automatic launch settings the first time you connect the camera to your computer (⇒Software Quick Start Guide booklet).
- ! Take care to ensure that the special FinePix F401 USB cable is connected the correct way around and that the plugs are pushed fully into the connection sockets.

## Camera Operation

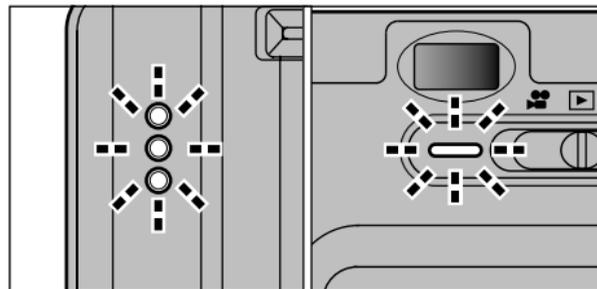

- When the camera and computer are exchanging data, the self timer lamp flashes and the viewfinder lamp flashes alternately green and orange.
  - "DSC" appears on the LCD monitor.
  - Power Save is disabled when the camera is connected to a USB port.
- 
- ! Before replacing the SmartMedia, always disconnect the camera from the PC using the procedure on P.86.
  - ! Do not disconnect the USB cable when the camera is communicating with the PC. See P.86 for information on the disconnection procedure.

## PC Operation

- FinePixViewer automatically starts up.



- A removable disk icon appears and you can use your PC to transfer files to and from the camera.

Windows  
  
Removable  
Disk

Macintosh  
  
untitled

If the above operations do not occur, you do not have the required software programs or drivers installed on your PC. Refer to the Software Quick Start Guide booklet and complete the required PC setup procedures. Then reconnect the camera to your PC.

## CONNECTING AT PC CAMERA MODE

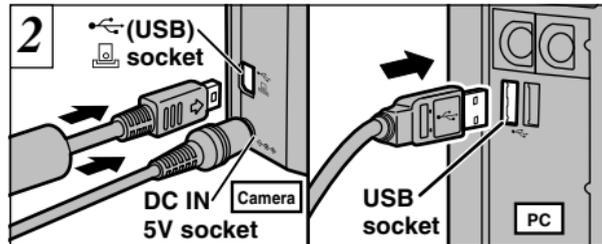

- ① Switch your PC on.
- ② Use the special FinePix F401 USB cable to connect the camera to your computer.
- ③ Switch the camera on.

If you are using a Windows PC, the driver settings are automatically specified when installation ends. Just wait a few moments.  
\* If your PC fails to recognize the camera, refer to the Software Quick Start Guide.

Always use the prescribed procedure when disconnecting or switching off the camera (→P.86).

- ⚠ Take care to ensure that the special FinePix F401 USB cable is connected the correct way around and that the plugs are pushed fully into the connection sockets.

### Camera Operation

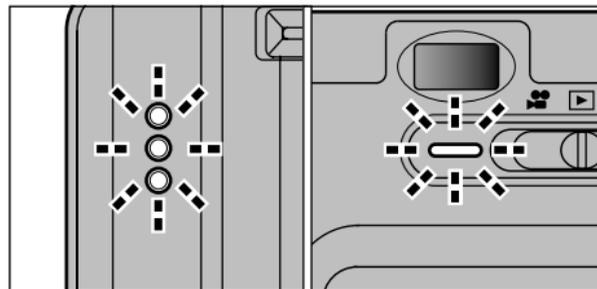

- When the camera and computer are exchanging data, the self timer lamp flashes and the viewfinder lamp flashes alternately green and orange.
  - The lens is fixed at the wide-angle zoom setting.
  - “PC CAMERA” appears on the LCD monitor.
  - Power Save is disabled when the camera is connected to a USB port.
- ⚠ If you switch the power on with the “PC Camera” USB setting selected, the color tones shown on the LCD monitor may differ.
  - ⚠ Do not disconnect the USB cable when the camera is communicating with the PC. See P.86 for information on the disconnection procedure.

### PC Operation

- FinePixViewer automatically starts up and the PictureHello window opens (Windows only).



\* Screen for Windows 98 SE

- You can use VideoImpression to view live images.



\* Screen for Macintosh

If the above operations do not occur, you do not have the required software programs or drivers installed on your PC. Refer to the Software Quick Start Guide booklet and complete the required PC setup procedures. Then reconnect the camera to your PC.

## DISCONNECTING FROM THE PC (Important — always use this procedure.)

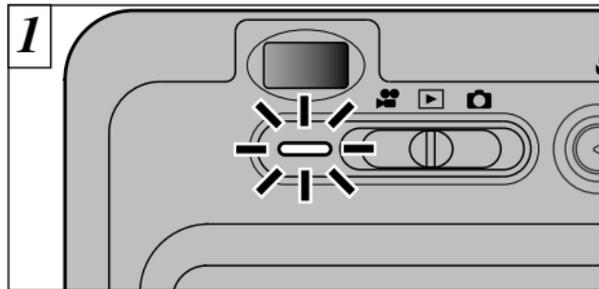

- 1 Quit all applications (FinePixViewer, VideoImpression, etc.) that are using the camera.
- 2 Check that the viewfinder lamp is lit green or that the self timer lamp is off (no data is being exchanged with the computer).

For a DSC connection, proceed to step 2.  
For a PC CAMERA connection, proceed to step 3.

- Even when "Copying" is no longer displayed on the computer, the camera and the computer may still be exchanging data. Always check that the viewfinder lamp is lit green or that the self timer lamp is off.

- 2 Perform the steps shown below before you switch the camera off. This procedure differs depending on the operating system software (or PC) you are using.

### Windows 98 or 98 SE

No PC operation is needed.

### Windows Me/2000 Professional/XP

- 1 Right-click the removable disk icon in the "My Computer" window and select Eject. This step is only required in Windows Me.



- 2 Left-click the Eject icon in the taskbar and eject "USB Disk".



\* Screen for Windows Me

- 3 The menu option shown below appears. Click on this option.



\* Screen for Windows Me

- 4 The "Eject hardware" dialog box appears. Click the [OK] button or the close button.

### Macintosh

Drag the "Removable drive" icon on the desktop to the Trash.



- When you drag the icon to the Trash, "REMOVE OK" appears on the camera's LCD monitor.

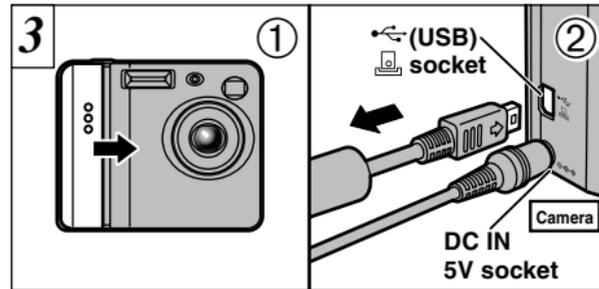

- 1 Switch the camera off.
- 2 Unplug the special FinePix F401 USB cable from the camera.

## System Expansion Options

- By using the FinePix F401 together with other optional FUJIFILM products, your system can be expanded to fill a wide range of uses.

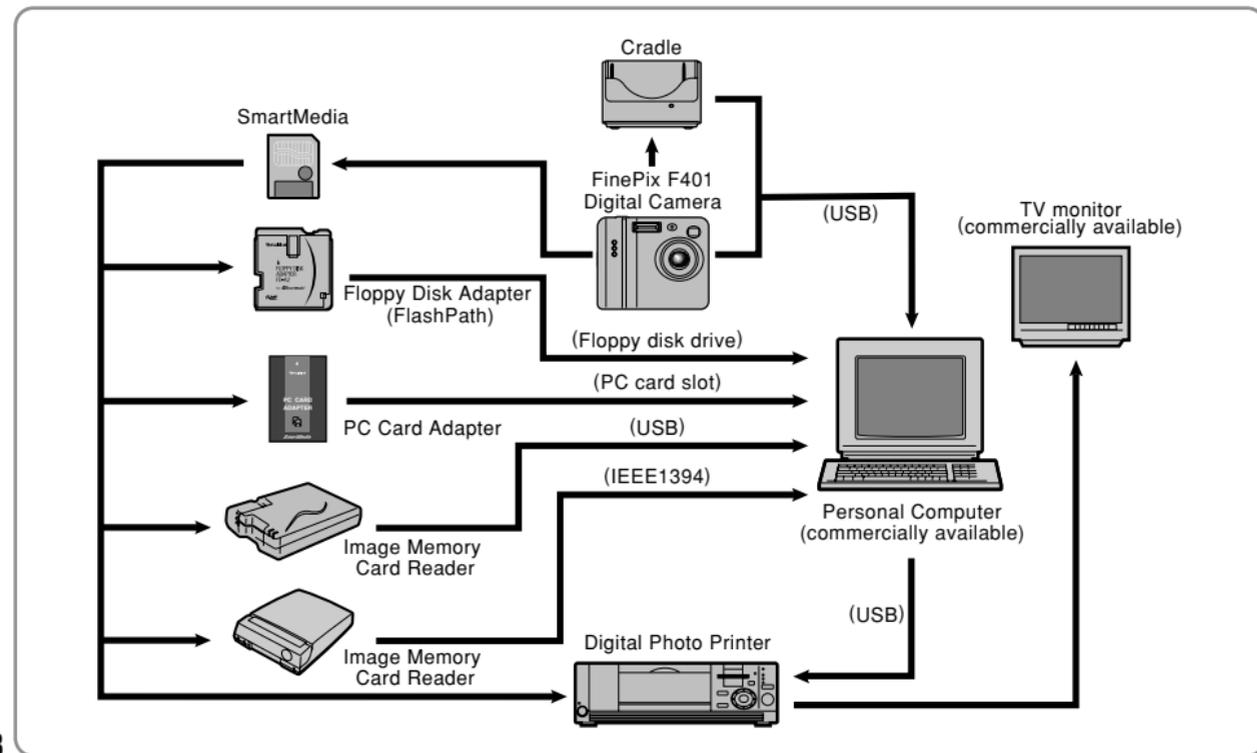

## Accessories Guide

- The optional accessories (sold separately) can make taking pictures with the FinePix F401 even easier. For information on how to attach and use the accessories, refer to the instructions provided with the accessory used. Visit the FUJIFILM web site for the latest information on camera accessories. <http://home.fujifilm.com/products/digital/index.html>

### ● SmartMedia™

These are SmartMedia cards sold separately. Use the 9 types listed below.

- MG-4S : 4MB, 3.3V
- MG-8S : 8MB, 3.3V
- MG-16S : 16MB, 3.3V
- MG-32S : 32MB, 3.3V
- MG-64S : 64MB, 3.3V
- \* Some 3.3V SmartMedia are labelled as "3V" cards.
- MG-16SW : 16MB, 3.3V, ID
- MG-32SW : 32MB, 3.3V, ID
- MG-64SW : 64MB, 3.3V, ID
- MG-128SW : 128MB, 3.3V, ID
- \* SmartMedia with ID are labelled as "ID" cards.

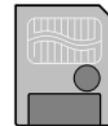

### ● BC-60 Battery Charger

Quickly charges the rechargeable battery. The BC-60 reduces charging time to approximately 2 hours (for the NP-60).



### ● NP-60 Rechargeable Battery

Lithium-ion slimline rechargeable battery.



### ● AC-5VH/AC-5VHS AC Power Adapter

Use the AC-5VH/AC-5VHS when you want to take pictures or play back images for long periods or when the FinePix F401 is connected to a personal computer. \* The shape of the AC power adapter, the plug and socket outlet depend on the country.



### ● PictureCradle CP-FX401

If you connect the AC power adapter and USB cable to this cradle, you can charge the camera battery or connect the camera to your computer just by placing the camera in the cradle.



### ● SC-FX401

This is designed to protect the camera against dirt, dust and light knocks while you are carrying it.

### ● **FD-A2 Floppy Disk Adapter (FlashPath)**

This adapter is the same size and shape as a 3.5-inch floppy disk. You can copy the images on a SmartMedia to your PC simply by loading the SmartMedia into the floppy disk adapter and then inserting the adapter into your floppy disk drive.



	Compatible OS	Compatible SmartMedia
FD-A2	Windows 95/98/98 SE/Me/NT4.0 Mac OS 7.6.1 to 9.1	5V/3.3V, 2MB to 128MB

### ● **SM-R2 Image Memory Card Reader**

The SM-R2 allows images to very easily be read and written from an image memory card (SmartMedia) to a personal computer. Its USB interface provides high-speed data transmission.

- Compatible with Windows 98/98 SE, Windows Me, Windows 2000 Professional or iMac and models that support USB as standard.



### ● **DM-R1 Image Memory Card Reader**

This device provides a simple way to transfer image data in either direction between your PC and an image memory card (SmartMedia or CompactFlash Type II (Microdrive-compatible)).

The IEEE 1394 interface provides high-speed data transfer.

- Compatible with Windows 98 SE, Windows 2000 Professional (read-only), iMac DV and Power Macintosh PCs with FireWire as a standard feature. Mac OS 8.5.1 to 9.1



### ● **PC-AD3 PC Card Adapter**

The PC Card Adapter allows the SmartMedia to be used as a PC Card Standard ATA-compliant (PCMCIA 2.1) PC card (Type II).

- Compatible with SmartMedia of 5V/3.3V, 2MB to 128MB.



► Be sure to read this information in conjunction with “Safety Notes” (⇒P.108), to ensure that you use your camera correctly.

### ■ **Places to Avoid**

Do not store or use the camera in the following types of locations:

- In the rain or in very humid, dirty or dusty places.
- In direct sunlight or in places subject to extreme temperature rises, such as in a closed car in summer.
- Extremely cold places.
- Places subject to strong vibration.
- Places affected by smoke or steam.
- Places subject to strong magnetic fields (such as near motors, transformers or magnets).
- In contact with chemicals such as pesticides or next to rubber or vinyl products for long periods of time.

### ■ **Notes on Immersion in Water or Sand**

The FinePix F401 is particularly adversely affected by water and sand. When you are at the beach or close to water, ensure that the camera is not exposed to water or sand. Take care also not to place the camera on a wet surface. Water or sand inside the camera can cause faults that may be irreparable.

### ■ **Notes on Condensation**

If the camera is carried suddenly from a cold location into a warm place, water droplets (condensation) may form on the inside of the camera or on the lens. When this occurs, switch the camera off and wait an hour before using the camera. Condensation may also form on the SmartMedia

card. In this event, remove the SmartMedia and wait a short time before using it again.

### ■ **When the Camera is Unused for Long Periods**

If you do not intend to use the camera for a long period of time, remove the battery and the SmartMedia card before storing the camera.

### ■ **Cleaning Your Camera**

- Use a blower brush to remove dust from the lens, LCD monitor screen or viewfinder as these surfaces, and then wipe lightly with a soft, dry cloth. If any soiling remains, apply a small amount of lens cleaning liquid to a piece of FUJIFILM lens cleaning paper and wipe gently.
- Do not scratch hard objects against the lens, LCD monitor screen or viewfinder as these surfaces are easily damaged.
- Clean the body of the camera with a soft, dry cloth. Do not use volatile substances such as thinners, benzine or insecticide, as these may react with camera body and cause deformation or remove the coating.

### ■ **Using the Camera Overseas**

When travelling overseas, do not place your camera in the check-in baggage. Baggage handling at airports may subject baggage to violent shocks, and the camera may be damaged internally even when no external damage is visible.

# Notes on the Power Supply

## Notes on Using the Battery (NP-60)

This camera uses the Rechargeable Lithium-ion Battery Pack NP-60. Note the points below when using the rechargeable battery. Take particular care to read the Safety Notes to ensure that you use the battery correctly.

\*When shipped, the NP-60 is not fully charged. Always charge the NP-60 before using it.

● When carrying the NP-60, install it in a digital camera or keep it in the soft case.

● When storing the NP-60, place it inside the special soft case provided.

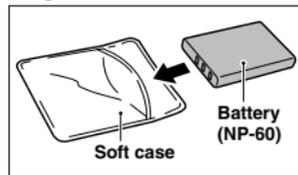

## Battery Features

● The NP-60 gradually loses its charge even when not used. Use a NP-60 that has been charged recently (in the last day or two) to take pictures.

● To maximize the life of the NP-60, switch the camera off as quickly as possible when it is not being used.

● The number of available shots will be lower in cold locations or at low temperatures. Take along a spare fully charged NP-60.

You can also increase the amount of power produced by putting the NP-60 in your pocket or another warm place to heat it and then loading it into the camera just before you take a picture.

If you are using a heating pad, take care not to place the NP-60 directly against the pad. The camera may not operate if you use a depleted NP-60 in cold conditions.

## Charging the Battery

● You can charge the NP-60 using the AC Power Adapter AC-5VS/AC-5VHS.

● The NP-60 can be charged at ambient temperatures between 0°C and +40°C (+32°F and +104°F). At an ambient temperature of +23°C (+73°F), it takes approximately 3 hours to charge a fully depleted NP-60 battery.

● You should charge the NP-60 at an ambient temperature between +10°C and +35°C (+50°F and +95°F). If you charge the NP-60 at a temperature outside this range, charging takes longer because the performance of the NP-60 is impaired.

● You cannot charge the NP-60 at temperatures of 0°C (+32°F) or below.

● You can also use the optional BC-60 Battery Charger to charge the NP-60.

● The NP-60 can be charged using the BC-60 Battery Charger at ambient temperatures between 0°C and +40°C (+32°F and +104°F). At an ambient temperature of +23°C (+73°F), it takes approximately 2 hours to charge a fully depleted NP-60 battery.

● You should charge the NP-60 at an ambient temperature between +10°C and +35°C (+50°F and +95°F). If you charge the NP-60 at a temperature outside this range, charging takes longer because the performance of the NP-60 is impaired.

● The NP-60 does not need to be fully discharged or exhausted flat before being charged.

● The NP-60 may feel warm after it has been charged or immediately after being used. This is perfectly normal.

● Do not recharge a fully charged NP-60.

## Battery Life

At normal temperatures, the NP-60 can be used at least 300 times.

If the time for which the NP-60 provides power shortens markedly, this indicates that the NP-60 has reached the end of its effective life and should be replaced.

## Notes on storage

Lithium-ion Battery Pack NP-60 is both compact and capable of storing large quantities of power. However, if it is stored for long periods while charged, the performance of the battery can be impaired.

● If the battery will not be used for some time, run the battery flat before storing it.

● Always remove the battery from the camera or battery charger when it is not being used.

● Place the battery pack inside the soft case and store in a cool place.

\*The battery should be stored in a dry location with an ambient temperature between +15°C and +25°C (+59°F and +77°F).

\*Do not leave the battery in hot or extremely cold places.

## Handling the Battery

### To avoid injury or damage, observe the following:

● Do not allow the metal portions of the battery to touch other metal objects.

● Do not bring the battery close to a flame or throw it into a fire.

● Do not attempt to disassemble or modify the battery.

● Do not recharge the battery with chargers other than those specified.

● Dispose of used batteries promptly.

### To avoid damaging the battery or shortening its life, observe the following:

● Do not drop the battery or otherwise subject it to strong impacts.

● Do not immerse the battery in water.

### To ensure that you obtain optimum battery performance, observe the following:

● Always keep the battery terminals clean.

● Store the battery in a cool, dry place. Storing the battery for long periods in a hot location can shorten the battery life.

**If you use the battery for a long period, the camera body and the battery itself will become warm. This is normal and is not a malfunction. Use the AC power adapter supplied with the camera if you are taking pictures or viewing images for a long period of time.**

## Specifications of the Enclosed NP-60

Nominal voltage	DC 3.7V
Nominal capacity	1035mAh
Operating temperature	0°C to +40°C (+32°F to +104°F)
Dimensions	35.2 mm × 53 mm × 7.0 mm (1.39 in. × 2.1 in. × 0.28 in.) (W × H × D)
Mass (Weight)	Approx. 30g (1.05 oz.)

\* These specifications are subject to change without notice.

### AC Power Adapter

Use only the AC-5VS/AC-5VHS AC Power Adapter with your FinePix F401 Digital Camera. The use of other AC power adapters may result in damage to your camera.

- The AC Power Adapter is only intended for indoor use.
- Push the connection cord plug firmly into the DC input socket.
- When unplugging the connector cord, switch the camera off and pull out the plug by grasping the plug itself. (Do not pull on the cord.)
- Do not use the AC power adapter with any device except the specified device.
- During use, the AC power adapter will become hot to touch, but this is normal.
- Do not disassemble the AC power adapter. Doing so could be dangerous.
- Do not use the AC power adapter in a place with high temperature and high humidity.
- Do not drop or subject the AC power adapter to strong shocks.
- The AC power adapter may emit a humming noise, but this is normal.
- If used near a radio, the AC power adapter may cause static, so play the radio in a distant place.

\*Very occasionally, DC output will be prevented by the operation of the internal protection circuit. In this event, unplug the AC-5VS/AC-5VHS AC power

adapter from the power socket for a few moments and then plug it in again. This will restore DC output.

#### ■ Specifications (AC-5VS/AC-5VHS)

Power Supply	AC 100V to 240V, 50/60Hz
Rated Input Capacity	12W (U.S.A. and Canada) 0.15A to 0.24A (other countries)
Rated Output	DC 5.0V 1.5A (U.S.A. and Canada) DC 5.0V 2.0A (other countries)
Temperature During Use	0°C to +40°C (+32°F to +104°F) (U.S.A. and Canada) 0°C to +45°C (other countries)
Storage Temperature	-10°C to +70°C (+14°F to +158°F)
Dimensions (MAX.)	47 mm × 20 mm × 72 mm (1.9 in. × 0.8 in. × 2.8 in.) (W × H × D) (U.S.A. and Canada) 49 mm × 40 mm × 65 mm (W × H × D) (U.K.) 49 mm × 31 mm × 65 mm (W × H × D) (other countries)
Mass (Weight)	Approx. 120 g (4.2 oz.) (U.S.A. and Canada) Approx. 200 g (7.0 oz.) (U.K.) Approx. 180 g (6.4 oz.) (other countries)
Connection Cord Length	Approx. 2 m (6.6 ft.)

\*Please note that specifications and characteristics are subject to change without notice.

### ■ SmartMedia

The SmartMedia card supplied with your FinePix F401 camera is a new image recording medium developed especially for use in digital cameras. Each SmartMedia card contains a built-in semiconductor memory chip (NAND flash memory) which is used for storing digital image data.

Because the data is stored electronically, the stored image data can be erased from the card and new data recorded.

### ■ SmartMedia with IDs

The SmartMedia ID is a SmartMedia that has an individually assigned identification number. SmartMedia ID cards can be used with devices that use ID numbers for copyright protection or other purposes. This camera accepts SmartMedia ID cards in the same way as conventional SmartMedia cards.

### ■ Storing Data

In the situations listed below, recorded data may be erased (destroyed). Please note that Fuji Photo Film Co., Ltd. accepts no responsibility whatsoever for the loss (destruction) of recorded data.

- \*When the SmartMedia is used incorrectly by the owner or a third party
- \*When the SmartMedia is exposed to static electricity or electrical noise
- \*When the battery cover is opened or the SmartMedia removed and the camera is then switched off during data recording, during data erasing (SmartMedia formatting) or during frame advance when images are being played back.

You should always back up important files onto another media (MO disk, CD-R, CD-RW, hard disk, etc.).

### ■ Notes on Handling SmartMedia

- Take care to hold the SmartMedia straight when you load it into your camera.
- Never remove the SmartMedia or switch the camera off during data recording, during data erasing (SmartMedia formatting) or during frame advance when images are being played back. These actions could result in damage to the SmartMedia.
- Use only the SmartMedia specified for use with the FinePix F401. The use of other SmartMedia could damage the camera.
- SmartMedia are precision electronic devices. Do not bend, drop, or subject SmartMedia to excessive shocks.
- Do not use or store SmartMedia in environments likely to be affected by strong static electricity or electrical noise.
- Do not use or store SmartMedia in very hot, humid or corrosive environments.
- Take care not to touch the SmartMedia's contact area or allow the area to become soiled. Use a dry lint-free cloth to wipe away any soiling that does occur.
- To avoid damage caused by static electricity, always use the special static-free case provided during transportation or storage, or keep the SmartMedia in a storage case if available.

- Do not carry SmartMedia in locations such as a trouser pocket. This could subject the SmartMedia to excessive force when you sit down, thereby damaging the SmartMedia.
- The SmartMedia may feel warm when it is removed from the camera after extended periods of picture taking or image viewing. This is normal and does not indicate a fault.
- Inserting a SmartMedia that is charged with static electricity into your camera may result in a camera malfunction. If this occurs, switch the camera off and then on again.
- Affix the label onto the designated area of the card. Do not use third-party labels as this can lead to problems when the card is inserted or removed.
- When you attach the label, take care that it does not cover any of the write-protect area.

### ■ Notes on Using SmartMedia with a PC

- If you intend to take photos using a SmartMedia that has been used on a PC, format the SmartMedia on your camera.
- When you format a SmartMedia in the camera and then shoot and record images, a directory (folder) is automatically created. Image data is then recorded in this directory.
- Do not change or delete the directory (folder) names or file names on the SmartMedia from your PC as this will make it impossible to use the SmartMedia in your camera.

- Always use the camera to erase image data on a SmartMedia.
- To edit image data, copy the image data to the PC's hard disk and then edit the copied data.
- Do not copy files other than those that will be used by the camera.

**Be sure to use your PC's disk eject function (right-click the removable disk icon in the "My Computer" window and then click "Eject") when you eject a SmartMedia from the PC card reader or PC card adapter.**

**When you are using a USB connection, you should also select and left-click the eject button for "USB disc/mass storage" in the taskbar. If you do not use the correct eject procedure, the SmartMedia may be damaged due to write-behind caching.**

### ■ Specifications

Type	Image memory card for digital cameras (SmartMedia)
Operating voltage	3.3V
Conditions for use	Temperature: 0°C to +40°C (+32°F to +104°F) Humidity: 80% or less (no condensation)
Dimensions	37 mm × 45 mm × 0.76 mm (1.45 in. × 1.77 in. × 0.03 in.) (W × H × D)

## Warning Displays

▶ The table below lists the warnings that are displayed on the LCD monitor

Warning Displayed	Explanation	Remedy
 (Lit red)  (Blinking red)	The battery in the camera is fully depleted or very low on charge.	Replace the battery or have new battery ready.
	There is a strong likelihood of camera shake because the shutter speed is slow.	Use flash photography. However, a tripod should be used for some scenes and modes.
	Outside the AE continuous range.	The shot can be taken, but the exposure will not be correct.
	The AF (auto focus) cannot work effectively.	<ul style="list-style-type: none"> <li>If the image is too dark, take the picture at a distance of around 2 m (6.6 ft.) from the subject.</li> <li>Use AF lock to take the picture.</li> </ul>
	There is no SmartMedia loaded or a 5 V SmartMedia is loaded the wrong way round.	Load the SmartMedia (3.3V) in the correct direction.
	<ul style="list-style-type: none"> <li>The SmartMedia is not formatted.</li> <li>The SmartMedia contact area is soiled.</li> </ul>	<ul style="list-style-type: none"> <li>Format the SmartMedia.</li> <li>Wipe the contact area on the SmartMedia with a soft dry cloth. It may be necessary to format the SmartMedia. If the error message is still displayed, replace the SmartMedia.</li> <li>Contact your FUJIFILM dealer.</li> </ul>
	<ul style="list-style-type: none"> <li>The SmartMedia contact area is soiled.</li> <li>The SmartMedia is damaged.</li> <li>The SmartMedia format is incorrect.</li> </ul>	<ul style="list-style-type: none"> <li>Wipe the contact area on the SmartMedia with a soft dry cloth. It may be necessary to format the SmartMedia. If the error message is still displayed, replace the SmartMedia.</li> <li>Contact your FUJIFILM dealer.</li> </ul>
	The SmartMedia is fully recorded.	Erase some images or use a SmartMedia that has ample free space.

## Warning Displays

Warning Displayed	Explanation	Remedy
	The SmartMedia is write-protected.	Use a SmartMedia that is not write-protected.
	<ul style="list-style-type: none"> <li>The file played back was not recorded correctly.</li> <li>The SmartMedia contact area is soiled.</li> <li>Camera fault.</li> <li>You attempted to play a movie that was not recorded on this camera.</li> </ul>	<ul style="list-style-type: none"> <li>Images cannot be played back.</li> <li>Wipe the contact area on the SmartMedia with a soft dry cloth. It may be necessary to format the SmartMedia. If the error message is still displayed, replace the SmartMedia.</li> <li>Contact your FUJIFILM dealer.</li> <li>Movies cannot be played back.</li> </ul>
	The frame number has reached 999–9999.	Take the shot using a formatted SmartMedia.
	<ul style="list-style-type: none"> <li>The data could not be recorded due to a SmartMedia error or a connection error between the SmartMedia and camera.</li> <li>The photographed image cannot be recorded as it is too large to fit in the available space on the SmartMedia.</li> </ul>	<ul style="list-style-type: none"> <li>Re-insert the SmartMedia or switch the camera off and then on again.</li> <li>Use a new SmartMedia.</li> </ul>
	<ul style="list-style-type: none"> <li>The voice memo file is faulty.</li> <li>Camera fault.</li> </ul>	<ul style="list-style-type: none"> <li>The voice memo cannot be played back.</li> <li>Contact your FUJIFILM dealer.</li> </ul>
	A protected file was erased.	Protected files cannot be erased. Remove the protection.

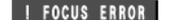
Warning Displayed	Explanation	Remedy
	Prints were specified for more than 1000 frames in the DPOF frame settings.	The maximum number of frames for which prints can be specified on the same SmartMedia is 999. Copy the images for which you want to order prints onto another SmartMedia and then specify the DPOF settings.
 	Camera malfunction or fault.	<ul style="list-style-type: none"> <li>Switch the camera on again, taking care not to touch the lens.</li> <li>Switch the camera off and on again.</li> </ul>
	The lens cover is faulty.	<ul style="list-style-type: none"> <li>Switch the camera on again, taking care not to touch the lens.</li> <li>Switch the camera off and on again.</li> </ul>

# Troubleshooting

► If you think the camera is faulty, check the following once more

Troubleshooting	Possible causes	Solutions
I tried to charge the battery but the self-timer lamp does not light.	<ul style="list-style-type: none"> <li>• There is no battery in the camera.</li> <li>• The camera and AC power adapter are not connected correctly.</li> </ul>	<ul style="list-style-type: none"> <li>• Load the battery.</li> <li>• Connect the camera and AC power adapter correctly.</li> </ul>
The self-timer lamp flashes during charging and I can't charge the battery.	<ul style="list-style-type: none"> <li>• The battery terminals are dirty.</li> <li>• The battery is faulty or flat.</li> </ul>	<ul style="list-style-type: none"> <li>• Take the battery out briefly and then reload it.</li> <li>• Wipe the battery terminals with a clean, dry cloth.</li> <li>• Load a new battery.</li> </ul>
No power.	<ul style="list-style-type: none"> <li>• The battery is exhausted.</li> <li>• The AC power adapter plug has come out of the power outlet.</li> <li>• The battery is loaded the wrong way round.</li> </ul>	<ul style="list-style-type: none"> <li>• Load a new fully charged battery.</li> <li>• Plug the adapter back in.</li> <li>• Load the battery in the correct direction.</li> </ul>
Power cuts out during operation.	The battery is exhausted.	Load a new fully charged battery.
Battery runs out quickly.	<ul style="list-style-type: none"> <li>• Camera is being used in extremely cold conditions.</li> <li>• The terminals are soiled.</li> <li>• The battery is flat.</li> </ul>	<ul style="list-style-type: none"> <li>• Put the battery in your pocket or another warm place to heat it and then load it into the camera just before you take a picture.</li> <li>• Wipe the battery terminals with a clean, dry cloth.</li> <li>• Load a new fully charged battery.</li> </ul>
No photograph is taken when the shutter button is pressed.	<ul style="list-style-type: none"> <li>• No SmartMedia is loaded.</li> <li>• The SmartMedia is fully recorded.</li> <li>• The SmartMedia is write-protected.</li> <li>• The SmartMedia is not formatted.</li> <li>• The SmartMedia contact area is soiled.</li> </ul>	<ul style="list-style-type: none"> <li>• Load a SmartMedia.</li> <li>• Insert a new SmartMedia or erase some unwanted frames.</li> <li>• Remove the write-protection.</li> <li>• Format the SmartMedia.</li> <li>• Wipe the SmartMedia contact area with a clean dry cloth.</li> </ul>

Troubleshooting	Possible causes	Solutions
No photograph is taken when the shutter button is pressed.	<ul style="list-style-type: none"> <li>• The SmartMedia is damaged.</li> <li>• The Power Save function has switched the camera off.</li> <li>• The battery is exhausted.</li> </ul>	<ul style="list-style-type: none"> <li>• Load a new SmartMedia.</li> <li>• Switch the camera on.</li> <li>• Load a new fully charged battery.</li> </ul>
I can't use the flash to take pictures.	<ul style="list-style-type: none"> <li>• The shutter button was pressed while the flash was charging.</li> <li>• The battery is exhausted.</li> <li>• The Suppressed Flash mode is selected.</li> </ul>	<ul style="list-style-type: none"> <li>• Wait until charging is completed before pressing the shutter button.</li> <li>• Load a new fully charged battery.</li> <li>• Set the flash mode to Auto, Red-eye Reduction or Forced Flash (The flash cannot be used in some modes).</li> </ul>
I can only select "Suppressed Flash" flash mode.	Continuous shooting is selected.	Set continuous shooting to OFF.
I can only select the "M" resolution setting.	The sensitivity is set to 800 or 1600 (high-sensitivity photography) in the Photography menu.	In the Photography menu, set the sensitivity to 400 or less.
The photographed image is dark even though I used the flash.	<ul style="list-style-type: none"> <li>• The subject is too far away.</li> <li>• Your finger was covering the flash/flash control sensor.</li> </ul>	<ul style="list-style-type: none"> <li>• Move to within the effective flash range before taking the shot.</li> <li>• Hold the camera correctly.</li> </ul>
The image is blurred.	<ul style="list-style-type: none"> <li>• The lens is dirty.</li> <li>• You photographed scenery with Macro mode selected.</li> <li>• You took a close-up shot without selecting Macro mode.</li> <li>• You are shooting a subject that is not suited to autofocus.</li> </ul>	<ul style="list-style-type: none"> <li>• Clean the lens.</li> <li>• Cancel Macro mode.</li> <li>• Select Macro mode.</li> <li>• Use AF/AE lock to take the shot.</li> </ul>

► If you think the camera is faulty, check the following once more

Troubleshooting	Possible causes	Solutions
There is speckling on the image.	The shot was taken with a slow shutter speed (long exposure) in a high-temperature environment.	This is a characteristic of CCDs and does not indicate a camera fault.
The camera does not emit any sound.	<ul style="list-style-type: none"> <li>• The camera volume is set too low.</li> <li>• The microphone was blocked during shooting/recording.</li> <li>• There is something covering the speaker during playback.</li> </ul>	<ul style="list-style-type: none"> <li>• Adjust the volume.</li> <li>• Take care not to block the microphone during shooting/recording.</li> <li>• Ensure that the speaker is uncovered.</li> </ul>
Frame erase does not erase the frame.	<ul style="list-style-type: none"> <li>• DPOF settings are specified for some frames.</li> <li>• Some frames may be protected.</li> </ul>	<ul style="list-style-type: none"> <li>• Cancel the DPOF settings and try again (►P.67).</li> <li>• Remove the protection.</li> </ul>
The ERASE ALL function does not erase all the frames.		
I can't format the SmartMedia.	The SmartMedia is write-protected.	Remove the write-protection. (Peel off the write-protect sticker.)
When the camera is connected to a personal computer (PC), the shot image appears on the camera's LCD monitor.	<ul style="list-style-type: none"> <li>• The special FinePix F401 USB cable is not properly connected to the computer or camera.</li> <li>• The PC is not switched on.</li> </ul>	<ul style="list-style-type: none"> <li>• Set up the camera and the special FinePix F401 USB cable correctly.</li> <li>• Switch the PC on.</li> </ul>
Nothing happens when I use the camera switches.	<ul style="list-style-type: none"> <li>• Camera malfunction.</li> <li>• The battery is exhausted.</li> </ul>	<ul style="list-style-type: none"> <li>• Briefly remove the battery or disconnect the AC power adapter. Then reload the battery or reconnect the AC power adapter and try again.</li> <li>• Load a new fully charged battery.</li> </ul>
The camera no longer works correctly.	The camera has suffered an unforeseen problem.	Briefly remove the battery or disconnect the AC power adapter. Then reload the battery or reconnect the AC power adapter and try again.

## DPOF:

Digital Print Order Format

DPOF is a format used for recording information on a storage media (image memory card, etc.) that allows you to specify which of the frames shot using a digital camera are printed and how many prints are made of each image.

## EV:

A number that denotes Exposure Value. The EV is determined by the brightness of the subject and sensitivity (speed) of the film or CCD. The number is larger for bright subjects and smaller for dark subjects. As the brightness of the subject changes, a digital camera maintains the amount of light hitting the CCD at a constant level by adjusting the aperture and shutter speed. When the amount of light striking the CCD doubles, the EV increases by 1. Likewise, when the light is halved, the EV decreases by 1.

## JPEG:

Joint Photographics Experts Group

A file format used for compressing and saving color images. The compression ratio can be selected, but the higher the compression ratio, the poorer the quality of the expanded image.

## Motion JPEG:

A type of AVI (Audio Video Interleave) file format that handles images and sound as a single file. Images in the file are recorded in JPEG format. Motion JPEG can be played back by QuickTime 3.0 or later.

## PC Card:

A generic term for cards that meet the PC Card Standard.

## PC Card Standard:

A standard for PC cards determined by the PCMCIA.

## PCMCIA:

Personal Computer Memory Card International Association (US).

## Explanation of Terms

### WAVE:

A standard format used on Windows systems for saving audio data. WAVE files have the ".WAV" file extension and the data can be saved in either compressed or uncompressed format. Uncompressed recording is used on this camera.

WAVE files can be played back on a personal computer using the following software:

Windows : MediaPlayer

Macintosh: QuickTime Player

\* QuickTime 3.0 or later

### White Balance:

Whatever the kind of the light, the human eye adapts to it so that a white object still looks white. On the other hand, devices such as digital cameras see a white subject as white by first adjusting the color balance to suit the color of the ambient light around the subject. This adjustment is called matching the white balance. A function that automatically matches the white balance is called an **Automatic White Balance function**.

## Specifications

### System

- **Model:** Digital camera FinePix F401
- **Number of effective pixels:** 2.1 million pixels
- **CCD sensor**  
1/2.7-inch Super CCD in an interwoven pattern  
Number of total pixels 2.11 million pixels
- **Number of recorded pixels**  
2304 × 1728 pixels (4.0 million pixels)/1600 × 1200 pixels/  
1280 × 960 pixels/640 × 480 pixels
- **File format**  
Still image: JPEG (Exif ver. 2.2)  
\* Design rule for Camera File System compliant, DPOF compatible  
Movie: AVI format, Motion JPEG  
Audio: WAV format
- **Storage media:** SmartMedia (3.3V)
- **Viewfinder:** Real image optical Approx. 80% coverage
- **Lens:** Super EBC Fujinon optical 3× zoom lens
- **Aperture:** F2.8-F4.8/F7-F11.6 (automatically selected)
- **Focus:** TTL contrast-type, Auto focus
- **Focus distance:** f = 5.7 mm-17.1 mm  
(Equivalent to 38 mm-114 mm on a 35 mm camera)
- **Exposure control**  
TTL 64-zones metering, Program AE, exposure compensation available in Manual photography mode
- **Sensitivity:** Equivalent to ISO 200/400/800/1600
- **White balance**  
Auto (In Manual modes, 7 positions can be selected.)
- **Focal range**  
Normal: Approx. 60 cm (2.0 ft.) to infinity  
Macro : Approx. 10 cm (0.3 ft.) to 80 cm (2.6 ft.)

### ■ Standard number of available shots/recording time per SmartMedia™

Quality	4M 4M • F	4M 4M • N	2M 2M	1M 1M	0.3M 0.3M	820	160
No. of recorded pixels	2304 × 1728		1600 × 1200	1280 × 960	640 × 480	Movie	
Image Data Size	Approx. 1.6MB	Approx. 790KB	Approx. 390KB	Approx. 320KB	Approx. 130KB	—	—
MG-4S (4MB)	2	4	9	12	30	Approx. 24 sec.	Approx. 83 sec.
MG-8S (8MB)	4	9	19	25	61	Approx. 49 sec.	Approx. 169 sec.
MG-16S/SW (16MB)	9	19	39	49	122	Approx. 98 sec.	Approx. 5.6 min.
MG-32S/SW (32MB)	20	39	79	99	247	Approx. 199 sec.	Approx. 11.3 min.
MG-64S/SW (64MB)	40	79	159	198	497	Approx. 6.7 min.	Approx. 22.8 min.
MG-128SW (128MB)	81	159	319	398	997	Approx. 13.4 min.	Approx. 45.6 min.

# Specifications

- **Shutter:** Variable-speed, 1/4 sec. to 1/2000 sec. (depend on Exposure mode)
- **Flash:** Auto flash using flash control sensor  
Effective range: Wide-angle Approx. 0.4 m-3.5 m (15.7 in.-11.5 ft.)  
Telephoto Approx. 0.4 m-2 m (15.7 in.-6.6 ft.)  
Flash modes: Auto, Red-Eye Reduction, Forced Flash, Suppressed Flash, Slow Synchro
- **Erase modes:** ERASE FRAME, ERASE ALL FRAMES, FORMAT (initialize)
- **LCD monitor**  
1.5-inches, low-temperature polysilicon TFT 114,000 pixels
- **Self-Timer:** 10 sec. timer clock

## Input/Output Terminals

- **DC Input:** To connect the AC power Adapter AC-5VS/AC-5VHS
-  **(USB) socket**  
For file transfer to a computer and connection to the optional cradle

## Power Supply and Others

- **Power supply**  
Use one of the following
  - Rechargeable Battery NP-60 or AC Power Adapter AC-5VS/AC-5VHS

### ■ Available shots using the battery (When fully charged)

	Battery Type	No. of Shots
NP-60	LCD monitor ON	Approx. 200
	LCD monitor OFF	Approx. 450

The number of shots shown here is an approximate guide to the number of consecutive shots that can be taken based on 50% flash usage at normal temperatures. However, the actual number of available shots will vary depending on the ambient temperature when the camera is used and the amount of charge in the battery. The number of available shots will be lower in cold conditions.

- **Conditions for use**  
Temperature: 0°C to +40°C (+32°F to +104°F)  
80% humidity or less (no condensation)
- **Camera dimensions (W/H/D)**  
85.0 mm × 69.4 mm × 27.5 mm/3.3 in. × 2.7 in. × 1.1 in. (not including accessories and attachments)
- **Camera mass (weight):** 185 g/6.5 oz. (not including accessories, batteries or SmartMedia)
- **Weight for photography:** Approx. 215 g/7.6 oz. (including battery and SmartMedia)
- **Accessories:** See P.7
- **Optional Accessories:** See P.89-90

### ■ Self timer lamp display

Camera operation	Display	Status
During charging	Lit	Charging in progress
	Off	Charging complete
	Brinking	Charging error
Switched on	Lit	POWER switch set to ON (goes off after several seconds)
Self-timer photography	Lit	From 10 seconds to 5 seconds before the shot is taken
	Brinking	For 5 seconds or less before the shot is taken
Recording Voice Memos	Brinking	Recording in progress
	Flashing rapidly	For 5 seconds or less before recording ends
Connected to a computer	Brinking	During communication with a computer
	Off	Ready for disconnection

- \* These specifications are subject to change without notice.
- \* The LCD monitor on your digital camera is manufactured using advanced high-precision technology. Even so, small bright points and anomalous colors (particularly around text) may appear on the monitor. These are normal display characteristics and do not indicate a fault with the monitor. This phenomenon will not appear on the recorded image.
- \* The operation error may be caused in a digital camera by the strong radio interference (i. e. electric fields, static electricity, line noise, etc.).
- \* Due to the nature of the lens, the edges of photographed images may appear distorted. This is normal and does not indicate a fault.

# Safety Notes

- To ensure that you use your FinePix F401 camera correctly, read these Safety Notes and your Owner's Manual carefully beforehand.
- After reading these Safety Notes, store them in a safe place.

## About the Icons

The icons shown below are used in this document to indicate the severity of the injury or damage that can result if the information indicated by the icon is ignored and the product is used incorrectly as a result.

 **WARNING** This icon indicates that death or serious injury can result if the information is ignored.

 **CAUTION** This icon indicates that personal injury or material damage can result if the information is ignored.

The icons shown below are used to indicate the nature of the information which is to be observed.

 Triangular icons notify the user of information requiring attention ("Important").

 Circular icons with a diagonal bar notify the user that the action indicated is prohibited ("Prohibited").

 Filled circles with an exclamation mark notify the user of an action that must be performed ("Required").

## WARNING

**If a problem arises, switch the camera off, remove the battery, disconnect and unplug the AC power adapter.**

Continued use of the camera when it is emitting smoke, is emitting any unusual odor, or is in any other abnormal state can cause a fire or electric shock.

- Contact your FUJIFILM dealer.



Unplug from power socket.

**Do not allow water or foreign objects to enter the camera.**

If water or foreign objects get inside the camera, switch the camera off, remove the battery and disconnect and unplug the AC power adapter.

Continued use of the camera can cause a fire or electric shock.

- Contact your FUJIFILM dealer.



**Do not place the camera on an unstable surface.**

This can cause the camera to fall or tip over and cause injury.



**Never attempt to modify or disassemble the camera. (Never open the casing.)**

Do not use the camera when it has been dropped or the casing is damaged. This can cause a fire or electric shock.

- Contact your FUJIFILM dealer.



Do not disassemble.

## WARNING

**Do not use the camera in the bathroom or shower.**

This can cause a fire or electric shock.



Do not use in the bathroom or shower.

**Never attempt to take pictures while in motion.**

Do not use the camera while you are walking or operating a moving car or other vehicle. This can result in you falling down or being involved in a traffic accident.



**Do not touch any metal parts of the camera during a thunderstorm.**

This can cause an electric shock due to induced current from the lightning discharge.



**Do not use the batteries except as specified.**

Load the batteries with the poles positioned as indicated by the ⊕ and ⊖ marks.



**Do not heat, modify or attempt to disassemble the batteries.**

**Do not drop or subject the batteries to impacts. Do not attempt to recharge lithium or alkaline batteries. Do not store the batteries with metallic products.**



Any of these actions can cause the batteries to burst or leak and cause fire or injury as a result.

## WARNING

**Use only the batteries or AC power adapter specified for use with this camera. Do not use voltages other than the power supply voltage shown.**

The use of other power sources can cause a fire.



**If the battery leaks and fluid gets into your eyes or comes into contact with your skin or clothing, this can cause injury or loss of eyesight. Immediately flush the affected area thoroughly with clean water and seek medical treatment.**



**When discarding or storing batteries, cover the battery terminals with insulation tape.**

• Contact with other metallic objects or batteries could cause the batteries to ignite or burst.



**Do not use the charger to charge batteries other than those specified here.**

The charger is designed for Fujifilm HR-AA NiMH batteries. Using the charger to charge conventional batteries or other types of rechargeable batteries can cause the batteries to leak fluid, overheat or burst.



## Safety Notes

 <b>CAUTION</b>	
<b>When charging ends, unplug the charger from the power socket.</b> Leaving the charger plugged into the power socket can cause a fire.	
<b>Do not use this camera in locations severely affected by oil fumes, steam, humidity or dust.</b> This can cause a fire or electric shock.	
<b>Do not leave this camera in places subject to extremely high temperatures.</b> Do not leave the camera in locations such as a sealed vehicle or in direct sunlight. This can cause a fire.	
<b>Keep out of the reach of small children.</b> This product could cause injury in the hands of a child.	
<b>Do not place heavy objects on the camera.</b> This can cause the heavy object to tip over or fall and cause injury.	
<b>Do not move the camera while the AC power adapter is still connected.</b> <b>Do not pull on the connection cord to disconnect the AC power adapter.</b> This can damage the power cord or cables and cause a fire or electric shock.	

 <b>CAUTION</b>	
<b>Do not cover or wrap the camera or the AC power adapter in a cloth or quilt.</b> This can cause heat to build up and distort the casing or cause a fire.	
<b>When you are cleaning the camera or you do not plan to use the camera for an extended period, remove the battery and disconnect and unplug the AC power adapter.</b> Failure to do so can cause a fire or electric shock.	
<b>Using a flash too close to a person's eyes may temporarily affect the eyesight.</b> Take particular care when photographing infants and young children.	
<b>Request regular internal testing and cleaning for your camera.</b> Build-up of dust in your camera can cause a fire or electric shock. ● Contact your FUJIFILM dealer to request internal cleaning every 2 years.	

## EC Declaration of Conformity

We  
Name : Fuji Photo Film (Europe) G.m.b.H.  
Address : Heesenstrasse 31  
40549 Dusseldorf, Germany

declare that the product  
Product Name : FUJIFILM DIGITAL CAMERA FinePix F401  
Manufacturer's Name : Fuji Photo Film Co., Ltd.  
Manufacturer's Address : 26-30, Nishiazabu 2-chome, Minato-ku,  
Tokyo 106-8620, Japan

is in conformity with the following Standards

Safety : EN60950  
EMC : EN55022 : 1998 Classe B  
EN55024 : 1998  
EN61000-3-2 : 1995 + A1:1998 + A2:1998

following the provision of the EMC Directive (89/336/EEC, 92/31/EEC and 93/68/EEC) and Low Voltage Directive (73/23/EEC).

CE

Dusseldorf, Germany

August 1, 2002

Place

Date

Signature/Managing Director



Bij dit produkt zijn batterijen geleverd. Wanneer deze leeg zijn, moet u ze niet weggooien maar inleveren als KCA





---

**FUJI PHOTO FILM CO., LTD.**

26-30, Nishiazabu 2-chome, Minato-ku, Tokyo 106-8620, Japan

Printed in Japan

Printed on recycled paper.

FGS-204105-FG