



1



9



9



3

# YUKON SUBURBAN

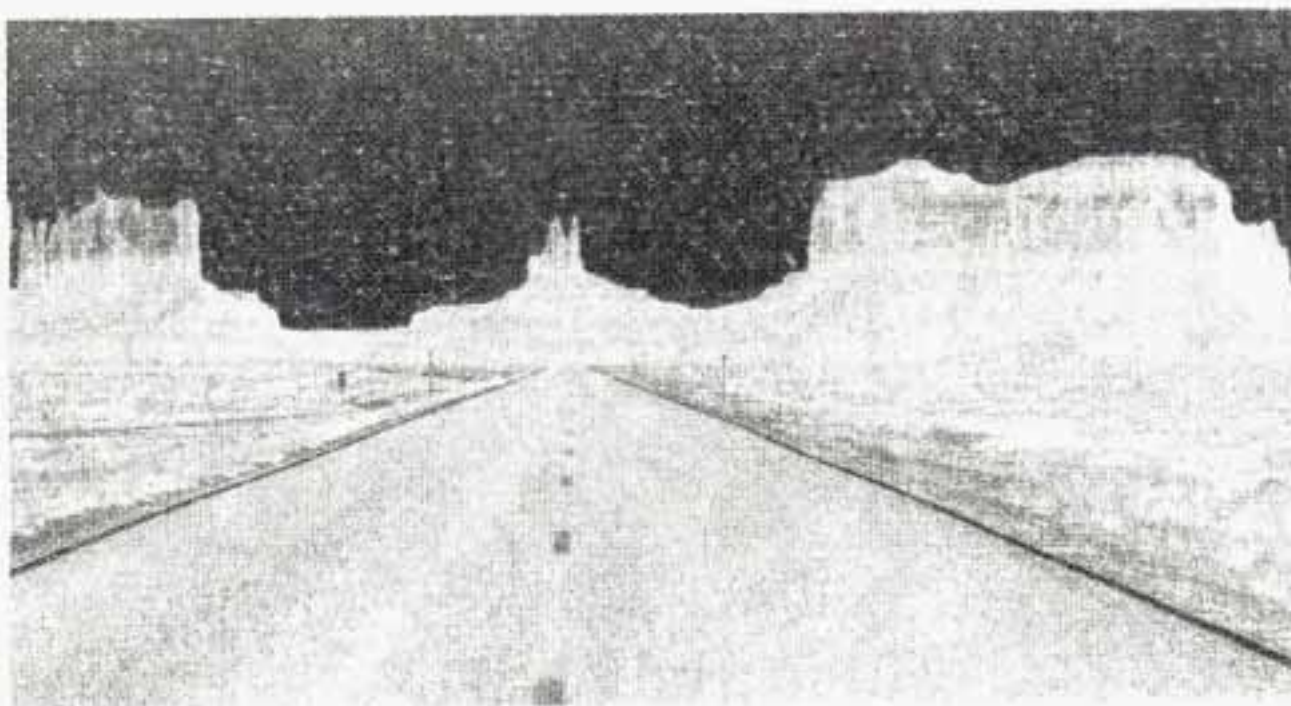

**Owner's Manual**

**GMC**  
TRUCK

**THE STRENGTH OF EXPERIENCE.**

**REPRODUCTION**

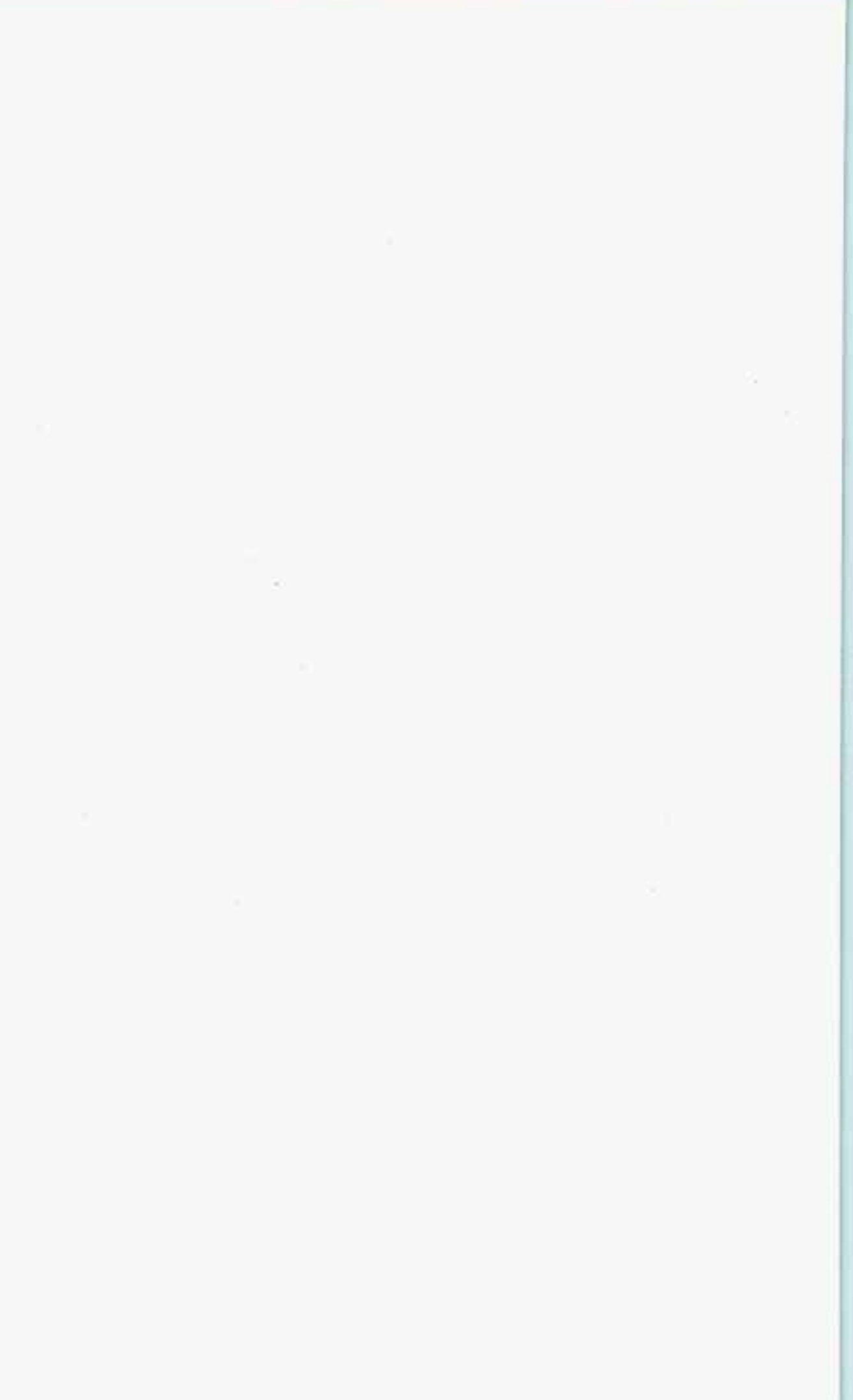

---

---

# **INTRODUCTION**

## **1993 Yukon and Suburban Owner's Manual**

### **Welcome**

This manual was prepared to acquaint you with the operation and maintenance of your 1993 GMC Truck vehicle, and to provide important safety information. There is also a GMC Truck Warranty and Owner Assistance Information booklet. In some vehicles, there can be information manuals from other manufacturers like body builders or special equipment companies. We urge you to review all these publications carefully. This will help you enjoy safe and trouble-free operation of your vehicle.

When it comes to service, keep in mind that your GMC Truck dealer knows your vehicle best and is interested in your complete satisfaction. Your dealer invites you to return for all of your service needs both during and after the warranty period.

Remember, if you have a concern and need help handling it to your satisfaction see the procedure in Section 8, or in the GMC Truck Warranty and Owner Assistance Information booklet.

Thanks for choosing a GMC Truck product. We value you as a member of the GMC Truck family. We want to assure you of our continuing interest in your pleasure and satisfaction with your vehicle.

GMC Truck Division  
General Motors Corporation  
Pontiac, Michigan

©Copyright 1992 General Motors Corporation, GMC Truck Division.  
All Rights Reserved

---

---

## Important Notes to Owners and Drivers

. . . **About Driving your Yukon:** As with other vehicles of this type, failure to operate this vehicle correctly may result in loss of control or an accident. Be sure to read the "on-pavement" and "off-road" driving guidelines in this manual. (See "Driving Guidelines" and "Off-Road Driving With Your Four-Wheel Drive Vehicle" in the Index.)

. . . **About This Manual:** Please keep this manual in your vehicle, so it will be there if you ever need it when you're on the road. If you sell the vehicle, please leave this manual in it so the new owner can use it.

This manual includes the latest information at the time it was printed. We reserve the right to make changes in the product after that time without further notice. For vehicles first sold in Canada, substitute the name "General Motors of Canada Limited" for GMC Truck Division whenever it appears in this manual.

. . . **For Canadian Owners Who Prefer a French Language Manual:**  
Aux propriétaires canadiens: Vous pouvez vous procurer un exemplaire de ce guide en français chez votre concessionnaire ou au DGN Marketing Services Ltd., 1500 Bonhill Rd., Mississauga, Ontario L5T 1C7.





*GENERAL MOTORS, GM, the GM Emblem, GMC, YUKON and SUBURBAN are registered trademarks of General Motors Corporation.*

---

---

## **Model Reference**

*This manual covers these models.*

TYPE	MODEL
	WAGON
	UTILITY

---

---

## **TABLE OF CONTENTS**

***How to Use this Manual***

***Seats & Safety Belts***

***Features & Controls***

***Comfort Controls & Audio Systems***

***Your Driving and the Road***

***Problems on the Road***

***Service & Appearance Care***

***Scheduled Maintenance Services***

***Customer Assistance Information***

***Index***

---

---

---

## Section

This section tells you how to use your manual and includes safety and vehicle damage warnings and symbols.

This section tells you how to use your seats and safety belts properly.

2

This section explains how to start and operate your vehicle.

3

This section tells you how to adjust the ventilation and comfort controls and how to operate your audio system.

4

Here you'll find helpful information and tips about the road and how to drive under different conditions.

5

This section tells you what to do if you have a problem while driving, such as a flat tire or engine overheating.

6

Here the manual tells you how to keep your vehicle running properly and looking good.

7

This section tells you when to perform vehicle maintenance and what fluids and lubricants to use.

This section tells you how to contact your GM division for assistance and how to get service publications. It also gives you information on "Reporting Safety Defects".

9

Here's an alphabetical listing of almost every subject in this manual. You can use it to quickly find something you want to read.





# ***How To Use This Manual***

---

## ***Section***

Many people read their owner's manual from beginning to end when they first receive their new vehicle. This will help you learn about the features and controls for your vehicle. In this manual, you'll find that pictures and words work together to explain things quickly.

**INDEX:** A good place to look for what you need is the Index in back of the manual. It's an alphabetical list of all that's in the manual, and the page number where you'll find it.

**SECTIONS 1-6:** Each section of this manual begins with a brief list of its contents, so you can often find at a glance if a section contains the information you want.

**SECTION 7:** This section covers the maintenance required for your vehicle.

**SECTION 8:** This section includes important information about reporting safety defects and gives you details about the Roadside Assistance program. You will also find customer satisfaction phone numbers (including customer satisfaction numbers for the hearing and speech impaired), as well as the mediation/arbitration procedure. We've also included ordering information for service publications in this section.

# ***How To Use This Manual***

---

## ***Safety Warnings and Symbols***

You will find a number of safety cautions in this book. We use yellow and the the word CAUTION to tell you about things that could hurt you if you were to ignore the warning.

### **CAUTION**



These mean there is something that could hurt you or other people.

In the yellow caution area, we tell you what the hazard is. Then we tell you what to do to help avoid or reduce the hazard. Please read these cautions. If you don't, you or others could be hurt.

You will also find a red circle with a slash through it in this book. This safety symbol means "Don't," "Don't do this," or "Don't let this happen."



AM002002

---

---

## ***Vehicle Damage Warnings***

Also, in this book you will find these blue notices:

### **NOTICE**

These mean there is something that could damage your vehicle.

In the blue notice area, we tell you about something that can damage your vehicle. Many times, this damage would not be covered by your warranty, and it could be costly. But the notice will tell you what to do to help avoid the damage.

When you read other manuals, you might see CAUTION and NOTICE warnings in different colors or in different words. In this manual, we've used the familiar words and colors that General Motors has used for years.

You'll also see warning labels on your vehicle. They use the same colors, and the words CAUTION or NOTICE.

# ***How To Use This Manual***

---

## ***Vehicle Symbols***

These are some of the symbols you will find on your vehicle. For example, these symbols are used on an original battery:



*Caution  
Possible Injury*



*Protect Eyes  
by Shielding*



*Caustic Battery Acid  
Could Cause Burns*



*Spark or Flame Could  
Explode Battery*



*Avoid Sparks  
or Flames*

---

These symbols are important for you and your passengers whenever your vehicle is driven:



*Fasten Safety  
Belts*



*Door Lock/Unlock*

---

These symbols have to do with your lights:



Master Lighting Switch

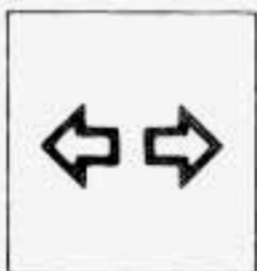

Turn Signal Direction



Hazard Warning Flasher



Headlight High Beam

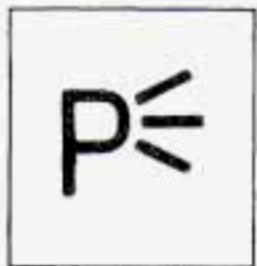

Parking Lights



Fog Lights



Daytime Running Lights



Off

---

These symbols are on some of your controls:



Windshield Wiper



Windshield Washer



Windshield Defroster

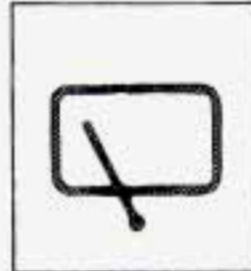

Rear Window Wiper

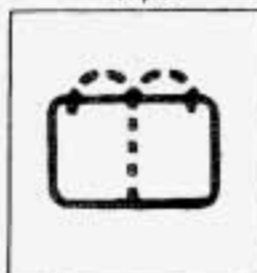

Rear Window Washer



Rear Window Defogger



Ventilating Fan



Hatch Release

P0595

# **How To Use This Manual**

These symbols are used on warning and indicator lights.



*Engine Coolant  
Temperature*

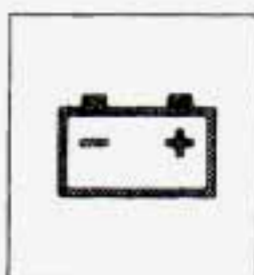

*Battery Charging  
System*



*Fuel*



*Engine Oil  
Pressure*



*Brake*

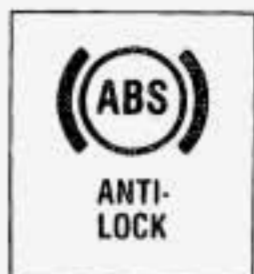

*4 Wheel  
Anti-Lock*



*Parking Brake  
Release*



*Shift Light*

Here are some other symbols you may see:

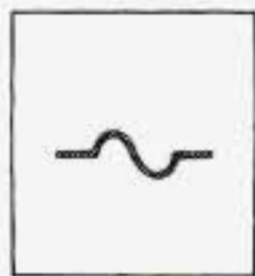

*Fuse*



*Hood Release*



*Lighter*



*Horn*

# Seats & Safety Belts



## Section

Here you'll find information about the seats in your vehicle and how to use your safety belts properly. You can also learn about some things you should **not** do with safety belts.

Seats and Seat Controls.....	1-2
Front Seats .....	1-2
Head Restraints .....	1-5
Rear Seats .....	1-8
Safety Belts: They're For Everyone .....	1-13
Why Safety Belts Work.....	1-15
Questions Many People Ask About Safety Belts .....	1-18
How To Wear Safety Belts Properly .....	1-20
Adults .....	1-20
Driver Position.....	1-20
Lap-Shoulder Belt.....	1-21
Safety Belt Use During Pregnancy.....	1-26
Passenger Positions .....	1-27
Children .....	1-34
Smaller Children and Babies.....	1-34
Child Restraints.....	1-36
Larger Children .....	1-44
Safety Belt Extender.....	1-46
Checking Your Restraint Systems.....	1-47
Replacing Safety Belts After a Crash.....	1-47

# Seats & Safety Belts

---

## Seats and Seat Controls

This section tells you about the seats—how to adjust them, take them out, and put them back in, and fold them up and down. It also tells you about reclining seats and head restraints.

### Front Seats

#### Manual Front Seat

#### CAUTION



You can lose control of the vehicle if you try to adjust a manual driver's seat while the vehicle is moving. The sudden movement could startle and confuse you, or make you push a pedal when you don't want to. Adjust the driver's seat only when the vehicle is not moving.

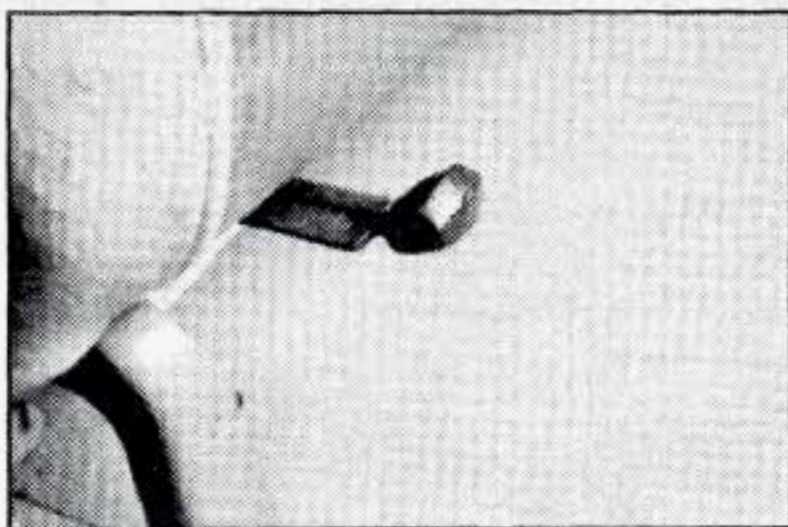

K2102

Slide the lever at the front of the seat toward your door to unlock it. Slide the seat to where you want it. Then release the lever and try to move the seat with your body, to make sure the seat is locked into place.



---

---

## **Power Seat**

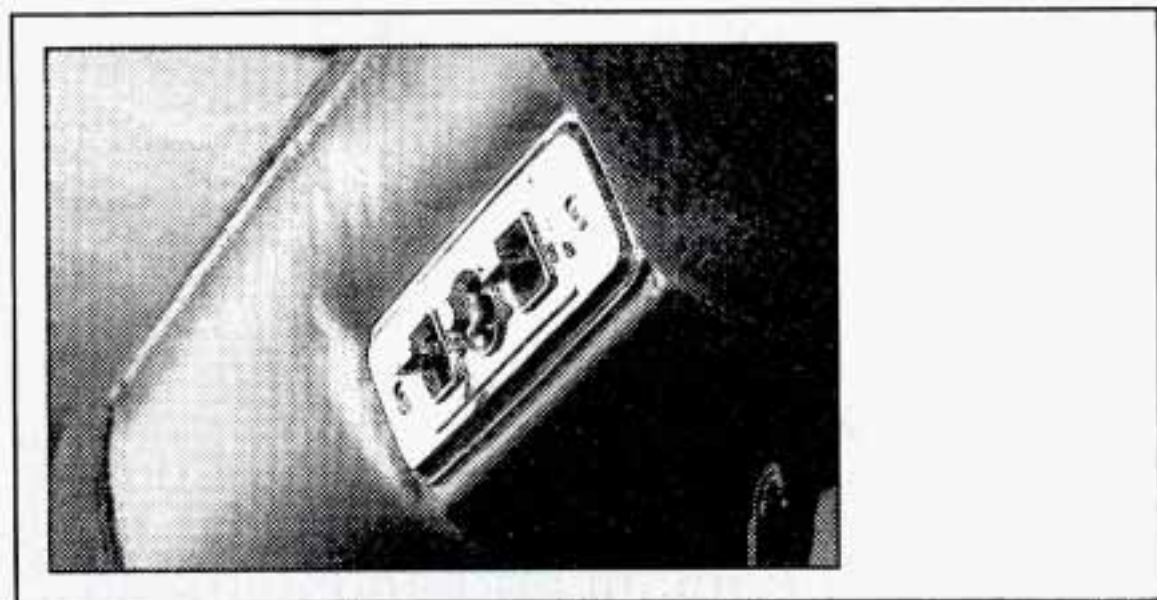

K2365

If your vehicle has a power seat on the driver's side, you can adjust it with this switch at the front of the seat.

## **Reclining Front Seatback (Bucket or Split Bench Seat)**

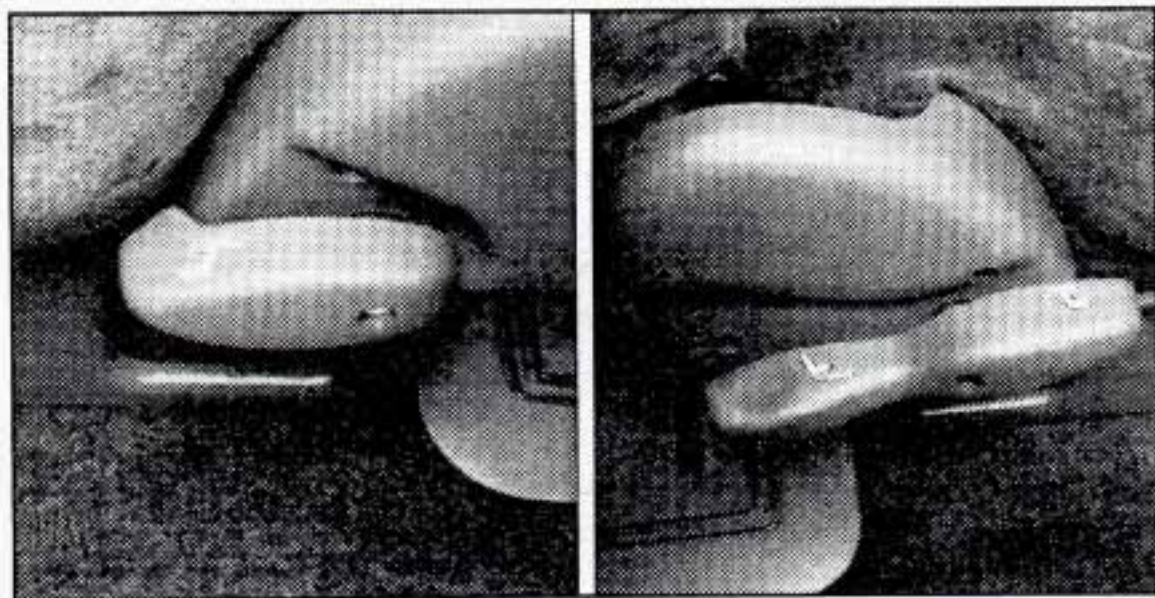

P0191

To adjust the seatback, lift the front of this lever. If your vehicle has a passenger side easy entry seat, your seatback lever will be slightly larger, but will work the same way. Release the lever to lock the seatback where you want it. Pull up on the lever and the seatback will go to an upright position.

## Seats & Safety Belts

Don't have a seatback reclined if your vehicle is moving.



AN101020

### CAUTION



Sitting in a reclined position when your vehicle is in motion can be dangerous. Even if you buckle up, your safety belts can't do their job when you're reclined like this.

The shoulder belt can't do its job because it won't be against your body. Instead, it will be in front of you. In a crash you could go into it, receiving neck or other injuries.

The lap belt can't do its job either. In a crash the belt could go up over your abdomen. The belt forces would be there, not at your pelvic bones. This could cause serious internal injuries.

For proper protection when the vehicle is in motion, have the seatback upright. Then sit well back in the seat and wear your safety belt properly.

---

---

## Head Restraints

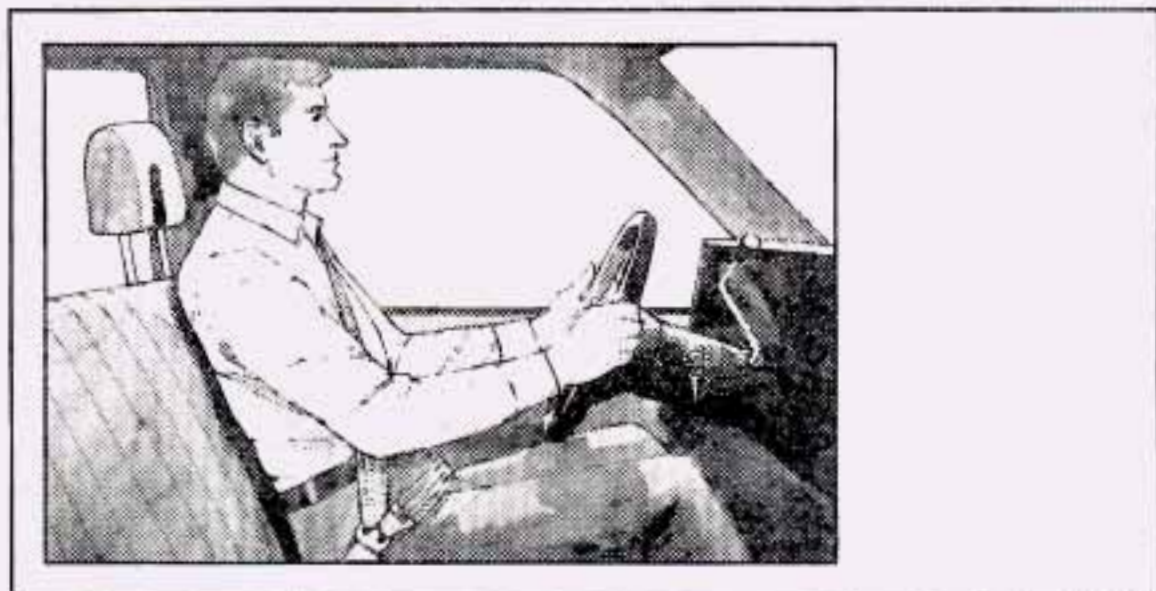

AN102016

Slide the head restraint up or down so that the top of the restraint is closest to the top of your ears.

This position reduces the chance of a neck injury in a crash.

### ***Seatback Latches (40/60 Reclining Split Bench Seat and Reclining Bucket Seat)***

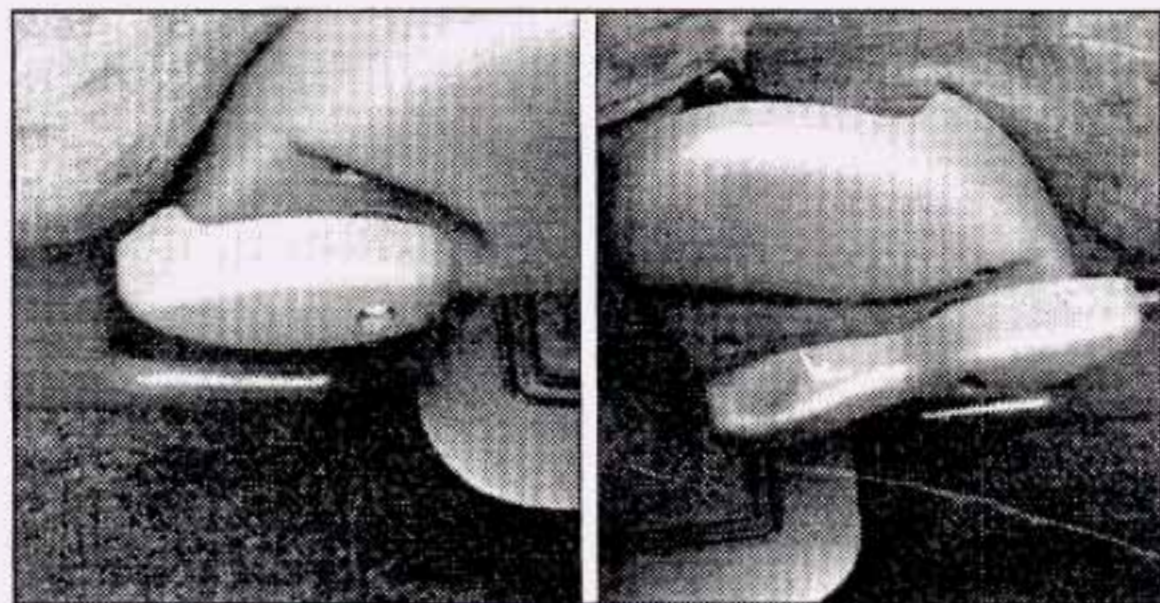

P0191

To fold a seatback forward, pull up on the front of this lever and fold the seatback forward.

## Seats & Safety Belts

---

To return the seatback to the upright position, just push the seatback rearward.

When you return the seatback to its original position, pull it forward to make sure the seatback is locked.

### CAUTION



If the seatback isn't locked, it could move forward in a sudden stop or crash. That could cause injury to the person sitting there. Always press rearward on the seatback to be sure it is locked.

### *Easy Entry Seat (Utility Model Front and Wagon Model Second Seat)*

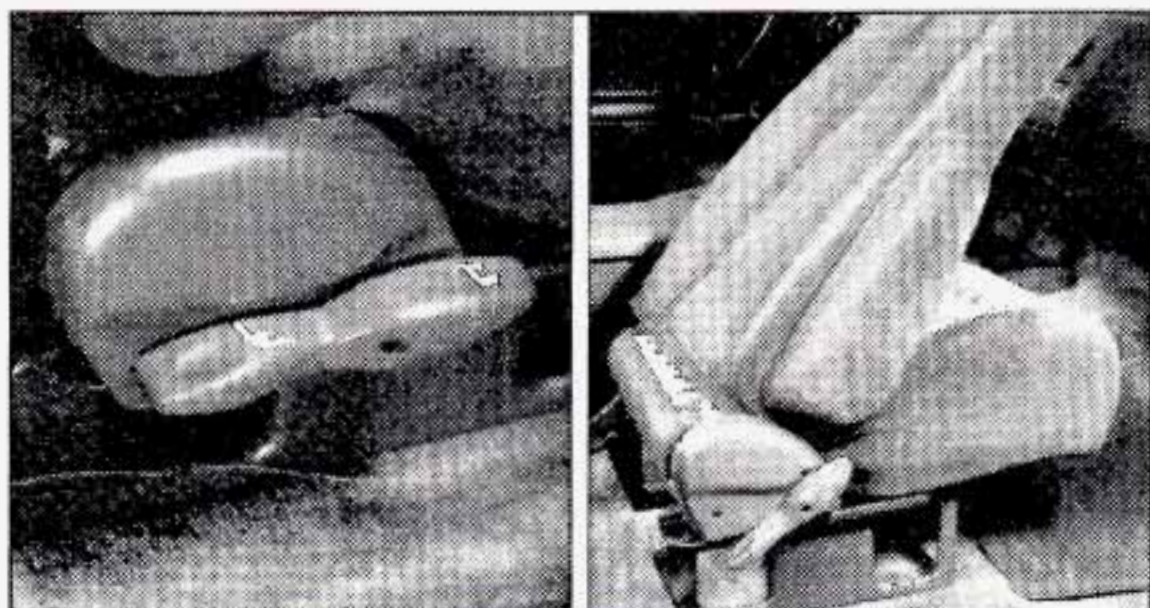

K2406

The right front bucket seat or the right side of the 40/60 split bench seat, available on the Utility model, has an easy entry feature. This makes it easy to get in and out of the rear seat.

To operate the seat, push down on the rear of the lever at the rear edge of the seat. When you do, the seatback will move fully forward and the seat bottom will release. Just pull or push the seat forward until it stops.

To return the seat to its regular position, return the seatback to its upright position, then push the whole seat rearward until it latches.

After returning the seat to its regular position, try to move the seat with your body, to make sure the seat is locked into place.

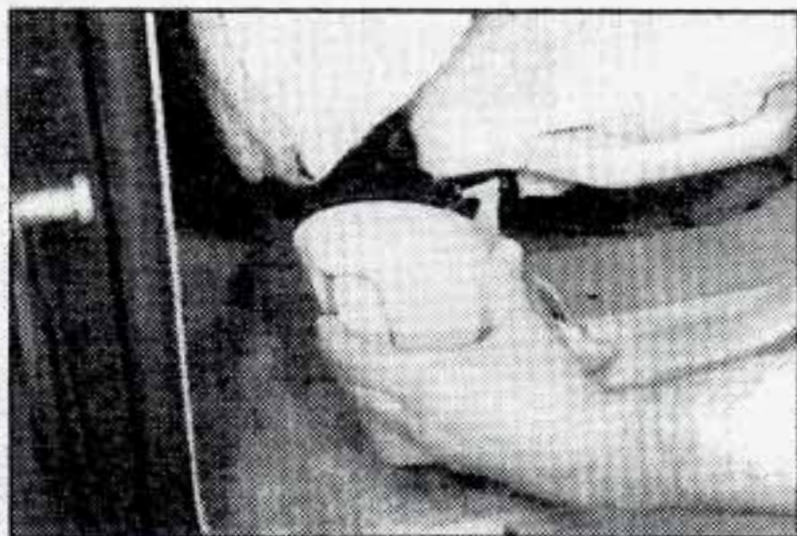

K2476

The right side of the rear 60/40 split folding bench seat, available on the Wagon model, has an easy entry feature. This makes it easy to get in and out of the third seat, if you have one.

To operate the seat, move the top lever at the rear edge of the seat forward, and tilt the seatback toward the front of the vehicle. When you do, the seat bottom will release. Just pull or push the seat forward until it stops.

To return the seat to its regular position, return the seatback to its upright position, then push the whole seat rearward until latches.

After returning the seat to its regular position, try to move the seat with your body, to make sure the seat is locked into place.

## CAUTION



If an easy entry right front seat isn't locked, it can move. In a sudden stop or crash, the person sitting there could be injured. After you've used it, be sure to push rearward on an easy entry seat to be sure it is locked.

# Seats & Safety Belts

---

## Rear Seats

### Folding Rear Seat (Utility Models)

If your vehicle has a rear seat, the seat can be folded flat for more cargo space. Before folding, make sure that nothing is under or in front of the seat. When the seat is folded, it will lay flat on the floor.

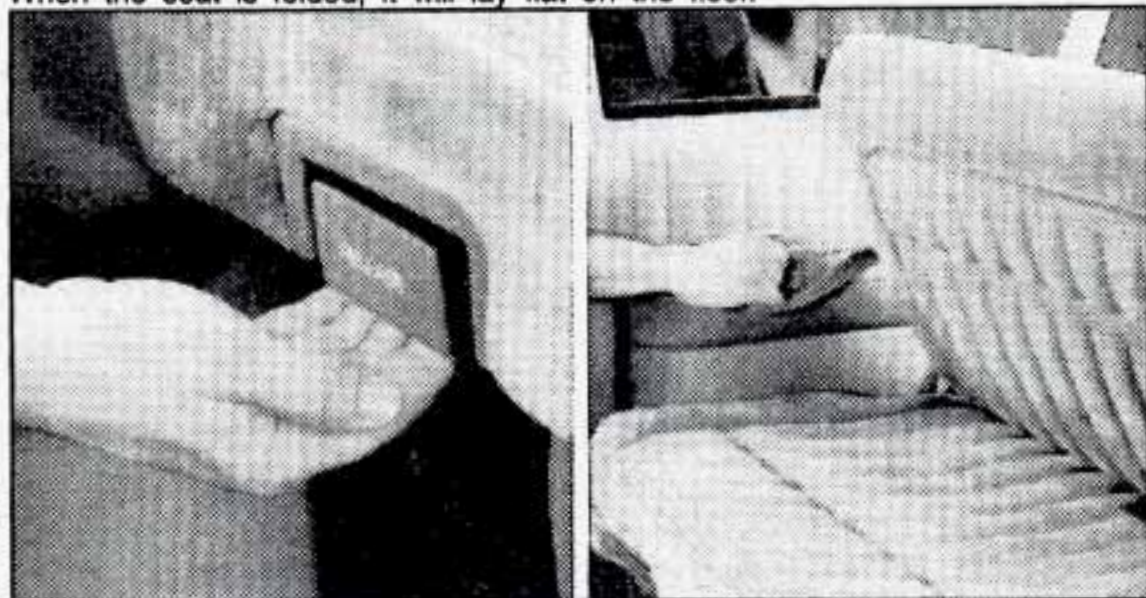

P0273

To fold the seat, pull on the lever at the front of the seat cushion marked **RELEASE**. Then, using the handle at the side of the seatback, pull the seatback forward and fold it into the seat cushion.

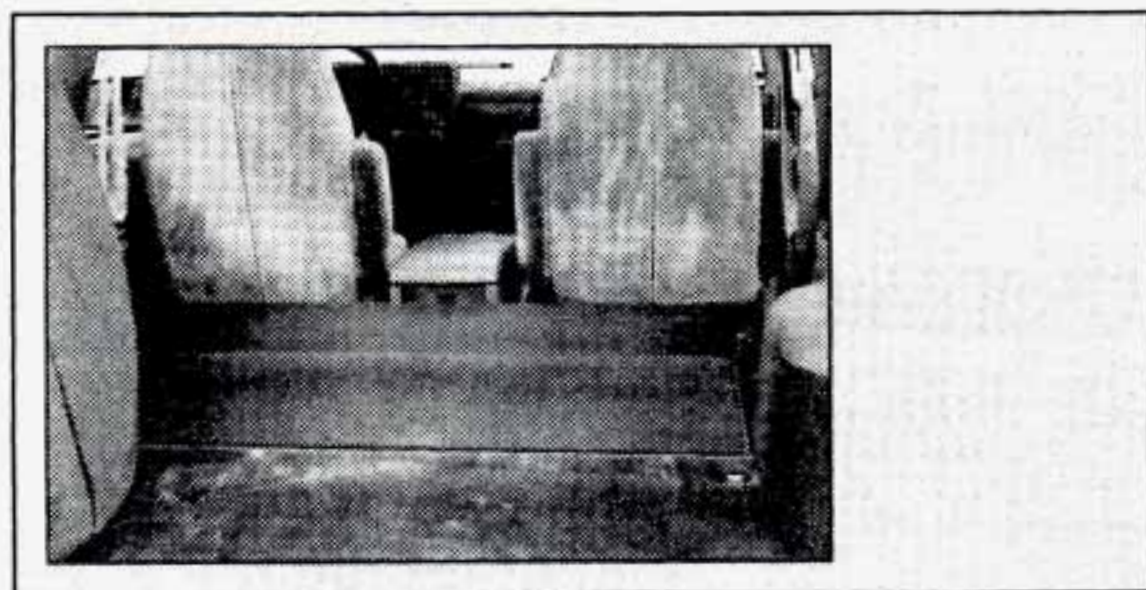

P0272

While the seat is in the folded position, hang the latch plate end of the outer passenger position safety belts on the hooks at the top of each retractor cover, out of the way.

---

---

To return the seat to the passenger position, just lift up on the seatback and push it rearward until it latches.

After returning the seat to the passenger position, pull forward on the seatback to make sure it is locked in place.

***Folding Second Seat (Wagon Models)***

If your vehicle has a 60/40 second seat, either side may be folded down to give you more cargo space. Before folding, make sure that nothing is under or in front of the seat. When the seat is folded, it will lay flat on the floor.

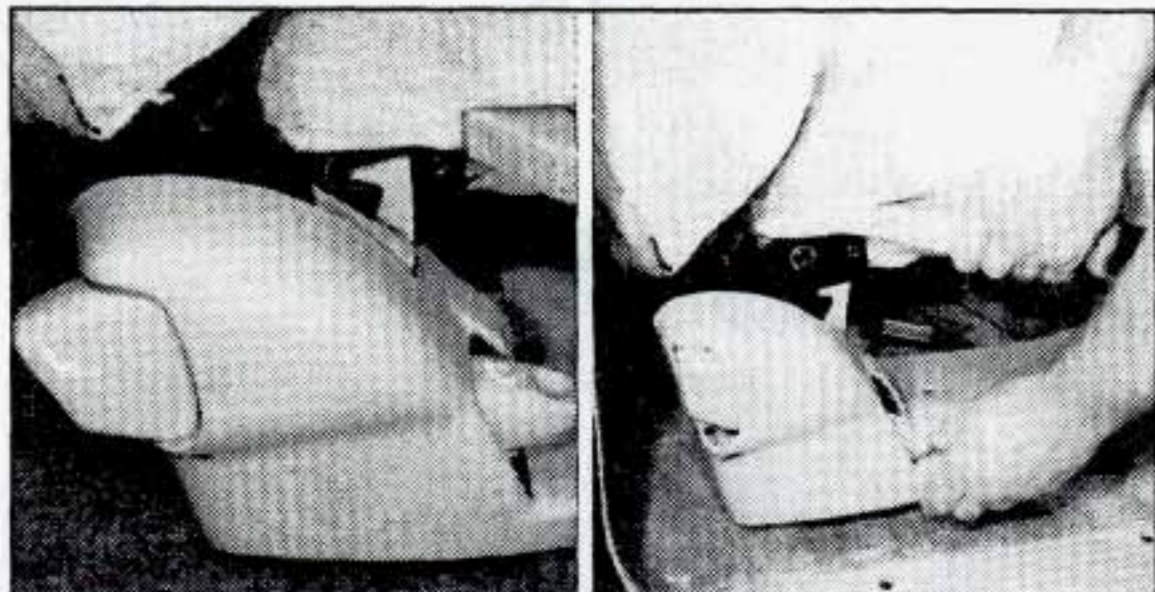

K2477

To fold the seat, push down on the lever at the outer side of the seat cushion and, using the handle mounted on the side of the seat, pull the seat cushion up and fold it forward.

## **Seats & Safety Belts**

---



P0507

After folding the seatback fully forward, push down on the lever again and fold the seatback forward until it is flat.

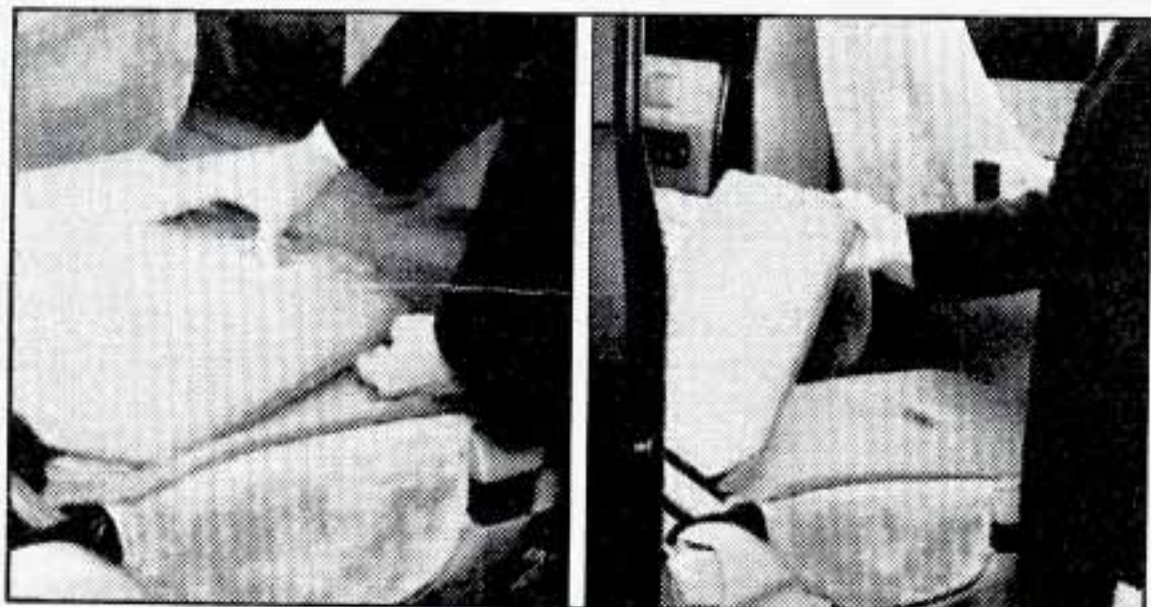

P0508

To create a load floor, release the panels from the seatbacks by pushing rearward on the latch, and fold them out to cover the rear seat footwell.





P0509

To return the seat to the passenger position, lift the load floor panels and latch them into the seatback. Then, lift the seatback up and push rearward until it latches. Lower the seat cushion until it latches in position.

After returning the seat to the passenger position, pull forward on the seatback and up on the seat cushion handle to make sure the seat is locked in place.

### ***Removable Rear Seat (Wagon Models)***

If your vehicle has a rear seat, it can be taken out for more cargo space.

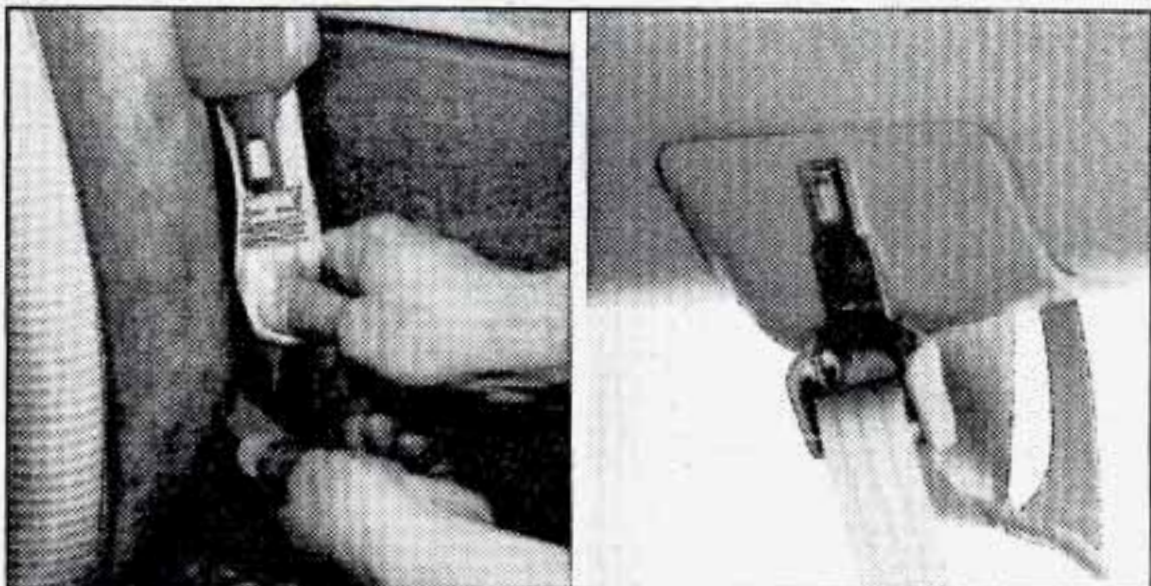

P0274

Before removing the seat, unlatch the outside passenger position safety belts from the seat frame. To do this, press in on the inside of the buckle cover

## Seats & Safety Belts

sleeve and pull the latch plate out of buckle. Then hang the latch plate end of the belt on the hook at the top of the retractor cover, out of the way.

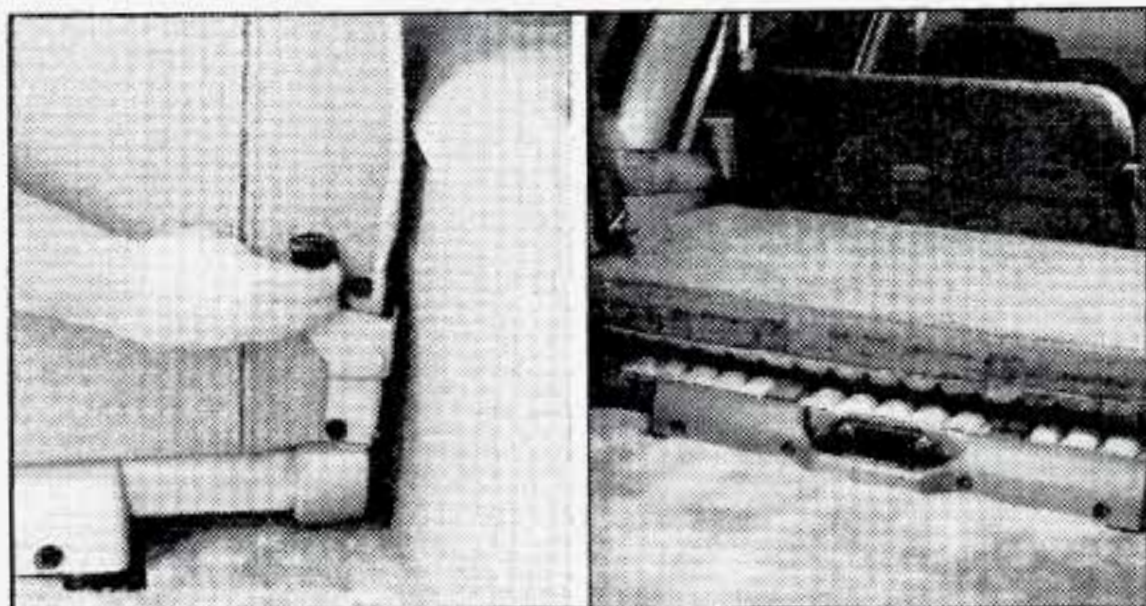

P0510

To remove the seat, fully open the rear load doors and enter the back of the vehicle. Move the seatback release lever at the right rear of the seat toward the center of the vehicle, and fold the seatback forward into the seat cushion.

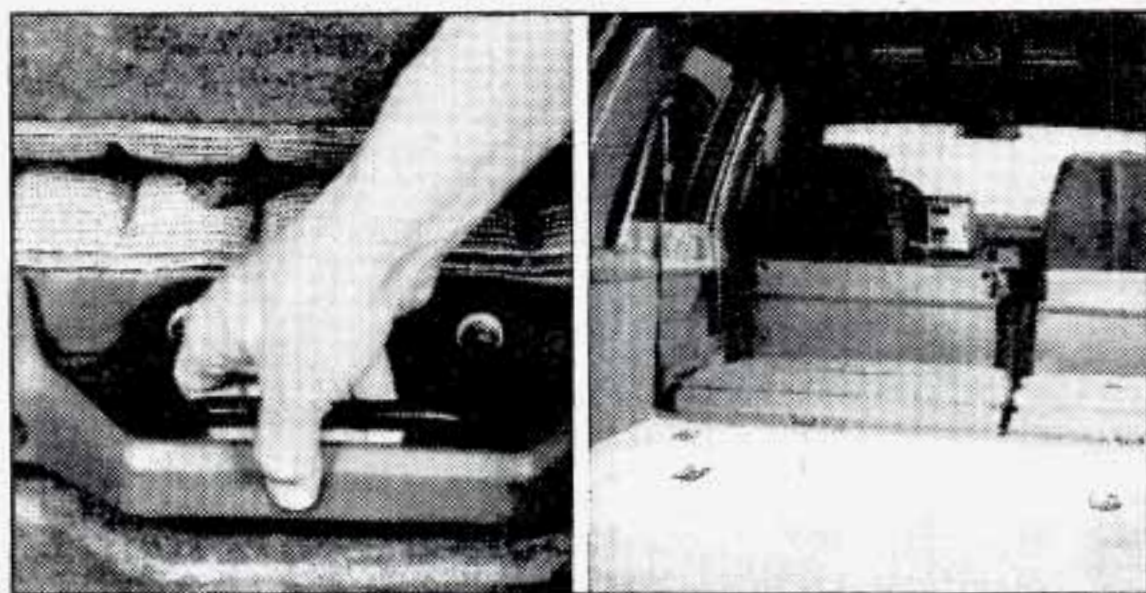

K2356

To unlatch the seat from the floor, pull up on the center release handle at the rear of the seat and lift the rear of the seat up, out of the floor. Turn the seat sideways and take it out of the vehicle.

---

---

To put the seat back in, hold it sideways and put it into the vehicle. Turn the seat to the forward position and set it down, with the latches at the bottom of the seat over the hooks in the floor. Pull up on the center release handle and let the seat drop into place. Release the handle to let the seat latch close and make sure it locks into place. Then, move the seatback release lever at the right rear of the seat toward the center of the vehicle and raise the seatback.

After returning the seat back to the upright position, push the seatback forward to make sure it is locked in place.

Then, return the outside passenger position safety belts to the seat frame buckles.

## CAUTION



A safety belt that is twisted or not properly attached won't provide the protection needed in a crash. The person wearing the belt could be seriously injured. After installing the seat, always check to be sure that the safety belts are not twisted and are properly attached.

## ***Safety Belts: They're For Everyone***

This part of the manual tells you how to use safety belts properly. It also tells you some things you should not do with safety belts.

## CAUTION



Don't let anyone ride where they can't wear a safety belt properly. If you are in a crash and you're not wearing a safety belt, your injuries can be **much** worse. You can hit things inside the vehicle or be ejected from it. You can be seriously injured or killed. In the same crash, you might not be if you are buckled up. Always fasten your safety belt, and check that your passengers' belts are fastened properly too.

## Seats & Safety Belts

---



AM110001

This figure lights up when you turn the key to **RUN** or **START** when your safety belt isn't buckled, and you'll hear a buzzer or tone, too. It's the reminder to buckle up. In many states and Canadian provinces, the law says to wear safety belts. Here's why: **They work.**

You never know if you'll be in a crash. If you do have a crash, you don't know if it will be a bad one.

A few crashes are very mild. In them, you won't get hurt even if you're not buckled up. And some crashes can be so serious, like being hit by a train, that even buckled up a person wouldn't survive. But most crashes are in between. In many of them, people who buckle up can survive and sometimes walk away. Without belts they could be badly hurt or killed.

After 25 years of safety belts in vehicles, the facts are clear. In most crashes buckling up does matter . . . a lot!



AN110021R1

### ***Why Safety Belts Work***

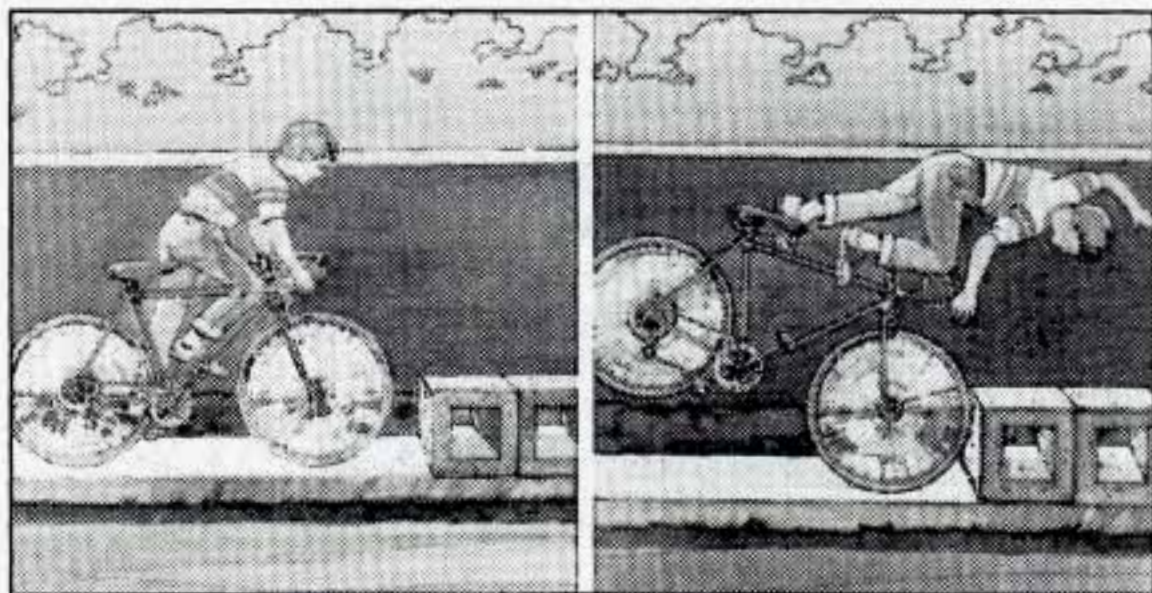

AM115001

AM115002

When you ride in or on anything, you go as fast as it goes. For example, if the bike is going 10 mph (16 km/h), so is the child. When the bike hits the block, it stops. But the child keeps going!

## Seats & Safety Belts

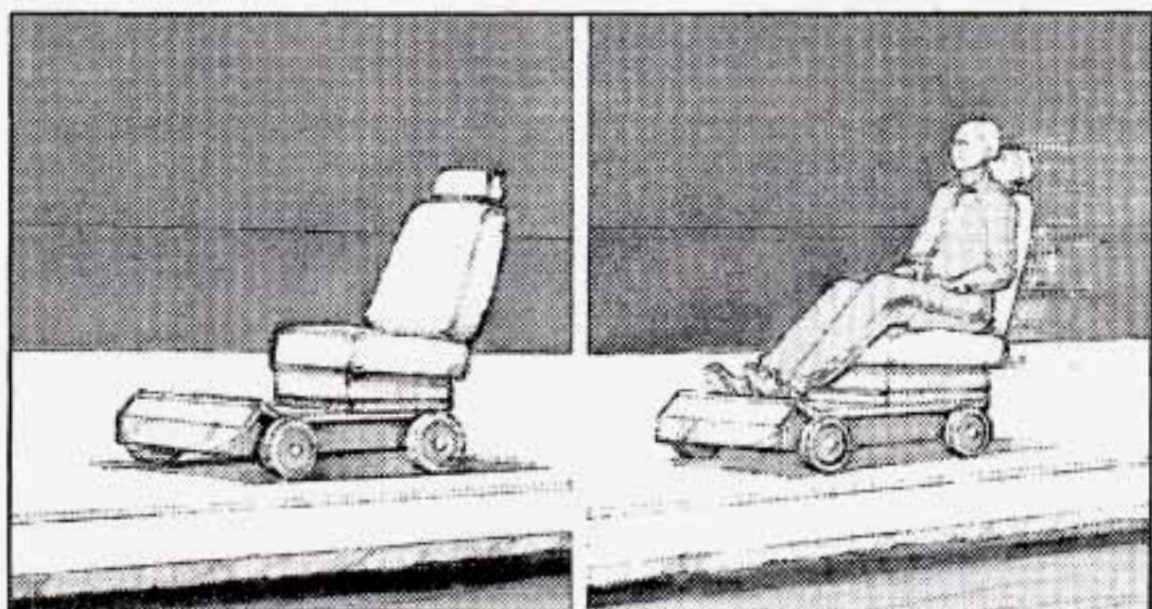

AM115003

AM115004

Take the simplest "vehicle." Suppose it's just a seat on wheels. Put someone on it.

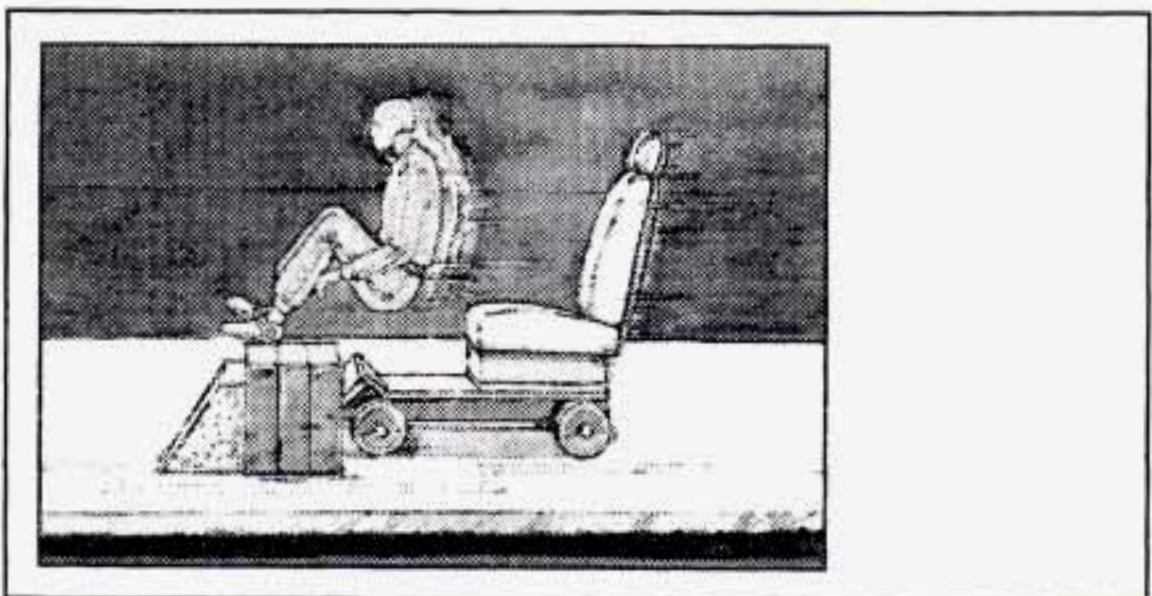

AM115005

Get it up to speed. Then stop the "vehicle." The rider doesn't stop.



AM115006

The person keeps going until stopped by something. In a real vehicle, it could be the windshield . . .

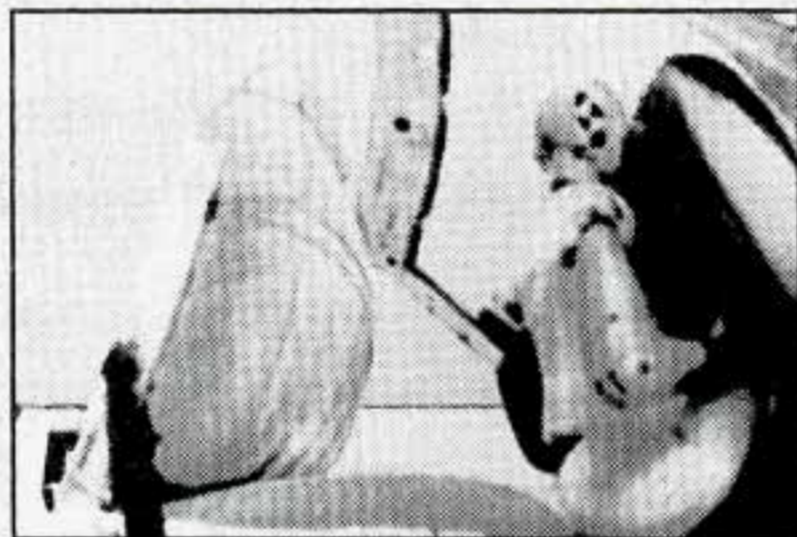

AM115007

or the instrument panel . . .

## **Seats & Safety Belts**

---

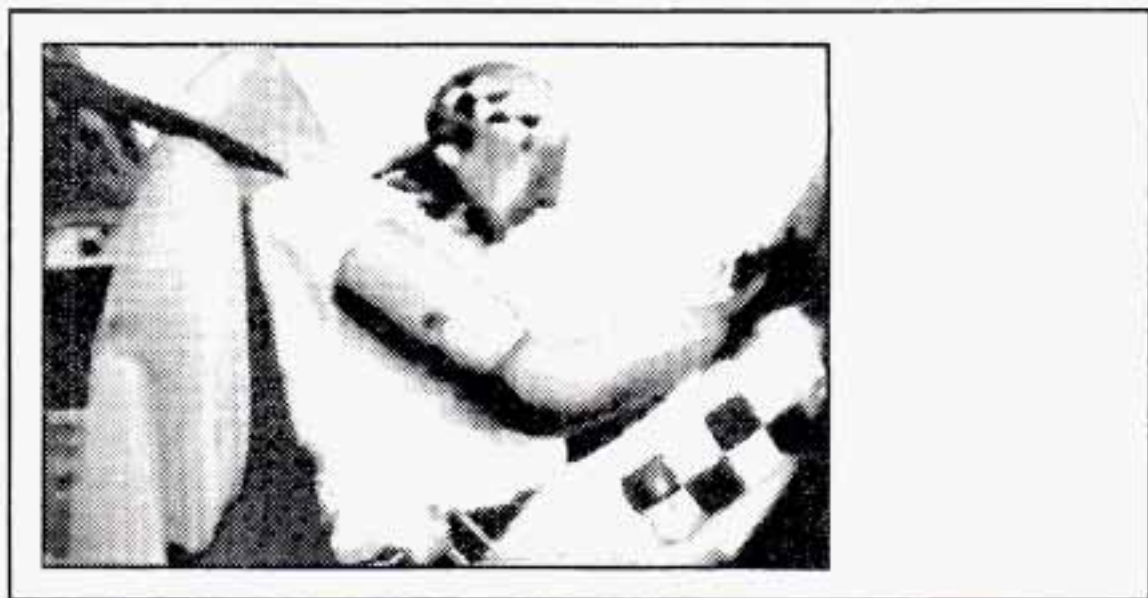

AW115008

or the safety belts!

With safety belts, you slow down as the vehicle does. You get more time to stop. You stop over more distance, and your strongest bones take the forces. That's why safety belts make such good sense.

### ***Here Are Questions Many People Ask About Safety Belts—and the Answers***

**Q:** Won't I be trapped in the vehicle after an accident if I'm wearing a safety belt?

**A:** You **could** be—whether you're wearing a safety belt or not. But you can easily unbuckle a safety belt, even if you're upside down. And your chance of being conscious during and after an accident, so you **can** unbuckle and get out, is **much** greater if you are belted.

**Q:** Why don't they just put in air bags so people won't have to wear safety belts?

**A:** "Air bags," or Supplemental Inflatable Restraint systems, are in some vehicles today and will be in more of them in the future. But they are supplemental systems only - so they work **with** safety belts, not instead of them. Every "air bag" system ever offered for sale has required the use of safety belts. Even if you're in a vehicle that has "air bags," you still have to buckle up to get the most protection. That's true not only in frontal collisions, but especially in side and other collisions.



---

**Q: If I'm a good driver, and I never drive far from home, why should I wear safety belts?**

**A:** You may be an excellent driver, but if you're in an accident - even one that isn't your fault - you and your passengers can be hurt. Being a good driver doesn't protect you from things beyond your control, such as bad drivers.

Most accidents occur within 25 miles (40 km) of home. And the greatest number of serious injuries and deaths occur at speeds of less than 40 mph (65 km/h).

Safety belts are for everyone.

### ***Safety Belt Reminder Light***



K2443

When the key is turned to **RUN** or **START**, a light will come on for about eight seconds to remind people to fasten their safety belts. Unless the driver's safety belt is buckled, a buzzer or tone will also sound.

# Seats & Safety Belts

---

## How To Wear Safety Belts Properly

### Adults

This part is only for people of adult size.

#### CAUTION



There are special things to know about safety belts and children. And there are different rules for babies and smaller children. If a child will be riding in your vehicle, see the part after this one, called "Children." Follow those rules for everyone's protection.

First, you'll want to know which restraint systems your vehicle has. We'll start with the driver position.

### Driver Position

This part describes the driver's restraint system.

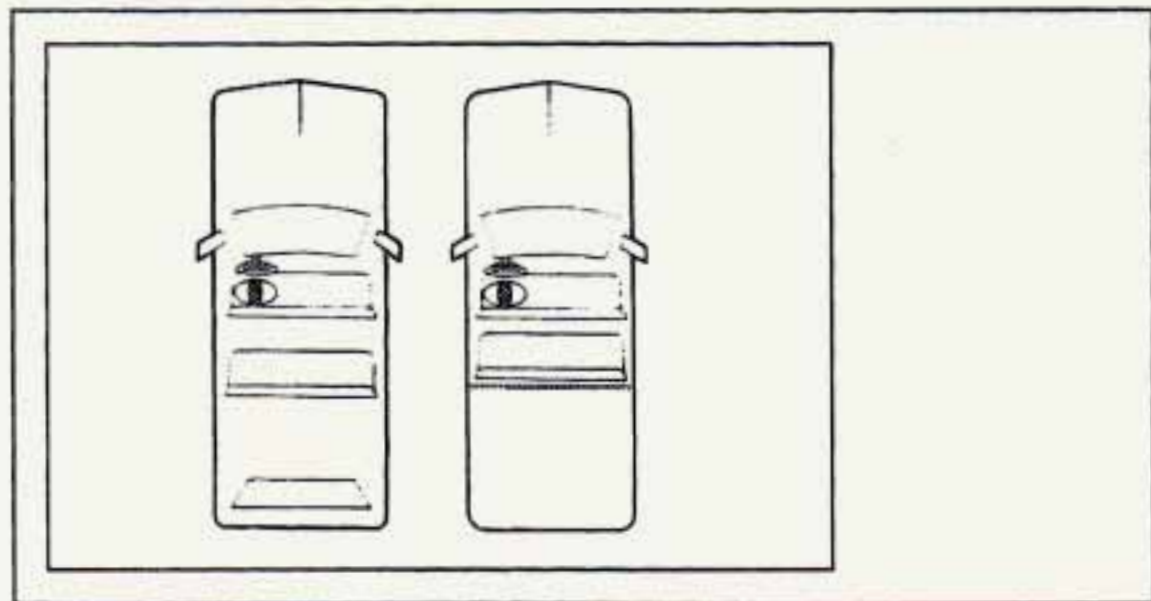

K2425

## Lap-Shoulder Belt

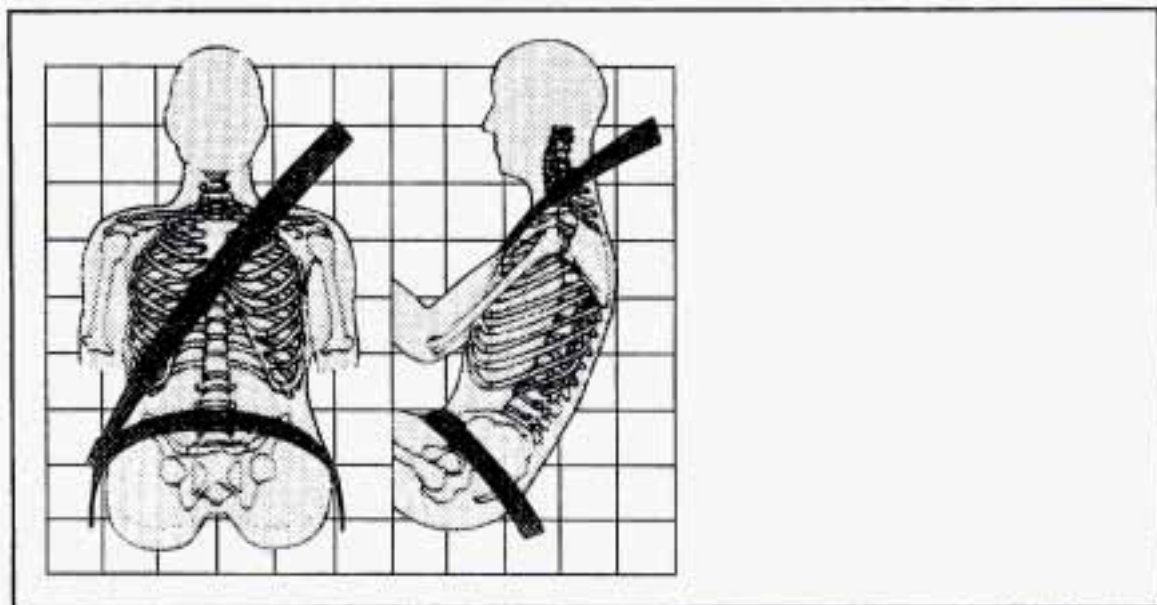

AM120007

The driver has a lap-shoulder belt. Here's how to wear it properly.

1. Close and lock the door.
2. Adjust the seat (to see how, see "Seats" in the Index) so you can sit up straight.

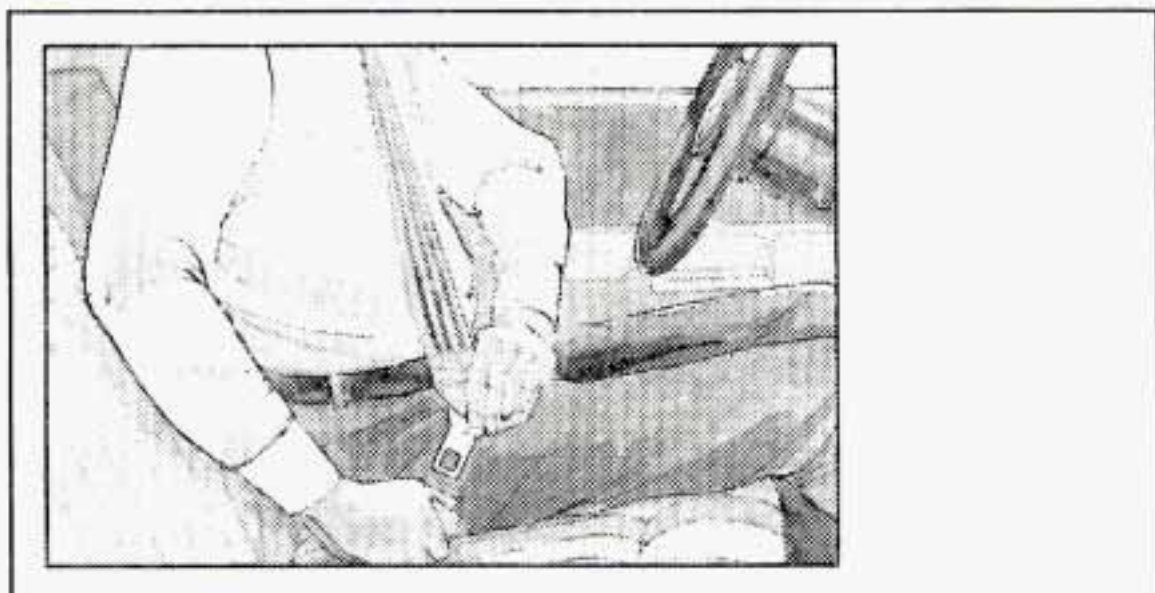

AN120120

3. Pick up the latch plate and pull the belt across you. On some models you may hear a clicking sound as the shoulder belt is pulled out or when released back into the cover. This is the shoulder belt tension reducing feature operating properly. Don't let the belt get twisted.
4. Push the latch plate into the buckle until it clicks.

## Seats & Safety Belts

If the belt isn't long enough, see "Safety Belt Extender" at the end of this section.

Make sure the release button on the buckle faces upward or outward so you would be able to unbuckle it quickly if you ever had to.

The lap part of the belt should be low and snug on the hips, just touching the thighs. In a crash, this applies force to the strong pelvic bones. And you'd be less likely to slide under the lap belt. If you slid under it, the belt would apply force at your abdomen. This could cause serious or even fatal injuries. The shoulder belt should go over the shoulder and across the chest. These parts of the body are best able to take belt restraining forces.

The safety belt locks if there's a sudden stop or a crash.

**Q: What's wrong with this?**

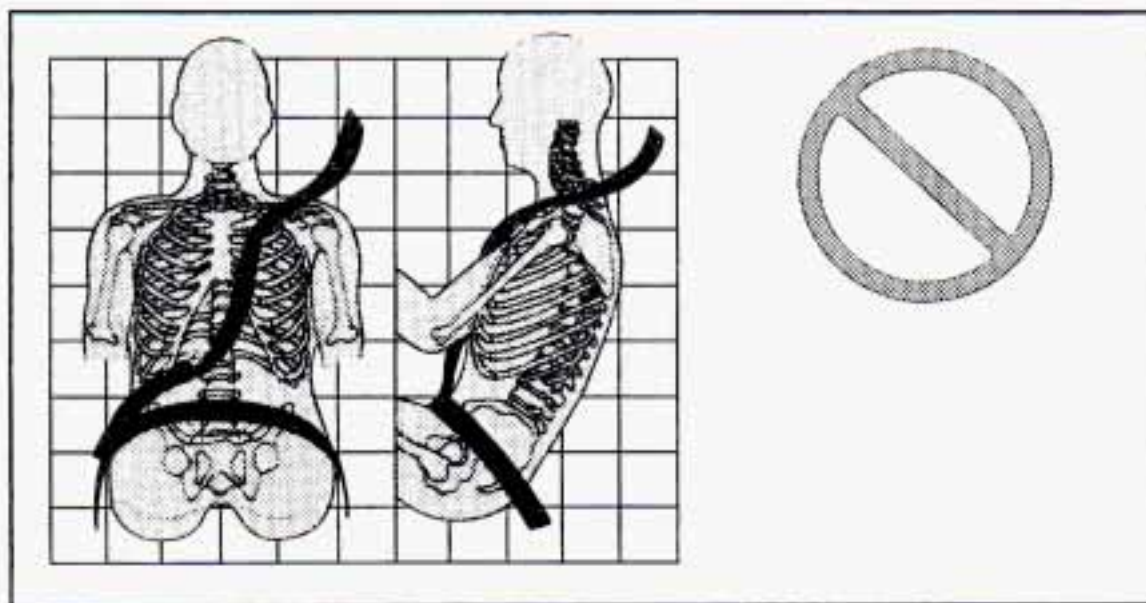

AM120015

**A:** The shoulder belt is too loose. It won't give nearly as much protection this way.

### CAUTION



You can be seriously hurt if your shoulder belt is too loose. In a crash you would move forward too much, which could increase injury. The shoulder belt should fit against your body.

**Q: What's wrong with this?**

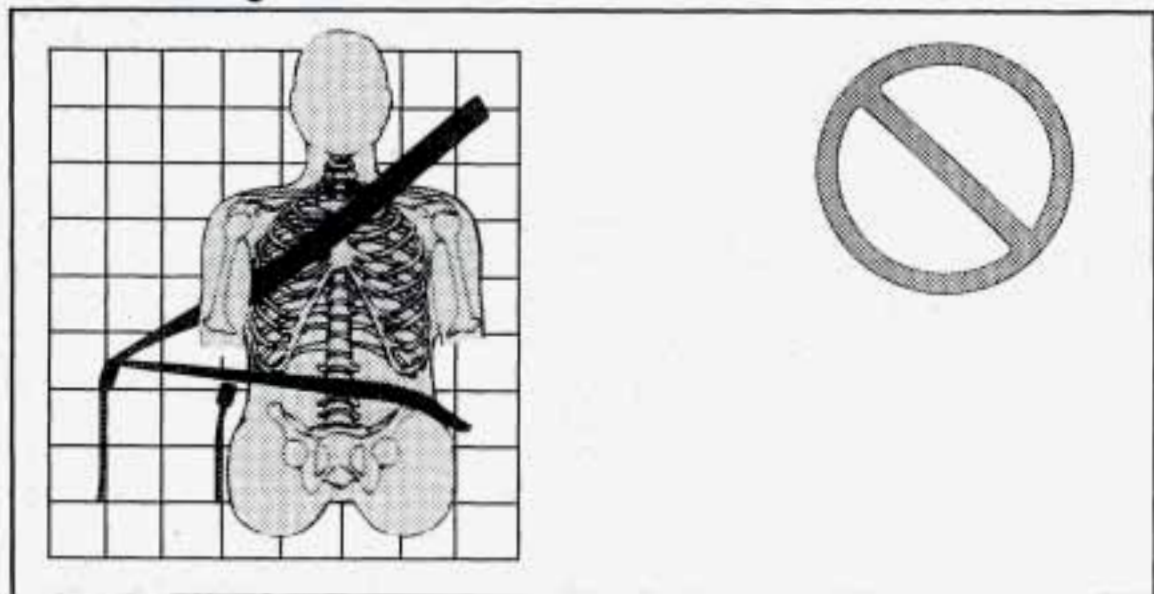

AM120016

**A: The belt is buckled in the wrong place.**

## CAUTION

 You can be seriously injured if your belt is buckled in the wrong place like this. In a crash, the belt would go up over your abdomen. The belt forces would be there, not at the pelvic bones. This could cause serious internal injuries. Always buckle your belt into the buckle nearest you.

**Q: What's wrong with this?**

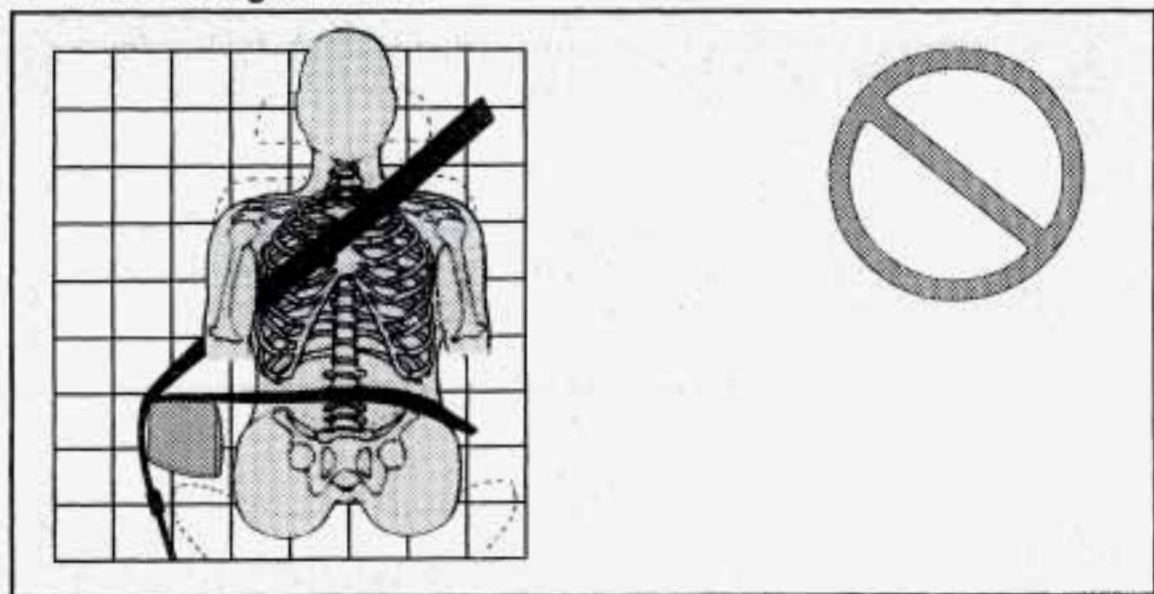

AM120058

**A: The belt is over an armrest.**

# Seats & Safety Belts

## CAUTION



You can be seriously injured if your belt goes over an armrest like this. The belt would be much too high. In a crash, you can slide under the belt. The belt force would then be applied at the abdomen, not at the pelvic bones, and that could cause serious or fatal injuries. Be sure the belt goes under the armrests.

**Q:** What's wrong with this?

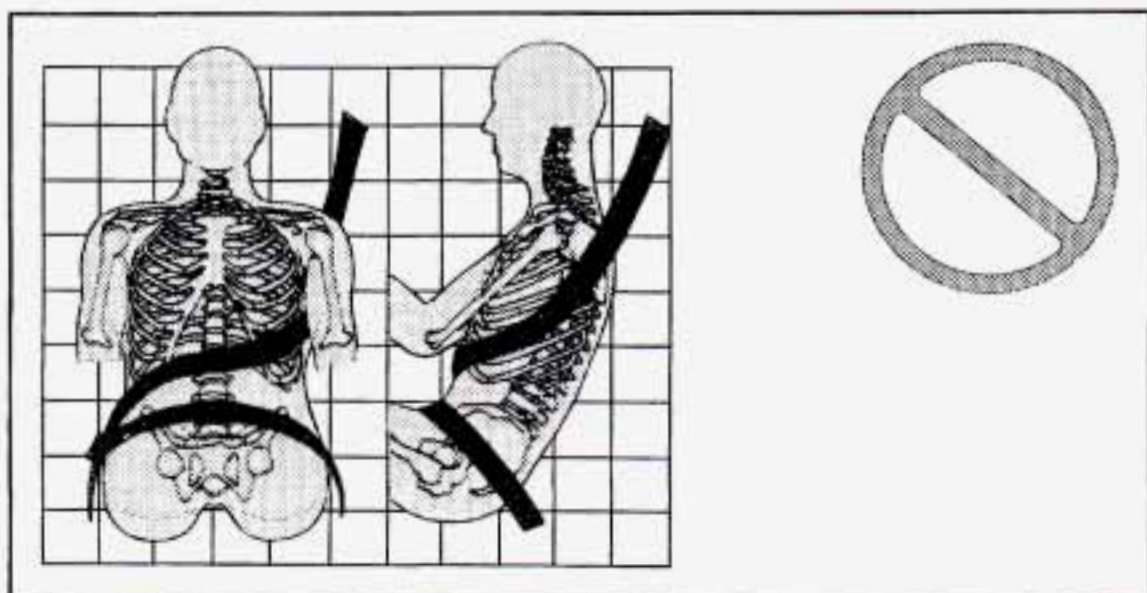

AM125001

**A:** The shoulder belt is worn under the arm. It should be worn over the shoulder at all times.

## CAUTION



You can be seriously injured if you wear the shoulder belt under your arm. In a crash, your body would move too far forward, which would increase the chance of head and neck injury. Also, the belt would apply too much force to the ribs, which aren't as strong as shoulder bones. You could also severely injure internal organs like your liver or spleen.

**Q: What's wrong with this?**

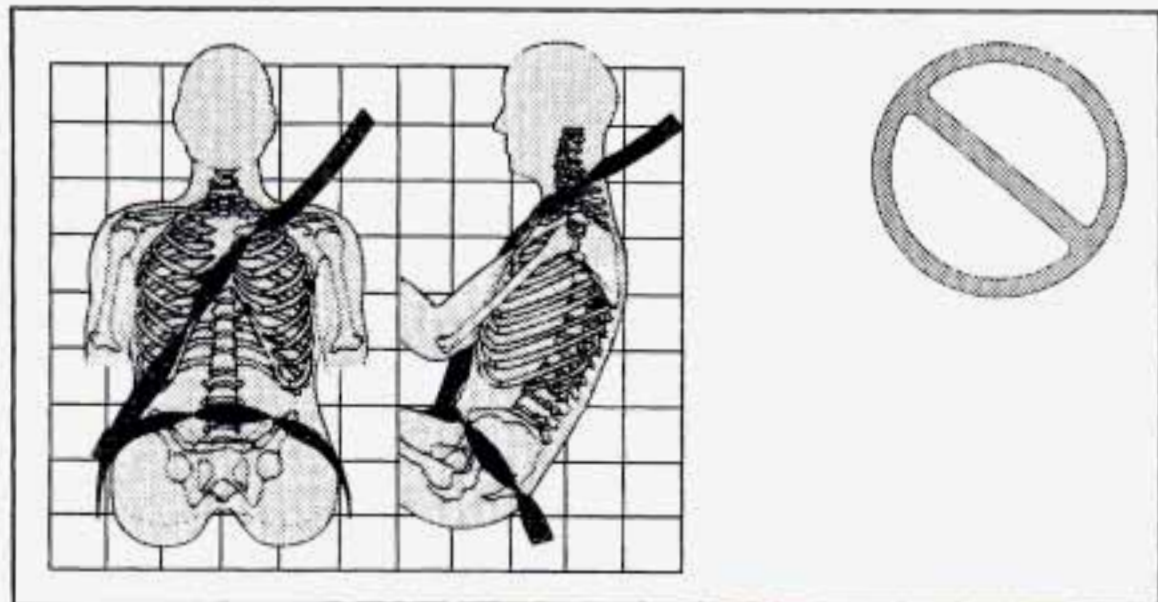

AM125002

**A: The belt is twisted across the body.**

## CAUTION



You can be seriously injured by a twisted belt. In a crash, you wouldn't have the full width of the belt to spread impact forces. If a belt is twisted, make it straight so it can work properly, or ask your dealer to fix it.

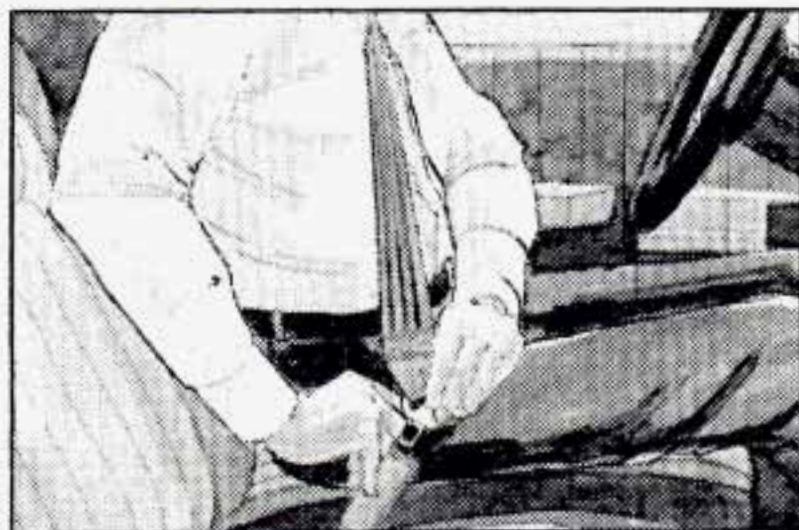

AN120123

To unlatch the belt, just push the button on the buckle. The belt should go back out of the way.

## **Seats & Safety Belts**

---

Before you close the door, be sure the belt is out of the way. If you slam the door on it, you can damage both the belt and your vehicle.

### ***Safety Belt Use During Pregnancy***

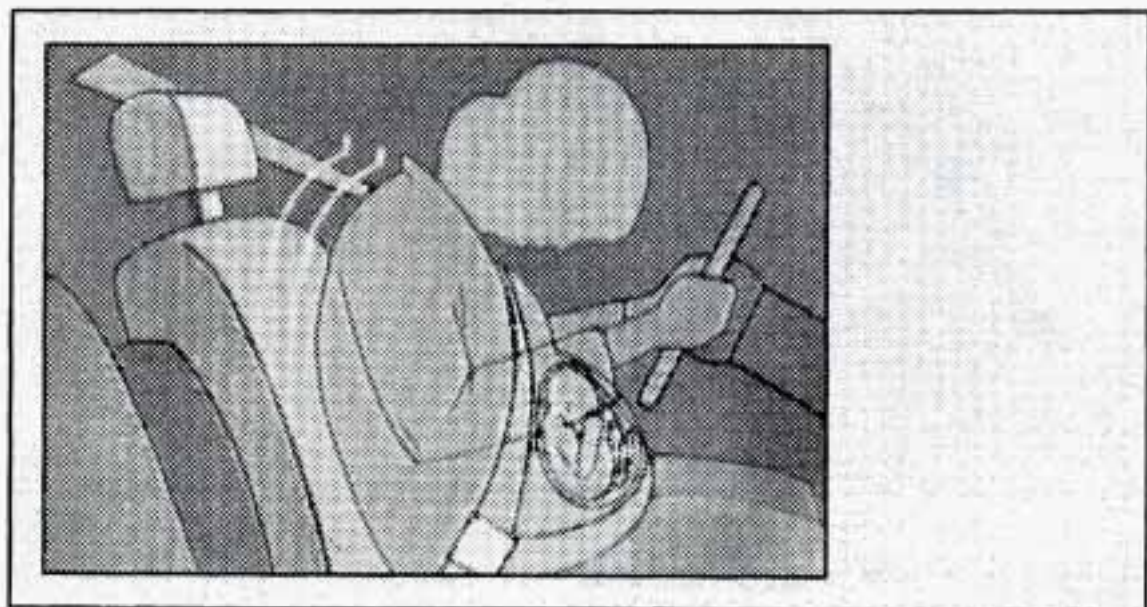

AM135001

Safety belts work for everyone, including pregnant women. Like all occupants, they are more likely to be seriously injured if they don't wear safety belts.

A pregnant woman should wear a lap-shoulder belt, and the lap portion should be worn as low as possible throughout the pregnancy.

The best way to protect the fetus is to protect the mother. When a safety belt is worn properly, it's more likely that the fetus won't be hurt in a crash. For pregnant women, as for anyone, the key to making safety belts effective is wearing them properly.



---

## ***Right Front Passenger Position***

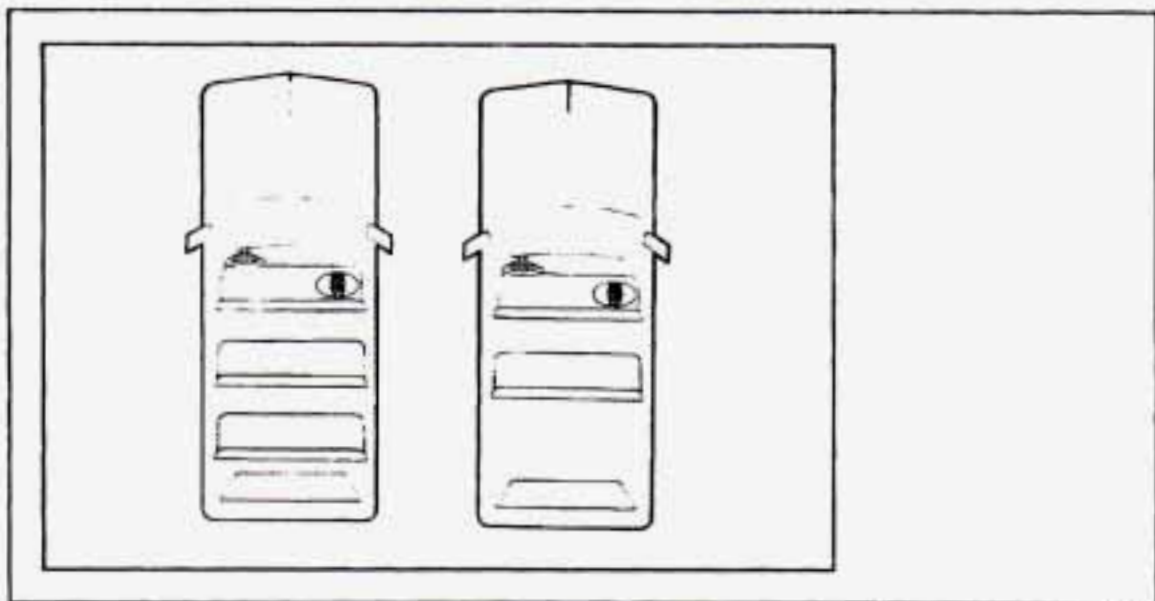

K2426

The right front passenger's safety belt works the same way as the driver's safety belt. See "Driver Position," earlier in this section.

When the lap portion of the belt is pulled out all the way, it will lock. If it does, let it go back all the way and start again.

## ***Center Passenger Position (Except Wagon Models Second Seat)***

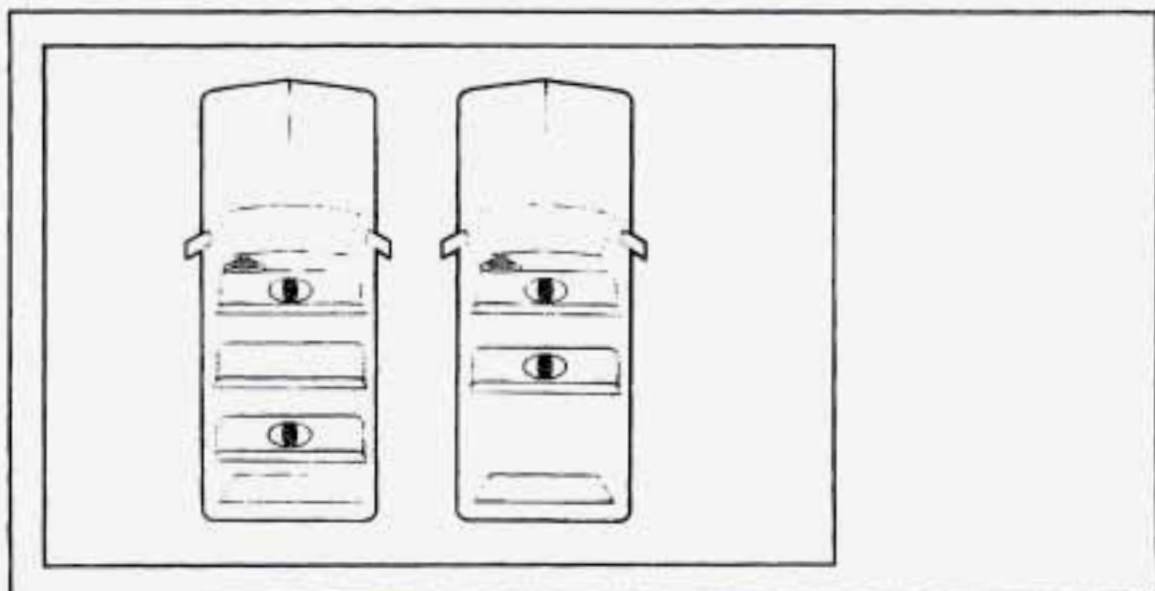

K2436

If your vehicle has front and rear bench seats, someone can sit in the center positions.

## **Seats & Safety Belts**

---

When you sit in the center seating position, (except in the second seat of the Wagon Models) you have a lap safety belt, which has no retractor. To make the belt longer, tilt the latch plate and pull it along the belt.

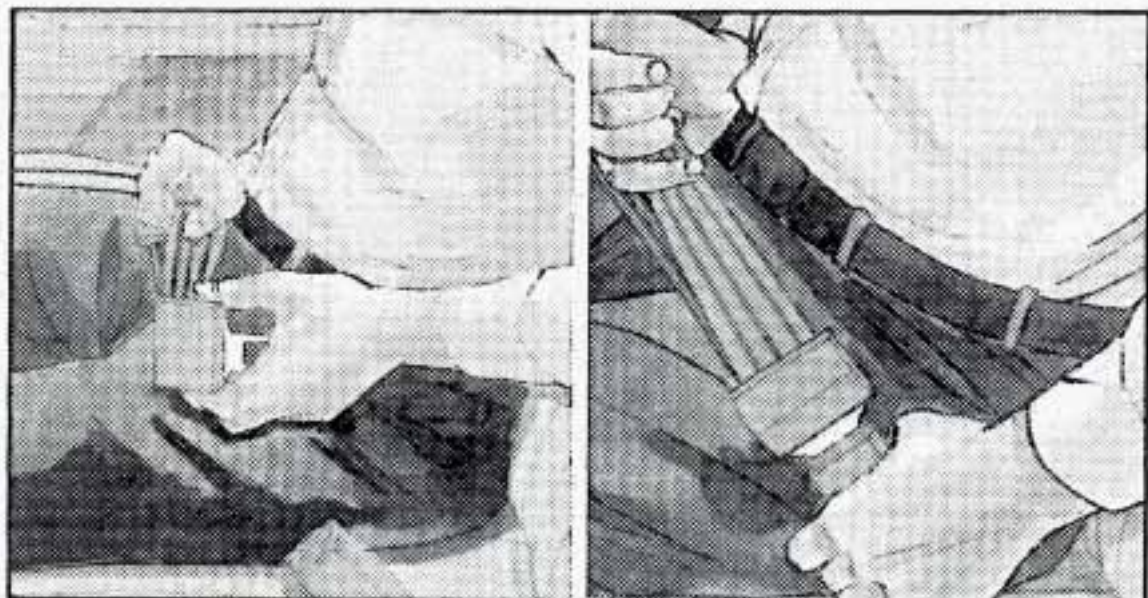

AN145041

AN145043

To make the belt shorter, pull its free end as shown until the belt is snug.

Buckle, position and release it the same way as the lap part of a lap-shoulder belt.

If the belt isn't long enough, see "Safety Belt Extender" at the end of this section.

Make sure the release button on the buckle faces upward or outward so you would be able to unbuckle it quickly if you ever had to.

## Center Passenger Position (Wagon Models Second Seat)

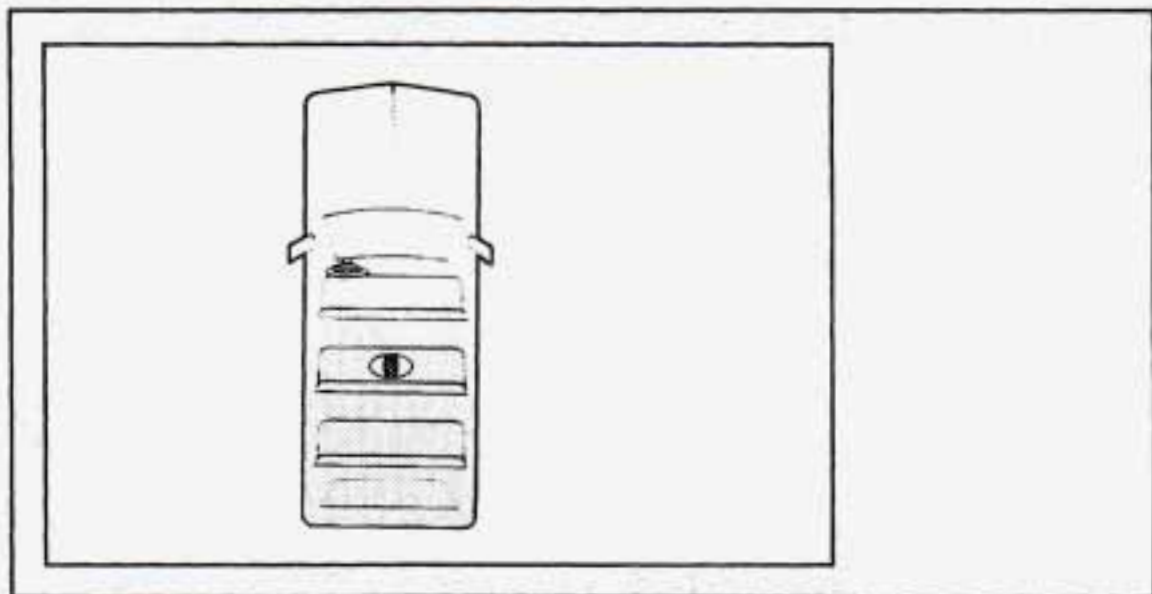

K2437

When you sit in the center position of the wagon model second seat, you have a lap safety belt which has a retractor.

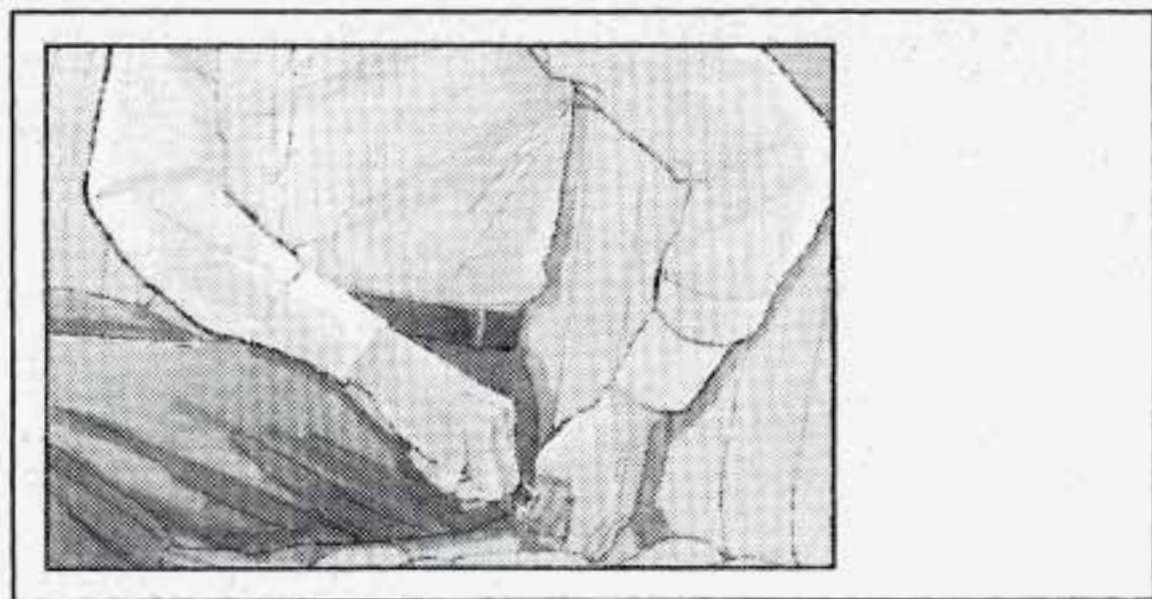

AN146053

1. Pick up the latch plate and, in a single motion, pull the belt across you. Don't let it get twisted.
2. Push the latch plate into the buckle until it clicks. If the belt stops before it reaches the buckle, let it go back all the way and start again.

## ***Seats & Safety Belts***

---

3. Feed the lap belt into the retractor to tighten it.
4. Position and release it the same way as the lap part of a lap-shoulder belt.

If the belt isn't long enough, see "Safety Belt Extender" at the end of this section. Make sure the release button on the buckle faces upward or outward so you would be able to unbuckle it quickly if you ever had to.

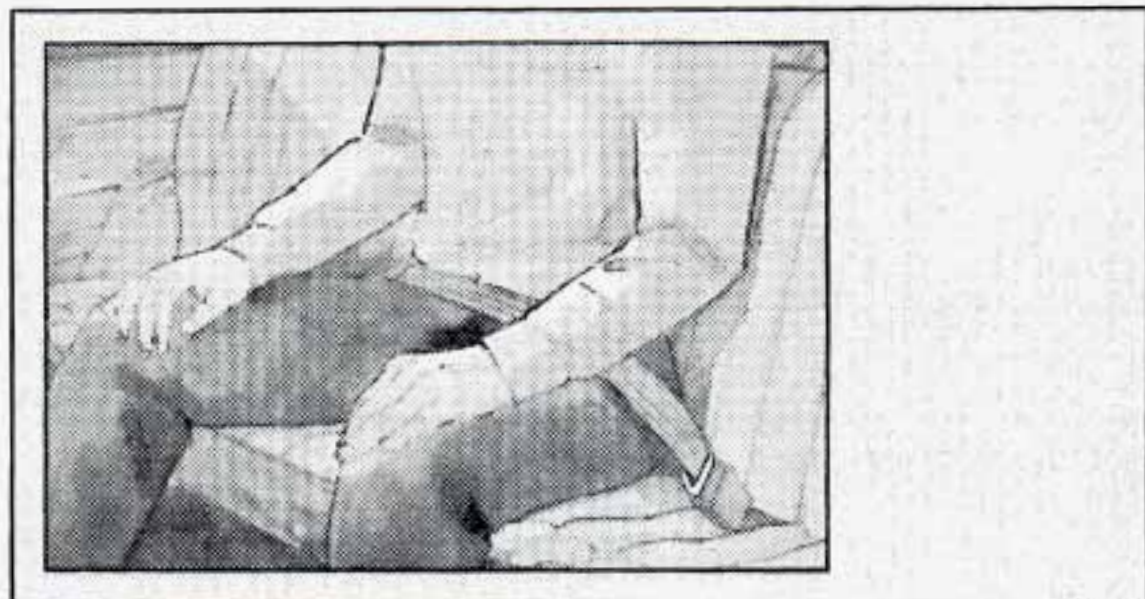

AN145054

### ***Rear Seat Passengers***

It's very important for rear seat passengers to buckle up! Accident statistics show that unbelted people in the rear seat are hurt more often in crashes than those who are wearing safety belts.

Rear passengers who aren't safety belted can be thrown out of the vehicle in a crash. And they can strike others in the vehicle who are wearing safety belts.

## ***Rear Seat Outside Positions***

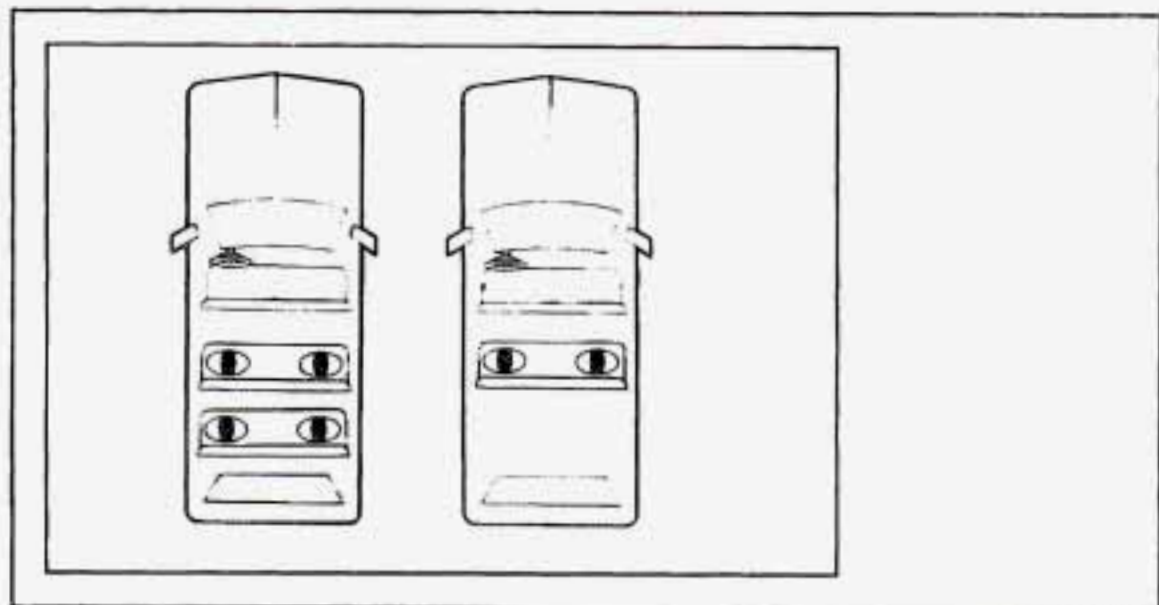

K2428

## ***Lap-Shoulder Belt***

The positions next to the windows have lap-shoulder belts. Here's how to wear one properly.

1. Pick up the latch plate and pull the belt across you. Don't let it get twisted.

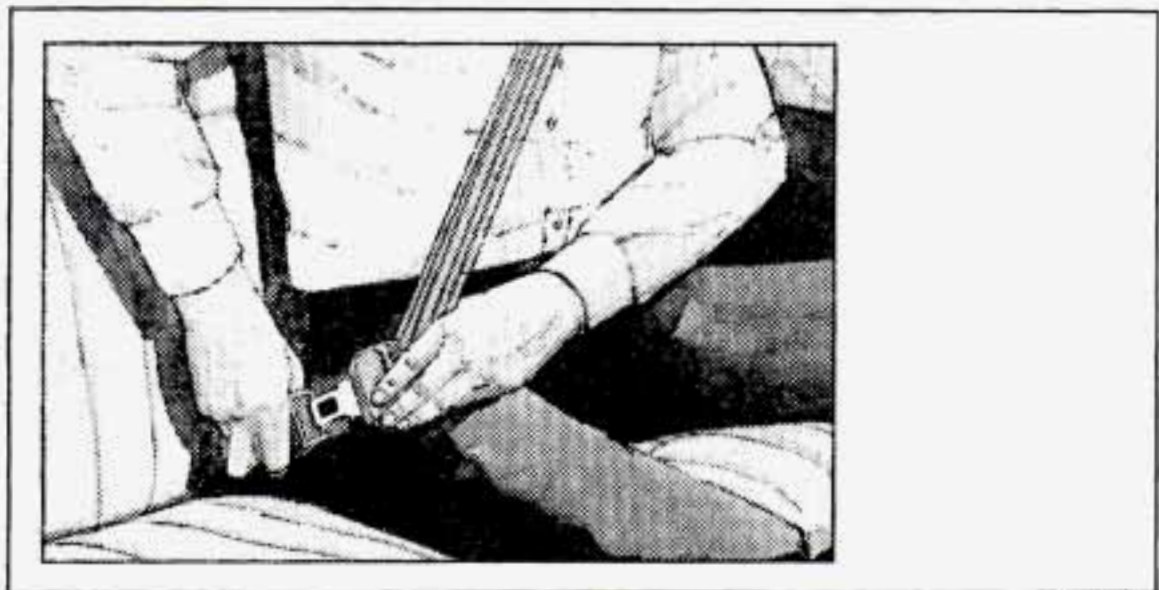

AN147025

2. Push the latch plate into the buckle until it clicks.

If the belt stops before it reaches the buckle, tilt the latch plate and keep pulling until you can buckle it.

## **Seats & Safety Belts**

If the belt is not long enough, see "Safety Belt Extender" at the end of this section.

Make sure the release button on the buckle faces upward or outward so you would be able to unbuckle it quickly if you ever had to.

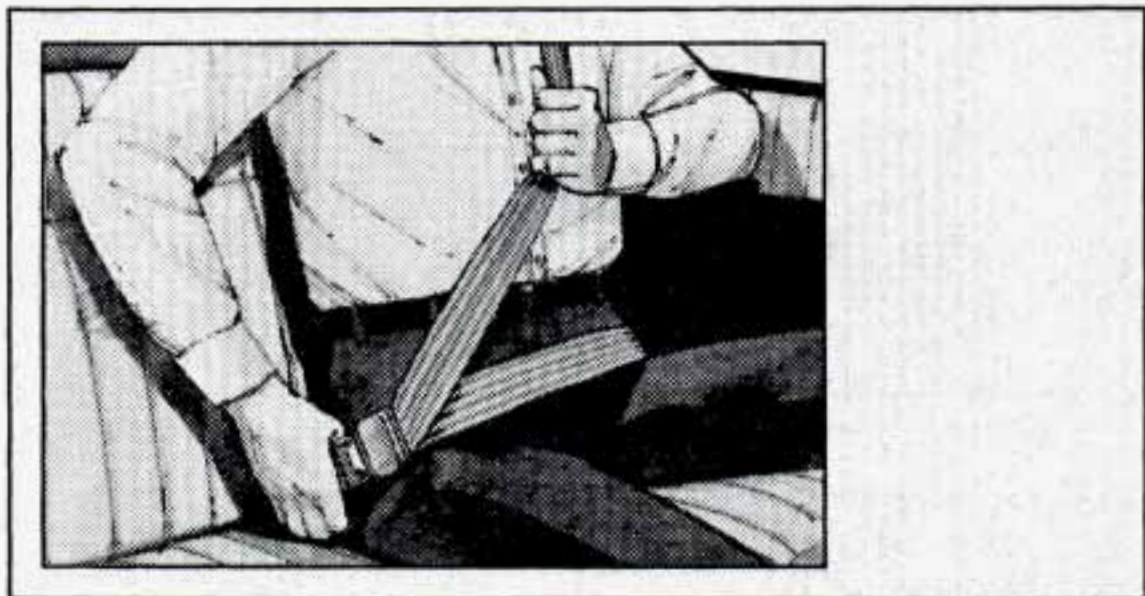

AM147096

- To make the lap part tight, pull down on the buckle end of the belt as you pull up the shoulder part.

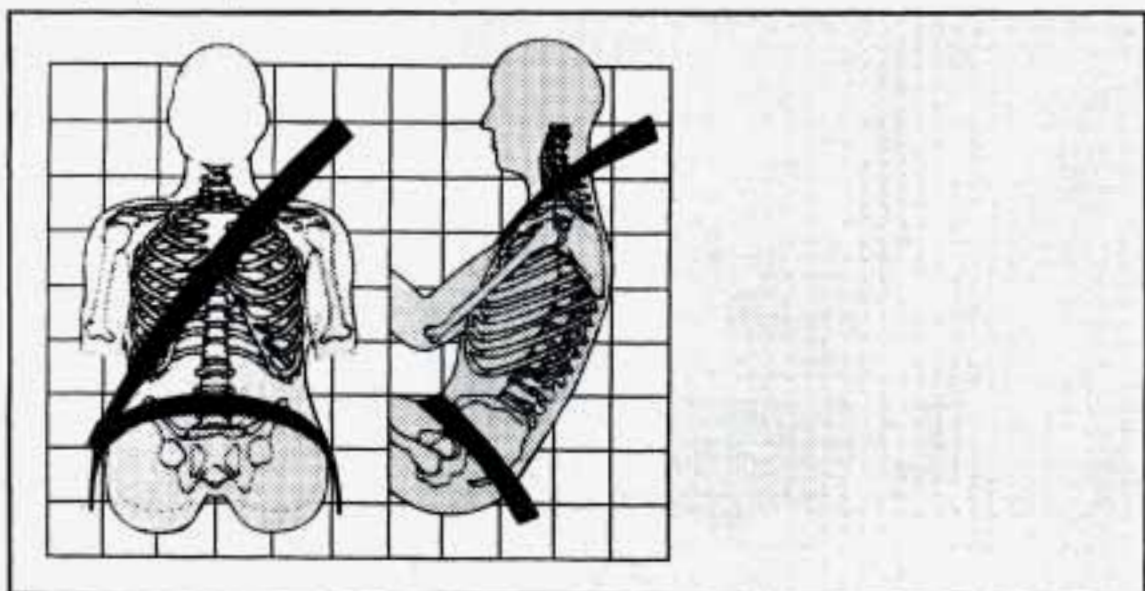

AM120007

The lap part of the belt should be low and snug on the hips, just touching the thighs. In a crash, this applies force to the strong pelvic bones. And you'd be less likely to slide under the lap belt. If you slid under it, the belt

would apply force at your abdomen. This could cause serious or even fatal injuries. The shoulder belt should go over the shoulder and across the chest. These parts of the body are best able to take belt restraining forces.

The safety belt locks if there is a sudden stop or a crash.

## CAUTION



You can be seriously hurt if your shoulder belt is too loose. In a crash you would move forward too much, which could increase injury. The shoulder belt should fit against your body.

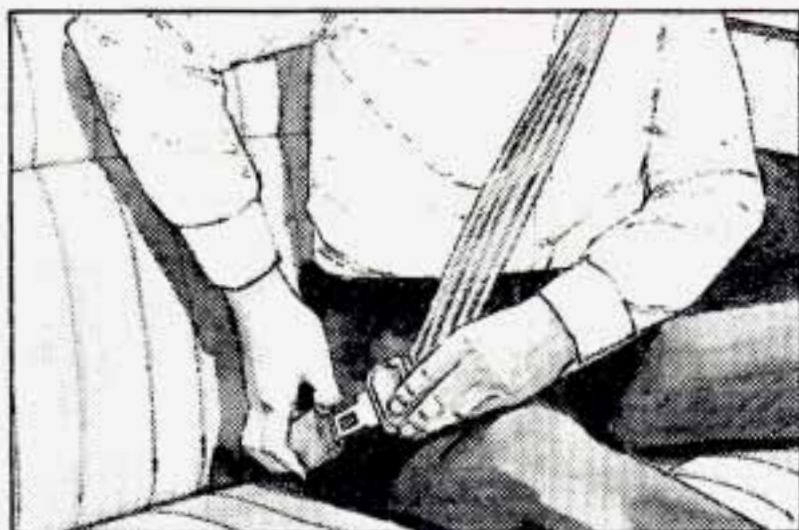

AN147030

To unlatch the belt, just push the button on the buckle.

# Seats & Safety Belts

## Children

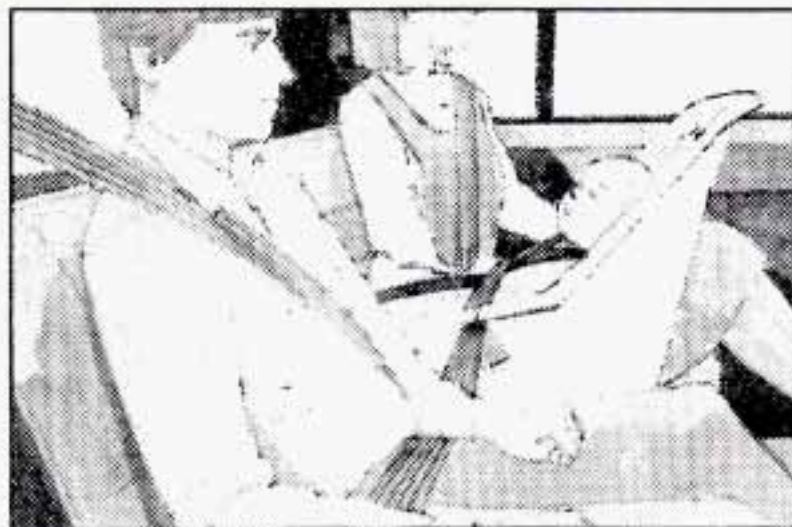

AN150036

Everyone in a vehicle needs protection! That includes infants and all children smaller than adult size. In fact, the law in every state and Canadian province says children up to some age must be restrained while in a vehicle.

### *Smaller Children and Babies*

#### **CAUTION**



Smaller children and babies should always be restrained in a child or infant restraint. The instructions for the restraint will say whether it is the right type and size for your child. A very young child's hip bones are so small that a regular belt might not stay low on the hips, as it should. Instead, the belt will likely be over the child's abdomen. In a crash the belt would apply force right on the child's abdomen, which could cause serious or fatal injuries. So, be sure that any child small enough for one is always properly restrained in a child or infant restraint.





AM150035

## CAUTION



Never hold a baby in your arms while riding in a vehicle. A baby doesn't weigh much—until a crash. During a crash a baby will become so heavy you can't hold it. For example, in a crash at only 25 mph (40 km/h), a 12-pound (5.5 kg) baby will suddenly become a 240-pound (110 kg) force on your arms. The baby would be almost impossible to hold.

Secure the baby in an infant restraint.

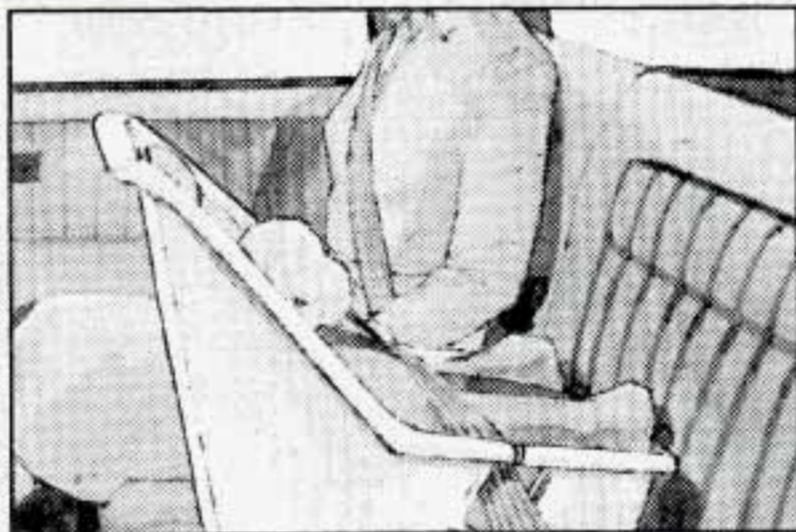

AN150037

# Seats & Safety Belts

## Child Restraints

Be sure to follow the instructions for the restraint. You may find these instructions on the restraint itself or in a booklet, or both. These restraints use the belt system in your vehicle, but the child also has to be secured within the restraint to help reduce the chance of personal injury. The instructions that come with the infant or child restraint will show you how to do that.

## Where to Put the Restraint

Accident statistics show that children are safer if they are restrained in the rear rather than the front seat. We at General Motors therefore recommend that you put your child restraint in the rear seat unless the child is an infant and you're the only adult in the vehicle. In that case, you might want to secure the restraint in the front seat where you can keep an eye on the baby.

Wherever you install it, be sure to secure the child restraint properly.

## CAUTION



An unsecured child restraint can move around in a collision or sudden stop and injure people in the vehicle. Be sure to properly secure any child restraint in your vehicle—even when no child is in it.

## Top Strap

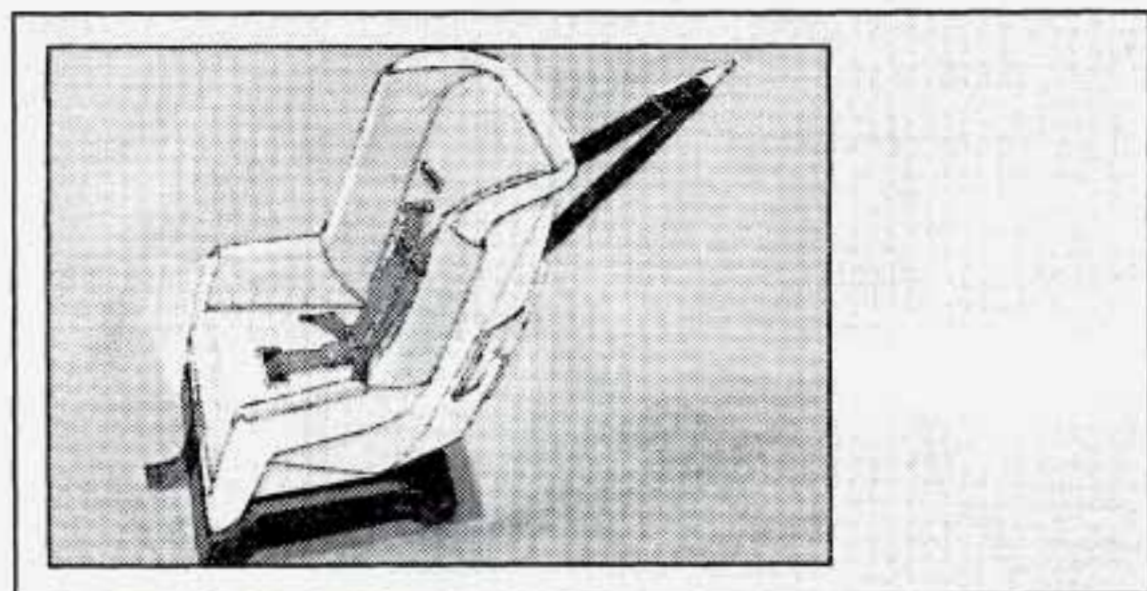

AN155001

If your child restraint has a top strap, it should be anchored. If you need to have an anchor installed, you can ask your GM dealer to put it in for you. If you want to install an anchor yourself, your dealer can tell you how to do it.

## Securing a Child Restraint in a Rear Outside Position

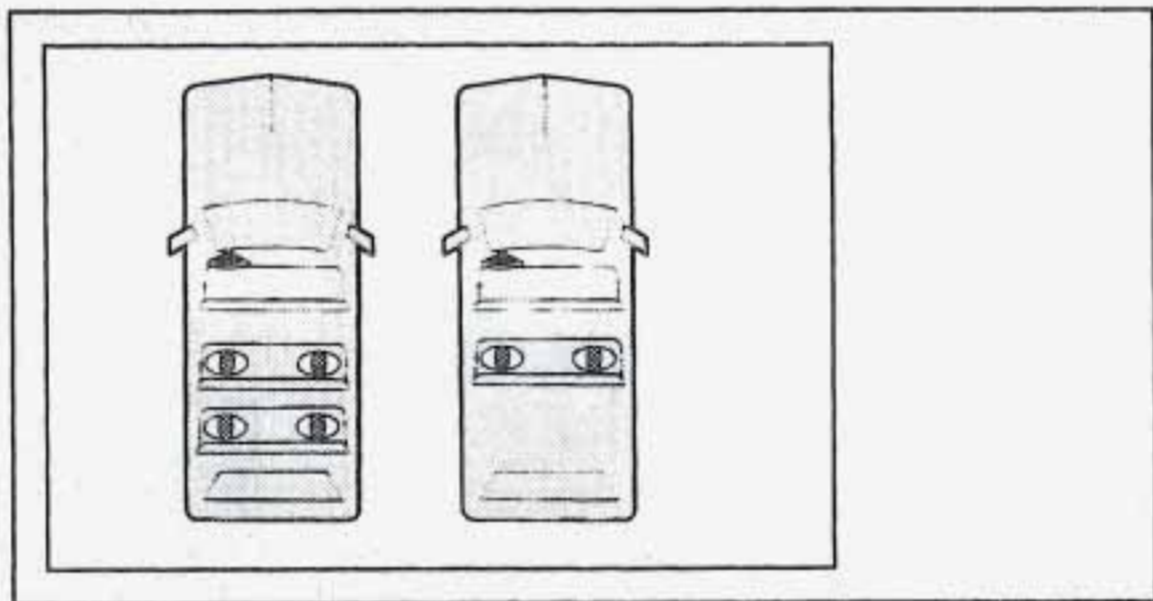

K2432

You'll be using the lap-shoulder belt. See the earlier section about the top strap if the child restraint has one.

1. Put the restraint on the seat. Follow the instructions for the child restraint.
2. Secure the child in the child restraint as the instructions say.

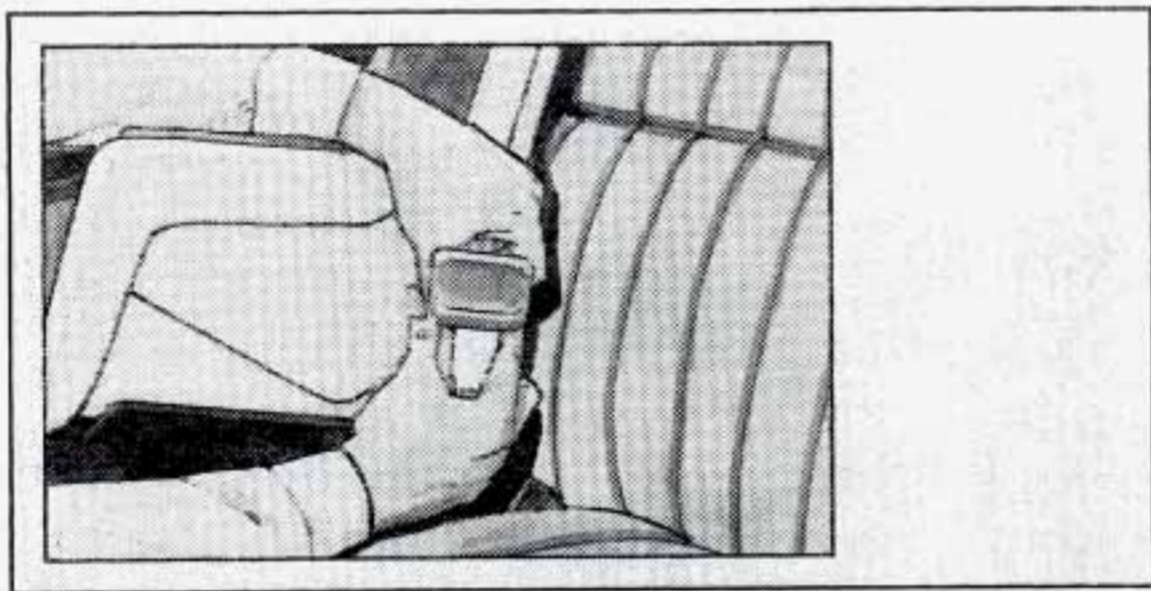

AN160147

3. Pull out the vehicle's safety belt. Make the belt as long as possible by tilting the latch plate and pulling it along the belt.

## Seats & Safety Belts

4. Run the lap part through or around the restraint. The child restraint instructions will show you how. See if the shoulder belt would go in front of the child's face or neck. If so, put it behind the child restraint.

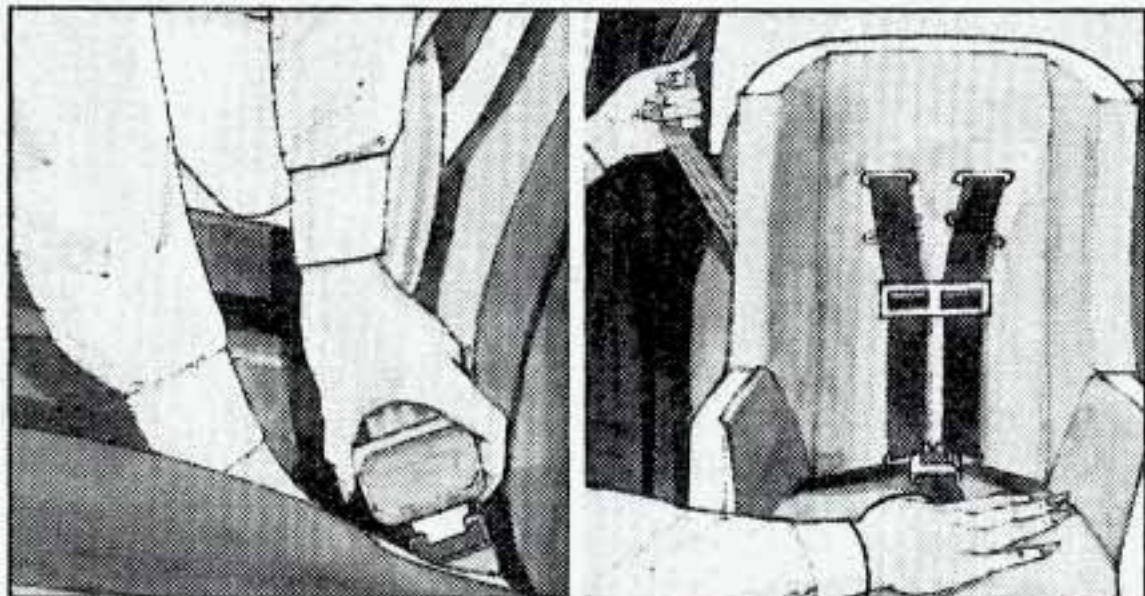

AN160062

AN160136

5. Buckle the belt. Make sure the release button faces upward or outward, so you'll be able to unbuckle it quickly if you ever need to.
6. To tighten the belt, pull up on the shoulder belt while you push down on the child restraint.

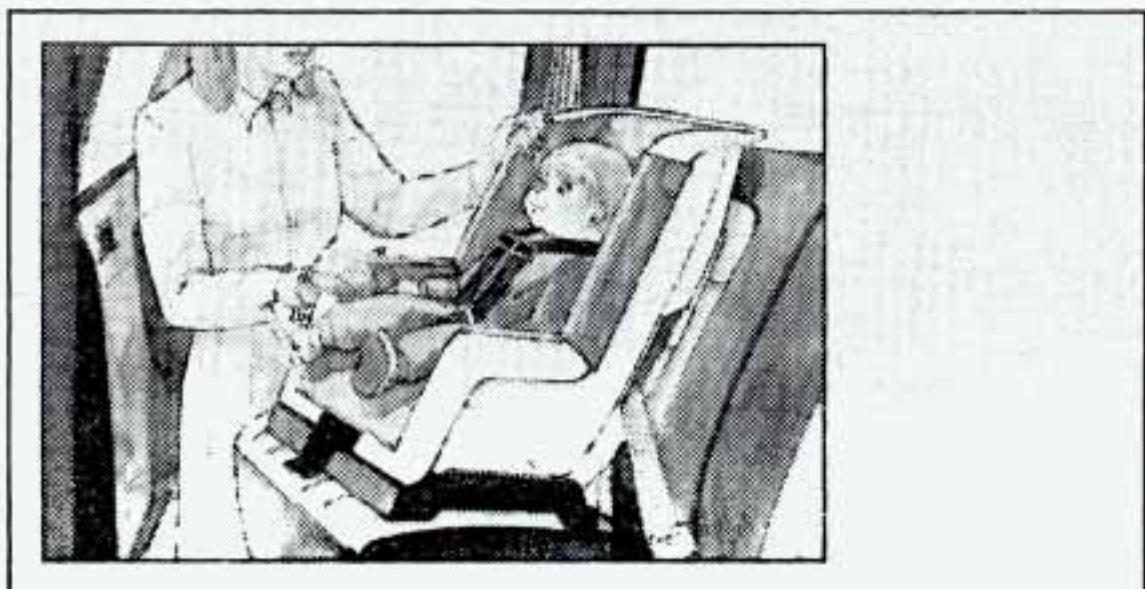

AN160067

7. Push and pull the child restraint in different directions to be sure it is secure.

To remove the child restraint, just unbuckle the vehicle's safety belt and let it go back all the way. The safety belt will move freely again and be ready to work for an adult or larger child passenger.

**Securing a Child Restraint in the Center Seat Position  
(Except Wagon Models Second Seat)**

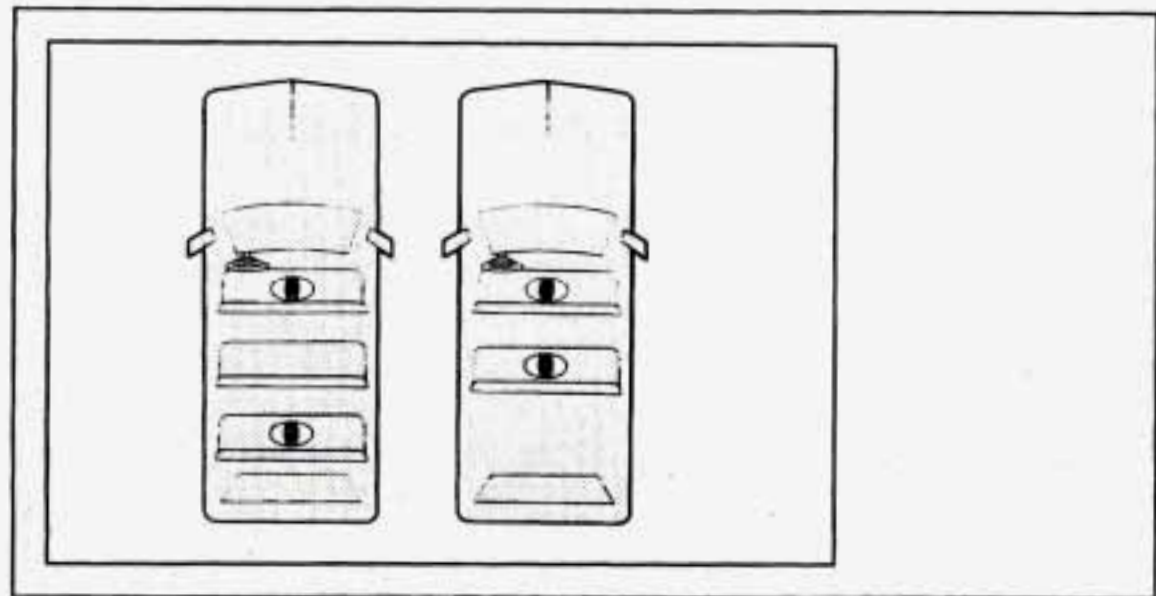

K2436

When you secure a child restraint in a center seating position, except in the second seat of a Wagon model, you'll be using the lap belt. See the earlier part about the top strap if the child restraint has one.

1. Make the belt as long as possible by tilting the latch plate and pulling it along the belt.

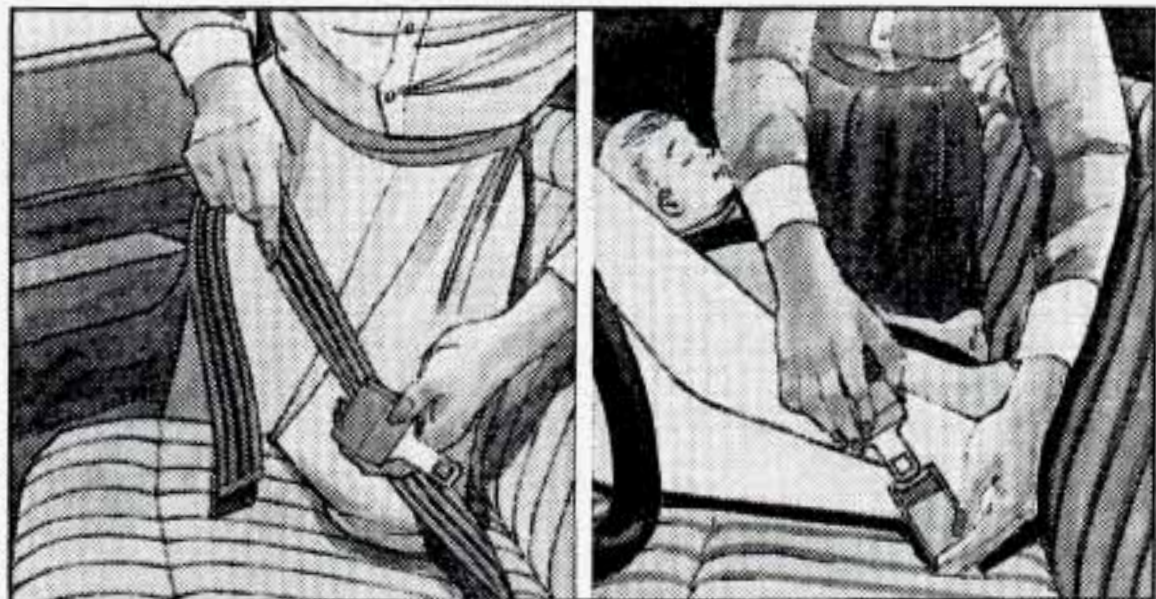

AN163029

AN163030

## **Seats & Safety Belts**

---

2. Put the restraint on the seat. Follow the instructions for the child restraint.
3. Secure the child in the child restraint as the instructions say.
4. Run the vehicle's safety belt through or around the restraint. The child restraint instructions will show you how.
5. Buckle the belt. Make sure the release button faces upward or outward, so you'll be able to unbuckle it quickly if you ever need to.
6. To tighten the belt, pull its free end while you push down on the child restraint.
7. Push and pull the child restraint in different directions to be sure it is secure. If the child restraint isn't secure, turn the latch plate over and buckle it again. Then see if it is secure. If it isn't, secure the restraint in a different place in the vehicle and contact the child restraint maker for their advice.

To remove the child restraint, just unbuckle the vehicle's safety belt. It will be ready to work for an adult or larger child passenger.

### ***Securing a Child Restraint in the Center Seat Position (Wagon Models Second Seat)***

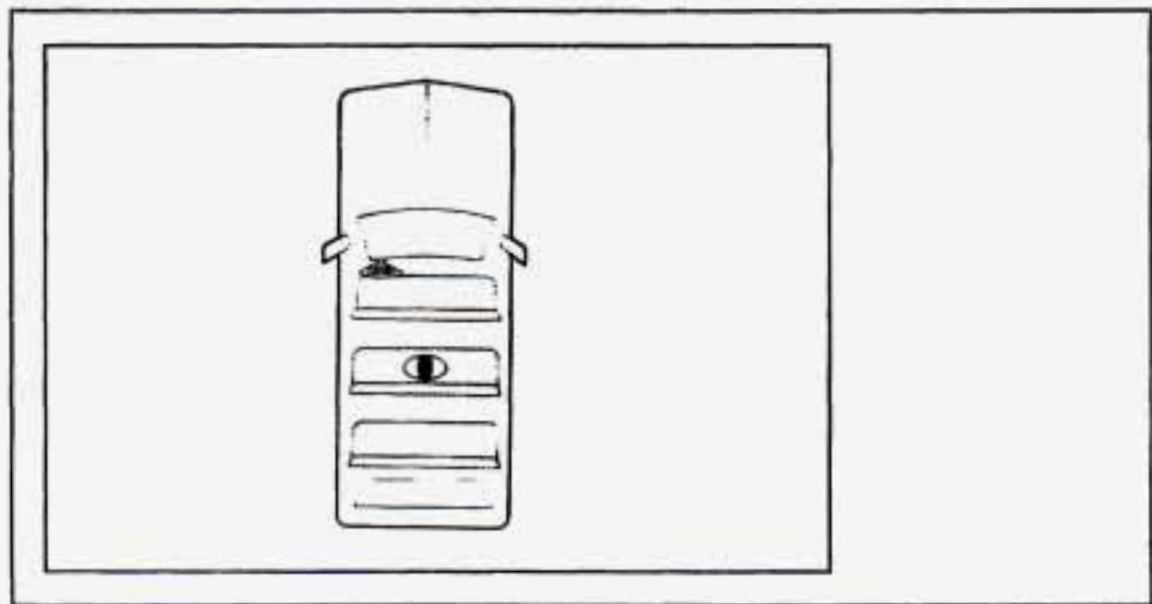

K2437

You'll be using the lap belt. See the earlier part about the top strap if the child restraint has one.

1. Put the restraint on the seat. Follow the instructions for the child restraint.
2. Secure the child in the child restraint as the instructions say.

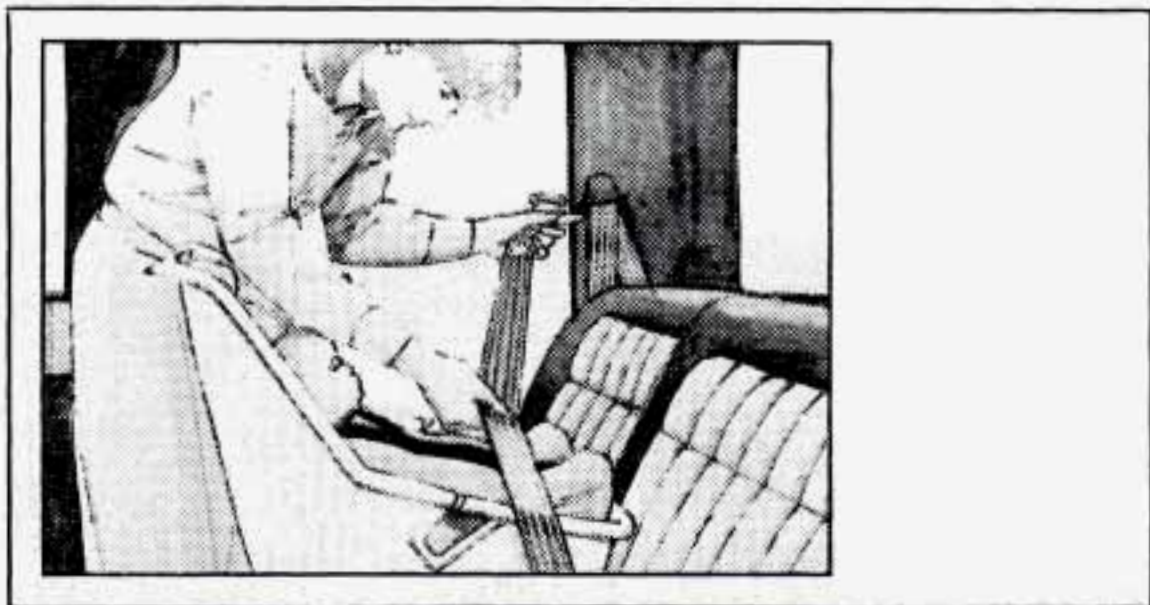

AN163055

3. Pull the lap belt all the way out without stopping.
4. While holding it out, run the belt through or around the child restraint. The child restraint instructions will show you how.

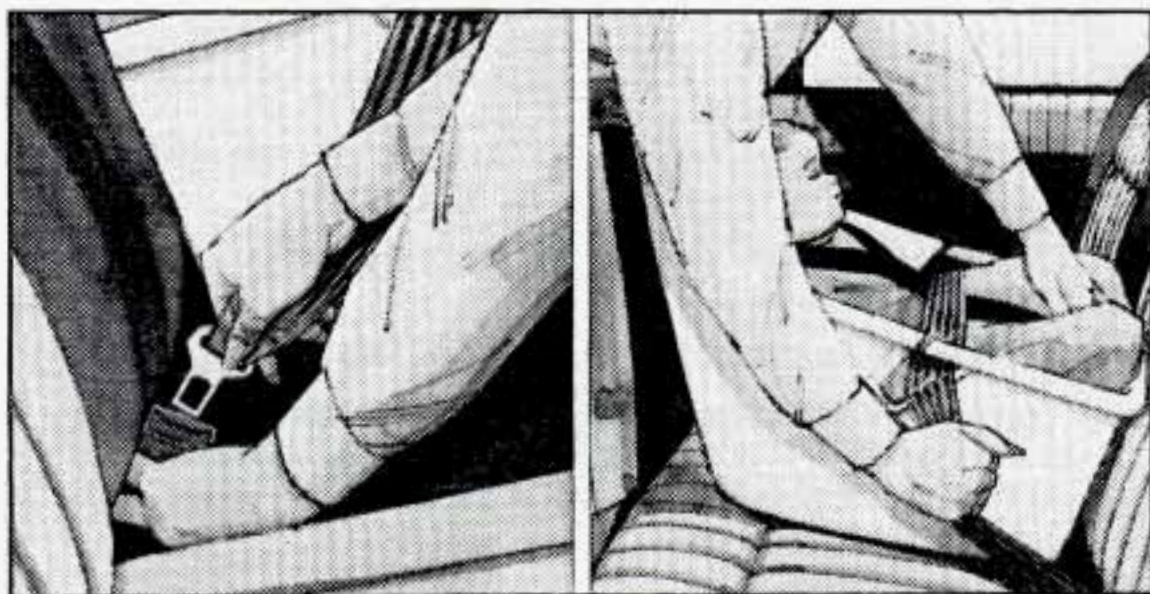

AN163056

AN163057

5. Buckle the belt. Make sure the release button faces upward or outward, so you'll be able to unbuckle it quickly if you ever need to.

## ***Seats & Safety Belts***

---

6. Pull the rest of the belt all the way out of the retractor to set the lock.
7. To tighten the belt, feed it back into the retractor while you push down on the child restraint.
8. Push and pull the child restraint in different directions to be sure it is secure.

To remove the child restraint, just unbuckle the vehicle's safety belt and let it go back all the way. The safety belt will move freely again and be ready to work for an adult or larger child passenger.

### ***Securing a Child Restraint in the Right Front Seat***

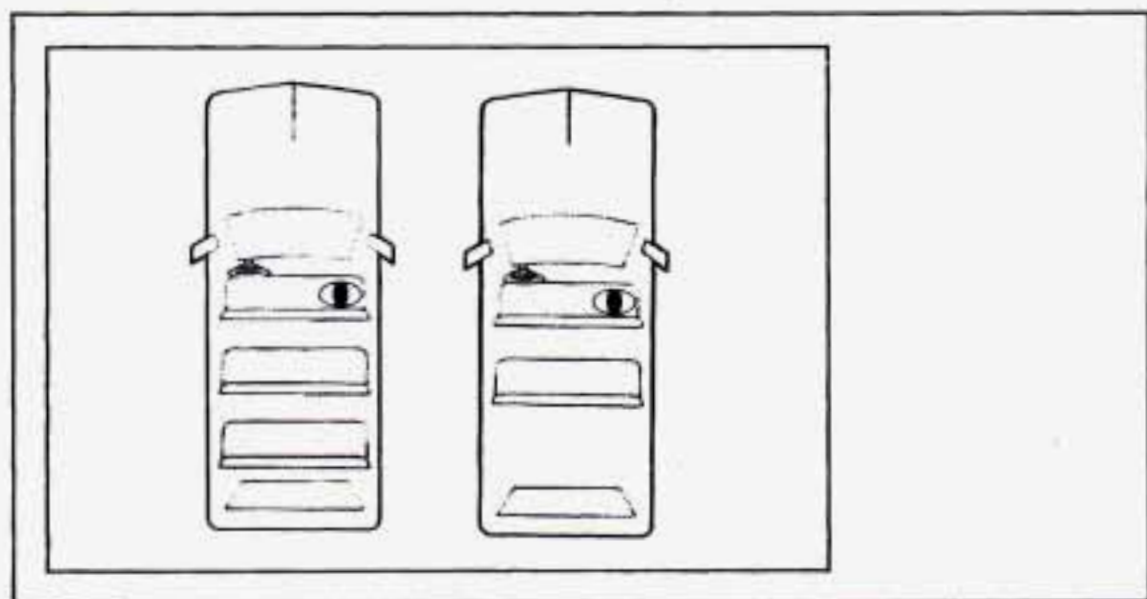

K243B

You'll be using the lap-shoulder belt. See the earlier part about the top strap if the child restraint has one.

1. Put the restraint on the seat. Follow the instructions for the child restraint.
2. Secure the child in the child restraint as the instructions say.
3. Pull out the vehicle's safety belt and run the lap part through or around the restraint. The child restraint instructions will show you how. See if the shoulder belt would go in front of the child's face or neck. If so, put it behind the child restraint.



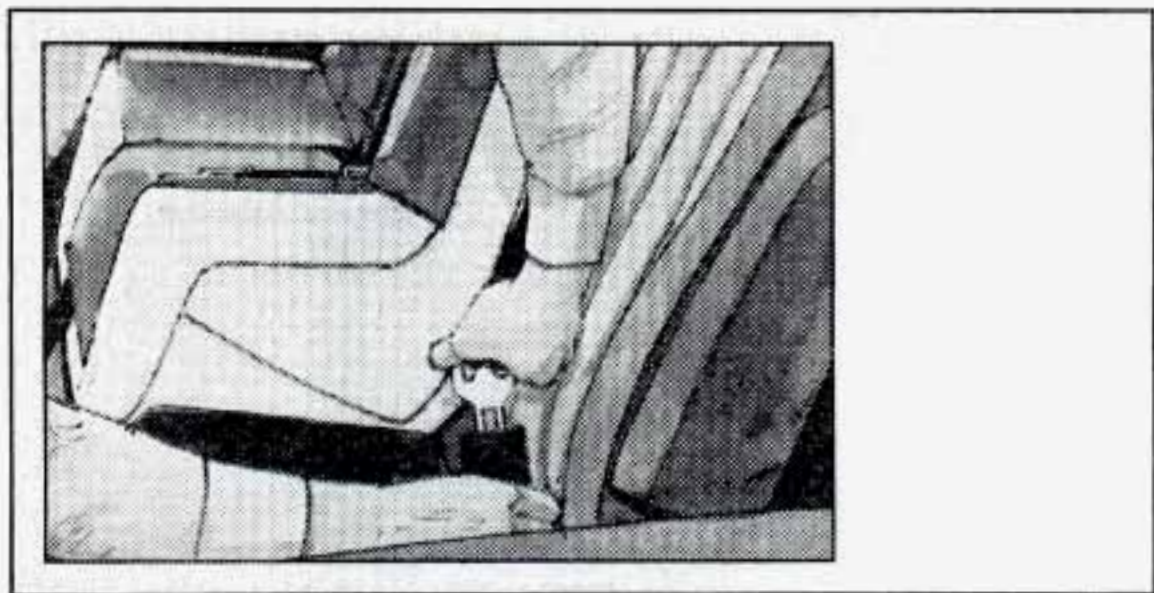

AN165013

4. Buckle the belt. Make sure the release button faces upward or outward, so you'll be able to unbuckle it quickly if you ever need to.
5. Pull the rest of the belt all the way out of the lap retractor to set the lock.

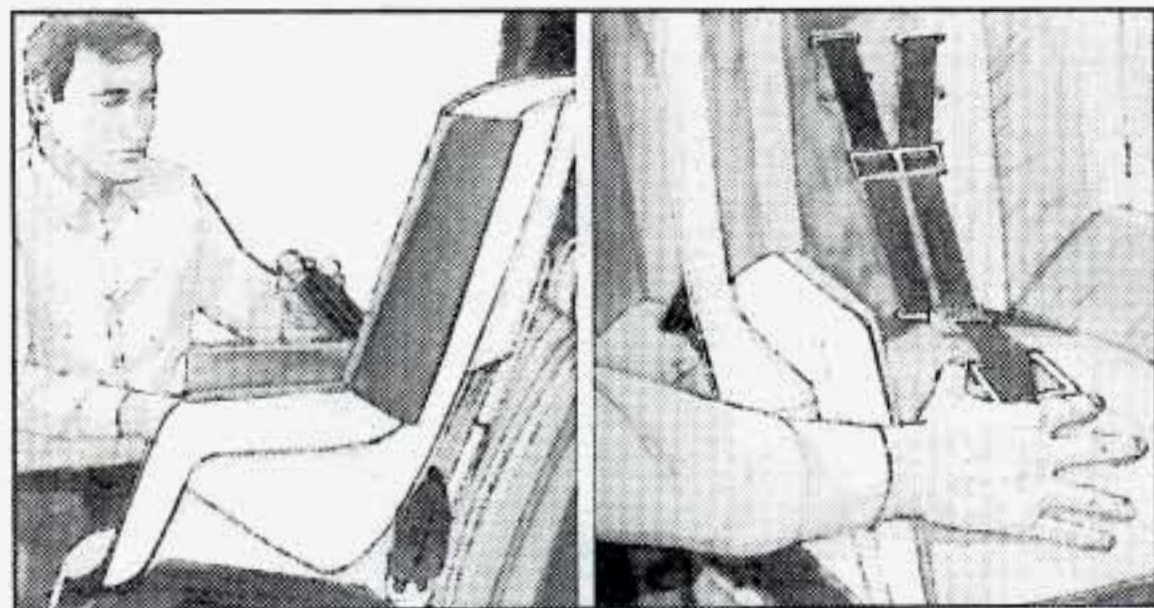

AN165123

AN165015

6. To tighten the belt, feed the lap belt back into the retractor while you push down on the child restraint.

## Seats & Safety Belts

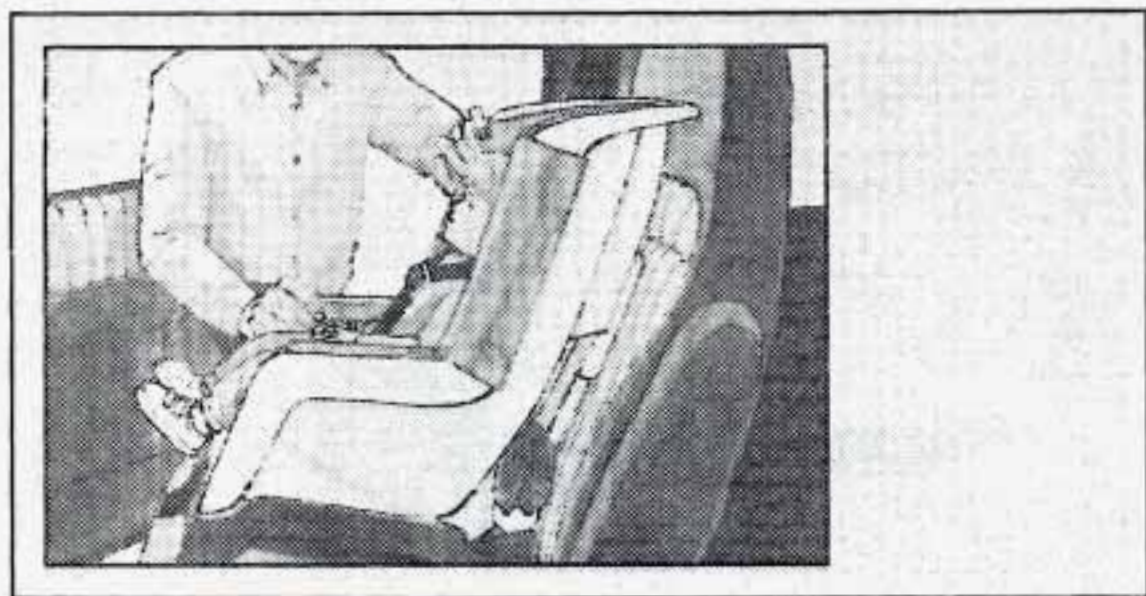

AM165016

7. Push and pull the child restraint in different directions to be sure it is secure.

To remove the child restraint, unbuckle the vehicle's safety belt and let it go back all the way. The safety belt will move freely again and be ready to work for an adult or larger child passenger.

### ***Larger Children***



AM170057

Children who have outgrown child restraints should wear the vehicle's safety belts. If you have the choice, a child should sit next to a window so the child can wear a lap-shoulder belt and get the additional restraint a shoulder belt can provide. Accident statistics show that children are safer if they are restrained in the rear seat. But they need to use the safety belts properly.

- Children who aren't buckled up can be thrown out in a crash.



AM170060

- Children who aren't buckled up can strike other people who are.

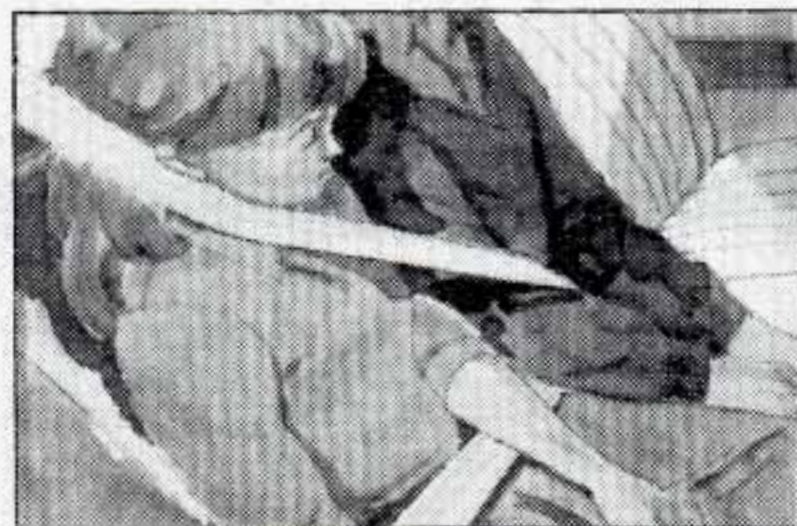

AM170058

## CAUTION



Never do this.

Here two children are wearing the same belt. The belt can't properly spread the impact forces. In a crash, the two children can be crushed together and seriously injured. A belt must be used by only one person at a time.

## Seats & Safety Belts

**Q:** What if a child is wearing a lap-shoulder belt, but the child is so small that the shoulder belt is very close to the child's face or neck?

**A:** Move the child toward the center of the vehicle, but be sure that the shoulder belt still is on the child's shoulder, so that in a crash the child's upper body would have the restraint that belts provide. If the child is so small that the shoulder belt still is very close to the child's face or neck, you might want to place the child in a seat that has a lap belt, if your vehicle has one.

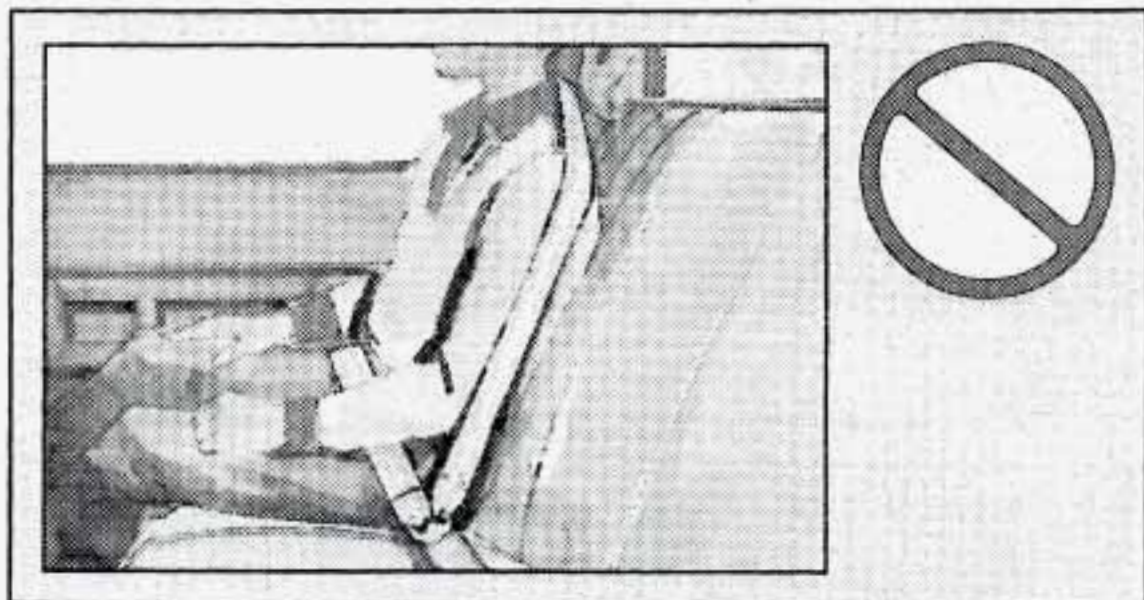

AM170064

### CAUTION



Never do this.

Here a child is sitting in a seat that has a lap-shoulder belt, but the shoulder part is behind the child. If the child wears the belt in this way, in a crash the child might slide under the belt. The belt's force would then be applied right on the child's abdomen. That could cause serious or fatal injuries.

Wherever the child sits, the lap portion of the belt should be worn low and snug on the hips, just touching the child's thighs. This applies belt force to the child's pelvic bones in a crash.

### Safety Belt Extender

If the vehicle's safety belt will fasten around you, you should use it. But if a safety belt isn't long enough to fasten, your dealer will order you an extender. It's free. When you go in to order it, take the heaviest coat you will wear, so the extender will be long enough for you. The extender will be just for you,

---

and just for the seat in your vehicle that you choose. Don't let someone else use it, and use it only for the seat it is made to fit. To wear it, just attach it to the regular safety belt.

## **Checking Your Restraint Systems**

Now and then, make sure all your belts, buckles, latch plates, retractors, anchorages and reminder systems are working properly. Look for any loose parts or damage. If you see anything that might keep a restraint system from doing its job, have it repaired.

## **Replacing Safety Belts After a Crash**

If you've had a crash, do you need new belts?

After a very minor collision, nothing may be necessary. But if the belts were stretched, as they would be if worn during a more severe crash, then you need new belts.

If you ever see a label on a right front safety belt that says to replace the belt, be sure to do so. Then it will be there to help protect you in an accident. You would see this label on the belt near the door opening.



AM177001

If belts are cut or damaged, replace them. Collision damage also may mean you will have to have safety belt parts like the retractor replaced or anchorage locations repaired—even if the belt wasn't being used at the time of the collision.

## Seats & Safety Belts

---

**Q:** What's wrong with this?

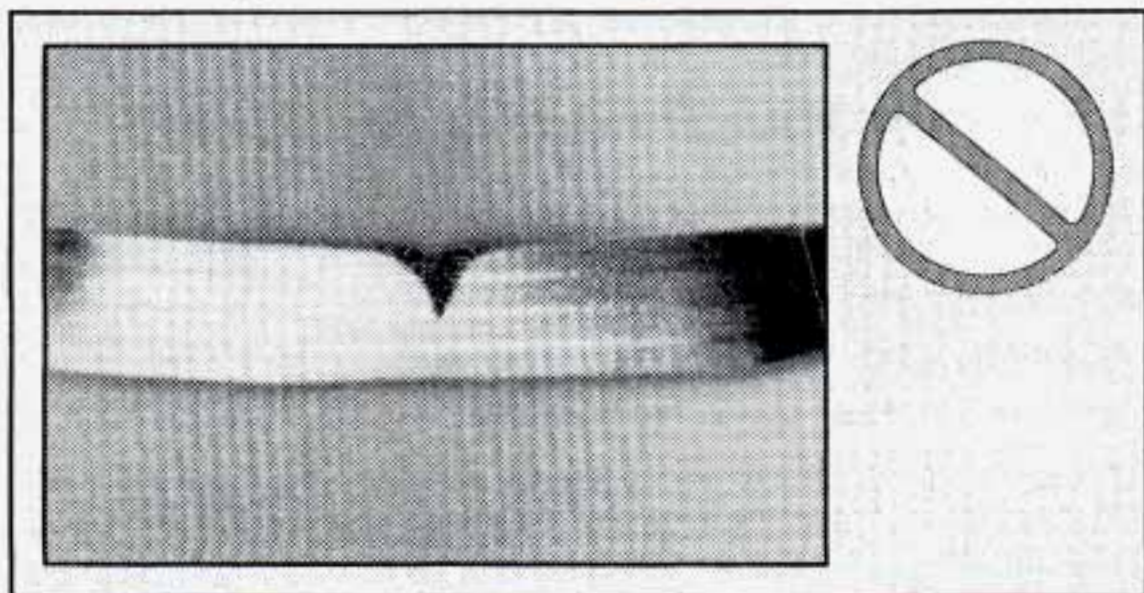

AP125004

**A:** The belt is torn.

### CAUTION



Torn or frayed belts may not protect you in a crash. They can rip apart under impact forces. If a belt is torn or frayed, get a new one right away.

Before replacing any safety belt, see your dealer for the correct part number. You'll need the model year and model number for your vehicle. The model year is on your title and registration. And you can find the model number on the certification/tire label of your vehicle.

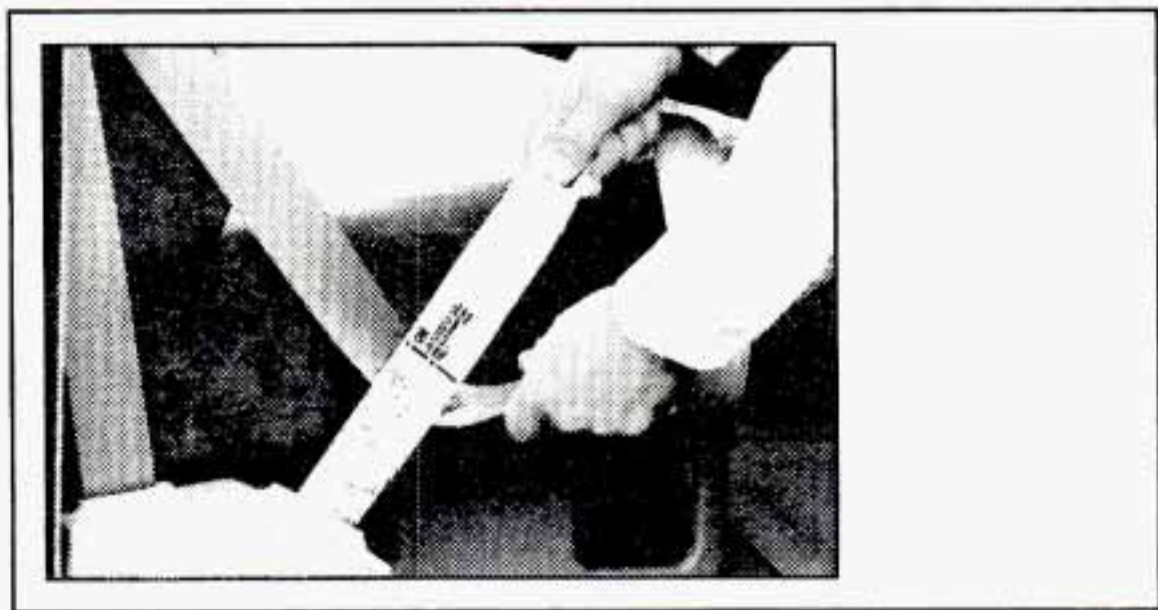

K2447

The model number on the replacement belt must be listed on the safety belt you want to replace.





# Features & Controls

## Section



Here you can learn about the many standard and optional features on your vehicle, and information on starting, shifting, and braking. Also explained are the instrument panel and the warning systems that tell you if everything is working properly—and what to do if you have a problem.

**For explanation of vehicle symbols in this section, refer to “Vehicle Symbols” in Section 0.**

Keys .....	2-3
Your Doors and How They Work.....	2-5
Side Doors .....	2-5
Door Locks.....	2-6
Tailgate, Tailgate Glass and Rear Doors.....	2-7
Tailgate .....	2-8
Panel Doors .....	2-9
Theft .....	2-10
New Vehicle Break-In .....	2-11
Ignition Switch .....	2-11
Starting Your Engine.....	2-14
Driving Through Water .....	2-15
Automatic Transmission .....	2-17
Five-Speed Manual Transmission .....	2-20

## **Features & Controls**

---

Locking Rear Axle.....	2-22
Parking Brake.....	2-23
Parking Over Things That Burn.....	2-27
Engine Exhaust.....	2-28
Running Your Engine While You're Parked.....	2-29
Four-Wheel Drive.....	2-30
Transfer Case.....	2-30
Front Axle Locking Feature.....	2-32
Windows.....	2-33
Horn.....	2-35
Tilt Wheel.....	2-35
Multifunction Lever.....	2-36
Turn Signal and Lane Change Indicator.....	2-37
Headlight High-Low Beam.....	2-38
Windshield Wipers.....	2-39
Windshield Washer.....	2-40
Cruise Control.....	2-41
Headlights and Vehicle Lighting.....	2-46
Mirrors.....	2-51
Sun Visors.....	2-53
Rear Window Wiper and Washer.....	2-54
Cigarette Lighter/Ashtrays.....	2-55
Storage Compartments.....	2-55
Instrument Cluster.....	2-62
Warning Lights, Gages and Indicators.....	2-68
Gages.....	2-76
Luggage Carrier.....	2-80
Trailer Wiring Harness.....	2-82

## Keys

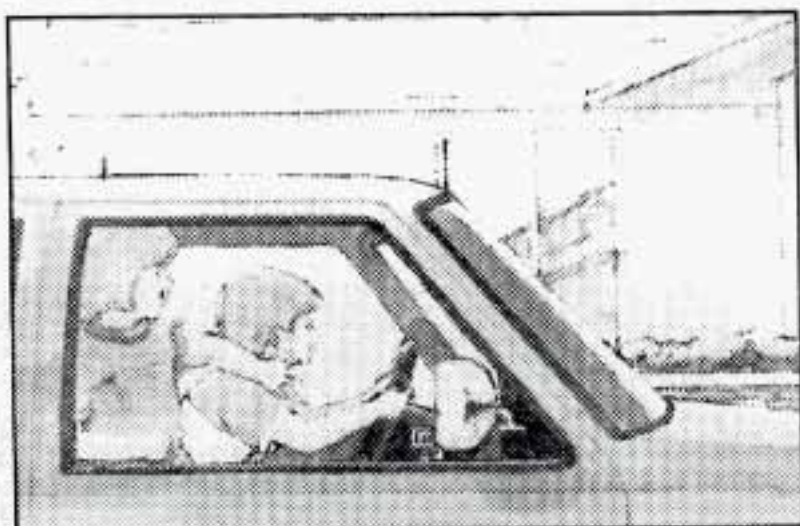

A0201001

### CAUTION



Leaving young children in a vehicle with the ignition key is dangerous for many reasons. A child or others could be badly injured or even killed.

They could operate power windows or other controls or even make the vehicle move. Don't leave the keys in a vehicle with young children.

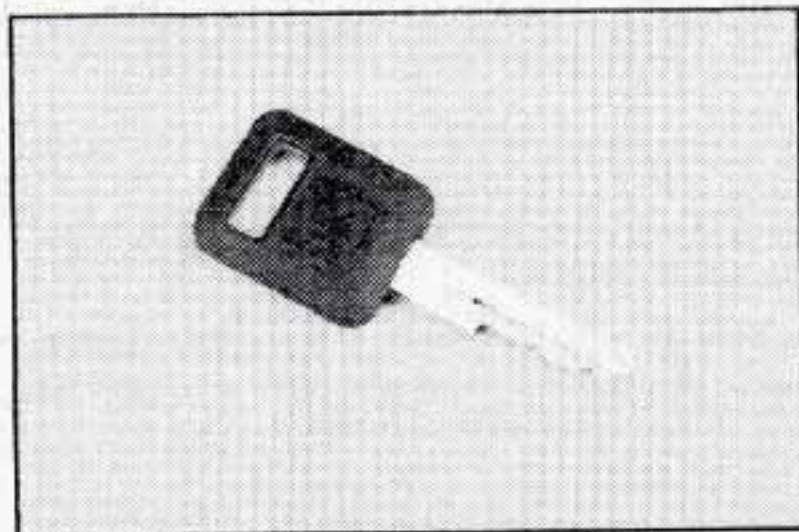

K512

The ignition keys are for the ignition only.

## Features & Controls

---

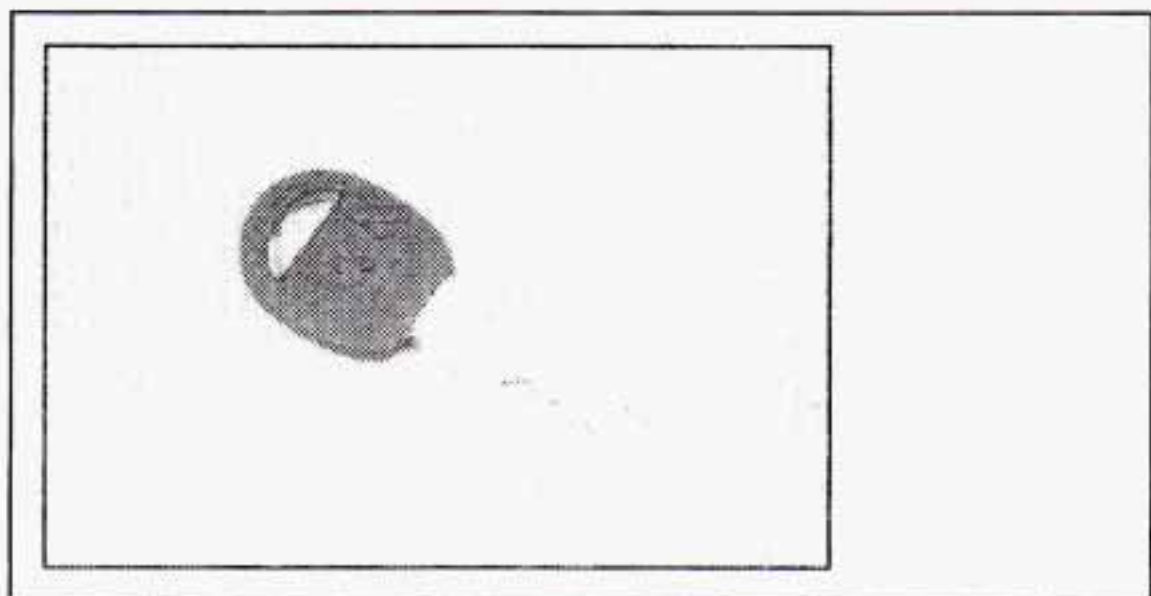

K5316

The door keys are for the doors and all other locks.

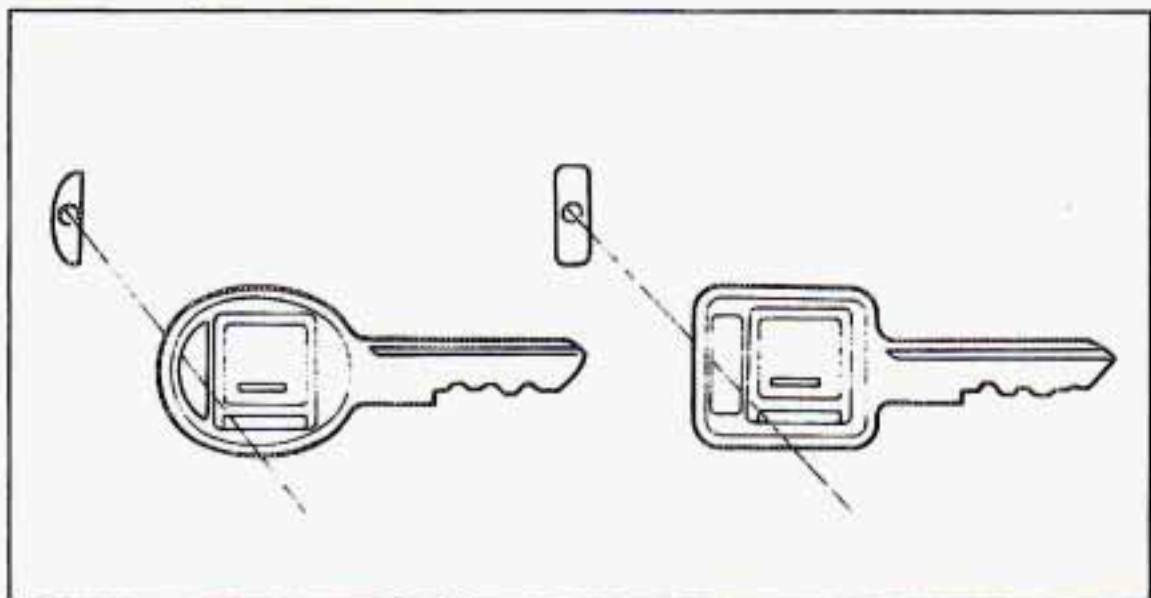

K1298

When a new vehicle is delivered, the dealer removes the plugs from the keys, and gives them to the first owner.

Each plug has a code on it that tells your dealer or a qualified locksmith how to make extra keys. Keep the plugs in a safe place. If you lose your keys, you'll be able to have new ones made easily using these plugs.

## NOTICE

Your vehicle has a number of new features that can help prevent theft. But you can have a lot of trouble getting into your vehicle if you ever lock your keys inside. You may even have to damage your vehicle to get in. So be sure you have extra keys.

## *Your Doors and How They Work*

### *Side Doors*

To open the door from the outside, pull the handle up and pull the door open.

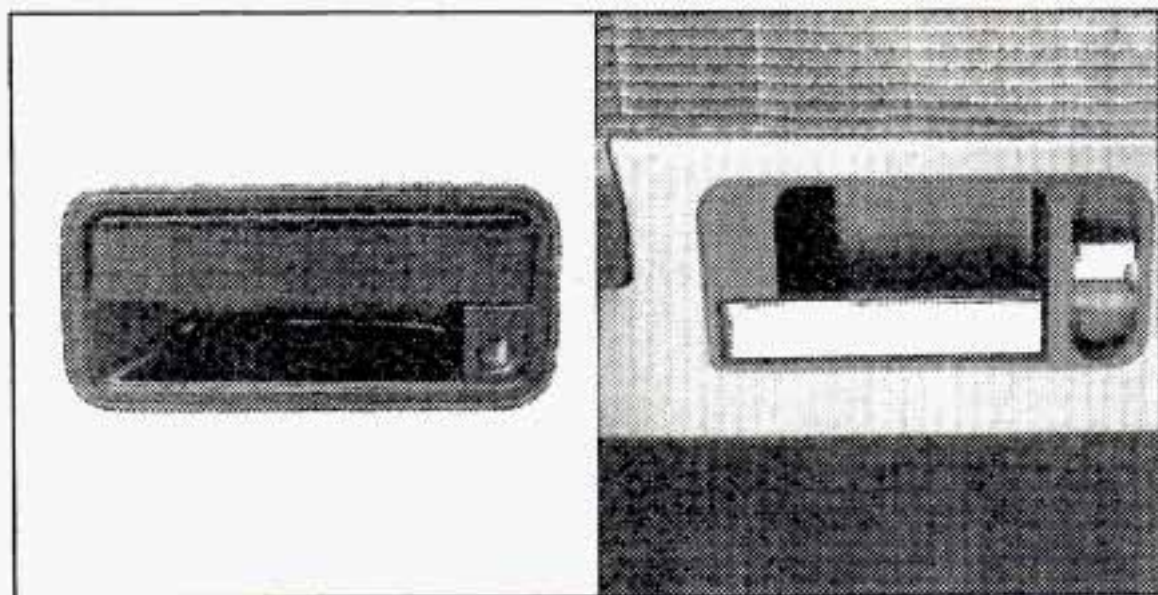

K2130

To open the door from the inside, pull the lever toward you and push the door open.

# Features & Controls

## Door Locks

### CAUTION



Unlocked doors can be dangerous.

Passengers—especially children—can easily open the doors and fall out. When a door is locked, the inside handle won't open it.

Outsiders can easily enter through an unlocked door when you slow down or stop your vehicle.

This may not be so obvious: You increase the chance of being thrown out of the vehicle in a crash if the doors aren't locked. Wear safety belts properly, lock your doors, and you will be far better off whenever you drive your vehicle.

There are several ways to lock and unlock your vehicle:

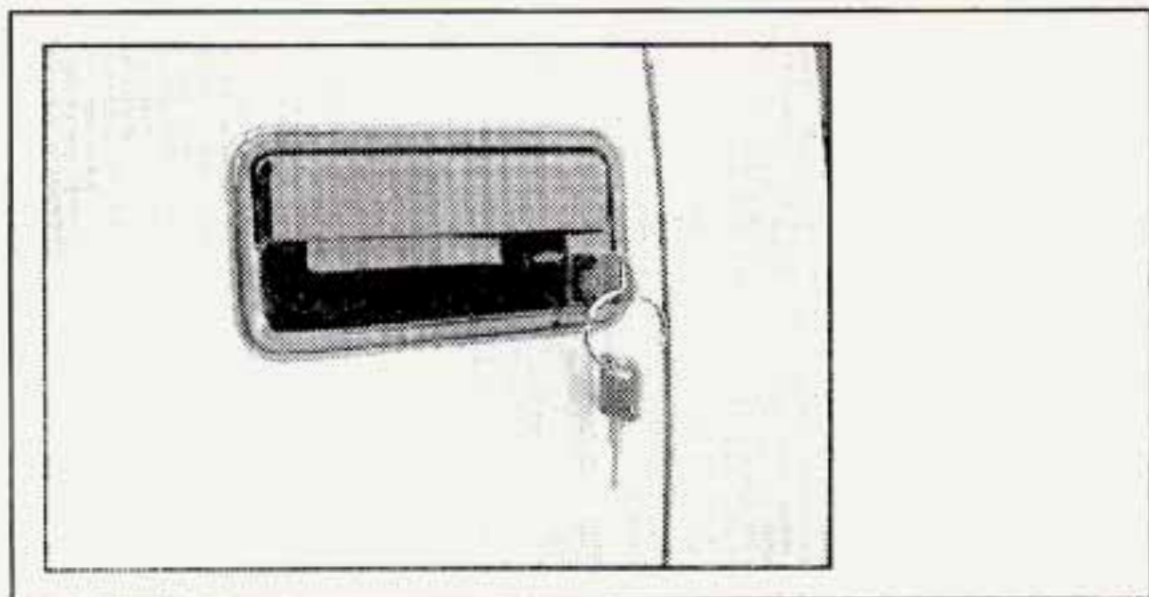

K2208

From the outside: use your door key.

From the inside: To lock the door, slide the lever on a side door down. To unlock the door, slide the lever on the door up. The rear panel doors do not have a lever.

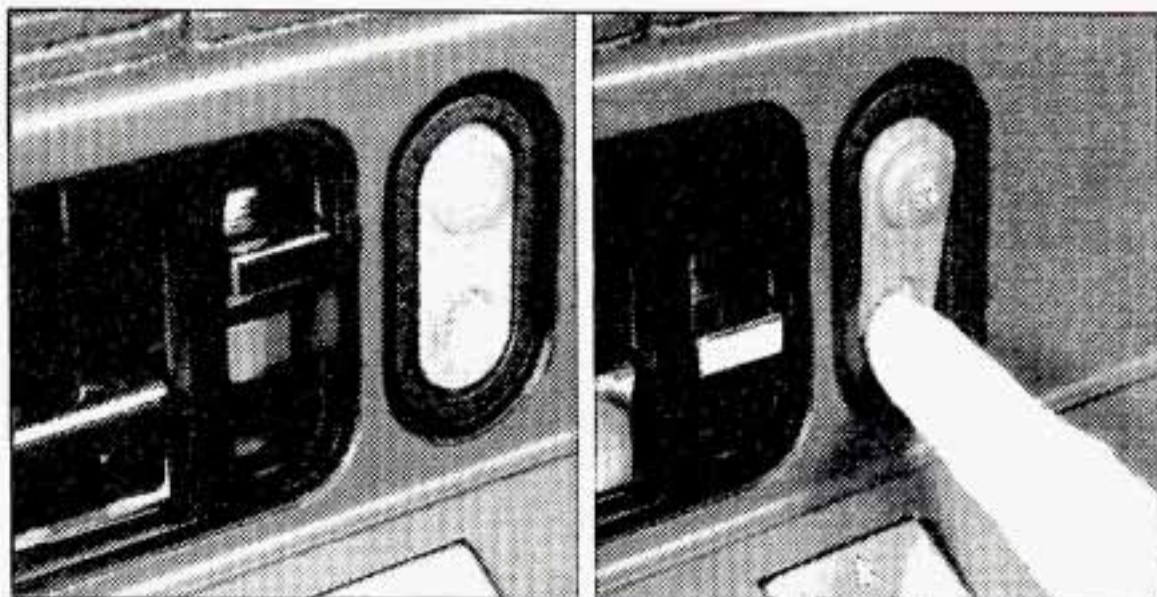

K2385

### ***Power Door Locks (Option)***

Press the bottom of the power door lock switch marked **LOCK**, on either front door, to lock all the doors at once. Press the switch marked **UNLOCK** to unlock all the doors at once.

### ***Leaving Your Vehicle***

If you are leaving the vehicle, take your keys, open your door and set the locks from the inside, then get out and close the door.

### ***Tailgate, Tailgate Glass and Rear Doors***

#### **CAUTION**



It can be dangerous to drive with the tailgate, tailgate glass or a rear door open. Carbon Monoxide (CO) gas can come into your vehicle. You can't see or smell CO. It can cause unconsciousness and even death.

If you must drive with the tailgate, tailgate glass or a rear door open:

- Make sure all windows are shut.
- Turn the fan on your heating or cooling system to its highest speed with the setting on **VENT**. That will force outside air into your vehicle. See "Comfort Controls" in the Index.
- If you have air vents on or under the instrument panel, open them all the way.

## **Features & Controls**

---

### **Tailgate**

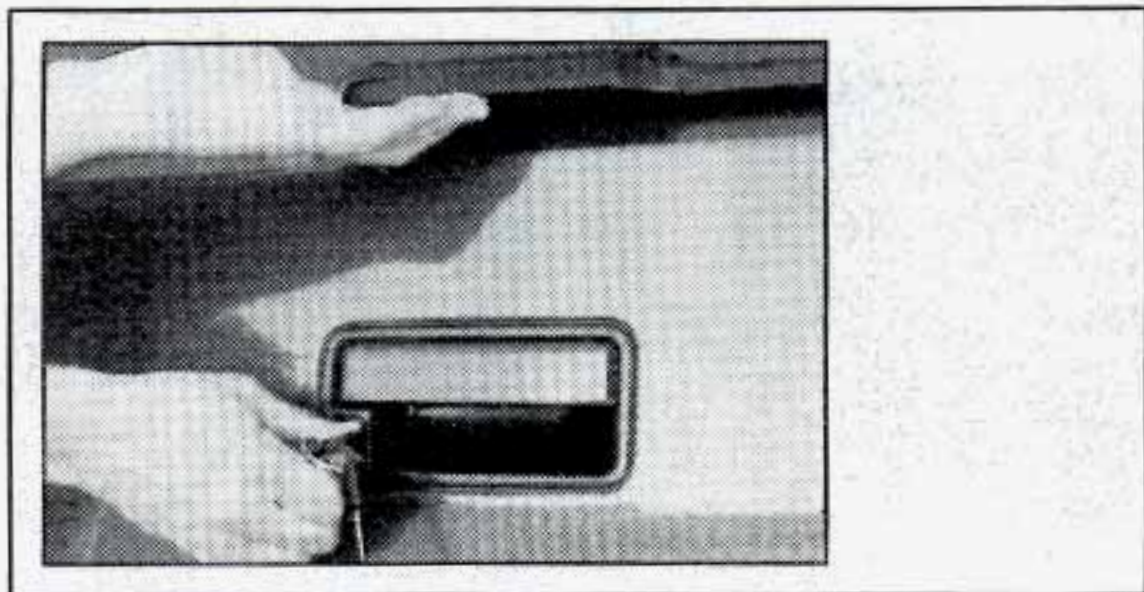

K2175

If your vehicle has a tailgate, you must raise the rear glass before lowering the tailgate. To open the glass from the outside, use your door key. With the key in the lock, turn the key to the right to release the glass, then lift it up.

Open the tailgate by lifting up on the handle while pulling the tailgate toward you.

Close the tailgate before closing the rear glass. After closing, make sure the tailgate is securely latched by pulling it toward you. After closing the rear glass, pull up on its handle to make sure it is locked.



### **Panel Doors**

To open the rear panel doors on the wagon model, you must open the right door first. Pull up on the handle and pull the door open.

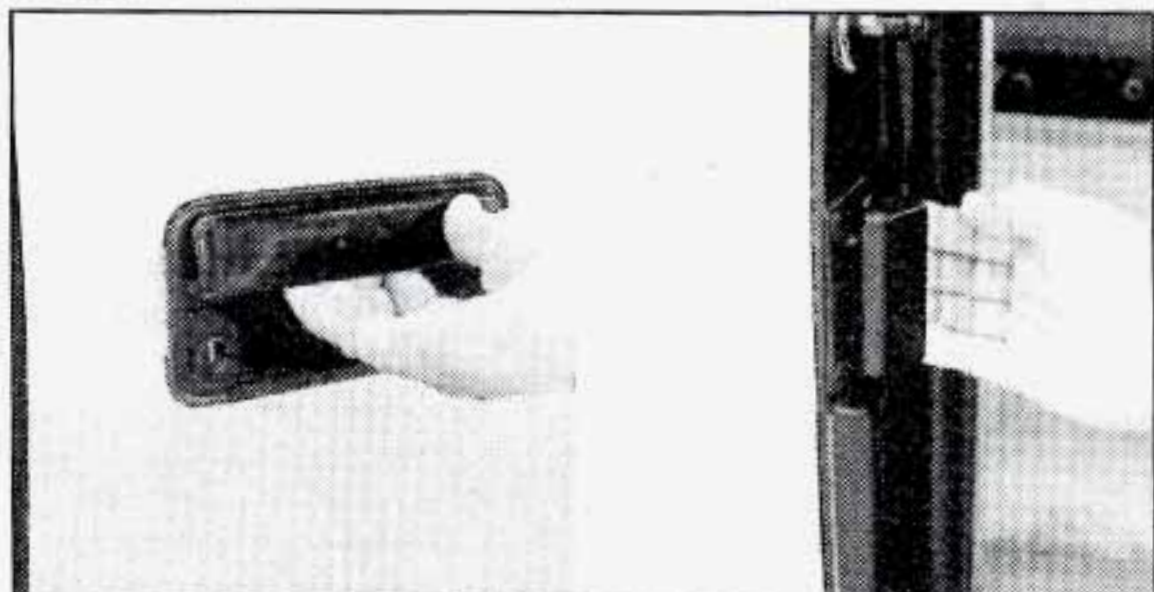

K2177

To open the left door, pull the handle on the door edge out and pull the door open.

To close the doors, close the left door first. Be sure both doors are latched securely.

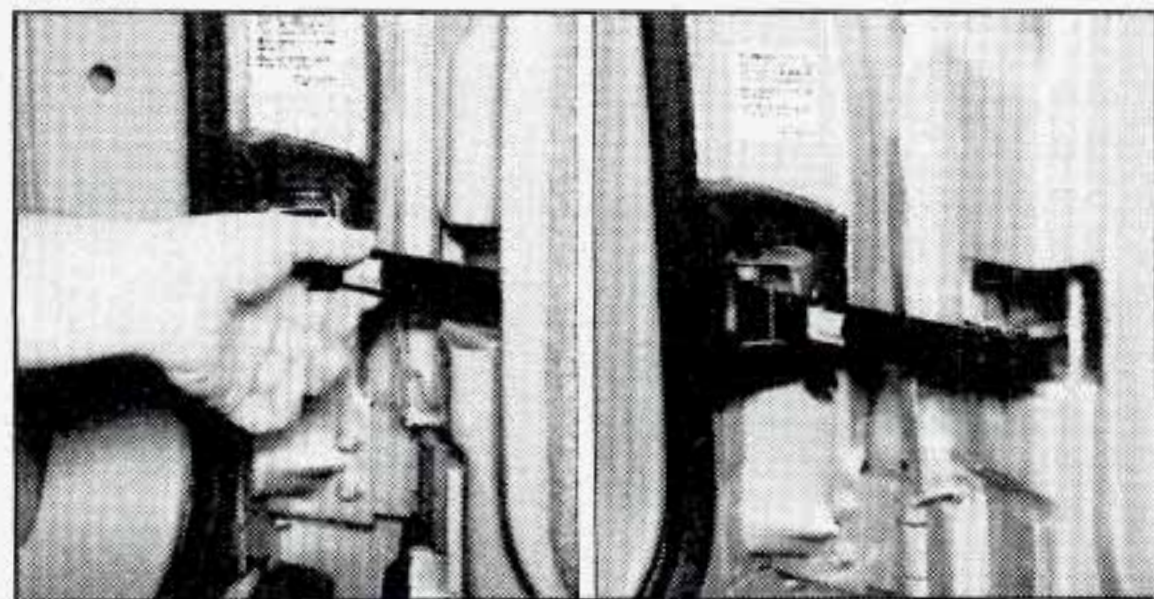

P028

The rear doors have a check assembly to keep them from opening farther than you want.

## **Features & Controls**

---

You can release the check strap if you need to open either door farther. First open the door part way, but do not let the end of the strap catch the pin on the door. Then hold the strap at the white mark and pull the strap away from the door pin. You can then swing the door open all the way.

To attach the check strap, just close the door and the strap will catch the pin.

### **Theft**

Vehicle theft is a big business, especially in some cities. Although your vehicle has a number of theft deterrent features, we know that nothing we put on it can make it impossible to steal. However, there are ways you can help.

**Key in the Ignition:** If you walk away from your vehicle with the keys inside, it's an easy target for joy riders or professional thieves—so don't do it. When you park your vehicle and open the driver's door, you'll hear a tone reminding you to remove your key from the ignition and take it with you. Always do this. Your steering wheel will be locked, and so will your ignition. If you have an automatic transmission, taking your key out also locks your transmission. And remember to lock the doors.

**Parking at Night:** Park in a lighted spot, close all windows and lock your vehicle. Remember to keep your valuables out of sight. Put them in a storage area, or take them with you.

**Parking Lots:** If you park in a lot where someone will be watching your vehicle, it's best to lock it up and take your keys. But what if you have to leave your ignition key? What if you have to leave something valuable in your vehicle?

- Put your valuables in a storage area, like your glove box or console, if you have one.
- Lock the console
- Lock all doors except the driver's
- Then take the key with you.

## New Vehicle "Break-In"

### NOTICE

Your modern vehicle doesn't need an elaborate "break-in." But it will perform better in the long run if you follow these guidelines:

- Keep your speed at 55 mph (88 km/h) or less for the first 500 miles (804 km).
- Don't drive at any one speed—fast or slow—for the first 500 miles (804 km). Don't make full-throttle starts.
- Avoid making hard stops for the first 200 miles (322 km) or so. During this time your new brake linings aren't yet broken in. Hard stops with new linings can mean premature wear and earlier replacement. Follow this "breaking-in" guideline every time you get new brake linings.

## Ignition Switch

Use your square key to start your vehicle. The square key lets you turn the ignition switch to five different positions:

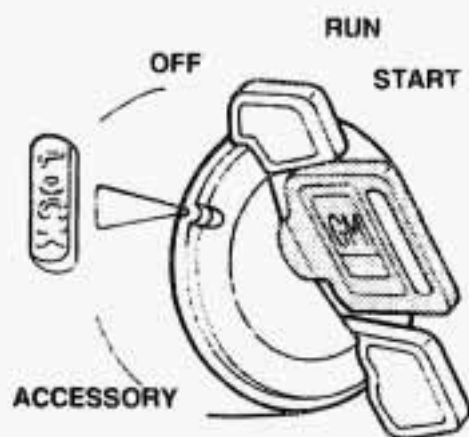
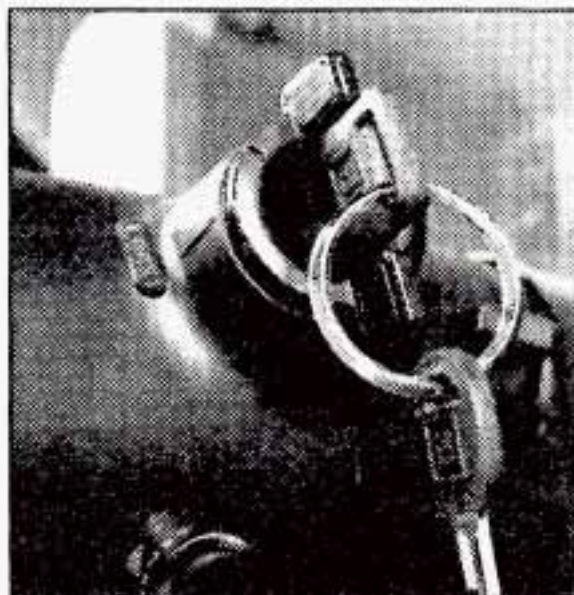

K0404

**Acc (Accessory):** **Acc** lets you use things like the radio and the windshield wipers when the engine is off. To get into **Acc**, push in the key and turn it toward you. Your steering wheel will remain locked, just as it was before you inserted the key.

## Features & Controls

---

**LOCK:** This position locks your ignition, steering wheel and transmission. It's a theft deterrent feature. You will only be able to remove your key when the ignition is turned to **LOCK**.

**Off:** This position lets you turn off the engine but still turn the steering wheel. Use **Off** if you must have your vehicle in motion while the engine is off (for example, if your vehicle is being pushed).

**Run:** This is the position for driving.

**Start:** This starts your engine.

### CAUTION



On manual transmission vehicles, turning the key to **LOCK** will lock the steering column and result in a loss of ability to steer the vehicle. This could cause a collision. If you need to turn the engine off while the vehicle is moving, turn the key only to **OFF**. Don't move the key release lever while the vehicle is moving.

### NOTICE

If your key seems stuck in **LOCK** and you can't turn it, be sure it is all the way in. If it is, then turn the steering wheel left and right while you turn the key hard. But turn the key only with your hand. Using a tool to force it could break the key or the ignition switch. If none of this works, then your vehicle needs service.

## Key Release Lever

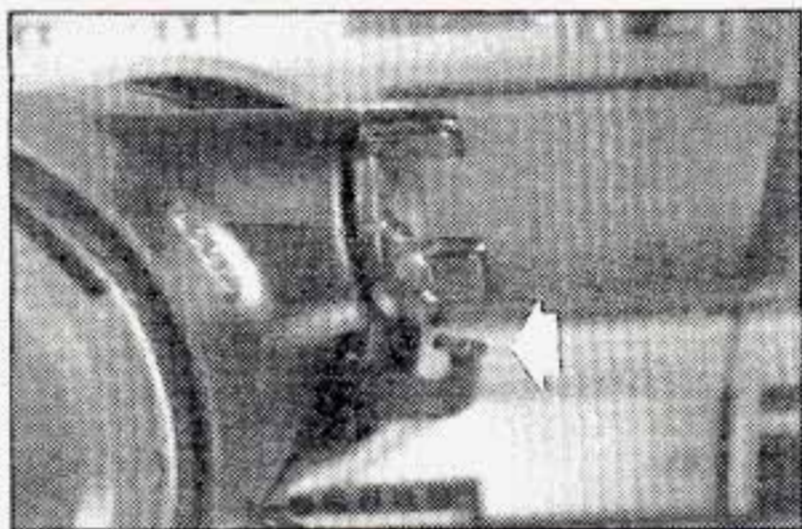

K0495

The ignition key cannot be removed from the ignition of manual transmission vehicles unless the key release lever is used.

### CAUTION



On manual transmission vehicles, if you need to turn the engine off while the vehicle is moving, do not press the key release lever, turn the key only to **Off**. Turning the key to **LOCK** will lock the steering column and result in loss of ability to steer the vehicle.

### *To Remove the Key*

On manual transmission vehicles, turn the key to the **LOCK** position while pressing the key release lever down. Keeping your finger on the lever, pull the key straight out.

On automatic transmission vehicles, turn the key to **LOCK** and pull it straight out.

# Features & Controls

---

## Starting Your Engine

Engines start differently. The 8th digit of your Vehicle Identification Number (VIN) shows the code letter or number for your engine. You will find the VIN at the top left of your instrument panel. (See "Vehicle Identification Number" in the Index.) Follow the proper steps to start the engine.

### To Start Your 5.7 Liter (Code K) engine or 7.4 Liter (Code N) engine:

#### 1. Automatic Transmission

Move your shift lever to **P** (Park) or **N** (Neutral). Your engine won't start in any other position—that's a safety feature. To restart when you're already moving, use **N** (Neutral) only.

### NOTICE

Don't try to shift to **P** (Park) if your vehicle is moving. If you do, you could damage the transmission. Shift to **P** (Park) only when your vehicle is stopped.

#### Manual Transmission

Shift your gear selector to neutral and hold the clutch pedal to the floor while starting the engine. Your vehicle won't start if the clutch pedal is not all the way down—that's a safety feature.

2. Don't push the accelerator pedal before starting your engine. In some other vehicles you might need to do this, but because of your vehicle's computer systems, you don't.
3. Turn your ignition key to **Start**. When the engine starts, let go of the key. The idle speed will go down as your engine gets warm.

**7.4L Engine Cold Start:** In cold weather, below 60°F (16°C), start the engine the same way but push the accelerator pedal one-quarter of the way down and hold it there for about 2 seconds after the engine starts.

### NOTICE

Holding your key in **Start** for longer than 15 seconds at a time will cause your battery to be drained much sooner. And the excessive heat can damage your starter motor.

4. If it doesn't start right away, hold your key in **Start**. If it doesn't start in three seconds, push the accelerator pedal about one-quarter of the way down for 12 more seconds, or until it starts.

- 
5. If your engine still won't start (or starts but then stops), it could be flooded with too much gasoline. Try this:

Wait 15 seconds to let the starter motor cool down. Then push your accelerator pedal all the way to the floor. Hold it there. Then, hold the key in **Start** for no more than ten seconds. This clears the extra gasoline from the engine. If the engine still doesn't start, wait another 15 seconds and do Step 5 again.

**Hot Engine Restart, 5.7L and 7.4L Engines (Vehicles Over 8500 GVWR):** If your engine is already hot and then stalls, turn your ignition key to **Off**. Then, turn your key to **Run**, and wait about 20 seconds before you restart your engine.

When the engine starts, let go of the key and accelerator pedal.

## **NOTICE**

Your engine is designed to work with the electronics in your vehicle. If you add electrical parts or accessories, you could change the way the fuel injection system operates. Before adding electrical equipment, check with your dealer. If you don't, your engine might not perform properly.

If you ever have to have your vehicle towed, see the part of this Manual that tells how to do it without damaging your vehicle. See "Towing Your Vehicle" in the Index.

### ***Driving Through Deep Standing Water***

## **NOTICE**

If you drive too quickly through deep puddles or standing water, water can come in through your engine's air intake and badly damage your engine. If you can't avoid deep puddles or standing water, drive through very slowly.

## Features & Controls

### Engine Block Heater (Option)

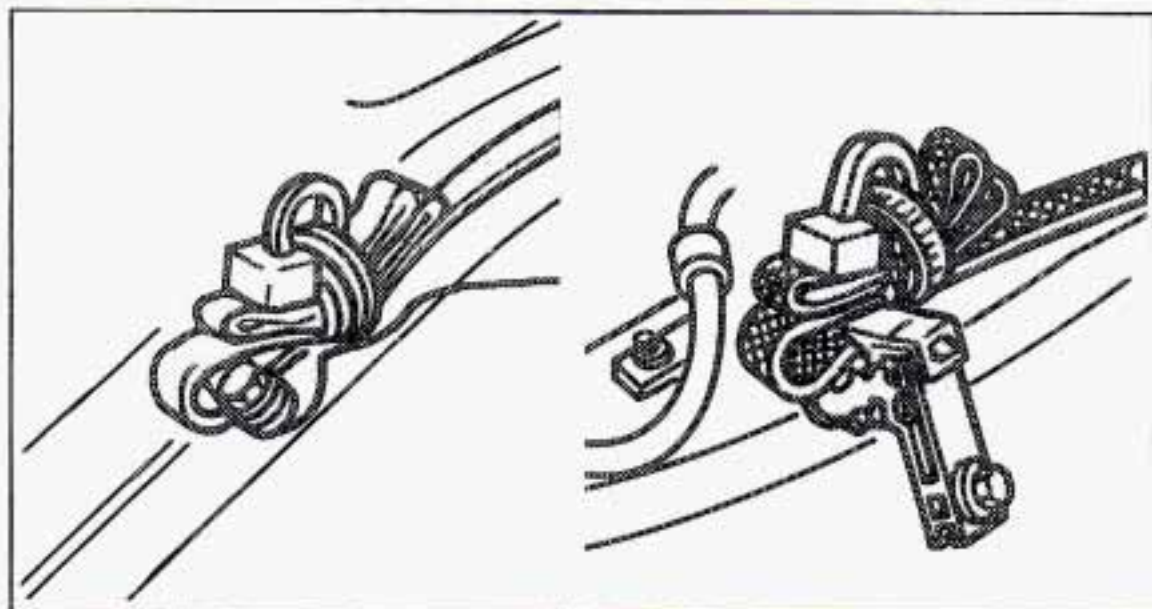

K2214

In very cold weather, 0°F (-18°C) or colder, the engine block heater can help. You'll get easier starting and better fuel economy during engine warm-up.

#### To use the block heater:

1. Turn off the engine.
2. Open the hood and unwrap the electrical cord.
3. Plug it into a normal, grounded 110-volt outlet.

#### CAUTION



Plugging the cord into an ungrounded outlet could cause an electrical shock. Also, the wrong kind of extension cord could overheat and cause a fire. You could be seriously injured. Plug the cord into a properly grounded three-prong 110-volt outlet. If the cord won't reach, use a heavy-duty three-prong extension cord rated for at least 15 amps.

#### NOTICE

After you've used the block heater, be sure to store the cord in the manner it was, to help keep it away from moving engine parts. If you don't, it could be torn and damaged.



---

How long should you keep the block heater plugged in? The answer depends on the weather, the kind of oil you have, and some other things. Instead of trying to list everything here, we ask that you contact a General Motors dealer in the area where you'll be parking your vehicle. The dealer can give you the best advice for that particular area.

## ***Automatic Transmission***

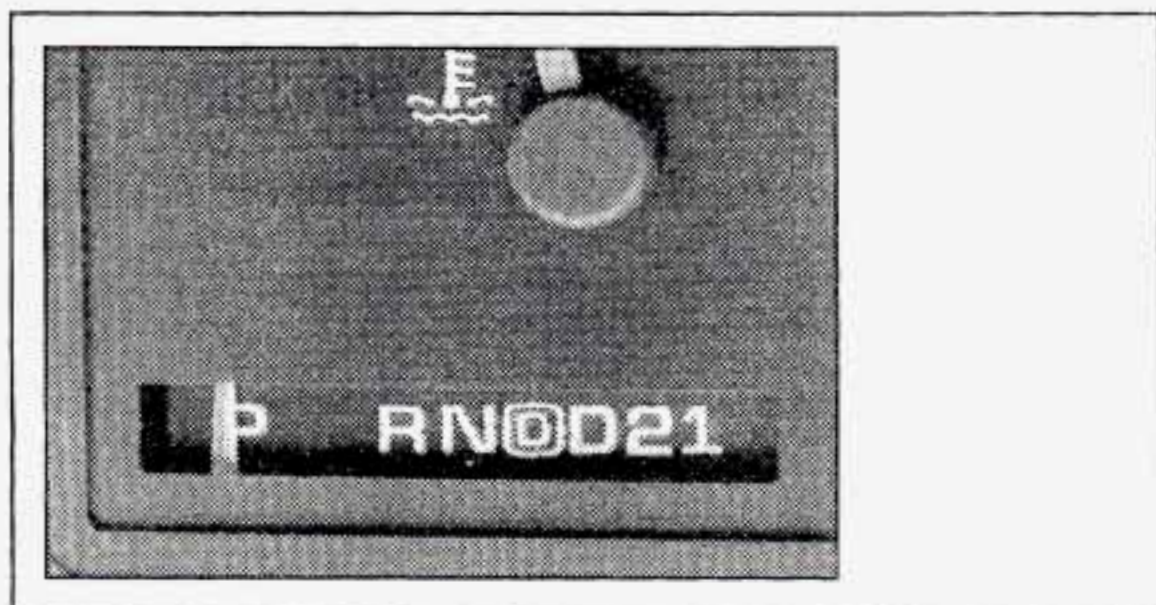

K2362

There are several different positions for your gear lever.

- **P** (Park)

This locks your rear wheels. It's the best position to use when you start your engine because your vehicle can't move easily.

## Features & Controls

### CAUTION



It is dangerous to get out of your vehicle if the shift lever is not fully in **P** (Park) with the parking brake firmly set. Your vehicle can roll.

Don't leave your vehicle when the engine is running unless you have to. If you have left the engine running, the vehicle can move suddenly. You or others could be injured. To be sure your vehicle won't move, when you're on fairly level ground, always set your parking brake and move the shift lever to **P** (Park).

If you have four-wheel drive, your vehicle will be free to roll—even if your shift lever is in **P** (Park)—if your transfer case is in **N** (Neutral). So, be sure the transfer case is in a drive gear—not **N** (Neutral).

See "Shifting Into Park" in the Index. If you are parking on a hill, or if you're pulling a trailer, also see "Parking on Hills" or "Towing a Trailer" in the Index.

- **R** (Reverse)

Use this gear to back up.

### NOTICE

Shifting to **R** (Reverse) while your vehicle is moving forward could damage your transmission. Shift to **R** (Reverse) only after your vehicle is stopped.

To rock your vehicle back and forth to get out of snow, ice or sand without damaging your transmission, see "If You're Stuck: In Sand, Mud, Ice or Snow" in the Index.

- **N** (Neutral)

In this setting, your engine doesn't connect with the wheels. To restart when you're already moving, use **N** (Neutral) only. Also, use **N** when your vehicle is being towed.

### CAUTION



Shifting out of **P** (Park) or **N** (Neutral) while your engine is "racing" (running at high speed) is dangerous. Unless your foot is firmly on the brake pedal, your vehicle could move very rapidly. You could lose control and hit people or objects. Don't shift out of **P** (Park) or **N** (Neutral) while your engine is racing.

## NOTICE

Damage to your transmission caused by shifting out of **P** (Park) or **N** (Neutral) with the engine racing isn't covered by your warranty.

- **OD** (Automatic Overdrive)

This position is for normal driving. If you need more power for passing, and you're:

- Going less than about 35 mph (56 km/h), push your accelerator pedal about halfway down
- Going about 35 mph (56 km/h) or more, push the accelerator all the way down

You'll shift down to the next gear and have more power.

**OD** should **not** be used when towing a trailer, carrying a heavy load, driving on steep hills, or for off-road driving. Select **D** (third gear) when operating the vehicle under any of these conditions.

- **D** (Third Gear)

This is like **OD**, but you never go into Overdrive. You should use **D** when towing a trailer, carrying a heavy load, driving on steep hills, or for off-road driving.

- **2** (Second Gear)

This position gives you more power but lower fuel economy. You can use **2** on hills. It can help control your speed as you go down steep mountain roads, but then you would also want to use your brakes off and on.

If you manually select **2**, the transmission will drive in second gear. You may use this feature for reducing torque to the rear wheels when you are trying to start your vehicle from a stop on slippery road surfaces.

- **1** (First Gear)

This position gives you even more power (but lower fuel economy) than **2**. You can use it on very steep hills, or in deep snow or mud. If the selector lever is put in **1**, the transmission won't shift into first gear until the vehicle is going slowly enough.

## **Features & Controls**

---

### **NOTICE**

If your rear wheels can't rotate, don't try to drive. This might happen if you were stuck in very deep sand or mud or were up against a solid object. You could damage your transmission.

Also, if you stop when going uphill, don't hold your vehicle there with only the accelerator pedal. This could overheat and damage the transmission. Use your brakes or shift to **P** (Park) to hold your vehicle in position on a hill.

### **Five-Speed Manual Transmission**



K2220

---

This is your shift pattern. Here's how to operate your transmission:

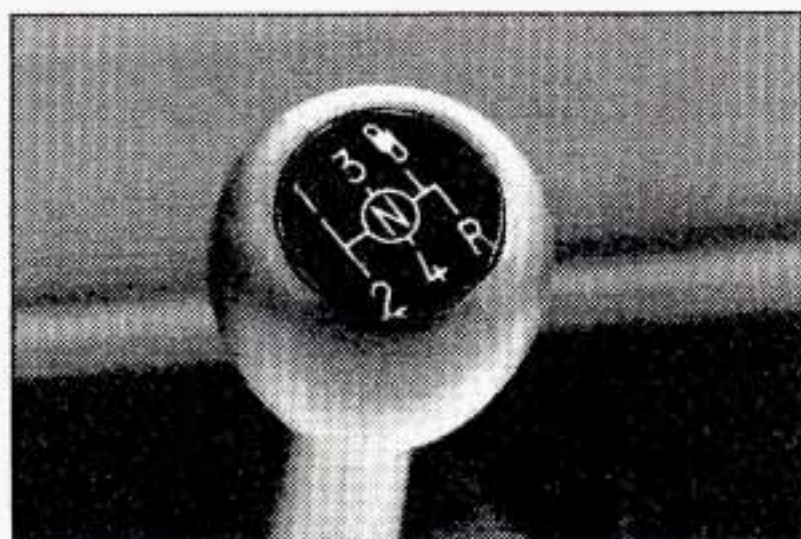

K2386

- **1 (First Gear)**—Press the clutch pedal and shift into **1**. Then, slowly let up on the clutch pedal as you press the accelerator pedal.

You can shift into **1** when you're going less than 20 mph (32 km/h). If you've come to a complete stop and it's hard to shift into **1**, put the shift lever in Neutral and let up on the clutch. Press the clutch pedal back down. Then shift into **1**.

- **2 (Second Gear)**—Press the clutch pedal as you let up on the accelerator pedal and shift into **2**. Then, slowly let up on the clutch pedal as you press the accelerator pedal.
- **3, 4 and 5 (Third, Fourth and Fifth Gears)**—Shift into **3, 4 and 5** the same way you do for **2**. Slowly let up on the clutch pedal as you press the accelerator pedal.

**To Stop** —Let up on the accelerator pedal and press the brake pedal. Just before the vehicle stops, press the clutch pedal and the brake pedal, and shift to Neutral.

**N (Neutral)**—Use this position when you start or idle your engine.

**R (Reverse)**—To back up, press the clutch pedal and shift into **R**. Let up on the clutch pedal slowly while pressing the accelerator pedal.

## Features & Controls

### NOTICE

Shift to **R** (Reverse) only after your vehicle is stopped. Shifting to **R** (Reverse) while your vehicle is moving could damage your transmission. Also, use Reverse, along with the parking brake, for parking your vehicle.

### Shift Light



K2317

If you have a manual transmission, you have a **SHIFT** light. This light will show you when to shift to the next higher gear for best fuel economy.

When this light comes on, you can shift to the next higher gear if weather, road and traffic conditions let you. For the best fuel economy, accelerate slowly and shift when the light comes on.

While you accelerate, it is normal for the light to go on and off if you quickly change the position of the accelerator. Ignore the **SHIFT** light when you downshift.

**Four-Wheel Drive Vehicles Only:** If your vehicle has four-wheel drive and is equipped with a manual transmission, disregard the shift light when the transfer case is in 4 LOW.

### Locking Rear Axle

If you have this feature, your rear axle can give you additional traction on snow, mud ice, sand or gravel. It works like a standard axle most of the time, but when one of the rear wheels has no traction and the other one does, the locking feature will allow the wheel with traction to move the vehicle.

---

---

## Parking Brake

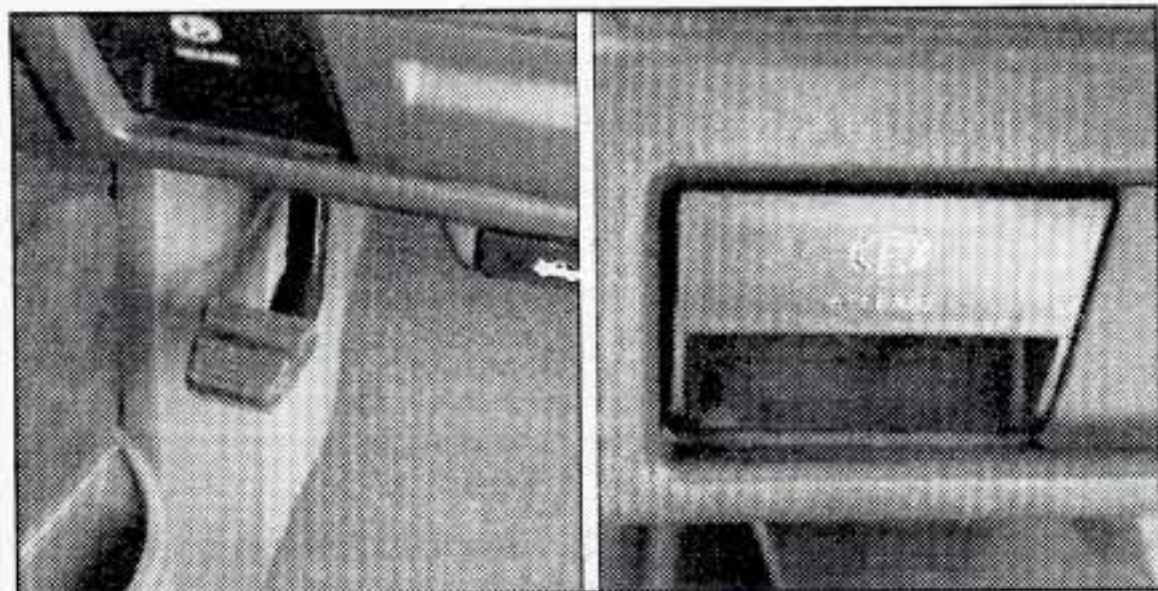

K2221

### To set the parking brake:

Hold the regular brake pedal down with your right foot. Push down the parking brake pedal with your left foot. If the ignition is on, the brake system warning light will come on.

### To release the parking brake:

Hold the regular brake pedal down. Pull the lever marked **RELEASE**.

## NOTICE

Driving with the parking brake on can cause your rear brakes to overheat. You may have to replace them, and you could also damage other parts of your vehicle.

### If you are on a hill:

See "Parking on Hills" in the Index. That part shows how to turn your front wheels.

### If you are towing a trailer and are parking on any hill:

See "Towing a Trailer" in the Index. That part shows what to do first to keep the trailer from moving.

## Features & Controls

---

### **Torque Lock**

The parking brake should be set first whenever leaving the driver's seat. If you are parked on a hill and the transmission is placed in **P** (Park) before the parking brake is set, the weight of the vehicle may put too much force on the parking pawl in the transmission. It may be difficult to pull the selector lever out of **P** (Park). This is called "torque lock." To prevent this, the parking brake should be set **BEFORE** moving the selector lever to **P** (Park).

When preparing to move the vehicle, the selector lever should be moved out of **P** (Park) **BEFORE** releasing the parking brake. Set the parking brake first, then release the transmission from **P** (Park), even on level surfaces.

If "torque lock" does occur, you may have to have another vehicle nudge your vehicle uphill a little to take some of the pressure off the transmission while you pull the selector lever out of **P** (Park).

### **Shifting Into P (Park) (Automatic Transmission Models Only)**

#### **CAUTION**



It can be dangerous to get out of your vehicle if the shift lever is not fully in **P** (Park) with the parking brake firmly set. Your vehicle can roll.

If you have left the engine running, the vehicle can move suddenly. You or others could be injured. To be sure your vehicle won't move, when you're on fairly level ground, use the steps that follow.

If you have four-wheel drive, and your transfer case is in **N** (Neutral), your vehicle will be free to roll—even if your shift lever is in **P** (Park). So, be sure the transfer case is in a drive gear—not in **N** (Neutral).

If you are parking on a hill, or if you're pulling a trailer, also see "Parking on Hills" or "Towing a Trailer" in the Index.



---

### ***Steering Column Shift Lever***

1. Hold the brake pedal down with your right foot and set the parking brake.
2. Move the shift lever into the **P** (Park) position like this:
  - Pull the lever toward you.

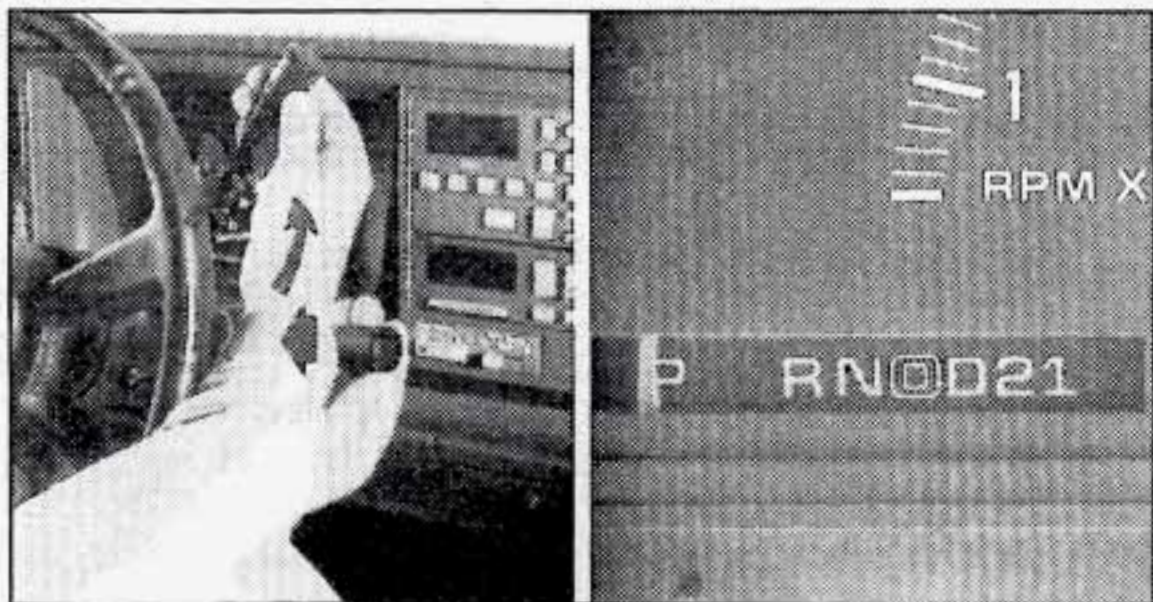

K2316

- Move the lever up as far as it will go.
3. If you have four-wheel drive, be sure the transfer case is in a drive gear—not in **N** (Neutral).
  4. Move the ignition key to **LOCK**.
  5. Remove the key and take it with you. If you can walk away from your vehicle with the ignition key in your hand, your vehicle is in **P** (Park).

## Features & Controls

---

### *Leaving Your Vehicle With the Engine Running (Automatic Transmission Models Only)*

#### **CAUTION**



It can be dangerous to leave your vehicle with the engine running. Your vehicle could move suddenly if the shift lever is not fully in **P** (Park) with the parking brake firmly set.

If you have four-wheel drive with a manual transfer case shift lever and your transfer case is in **N** (Neutral), your vehicle will be free to roll, even if your shift lever is in **P** (Park). So be sure the transfer case is in a drive gear—not in **N** (Neutral).

And, if you leave the vehicle with the engine running, it could overheat and even catch fire. You or others could be injured. Don't leave your vehicle with the engine running unless you have to.

If you have to leave your vehicle with the engine running, be sure your vehicle is in **P** (Park) and your parking brake is firmly set, before you leave it.

If you have four-wheel drive with a manual transfer case shift lever, be sure that the transfer case is in a drive gear—not in **N** (Neutral).

After you've moved the shift lever into the **P** (Park) position, hold the regular brake pedal down. Then, see if you can move the shift lever away from **P** (Park) without first pulling it toward you.

If you can, it means that the shift lever wasn't fully locked into **P** (Park).

#### ***Parking Your Vehicle (Manual Transmission Models Only)***

Before you get out of your vehicle, put your manual transmission in **R** (Reverse) and firmly apply the parking brake.

If you have four-wheel drive, be sure your transfer case is in a drive gear. Your vehicle could roll if it isn't.

If you are parking on a hill, or if your vehicle is equipped to tow a trailer, see "Towing a Trailer" or "Parking on Hills" in the Index.

## ***Parking Over Things That Burn***

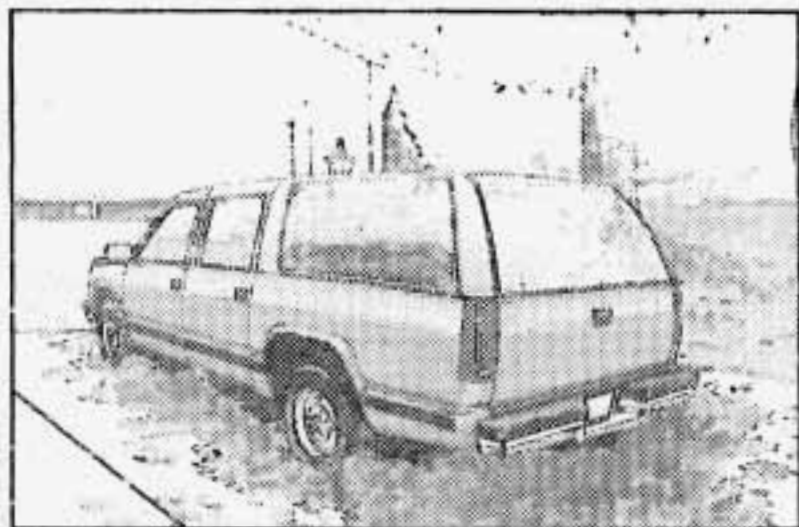

AM220009

### **CAUTION**



Things that can burn could touch hot exhaust parts under your vehicle and ignite. Don't park over papers, leaves, dry grass or other things that can burn.

## Features & Controls

---

### Engine Exhaust

#### CAUTION



Engine exhaust can kill. It contains the gas carbon monoxide (CO), which you can't see or smell. It can cause unconsciousness and death.

You might have exhaust coming in if:

- Your exhaust system sounds strange or different.
- Your vehicle gets rusty underneath.
- Your vehicle was damaged in a collision.
- Your vehicle was damaged when driving over high points on the road or over road debris.
- Repairs weren't done correctly.
- Your vehicle or exhaust system had been modified improperly.

If you **ever** suspect exhaust is coming into your vehicle:

- Drive it only with all the windows down to blow out any CO; and
- Have it fixed **immediately**.

---

---

## **Running Your Engine While You're Parked (Automatic Transmission)**

It's better not to park with the engine running. But if you ever have to, here are some things to know.

### **CAUTION**



Idling the engine with the air system control off could allow dangerous exhaust into your vehicle. (See the earlier Caution under "Engine Exhaust".)

Also, idling in a closed-in place can let deadly carbon monoxide (CO) into your vehicle even if the fan switch is at the highest setting. One place this can happen is a garage. Exhaust—with CO—can come in easily. **NEVER** park in a garage with the engine running.

Another closed-in place can be a blizzard. (See "Blizzard" in the Index.)

### **CAUTION**



It can be dangerous to get out of your vehicle if the shift lever is not fully in **P** with the parking brake firmly set. Your vehicle can roll. Don't leave your vehicle when the engine is running unless you have to. If you've left the engine running, the vehicle can move suddenly. You or others could be injured. To be sure your vehicle won't move, even when you're on fairly level ground, always set your parking brake and move the shift lever to **P** (Park).

If you have four-wheel drive, and you're transfer case is in **N** (Neutral), your vehicle will be free to roll, even if your shift lever is in **P** (Park). So, be sure the transfer case is in a drive gear—not in **N** (Neutral). Follow the proper steps to be sure your vehicle won't move. See "Shifting Into Park" in the Index.

If you are parking on a hill, or if you're pulling a trailer, also see "Parking on Hills" or "Trailer Towing" in the Index.

# Features & Controls

## Four Wheel Drive

### CAUTION



It can be dangerous to get out of your vehicle if the shift lever is not fully in **P** (Park) with the parking brake firmly set. If you have four-wheel drive, also be sure the transfer case is in a drive gear. Your vehicle can roll. If you have left the engine running, the vehicle can move suddenly. You or others could be injured. To be sure your vehicle won't move, follow the steps below. If you are parking on a hill, or if you're pulling a trailer, see "Parking on Hills" or "Trailer Towing" in the Index.

If your vehicle has four-wheel drive, you can send your engine's driving power to all four wheels for extra traction. To get the most satisfaction out of four-wheel drive, you must be familiar with its operation. Read the part that follows before using four-wheel drive. You should use **2H** for most normal driving conditions.

### NOTICE

Driving in the **4H** or **4L** positions for a long time on dry or wet pavement could shorten the life of your vehicle's drivetrain.

## Transfer Case

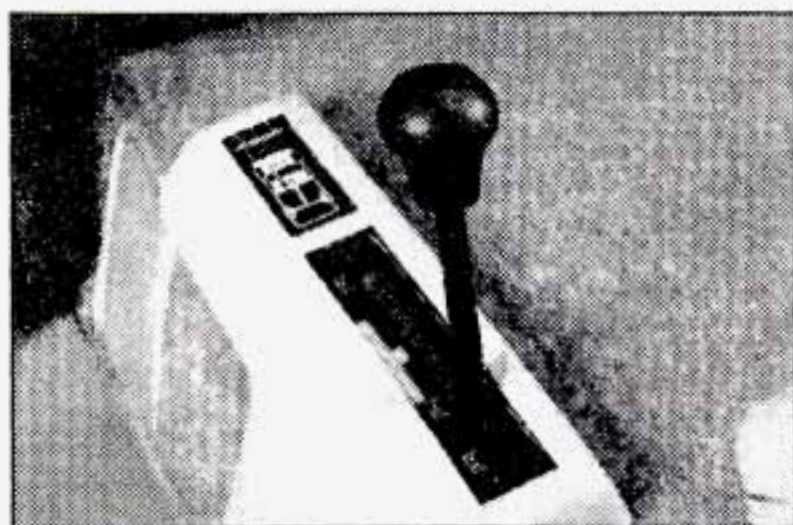

P0276

---

The transfer case shift lever is on the floor to the right of the driver. Use this lever to shift into and out of four-wheel drive. An indicator near the lever shows you the transfer case settings:

- 4L
- N
- 2H
- 4H

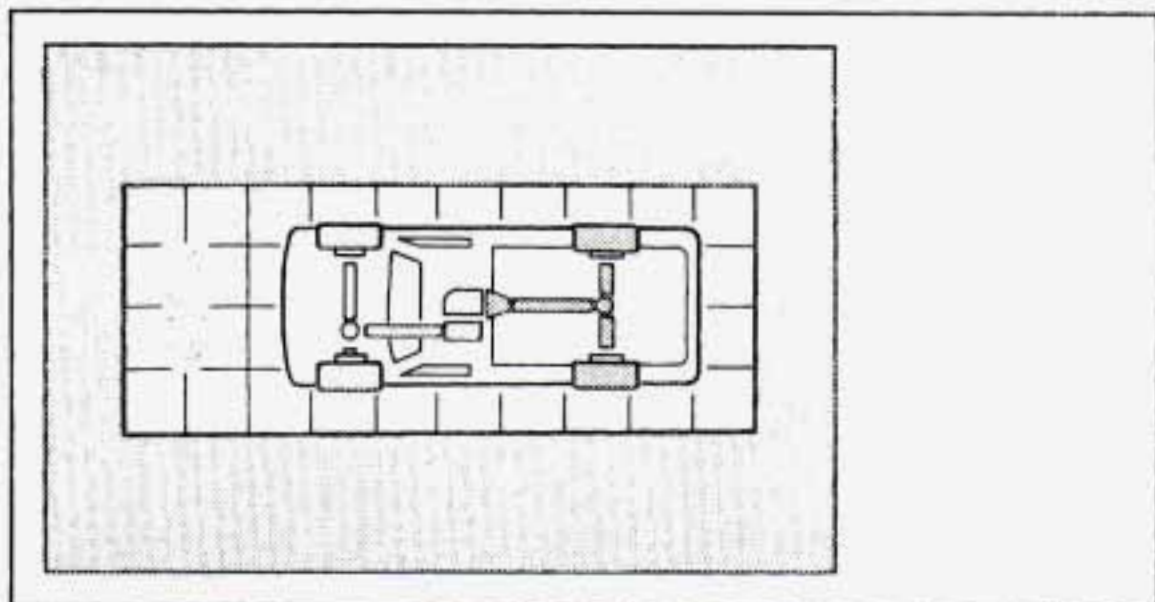

K2224

The front axle portion of the indicator diagram will light up when you shift into four-wheel drive. A slight delay between shifting and the indicator's lighting is normal. If the indicator does not light up, or if the front axle light does not go out after you shift out of four-wheel drive, have your dealer check your system.

When your headlights or parking lights are on, rotate the dial to the right of your headlight switch to adjust the brightness of your transfer case indicator light. Rotate the dial up to brighten, or down to dim, the indicator light.

### ***Transfer Case Shift Positions***

**2H (High):** This setting is for driving in most street and highway situations. Your front axle is not engaged in two-wheel drive.

**4H (High):** This setting engages your front axle to help drive your vehicle. Use **4H** when you need extra traction, such as on wet or icy roads, or in most off-road situations.

## ***Features & Controls***

---

**N (Neutral):** Shift to this setting only when your vehicle needs to be towed or when using a power take off.

**4L (Low):** This setting also engages your front axle to give you extra traction, but should be used only for off-road or on extremely slippery surfaces.

You can shift from **2H** to **4H** or from **4H** to **2H** while the vehicle is moving. Your front axle will engage faster if you take your foot off of the accelerator for a few seconds after you shift. In extremely cold weather it may be necessary to stop or slow the vehicle to shift out of **2H**.

To shift into or out of **4L** or **N (Neutral)**:

1. Slow the vehicle to a roll, about 3 mph (5 km/h) and shift your transmission into neutral.
2. Shift the transfer case shift lever in one continuous motion.

Don't pause in **N (Neutral)** as you shift the transfer case into **4L**, or your gears could clash.

Remember that driving in **4H** or **4L** may reduce fuel economy. Also, driving in four-wheel drive on dry pavement could cause your tires to wear faster and make your transfer case harder to shift.

### ***Front Axle Locking Feature***

The front axle locks and unlocks automatically when you shift the transfer case. A slight delay for the axle to lock or unlock is normal. If the outside temperature is very hot, or the vehicle has been used under hard driving conditions, there may be a slight delay for the axle to unlock.



---

## Windows

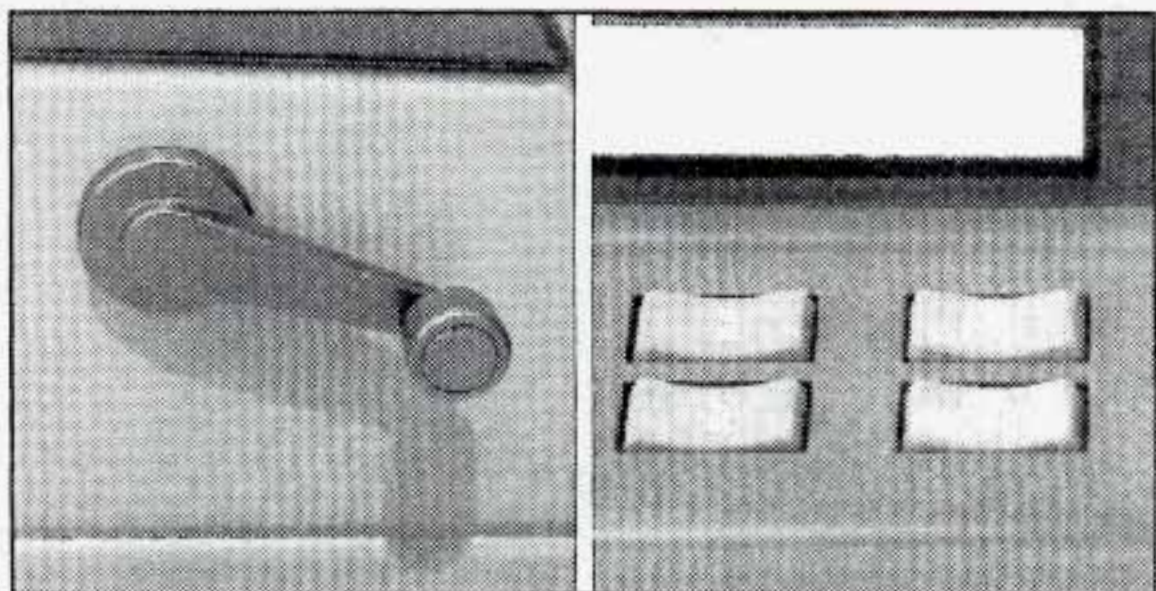

K2364

To open your manual windows, turn the hand crank on each door to raise or lower your side door windows.

If you have the optional power windows, the controls are on each of the side doors.

The driver's door has a switch for the passenger windows as well. Your power windows will work when the ignition has been turned to **ACC** or **Run**.

Push the rear of the switch with the power window symbol on it to lower the window.

Push the front of the switch with the power window symbol on it to raise the window.

## Features & Controls

---

### Electric Tailgate Glass Release

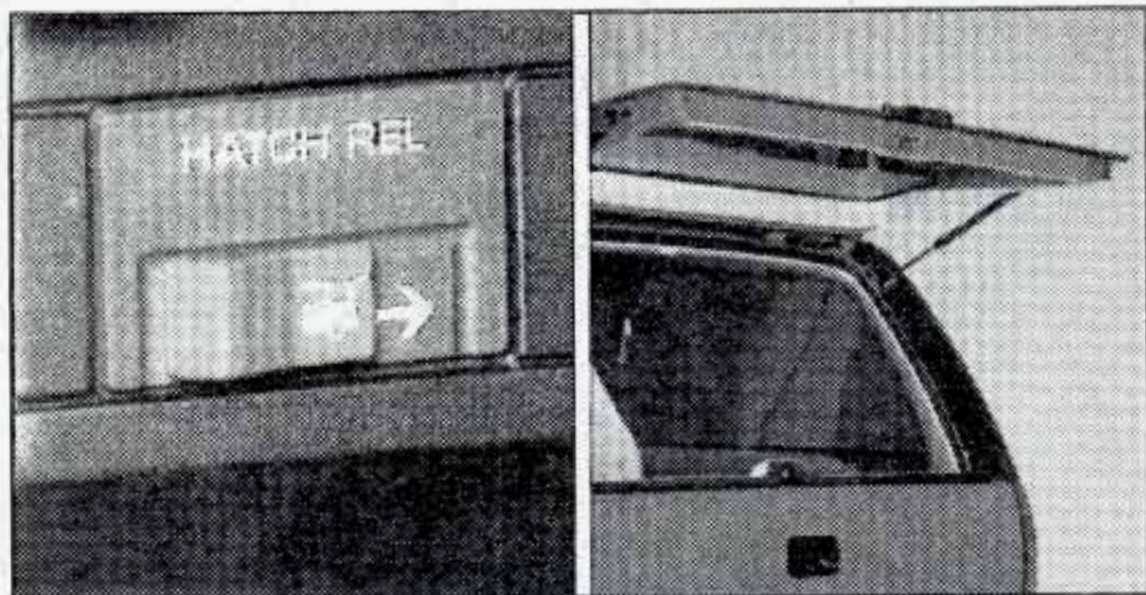

P0271

Before operating your electric tailgate glass release, see the caution under "Tailgate, Tailgate Glass and Rear Doors" in this section.

The electric hatch release button, located below the headlight switch, lets you release the tailgate glass. To use it, slide the button to the right until you hear the latch release the window.

If you have an automatic transmission, your shift lever must be in **P** (Park) or **N** (Neutral) for the release to work. With a manual transmission, you must apply the parking brake for the release to work.

---

---

## **Horn**

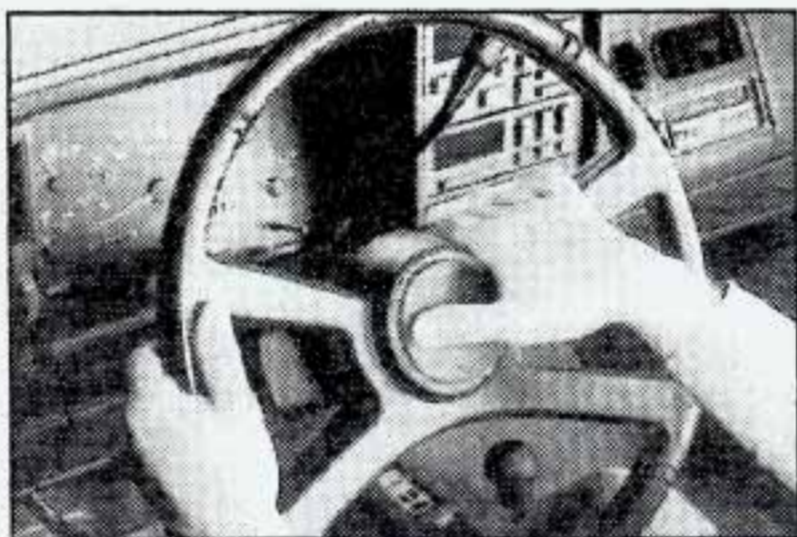

K2319

To sound the horn, press the pad with the horn symbol on it. The pad is located in the center of the steering wheel.

## **Tilt Wheel (Option)**

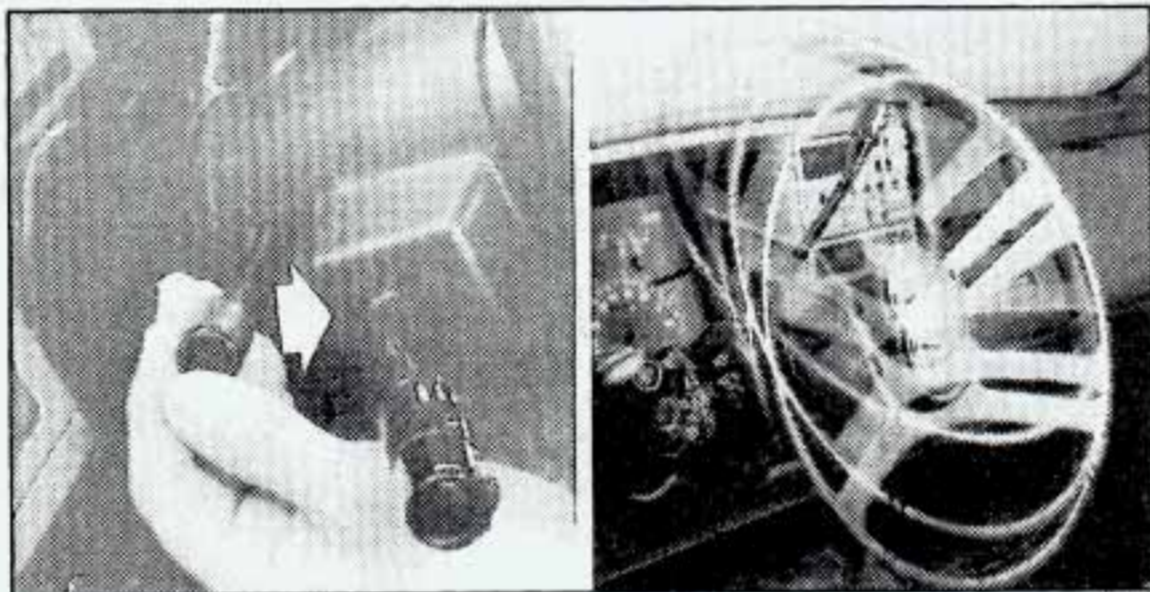

K2185

A tilt steering wheel allows you to adjust the steering wheel before you drive. You can also raise it to the highest level to give your legs more room when you exit and enter the vehicle.

## **Features & Controls**

---

To tilt the wheel, hold the steering wheel and pull the lever. Move the steering wheel to a comfortable level, then release the lever to lock the wheel in place.

### **Multifunction Lever**

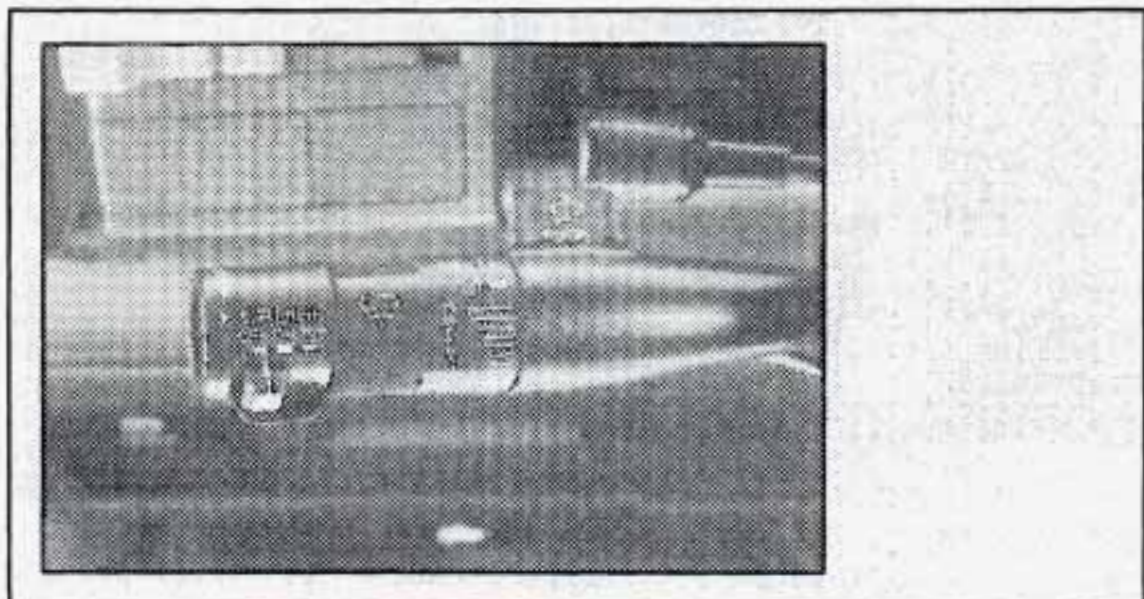

K2239

The lever on the left side of the steering column includes your:

- Turn Signal and Lane Change Indicator
- Headlight High-Low Beam & Passing Signal
- Windshield Wipers
- Windshield Washer
- Cruise Control (Option)

## ***Turn Signal and Lane Change Indicator***

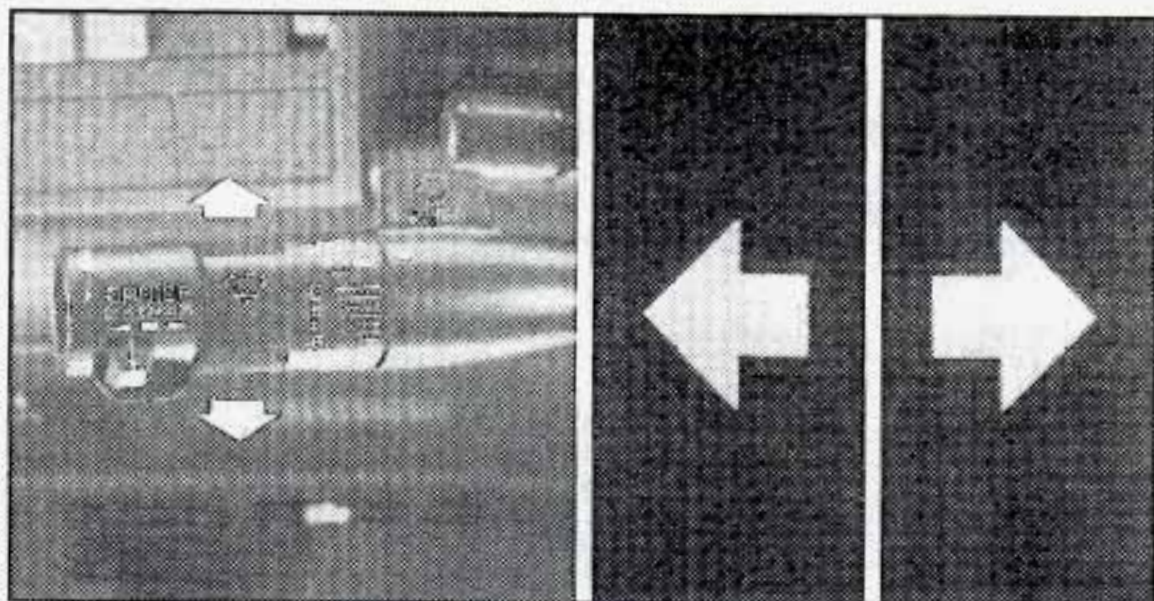

The turn signal has two upward (for Right) and two downward (for Left) positions. These positions allow you to signal a turn or a lane change.

To signal a turn, move the lever all the way up or down. When the turn is finished, the lever will return automatically.

A green arrow on the instrument panel will flash in the direction of the turn or lane change.

To signal a lane change, just raise or lower the lever until the green arrow starts to flash. Hold it there until you complete your lane change. The lever will return by itself when you release it.

As you signal a turn or a lane change, if the arrows flash twice as fast as normal, a signal bulb may be burned out and other drivers won't see your turn signal.

If a bulb is burned out, replace it to help avoid an accident. If the green arrows don't go on at all when you signal a turn, check the fuse (see "Fuses" in the Index) and for burned-out bulbs.

### ***Operation of Lights***

Although your vehicle's lighting system (headlights, parking lights, fog lamps, side marker lights and taillights) meet all applicable federal lighting requirements, certain states and provinces may apply their own lighting regulations that may require special attention before you operate these lights. For example, some jurisdictions may require that you operate your lower

## **Features & Controls**

---

beam lights with fog lamps at all times, or that headlights be turned on whenever you must use your windshield wipers. In addition, most jurisdictions prohibit driving solely with parking lights, especially at dawn or dusk. It is recommended that you check with your own state or provincial highway authority for applicable lighting regulations.

### **Headlight High-Low Beam**

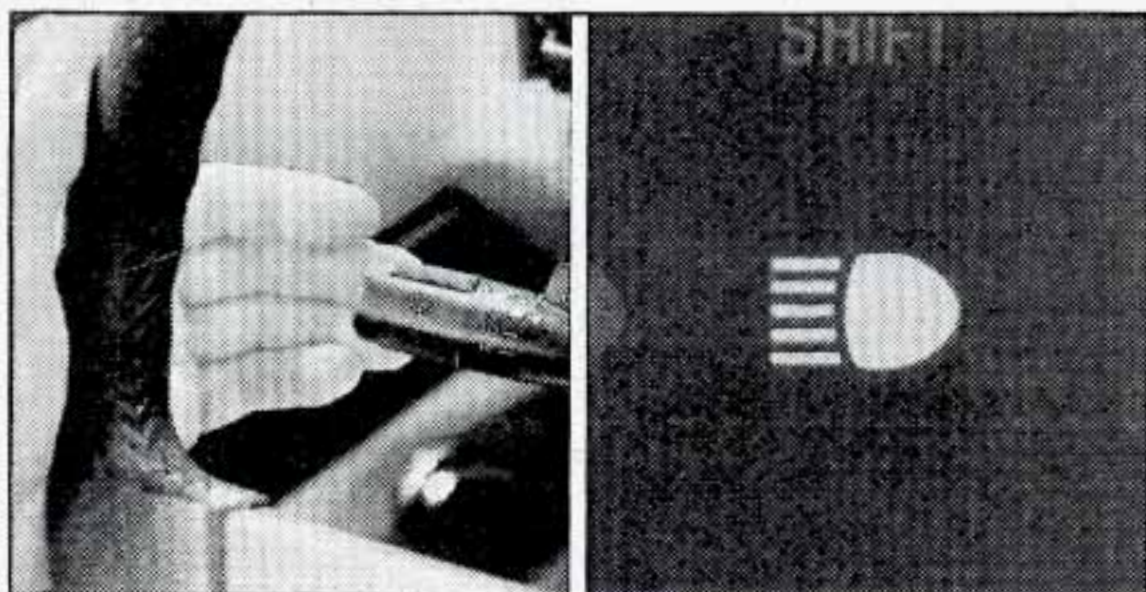

K2242

To change the headlights from low beam to high or high to low, pull the turn signal lever all the way toward you. Then release it. When the high beams are on, this blue light on the instrument panel also will be on.

## Windshield Wipers

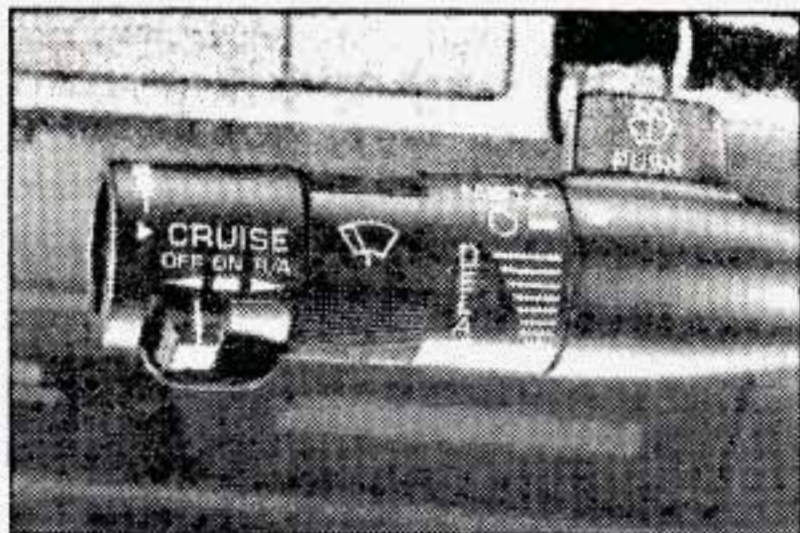

K2244

You control the windshield wipers by turning the band with the wiper symbol on it.

For a single wiping cycle, turn the band to **MIST**. Hold it there until the wipers start, then let go. The wipers will stop after one cycle. If you want more cycles, hold the band on **MIST** longer.

You can set the wiper speed for a long or short delay between wipes. This can be very useful in light rain or snow. Turn the band to choose the delay time. The closer to **LO**, the shorter the delay.

For steady wiping at low speed, turn the band away from you to the **LO** position. For high speed wiping, turn the band further, to **HI**. To stop the wipers, move the band to the off symbol.

### CAUTION



Damaged wiper blades may prevent you from seeing well enough to drive safely. To avoid damage, be sure to clear ice and snow from the wiper blades before using them. If they're frozen to the windshield, carefully loosen or thaw them. If your blades do become damaged get new blades or blade inserts.

Heavy snow or ice can overload your wipers. A circuit breaker will stop them until the motor cools. Clear away snow or ice to prevent an overload.

## Features & Controls

### Windshield Washer

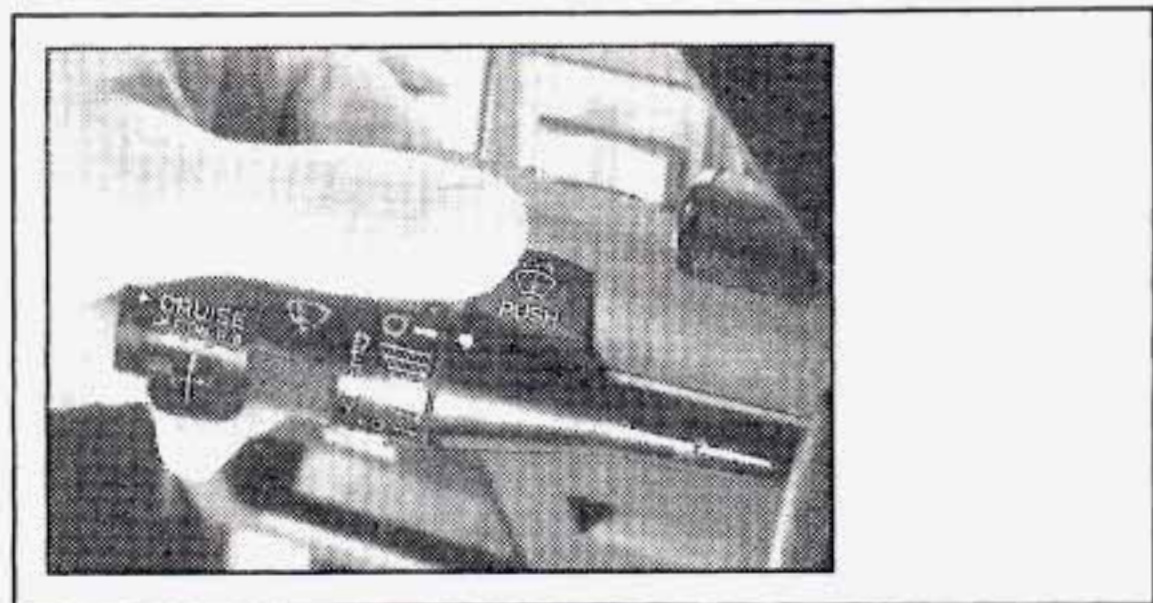

K2246

At the top of the multifunction lever there's a paddle with the word **PUSH** on it. To spray washer fluid on the windshield, push the paddle.

The wipers will clear the window and then either stop or return to your preset speed.

### CAUTION



- Driving without washer fluid can be dangerous. A bad mud splash can block your vision. You could hit another vehicle or go off the road. Check your washer fluid level often.
- In freezing weather, don't use your washer until the windshield is warmed. Otherwise the washer fluid can form ice on the windshield, blocking your vision.



## NOTICE

- When using concentrated washer fluid, follow the manufacturer's instructions for adding water.
- Don't mix water with ready-to-use washer fluid. Water can cause the solution to freeze and damage your washer fluid tank and other parts of the washer system. Also, water doesn't clean as well as washer fluid.
- Fill your washer fluid tank only 3/4 full when it's very cold. This allows for expansion, which could damage the tank if it is completely full.
- Don't use radiator antifreeze in your windshield washer. It can damage your washer system and paint.

### *Cruise Control (Option)*

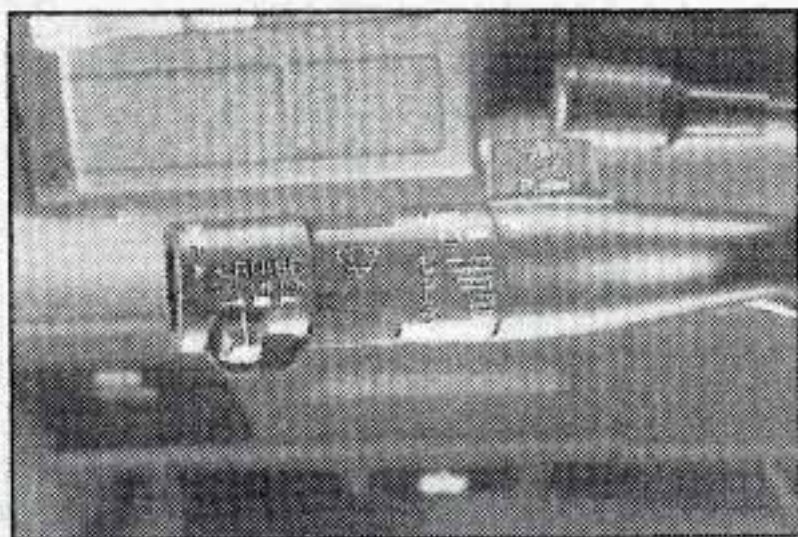

K2247

With Cruise Control, you can maintain a speed of about 25 mph (40 km/h) or more without keeping your foot on the accelerator. This can really help on long trips. Cruise Control does not work at speeds below about 25 mph (40 km/h).

When you apply your brakes, or the clutch pedal, if you have a manual transmission, the Cruise Control shuts off.

## Features & Controls

### CAUTION



- Cruise Control can be dangerous where you can't drive safely at a steady speed. So, don't use your Cruise Control on winding roads or in heavy traffic.
- Cruise Control can be dangerous on slippery roads. On such roads, fast changes in tire traction can cause needless wheel spinning, and you could lose control. Don't use Cruise Control on slippery roads.

### To Set Cruise Control

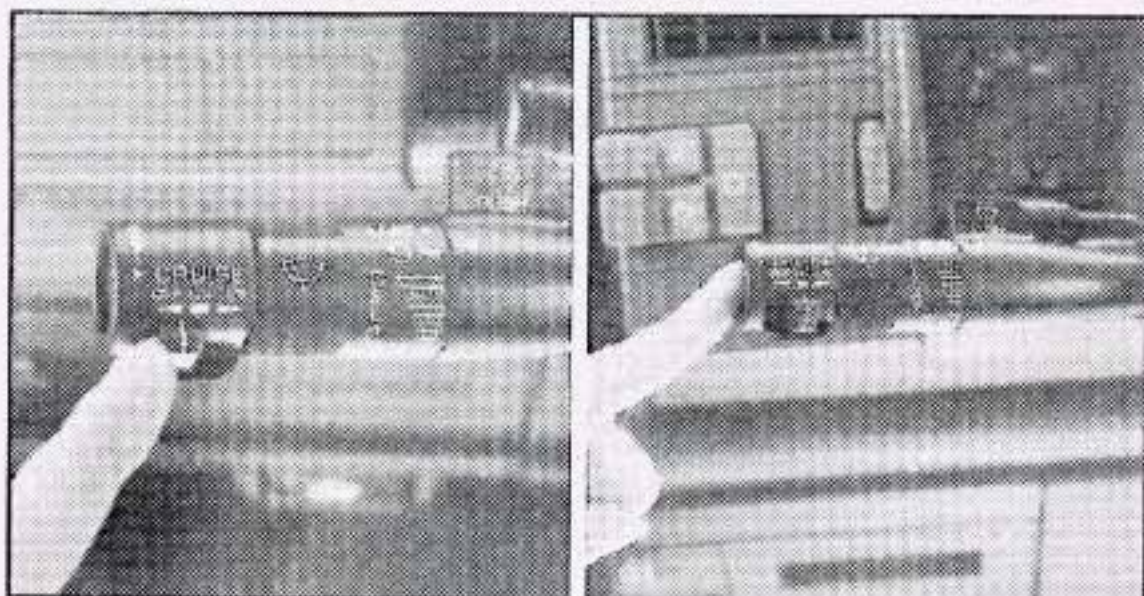

K2248

Move the Cruise switch to **ON**.

### CAUTION



If you leave your Cruise Control switch on when you're not using Cruise, you might hit a button and go into Cruise when you don't want to. You could be startled and even lose control. Keep the Cruise Control switch **OFF** until you want to use it.

- Get up to the speed you want.
- Push in the set button at the end of the lever and release it.
- Take your foot off the accelerator pedal.

### ***To Resume a Set Speed***

Suppose you set your Cruise Control at a desired speed and then you apply the brake. This, of course, shuts off the Cruise Control. But you don't need to reset it. Once you're going about 25 mph (40 km/h) or more, you can move the Cruise Control switch from **ON** to **R/A** for about half a second.

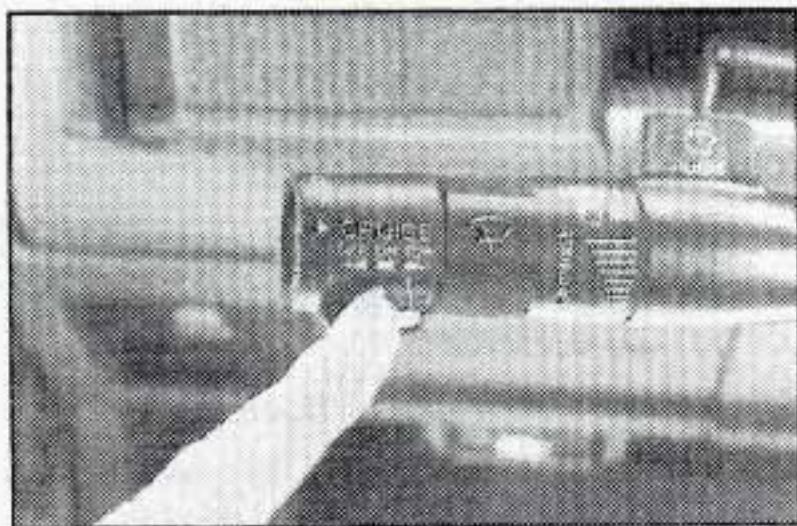

K2249

You'll go right back up to your chosen speed and stay there.

### **CAUTION**



If you hold the switch at **R/A** longer than half a second, the vehicle will keep going faster until you release the switch or apply the brake. You could be startled and even lose control. So unless you want to go faster, don't hold the switch at **R/A**.

### ***To Increase Speed While Using Cruise Control***

There are two ways to go to a higher speed. Here's the first:

1. Use the accelerator pedal to get to the higher speed.
2. Push the button at the end of the lever, then release the button and the accelerator pedal.

You'll now cruise at the higher speed.

## Features & Controls

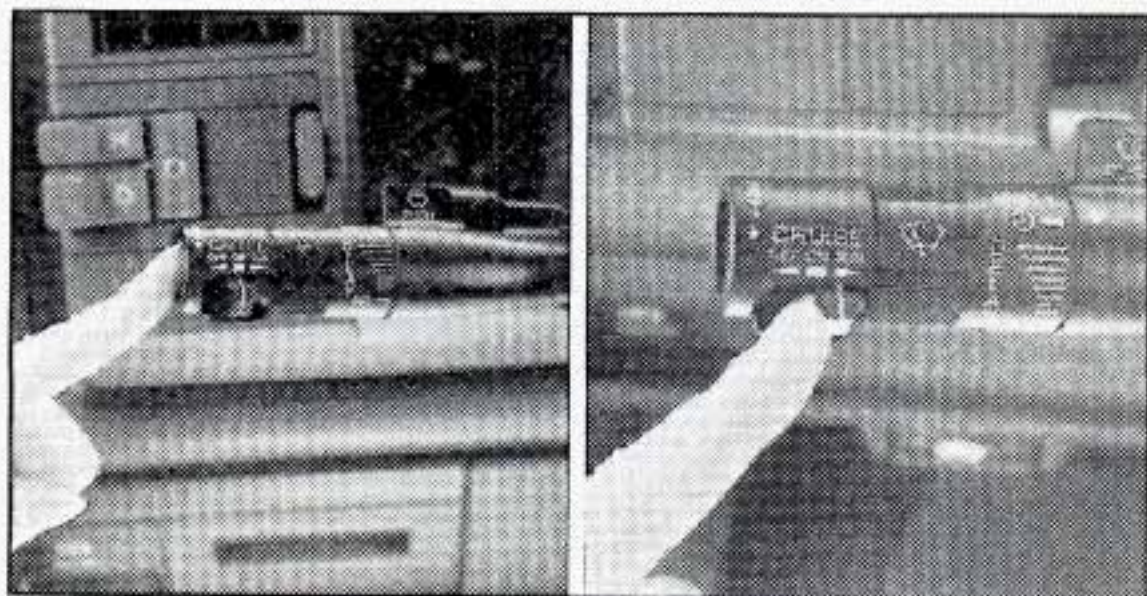

K2207

### ***Here's the Second Way to go to a higher speed:***

1. Move the Cruise switch from **ON** to **R/A**. Hold it there until you get up to the speed you want, and then release the switch.
2. To increase your speed in very small amounts, move the switch to **R/A** for less than three quarters of a second and then release it. Each time you do this, your vehicle will go about 1 mph (1.6 km/h) faster.

### ***To Reduce Speed While Using Cruise Control***

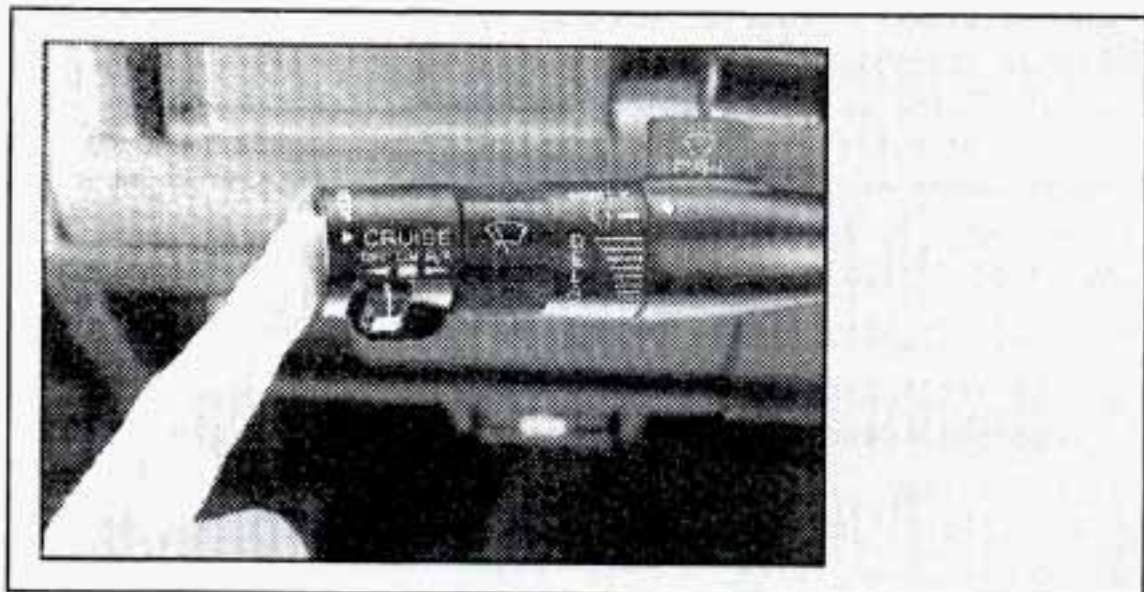

K2260

1. Push in the button at the end of the lever until you reach the lower speed you want, then release it.

- 
2. To slow down in very small amounts, push the button for less than half a second. Each time you do this, you'll go about 1 mph (1.6 km/h) slower.

### ***Passing Another Vehicle While Using Cruise Control***

Use the accelerator pedal to increase your speed. When you take your foot off the pedal, your vehicle will slow down to the Cruise Control speed you set earlier.

### ***Using Cruise Control on Hills***

How well your Cruise Control will work on hills depends upon your speed, load, and the steepness of the hills. When going up steep hills, you may have to step on the accelerator pedal to maintain your speed. When going downhill, you may have to brake or shift to a lower gear to keep your speed down. Of course, applying the brake takes you out of Cruise Control. Many drivers find this to be too much trouble and don't use Cruise Control on steep hills.

### ***To Get Out of Cruise Control***

There are several ways to turn off the Cruise Control:

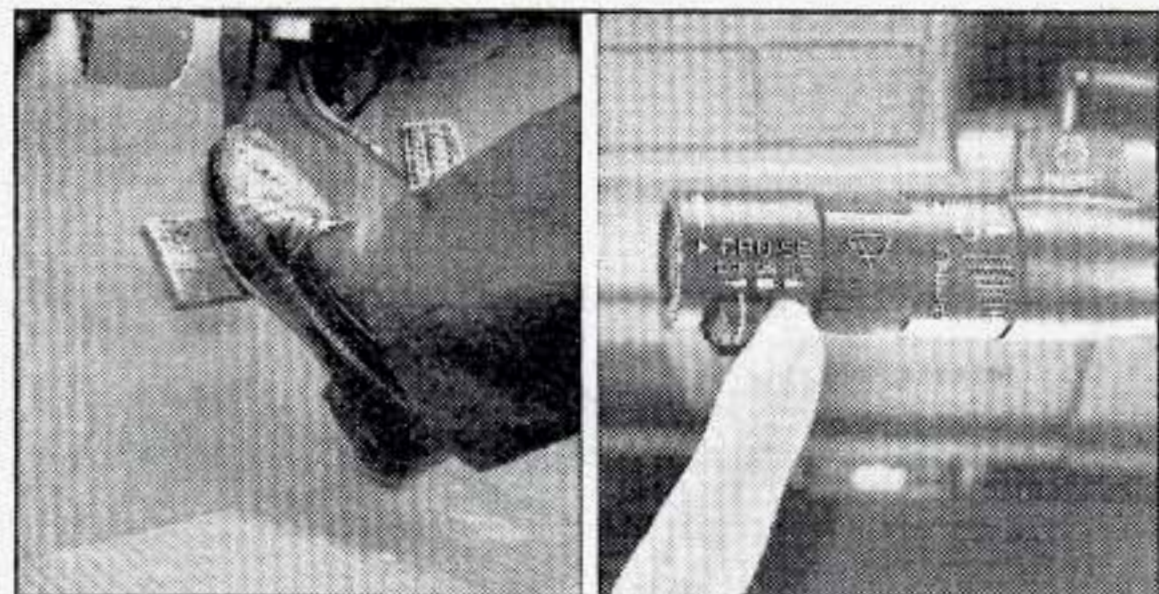

K2206

1. Step lightly on the brake pedal or push the clutch pedal, if you have a manual transmission; OR
2. Move the Cruise switch to **OFF**.

When you turn off the Cruise Control or the ignition, your Cruise Control set speed memory is erased.

## **Features & Controls**

---

### **Headlights and Vehicle Lighting**

Your light switches are on the left side of your instrument panel.

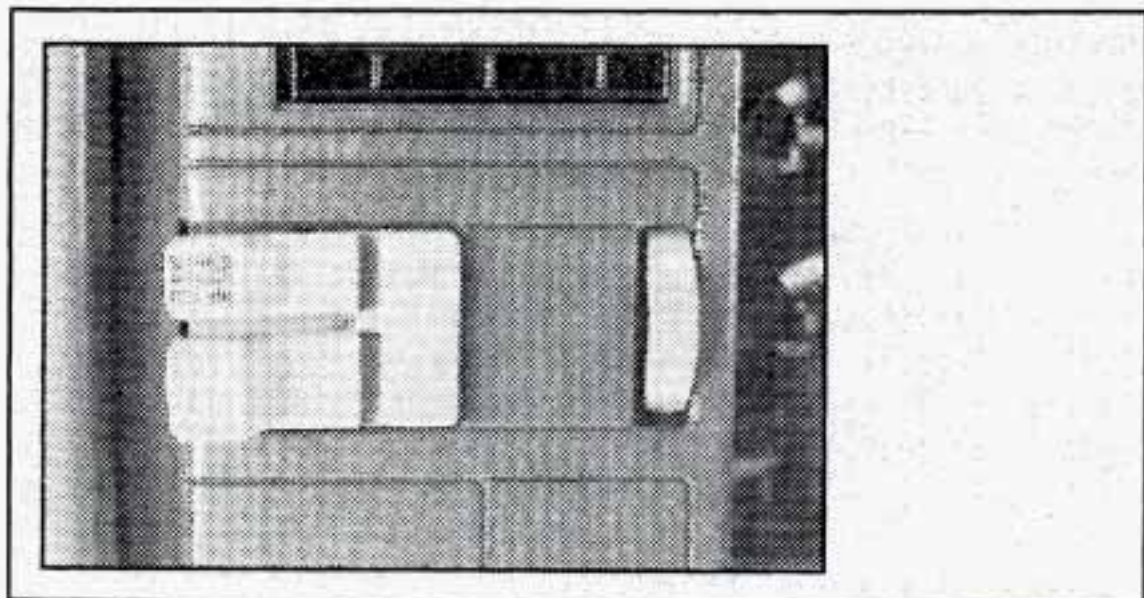

K2250

Push the left side of the switch with the parking lights symbol on it to turn on:

- Parking Lights
- Sidemarker Lights
- Taillights
- License Plate Lights
- Roof Marker Lights (if you have them)
- Instrument Panel Lights
- Transfer Case Shift Indicator Light

Push the left side of the switch with the master lighting symbol on it to turn on the headlights, together with:

- Parking Lights
- Sidemarker Lights
- Taillights
- License Plate Lights
- Roof Marker Lights (if you have them)
- Instrument Panel Lights
- Transfer Case Shift Indicator Light

---

Push the right side of the switch with the **0** symbol on it to turn off your lights.

Turn the dial at the right of the headlight switch to adjust interior lights. Turning the dial all the way up turns on the interior lights.

You can switch your headlights from low beam to high by pulling the multifunction lever toward you. To return the headlights to low beam, pull the lever again.

A circuit breaker protects your headlights from electrical overload. If you have an electrical overload, your headlights will flicker on and off. If this ever happens, have your headlight wiring checked right away.

### ***Headlights-On Reminder***

A buzzer will sound when your headlights are turned on and your ignition is in **Off**, **LOCK** or **Acc**.

### ***Daytime Running Lights (DRL) Indicator Light (Canada Only)***

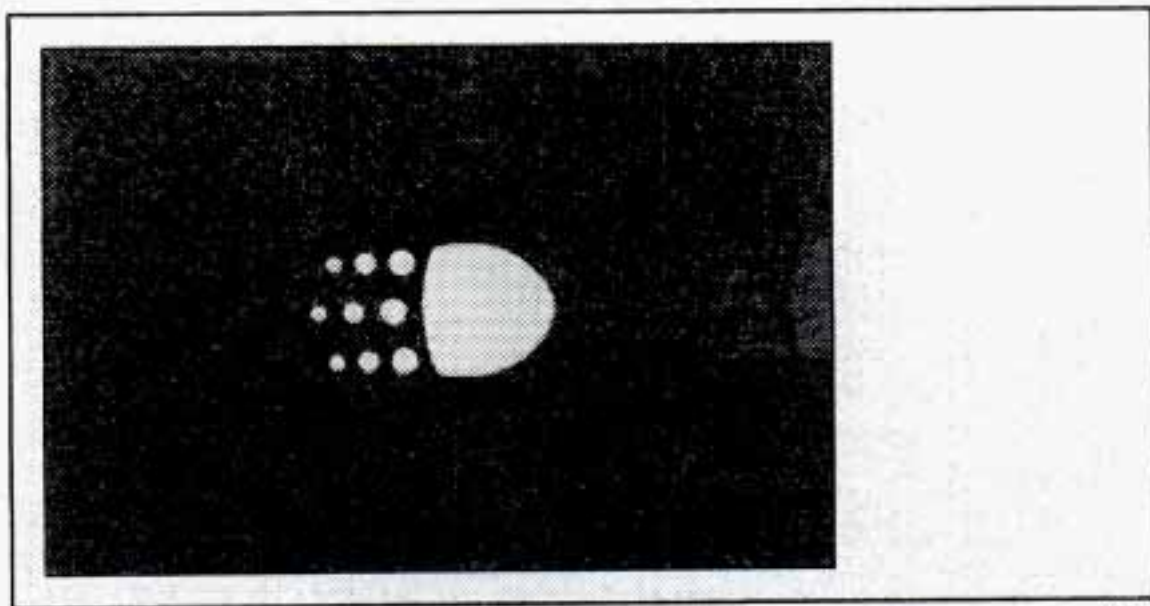

K2318

If your vehicle was first sold, when new, in Canada, you will have this light on the instrument panel. It goes on whenever the Daytime Running Lights are on.

### ***Daytime Running Lights (Canada Only)***

The Canadian Federal Government has decided that "Daytime Running Lights" (DRL) are a useful feature, in that DRL can make your vehicle more visible to pedestrians and other drivers during daylight hours. DRL are required on new vehicles sold in Canada.

## Features & Controls

---

The high beam headlights will come on at reduced brightness in Daylight when:

- The ignition is on
- The headlight switch is off, and
- The parking brake is released

When you turn on your headlights, the DRL will switch off and the exterior lights come on. When you turn off the headlights, the exterior lights will go out and the high beams will change to the reduced brightness of DRL again. The DRL indicator light on the instrument panel will go on whenever the DRL are on. This light means that only the DRL are on. When you turn on your exterior lights, this light will go out. Of course, you may still turn on the headlights any time you need to.

To idle your vehicle with the DRL off, set the parking brake. The DRL will stay off until you release the parking brake.

### ***Dome Lights***

The dome lights will come on when you open the doors or tailgate. You can also turn the dome lights on by turning the interior light dimmer dial on the headlight switch all the way up until it clicks.

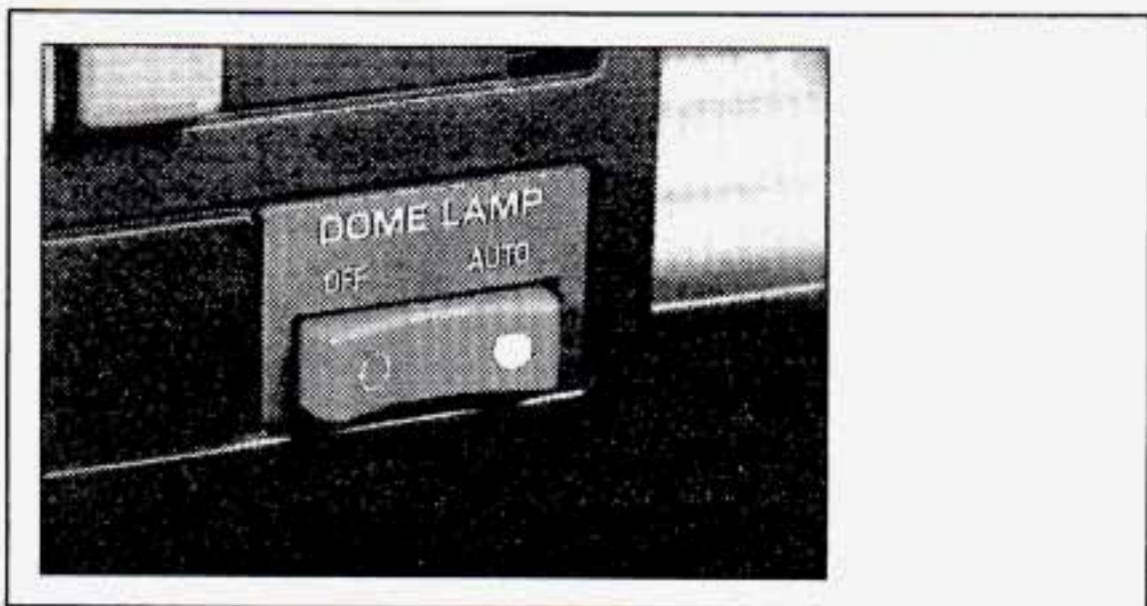

K2360

You can use the dome lamp switch, located below the headlight switch, to set the dome lamps to come on automatically or remain off. To turn the lights off, just press the side of the switch marked **OFF**. To return the lights to automatic operation, press the side marked **AUTO**.



---

---

## Reading Lights

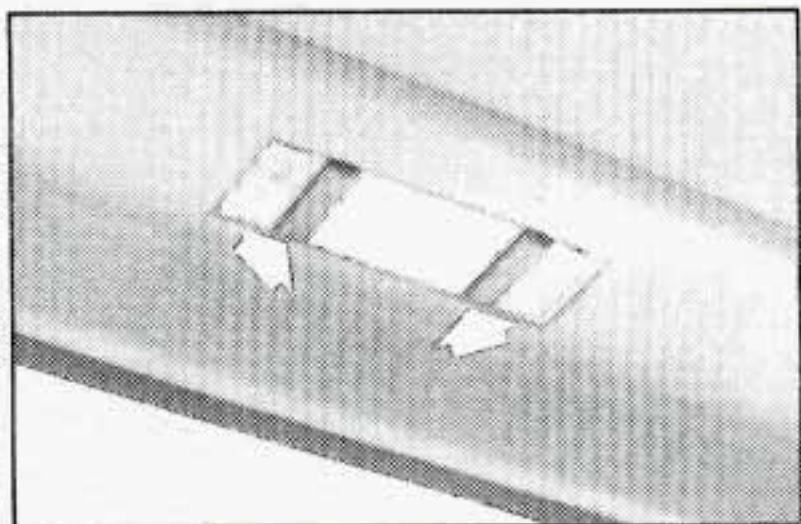

K2252

If you have reading lights, press the bar next to the light to turn the light on. Press the bar again to turn the light off.

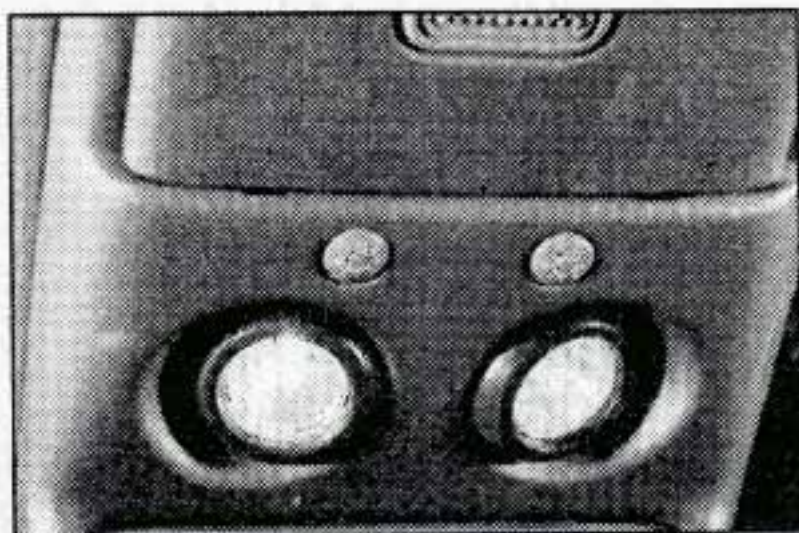

K2161

If your vehicle has an overhead console with reading lights, they can be swiveled to point in the direction you want. To turn the light on, press the button next to the light with the master lighting symbol on it. Press the button again to turn the light off.

## Features & Controls

---

### *Underhood Reel Light*

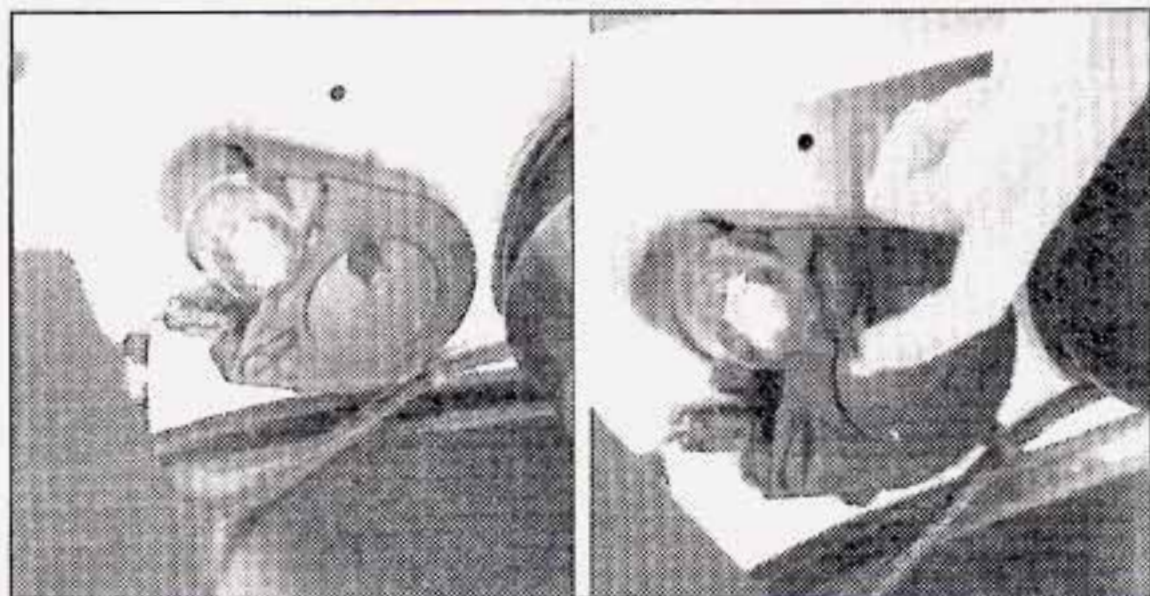

K2255

You may have an underhood reel light. It is inside the engine compartment on the passenger side fender. You can use it as a flashlight.

To use the light, pull up on the release lever and pull the light out. The cord will unreeel as you pull the light.

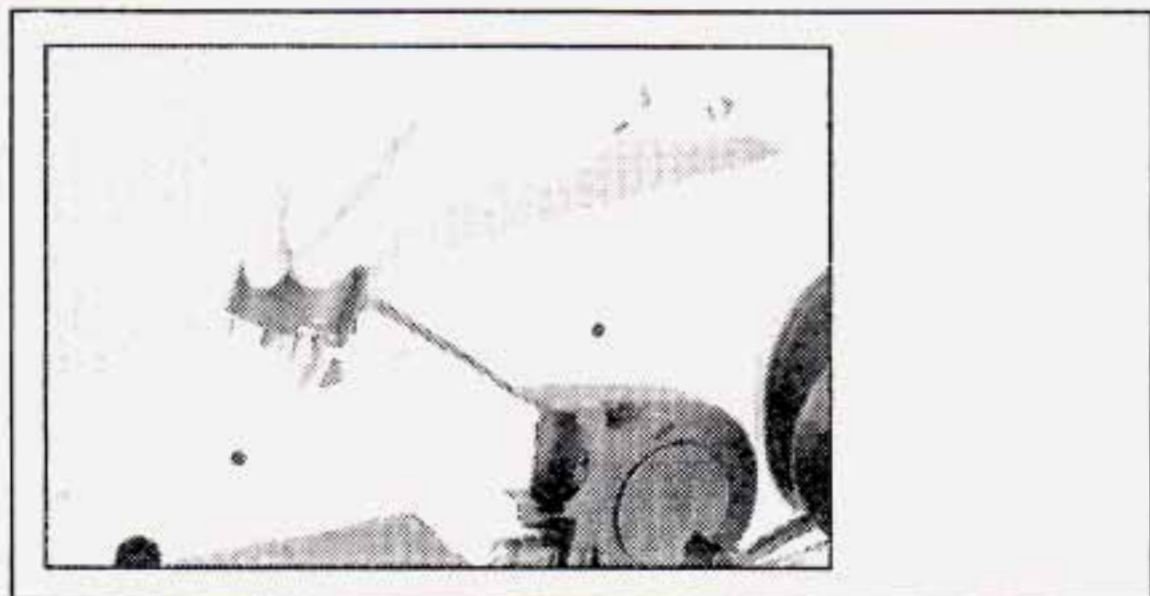

K2253

When you are done using the light, reel the cord back into the housing by turning the handle. Then, slide the light into the holder. Press **PUSH** on the release lever to lock the light into the holder.

---

---

## **Mirrors**

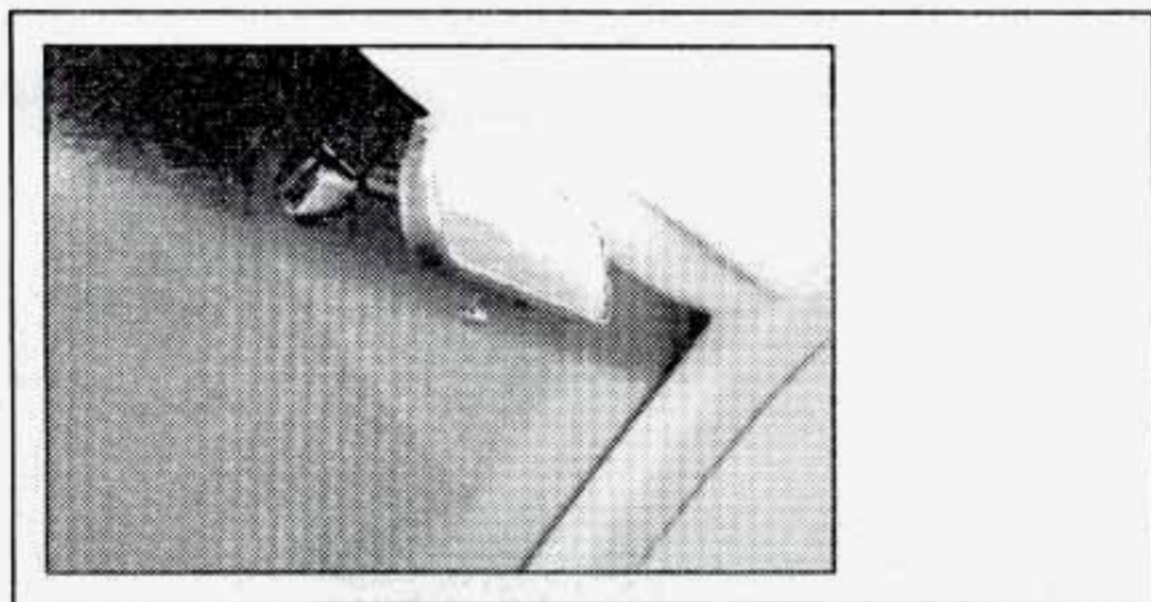

K2256

### ***Inside Mirror***

Push or pull the tab under the mirror to reduce glare from headlights behind you after dark.

### ***Outside Mirrors***

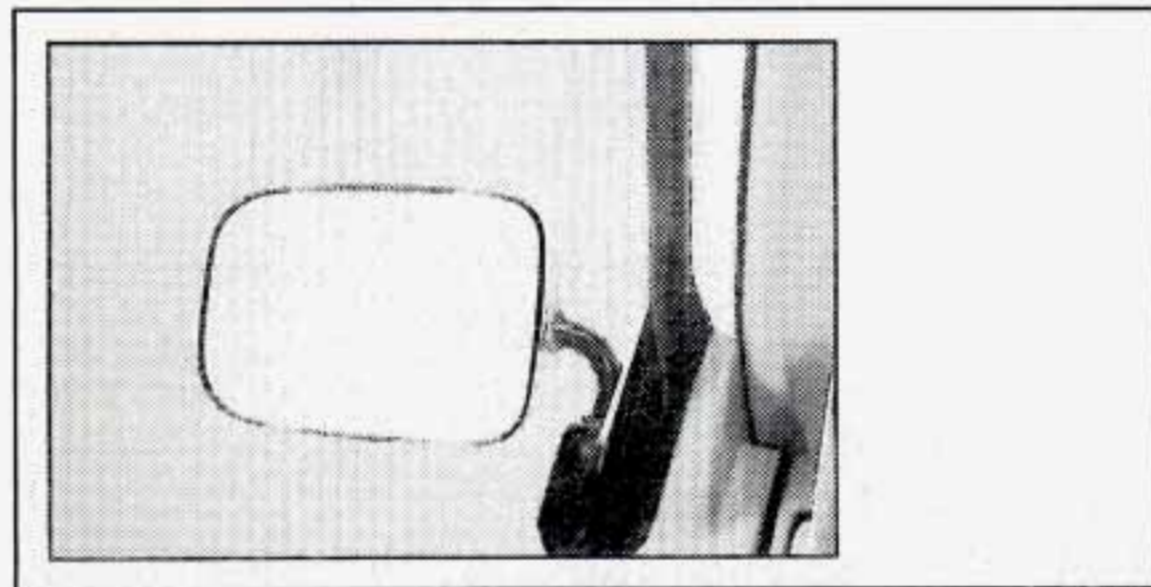

K2295

Adjust your outside mirrors so you can just see the side of your vehicle, and have a clear view of objects behind you. Some mirrors can be folded in to enter narrow doorways.

## Features & Controls

---

### *Convex Outside Mirror*

Your right side mirror may be convex. A convex mirror's surface is curved so you can see more from the driver's seat.

#### CAUTION



If you aren't used to a convex mirror, you can hit another vehicle. A convex mirror can make things (like other vehicles) look farther away than they really are. If you cut too sharply into the right lane, you could hit a vehicle on your right. Check your inside mirror or glance over your shoulder before changing lanes.

### *Electric Outside Mirrors*

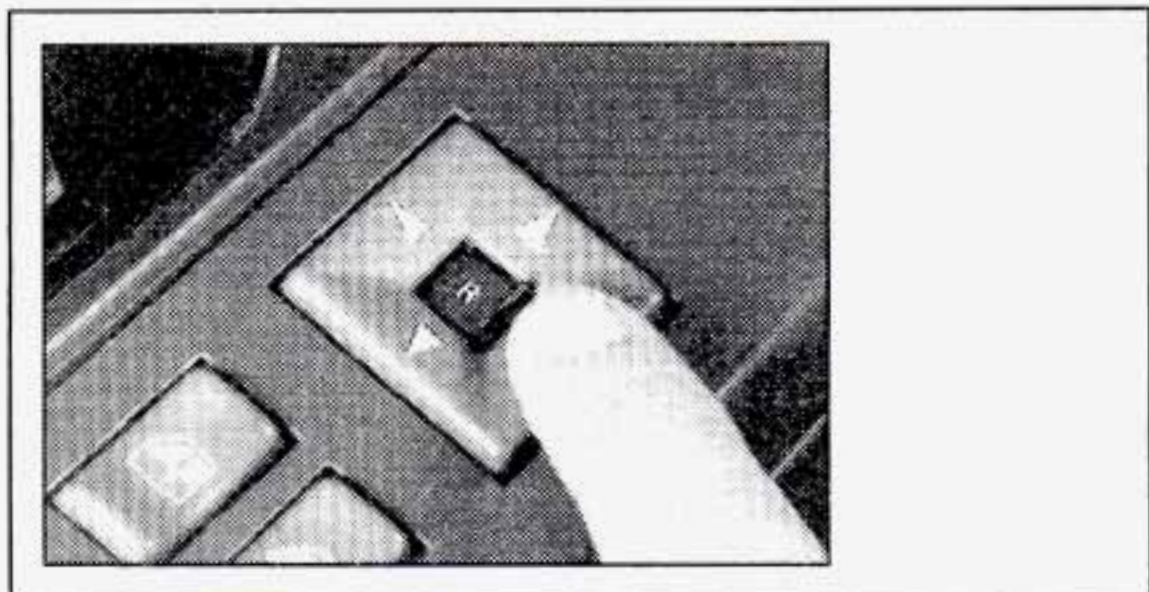

K2168

If you have electric mirrors, they can be adjusted to point where you want from inside the vehicle. Select the mirror by moving the center of the switch, located on the driver's door armrest, to **R** right or **L** left. Then, adjust the mirror angle by pressing the outer arrows on the switch until the mirror is adjusted where you want it.

---

---

## **Sun Visors**

To block out glare, you can swing down the visors. You can also swing them out to help block glare from the side.

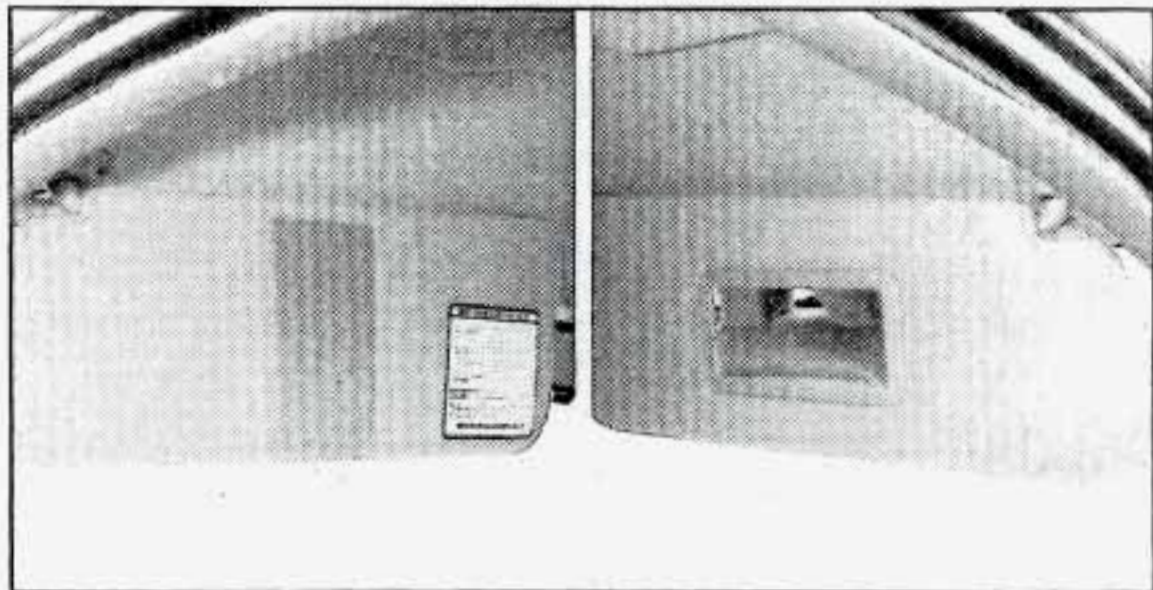

K2465

Your visor may have a strap to hold small items, such as maps. Some visors have mirrors on them.

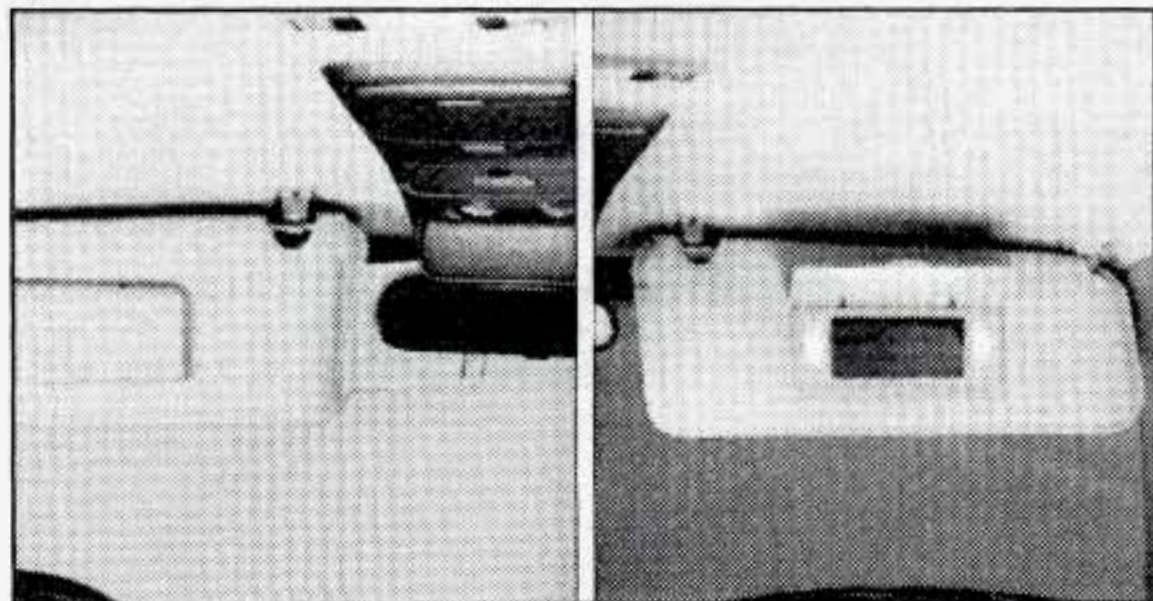

P0284

Some visors have an extender on the inside edge. When the visor is down, pull the extender out for extra glare coverage at the front or side.

Some visors have mirrors with lights. The mirror lights will come on when you lift the mirror cover.

## ***Features & Controls***

---

### ***Rear Window Wiper and Washer***



K2171

The rear window wiper/washer switch is on your instrument panel, to the right of the steering wheel.

- To turn the wiper on, slide the lever to the right.

For delay wiping, slide the lever under **DELAY** to the center of the rear wiper control. The wiper will cycle every nine seconds.

For steady wiper action, move the slide lever all the way to the right.

- To wash the window, push in on the end of the lever. Window washer fluid will continue to spray until the lever is released.

The rear window washer uses the same fluid bottle as the windshield washer. If the fluid level is low in the washer fluid bottle, you may not be able to wash your rear window. If you can wash your windshield, but not your rear window, check the fluid level.

## Cigarette Lighter/Ashtrays

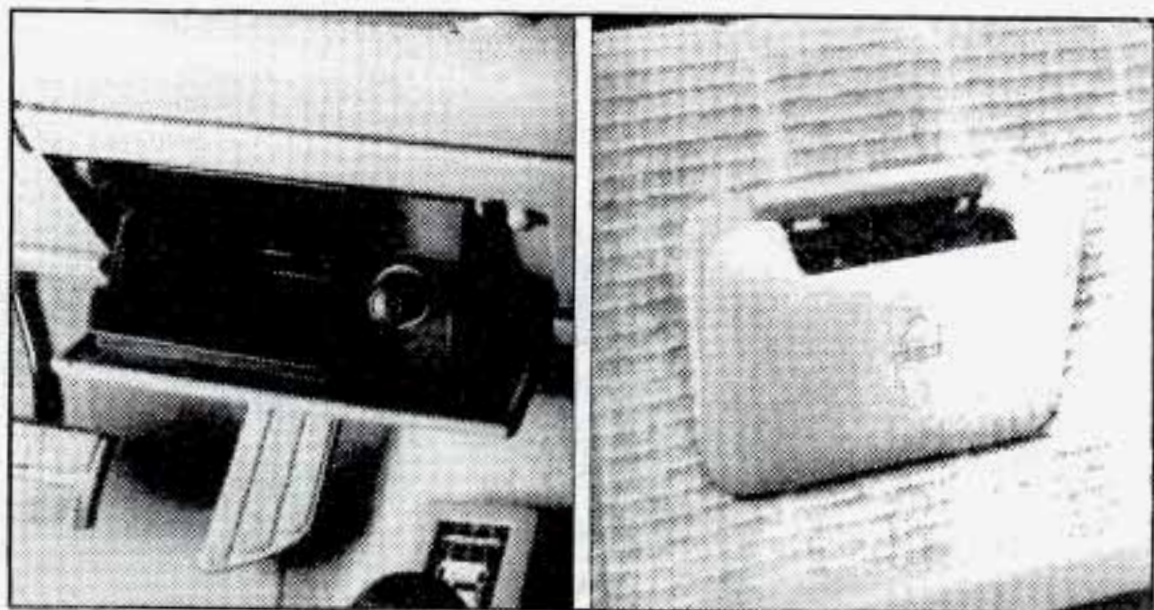

P0286

To use the lighter, push it in all the way, and let go. When it's ready, it will pop back by itself.

### NOTICE

Don't hold a cigarette lighter in with your hand while it is heating. If you do, it won't be able to back away from the heating element when it's ready. That can make it overload, damaging the lighter and the heating element.

To remove the front ashtray, pull on the front of it.

To remove the rear ashtrays, press down on the inside tabs and pull.

Don't put papers and other things that burn into your ashtrays. If you do, cigarettes or other smoking materials could set them on fire, causing damage.

## Storage Compartments

Your vehicle has a variety of storage compartments provided for your convenience.

## **Features & Controls**

---

### **Glove Box**

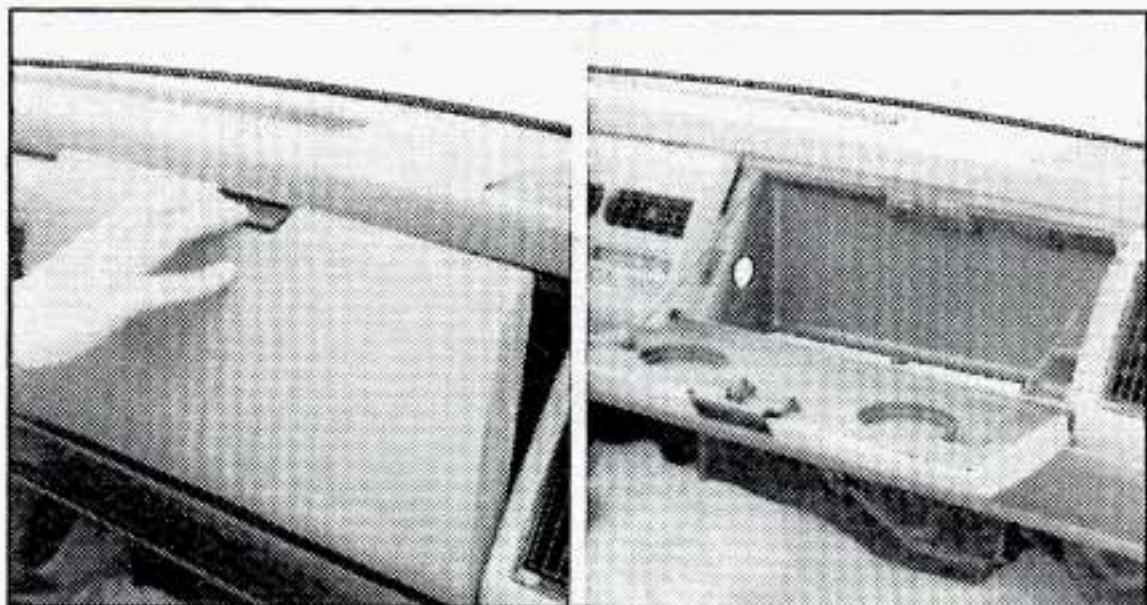

K2234

To open your glove box, press the button down and pull the door open. Two cup holders are provided for your convenience.

### **Center Floor Console**

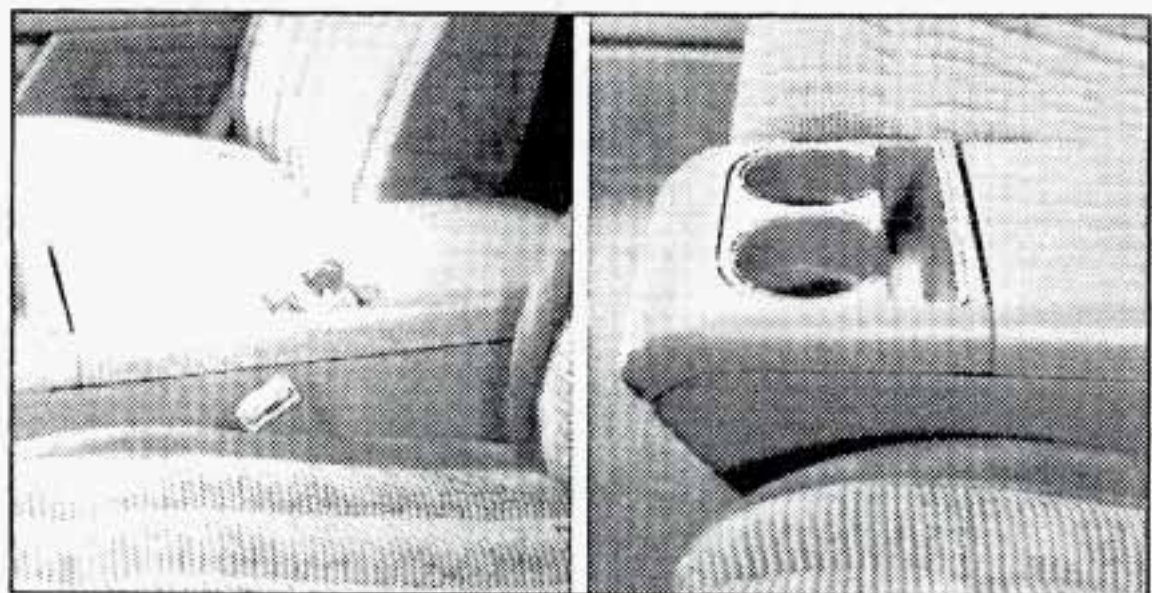

K2239

Your vehicle may have a console compartment between the bucket seats. To open it, just squeeze the buttons on both sides of the keyhole, and pull up. Use your round key to lock this compartment. Your console also includes a handy place to hold cups.



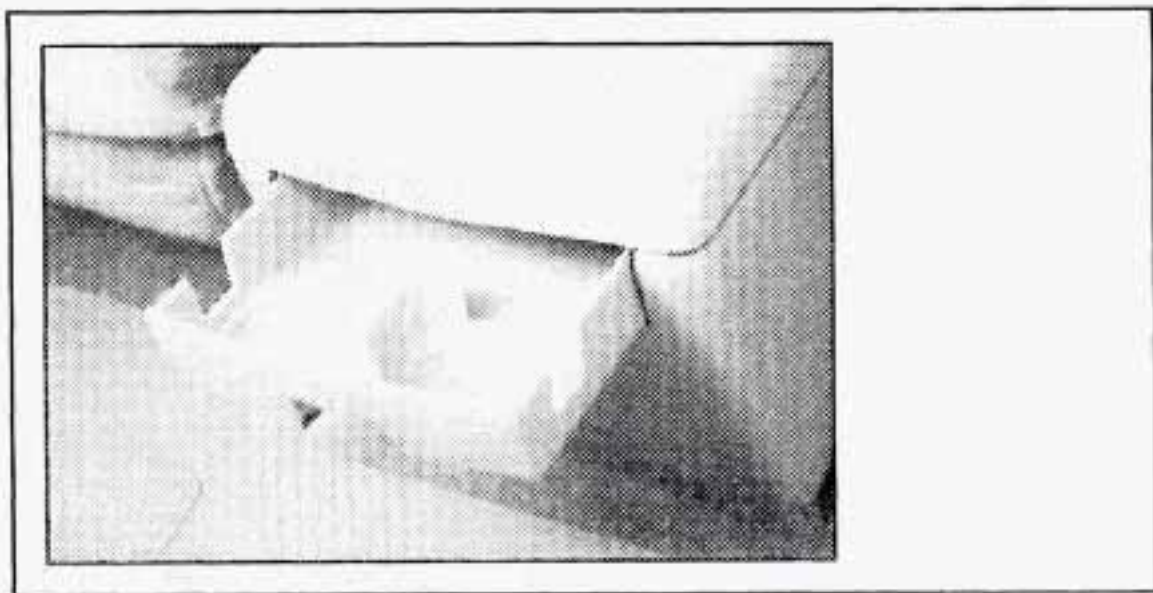

P0192

Your console also has a cup holder that slides out, for the back seat passengers to use.

### ***Cup Holder***

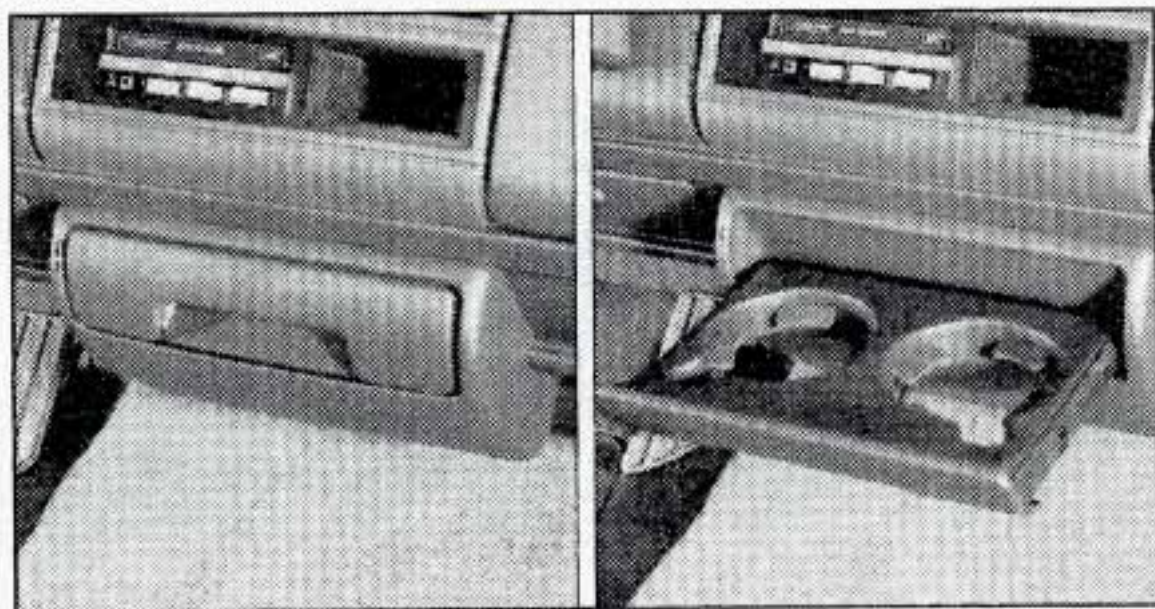

PB002

If your vehicle has a full or split bench seat, you may have a cup holder attached to the instrument panel.

To use the cup holder, pull the handle and slide the cup holder tray out until it stops. Then, let the cup holder swing down into position. To close the cup holder, lift the front and slide the tray all the way in.

## Features & Controls

---

### Center Overhead Console

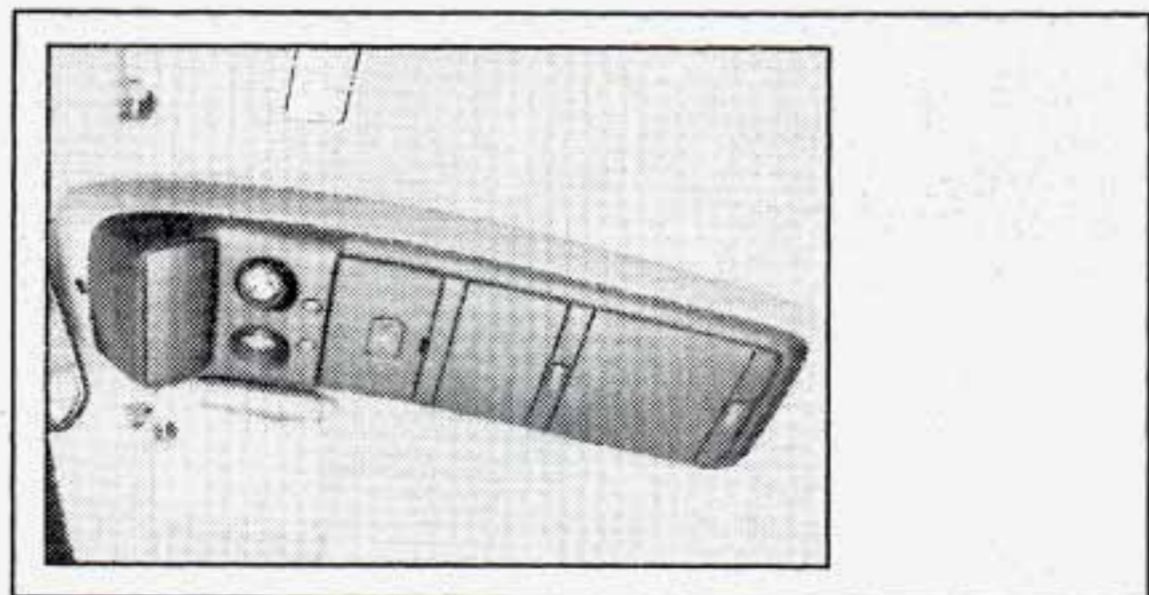

P0222

Your vehicle may have an overhead console. It has storage compartments inside it.

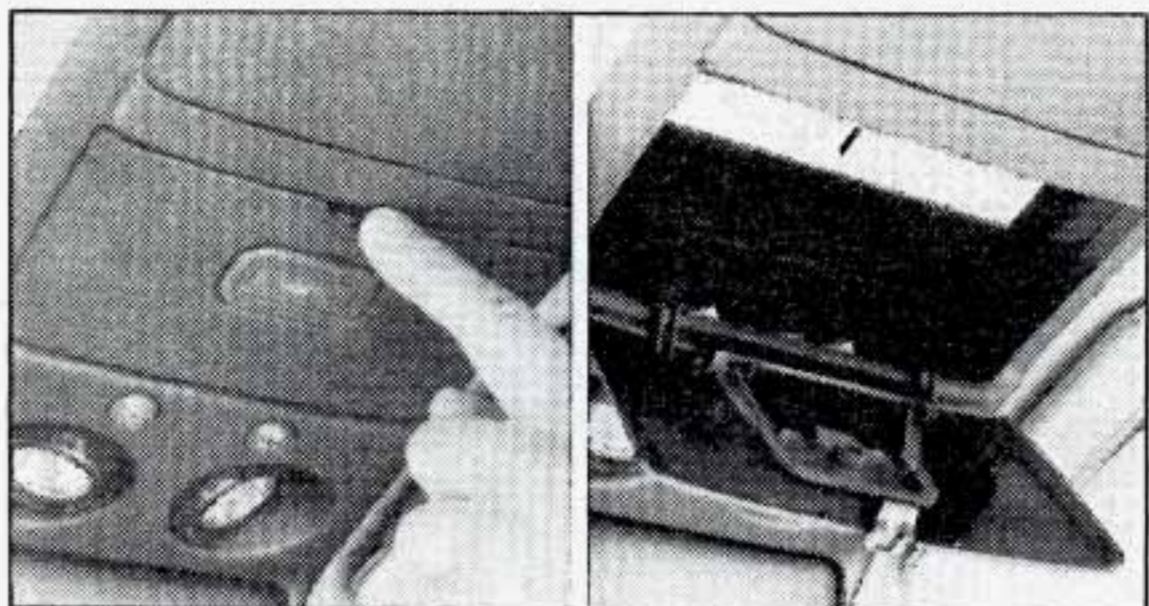

P0057

If you have a garage door opener, the front overhead compartment can be used to conveniently store the opener. To install the garage door opener, first open the compartment door by pressing the release button forward.

Peel the protective backing from the hook and loop patch. Press it firmly to the back of your garage door opener, as close to the center of the opener as possible.

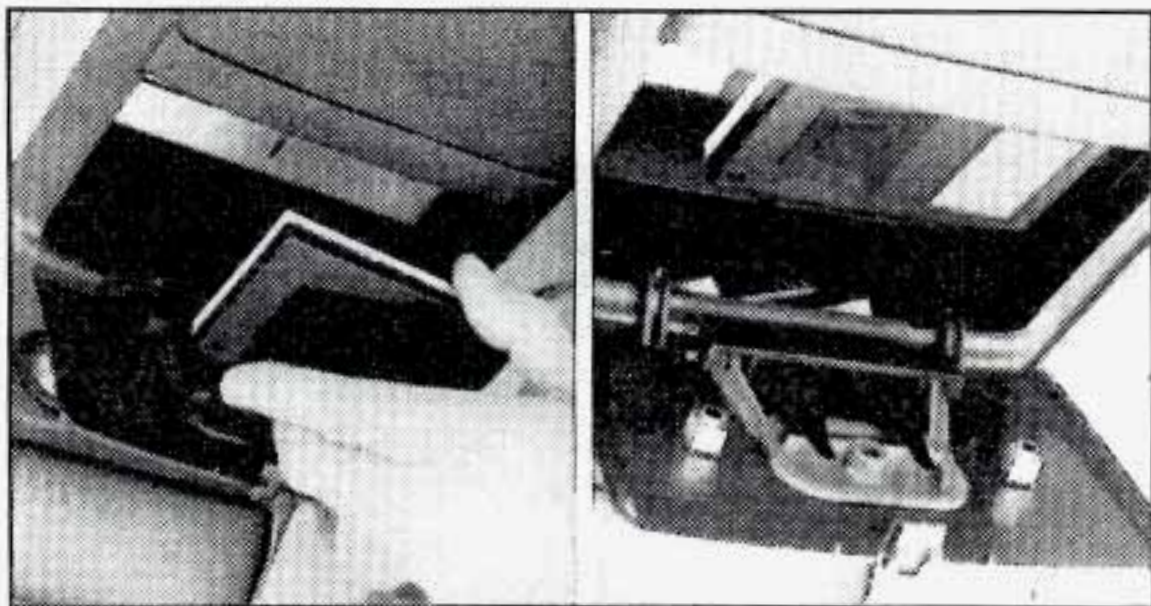

P0058

Center the garage door opener activation button over the console door button, and press the opener firmly into place.

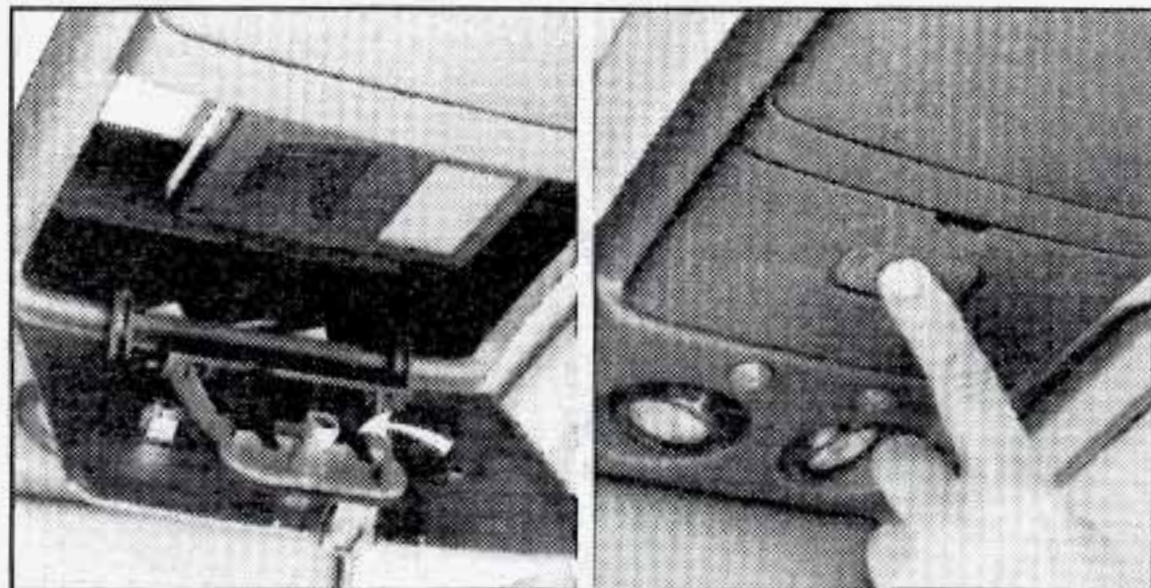

P0059

Use the pegs inside the compartment door to make sure the button on the compartment door will contact the control button on the garage door opener. Add one peg at a time until the garage door opener operates with the compartment door closed, when you push the button marked PUSH.

## Features & Controls

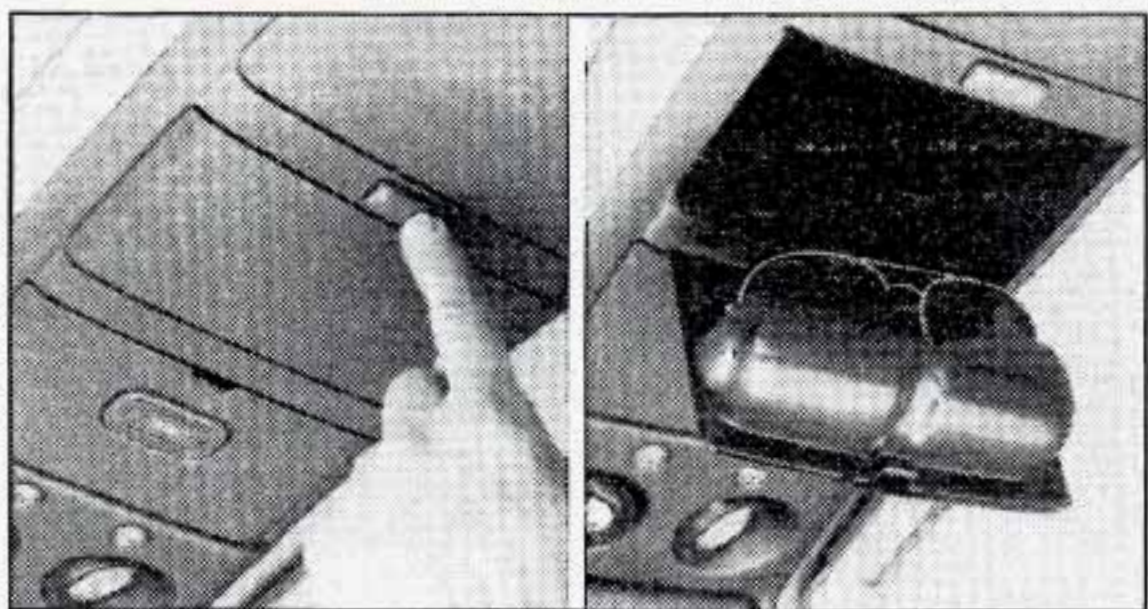

P0223

The center overhead compartment can be used to conveniently store your sunglasses. To open the compartment, press the release button located at the rear of the compartment door.

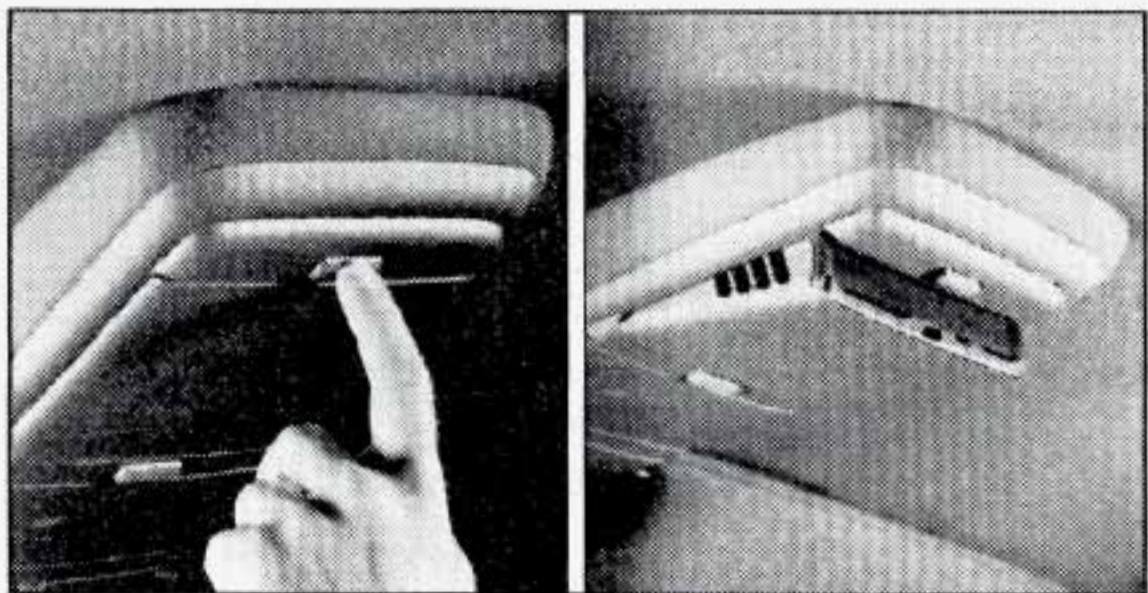

K2147

The rear overhead compartment can be used to store a small item, like a book. To open the compartment, press the release button located at the rear of the compartment door.

---

---

## **Other Storage Compartments**

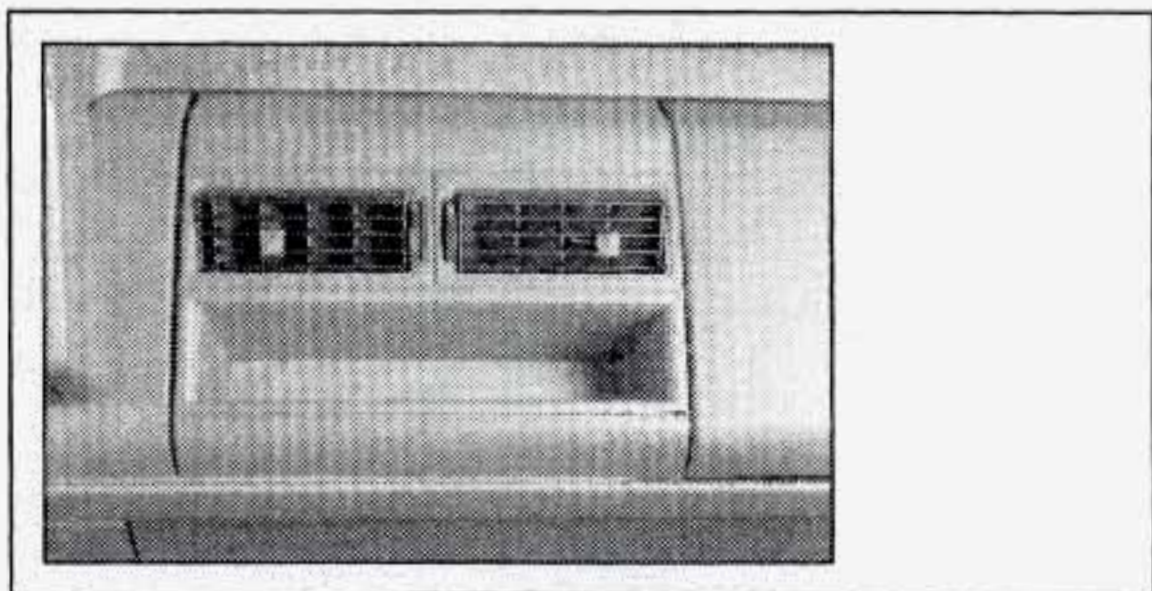

K2238

Some vehicles have storage areas in the instrument panel. Use these spaces for items such as gloves or small books.

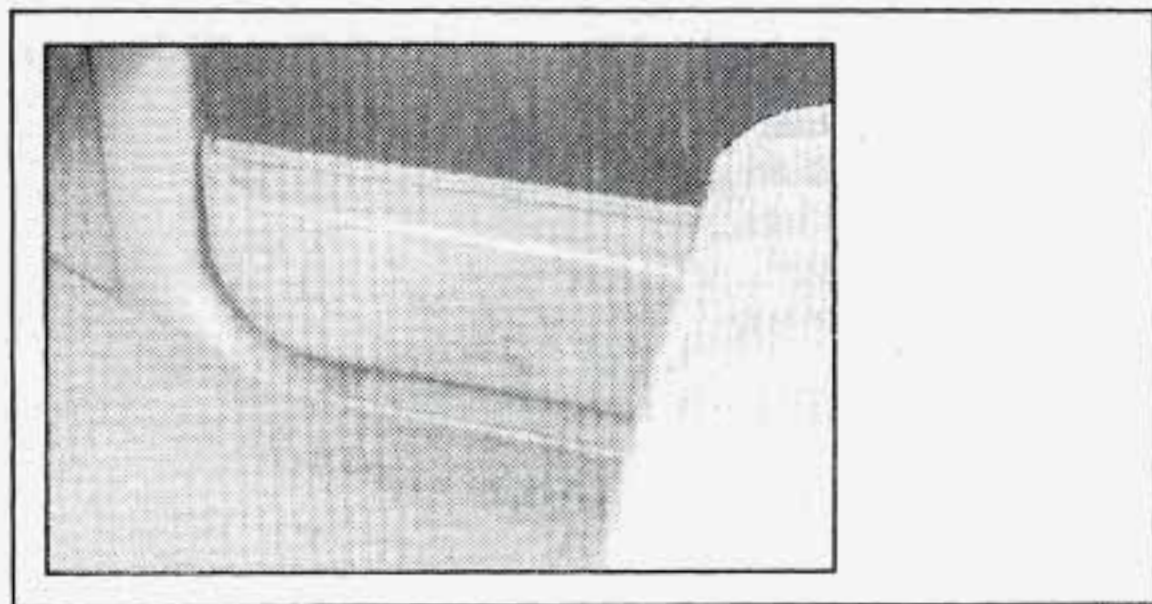

K2269

Some models have a storage pocket on each of the front doors. You can use the pocket to store a variety of small items.

## Features & Controls

### ■ INSTRUMENT PANEL AND CONTROLS

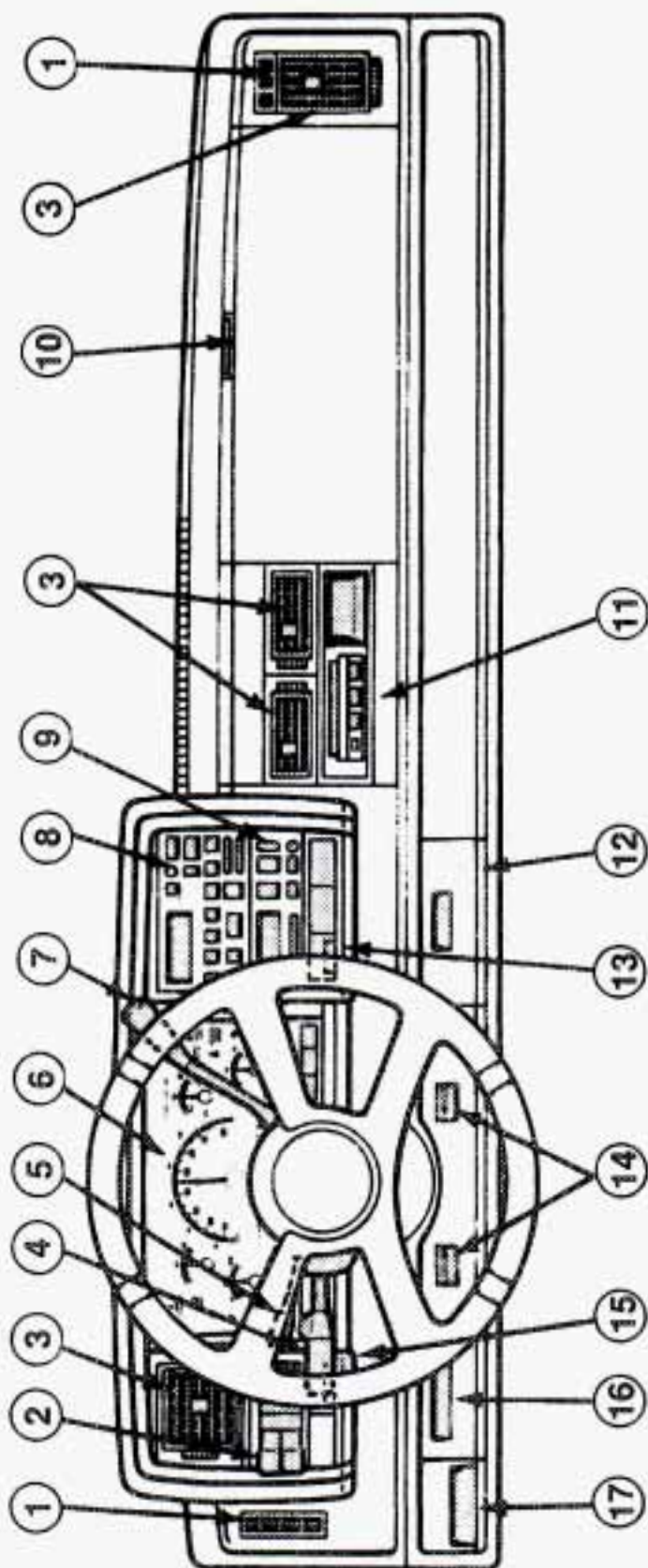

1. Side Window Defogger Vents
2. Light Controls
3. Air Vents
4. Multifunction Lever
5. Tilt Lever
6. Instrument Cluster
7. Gearshift Lever
8. Audio System
9. Climate Control System
10. Glove Box
11. Audio System
12. Ashtray
13. Rear Window Defogger Switch or Auxiliary (Rear) Heater Switch
14. Air Vent Handles
15. Cargo Lamp Switch
16. Fuse Panel
17. Parking Brake Release Handle

## Features & Controls

### INSTRUMENT CLUSTER - STANDARD





# INSTRUMENT CLUSTER - TACHOMETER

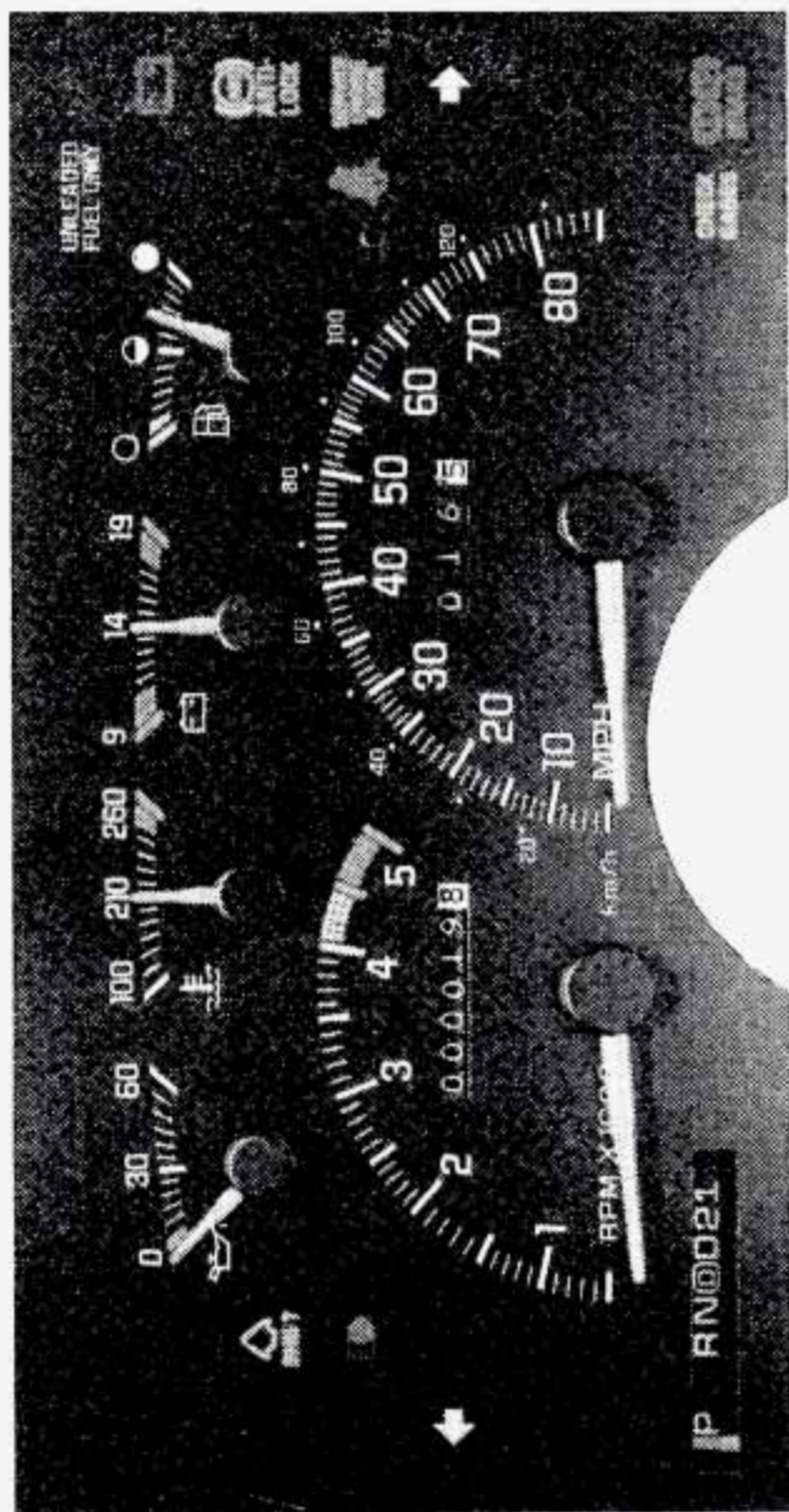

## **Features & Controls**

---

### **Instrument Cluster**

Your instrument cluster is designed to let you know at a glance how your vehicle is running. You'll know how fast you're going, about how much fuel you have, and many other things you'll need to know to drive safely and economically.

### **Tachometer Cluster**

If you have the tachometer cluster, it looks slightly different but will tell you everything the standard cluster does, in addition to displaying the vehicles engine revolutions per minute (rpm).

### **Speedometer and Odometer**

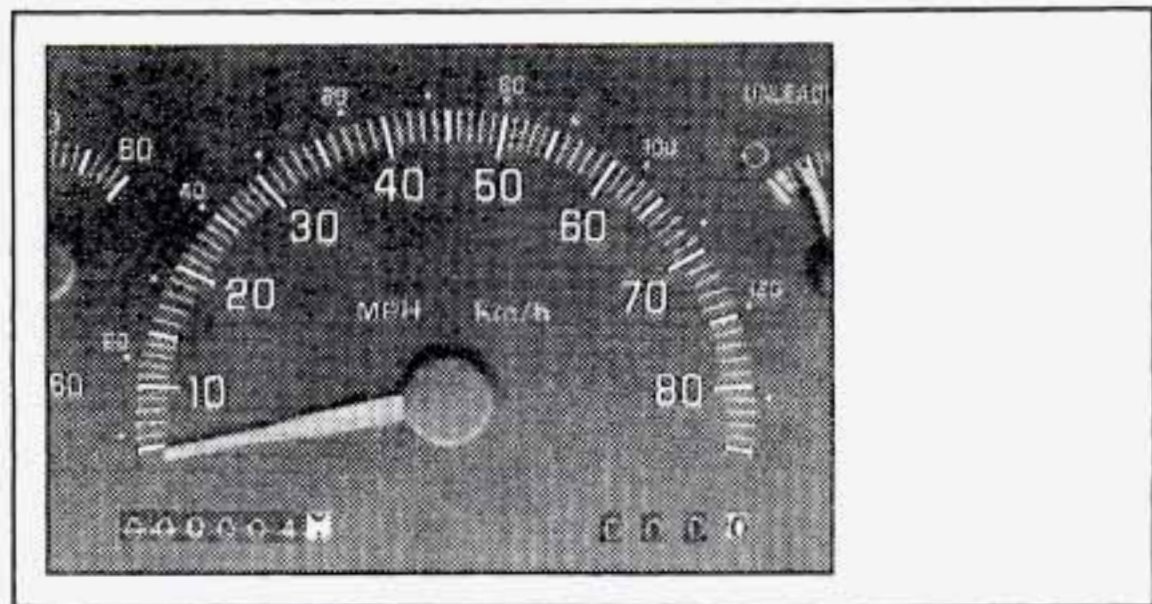

K2322

Your speedometer lets you see your speed in both miles per hour (mph) and kilometers per hour (km/h). Your odometer shows how far your vehicle has been driven, in either miles (used in the U.S.) or kilometers (used in Canada).

### **Tamper Resistant Odometer**

Your odometer is tamper-resistant. The odometer will show silver lines between the numbers if someone tries to turn it back.

You may wonder what happens if your vehicle needs a new odometer installed. If the new one can be set to the mileage total of the old odometer, then it must be. But if it can't, then it's set at zero, and a label must be put on the driver's door to show the old mileage reading when the new odometer was installed.

## ***Trip Odometer***

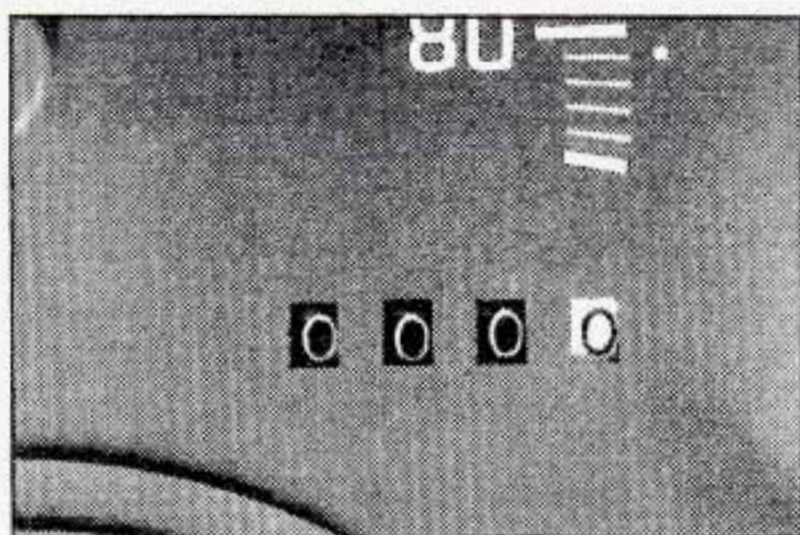

K2323

The trip odometer can tell you how far your vehicle has been driven since you last set the trip odometer to zero.

To reset the trip odometer, fully press the reset button located near the readout. If the reset button is not fully pressed, the trip odometer may not go all the way back to zero. If it doesn't, you may have to press the reset button again to reset the readout to zero.

## ***Tachometer***



K2324

If you have a tachometer, it displays the engine speed in revolutions per minute (rpm).

## **Features & Controls**

---

### **NOTICE**

Do not operate the engine with the tachometer in the red area, or engine damage may occur.

Damage to your engine or vehicle caused by operating the engine in the red area isn't covered by your vehicle warranty.

### ***Warning Lights, Gages and Indicators***

This part describes the warning lights and gages that are on your vehicle. The pictures will help you locate them.

Warning lights and gages can signal that something is wrong before it becomes serious enough to cause an expensive repair or replacement. Paying attention to your warning lights and gages could also save you or others from injury.

Warning lights go on when there may be or is a problem with one of your vehicle's functions. As you will see in the details on the next few pages, some warning lights come on briefly when you turn the ignition key just to let you know they're working. If you are familiar with this part, you should not be alarmed when this happens.

Gages can indicate when there may be or is a problem with one of your vehicle's functions. Often gages and warning lights work together to let you know when there's a problem with your vehicle.

When one of the warning lights comes on and stays on when you are driving, or when one of the gages shows there may be a problem, check the part that tells you what to do about it. Please follow the manual's advice. Waiting to do repairs can be costly—and even dangerous. So please get to know your warning lights and gages. They're a big help.

---

---

## Brake System Warning Light



K2325

Your vehicle's hydraulic brake system is divided into two parts. If one part isn't working, the other part can still work and stop you. For good braking, though, you need both parts working well. If the warning light goes on, there could be a brake problem. Have your brake system inspected right away.

This light should come on as you start the vehicle. If it doesn't come on then, have it fixed so it will be ready to warn you if there's a problem.

This light will also come on when you set your parking brake, and it will stay on if your parking brake doesn't release fully. If it stays on after your parking brake is fully released, it means you may have a brake problem.

If the light comes on while driving, pull off the road and stop carefully. You may notice that the pedal is harder to push. Or, the pedal may go closer to the floor. It may take longer to stop. If the light is still on, have the vehicle towed for service. (See "Towing Your Vehicle" in the Index.)

### CAUTION



Your brake system may not be working properly if the brake warning light is on. Driving with the brake warning light on can lead to an accident. If the light is still on after you've pulled off the road and stopped carefully, have the vehicle towed for service.

## **Features & Controls**

---

### ***Anti-Lock Brake System Warning Light***

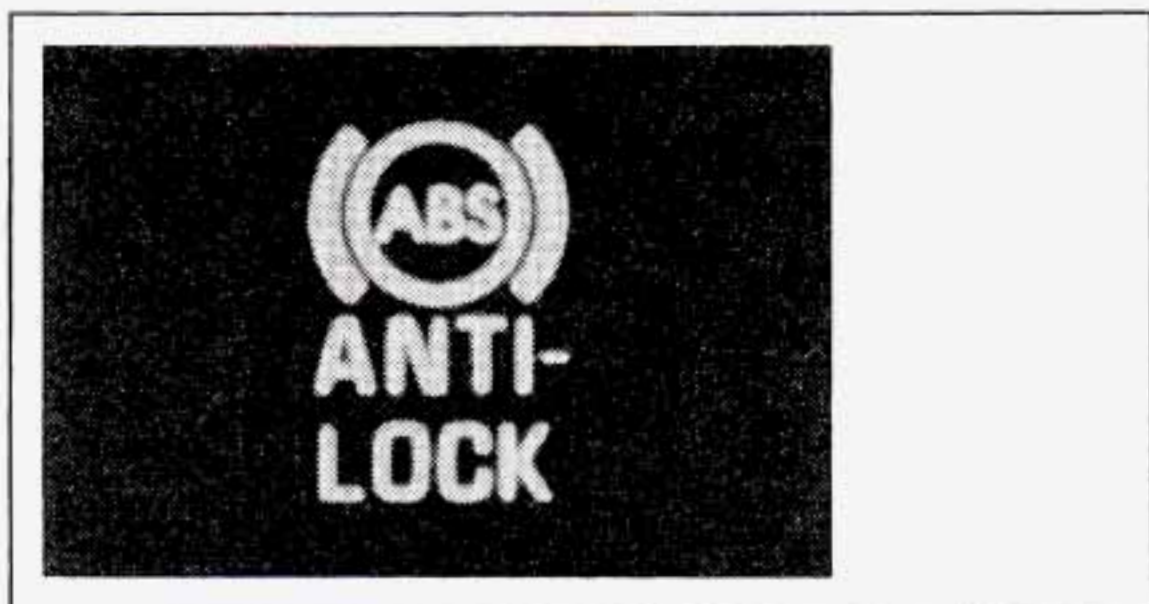

PB005

With anti-lock, this light will go on when you start your engine and may stay on for several seconds or so. That's normal.

If the light doesn't come on, have it fixed so it will be ready to warn you if there is a problem.

If the light stays on, or comes on when you're driving, your vehicle needs service. Unless the regular brake system warning light is also on, you will still have brakes, but not anti-lock brakes. If the regular brake system warning light is also on, see "Brake System Warning Light" earlier in this section.

---

---

## ***Charging System Light***

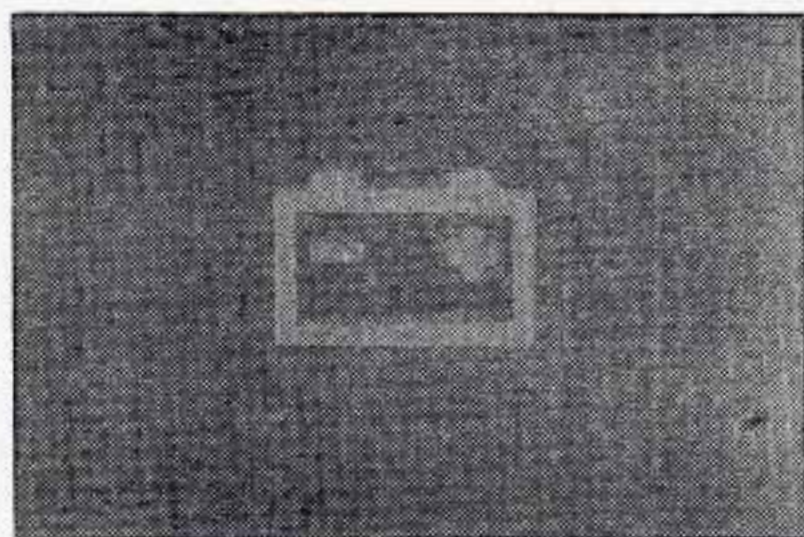

K2328

The red charging system light is located at the upper right hand corner of your instrument cluster. It should come on briefly when you turn on the ignition, before starting the engine, as a check to show you it is working. After the engine starts, the light should go out. If it stays on, or comes on while you are driving, you may have a problem with your electrical charging system. It could indicate that you have a loose alternator drive belt, or that you have some other electrical problem. Have it checked right away. Driving while this light is on could drain your battery.

If you must drive a short distance with the light on, be certain to turn off all your accessories, such as the radio and air conditioner.

## Features & Controls

---

### *Malfunction Indicator Lamp (Service Engine Soon Light)*



K2329

A computer monitors operation of your fuel, ignition and emission control systems. This light should come on when the ignition is on, but the engine is not running, as a check to show you it is working. If it does not come on at all, have it fixed right away. If it stays on, or comes on while you are driving, the computer is indicating that you have a problem. You should take your vehicle in for service soon.

### **NOTICE**

If you keep driving your vehicle with this light on, after awhile the emission controls won't work as well, your fuel economy won't be as good, and your engine may not run as smoothly. This could lead to costly repairs not covered by your warranty.



---

### ***CHECK GAGES Light***

This light will come on briefly when you are starting the engine. If the light comes on and stays on while you are driving, it could indicate a problem with your vehicle. Check your various gages to see if they are in the warning zones.

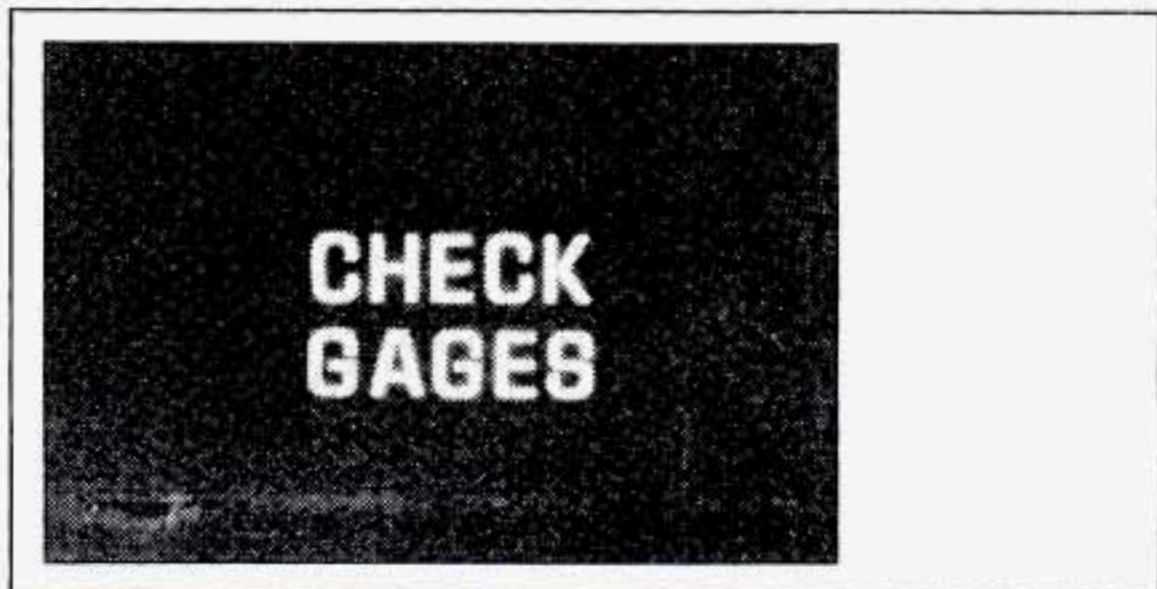

K2330

### ***Daytime Running Lights (DRL) Indicator Light (Canada Only)***

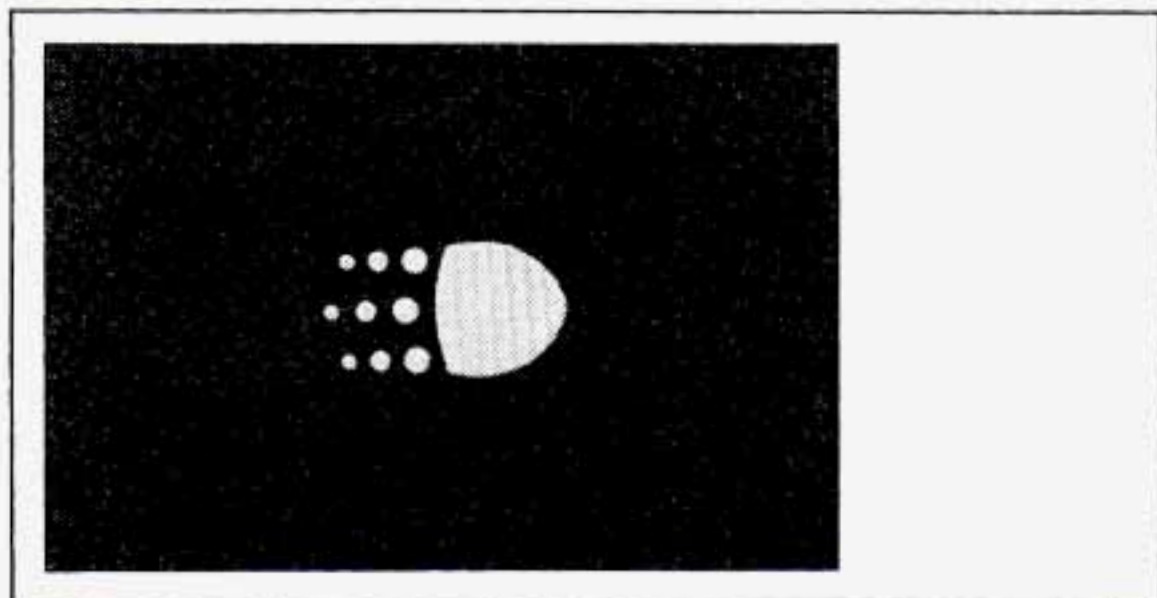

K2318

If your vehicle was first sold, when new, in Canada, you will have this green light on the instrument panel. It will light, just above the speedometer, whenever the Daytime Running Lights are on. For more details about DRL, see "Headlights and Vehicle Lighting" in this section.

## Features & Controls

---

### *SHIFT Indicator Light*

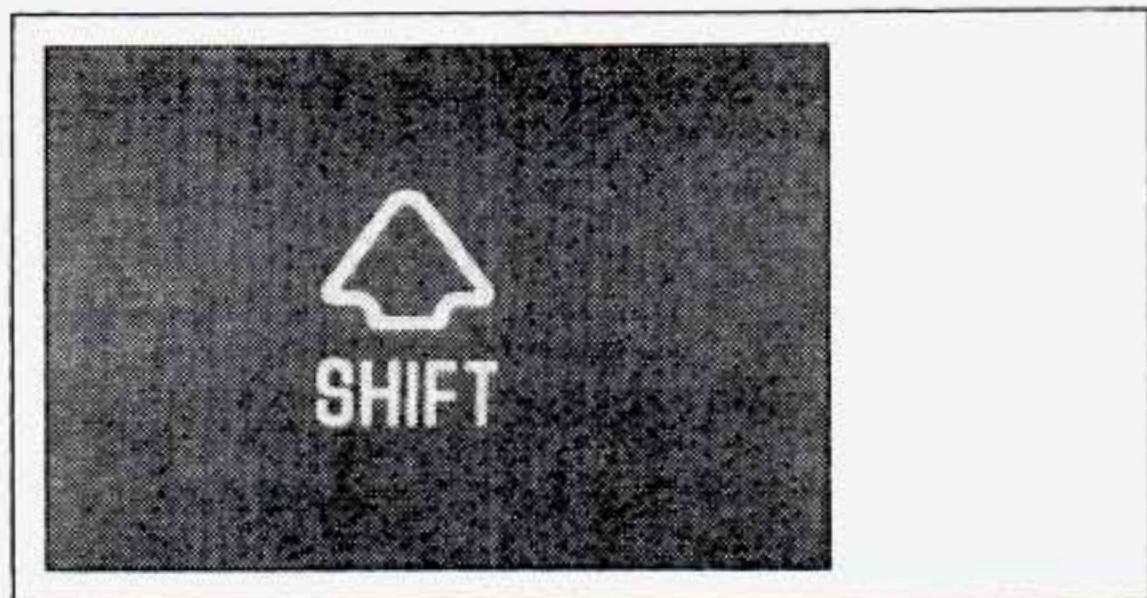

K2317

This light, with the **SHIFT**/arrow symbol, is at the left side of the instrument cluster on some vehicles with manual transmissions. Depending on your particular model, your vehicle may not have this light. The **SHIFT** indicator light will help you get the best fuel economy. See "Shift Light" or "Shift Speeds—Vehicles Without Shift Light" in this section for more information.

### *Headlight High Beam Indicator Light*

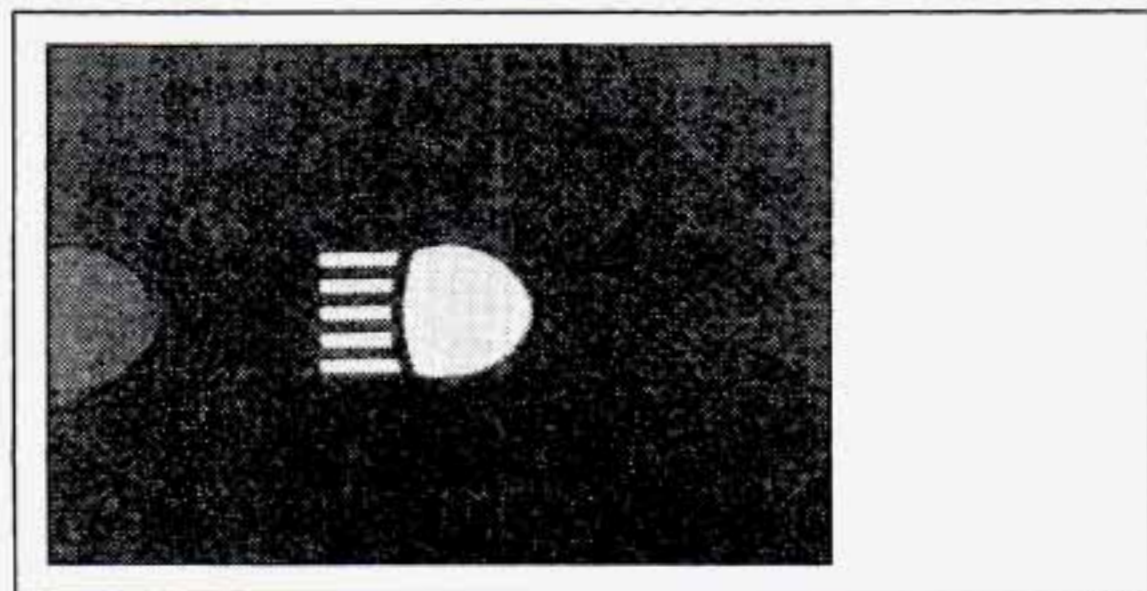

K2331

This light with the blue high beam symbol is on the left side of the instrument cluster. The high beam indicator is on whenever you use your high

---

beam headlights. For more details about high beams, see "Headlight High-Low Beam Changer" earlier in this section.

***Turn Signal and Lane Change Indicator***

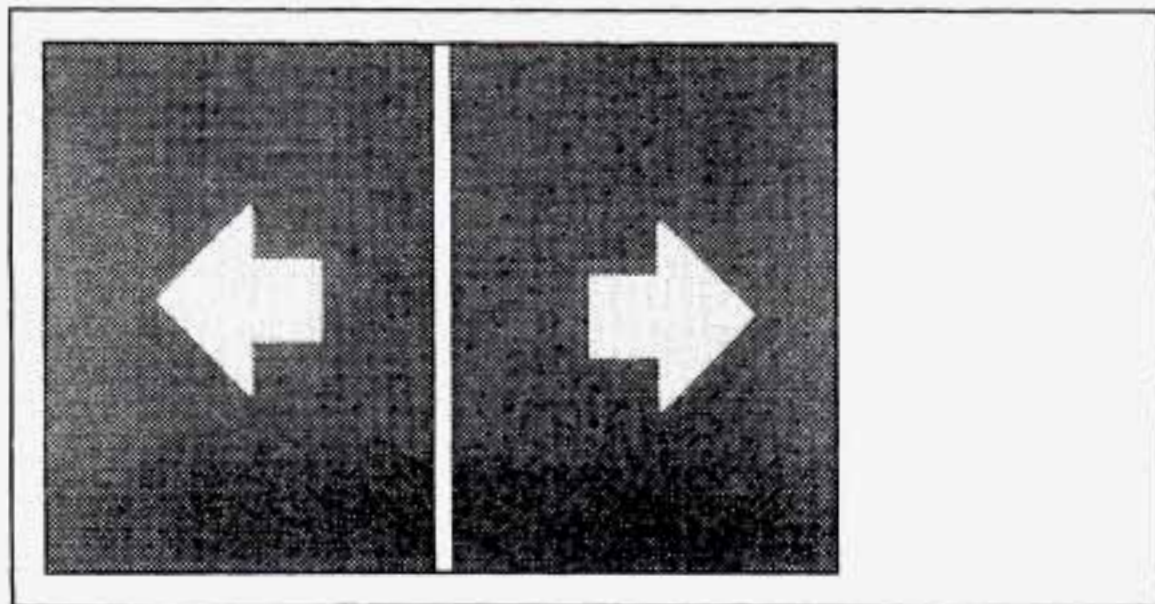

K2444

These lights, with the green arrows, are on each side of the instrument cluster. The signal indicator will come on whenever you signal a turn or lane change. See "Turn and Lane Change Signal" earlier in this section.

# Features & Controls

---

## Gages

### Fuel Gage Standard Cluster

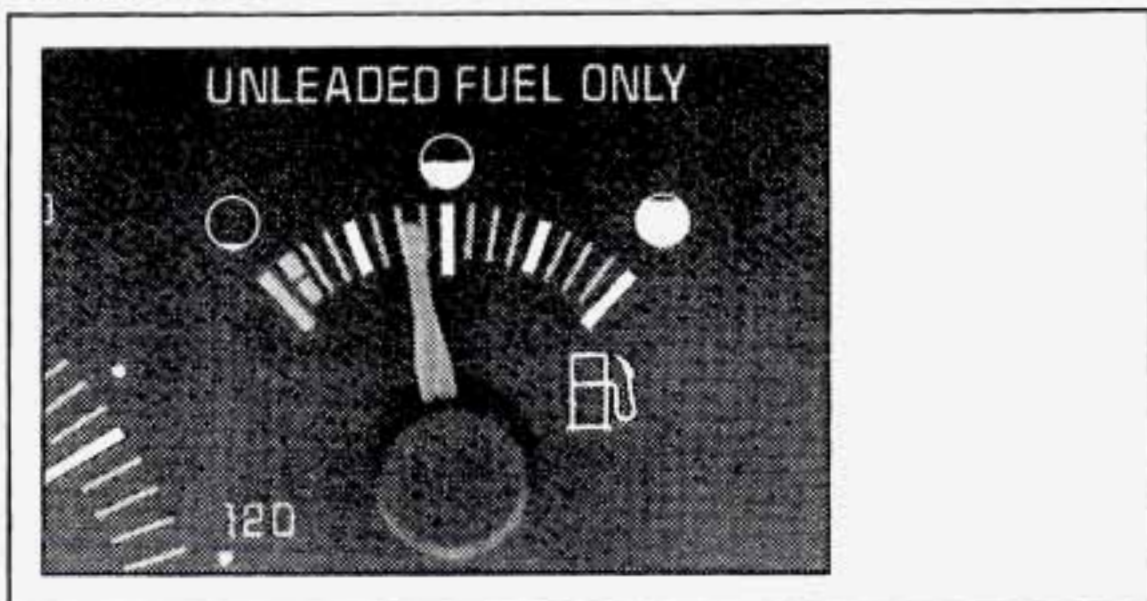

K2114

### Tachometer Cluster

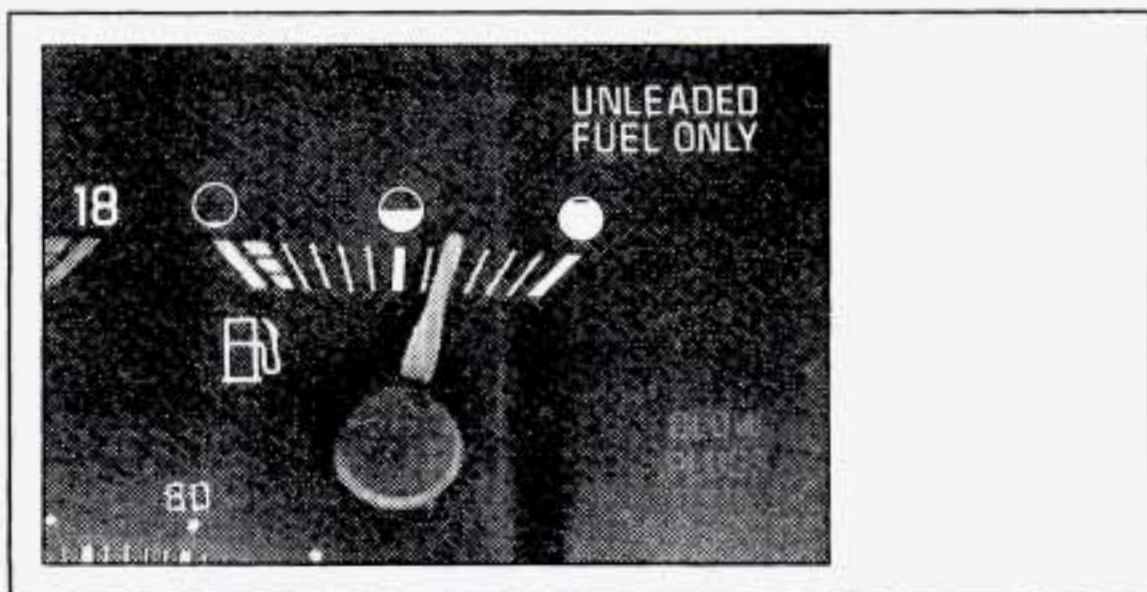

K2115

The fuel gage, when the ignition is on, tells you about how much fuel you have left in your tank. The gage will first indicate empty before you are out of fuel, and you should get more fuel as soon as possible.

---

Listed are four situations you may experience with your fuel gage:

- At the gas station, the fuel pump shuts off before the gage reads full.
- It takes a little more or less fuel to fill up than the fuel gage indicated. For example, the gage may have indicated the tank was half full, but it actually took a little more or less than half the tank's capacity to fill the tank.
- The gage moves a little when you turn a corner or speed up.
- The gage doesn't go back to empty when you turn off the ignition.

None of these indicate a problem with the fuel gage.

For information on how to fill your fuel tank see "Fuel—Filling Your Tank" in the Index.

For your fuel tank capacity, see "Fuel—Tank Capacity" in the Index.

### ***Engine Coolant Temperature Gage***

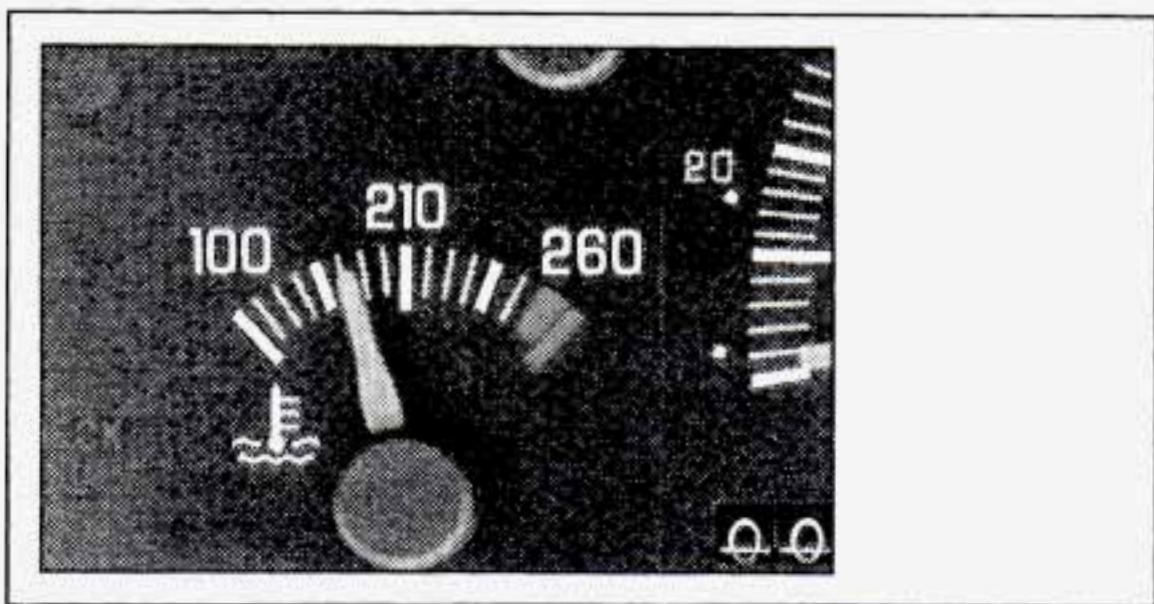

K2334

This gage shows the engine coolant temperature. If the gage pointer moves into the red area, about 260°F (145°C) or more, your engine is too hot! It means that your engine coolant has overheated. If you have been operating your vehicle under normal operating conditions, you should pull off the road, stop your vehicle and turn off the engine as soon as possible.

### ***Hot Coolant Can Burn You Badly!***

In "Problems on the Road", this manual shows what to do. See "Engine Overheating" in the Index.

## Features & Controls

---

### *Oil Pressure Gage Standard Cluster*

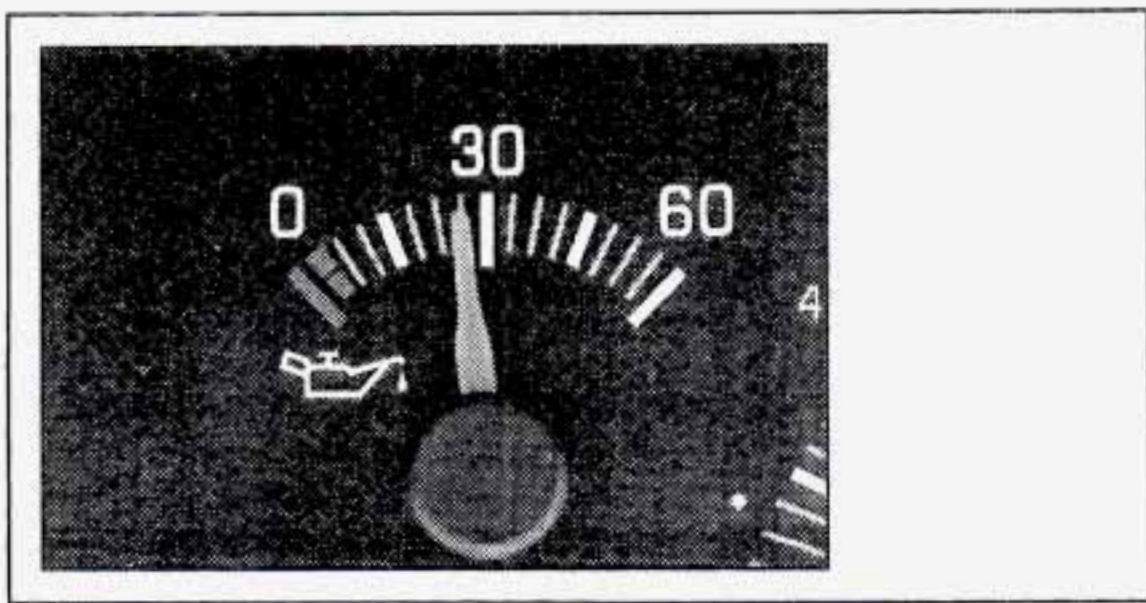

K2116

### *Tachometer Cluster*

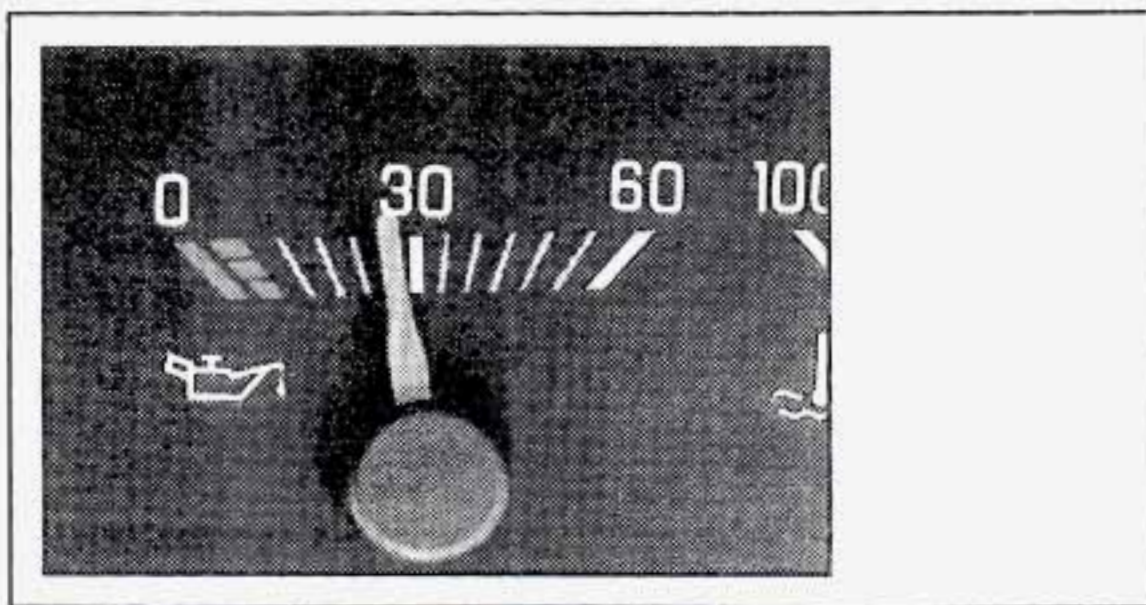

K2117

The oil pressure gage shows the engine oil pressure in psi (pounds per square inch) when the engine is running. Canadian vehicles indicate pressure in kPa (kilopascals). Oil pressure may vary with engine speed, outside temperature and oil viscosity, but readings above the low pressure zone indicate the normal operating range.

A reading in the low pressure zone may be caused by a dangerously low oil level or other problem causing low oil pressure. Check your oil as soon as possible.

## CAUTION



Don't keep driving if the oil pressure is low. If you do, your engine can become so hot that it catches on fire. You or others could be burned. Check your oil as soon as possible and have your vehicle serviced.

## NOTICE

Damage to your engine from neglected oil problems can be costly and is not covered by your warranty.

### *Voltmeter*

*Standard Cluster*

*Tachometer Cluster*

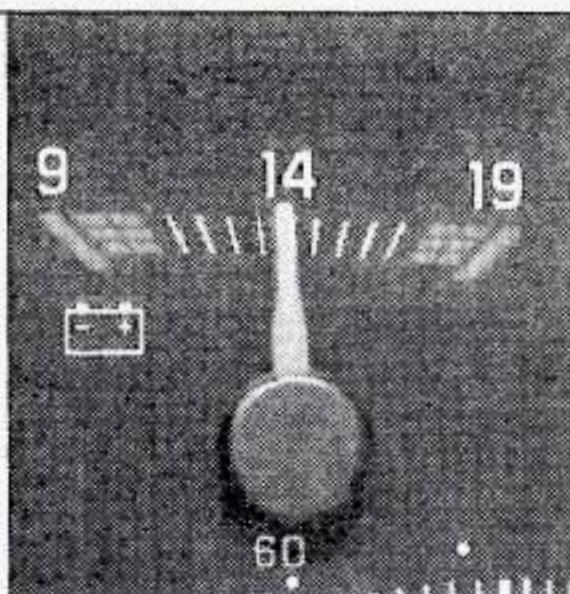
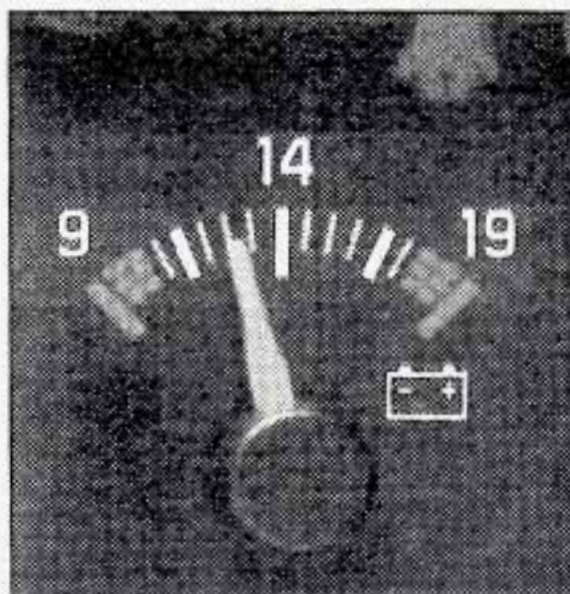

K2336

When your engine is not running, but the ignition is on (in the **Run** position), this gage shows your battery's state of charge in DC volts. When the engine is running, the gage shows the condition of the charging system. Readings between the low and high warning zones indicate the normal operating range.

Readings in either warning zone indicate a possible problem in the electrical system.

## **Features & Controls**

---

You can only drive for a short time with the reading in either warning zone. If you must drive, turn off all unnecessary accessories, and have the vehicle serviced as soon as possible.

### **Convenience Net**

#### **CAUTION**



An improperly stored convenience net could be thrown about the vehicle during a collision or sudden maneuver. You or others could be injured. When you are done using the convenience net, always store it in its original storage pouch, and securely reattach the pouch on the rear side of the spare tire cover.

### **Luggage Carrier**

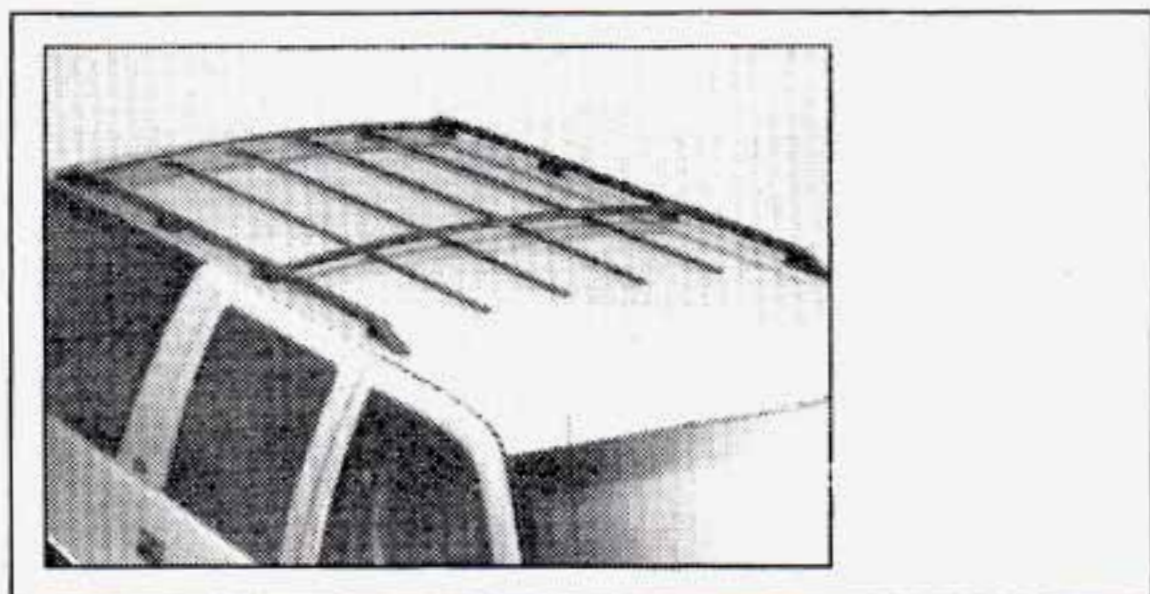

P0225

If you have the optional luggage carrier, you can load things on top of your vehicle. The luggage carrier has slats and side rails attached to the roof, and cross rails which can be moved fore and aft in the side rails to help secure cargo. Tie the load to the side rails or side rail supports. Use the cross rails mostly for fore and aft stops.



## NOTICE

Loading cargo that weighs more than 200 pounds (90.6 kg) on the luggage carrier may damage your vehicle.

When you carry large things, never let them hang over the rear or the sides of your vehicle. Load your cargo so that it rests on the slats and does not scratch or damage the vehicle.

Put the cargo against the side rails and fasten it securely to the luggage carrier. Put the main weight as far forward as you can. Place the main weight over the rear axles.

Don't exceed the maximum vehicle capacity when loading your vehicle. For more information on vehicle capacity and loading, see "Loading Your Vehicle" in the Index.

To prevent damage or loss of cargo as you're driving, check now and then to make sure the luggage carrier and cargo are still securely fastened.

Be sure the cargo is properly loaded.

- If small heavy objects are placed on the roof, place the load in the area over the rear wheels (behind the rear side door on wagon models). If you need to, cut a piece of 3/8 inch plywood to fit inside the cross rails and side rails to spread the load. If plywood is used, tie it to the side rail supports.
- Tie the load to the cross rails or the side rail supports. Use the cross rails only to keep the load from sliding.
- If you need to carry long items, move the cross rails as far apart as they will go. Tie the load to the cross rails and the side rails or side rail supports. Also tie the load to the bumpers. Do not tie the load so tightly that the cross rails or side rails are damaged.
- After moving the cross rails, be sure to tighten all the slider screws.

To reduce wind noise, the cross rails must be installed with the narrow edge toward the front of the vehicle.

Also, the front cross rail should be about 8 inches (200 mm) behind the front anchor on Utility models.

## **Features & Controls**

---

### **Trailer Wiring Harness**

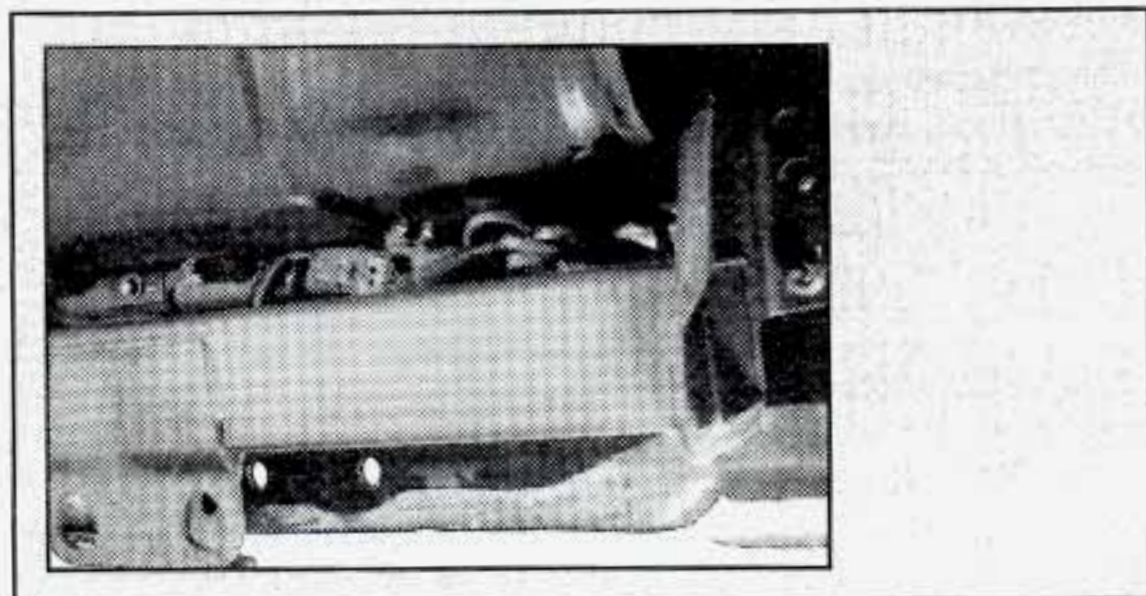

K2373

The 7-wire harness is stored under your vehicle along the rear frame crossmember. The harness has a 30 amp in-line fused battery feed wire and no connector, and should be wired by a qualified electrical service person. Securely attach the harness to the trailer, then tape or strap it to your vehicle's frame rail. Be sure you leave it loose enough so the wiring won't bind or break when turning with the trailer, but not so loose that it drags on the ground.

Store the harness in its original position. Wrap the harness together and tie it neatly so it won't be damaged.

# **Comfort Controls & Audio Systems**

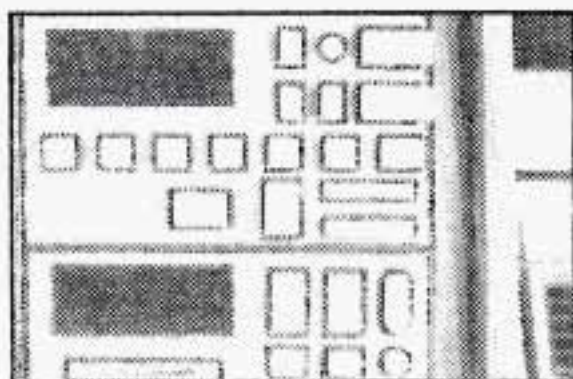

## **Section**

# **3**

In this section you'll find out how to operate the comfort control and audio systems offered with your vehicle. Be sure to read about the particular system supplied with your vehicle.

**For explanation of vehicle symbols in this section, refer to "Vehicle Symbols" in Section 0.**

Comfort Controls .....	3-2
Flow-Through Ventilation System .....	3-2
Heating System.....	3-4
Electronic Heating/Air Conditioning System.....	3-5
Rear Air Conditioning and Heating Systems (Wagon Models) .....	3-8
Rear Window Defogger.....	3-11
Audio Systems.....	3-12
FM Stereo .....	3-12
AM.....	3-12
AM Stereo .....	3-13
How to Operate Your AM ETR <sup>®</sup> Radio .....	3-13
How to Operate Your AM-FM Stereo Audio System and Cassette Player.....	3-14
How to Operate Your AM-FM Stereo Audio System and Cassette Player with Graphic Equalizer.....	3-17
Care of Your Cassette Tape Player.....	3-21
Fixed Mast Antenna .....	3-21

# ***Comfort Controls & Audio Systems***

---

## ***Comfort Controls***

### ***Flow-Through Ventilation System***

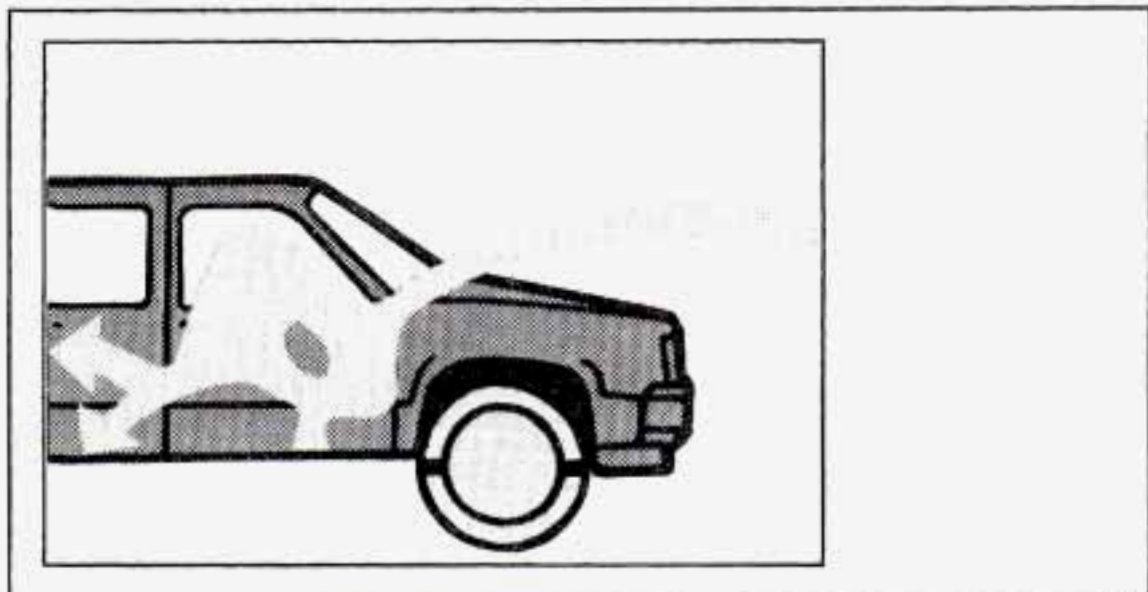

K2190

Your vehicle's flow-through ventilation system supplies outside air to the inside of your vehicle when it is moving. With the side windows closed, air will flow into the front air inlet grilles, through the vehicle and out the rear air exhaust valves. Outside air will also enter the vehicle when the heater or the air conditioning fan is running.

#### ***Ventilation Tips***

- Keep the hood and front air inlet free of ice, snow, or any other obstruction (such as leaves). The heater and defroster will work far better, reducing the chance of fogging the inside of your windows.
- When you enter a vehicle in cold weather, turn the blower fan to **HI** for a few moments before driving off. This helps clear the intake ducts of snow and moisture, and reduces the chance of fogging the inside of your windows.
- Keep the air path under the front seats clear of objects. This helps air to circulate throughout your vehicle.

Your vehicle's flow-through ventilation system supplies outside air to the inside of your vehicle when it is moving. With the side windows closed, air will flow into the front air inlet grilles, through the vehicle and out the rear air exhaust valves. Outside air will also enter the vehicle when the heater or the air conditioning fan is running.

---

## Air Vents

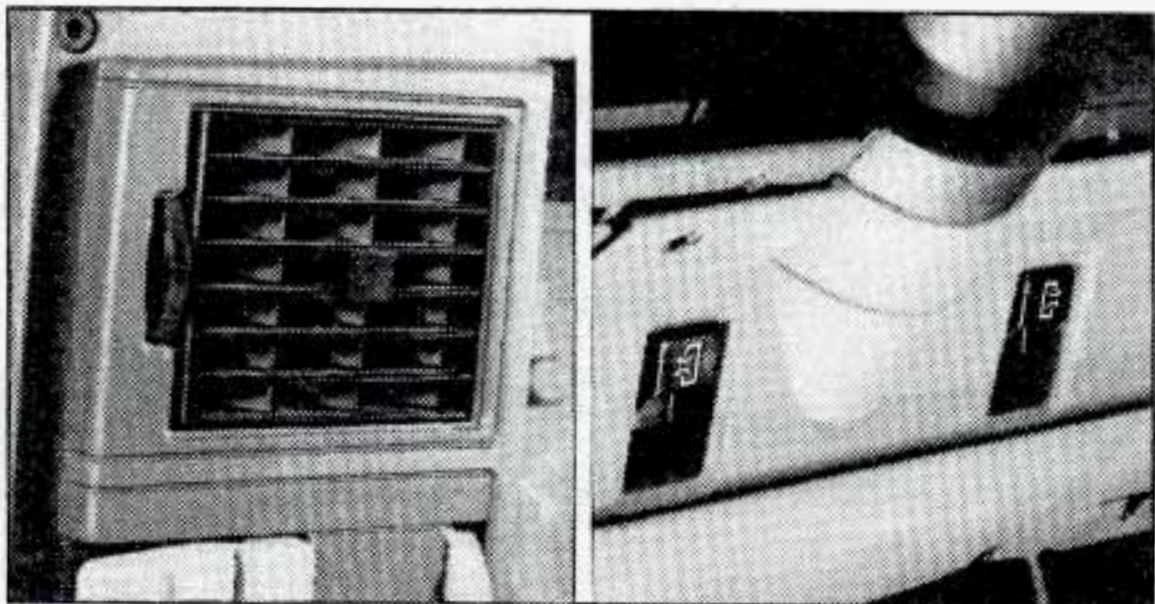

K2315

You will find air vents in the center and on the sides of your instrument panel. You can move the vents to direct the flow of air, or close the vents altogether. When you close a vent, it will increase the flow of air coming out of any vents that are open.

If your vehicle does not have air conditioning, there are air vents below the instrument panel. Each vent has a handle with a vent symbol on it. Use the handle to open and close the vent.

# **Comfort Controls & Audio Systems**

## ***Heating System (Without Air Conditioning)***

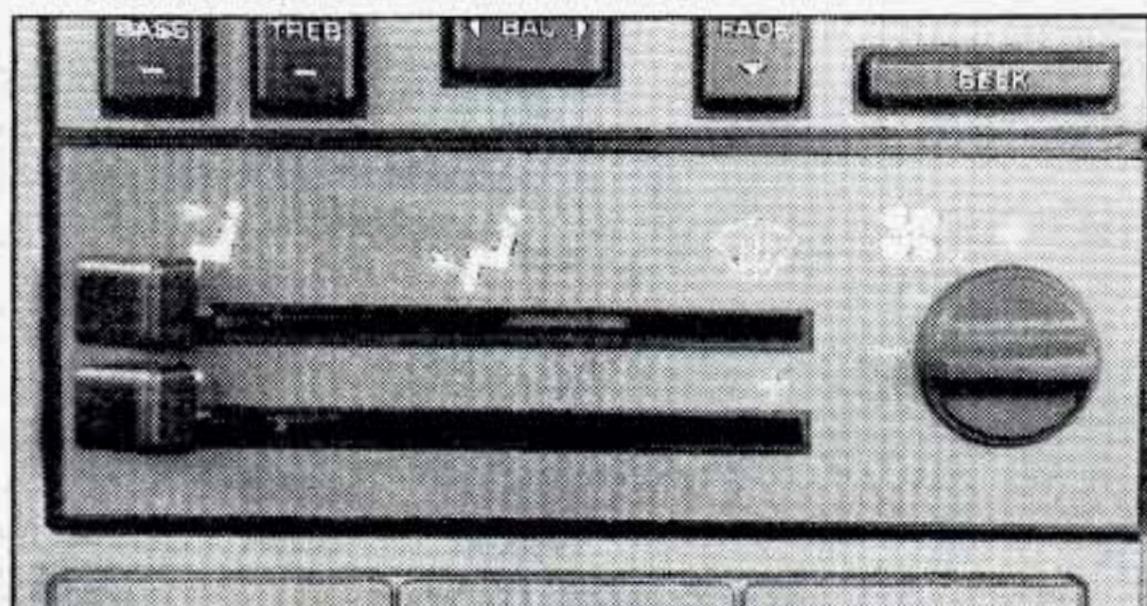

K2441

If your vehicle does not have air conditioning, this is what your heating system will look like.

### ***Fan Knob***

The knob on the right has four positions. To increase the air flow, turn it toward (+). To decrease the air flow, turn it toward (—).

### ***Temperature Lever***

The bottom lever lets you select the temperature of the air flowing into your vehicle. Move the lever right toward (+) for warmer air. Move the lever left toward (—) for cooler air.

### ***Function Lever***

The top lever can be moved to three different heating functions.

**Defrost (Right):** This setting operates the defroster. Heated air comes out near the windshield. Use this when you get fog or ice on the windshield.

**Heater (Center):** Heated air comes out near the floor. This is best for cold weather.

**Vent (Left):** The air comes out at the vents on your instrument panel and at your front side windows.

Placing the lever between positions sends air out both vents.

---

---

## ***Heater Output***

### **Optional Engine Block Heater**

If your engine is equipped with an optional engine block heater, you can use it during initial start-up in cold weather (20°F, -8°C, or lower) to help heat the passenger compartment faster. Because an engine block heater warms the engine coolant, your vehicle's heating system can provide some heat as soon as you start the engine.

The use of an engine block heater also reduces the time it takes for the engine to reach normal operating temperature, and shortens the time it takes the heater to reach full output. For more information, See "Engine Block Heater" in the Index.

## ***Electronic Heating/Air Conditioning System***

### ***Function Display***

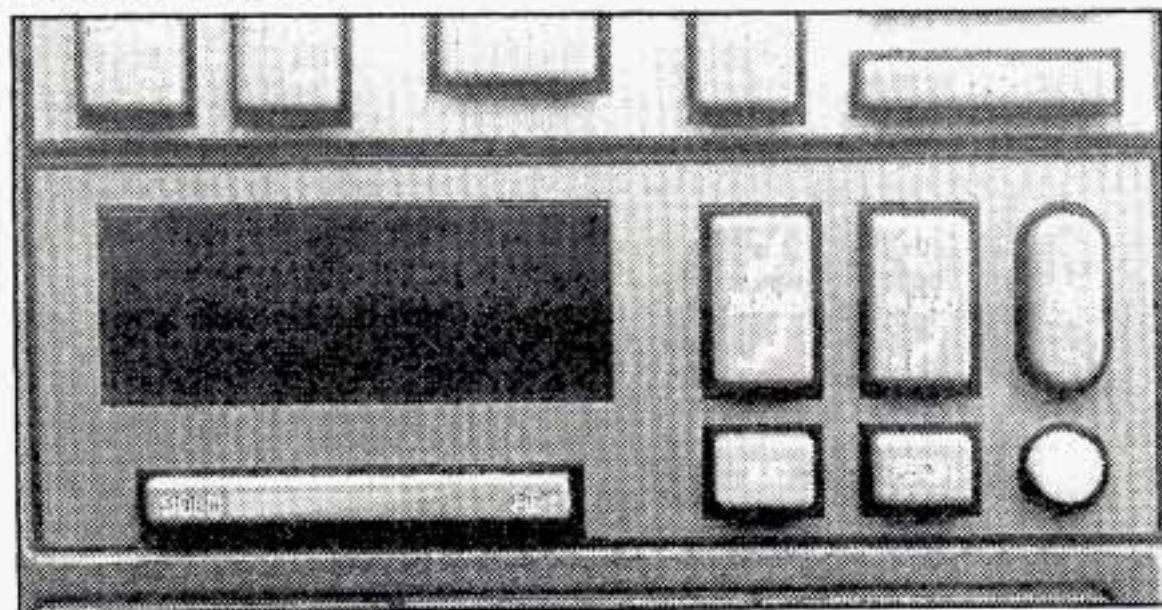

K2305

If your vehicle has air conditioning, your heating/air conditioning system will look like this.

When you first turn on your vehicle's air conditioning, open the windows to clear the vehicle of hot air.

## Comfort Controls & Audio Systems

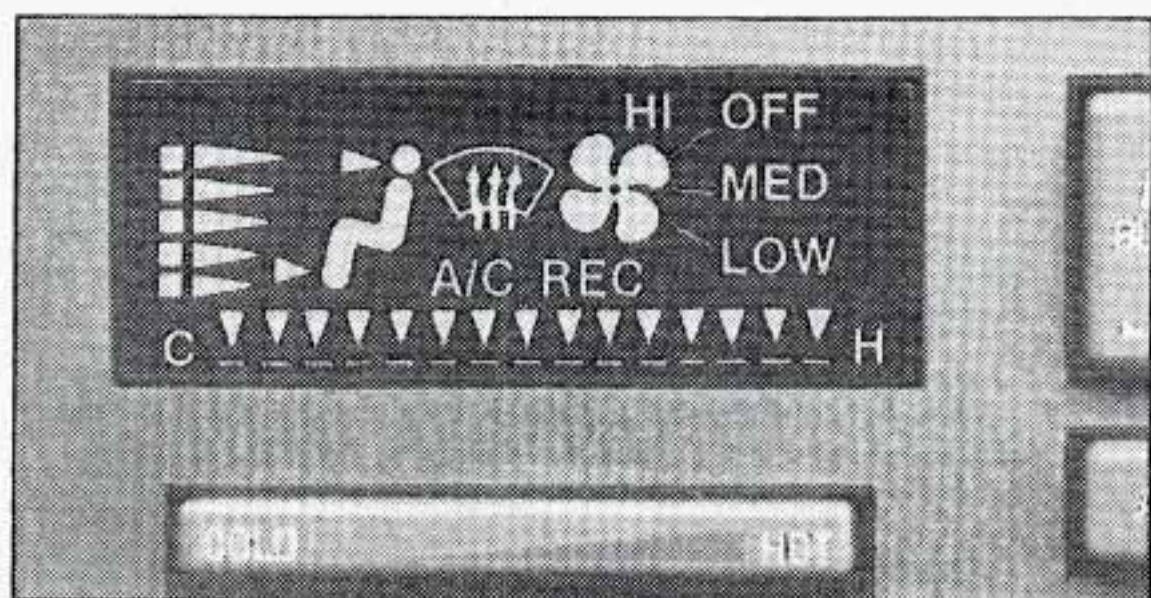

K2313

Your system has a lighted display showing each system when it is operating. During normal operation, all the lights won't come on at the same time. Only the ones displaying the current settings will light.

### **System Controls**

**A/C** Button: Press the button marked **A/C** to turn your air conditioner on and off. The **A/C** symbol will light on your display and air will come out of your dashboard vents. The fan will automatically be set on **LOW**.

When you press the **A/C** button to turn the air conditioner off, the system will operate in the vent mode. When you turn the air conditioner back on, the system will operate in the mode that you last selected unless the **OFF** button was pressed.

**OFF** Button: Press this button to turn the air conditioning/ heating system off. Pressing **OFF** will erase the present mode of operation from the system's memory. Outside air will still come out of the heater outlet whenever the vehicle is moving forward.

If the **OFF** button was pressed, you must press **A/C**, **MAX**, or one of the **BLEND** buttons for the system to come back on.

### **Air Controls (BLEND)**

The two buttons to the right of the system display control the air flow. You can blend the air flow to suit your needs. The amount of blending is shown on the display by an arrow moving between the figure's feet (floor air flow) and head (vent air flow).



---

### ***Right Button***

**Defrost (Top):** Press here to operate the defroster. Heated air comes out near the windshield. You can use it to help clear fog or ice on your windshield.

**Heater (Bottom):** Press here, and heated air comes out near the floor. This setting is best for passenger comfort in cold weather.

The air flow can be blended between the two positions. To blend between positions, press the side of the button showing the area where you would like more air flow. The system will automatically begin to blend toward the position chosen. To stop the system between positions, just press the **SAME** side of the button again.

### ***Left Button***

**Vent (Top):** Press the top of this button and all of the airflow will come through the instrument panel vents.

**Heater (Bottom):** Press the bottom of this button and all of the airflow will come through the floor outlet.

The air flow can be blended between the two positions. To blend between positions, press the side of the switch showing the area where you would like more air flow. The system will automatically begin to blend toward the position chosen. To stop the system between positions, just press the **SAME** side of the button again.

### ***Temperature Selector Bar***

The bar under your system display lets you select the temperature of the air coming into your vehicle. Press **COLD** for cooler air and press **HOT** for warmer air. Release the bar when the system reaches the temperature you want. The temperature is shown on the display by an arrow moving between **C** and **H**.

### ***Fan Control Button***

This button is in the upper right corner of your system control panel. The fan has four settings—low, medium low, medium high and high. Press the top of the button (+) to increase the air flow. Press the bottom of the button (—) to decrease the air flow. The setting you select is shown on your display as **LOW**, **MED LOW**, **MED HI** or **HI**.

### ***Air Recirculation Button***

If you press the **MAX** button (**RECIR** on some models), the air in your vehicle will be recirculated. With the air conditioner on, **MAX** will give you maximum cooling. It can also be used in all modes to help keep dust out of your vehicle. When **MAX** is selected, **REC** will light on your display.

# **Comfort Controls & Audio Systems**

## ***Rear Air Conditioning and Heating Systems (Wagon Models)***

If your vehicle has either or both of these systems, you can increase and decrease the air flow at the rear vents. Depending on the system you have and the setting selected, you can send cooled or heated air to the rear of the vehicle.

### ***Rear Air Conditioning (Without Rear Heater)***

**Front Control**

**Rear Control**

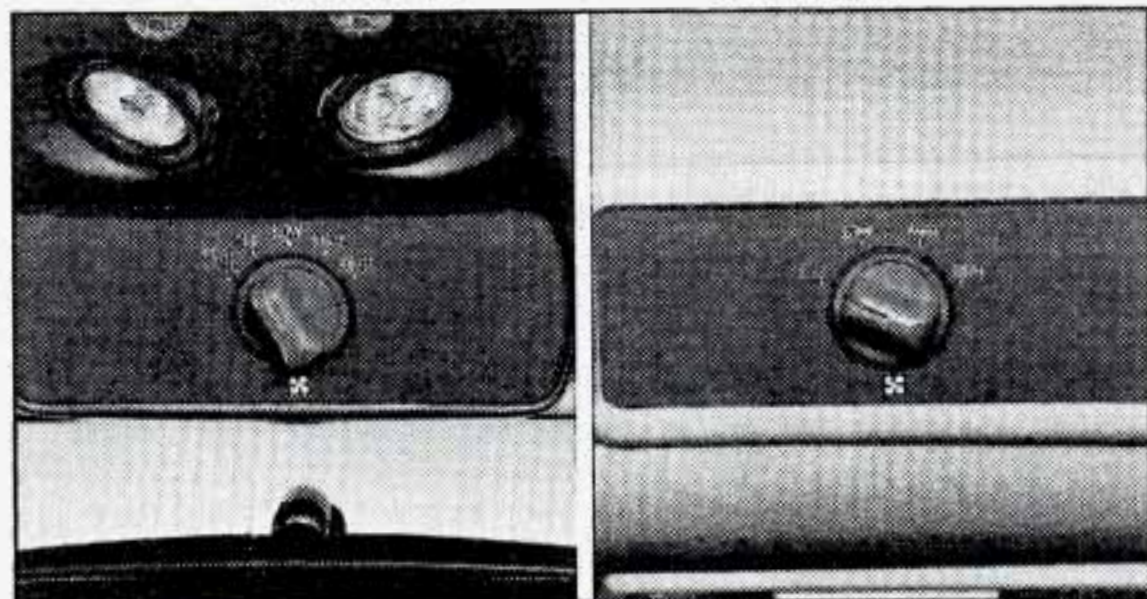

K2478

If your vehicle has rear air conditioning (without rear heater), the controls are located above the front and second seats. The front and rear overhead controls let you increase and decrease the air flow at the rear vents.

To operate the rear air conditioning system, the front air conditioning system must be on. With the front air conditioning system off, the rear system controls can be used to circulate air in the rear of the vehicle.

To operate the rear system using the front control, just turn the knob to blower position you want.

To use the rear control, first turn the front control knob to **REAR CNTL.** Then, the rear control can be used to increase and decrease the air flow.

## ***Rear Heater (Without Rear Air Conditioning)***

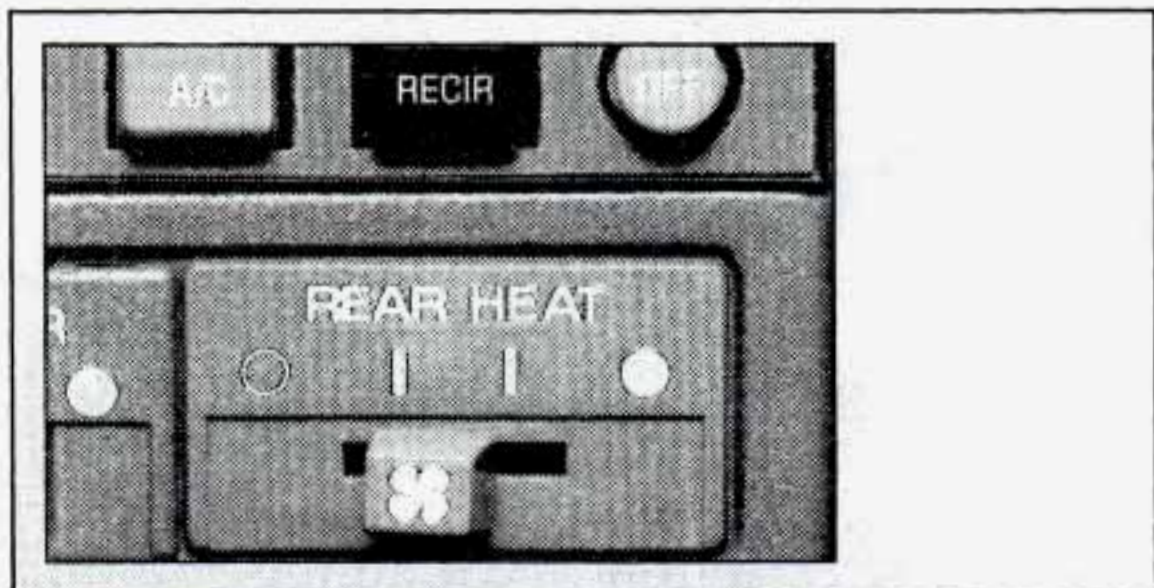

K2172

If you have a rear heater (without rear air conditioning), the control switch is located on the instrument panel. To increase and decrease the flow of heated air to the rear floor vents, move the switch with the fan symbol on it to the blower speed you want.

Move the switch all the way to the left position to turn the rear blower off, and each position to the right increases the flow of heated air.

Move the switch all the way to the right position to turn the blower on high, providing maximum flow of heated air.

# Comfort Controls & Audio Systems

---

## Rear Air Conditioning and Rear Heater

Front Control

Rear Control

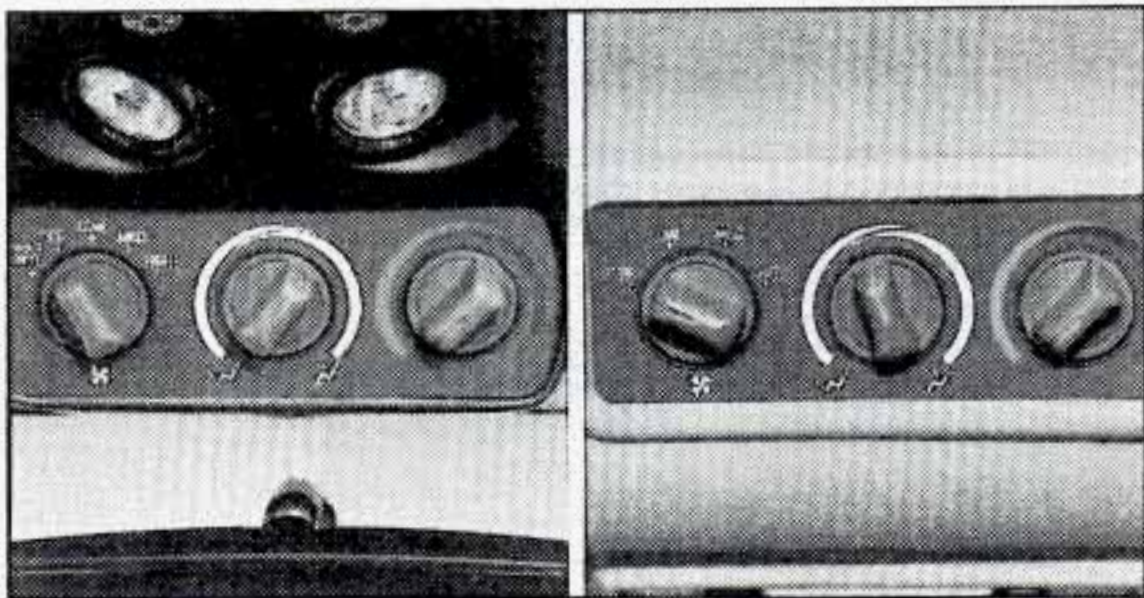

K2479

If your vehicle has a rear air conditioning and rear heater system combination, controls are provided to regulate the temperature, location and speed of the air flow.

To adjust the air temperature, turn the temperature knob on the right side of the control panel. For warmer air turn the knob to the right (red) side, and for cooler air, turn the knob to the left (blue) side.

To regulate the air flow location, adjust the center knob on the control panel. Turn the knob toward the left for floor vent air flow or toward the right for headliner vent air flow. Generally, the upper vents are used for air conditioning and the floor vents for heating; however, the control knob may be set to allow any desired blend of air flow.

To adjust the air flow speed, turn the fan control knob on the left side of the control panel to the desired blower setting.

To activate the rear control, move the fan knob on the front control to **REAR CNTL**. This will allow second seat passengers to adjust the controls as they desire.

---

## Rear Window Defogger



K2112

You can tell if your vehicle has this option by looking at the rear window. If you see lines running across the glass, you have it. These are the wires which heat your window.

### NOTICE

Scraping the inside of your rear window could cut and damage the defogger. Your warranty would not cover this damage. And don't put decals there. you might have to scrape them off.

For best results, clear the window of as much snow or ice as possible first.

To turn on the rear window defogger, find the switch marked **REAR DEFOG** on your instrument panel, just below the heater system. Press the right side of the switch, with the defog symbol on it, until the light in the switch comes on, then release it. The rear window defogger will only work if the ignition switch is turned to **RUN**.

You can turn the defogger off at any time by pressing the left, lighted side of the switch. The defogger will shut itself off after several minutes, so that the glass does not get too hot. If the defogger shuts off, and the window still isn't clear, turn the defogger on again.

# ***Comfort Controls & Audio Systems***

## **Audio Systems**

Your Delco<sup>®</sup> audio system has been designed to operate easily and give years of listening pleasure. But you will get the most enjoyment out of it, if you acquaint yourself with it first. Find out what your Delco<sup>®</sup> system can do and how to operate all its controls, to be sure you're getting the most out of the advanced engineering that went into it.

### **CAUTION**



Hearing damage from loud noise is almost undetectable until it is too late. Your hearing can adapt to higher volumes of sound. Sound that seems normal can be loud and harmful to your hearing. Take precautions by adjusting the volume control on your radio to a safe sound level before hearing adapts to it.

To help avoid hearing loss or damage:

- Adjust the volume control to the lowest setting.
- Increase volume slowly until you hear comfortably and clearly.

### **NOTICE**

Before you add any sound equipment to your vehicle—like a tape player, CB radio, mobile telephone or two-way radio—be sure you can add what you want. If you can, it's very important to do it properly. Added sound equipment may interfere with the operation of your vehicle's engine, Delco<sup>®</sup> radio or other systems, and even damage them. And, your vehicle's systems may interfere with the operation of sound equipment that has been added improperly.

So, before adding sound equipment, check with your dealer.

Be sure to check Federal rules covering mobile radio and telephone units.

### **FM Stereo**

FM stereo will give you the best sound. But FM signals will reach only about 10 to 40 miles (16 to 65 km). And, tall buildings or hills can interfere with FM signals, causing the sound to come and go.

### **AM**

The range for most AM stations is greater than for FM, especially at night. The longer range, however, can cause stations to interfere with each other. AM can pick up noise from things like electrical storms and power lines. If the noise interferes with your listening, try reducing the treble to lessen the noise.

---

---

## **AM Stereo**

This means the Delco® system can receive C-QUAM® stereo broadcasts. Many AM stations around the country use C-QUAM® to produce stereo, though some do not. (C-QUAM® is a registered trademark of Motorola, Inc.). If your Delco® system can get C-QUAM®, your "STEREO" light will come on when you're receiving it.

## **How to Operate Your AM ETR® Radio**



K2186

### **To Play the Radio**

Press the **PWR-VOL-TONE** knob to switch the radio on and off. This knob does two other things:

- It controls the volume. The **VOL** knob increases the volume when rotated clockwise.
- The knob behind the **PWR-VOL** knob is the **TONE** knob. Rotate this knob counterclockwise for more bass and clockwise for more treble.

### **TUNE Button**

Press the side of the button with the down arrow to decrease the radio frequency or the side of the switch with the up arrow to increase the radio frequency.

### **RCL Button**

When the ignition is off, press the **RCL** button to display the time. With the ignition in **RUN** or **ACC**, press it to recall the station frequency when the time is showing.

# **Comfort Controls & Audio Systems**

## **Pushbuttons**

The five pushbuttons let you return to favorite stations. Just:

- Tune in the station you want.
- Press the **SET** button. (**SET** appears in the VF display for a few seconds).
- Within 5 seconds, press one of the five pushbuttons to store the station. Whenever you press that button, the preset station will return.

## **How to Operate Your AM-FM Stereo Audio System and Cassette Deck**



P0200

### **To Play the Radio**

Press the amber **PWR** button to switch the radio on and off.

### **VOL**

Controls the volume. Pressing (+) increases volume; (—) decreases volume.

### **RCL**

When the ignition is off, press the **RCL** button to display the time. With the ignition on, press **RCL** to recall the station frequency and volume setting when the time is showing.

### **BAL/FADE**

To balance and fade the sound between the right/left or front/rear speakers, use the four buttons with the speaker symbols on them. Press the left and right buttons to adjust the left and right speaker balance. Pressing the top



---

---

and bottom buttons adjusts the front and rear speaker volume, or fade. The relative balance and fade adjustments are shown on the VF display.

### **TUNE**

Press the (+) to increase frequency and (—) to decrease frequency.

### **AM/FM**

Push to get AM or FM.

### **SEEK**

Press the **SEEK** button to make the receiver seek, and stop at, the next higher available station.

### **SCAN**

Press the **SCAN** button to make the receiver scan, and momentarily pause at, all available stations. **SCAN** will appear in the VF display while the receiver is in the scan mode. Press **SCAN** again to cancel the scan mode and hold the current station.

### **Pushbuttons**

The six pushbuttons let you return to favorite stations. You can set the pushbuttons for up to twelve favorite stations (6 AM and 6 FM). To set the pushbuttons, just:

- Tune in the station you want.
- Press the **SET** button. (**SET** appears in the VF display for a few seconds.)
- Within 5 seconds, push one of the six pushbuttons to store the station. After that, whenever you press that button, the preset station will return.

### **Clock**

To set the clock, just:

- Press the **SET** button. The word **SET** will light up in the VF display.
- Within 5 seconds, press and hold the **SEEK** button until the correct hour appears on the display.
- Then, press and hold the **SCAN** button until the correct minute appears on the display.
- After you set the time, the word **SET** will remain in the VF display for a few seconds.

### **TREBLE**

Push (+) to hear more treble.

Push (—) to hear less treble.

## ***Comfort Controls & Audio Systems***

---

### ***BASS***

Push (+) to hear more bass.

Push (—) to hear less bass.

Adjust these buttons to give a pleasing sound. If a station is weak and noisy, just reduce **TREB** to lessen interference.

### ***Cassette Deck***

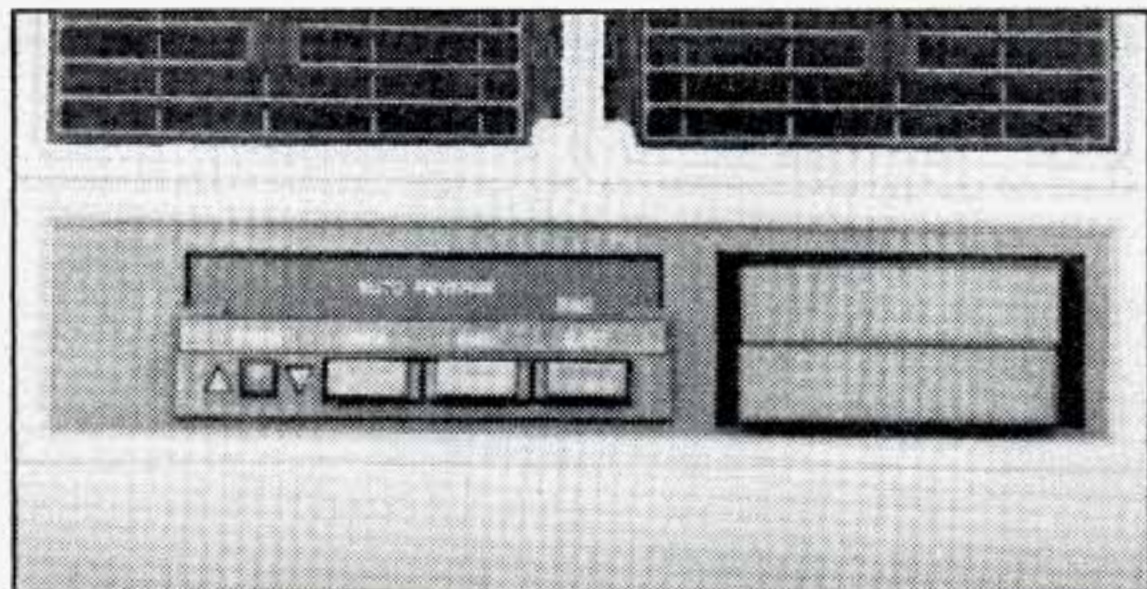

K2310

If you have a cassette deck, it is built to work best with tapes that are 30 to 45 minutes long on each side. Tapes longer than that are so thin that they may not work well in this player.

Once the tape is playing, use the radio control knobs for volume, balance and fade, just as you do for the radio. The arrows on the player indicate which side of the tape is being played.

### ***REV***

To rapidly reverse the tape, press **REV**. The tape will rapidly reverse until you press the **FWD** button lightly.

### ***FWD***

To rapidly advance the tape, press **FWD**. The tape will rapidly advance until you press the **REV** button lightly.

### ***PROG***

To go from one side of the tape to the other, press the **PROG** button. Observe the lighted arrows to determine which side of the tape is being played.

---

If a tape is inserted with side "1" (or "A") up, then the up arrow means that that side is being played. Likewise, a down arrow would indicate that side "2" (or "B") had been selected. The player will automatically switch to the other side of the tape when the first side ends.

### **EJECT**

To remove the tape or stop the tape and switch to radio, press the **EJCT** button.

## **How to Operate Your AM-FM Stereo Audio System and Cassette Deck with Equalizer**

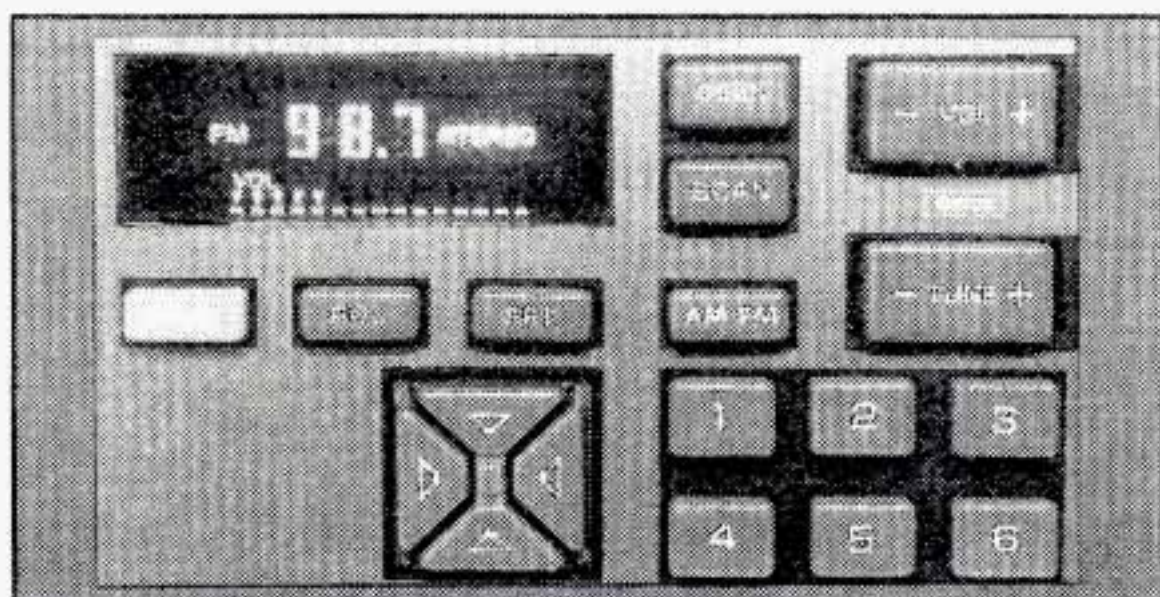

P0199

### **To Play the Radio**

Press the amber **PWR** button to switch the radio on and off.

### **VOL**

Controls the volume. Pressing (+) increases volume; (—) decreases volume.

### **RCL**

When the ignition is off, press the **RCL** button to display the time. With the ignition on, press **RCL** to recall the station frequency and volume setting when the time is showing.

### **BAL/FADE**

To balance and fade the sound between the right/left or front/rear speakers, use the four buttons with the speaker symbols on them. Press the left and right buttons to adjust the left and right speaker balance. Pressing the top and bottom buttons adjusts the front and rear speaker volume, or fade. The relative balance and fade adjustments are shown on the VF display.

# ***Comfort Controls & Audio Systems***

---

## ***TUNE***

To tune in radio stations, push the (+) to increase frequency and (—) to decrease frequency.

## ***AM/FM***

Push to get AM or FM.

## ***SEEK***

Press the **SEEK** button to make the receiver seek, and stop at, the next higher available station.

## ***SCAN***

Press the **SCAN** button to make the receiver scan, and momentarily pause at, all available stations. **SCAN** will appear in the VF display while the receiver is in the scan mode. Press **SCAN** again to cancel the scan mode and hold the current station.

## ***Pushbuttons***

The six pushbuttons let you return to favorite stations. You can set the pushbuttons for up to twelve favorite stations (6 AM and 6 FM). To set the pushbuttons, just:

- Tune in the station you want.
- Press the **SET** button. (**SET** appears in the VF display for a few seconds.)
- Within 5 seconds, push one of the six pushbuttons to store the station. After that, whenever you press that button, the preset station will return.

## ***Clock***

To set the clock, just:

- Press the **SET** button. The word **SET** will light up in the VF display.
- Within 5 seconds, press and hold the **SEEK** button until the correct hour appears on the display.
- Then, press and hold the **SCAN** button until the correct minute appears on the display.
- After you set the time, the word **SET** will remain in the VF display for a few seconds.

## ***Tone***

To adjust the tone of this radio combination, see the instructions for the graphic equalizer tape deck.

## **AmSt**

The **AmSt** button is just below the **PWR** button. Push this when you tune to an AM station that broadcasts in stereo. Your **STEREO** light will come on when you're receiving AM stereo. If you push **AmSt** and there is no more noise, it means the station is weak. You'll hear the station better if you don't use **AmSt**. Just push the **AmSt** button again to cancel stereo.

NOTE: Your Delco system may be able to receive C-QUAM<sup>®</sup> stereo broadcasts. Many AM stations around the country use C-QUAM<sup>®</sup> to produce stereo, though some do not. C-QUAM<sup>®</sup> is a registered trademark of Motorola Inc. If your Delco system can get C-QUAM<sup>®</sup> signals, your **STEREO** light will come on when you are receiving stereo.

## **Cassette Deck with Graphic Equalizer**

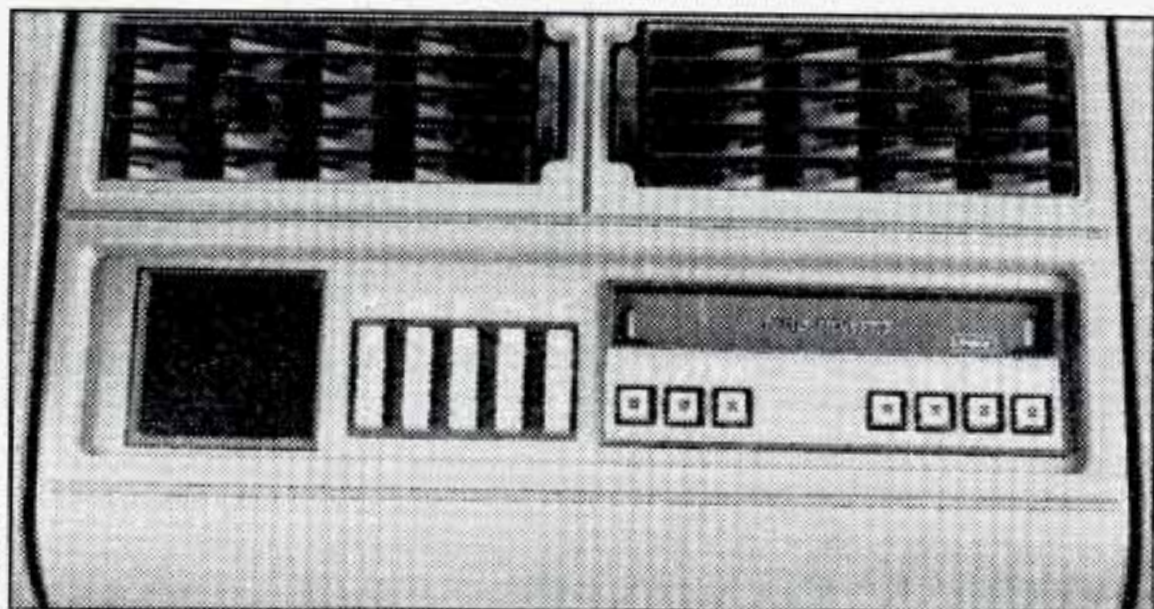

K2311

Press the **PWR** button on the radio to turn the unit on. The radio will play until a cassette is pushed into the cassette entry door (the tape side goes in first.) The cassette deck is built to work best with tapes that are 30 to 45 minutes long on each side. Tapes longer than that are so thin that they may not work well in this player.

Once the tape is playing, use the **VOL**, **BAL** and **FADE** controls on the radio. The arrows indicate which side of the tape is being played.

## **Equalizer**

Boost the bass, emphasize a voice in a song, brighten the treble—your equalizer enables you to adjust five separate sound frequencies to your individual taste.

## ***Comfort Controls & Audio Systems***

---

Press (+) to emphasize a frequency, press (—) to de-emphasize it. It's best to begin with all the controls in the middle position, then adjust each control as you like. Observe the VF display for relative emphasis.

### ***CrO2***

This button sets tape bias. When playing high bias chrome or metal tapes, press **CrO2** (the light in the button will come on). When playing standard tapes, press the button again (the light will go out).

### ***PROG***

To go from one side of the tape to the other, press the **PROG** button. Observe the lighted arrows to determine which side of the tape is being played.

If a tape is inserted with side "1" (or "A") up, then the up arrow means that that side is being played. Likewise, a down arrow would indicate that side "2" (or "B") had been selected. The player will automatically switch to the other side of the tape when the first side ends.

### ***EJECT***

Press **EJECT** to eject the cassette tape from the player (the radio will then play.)

### ***FWD***

To rapidly advance the tape, press **FWD**. The light in the button will be lit and the tape will rapidly advance until you press the **REV** button lightly.

### ***SEEK***

To search for the next selection on the tape, forward or back, press **SEEK** (the light in the **SEEK** button will be lit) and either **FWD** or **REV**. For the seek mode to stop, there must be at least a 4-second gap between selections on the tape.

### ***REV***

To rapidly reverse the tape, press **REV**. The light in the button will be lit and the tape will rapidly reverse until you press the **FWD** button lightly.

### ***REPT***

Press **REPT** to repeat the currently playing selection on the tape. For the repeat to stop, there must be at least a 4-second gap between selections.

---

## ***Care of Your Cassette Tape Player***

A tape player that is not cleaned regularly can cause reduced sound quality, ruined cassettes, or a damaged mechanism. Cassette tapes should be stored in their cases away from contaminants, direct sunlight, and extreme heat. If they aren't, they may not operate properly or cause failure of the tape player.

Your tape player should be cleaned regularly each month or after 15 hours of use. If you notice a reduction in sound quality, try a known good cassette to see if the tape or the player is at fault. If this other cassette has no improvement in sound quality, clean the tape player.

Clean your tape player with a wiping-action, non abrasive cleaning cassette, and follow the directions provided with it.

Cassettes are subject to wear and the sound quality may degrade over time. Always make sure that the cassette tape is in good condition before you have your tape player serviced.



K1313

## ***Fixed Mast Antenna***

The fixed mast antenna can withstand most car washes without being damaged. If the mast should ever become slightly bent, you can straighten it out by hand. If the mast is badly bent, as it might be by vandals, you should replace it.

Check every once in a while to be sure the mast is still tightened to the fender.



THE UNIVERSITY OF CHICAGO

PHYSICS DEPARTMENT

1952

PHYSICS 551

PROBLEM SET 1

1952

PHYSICS 551

PROBLEM SET 1

1952

PHYSICS 551

PROBLEM SET 1



# ***Your Driving and the Road***



## ***Section***

Here you'll find information about driving different kinds of roads and in varying weather conditions. We've also included many other useful tips on driving.

Road Signs .....	4-2
Defensive Driving .....	4-9
Drunken Driving .....	4-10
Control of a Vehicle .....	4-13
Braking .....	4-13
Steering .....	4-18
Steering in Emergencies .....	4-19
Passing .....	4-21
Loss of Control .....	4-23
Driving Guidelines (Utility Models) .....	4-24
Off-Road Driving With Your Four-Wheel Drive Vehicle .....	4-24
Driving at Night .....	4-35
Driving in the Rain .....	4-37
Driving in Fog, Mist and Haze .....	4-40
City Driving .....	4-42
Freeway Driving .....	4-43
Driving a Long Distance .....	4-44
Hill and Mountain Roads .....	4-47
Parking on Hills .....	4-49
Winter Driving .....	4-53
Towing a Trailer .....	4-56
Power Winches .....	4-64

# ***Your Driving and the Road***

---

## **Road Signs**

The road signs you see everywhere are coded by color, shape and symbol. It's a good idea to know these codes so that you can quickly grasp the basic meaning or intent of the sign even before you have a chance to read it.

### **Color of Road Signs**

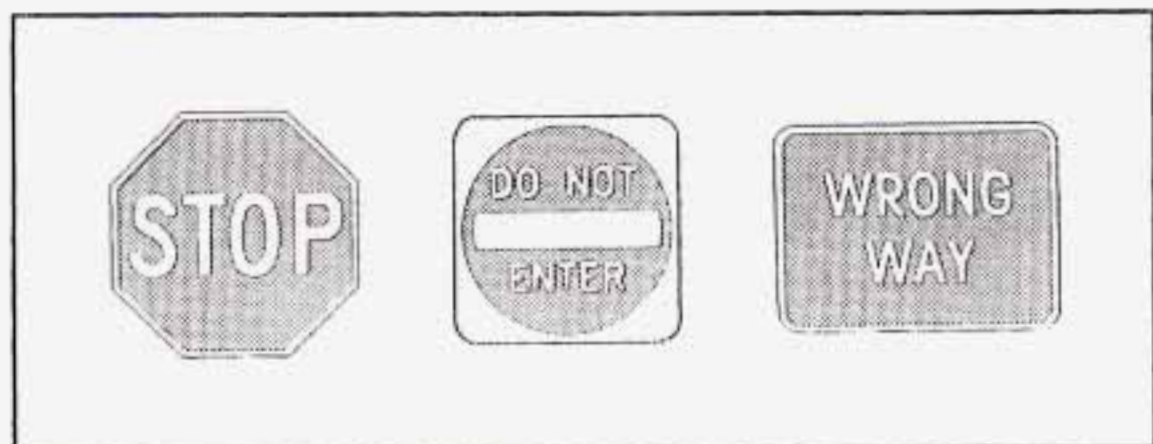

AM402001

**RED** means **STOP**. It may also indicate that some movement is not allowed. Examples are **DO NOT ENTER** and **WRONG WAY**.

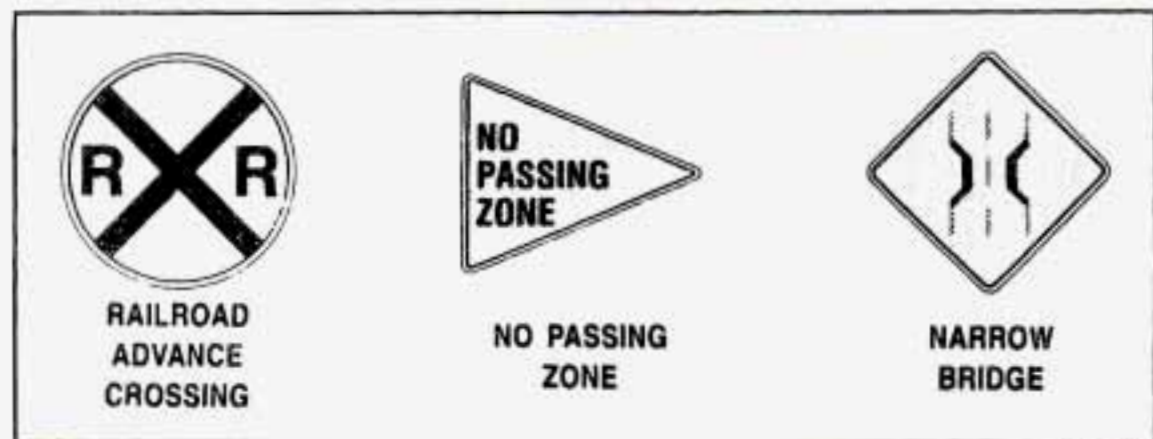

AM402002

**YELLOW** indicates a general warning. Slow down and be careful when you see a yellow sign. It may signal a railroad crossing ahead, a no passing zone, or some other potentially dangerous situation. Likewise, a yellow solid line painted on the road means "Don't Cross."



**LOW  
SHOULDER**



**WORKERS  
AHEAD**



**FLAGGER  
AHEAD**

AM402003

**ORANGE** indicates road construction or maintenance. You'll want to slow down when you see an orange sign, as part of the road may be closed off or torn up. And there may be workers and maintenance vehicles around, too.



AM402004

**GREEN** is used to guide the driver. Green signs may indicate upcoming freeway exits or show the direction you should turn to reach a particular place.



**HOSPITAL**



**INFORMATION**

AM402005

**BLUE** signs with white letters show motorists' services.

## ***Your Driving and the Road***

---



**CANOEING**



**SWIMMING**

AM402006

**BROWN** signs point out recreation areas or points of historic or cultural interest.

### ***Shape of Road Signs***

The shape of the sign will tell you something, too.



AM402007

An **OCTAGONAL** (eight-sided) sign means **STOP**. It is always red with white letters.



AM402008

A DIAMOND-shaped sign is a warning of something ahead—for example, the end of a divided highway, a curve, steep hill, soft shoulder, or a narrow bridge.



AM402009

A TRIANGLE pointed downward, indicates YIELD. It assigns the right-of-way to traffic on certain approaches to an intersection.



AM402010

A TRIANGULAR sign also is used on two-lane roads to indicate a NO PASSING ZONE. This sign will be on the left side of the roadway.

## ***Your Driving and the Road***

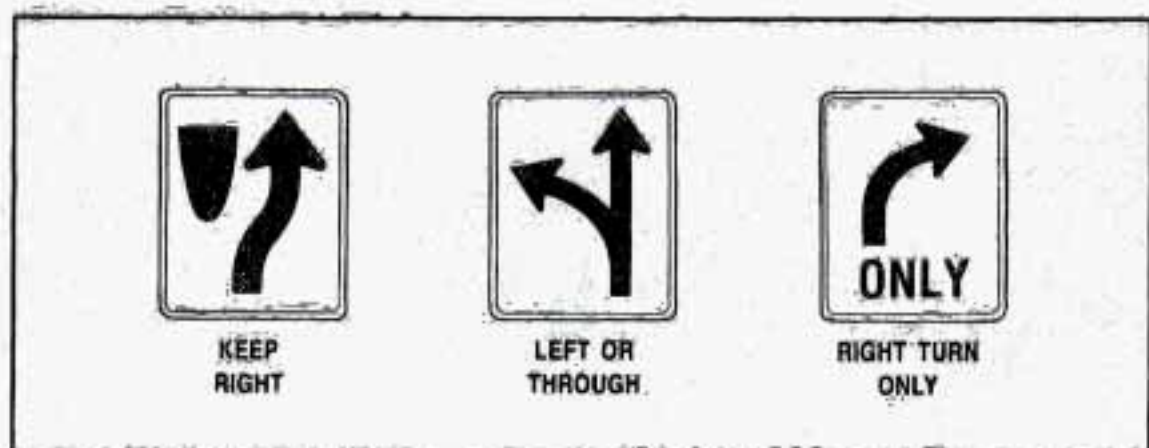

AM402011

RECTANGULAR (square or oblong) signs show speed limits, parking regulations, give directions, and such information as distances to cities.

### ***Symbols on Road Signs***

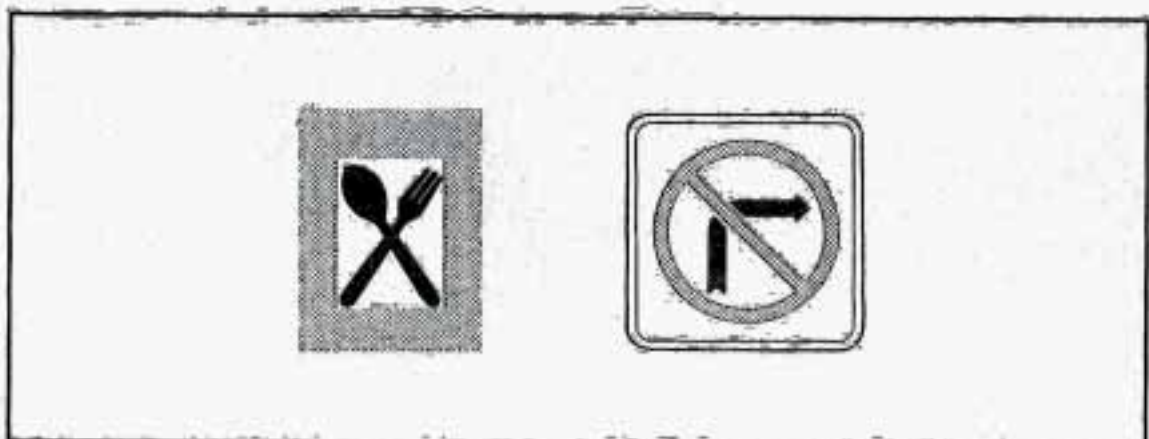

AM402012

There are many international road signs in use today.

The basic message of many of these signs is in pictures or graphic symbols. A picture within a circle with a diagonal line across it shows what **NOT** to do.



AM402013

---

## Traffic Lights



AM402014

We're all familiar with traffic lights or stop lights. Often green arrows are being used in the lights for improved traffic control. On some multilane roads, green arrows light up, indicating that traffic in one or more lanes can move or make a turn. Green arrows don't mean "go no matter what." You'll still need to proceed with caution, yielding the right of way to pedestrians and sometimes to other vehicles.

Some traffic lights also use red arrows to signify that you must stop before turning on red.

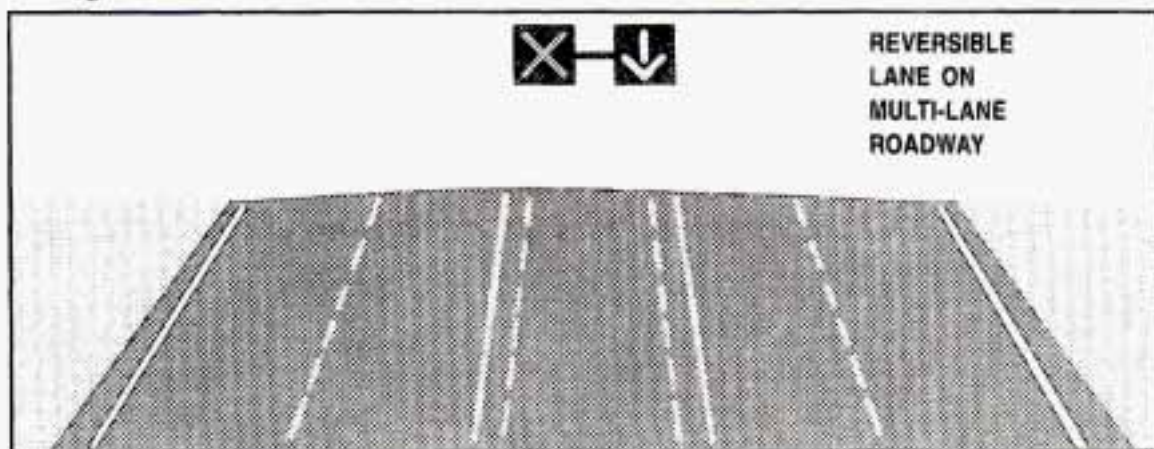

AM402015

Many city roads and expressways, and even bridges, use reversible-lane traffic control during rush hours. A red X light above a lane means no driving in that lane at that time. A green arrow means you may drive in that lane. Look for the signs posted to warn drivers what hours and days these systems are in effect.

# ***Your Driving and the Road***

---

## ***Pavement Markings***

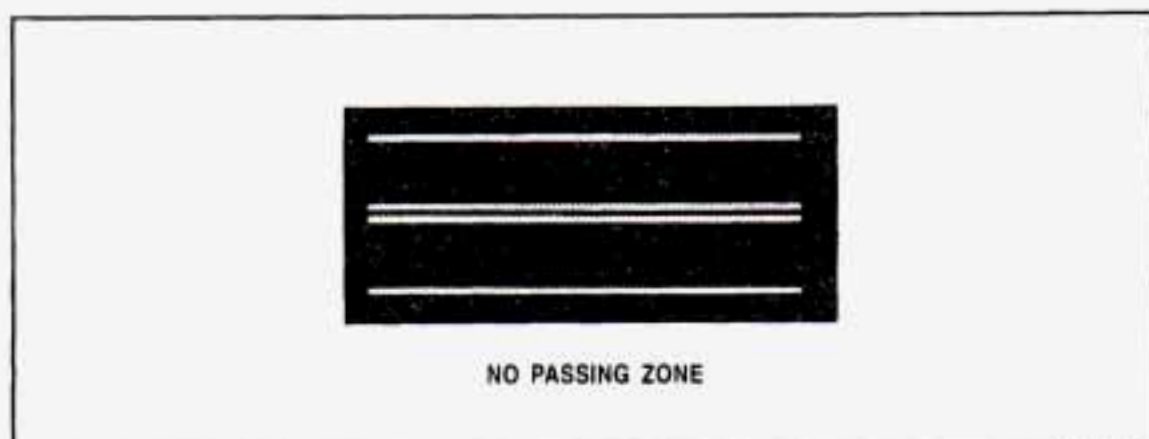

AM402016

Pavement markings add to traffic signs and signals. They give information to drivers without taking attention from the roadway. A solid yellow line on your side of the road or lane means "don't cross."

### ***Your Own Signals***

Drivers signal to others, too. It's not only more polite, it's safer, to let other drivers know what you are doing. And in some places the law requires driver signals.

**Turn and lane change signals:** Always signal when you plan to turn or change lanes.

If necessary, you can use hand signals out the window: Left arm straight out for a left turn, down for slow or about-to-stop, and up for a right turn.

**Slowing down:** If time allows, tap the brake pedal once or twice in advance of slowing or stopping. This warns the driver behind you.

**Disabled:** Your four-way flashers signal that your vehicle is disabled or is a hazard. See "Hazard Warning Flasher" in the Index.

### ***Traffic Officer***

The traffic police officer is also a source of important information. The officer's signals govern, no matter what the traffic lights or other signs say.

The next part discusses some of the road conditions you may encounter.



---

---

## **Defensive Driving**

The best advice anyone can give about driving is: Drive defensively.

Please start with a very important safety device in your vehicle: Buckle up. (See "Safety Belts" in the Index.)

Defensive driving really means "be ready for anything." On city streets, rural roads, or freeways, it means "always expect the unexpected."

Assume that pedestrians or other drivers are going to be careless and make mistakes. Anticipate what they might do. Be ready for their mistakes.

Expect children to dash out from behind parked cars, often followed by other children. Expect occupants in parked cars to open doors into traffic. Watch for movement in parked cars—someone may be about to open a door.

Expect other drivers to run stop signs when you are on a through street. Be ready to brake if necessary as you go through intersections. You may not have to use the brake, but if you do, you will be ready.

If you're driving through a shopping center parking lot where there are well-marked lanes, directional arrows, and designated parking areas, expect some drivers to ignore all these markings and dash straight toward one part of the lot.

Pedestrians can be careless. Watch for them. In general, you must give way to pedestrians even if you know you have the right of way.

Rear-end collisions are about the most preventable of accidents. Yet they are common. Allow enough following distance. It's the best defensive driving maneuver, in both city and rural driving. You never know when the vehicle in front of you is going to brake or turn suddenly.

Here's a final bit of information about defensive driving. The most dangerous time for driving in the U.S. is very early on Sunday morning. In fact, GM Research studies show that the most and the least dangerous times for driving, every week, fall on the same day. That day is Sunday. The most dangerous time is Sunday 3 a.m. to 4 a.m. The safest time is Sunday from 10 a.m. to 11 a.m. Driving the same distance on a Sunday at 3 a.m. isn't just a little more dangerous than it is at 10 a.m. It's about 134 times more dangerous.

That leads to the next part.

# ***Your Driving and the Road***

---

## ***Drunken Driving***

Death and injury associated with drinking and driving is a national tragedy. It's the number one contributor to the highway death toll, claiming thousands of victims every year. Alcohol takes away three things that anyone needs to drive a vehicle.

- Judgment
- Muscular Coordination
- Vision

Police records show that half of all motor vehicle-related deaths involve alcohol—a driver, a passenger or someone else, such as a pedestrian, had been drinking. In most cases, these deaths are the result of someone who was drinking and driving. Over 25,000 motor vehicle-related deaths occur each year because of alcohol, and thousands of people are injured.

Just how much alcohol is too much if a person plans to drive? Ideally, no one should drink alcohol and then drive. But if one does, then what's "too much"? It can be a lot less than many might think. Although it depends on each person and situation, here is some general information on the problem.

The Blood Alcohol Content (BAC) of someone who is drinking depends upon four things:

- How much alcohol is in the drink.
- The drinker's body weight.
- The amount of food that is consumed before and during drinking.
- The length of time it has taken the drinker to consume the alcohol.

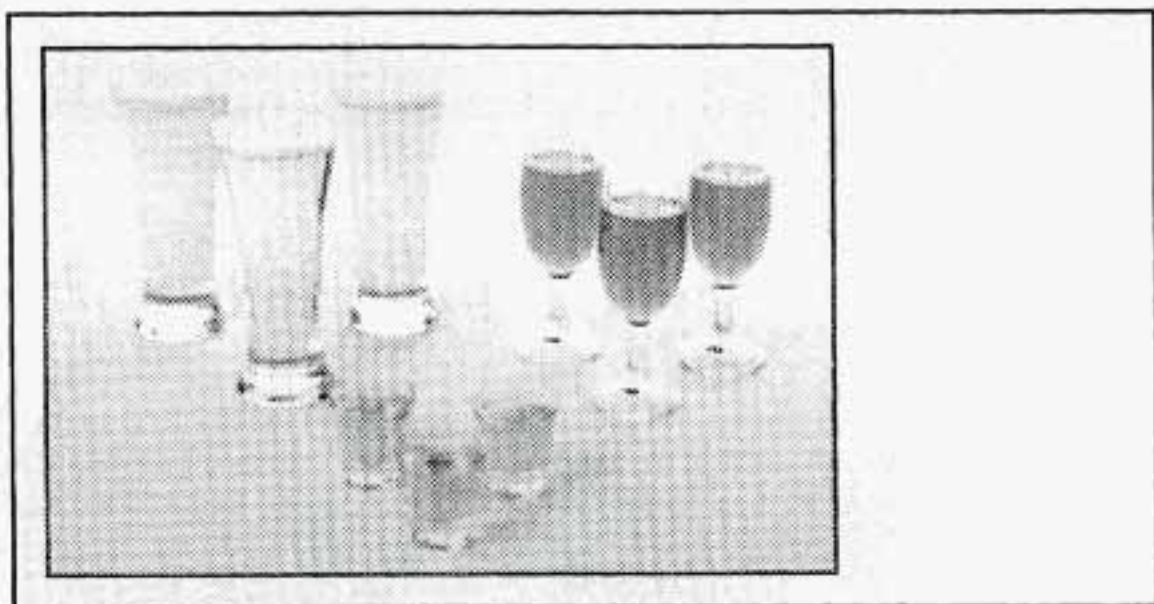

AM407001

According to the American Medical Association, a 180-pound (82 kg) person who drinks three 12-ounce (355 ml) bottles of beer in an hour will end up with a BAC of about 0.06 percent. The person would reach the same BAC by drinking three 4-ounce (120 ml) glasses of wine or three mixed drinks if each had 1-1/2 ounces (45 ml) of a liquor like whiskey, gin or vodka.

It's the amount of alcohol that counts. For example, if the same person drank three double martinis (3 ounces or 90 ml of liquor each) within an hour, the person's BAC would be close to 0.12 percent. A person who consumes food just before or during drinking will have a slightly lower BAC level.

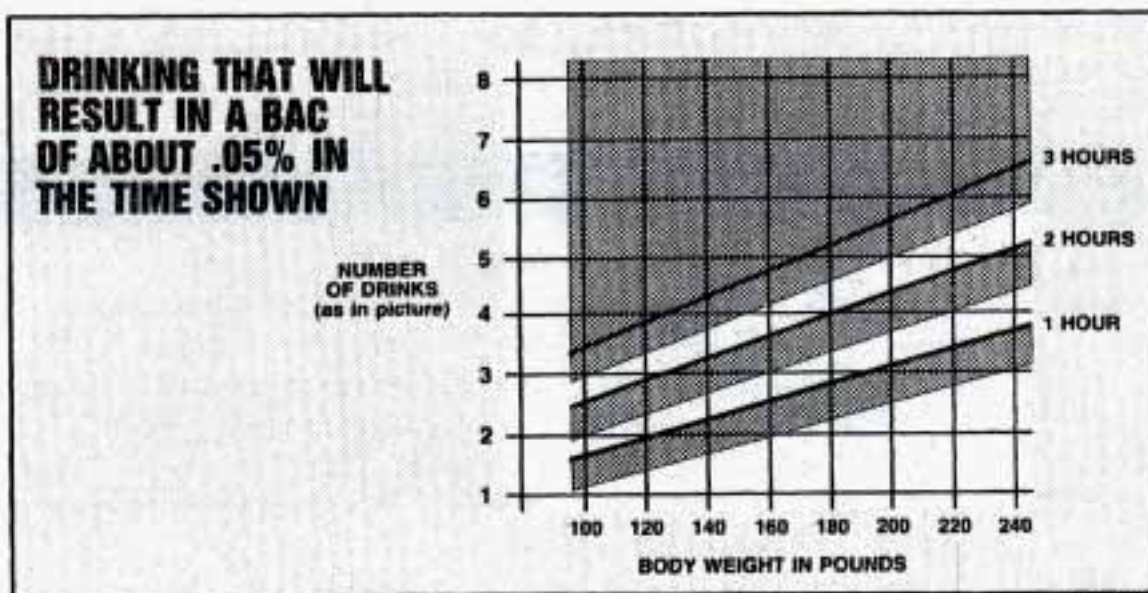

AM407002

## ***Your Driving and the Road***

---

The law in most U.S. states sets the legal limit at a BAC of 0.10 percent. In Canada the limit is 0.08 percent, and in some other countries it's lower than that. The BAC will be over 0.10 percent after three to six drinks (in one hour). Of course, as we've seen, it depends on how much alcohol is in the drinks, and how quickly the person drinks them.

But it's very important to keep in mind that the ability to drive is affected well below a BAC of 0.10 percent. Research shows that the driving skills of many people are impaired at a BAC approaching 0.05 percent, and that the effects are worse at night. All drivers are impaired at BAC levels above 0.05 percent. Statistics show that the chance of being in an accident increases sharply for drivers who have a BAC of 0.05 percent or above. A driver with a BAC level of 0.06 percent (three beers in one hour for a 180-pound or 82 kg person) has doubled his or her chance of having an accident. At a BAC level of 0.10 percent, the chance of that driver having an accident is six times greater; at a level of 0.15 percent, the chances are twenty-five times greater! And, the body takes about an hour to rid itself of the alcohol in one drink. No amount of coffee or number of cold showers will speed that up.

"I'll be careful" isn't the right answer. What if there's an emergency, a need to take sudden action, as when a child darts into the street? A person with a higher BAC might not be able to react quickly enough to avoid the collision.

There's something else about drinking and driving that many people don't know. Medical research shows that alcohol in a person's system can make crash injuries worse. That's especially true for brain, spinal cord and heart injuries. That means that if anyone who has been drinking—driver or passenger—is in a crash, the chance of being killed or permanently disabled is higher than if that person had not been drinking. And we've already seen that the chance of a crash itself is higher for drinking drivers.

### **CAUTION**



Drinking and then driving is very dangerous. Your reflexes, perceptions, and judgment will be affected by even a small amount of alcohol. You could have a serious—or even fatal—accident if you drive after drinking. Please don't drink and drive or ride with a driver who has been drinking. Ride home in a cab; or if you're with a group, designate a driver who will not drink.

---

---

## **Control of a Vehicle**

You have three systems that make your vehicle go where you want it to go. They are the brakes, the steering and the accelerator. All three systems have to do their work at the places where the tires meet the road.

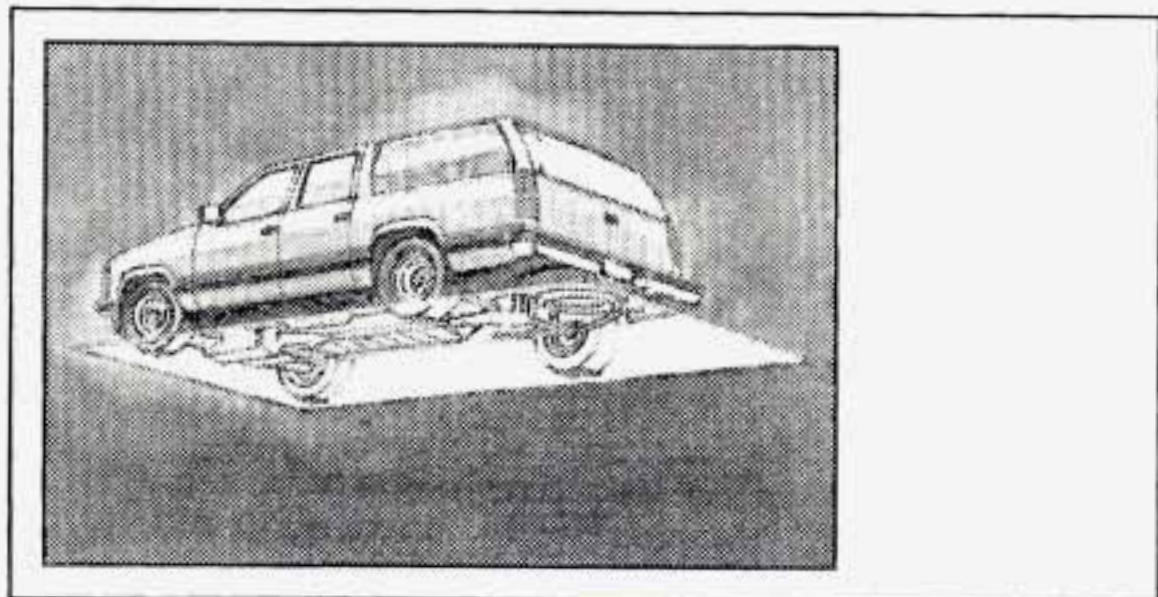

AM409006

Sometimes, as when you're driving on snow or ice, it's easy to ask more of those control systems than the tires and road can provide. That means you can lose control of your vehicle.

### **Braking**

Braking action involves **perception time** and **reaction time**.

First, you have to decide to push on the brake pedal. That's **perception time**. Then you have to bring up your foot and do it. That's **reaction time**.

Average **reaction time** is about 3/4 of a second. But that's only an average. It might be less with one driver and as long as two or three seconds or more with another. Age, physical condition, alertness, coordination, and eyesight all play a part. So do alcohol, drugs and frustration. But even in 3/4 of a second, a vehicle moving at 60 mph (100 km/h) travels 66 feet (20 m). That could be a lot of distance in an emergency, so keeping enough space between your vehicle and others is important.

And, of course, actual stopping distances vary greatly with the surface of the road (whether it's pavement or gravel); the condition of the road (wet, dry, icy); tire tread; and the condition of your brakes.

## Your Driving and the Road

Most drivers treat their brakes with care. Some, however, overwork the braking system with poor driving habits.

- Avoid needless heavy braking. Some people drive in spurts—heavy acceleration followed by heavy braking—rather than keeping pace with traffic. This is a mistake. Your brakes may not have time to cool between hard stops. Your brakes will wear out much faster if you do a lot of heavy braking.
- Don't "ride" the brakes by letting your left foot rest lightly on the brake pedal while driving.

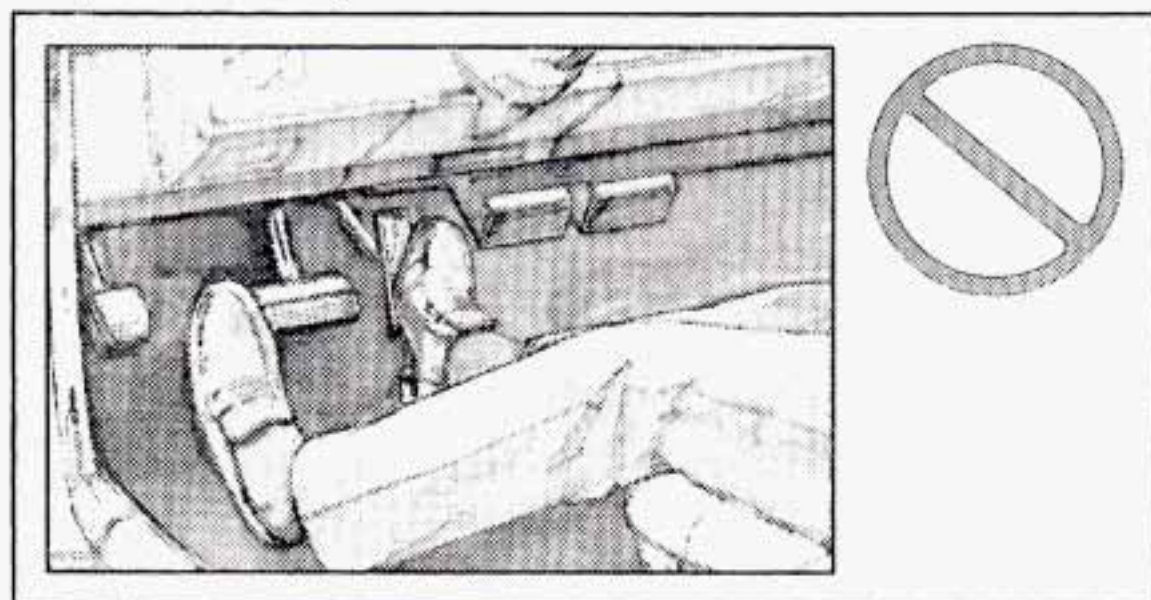

AM410001

### CAUTION



"Riding" your brakes can cause them to overheat to the point that they won't work well. You might not be able to stop your vehicle in time to avoid an accident. If you "ride" your brakes, they will get so hot they will require a lot of pedal force to slow you down. Avoid "riding" the brakes.

### NOTICE

"Riding" the brakes wears them out much faster. You would need costly brake replacement much sooner than normal, and it also reduces fuel economy.

If you keep pace with the traffic and allow realistic following distances, you will eliminate a lot of unnecessary braking. That means better braking and longer brake life.

- 
- If your engine ever stops while you're driving, brake normally but don't pump your brakes. If you do, the pedal may get harder to push down. If your engine stops, you will still have some power brake assist. But you will use it when you brake. Once the power assist is used up, it may take longer to stop and the brake pedal will be harder to push.

### ***Anti-lock Brakes (ABS)***

Your vehicle has an advanced electronic braking system that can help keep it under control.

When you start your vehicle and begin to drive away, you may hear a momentary motor or clicking noise. This is the ABS system testing itself.

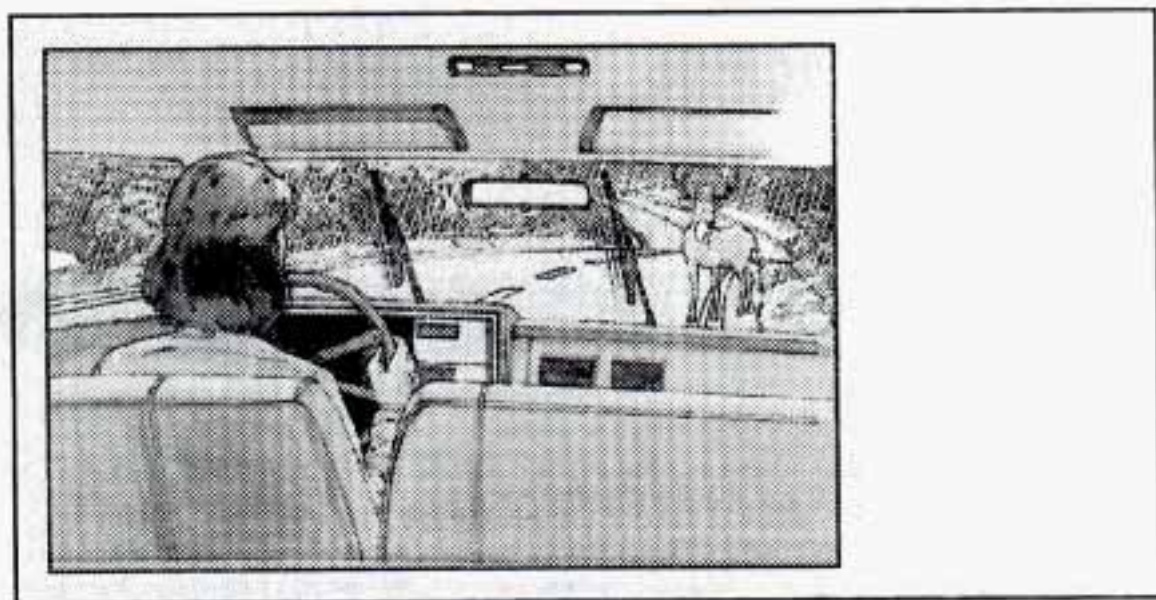

AM415006

Here's how anti-lock works. Let's say the road is wet. You're driving safely. Suddenly an animal jumps out in front of you.

You slam on the brakes. Here's what happens with ABS.

A computer senses that wheels are slowing down. The computer separately works the brakes at each front wheel and at the rear wheels. The anti-lock system can change the brake pressure faster than any driver could. The computer is programmed to make the most of available tire and road conditions. You can steer around the obstacle while braking hard.

## ***Your Driving and the Road***

---

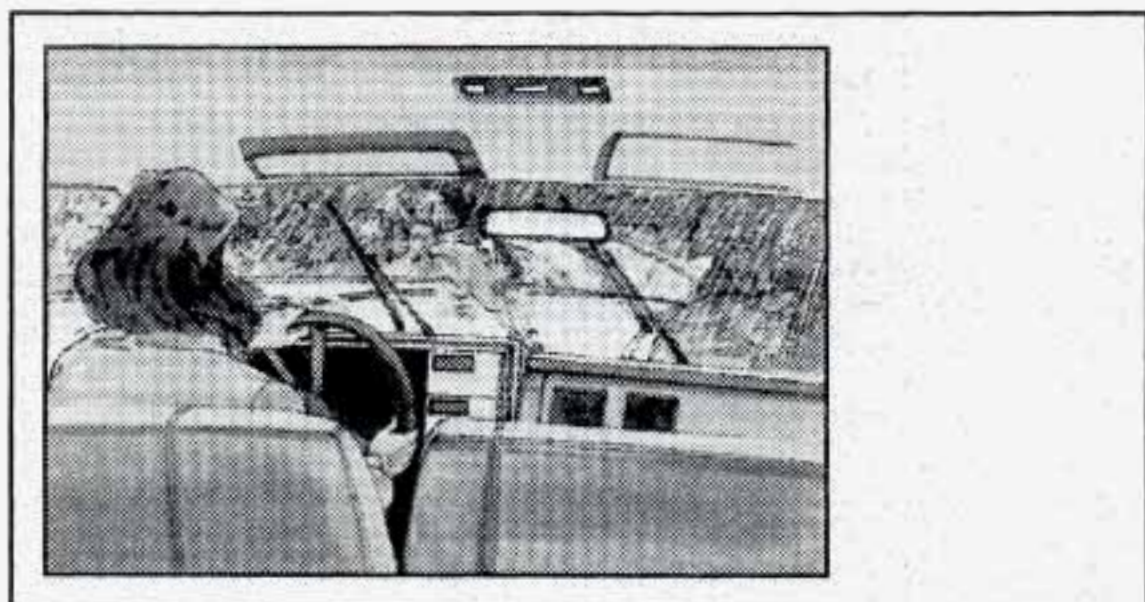

AM415016

As you brake, your computer keeps receiving updates on wheel speed and controls braking pressure accordingly.

### **CAUTION**



Anti-lock doesn't change the time you need to get your foot up to the brake pedal. If you get too close to the vehicle in front of you, you won't have time to apply your brakes if that vehicle suddenly slows or stops. Always leave enough room up ahead to stop, even though you have anti-lock brakes.

### ***To Use Four-Wheel Anti-Lock:***

Don't pump the brakes. Just hold the brake pedal down and let anti-lock work for you. You may feel the brakes vibrate, or you may notice some noise, but this is normal.



## Brake System Warning Light

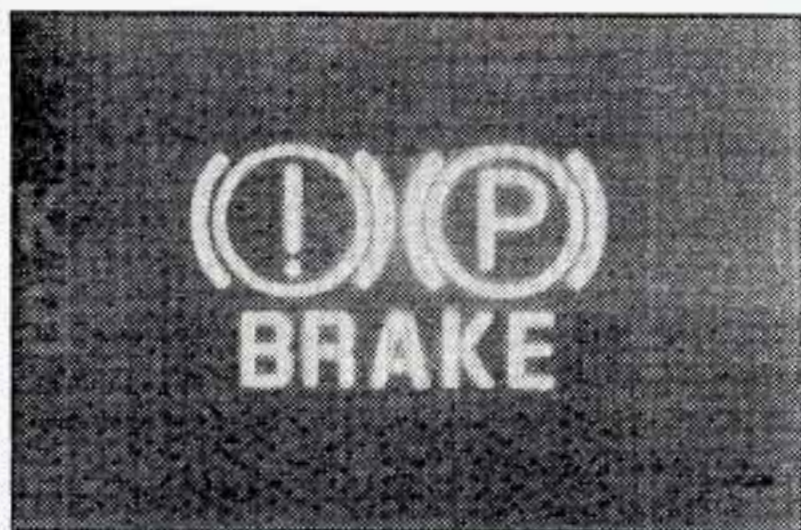

K2325

This light appears on your instrument cluster to warn you if your regular braking system needs service. See "Brake System Warning Light" in the Index.

### **Disc Brake Wear Indicators**

Disc brake pads have built-in wear indicators that make a high-pitched warning sound when the brake pads are worn and new pads are needed. The sound may come and go or be heard all the time your vehicle is moving (except when you are pushing on the brake pedal firmly).

### **CAUTION**



The brake wear warning sound means that sooner or later your your brakes won't work well. That could lead to an accident. When you hear the brake wear warning sound, have your vehicle serviced.

### **NOTICE**

Continuing to drive with worn-out brake pads could result in costly brake repair.

Some driving conditions or climates may cause a brake squeal when the brakes are first applied or lightly applied. This does not mean something is wrong with your brakes.

# ***Your Driving and the Road***

---

## ***Rear Drum Brakes***

Your rear drum brakes don't have the wear indicators, but if you ever hear a rear brake rubbing noise, have the rear brake lining inspected. Also, the rear brake drums should be removed and inspected each time the tires are removed for rotation or changing. When you have the front brakes replaced, have the rear brakes inspected, too.

Brake linings should always be replaced as complete axle sets.

## ***Brake Pedal Travel***

See your dealer if the brake pedal does not return to normal height, or if there is a rapid increase in pedal travel. This could be a sign of brake trouble.

## ***Brake Adjustment***

Every time you make a brake stop, your disc brakes adjust for wear. If your brake pedal goes down farther than normal, your rear drum brakes may need adjustment. Adjust them by backing up and firmly applying the brakes a few times.

## ***Braking In Emergencies***

Use your anti-lock braking system when you need to. With anti-lock, you can steer and brake at the same time. In many emergencies, steering can help you more than even the very best braking.

## ***Steering***

### ***Power Steering***

If you lose power steering assist because the engine stops or the system fails to function, you can steer but it will take much more effort.

### ***Steering Tips***

#### ***Driving on Curves***

It's important to take curves at a reasonable speed.

A lot of the "driver lost control" accidents mentioned on the news happen on curves. Here's why:

Experienced driver or beginner, each of us is subject to the same laws of physics when driving on curves. The traction of the tires against the road surface makes it possible for the vehicle to change its path when you turn the front wheels. If there's no traction, inertia will keep the vehicle going in the same direction. If you've ever tried to steer a vehicle on wet ice, you'll understand this.

---

The traction you can get in a curve depends on the condition of your tires and the road surface, the angle at which the curve is banked, and your speed. While you're in a curve, speed is the one factor you can control.

Suppose you're steering through a sharp curve. Then you suddenly accelerate. Those two control systems—steering and acceleration—can overwhelm those places where the tires meet the road and make you lose control.

What should you do if this ever happens? Let up on the accelerator pedal, steer the vehicle the way you want it to go, and slow down.

Speed limit signs near curves warn that you should adjust your speed. Of course, the posted speeds are based on good weather and road conditions. Under less favorable conditions you'll want to go slower.

If you need to reduce your speed as you approach a curve, do it before you enter the curve, while your front wheels are straight ahead.

Try to adjust your speed so you can "drive" through the curve. Maintain a reasonable, steady speed. Wait to accelerate until you are out of the curve, and then accelerate gently into the straightaway.

When you drive into a curve at night, it's harder to see the road ahead of you because it bends away from the straight beams of your lights. This is one good reason to drive slower.

### ***Steering in Emergencies***

There are times when steering can be more effective than braking. For example, you come over a hill and find a truck stopped in your lane, or a car suddenly pulls out from nowhere, or a child darts out from between parked cars and stops right in front of you. You can avoid these problems by braking—if you can stop in time. But sometimes you can't; there isn't room. That's the time for evasive action—steering around the problem.

Your vehicle can perform very well in emergencies like these. First apply your brakes.

It is better to remove as much speed as you can from a possible collision. Then steer around the problem, to the left or right depending on the space available.

An emergency like this requires close attention and a quick decision. If you are holding the steering wheel at the recommended 9 and 3 o'clock positions, you can turn it a full 180 degrees very quickly without removing either hand. But you have to act fast, steer quickly, and just as quickly straighten the

## ***Your Driving and the Road***

---

wheel once you have avoided the object. You must then be prepared to steer back to your original lane and then brake to a controlled stop.

Depending on your speed, this can be rather violent for an unprepared driver. This is one of the reasons driving experts recommend that you use your safety belts and keep both hands on the steering wheel.



K2218

The fact that such emergency situations are always possible is a good reason to practice defensive driving at all times.

### ***Off-Road Recovery***

You may find sometime that your right wheels have dropped off the edge of a road onto the shoulder while you're driving.

If the level of the shoulder is only slightly below the pavement, recovery should be fairly easy. Ease off the accelerator and then, if there is nothing in the way, steer so that your vehicle straddles the edge of the pavement. You can turn the steering wheel up to 1/4 turn until the right front tire contacts the pavement edge. Then turn your steering wheel to go straight down the roadway.

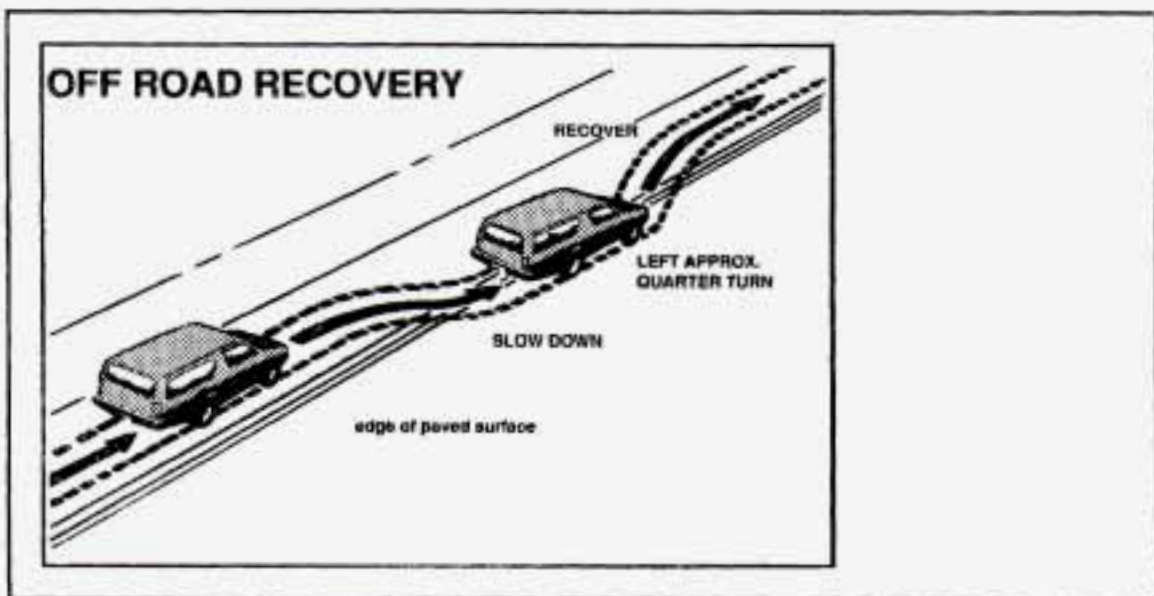

AM428002

If the shoulder appears to be about four inches (100 mm) or more below the pavement, this difference can cause problems. If there is not enough room to pull entirely onto the shoulder and stop, then follow the same procedures. But if the right front tire scrubs against the side of the pavement, do NOT steer more sharply. With too much steering angle, the vehicle may jump back onto the road with so much steering input that it crosses over into the oncoming traffic before you can bring it back under control.

Instead, ease off again on the accelerator and steering input, straddle the pavement once more, then try again.

## ***Passing***

The driver of a vehicle about to pass another on a two-lane highway waits for just the right moment, accelerates, moves around the vehicle ahead, then goes back into the right lane again. A simple maneuver?

Not necessarily! Passing another vehicle on a two-lane highway is a potentially dangerous move, since the passing vehicle occupies the same lane as oncoming traffic for several seconds. A miscalculation, an error in judgment, or a brief surrender to frustration or anger can suddenly put the passing driver face to face with the worst of all traffic accidents—the head-on collision.

So here are some tips for passing:

- "Drive ahead." Look down the road, to the sides, and to crossroads for situations that might affect your passing patterns. If you have any doubt whatsoever about making a successful pass, wait for a better time.

## ***Your Driving and the Road***

---

- Watch for traffic signs, pavement markings, and lines. If you can see a sign up ahead that might indicate a turn or an intersection, delay your pass. A broken center line usually indicates it's all right to pass (providing the road ahead is clear). Never cross a solid line on your side of the lane or a double solid line, even if the road seems empty of approaching traffic.
- If you suspect that the driver of the vehicle you want to pass isn't aware of your presence, tap the horn a couple of times before passing.
- Do not get too close to the vehicle you want to pass while you're awaiting an opportunity. For one thing, following too closely reduces your area of vision, especially if you're following a larger vehicle. Also, you won't have adequate space if the vehicle ahead suddenly slows or stops. Keep back a reasonable distance.
- When it looks like a chance to pass is coming up, start to accelerate but stay in the right lane and don't get too close. Time your move so you will be increasing speed as the time comes to move into the other lane. If the way is clear to pass, you will have a "running start" that more than makes up for the distance you would lose by dropping back. And if something happens to cause you to cancel your pass, you need only slow down and drop back again and wait for another opportunity.
- If other cars are lined up to pass a slow vehicle, wait your turn. But take care that someone isn't trying to pass you as you pull out to pass the slow vehicle. Remember to glance over your shoulder and check the blind spot.
- Check your mirrors, glance over your shoulder, and start your left lane change signal before moving out of the right lane to pass. When you are far enough ahead of the passed vehicle to see its front in your inside mirror, activate your right lane change signal and move back into the right lane. (Remember that your right outside mirror is convex. The vehicle you just passed may seem to be farther away from you than it really is).
- Try not to pass more than one vehicle at a time on two-lane roads. Reconsider before passing the next vehicle.
- Don't overtake a slowly moving vehicle too rapidly. Even though the brake lights are not flashing, it may be slowing down or starting to turn.
- If you're being passed, make it easy for the following driver to get ahead of you. Perhaps you can ease a little to the right.

---

## ***Loss of Control***

Let's review what driving experts say about what happens when the three control systems (brakes, steering and acceleration) don't have enough friction where the tires meet the road to do what the driver has asked.

In any emergency, don't give up. Keep trying to steer, and constantly seek an escape route or area of less danger.

### ***Skidding***

In a skid, a driver can lose control of the vehicle. Defensive drivers avoid most skids by taking reasonable care suited to existing conditions, and by not "overdriving" those conditions. But skids are always possible.

The three types of skids correspond to your vehicle's three control systems. In the braking skid your wheels aren't rolling. In the steering or cornering skid, too much speed or steering in a curve causes tires to slip and lose cornering force. And in the acceleration skid too much throttle causes the driving wheels to spin.

A cornering skid and an acceleration skid are best handled by easing your foot off the accelerator pedal. If your vehicle starts to slide (as when you turn a corner on a wet, snow- or ice-covered road), ease your foot off the accelerator pedal as soon as you feel the vehicle start to slide. Quickly steer the way you want the vehicle to go. If you start steering quickly enough, your vehicle will straighten out. As it does, straighten the front wheels.

Of course, traction is reduced when water, snow, ice, gravel, or other material is on the road. For safety, you'll want to slow down and adjust your driving to these conditions. It is important to slow down on slippery surfaces because stopping distance will be longer and vehicle control more limited.

While driving on a surface with reduced traction, try your best to avoid sudden steering, acceleration, or braking (including engine braking by shifting to a lower gear). Any sudden changes could cause the tires to slide. You may not realize the surface is slippery until your vehicle is skidding. Learn to recognize warning clues—such as enough water, ice or packed snow on the road to make a "mirrored surface"—and slow down when you have any doubt.

Remember: Any anti-lock braking system (ABS) helps avoid only the braking skid. Steer the way you want to go.

# ***Your Driving and the Road***

---

## ***Driving Guidelines (Utility Models)***

This multipurpose passenger vehicle is defined as a utility vehicle in Consumer Information Regulations issued by the National Highway Traffic Safety Administration (NHTSA) of the United States Department of Transportation. Utility vehicles have higher ground clearance and a narrower track to make them capable of performing in a wide variety of off-road applications. Specific design characteristics give them a higher center of gravity than ordinary cars. An advantage of the higher ground clearance is a better view of the road allowing you to anticipate problems. They are not designed for cornering at the same speeds as conventional 2-wheel drive vehicles any more than low-slung sports cars are designed to perform satisfactorily under off-road conditions. If at all possible, avoid sharp turns or abrupt maneuvers. As with other vehicles of this type, failure to operate this vehicle correctly may result in loss of control or vehicle rollover.

## ***Off-Road Driving with Your Four-Wheel Drive Vehicle***

This off-road guide is for vehicles that have four-wheel drive. (Also, see "Anti-lock Brakes" in the Index.) If your vehicle doesn't have four-wheel drive, you shouldn't drive off-road unless you're on a level, solid surface.

Off-road driving can be great fun. But it does have some definite hazards. The greatest of these is the terrain itself.

"Off-roading" means you've left the great North American road system behind. Traffic lanes aren't marked. Curves aren't banked. There are no road signs. Surfaces can be slippery, rough, uphill or downhill. In short, you've gone right back to nature.

Off-road driving involves some new skills. And that's why it's very important that you read this guide. You'll find many driving tips and suggestions. These will help make your off-road driving safer and more enjoyable.

### ***Before You Go Off-Roading***

There are some things to do before you go out. For example, be sure to have all necessary maintenance and service work done. Be sure you read all the information about your four-wheel drive vehicle in this manual. Is there enough fuel? Is the spare tire fully inflated? Are the fluid levels up where they should be? What are the local laws that apply to off-roading where you'll be driving? If you don't know, you should check with law enforcement people in the area. Will you be on someone's private land? If so, be sure to get the necessary permission.



---

---

## ***Loading Your Vehicle for Off-Road Driving***

There are some important things to remember about how to load your vehicle.

- The heaviest things should be on the load floor and forward of your rear axle. Put heavier items as far forward as you can.
- Be sure the load is secured properly, so driving on the off-road terrain doesn't toss things around.

### **CAUTION**



- Cargo on the load floor piled higher than the seatbacks can be thrown forward during a sudden stop. You or your passengers could be injured. Keep cargo below the top of the seatbacks.
- Unsecured cargo on the load floor can be tossed about when driving over rough terrain. You or your passengers can be struck by flying objects. Secure the cargo properly.
- Heavy loads on the roof raise the vehicle's center of gravity, making it more likely to roll over. You can be seriously or fatally injured if the vehicle rolls over. Put heavy loads inside the cargo area, not on the roof. Keep cargo in the cargo area as far forward and low as possible.

You'll find other important information in this manual. See "Vehicle Loading", "Luggage Carrier" and "Tires" in the Index.

### ***Traveling to Remote Areas***

It makes sense to plan your trip, especially when going to a remote area. Know the terrain and plan your route. You are much less likely to get bad surprises. Get accurate maps of trails and terrain. Try to learn of any blocked or closed roads.

It's also a good idea to travel with at least one other vehicle. If something happens to one of them, the other can help quickly.

Does your vehicle have a winch? If so, be sure to read the winch instructions. In a remote area, a winch can be handy if you get stuck. But you'll want to know how to use it properly.

### ***Getting Familiar with Off-Road Driving***

It's a good idea to practice in an area that's safe and close to home before you go into the wilderness. Off-road driving does require some new and different driving skills. Here's what we mean.

## ***Your Driving and the Road***

---

Tune your senses to different kinds of signals. Your eyes, for example, need to constantly sweep the terrain for unexpected obstacles. Your ears need to listen for unusual tire or engine sounds. With your arms, hands, feet, and body you'll need to respond to vibrations and vehicle bounce.

Controlling your vehicle is the key to successful off-road driving. One of the best ways to control your vehicle is to control your speed. Here are some things to keep in mind. At higher speeds:

- you approach things faster and you have less time to scan the terrain for obstacles.
- you have less time to react.
- you have more vehicle bounce when you drive over obstacles.
- you'll need more distance for braking, especially since you're on an unpaved surface.

### **CAUTION**



When you're driving off road, bouncing and quick changes in direction can easily throw you out of position. This could cause you to lose control and crash. So, whether you are driving on or off the road, you and your passengers should wear your safety belts.

### ***Scanning the Terrain***

Off-road driving can take you over many different kinds of terrain. You need to be familiar with the terrain and its many different features. Here are some things to consider.

#### ***Surface Conditions***

Off-roading can take you over hard-packed dirt, gravel, rocks, grass, sand, mud, snow or ice. Each of these surfaces affects the steering, acceleration, and braking of your vehicle in different ways. Depending upon the kind of surface you are on, you may experience slipping, sliding, wheel spinning, delayed acceleration, poor traction, and longer braking distances.

#### ***Surface Obstacles***

Unseen or hidden obstacles can be hazardous. A rock, log, hole, rut, or bump can startle you if you're not prepared for them. Often these obstacles are hidden by grass, bushes, snow or even the rise and fall of the terrain itself. Here are some things to consider:

- Is the path ahead clear?
- Will the surface texture change abruptly up ahead?

- 
- Does the travel take you uphill or downhill? (There's more discussion of these subjects later.)
  - Will you have to stop suddenly or change direction quickly?

When you drive over obstacles or rough terrain, keep a firm grip on the steering wheel. Ruts, troughs, or other surface features can jerk the wheel out of your hands if you're not prepared.

When you drive over bumps, rocks, or other obstacles, your wheels can leave the ground. If this happens, even with one or two wheels, you can't control the vehicle as well or at all.

Because you will be on an unpaved surface, it's especially important to avoid sudden acceleration, sudden turns, or sudden braking.

In a way, off-road driving requires a different kind of alertness from driving on paved roads and highways. There are no road signs, posted speed limits or signal lights. You have to use your own good judgment about what is safe and what isn't.

## CAUTION



Drinking and driving can be very dangerous on any road. And this is certainly true for off-road driving. At the very time you need special alertness and driving skills, your reflexes, perceptions and judgment can be affected by even a small amount of alcohol. You could have a serious—or even fatal—accident if you drink and drive or ride with a driver who has been drinking. (See "Drunken Driving" in the Index.)

### *Driving On Off-Road Hills*

Off-road driving often takes you up, down, or across a hill. Driving safely on hills requires good judgment and an understanding of what your vehicle can and can't do. There are some hills that simply can't be driven, no matter how well-built the vehicle.

## CAUTION



Many hills are simply too steep for any vehicle. If you drive up them, you will stall. If you drive down them, you can't control your speed. If you drive across them, you will roll over. You could be seriously injured or killed. If you have any doubt about the steepness, don't drive the hill.

# ***Your Driving and the Road***

---

## ***Approaching a Hill***

When you approach a hill, you need to decide if it's one of those hills that's just too steep to climb, descend, or cross. Steepness can be hard to judge. On a very small hill, for example, there may be a smooth, constant incline with only a small change in elevation where you can easily see all the way to the top. On a large hill, the incline may get steeper as you near the top, but you may not see this because the crest of the hill is hidden by bushes, grass, or shrubs.

Here are some other things to consider as you approach a hill.

- Is there a constant incline, or does the hill get sharply steeper in places?
- Is there good traction on the hillside, or will the surface cause tire slipping?
- Is there a straight path up or down the hill so you won't have to make turning maneuvers?
- Are there obstructions on the hill than can block your path (boulders, trees, logs or ruts)?
- What's beyond the hill? Is there a cliff, an embankment, a drop-off, a fence? Get out and walk the hill if you don't know. It's the smart way to find out.
- Is the hill simply too rough? Steep hills often have ruts, gullies, troughs and exposed rocks because they are more susceptible to the effects of erosion.

## ***Driving Uphill***

Once you decide you can safely drive up the hill, you need to take some special steps.

- Use a lower gear and get a firm grip on the steering wheel.
- Get a smooth start up the hill and try to maintain your speed. Don't use more power than you need, because you don't want your wheels to start spinning or sliding.
- Try to drive straight up the hill if at all possible. If the path twists and turns, you might want to find another route.

## CAUTION



Turning or driving across steep hills can be dangerous. You could lose traction, slide sideways, and possibly roll over. You could be seriously injured or killed. When driving up hills, always try to go straight up.

- Ease up on your speed as you approach the top of the hill.
- Attach a flag to the vehicle to make you more visible to approaching traffic on trails or hills.
- Sound the horn as you approach the top of hill to let opposing traffic know you're there.
- Use your headlights even during the day. They make you more visible to oncoming traffic.

## CAUTION



Driving to the top (crest) of a hill at full speed can cause an accident. There could be a drop-off, embankment, cliff, or even another vehicle. You could be seriously injured or killed. As you near the top of a hill, slow down and stay alert.

**Q: What should I do if my vehicle stalls, or is about to stall, and I can't make it up the hill?**

**A:** If this happens, there are some things you should do, and there are some things you must not do. First, here's what you **should** do:

- Push the brake pedal to stop the vehicle and keep it from rolling backwards. Also, apply the parking brake.
- If your engine is still running, shift the transmission into reverse, release the parking brake, and slowly back down the hill in reverse.
- If your engine has stopped running, you'll need to restart it. With the brake pedal depressed and the parking brake still applied, shift the transmission to **P** (Park) (or, shift to **N** (Neutral) if your vehicle has a manual transmission) and restart the engine. Then, shift to reverse, release the parking brake, and slowly back down the hill in reverse.
- As you are backing down the hill, put your left hand on the steering wheel at the 12 o'clock position. This way, you'll be able to tell if your wheels are straight or turned to the left or right as you back down.

## ***Your Driving and the Road***

---

Here are some things you **must not** do if you stall, or are about to stall, when going up a hill.

- Never attempt to prevent a stall by shifting into **N** (Neutral) (or depressing the clutch, if you have a manual transmission) to “rev-up” the engine and regain forward momentum. This won't work. Your vehicle will roll backwards very quickly and you could go out of control.

Instead, apply the regular brake to stop the vehicle. Then apply the parking brake. Shift into reverse, release the parking brake, and slowly back down.

- Never attempt to turn around if you are about to stall when going up a hill. If the hill is steep enough to stall your vehicle, it's steep enough to cause you to roll over if you turn around. If you can't make it up the hill, you must back down the hill.

**Q: Suppose, after stalling, I try to back down the hill and decide I just can't do it. What should I do?**

**A:** Set the parking brake, put your transmission in **P** (Park) (or the manual transmission in first gear), and turn off the engine. Leave the vehicle and go get some help. Exit on the uphill side and stay clear of the path the vehicle would take if it rolled downhill. Do not shift the transfer case to **N** (Neutral) when you leave the vehicle. Leave it in some gear.

### **CAUTION**



Shifting the transfer case to **N** (Neutral) can cause your vehicle to roll even if the transmission is in **P** (Park) (or, if you have the manual transmission, even if you're in gear). This is because the **N** (Neutral) position on the transfer case overrides the transmission. If you are going to leave your vehicle, set the parking brake and shift the transmission to **P** (Park) (or, put your manual transmission in first gear). But do not shift the transfer case to the **N** (Neutral) position. Leave the transfer case in the 2 Wheel, 4 High or 4 Low position.

### ***Driving Downhill***

When off-roading takes you downhill, you'll want to consider a number of things:

- How steep is the downhill? Will I be able to maintain vehicle control?
- What's the surface like? Smooth? Rough? Slippery? Hard-packed dirt? Gravel?
- Are there hidden surface obstacles? Ruts? Logs? Boulders?

- 
- What's at the bottom of the hill? Is there a hidden creek bank or even a river bottom with large rocks?

If you decide you can go down a hill safely, then try to keep your vehicle headed straight down, and use a low gear. This way, engine drag can help your brakes and they won't have to do all the work. Descend slowly, keeping your vehicle under control at all times.

## CAUTION



Heavy braking when going down a hill can cause your brakes to overheat and fade. This could cause loss of control and a serious accident. Apply the brakes lightly when descending a hill and use a low gear to keep vehicle speed under control.

**Q: Are there some things I should not do when driving down a hill?**

**A:** Yes! These are important because if you ignore them you could lose control and have a serious accident.

- When driving downhill, avoid turns that take you across the incline of the hill. A hill that's not too steep to drive down may be too steep to drive across. You could roll over if you don't drive straight down.
- Never go downhill with the transmission in **N** (Neutral), or with the clutch pedal depressed in a manual shift. This is called "free-wheeling." Your brakes will have to do all the work and could overheat and fade.

**Q: Am I likely to stall when going downhill?**

**A:** It's much more likely to happen going uphill. But if it happens going downhill, here's what to do.

- Stop your vehicle by applying the regular brakes. Apply the parking brake.
- Shift to **P** (Park) (or to Neutral with the manual transmission) and, while still braking, restart the engine.
- Shift back to a low gear, release the parking brake, and drive straight down.
- If the engine won't start, get out and get help.

### ***Driving Across an Incline***

Sooner or later, an off-road trail will probably go across the incline of a hill. If this happens, you have to decide whether to try to drive across the incline. Here are some things to consider:

## ***Your Driving and the Road***

---

- A hill that can be driven straight up or down may be too steep to drive across. When you go straight up or down a hill, the length of the wheel base (the distance from the front wheels to the rear wheels) reduces the likelihood the vehicle will tumble end over end. But when you drive across an incline, the much more narrow track width (the distance between the left and right wheels) may not prevent the vehicle from tilting and rolling over. Also, driving across an incline puts more weight on the downhill wheels. This could cause a downhill slide or a rollover.
- Surface conditions can be a problem when you drive across a hill. Loose gravel, muddy spots, or even wet grass can cause your tires to slip sideways, downhill. If the vehicle slips sideways, it can hit something that will trip it (a rock, a rut, etc.) and roll over.
- Hidden obstacles can make the steepness of the incline even worse. If you drive across a rock with the uphill wheels, or if the downhill wheels drop into a rut or depression, your vehicle can tilt even more.

For reasons like these, you need to decide carefully whether to try to drive across an incline. Just because the trail goes across the incline doesn't mean you have to drive it. The last vehicle to try it might have rolled over.

### **CAUTION**



Driving across an incline that's too steep will make your vehicle roll over. You could be seriously injured or killed. If you have any doubt about the steepness of the incline, don't drive across it. Find another route instead.

**Q: What if I'm driving across an incline that's not too steep, but I hit some loose gravel and start to slide downhill. What should I do?**

**A:** If you feel your vehicle starting to slide sideways, turn downhill. This should help straighten out the vehicle and prevent the side slipping. However, a much better way to prevent this is to get out and "walk the course" so you know what the surface is like before you drive it.

### ***Stalling on an Incline***

If your vehicle stalls when you're crossing an incline, be sure you (and your passengers) get out on the uphill side, even if the door there is harder to open. If you get out on the downhill side and the vehicle starts to roll over, you'll be right in its path.

If you have to walk down the slope, stay out of the path the vehicle will take if it does roll over.



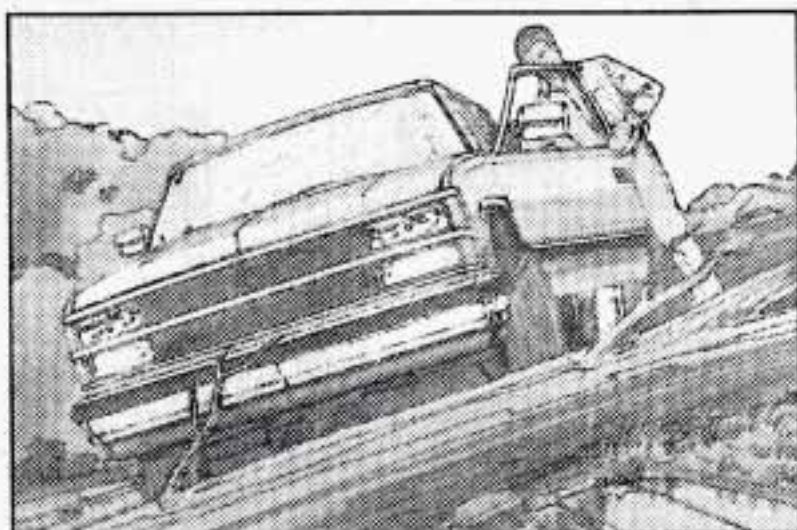

AM440002

## CAUTION



Getting out on the downhill (low) side of a vehicle stopped across an incline is dangerous. If the vehicle rolls over, you could be crushed or killed. Always get out on the uphill (high) side of the vehicle and stay well clear of the rollover path.

### ***Driving In Mud, Sand, Snow, Or Ice***

When you drive in mud, snow or sand, your wheels won't get good traction. You can't accelerate as quickly, turning is more difficult, and you'll need longer braking distances.

It's best to use a low gear when you're in mud—the deeper the mud, the lower the gear. In really deep mud, the idea is to keep your vehicle moving so you don't get stuck.

When you drive on sand, you'll sense a change in wheel traction. But it will depend upon how loosely packed the sand is. On loosely packed sand (as on beaches or sand dunes) your tires will tend to sink into the sand. This has an effect on steering, accelerating, and braking. You may want to reduce the air pressure in your tires slightly when driving on sand. This will improve traction.

Hard packed snow and ice offer the worst tire traction. On these surfaces, it's very easy to lose control. On wet ice, for example, the traction is so poor that you will have difficulty accelerating. And if you do get moving, poor steering and difficult braking can cause you to slide out of control.

## ***Your Driving and the Road***

---

### **CAUTION**



Driving on frozen lakes, ponds or rivers can be dangerous. Underwater springs, currents under the ice, or sudden thaws can weaken the ice. Your vehicle could fall through the ice and you and your passengers could drown. Drive your vehicle on safe surfaces only.

### ***Driving In Water***

Light rain causes no special off-road driving problems. But heavy rain can mean flash flooding, and flood waters demand extreme caution.

Find out how deep the water is before you drive through it. If it's deep enough to cover your wheel hubs, axles, or exhaust pipe, don't try it—you probably won't get through. Also, water that deep can damage your axle and other vehicle parts.

If the water isn't too deep, then drive through it slowly. At fast speeds, water splashes on your ignition system and your vehicle can stall. Stalling can also occur if you get your tailpipe under water. And, as long as your tailpipe is under water, you'll never be able to start your engine. When you go through water, remember that when your brakes get wet, it may take you longer to stop.

### **CAUTION**



Driving through rushing water can be dangerous. Deep water can sweep your vehicle downstream and you and your passengers could drown. If it's only inches deep, it can still wash away the ground from under your tires, and you could lose traction and roll the vehicle over. Don't drive through rushing water.

### ***After Off-Road Driving***

Remove any brush or debris that has collected on the underbody, chassis, or under the hood. These accumulations can be a fire hazard.

After operation in mud or sand, have the brake linings cleaned and checked. These substances can cause glazing and uneven braking. Check the body structure, steering, suspension, wheels, tires, and exhaust system for damage. Also, check the fuel lines and cooling system for any leakage.

Your vehicle will require more frequent service due to off-road use. Refer to Section 7 for additional information.

---

## ***Driving at Night***



AN450003

Night driving is more dangerous than day driving. One reason is that some drivers are likely to be impaired—by alcohol or drugs, with night vision problems, or by fatigue.

Here are some tips on night driving.

- Drive defensively. Remember, this is the most dangerous time.
- Don't drink and drive (See "Drunken Driving" in the Index for more on this problem).
- Adjust your inside rear view mirror to reduce the glare from headlights behind you.
- Since you can't see as well, you may need to slow down and keep more space between you and other vehicles. It's hard to tell how fast the vehicle ahead is going just by looking at its taillights.
- Slow down, especially on higher speed roads. Your headlights can light up only so much road ahead.
- In remote areas, watch for animals.
- If you're tired, pull off the road in a safe place and rest.

### ***Night Vision***

No one can see as well at night as in the daytime. But as we get older these differences increase. A 50-year-old driver may require at least twice as much light to see the same thing at night as a 20-year-old.

## ***Your Driving and the Road***

---

What you do in the daytime can also affect your night vision. For example, if you spend the day in bright sunshine you are wise to wear sunglasses. Your eyes will have less trouble adjusting to night.

But if you're driving, don't wear sunglasses at night. They may cut down on glare from headlights, but they also make a lot of things invisible that should remain visible—such as parked cars, obstacles, pedestrians, or even trains blocking railway crossings. You may want to put on your sunglasses after you have pulled into a brightly-lighted service or refreshment area. Eyes shielded from that glare may adjust more quickly to darkness back on the road. But be sure to remove your sunglasses before you leave the service area.

You can be temporarily blinded by approaching lights. It can take a second or two, or even several seconds, for your eyes to readjust to the dark. When you are faced with severe glare (as from a driver who doesn't lower the high beams, or a vehicle with misaimed headlights), slow down a little. Avoid staring directly into the approaching lights. If there is a line of opposing traffic, make occasional glances over the line of headlights to make certain that one of the vehicles isn't starting to move into your lane. Once you are past the bright lights, give your eyes time to readjust before resuming speed.

### ***High Beams***

If the vehicle approaching you has its high beams on, signal by flicking yours to high and then back to low beam. This is the usual signal to lower the headlight beams. If the other driver still doesn't lower the beams, resist the temptation to put your high beams on. This only makes two half-blinded drivers.

On a freeway, use your high beams only in remote areas where you won't impair approaching drivers. In some places, like cities, using high beams is illegal.

When you follow another vehicle on a freeway or highway, use low beams. True, most vehicles now have day-night mirrors that enable the driver to reduce glare. But outside mirrors are not of this type and high beams from behind can bother the driver ahead.

### ***A Few More Night Driving Suggestions***

Keep your windshield and all the glass on your vehicle clean—inside and out. Glare at night is made much worse by dirt on the glass. Even the inside of the glass can build up a film caused by dust. Tobacco smoke also makes inside glass surfaces very filmy and can be a vision hazard if it's left there.

Dirty glass makes lights dazzle and flash more than clean glass would, making the pupils of your eyes contract repeatedly. You might even want to

---

keep a cloth and some glass cleaner in your vehicle if you need to clean your glass frequently.

Remember that your headlights light up far less of a roadway when you are in a turn or curve.

Keep your eyes moving; that way, it's easier to pick out dimly lighted objects.

Just as your headlights should be checked regularly for proper aim, so should your eyes be examined regularly. Some drivers suffer from night blindness—the inability to see in dim light—and aren't even aware of it.

### ***Driving in the Rain***

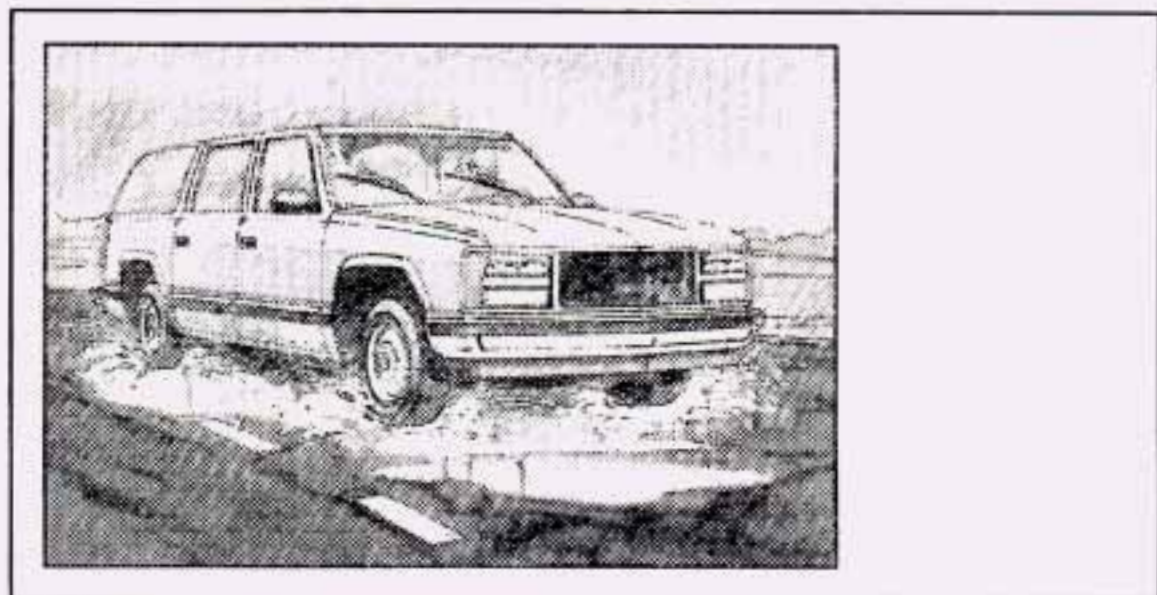

AN455012

Rain and wet roads can mean driving trouble. On a wet road you can't stop, accelerate or turn as well because your tire-to-road traction isn't as good as on dry roads. And, if your tires don't have much tread left, you'll get even less traction.

It's always wise to go slower and be cautious if rain starts to fall while you are driving. The surface may get wet suddenly when your reflexes are tuned for driving on dry pavement.

The heavier the rain, the harder it is to see. Even if your windshield wiper blades are in good shape, a heavy rain can make it harder to see road signs and traffic signals, pavement markings, the edge of the road, and even people walking. Road spray can often be worse for vision than rain, especially if it comes from a dirty road.

## ***Your Driving and the Road***

---

So it is wise to keep your wiping equipment in good shape and keep your windshield washer tank filled. Replace your windshield wiper inserts when they show signs of streaking or missing areas on the windshield, or when strips of rubber start to separate from the inserts.



AN455018

Driving too fast through large water puddles or even going through some car washes can cause problems, too. The water may affect your brakes. Try to avoid puddles. But if you can't, try to slow down before you hit them.

### **CAUTION**



Wet brakes can cause accidents. They won't work well in a quick stop and may cause pulling to one side. You could lose control of the vehicle.

After driving through a large puddle of water or a car wash, apply your brake pedal lightly until your brakes work normally.

### ***Hydroplaning***

Hydroplaning is dangerous. So much water can build up under your tires that they can actually ride on the water. This can happen if the road is wet enough and you're going fast enough. When your vehicle is hydroplaning, it has little or no contact with the road.

You might not be aware of hydroplaning. You could drive along for some time without realizing your tires aren't in constant contact with the road. You could find out the hard way: when you have to slow, turn, move out to pass—or if you get hit by a gust of wind. You could suddenly find yourself out of control.

---

---

Hydroplaning doesn't happen often. But it can if your tires haven't much tread or if the pressure in one or more is low. It can happen if a lot of water is standing on the road. If you can see reflections from trees, telephone poles, or other vehicles, and raindrops "dimple" the water's surface, there could be hydroplaning.

Hydroplaning usually happens on higher speed roads. There just isn't a hard and fast rule about hydroplaning. The best advice is to slow down when it is raining, and be careful.

### ***Some Other Rainy Weather Tips***

- Turn on your headlights—not just your parking lights—to help make you more visible to others.
- Look for hard-to-see vehicles coming from behind. You may want to use your headlights even in daytime if it's raining hard.
- Besides slowing down, allow some extra following distance. And be especially careful when you pass another vehicle. Allow yourself more clear room ahead, and be prepared to have your view restricted by road spray. If the road spray is so heavy you are actually blinded, drop back. Don't pass until conditions improve. Going more slowly is better than having an accident.
- Use your defogger if it helps.
- Have good tires with proper tread depth. (See "Tires" in the Index.)

# ***Your Driving and the Road***

---

## ***Driving in Fog, Mist and Haze***

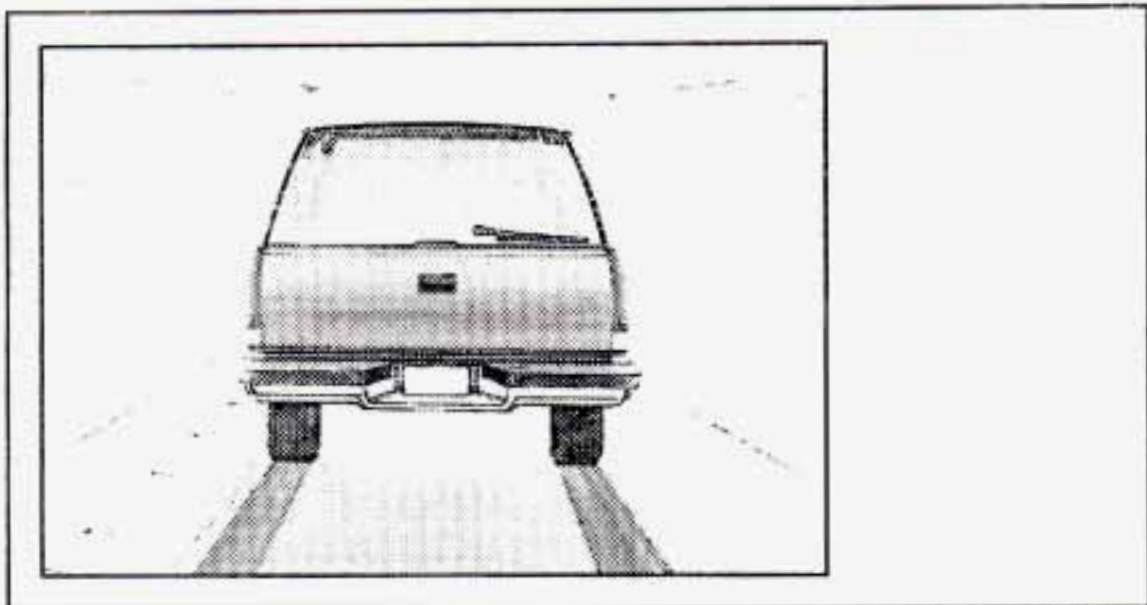

AN459006

Fog can occur with high humidity or heavy frost. It can be so mild that you can see through it for several hundred feet (meters). Or it might be so thick that you can see only a few feet (meters) ahead. It may come suddenly to an otherwise clear road. And it can be a major hazard.

When you drive into a fog patch, your visibility will be reduced quickly. The biggest dangers are striking the vehicle ahead or being struck by the one behind. Try to "read" the fog density down the road. If the vehicle ahead starts to become less clear or, at night, if the taillights are harder to see, the fog is probably thickening. Slow down to give traffic behind you a chance to slow down. Everybody then has a better chance to avoid hitting the vehicle ahead.

A patch of dense fog may extend only for a few feet (meters) or for miles (kilometers); you can't really tell while you're in it. You can only treat the situation with extreme care.

One common fog condition—sometimes called mist or ground fog—can happen in weather that seems perfect, especially at night or in the early morning in valley and low, marshy areas. You can be suddenly enveloped in thick, wet haze that may even coat your windshield. You can often spot these fog patches or mist layers with your headlights. But sometimes they can be waiting for you as you come over a hill or dip into a shallow valley. Start your windshield wipers and washer to help clear accumulated road dirt. Slow down carefully.



---

### ***Tips on Driving in Fog***

If you get caught in fog, turn your headlights on low beam, even in daytime. You'll see—and be seen—better. Use your fog lights if your vehicle has them.

Don't use your high beams. The light will bounce off the water droplets that make up fog and reflect back at you.

Use your defogger. In high humidity, even a light buildup of moisture on the inside of the glass will cut down on your already limited visibility. Run your windshield wiper and washer occasionally. Moisture can build up on the outside glass, and what seems to be fog may actually be moisture on the outside of your windshield.

Treat dense fog as an emergency. Try to find a place to pull off the road. Of course you want to respect another's property, but you might need to put something between you and moving vehicles—space, trees, telephone poles, a private driveway, anything that removes you from other traffic.

If visibility is near zero and you must stop but are unsure whether you are away from the road, turn your lights on, start your hazard warning flasher, and sound your horn at intervals or when you hear approaching traffic.

Pass other vehicles in fog only if you can see far enough ahead to pass safely. Even then, be prepared to delay your pass if you suspect the fog is worse up ahead. If other vehicles try to pass you, make it easy for them.

# ***Your Driving and the Road***

---

## ***City Driving***

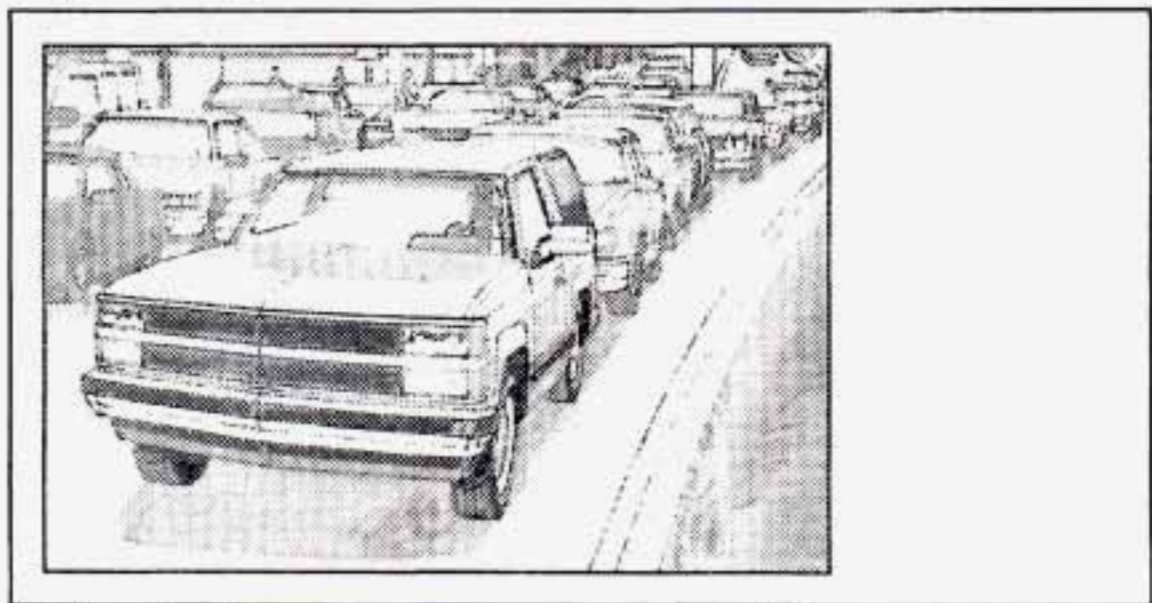

AN460004

One of the biggest problems with city streets is amount of traffic on them. You'll want to watch out for what the other drivers are doing and pay attention to traffic signals.

Here are ways to increase your safety in city driving:

- Know the best way to get to where you are going. Try not to drive around trying to pick out a familiar street or landmark. Get a city map and plan your trip into an unknown part of the city just as you would for a cross-country trip.
- Try to use the freeways that rim and crisscross most large cities. You'll save time and energy. (See the next section, "Freeway Driving.")
- Treat a green light as a warning signal. A traffic light is there because the corner is busy enough to need it. When a light turns green, and just before you start to move, check both ways for vehicles that have not cleared the intersection or may be running the red light.
- Obey all posted speed limits. But remember that they are for ideal road, weather and visibility conditions. You may need to drive below the posted limit in bad weather or when visibility is especially poor.
- Pull to the right (with care) and stop clear of intersections when you see or hear emergency vehicles.

---

---

## ***Freeway Driving***

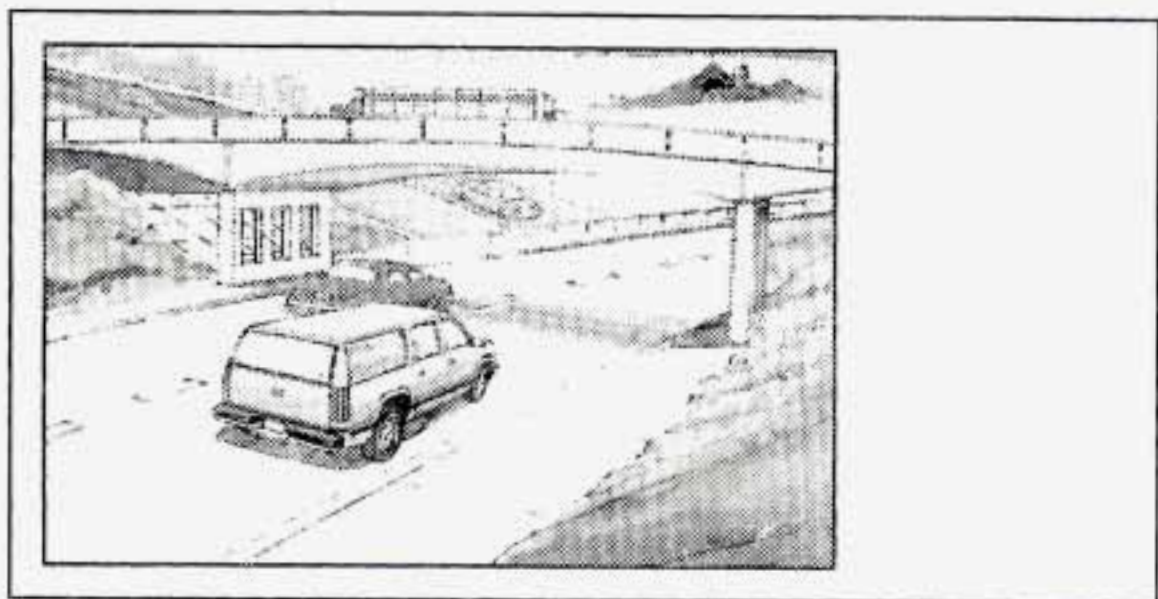

AN461005

Mile for mile, freeways (also called thruways, parkways, expressways, turnpikes, or superhighways) are the safest of all roads. But they have their own special rules.

The most important advice on freeway driving is: Keep up with traffic and keep to the right. Drive at the same speed most of the other drivers are driving. Too-fast or too-slow driving breaks a smooth traffic flow. Treat the left lane on a freeway as a passing lane.

### ***Entering the Freeway***

At the entrance there is usually a ramp that leads to the freeway. If you have a clear view of the freeway as you drive along the entrance ramp, you should begin to check traffic. Try to determine where you expect to blend with the flow. If traffic is light, you may have no problem. But if it is heavy, find a gap as you move along the entering lane and time your approach. Try to merge into the gap at close to the prevailing speed. Switch on your turn signal, check your rearview mirrors as you move along, and glance over your shoulder as often as necessary. Try to blend smoothly with the traffic flow.

### ***Driving on the Freeway***

Once you are on the freeway, adjust your speed to the posted limit or to the prevailing rate if it's slower. Stay in the right lane unless you want to pass. If you are on a two-lane freeway, treat the right lane as the slow lane and the left lane as the passing lane. If you are on a three-lane freeway, treat the right lane as the slower-speed through lane, the middle lane as the higher-speed through lane, and the left lane as the passing lane.

## ***Your Driving and the Road***

---

Before changing lanes, check your rearview mirrors. Then use your turn signal. Just before you leave the lane, glance quickly over your shoulder to make sure there isn't another vehicle in your "blind" spot.

If you are moving from an outside to a center lane on a freeway having more than two lanes, make sure another vehicle isn't about to move into the same spot. Look at the vehicles two lanes over and watch for telltale signs: turn signals flashing, an increase in speed, or moving toward the edge of the lane. Be prepared to delay your move.

Once you are moving on the freeway, make certain you allow a reasonable following distance. Expect to move slightly slower at night.

### ***Leaving the Freeway***

When you want to leave the freeway, move to the proper lane well in advance. Dashing across lanes at the last minute is dangerous. If you miss your exit do not, under any circumstances, stop and back up. Drive on to the next exit.

At each exit point is a deceleration lane. Ideally it should be long enough for you to enter it at freeway speed (after signaling, of course) and then do your braking before moving onto the exit ramp. Unfortunately, not all deceleration lanes are long enough—some are too short for all the braking. Decide when to start braking. If you must brake on the through lane, and if there is traffic close behind you, you can allow a little extra time and flash your brake lights (in addition to your turn signal) as extra warning that you are about to slow down and exit.

The exit ramp can be curved, sometimes quite sharply. The exit speed is usually posted. Reduce your speed according to your speedometer, not to your sense of motion. After driving for any distance at higher speeds, you may tend to think you are going slower than you actually are. For example, 40 mph (65 km/h) might seem like only 20 mph (30 km/h). Obviously, this could lead to serious trouble on a ramp designed for 20 mph (30 km/h)!

### ***Driving a Long Distance***

Although most long trips today are made on freeways, there are still many made on regular highways.

Long-distance driving on freeways and regular highways is the same in some ways. The trip has to be planned and the vehicle prepared, you drive at higher-than-city speeds, and there are longer turns behind the wheel. You'll enjoy your trip more if you and your vehicle are in good shape. Here are some tips for a successful long trip.

---

### ***Before Leaving on a Long Trip***

Make sure you're ready. Try to be well rested. If you must start when you're not fresh—such as after a day's work—don't plan to make too many miles that first part of the journey. Wear comfortable clothing and shoes you can easily drive in.

Is your vehicle ready for a long trip? If you keep it serviced and maintained, it's ready to go. If it needs service, have it done before starting out. Of course, you'll find experienced and able service experts in your vehicle's dealerships all across North America. They'll be ready and willing to help if you need it.

Here are some things you can check before a trip:

- **Windshield Washer Fluid:** Is the reservoir full? Are all windows clean inside and outside?
- **Wiper Blades:** Are they in good shape?
- **Fuel, Engine Oil, Other Fluids:** Have you checked all levels?
- **Lights:** Are they all working? Are the lenses clean?
- **Tires:** They are vitally important to a safe, trouble-free trip. Is the tread good enough for long distance driving? Are the tires all inflated to the recommended pressure?
- **Weather Forecasts:** What's the weather outlook along your route? Should you delay your trip a short time to avoid a major storm system?
- **Maps:** Do you have up-to-date maps?

### ***On the Road***

Unless you are the only driver, it is good to share the driving task with others. Limit turns behind the wheel to about 100 miles (160 km) or two hours at a sitting. Then, either change drivers or stop for some refreshment like coffee, tea or soft drinks and some limbering up. But do stop and move around. Eat lightly along the way. Heavier meals tend to make some people sleepy.

On two-lane highways or undivided multilane highways that do not have controlled access, you'll want to watch for some situations not usually found on freeways. Examples are: stop signs and signals, shopping centers with direct access to the highway, no passing zones and school zones, vehicles turning left and right off the road, pedestrians, cyclists, parked vehicles, and even animals.

# ***Your Driving and the Road***

---

## ***Highway Hypnosis***

Is there actually such a condition as “highway hypnosis?” Or is it just plain falling asleep at the wheel? Call it highway hypnosis, lack of awareness, or whatever.

There is something about an easy stretch of road with the same scenery, along with the hum of the tires on the road, the drone of the engine, and the rush of the wind against the vehicle that can make you sleepy. Don't let it happen to you! If it does, your vehicle can leave the road in **less than a second**, and you could crash and be injured.

What can you do about highway hypnosis? First, be aware that it can happen.

Then here are some tips:

- Make sure your vehicle is well ventilated, with a comfortably cool interior.
- Keep your eyes moving. Scan the road ahead and to the sides. Check your rearview mirrors frequently and your instruments from time to time. This can help you avoid a fixed stare.
- Wear good sunglasses in bright light. Glare can cause drowsiness. But don't wear sunglasses at night. They will drastically reduce your overall vision at the very time you need all the seeing power you have.
- If you get sleepy, pull off the road into a rest, service, or parking area and take a nap, get some exercise, or both. For safety, treat drowsiness on the highway as an emergency.

As in any driving situation, keep pace with traffic and allow adequate following distances.

---

---

## Hill and Mountain Roads

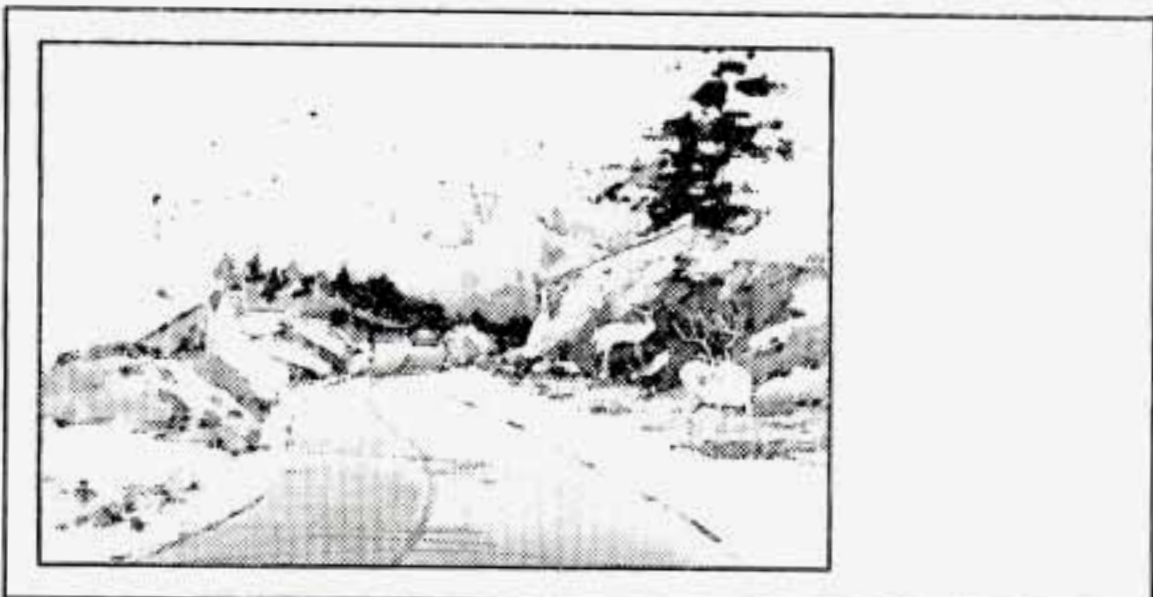

AM470001

Driving on steep hills or mountains is different from driving in flat or rolling terrain. If you drive regularly in steep country, or if you're planning to visit there, here are some tips that can make your trips safer and more enjoyable.

(See "Off-Road" in the Index for information about driving off-road.)

- Keep your vehicle in good shape. Check all fluid levels and also the brakes, tires, cooling system and transmission. These parts can work hard on mountain roads.
- Know how to go down hills. The most important thing to know is this: let your engine do some of the slowing down. Don't make your brakes do it all. Shift to a lower gear when you go down a steep or long hill. That way, you will slow down without excessive use of your brakes.

### CAUTION



If you don't shift down, your brakes could get so hot that they wouldn't work well. You would then have poor braking or even none going down a hill. You could crash. Shift down to let your engine assist your brakes on a steep downhill slope.

## ***Your Driving and the Road***

---

### **CAUTION**



Coasting downhill in **N** (Neutral) or with the ignition off is dangerous. Your brakes will have to do all the work of slowing down. They could get so hot that they wouldn't work well. You could crash. Always have your engine running and your vehicle in gear when you go downhill.

- Know how to go uphill. You may want to shift down to a lower gear. The lower gears help cool your engine and transmission, and you can climb the hill better.
- Stay in your own lane when driving on two-lane roads in hills or mountains. Don't swing wide or cut across the center of the road. Drive at speeds that let you stay in your own lane. That way, you won't be surprised by a vehicle coming toward you in the same lane.
- It takes longer to pass another vehicle when you're going uphill. You'll want to leave extra room to pass. If a vehicle is passing you and doesn't have enough room, slow down to make it easier for the other vehicle to get by.
- As you go over the top of a hill, be alert. There could be something in your lane, like a stalled car or an accident.
- You may see highway signs on mountains that warn of special problems. Examples are long grades, passing or no-passing zones, a falling rocks area, or winding roads. Be alert to these and take appropriate action.
- Winter driving can present special problems. See "Winter Driving" in the Index.



---

## *Parking on Hills*



AM470025

Hills and mountains mean spectacular scenery. But please be careful where you stop if you decide to look at the view or take pictures. Look for pull-offs or parking areas provided for scenic viewing.

Another part of this manual tells how to use your parking brake (see "Parking Brake" in the Index). But on a mountain or steep hill, you can do one more thing. You can turn your front wheels to keep your vehicle from rolling downhill or out into traffic.

## ***Your Driving and the Road***

---

Here's how:

### ***Downhill Parking***

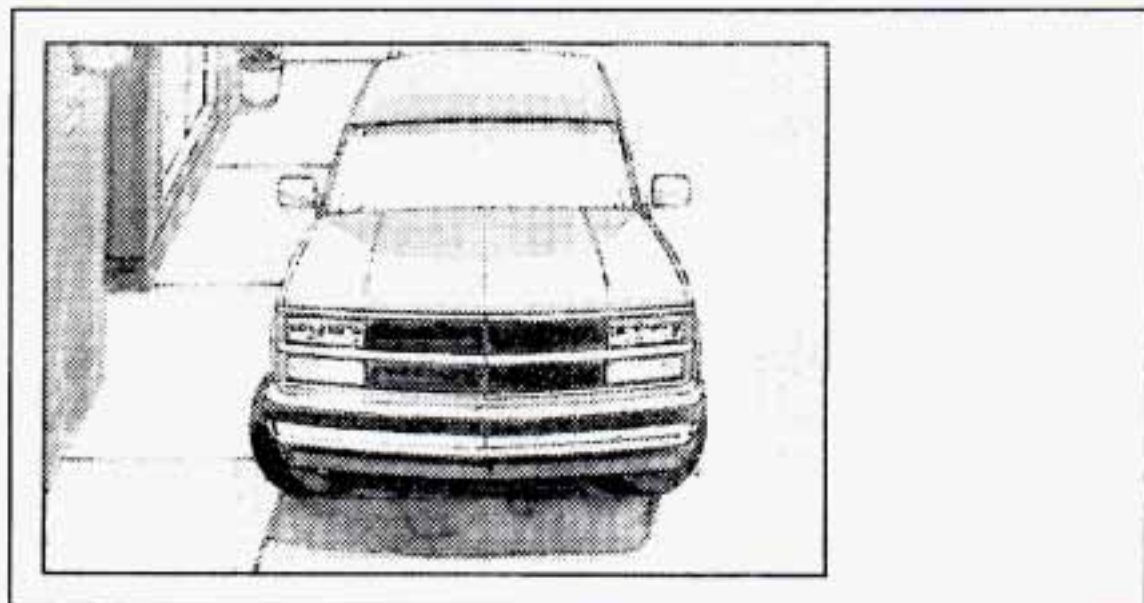

AN470032

Turn your wheels to the right.

You don't have to jam your tires against the curb, if there is a curb. A gentle contact is all you need.

## ***Parking Uphill***

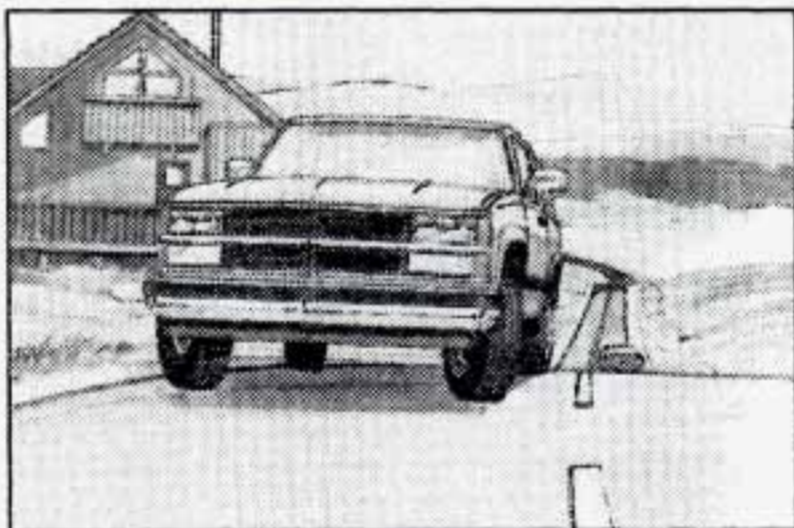

AN470039

If there is a curb, turn your wheels to the left if the curb is at the right side of your vehicle.



AN470046

If you're going uphill on a one-way street and you're parking on the left side, your wheels should point to the right.

## ***Your Driving and the Road***

---

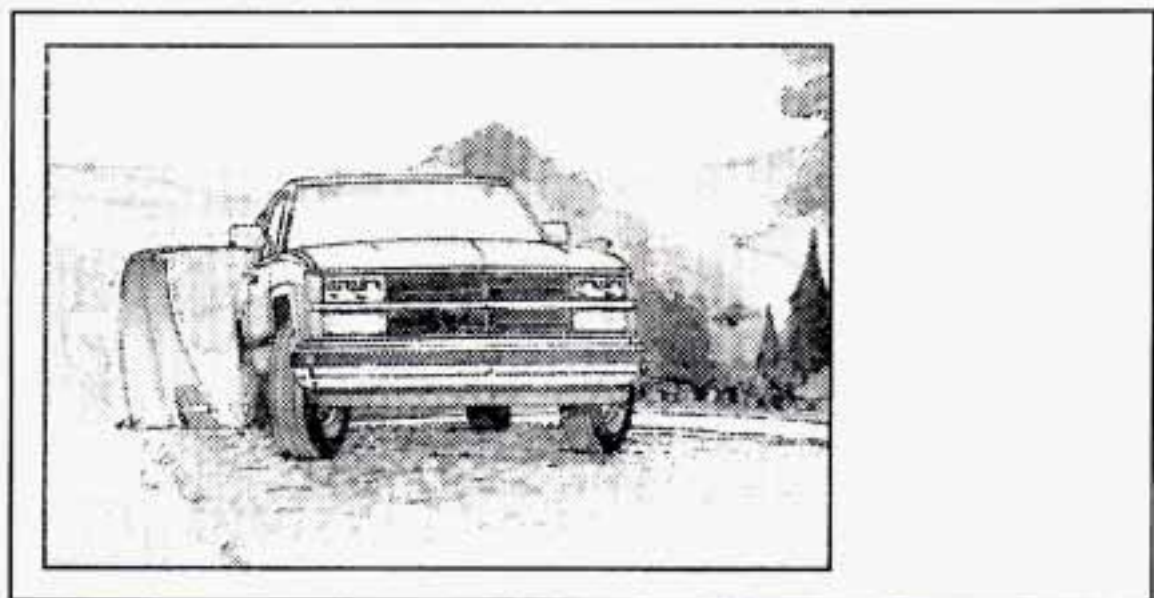

AN470054

If there is no curb when you're parking uphill, turn the wheels to the right.

If there is no curb when you're parking uphill on the left side of a one-way street, your wheels should be turned to the left.

### ***Torque Lock (Automatic Transmission)***

If you are parking on a hill and you don't shift your transmission into **P** (Park) properly, the weight of the vehicle may put too much force on the parking pawl in the transmission. You may find it difficult to pull the shift lever out of **P** (Park). This is called "torque lock." To prevent torque lock, always be sure to shift into **P** (Park) before you leave the driver's seat. To find out how, see "Shifting Into **P** (Park)" in the Index.

When you are ready to drive, move the selector lever out of **P** (Park) **BEFORE** you release the parking brake.

If "torque lock" does occur, you may need to have another vehicle push yours a little uphill to take some of the pressure from the transmission, so you can pull the shift lever out of **P** (Park).

---

---

## **Winter Driving**

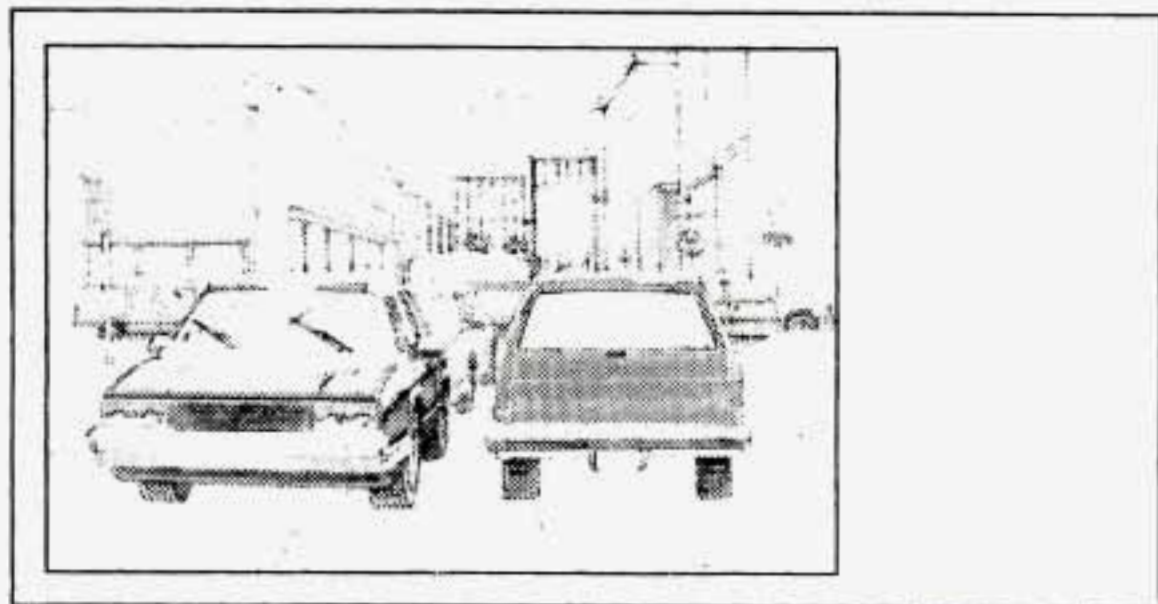

AM480003

Here are some tips for winter driving.

- Have your vehicle in good shape for winter. Be sure your engine coolant mix is correct.
- Snow tires can help in loose snow, but they may give you less traction on ice than regular tires. If you do not expect to be driving in deep snow, but may have to travel over ice, you may not want to switch to snow tires at all.
- You may want to put winter emergency supplies in your vehicle.

Include an ice scraper, a small brush or broom, a supply of windshield washer fluid, a rag, some winter outer clothing, a small shovel, a flashlight, a red cloth, and a couple of reflective warning triangles. And, if you will be driving under severe conditions, include a small bag of sand, a piece of old carpet or a couple of burlap bags to help provide traction. Be sure you properly secure these items in your vehicle.

### ***Driving on Snow or Ice***

Most of the time, those places where your tires meet the road probably have good traction.

However, if there is snow or ice between your tires and the road, you can have a very slippery situation. You'll have a lot less traction or "grip" and will need to be very careful.

## **Your Driving and the Road**

---

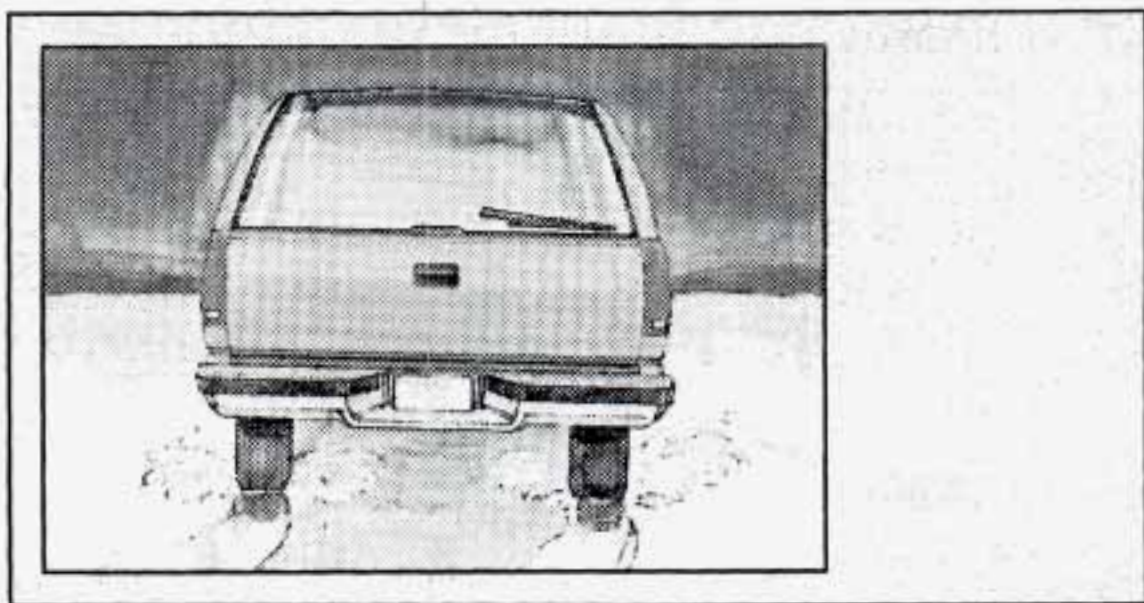

AN480018

What's the worst time for this? "Wet ice." Very cold snow or ice can be slick and hard to drive on. But wet ice can be even more trouble because it may offer the least traction of all. You can get "wet ice" when it's about freezing (32°F, 0°C) and freezing rain begins to fall. Try to avoid driving on wet ice until salt and sand crews can get there.

Whatever the condition—smooth ice, packed, blowing or loose snow—drive with caution. Accelerate gently. Try not to break the fragile traction. If you accelerate too fast, the drive wheels will spin and polish the surface under the tires even more.

Your anti-lock brakes improve your ability to make a hard stop on a slippery road. Even though you have the anti-lock braking system, you'll want to begin stopping sooner than you would on dry pavement. See "Anti-lock" in the Index.

Allow greater following distances on any slippery road.

- Watch for slippery spots. The road might be fine until you hit a spot that's covered with ice. On an otherwise clear road, ice patches may appear in shaded areas where the sun can't reach: around clumps of trees, behind buildings, or under bridges. Sometimes the surface of a curve or an overpass may remain icy when the surrounding roads are clear. If you see a patch of ice ahead of you, brake before you are on it. Try not to brake while you're actually on the ice, and avoid sudden steering maneuvers.

## *If You're Caught in a Blizzard*



AN480030

If you are stopped by heavy snow, you could be in a serious situation. You should probably stay with your vehicle unless you know for sure that you are near help and you can hike through the snow. Here are some things to do to summon help and keep yourself and your passengers safe: Turn on your hazard flashers. Tie a red cloth to your vehicle to alert police that you've been stopped by the snow. Put on extra clothing or wrap a blanket around you. If you have no blankets or extra clothing, make body insulators from newspapers, burlap bags, rags, floor mats—anything you can wrap around yourself or tuck under your clothing to keep warm.

You can run the engine to keep warm, but be careful.

### **CAUTION**



Snow can trap exhaust gases under your vehicle. This can cause deadly CO (carbon monoxide) gas to get inside. CO could overcome you and kill you. You can't see it or smell it, so you might not know it is in your vehicle. Clear away snow from around the base of your vehicle, especially any that is blocking your exhaust pipe. And check around again from time to time to be sure snow doesn't collect there.

Open a window just a little on the side of the vehicle that's away from the wind. This will help keep CO out.

## ***Your Driving and the Road***

---



AN480044

Run your engine only as long as you must. This saves fuel. When you run the engine, make it go a little faster than just idle. That is, push the accelerator slightly. This uses less fuel for the heat that you get and it keeps the battery charged. You will need a well-charged battery to restart the vehicle, and possibly for signaling later on with your headlights. Let the heater run for awhile. Then, shut the engine off and close the window almost all the way to preserve the heat. Start the engine again and repeat this only when you feel really uncomfortable from the cold. But do it as little as possible. Preserve the fuel as long as you can. To help keep warm, you can get out of the vehicle and do some fairly vigorous exercises every half hour or so until help comes.

### ***If You're Stuck in Deep Snow***

This manual explains how to get the vehicle out of deep snow without damaging it. See "Rocking Your Vehicle" in the Index.

## ***Towing a Trailer***

### **CAUTION**



If you don't use the correct equipment and drive properly, you can lose control when you pull a trailer. For example, if the trailer is too heavy, the brakes may not work well—or even at all. You and your passengers could be seriously injured. Pull a trailer only if you have followed all the steps in this section.



---

---

## NOTICE

Pulling a trailer improperly can damage your vehicle and result in costly repairs not covered by your warranty. To pull a trailer correctly, follow the advice in this section.

Every vehicle is ready for some trailer towing. If it was built with trailering options, as many are, it's ready for heavier trailers. But trailering is different than just driving your vehicle by itself. Trailering means changes in handling, durability, and fuel economy. Successful, safe trailering takes correct equipment, and it has to be used properly.

That's the reason for this section. In it are many time-tested, important trailering tips and safety rules. Many of these are important for your safety and that of your passengers. So please read this section carefully before you pull a trailer.

### ***If You Do Decide To Pull A Trailer***

If you do, here are some important points.

- There are many different laws having to do with trailering. Make sure your rig will be legal, not only where you live but also where you'll be driving. A good source for this information can be state or provincial police.
- Consider using sway control with a utility model if your trailer will weigh 3,000 pounds (1361 kg) or less, or with a wagon model if your trailer will weigh 4,000 pounds (1800 kg) or less. You should always use sway control with a utility model if your trailer will weigh more than 3,000 pounds (1361 kg), or with a wagon model if your trailer will weigh more than 4,000 pounds (1800 kg). You can ask a hitch dealer about sway controls.
- Don't tow a trailer at all during the first 500 miles (800 km) your new vehicle is driven. Your engine, axle, or other parts could be damaged.
- Then, during the first 500 miles (800 km) that you tow a trailer, don't drive over 50 mph (80 km/h) and don't make starts at full throttle. That will help your engine and other parts of your vehicle wear in at the heavier loads.

## ***Your Driving and the Road***

---

- Three important considerations have to do with weight:

### ***Weight of the Trailer***

How heavy can a trailer safely be?

- For utility vehicles, a trailer should never weigh more than 7,000 pounds (3175.2 kg).
- For wagon models, a trailer should never weigh more than 10,000 pounds (6125.6 kg).

But even that can be too heavy. It depends on how you plan to use your rig. For example, speed, altitude, road grades, outside temperature, and how much your vehicle is used to pull a trailer all are important. And, it can also depend on any special equipment that you have on your vehicle. You can ask your dealer for our trailering information or advice, or you can write us at the address listed in your Warranty and Owner Assistance Information Booklet.

In Canada, write to:

General Motors of Canada Limited  
Customer Assistance Center  
1908 Colonel Sam Drive  
Oshawa, Ontario L1H 8P7

### ***Weight of the Trailer Tongue***

The tongue load (A) of any trailer is an important weight to measure because it affects the total, gross weight of your vehicle. The gross vehicle weight (GVW) includes the curb weight of the vehicle, any cargo you may carry in it, and the people who will be riding in the vehicle. And if you will tow a trailer, you must add the tongue load to the GVW because your vehicle will be carrying that weight, too. See "Loading Your Vehicle" in the Index for more information about your vehicle's maximum load capacity.

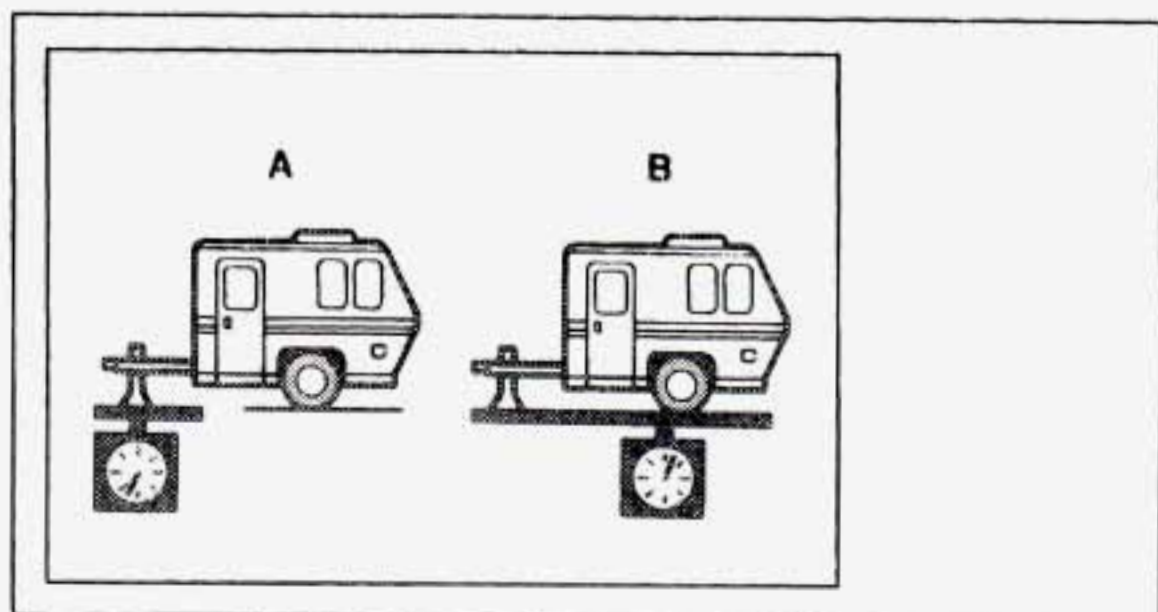

AN490002

If you're using a "dead-weight" hitch, the trailer tongue (A) should weigh 10% of the total loaded trailer weight (B). If you have a "weight-distributing" hitch, the trailer tongue (A) should weigh 12% of the total loaded trailer weight (B). After you've loaded your trailer, weigh the trailer and then the tongue, separately, to see if the weights are proper. If they aren't, you may be able to get them right simply by moving some items around in the trailer.

### **Total Weight on Your Vehicle's Tires**

Be sure your vehicle's tires are inflated to the limit for cold tires. You'll find these numbers on the Certification label at the rear edge of the driver's door (or see "Loading Your Vehicle" in the Index). Then be sure you don't go over the GVW limit for your vehicle.

### **Hitches**

It's important to have the correct hitch equipment. Crosswinds, large trucks going by, and rough roads are a few reasons why you'll need the right hitch. Here are some rules to follow:

- If your vehicle has a step bumper and you are going to use a ball-type hitch, remove the pad and cut holes in it to match the hitch and safety chain holes in the bumper.
- If you'll be pulling a trailer with a utility model that, when loaded, will weigh more than 3,000 pounds (1361 kg); or with a wagon model that when loaded, will weigh more than 4,000 pounds (1800 kg), be sure to use a properly mounted weight-distributing hitch and sway control of the proper size. This equipment is very important for proper vehicle loading and good handling when you're driving.

## ***Your Driving and the Road***

---

- Will you have to make any holes in the body of your vehicle when you install a trailer hitch? If you do, then be sure to seal the holes later when you remove the hitch. If you don't seal them, deadly carbon monoxide (CO) from your exhaust can get into your vehicle (see "Carbon Monoxide" in the Index). Dirt and water can, too.

### ***Safety Chains***

You should always attach chains between your vehicle and your trailer. Cross the safety chains under the tongue of the trailer so that the tongue will not drop to the road if it becomes separated from the hitch. Instructions about safety chains may be provided by the trailer manufacturer. Follow the manufacturer's recommendation for attaching safety chains. Always leave just enough slack so you can turn with your rig. And, never allow safety chains to drag on the ground.

### ***Trailer Brakes***

If your trailer weighs more than 1,000 pounds (450 kg) loaded, then it needs its own brakes—and they must be adequate. Be sure to read and follow the instructions for the trailer brakes so you'll be able to install, adjust and maintain them properly.

Don't tap into your vehicle's brake system if the trailer's brake system will use more than 0.02 cubic inch (0.3 cc) of fluid from your vehicle's master cylinder. If it does, both braking systems won't work well. You could even lose your brakes.

- Will the trailer brake parts take 3,000 psi (20 650 kPa) of pressure? If not, the trailer brake system must not be used with your vehicle.
- If everything checks out this far, then make the brake fluid tap at the port on the master cylinder that sends fluid to the rear brakes. But don't use copper tubing for this. If you do, it will bend and finally break off. Use steel brake tubing.

### ***Driving with a Trailer***

Towing a trailer requires a certain amount of experience. Before setting out for the open road, you'll want to get to know your rig. Acquaint yourself with the feel of handling and braking with the added weight of the trailer. And always keep in mind that the vehicle you are driving is now a good deal longer and not nearly so responsive as your vehicle is by itself.

Before you start, check the trailer hitch and platform, safety chains, electrical connector, lights, tires and mirror adjustment. If the trailer has electric brakes, start your vehicle and trailer moving and then apply the trailer brake controller by hand to be sure the brakes are working. This lets you check your electrical connection at the same time.

## CAUTION



If you have a rear-most window open and you pull a trailer with your vehicle, carbon monoxide (CO) could come into your vehicle. You can't see or smell CO. It can cause unconsciousness or death (See "Engine Exhaust" in the Index). To maximize your safety when towing a trailer:

- Have the exhaust system inspected for leaks and make necessary repairs before starting on your trip.
- Keep the rear-most windows closed.
- If exhaust does come into your vehicle through a window in the rear or another opening, drive with your front, main heating or cooling system **on** and with the fan on any speed. This will bring fresh, outside air into your vehicle. Do not use **RECIR** because it only recirculates the air inside your vehicle. See "Comfort Controls" in the Index.

During your trip, check occasionally to be sure that the load is secure, and that the lights and any trailer brakes are still working.

### ***Following Distance***

Stay at least twice as far behind the vehicle ahead as you would when driving your vehicle without a trailer. This can help you avoid situations that require heavy braking and sudden turns.

### ***Passing***

You'll need more passing distance up ahead when you're towing a trailer. And, because you're a good deal longer, you'll need to go much farther beyond the passed vehicle before you can return to your lane.

### ***Backing Up***

Hold the bottom of the steering wheel with one hand. Then, to move the trailer left, just move your hand to the left. To move the trailer to the right, move your hand to the right. Always back up slowly and, if possible, have someone guide you.

### ***Making Turns***

When you're turning with a trailer, make wider turns than normal. Do this so your trailer wheels won't strike soft shoulders, curbs, road signs, trees, or other objects. Avoid jerky or sudden maneuvers. Signal well in advance.

# ***Your Driving and the Road***

---

## ***Turn Signals When Towing a Trailer***

When you tow a trailer, your vehicle has to have a different turn signal flasher and extra wiring. The green arrows on your instrument panel will flash whenever you signal a turn or lane change. Properly hooked up, the trailer lights will also flash, telling other drivers you're about to turn, change lanes, or stop.

When towing a trailer, the green arrows on your instrument panel will flash for turns even if the bulbs on the trailer are burned out. Thus, you may think drivers behind you are seeing your signal when they are not. It's important to check occasionally to be sure the trailer bulbs are still working.

## ***Driving on Grades***

Reduce speed and shift to a lower gear **before** you start down a long or steep downgrade. If you don't shift down, you might have to use your brakes so much that they would get hot and no longer work well.

On a long uphill grade, shift down and reduce your speed to 45 mph (70 km/h) or less to reduce the possibility of engine and transmission overheating.

If you have an automatic transmission, you should use **D** (or, as you need to, a lower gear) when towing a trailer. Operating your vehicle in **D** when towing a trailer will minimize heat buildup and extend the life of your transmission. Or, if you have a manual transmission with fifth gear and you are towing a trailer, it's better not to use fifth gear, just drive in fourth gear (or, as you need to, a lower gear).

## ***Parking on Hills***

You really should not park your rig on a hill. If something goes wrong, your rig could start to move. People can be injured and both your vehicle and the trailer can be damaged.

But if you ever have to park your rig on a hill, here's how to do it:

1. Apply your regular brakes, but don't shift into **P** (Park) yet, or into gear for a manual transmission.
2. Have someone place chocks under the trailer wheels.
3. When the wheel chocks are in place, release the regular brakes until the chocks absorb the load.
4. Reapply the regular brakes. Then apply your parking brake, and then shift to **P** (Park), or **R** (Reverse) for a manual transmission.
5. If you have a four-wheel-drive vehicle, be sure the transfer case is in a drive gear—not in **N** (Neutral).

6. Release the regular brakes.

## CAUTION



It can be dangerous to get out of your vehicle if the shift lever is not fully in **P** (Park) with the parking brake firmly set. Your vehicle can roll.

If you have left the engine running, the vehicle can move suddenly. You or others could be injured. To be sure your vehicle won't move, when you're on fairly level ground, use the steps that follow.

If you have four-wheel drive and your transfer case is in **N** (Neutral), your vehicle will be free to roll, even if your shift lever is in **P** (Park). So, be sure the transfer case is in a drive gear—not in **N** (Neutral).

If you are parking on a hill, or if you're pulling a trailer, also see "Parking On Hills" in the Index.

### ***When You Are Ready to Leave After Parking on a Hill***

1. Apply your regular brakes and hold the pedal down while you:
  - Start your engine.
  - Shift into a gear; and
  - Release the parking brake.
2. Let up on the brake pedal.
3. Drive slowly until the trailer is clear of the chocks.
4. Stop and have someone pick up and stow the chocks.

### ***Maintenance When Trailer Towing***

Your vehicle will need service more often when you're pulling a trailer. See the Maintenance Schedule for more on this. Things that are especially important in trailer operation are automatic transmission fluid (don't overfill), engine oil, axle lubricant, belts, cooling system, and brake adjustment. Each of these is covered in this manual, and the Index will help you find them quickly. If you're trailering, it's a good idea to review these sections before you start your trip.

Check periodically to see that all hitch nuts and bolts are tight.

## ***Your Driving and the Road***

---

### ***Trailer Wiring Harness***

See "Trailer Wiring Harness" in the Index.

### ***Power Winches***

If you wish to use a power winch on your vehicle, only use it when your vehicle is stationary or anchored.

#### **NOTICE**

When operating a power winch on your vehicle always leave the transmission in the neutral position. Do not leave an automatic transmission in **P** (Park) or a manual transmission in gear or the transmission may be damaged.

Use the regular brakes, set the parking brake or block the wheels to keep your vehicle from rolling.



# Problems on the Road

---



## Section

# 5

Here you'll find what to do about some problems that can occur on the road.

Hazard Warning Flashers .....	5-2
Other Warning Devices .....	5-3
Jump Starting .....	5-3
Towing Your Vehicle .....	5-7
Engine Overheating .....	5-8
Engine Fan Noise .....	5-16
If a Tire Goes Flat .....	5-16
Changing a Flat Tire .....	5-16
Storing the Jack and Tire .....	5-30
If You're Stuck: In Sand, Mud, Ice or Snow .....	5-31

## **Problems on the Road**

---

### **Hazard Warning Flashers**

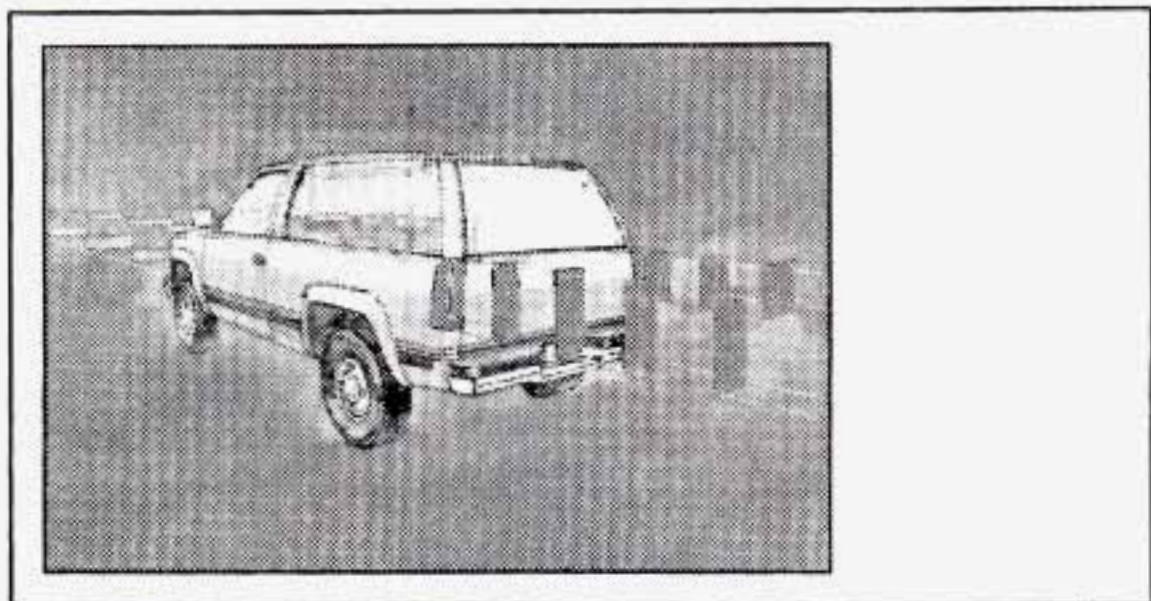

AN505005

Your hazard warning flashers let you warn others. They also let police know you have a problem. Your front and rear turn signal lights flash on and off. But they won't flash if you are braking.

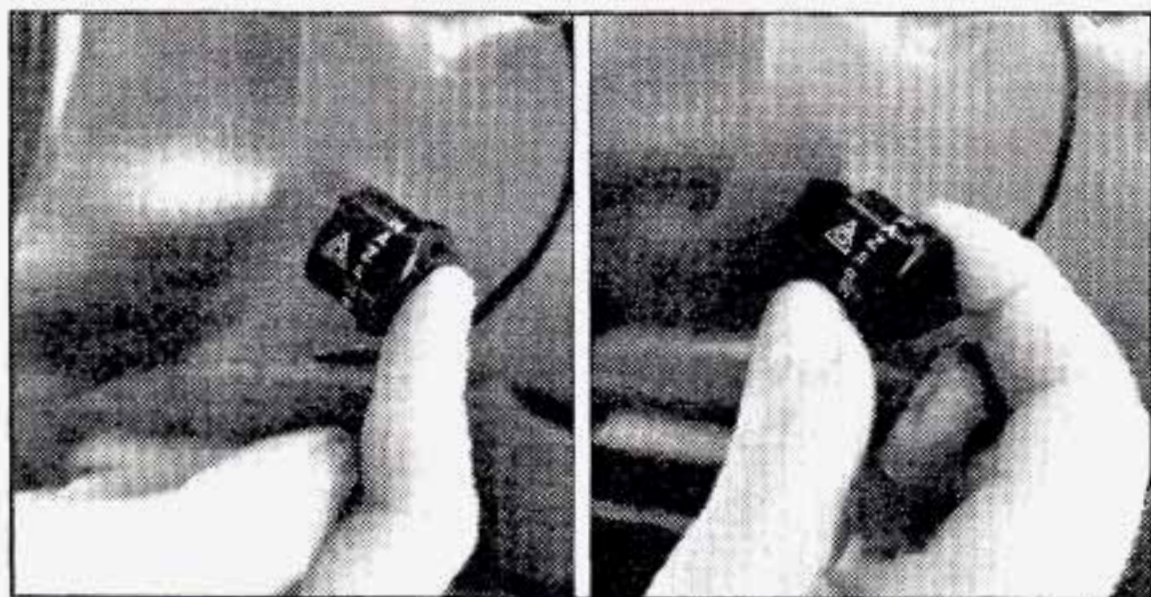

K2503

Press the button in to make your front and rear turn signal lights flash on and off.

Your hazard warning flashers work no matter what position your key is in, and even if the key isn't in.

---

To turn off the flashers, pull out on the collar.

When the hazard warning flashers are on, your turn signals won't work.

## **Other Warning Devices**

If you carry reflective triangles, you can set one up at the side of the road about 300 feet (100 m) behind your vehicle.

## **Jump Starting**

If your battery has run down, you may want to use another vehicle and some jumper cables to start your vehicle. But please follow the steps below to do it safely.

### **CAUTION**



Batteries can hurt you. They can be dangerous because:

- They contain **acid** that can burn you.
- They contain **gas** that can explode or ignite.
- They contain enough **electricity** to burn you.

If you don't follow these steps exactly, some or all of these things can hurt you.

### **NOTICE**

Ignoring these steps could result in costly damage to your vehicle that wouldn't be covered by your warranty.

Trying to start your vehicle by pushing or pulling it could damage your vehicle, even if you have a manual transmission. And if you have an automatic transmission, it won't start that way.

### **To Jump Start Your Vehicle**

1. Check the other vehicle. It must have a 12-volt battery with a negative ground system.

### **NOTICE**

If the other system isn't a 12-volt system with a negative ground, both vehicles can be damaged.

2. Get the vehicles close enough so the jumper cables can reach, but be sure the vehicles aren't touching each other. If they are, it could cause a

## Problems on the Road

ground connection you don't want. You wouldn't be able to start your vehicle, and the bad grounding could damage the electrical systems.

### CAUTION



You could be injured if the vehicles roll. Set the parking brake firmly on each vehicle. Put an automatic transmission in **P** (Park) or a manual transmission in **N** (Neutral).

If you have a four-wheel-drive vehicle, be sure the transfer case is not in **N** (Neutral).

3. Turn off the ignition on both vehicles. Turn off all lights that aren't needed, and radios. This will avoid sparks and help save both batteries. And it could save your radio!

### NOTICE

If you leave a radio on, it could be badly damaged. The repairs wouldn't be covered by your warranty.

4. Open the hoods and locate the batteries.

Find the positive (+) and negative (—) terminals on each battery.

### CAUTION



Using a match near a battery can cause battery gas to explode. People have been hurt doing this, and some have been blinded. Use a flashlight if you need more light.

Be sure the batteries have enough water. You don't need to add water to the Delco Freedom<sup>®</sup> battery installed in every new GM vehicle. But if a battery has filler caps, be sure the right amount of fluid is there. If it is low, add water to take care of that first. If you don't, explosive gas could be present.

Battery fluid contains acid that can burn you. Don't get it on you. If you accidentally get it in your eyes or on your skin, flush the place with water and get medical help immediately.

5. Check that the jumper cables don't have loose or missing insulation. If they do, you could get a shock. The vehicles could be damaged, too.  
Before you connect the cables, here are some things you should know. Positive (+) will go to positive (+) and negative (—) will go to negative

(-) or a metal engine part. Don't connect (+) to (-) or you'll get a short that would damage the battery and maybe other parts, too.

## CAUTION

 Fans or other moving engine parts can injure you badly. Keep your hands away from moving parts once the engines are running.

6. Connect the red positive (+) cable to the positive (+) terminal of the vehicle with the dead battery. Use a remote positive (+) terminal if the vehicle has one.

*Dead Battery*

*Good Battery*

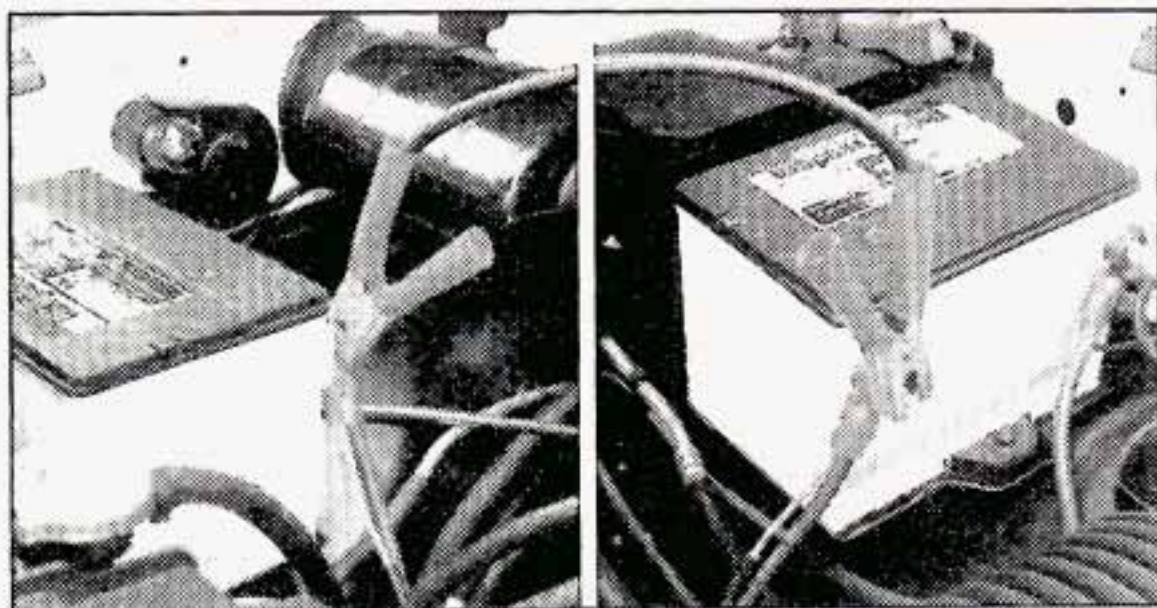

K2504

7. Don't let the other end touch metal. Connect it to the positive (+) terminal of the good battery. Use a remote positive (+) terminal if the vehicle has one.
8. Now connect the black negative (-) cable to the good battery's negative (-) terminal.

Don't let the other end touch anything until the next step. The other end of the negative cable **doesn't** go to the dead battery. It goes to a heavy unpainted metal part on the engine of the vehicle with the dead battery.

9. Attach the cable at least 18 inches (45 cm) away from the dead battery, but not near engine parts that move. The electrical connection is just as good there, but the chance of sparks getting back to the battery is much less.

## Problems on the Road

*Good Battery*

*Dead Battery*

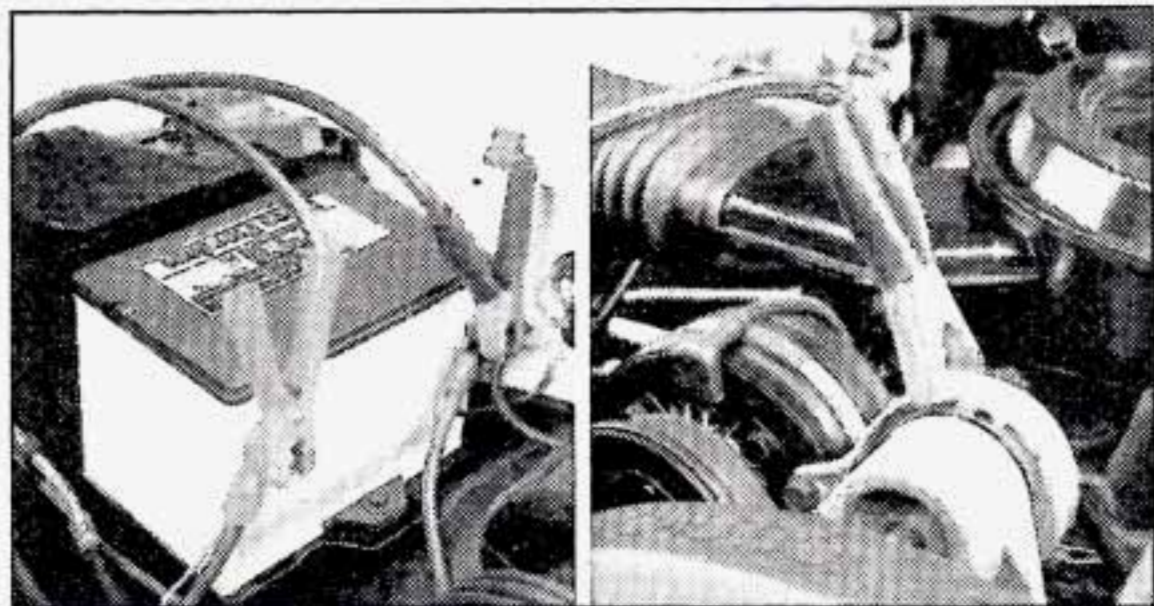

K2506

10. Now start the vehicle with the good battery and run the engine for awhile.
11. Try to start the vehicle with the dead battery.  
If it won't start after a few tries, it probably needs service.
12. Remove the cables in reverse order to prevent electrical shorting. Take care that they don't touch each other or any other metal.

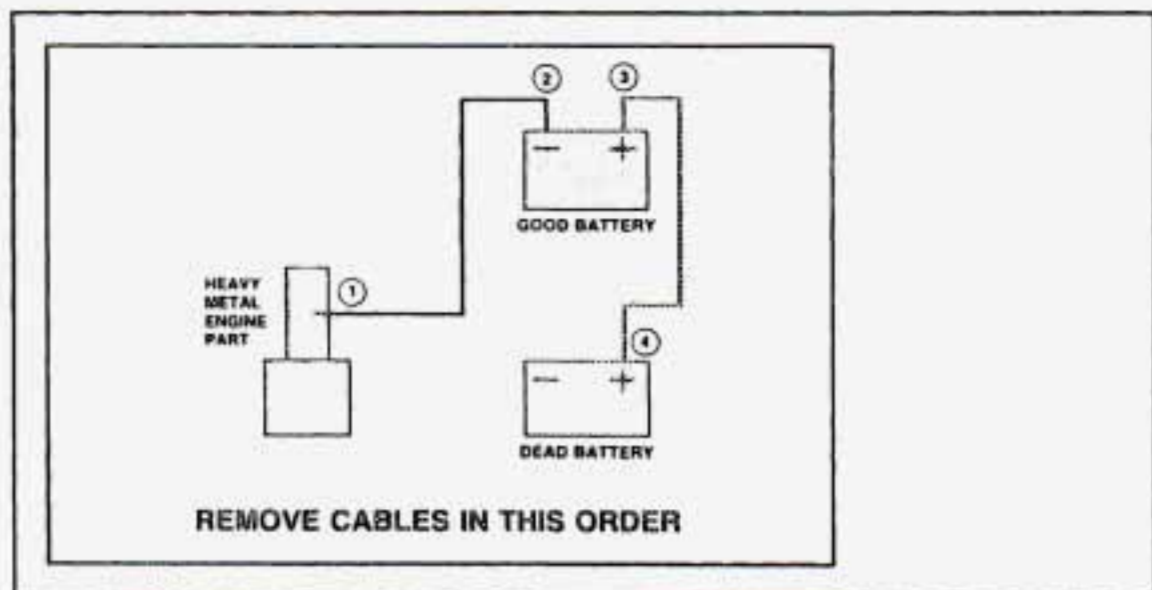

K1508

---

---

## **Towing Your Vehicle**

Try to have a GM dealer or a professional towing service tow your vehicle. They can provide the right equipment and know how to tow it without damage.

If your vehicle has been changed since it was factory-new, by adding things like fog lamps, aero skirting, or special tires and wheels, these things could be damaged during towing.

Before you do anything, turn on the hazard warning flashers.

When you call, tell the towing service:

- That your vehicle has rear-wheel drive, or that it has the four-wheel drive option.
- The make, model, and year of your vehicle.
- Whether you can move the shift lever for the transmission and transfer case, if you have one.
- If there was an accident, what was damaged.

### **CAUTION**



To help avoid injury to you or others:

- Never let passengers ride in a vehicle that is being towed.
- Never tow faster than safe or posted speeds.
- Never tow with damaged parts not fully secured.
- Never get under your vehicle after it has been lifted by the tow truck.
- Always use separate safety chains on each side when towing a vehicle.

When your vehicle is being towed, have the ignition key off. The steering wheel should be clamped in a straight-ahead position, with a clamping device designed for towing service. Do not use the vehicle's steering column lock for this. The transmission and transfer case, if you have one, should be in Neutral and the parking brake released.

If you have a two-wheel drive vehicle, don't have your vehicle towed on the rear wheels, unless you must. If the vehicle must be towed on the rear wheels, don't go more than 35 mph (56 km/h) or farther than 50 miles (80 km) or your transmission will be damaged. If these limits must be exceeded, then the rear drive wheels have to be supported on a dolly.

## ***Problems on the Road***

---

If your vehicle has the four-wheel-drive option and the transfer case is engaged, a dolly must be used under the rear wheels when towing from the front.

### ***Engine Overheating***

You will find a coolant temperature gage on your vehicle instrument panel.

#### ***If Steam Is Coming From Your Engine:***

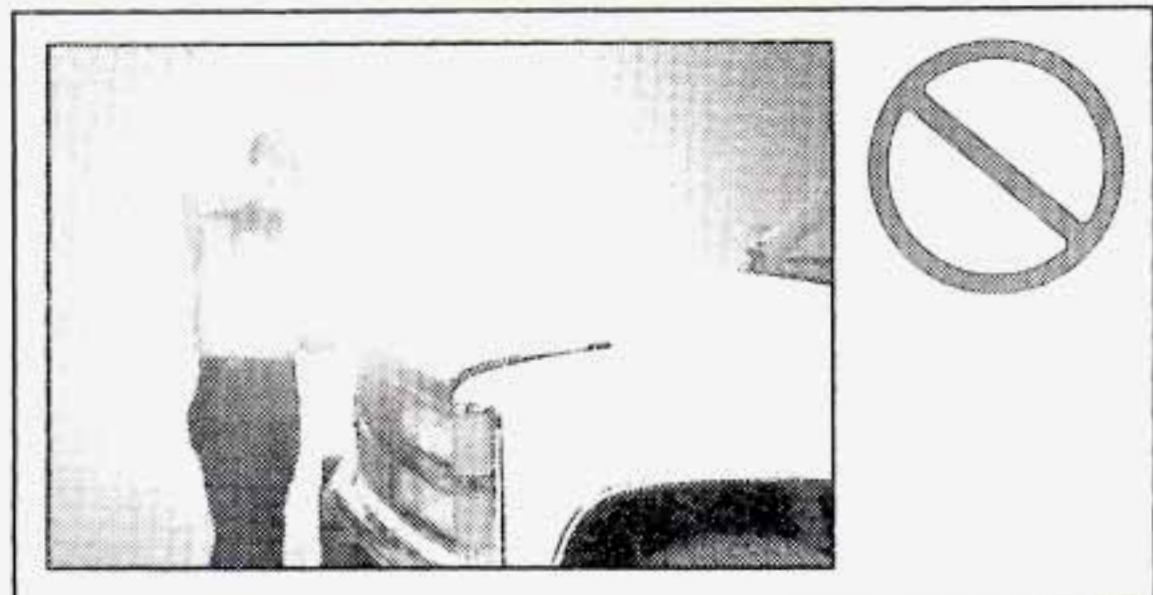

K2509

### **CAUTION**



Steam from an overheated engine can burn you badly, even if you just open the hood. Stay away from the engine if you see or hear steam coming from it. Just turn it off and get everyone away from the vehicle until it cools down. Wait until there is no sign of steam or coolant before opening the hood.

If you keep driving when your engine is overheated, the liquids in it can catch fire. You or others could be badly burned. Stop your engine if it overheats, and get out of the vehicle until the engine is cool.

### **NOTICE**

If your engine catches fire because you keep driving with no coolant your vehicle can be badly damaged. The costly repairs would not be covered by your warranty.



---

---

### ***If No Steam Is Coming From Your Engine:***

If you get the overheat warning but see or hear no steam, the problem may not be too serious. Sometimes the engine can get a little too hot when you:

- Climb a long hill on a hot day.
- Stop after high speed driving.
- Idle for long periods in traffic.
- Tow a trailer.

If you get the overheat warning with no sign of steam, try this for a minute or so:

1. If you have an air conditioner, turn it off.
2. Turn on your heater to full hot at the highest fan speed and open the window as necessary.
3. If you're in a traffic jam, shift to **N** (Neutral).

If you no longer have the overheat warning, you can drive. Just to be safe, drive slower for about ten minutes. If the warning doesn't come back on, you can drive normally.

If the warning continues, pull over, stop, and park your vehicle right away.

If there's still no sign of steam, push the accelerator until the engine speed is about twice as fast as normal idle speed. Bring the engine speed back to normal idle speed after two or three minutes. Now see if the warning stops. But then, if you still have the warning, **TURN OFF THE ENGINE AND GET EVERYONE OUT OF THE VEHICLE** until it cools down.

You may decide not to lift the hood but to get service help right away.

## Problems on the Road

### Cooling System

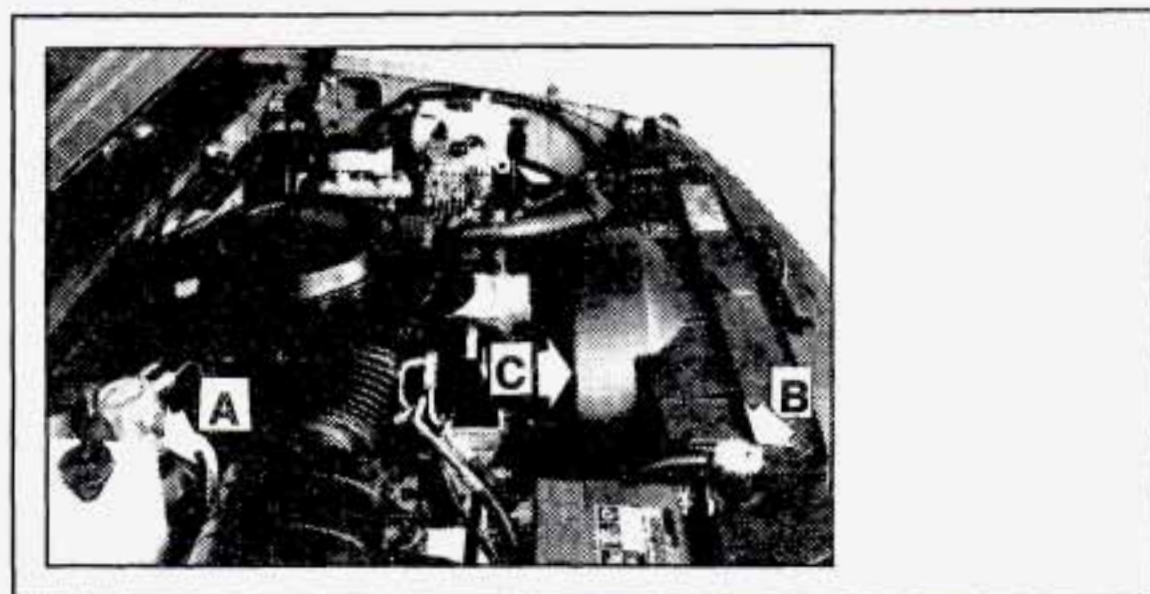

P0210

When you decide it's safe to lift the hood, here's what you'll see:

- A. Coolant recovery tank
- B. Radiator pressure cap
- C. Engine fan

#### CAUTION



An electric fan under the hood can start up even when the engine is not running and can injure you. Keep hands, clothing, and tools away from any underhood electric fan.

If the coolant inside the coolant recovery tank or surge tank is boiling, don't do anything else until it cools down.

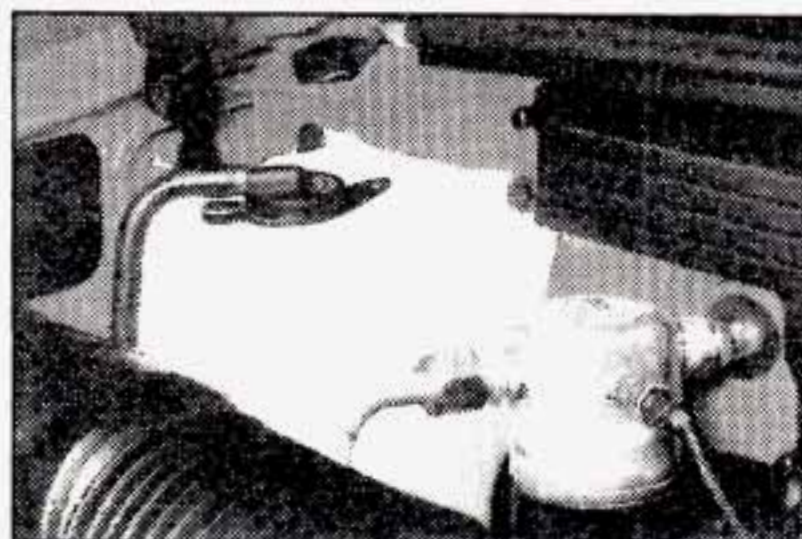

P0593

The coolant level should be at or above **COLD**. If it isn't, you may have a leak in the radiator hoses, heater hoses, radiator, water pump or somewhere else in the cooling system.

## CAUTION



Heater and radiator hoses, and other engine parts, can be very hot. Don't touch them. If you do, you can be burned.

Don't run the engine if there is a leak. If you run the engine, it could lose all coolant. That could cause an engine fire, and you could be burned. Get any leak fixed before you drive the vehicle.

## NOTICE

Engine damage from running your engine without coolant isn't covered by your warranty.

If there seems to be no leak, check to see if the electric engine fan (if you have one) is running. If the engine is overheating, the fan should be running. If it isn't, your vehicle needs service.

Start the engine again to see if the regular fan runs when the engine does. If it doesn't, your vehicle needs service. Turn off the engine.

### ***How to Add Coolant to the Coolant Recovery Tank***

If you haven't found a problem yet, but the coolant level isn't at or above **COLD**, add a 50/50 mixture of **clean water** (preferably distilled) and a proper

## Problems on the Road

antifreeze at the coolant recovery tank. (See "Coolant" in the Index for more information about the proper coolant mix.)

### CAUTION



Adding only plain water to your cooling system can be dangerous. Plain water, or some other liquid like alcohol, can boil before the proper coolant mix will. Your vehicle's coolant warning system is set for the proper coolant mix. With plain water or the wrong mix, your engine could get too hot but you wouldn't get the overheat warning. Your engine could catch fire and you or others could be burned. Use a 50/50 mix of **clean water** and a proper antifreeze.

### NOTICE

In cold weather, water can freeze and crack the engine, radiator, heater core and other parts. Use the recommended coolant.



P0206

### CAUTION



You can be burned if you spill coolant on hot engine parts. Coolant contains ethylene glycol and it will burn if the engine parts are hot enough. Don't spill coolant on a hot engine.

When the coolant in the coolant recovery is at or above **COLD**, start your vehicle.

---

---

If the overheat warning continues, there's one more thing you can try. You can add the proper coolant mix directly to the radiator, but be sure the radiator is cool before you do it.

## CAUTION



Steam and scalding liquids from a hot cooling system can blow out and burn you badly. They are under pressure, and if you turn the radiator pressure cap—even a little—they can come out at high speed. Never turn the cap when the cooling system, including the radiator pressure cap, is hot. Wait for the cooling system and radiator pressure cap to cool if you ever have to turn the pressure cap.



K2511

### ***How to Add Coolant to the Radiator***

1. You can remove the radiator pressure cap when the cooling system, including the radiator pressure cap and upper radiator hose is no longer hot. Turn the pressure cap slowly to the left until it first stops. (Don't press down while turning the pressure cap.)

If you hear a hiss, wait for that to stop. A hiss means there is still some pressure left.

## Problems on the Road

---

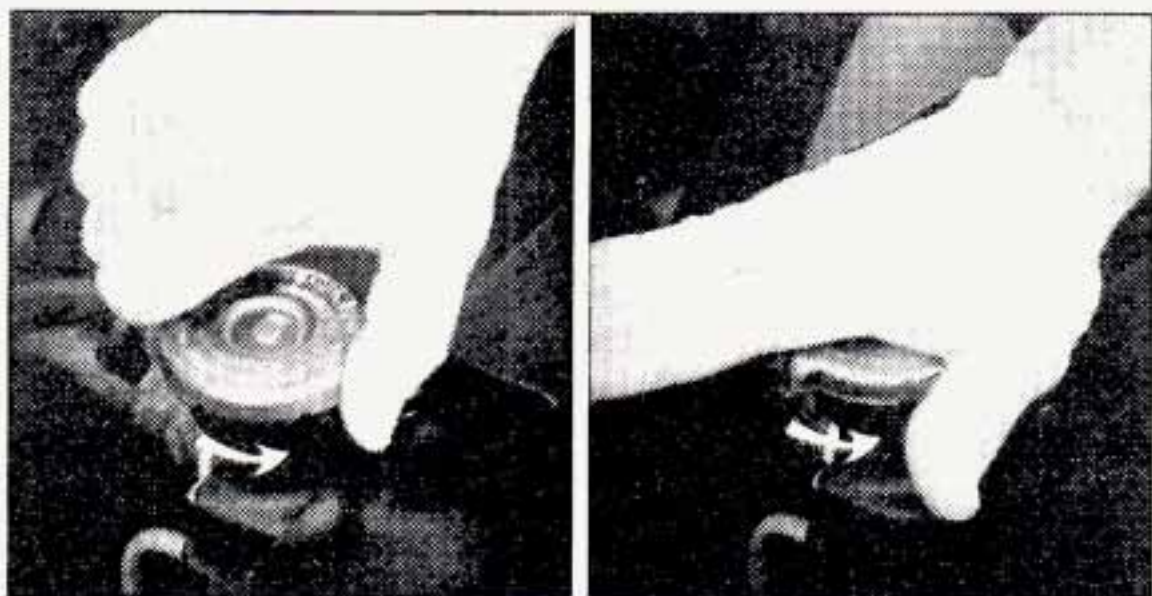

P0244

2. Then keep turning the pressure cap, but now push down as you turn it. Remove the pressure cap.

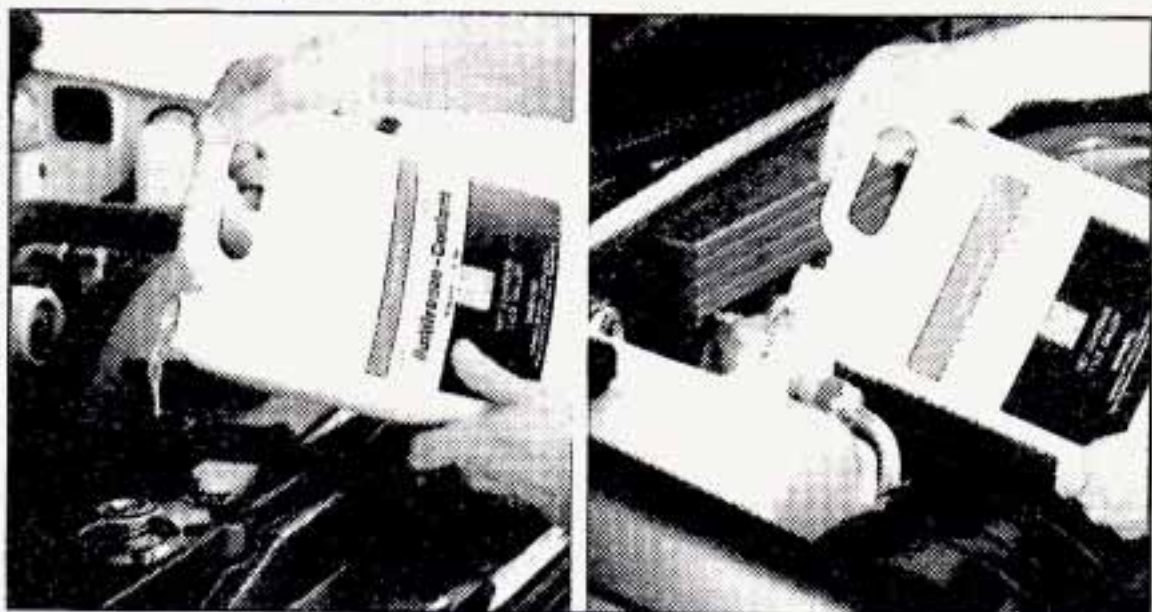

K2341

3. Fill the radiator with the proper mix, up to the base of the filler neck.
4. Then fill the coolant recovery tank to **COLD**.
5. Put the cap back on the coolant recovery tank, but leave the radiator pressure cap off.

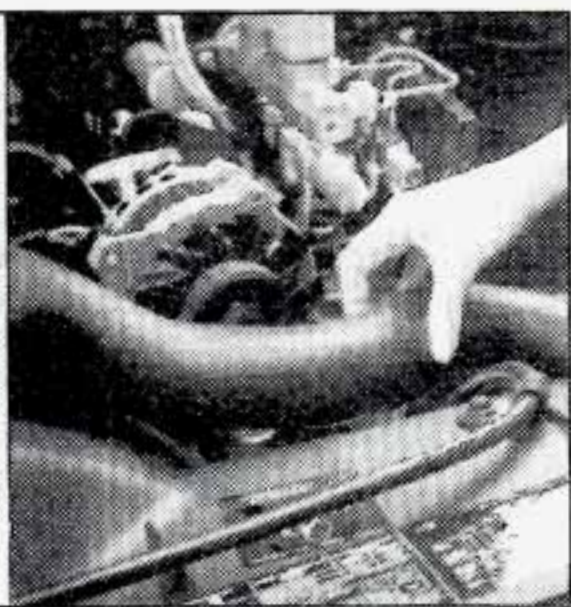
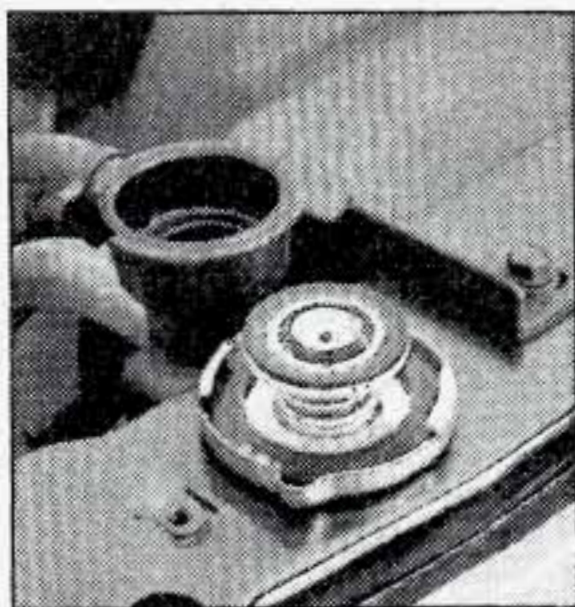

K2550

6. Start the engine and let it run until you can feel the upper radiator hose getting hot. Watch out for the engine fan(s).
7. By this time, the coolant level inside the radiator filler neck may be lower. If the level is lower, add more of the proper mix through the filler neck until the level reaches the base of the filler neck.

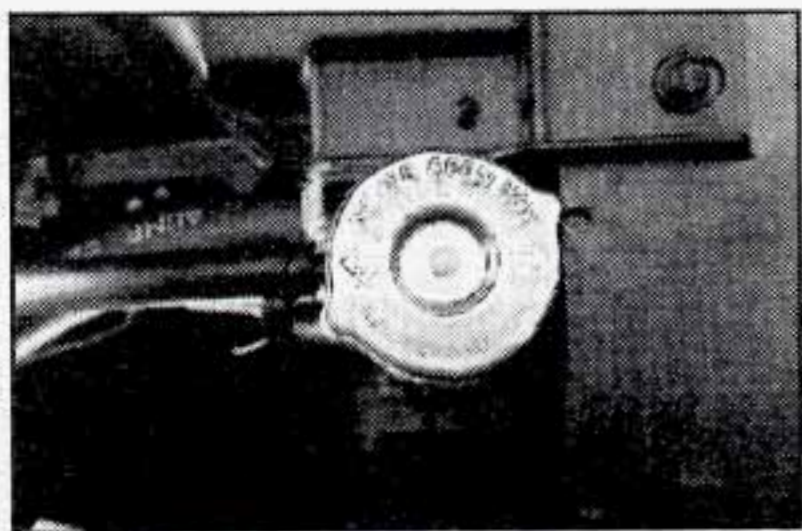

K2515

8. Then replace the pressure cap. Be sure the arrows on the pressure cap line up like this.

## ***Problems on the Road***

---

### ***Engine Fan Noise***

This vehicle has a clutched engine cooling fan. When the clutch is engaged, the fan spins faster to provide more air to cool the engine. In most every day driving conditions the clutch is not engaged. This improves fuel economy and reduces fan noise. Under heavy vehicle loading, trailer towing and/or high outside temperatures, the fan speed increases when the clutch engages. So you may hear an increase in fan noise. This is normal and should not be mistaken as the transmission slipping or making extra shifts. It is merely the cooling system functioning properly. The fan will slow down when additional cooling is not required and the clutch disengages.

You may also hear this fan noise when you start the engine. It will go away as the fan clutch disengages.

### ***If a Tire Goes Flat***

It's unusual for a tire to "blow out" while you're driving, especially if you maintain your tires properly. If air goes out of a tire, it's much more likely to leak out slowly. But if you should ever have a "blowout," here are a few tips about what to expect and what to do:

If a front tire fails, the flat tire will create a drag that pulls the vehicle toward that side. Take your foot off the accelerator pedal and grip the steering wheel firmly. Steer to maintain lane position, then gently brake to a stop well out of the traffic lane.

A rear blowout, particularly on a curve, acts much like a skid and may require the same correction you'd use in a skid. In any rear blowout, remove your foot from the accelerator pedal. Get the vehicle under control by steering the way you want the vehicle to go. It may be very bumpy and noisy, but you can still steer. Gently brake to a stop, well off the road if possible.

If your tire goes flat, the next part shows how to use your jacking equipment to change a flat tire safely.

### ***Changing a Flat Tire***

If a tire goes flat, avoid further tire and wheel damage by driving slowly to a level place. Turn on your hazard warning flashers.



## CAUTION



Changing a tire can cause an injury. The vehicle can slip off the jack and roll over you or other people. You and they could be badly injured. Find a level place to change your tire. To help prevent the vehicle from moving:

1. Set the parking brake firmly.
2. Put the shift lever in **P** (Park).
3. Shift a manual transmission to **1** (First) or **R** (Reverse).
4. If you have a four-wheel-drive vehicle, be sure the transfer case is in a drive gear—not in **N** (Neutral).
5. Turn off the engine.

To be even more certain the vehicle won't move, you can put chocks at the front and rear of the tire farthest away from the one being changed. That would be the tire on the other side of the vehicle, at the opposite end.



AN545005

The following steps will tell you how to use the jack and change a tire.

The equipment you'll need is located in the rear cargo area. You'll also find your spare tire there.

## ***Problems on the Road***

---

### ***Spare Tire***

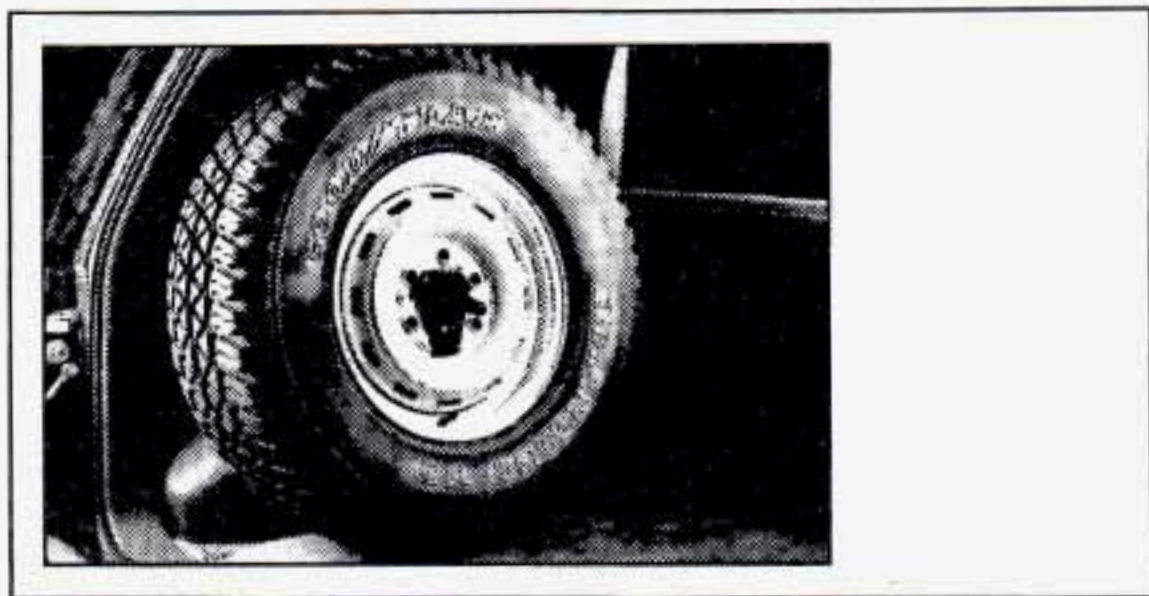

K2122

First open the tire cover, if you have one. Turn the wing nut counterclockwise and take it, and the adapter, off the bolt. Take the tire out of the vehicle and remove the tire cover.

### ***Jack and Tools***

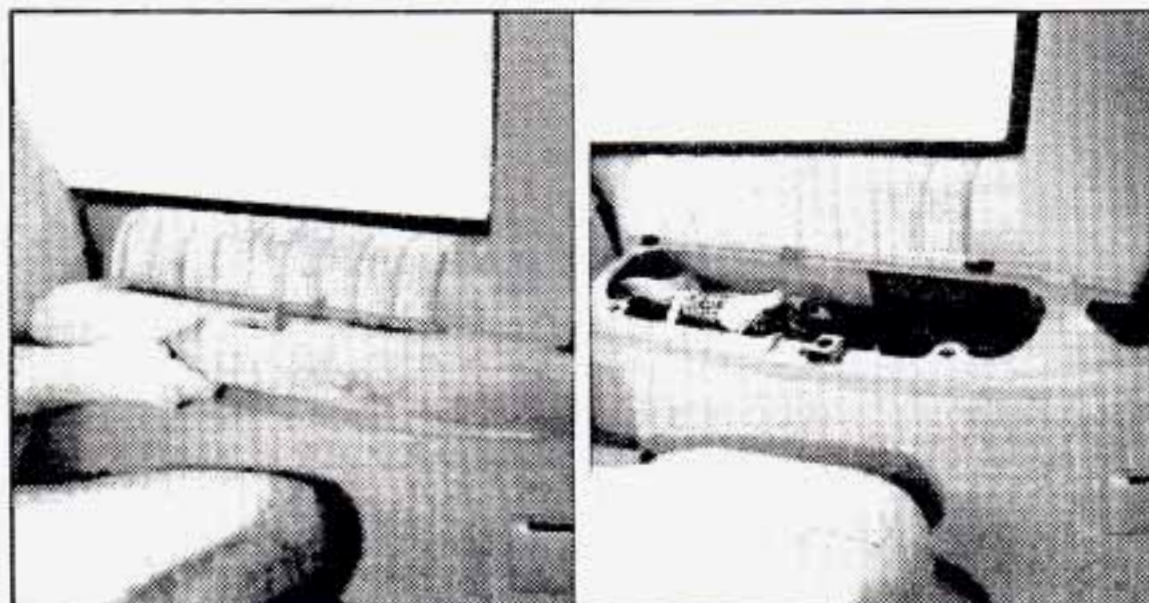

P0287

If your wagon model has a jack cover, lift the tab up to release the cover, then take it off.

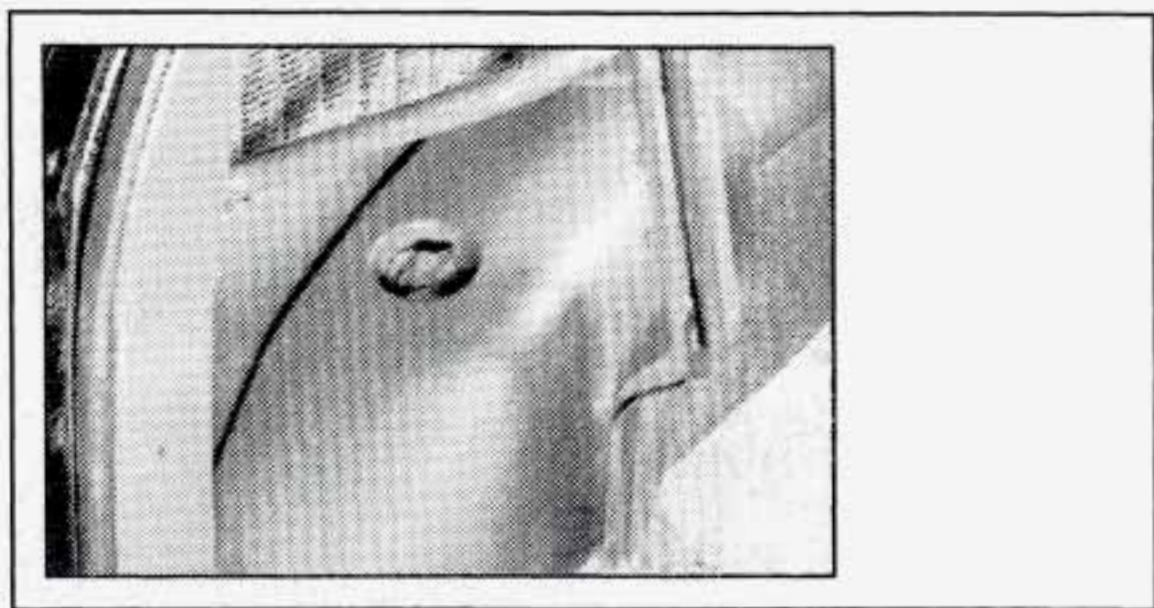

K2135

If your utility model has a jack cover, turn the wing nut counterclockwise to take it off, then take the cover off.

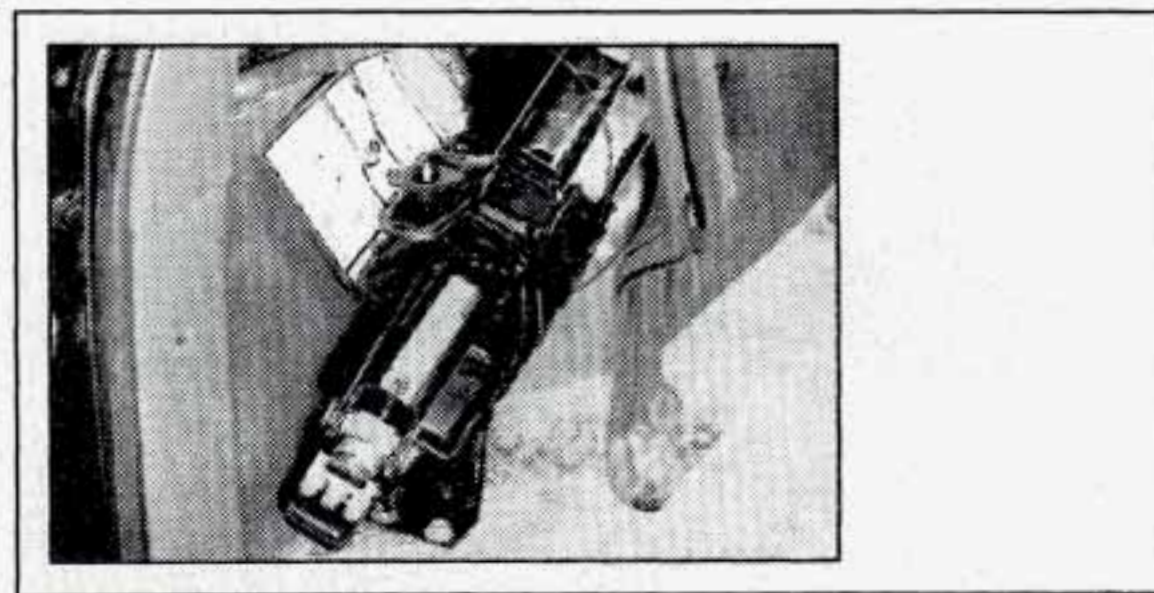

K2141

To take the jack out, turn the wing nut counterclockwise and take it and the retainer off. Take the jack and storage box out and take the tools out of the box.

Your vehicle may have a pair of emergency gloves secured to the jack. You can use them when changing the tire, or during other emergency situations. Remember to replace them with the jack, so you will have them handy if needed later.

## Problems on the Road

---

### Changing the Tire

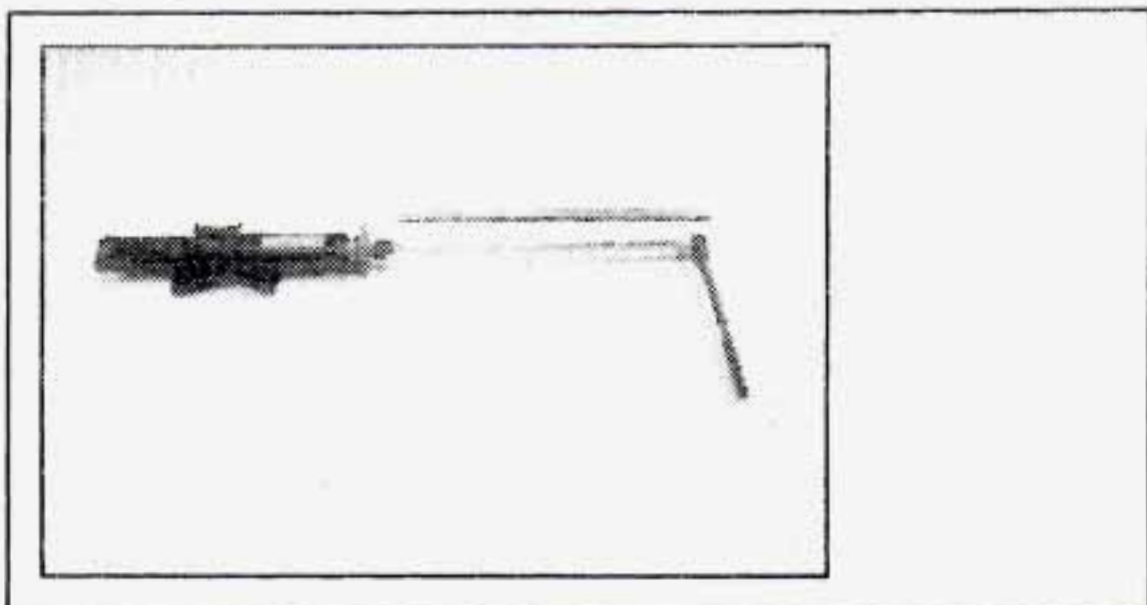

K2519

Start with the jack, the jack handle and the ratchet. If the flat tire is on the rear of the vehicle, you'll need the jack handle extensions also.

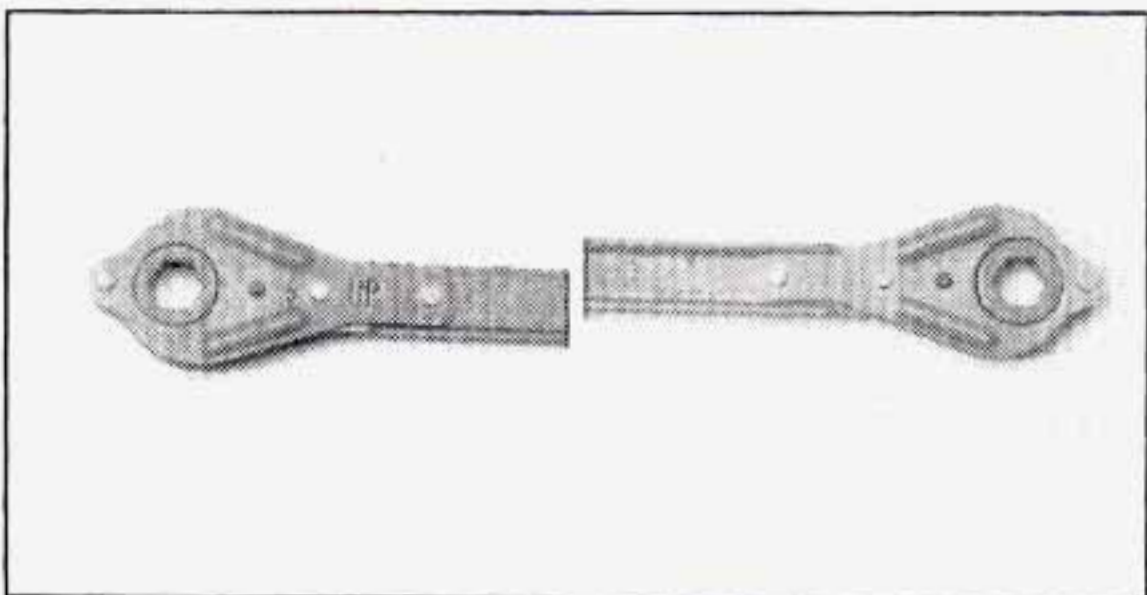

K2535

The ratchet has an **UP** and a **DOWN** marking.

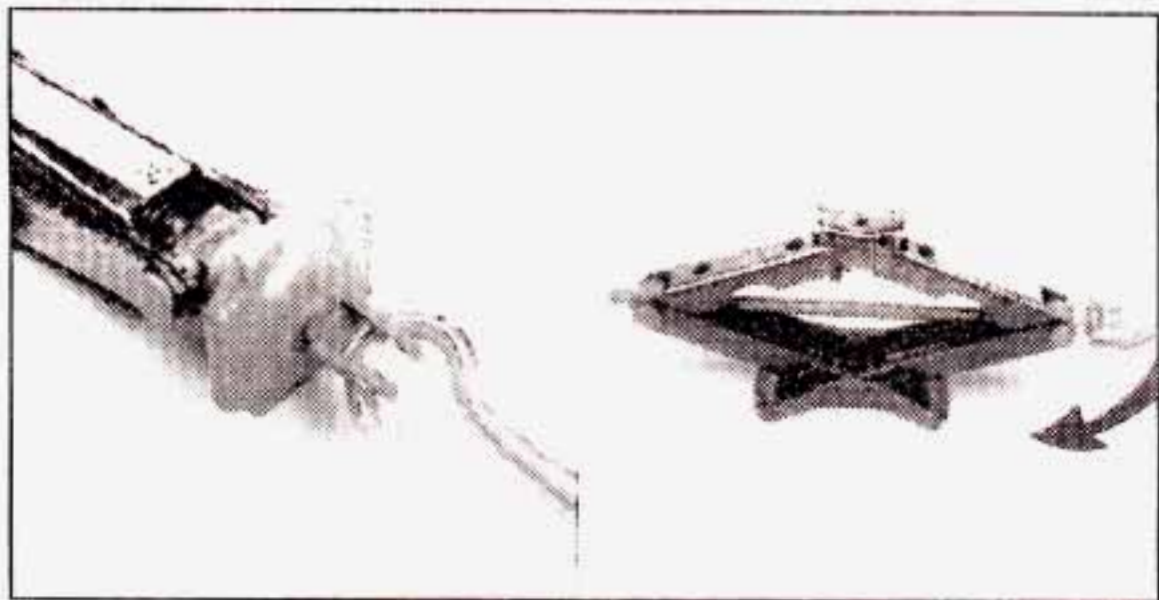

K2521

Attach the jack handle (and jack handle extensions, if needed) to the jack. With the **UP** marking on the ratchet facing you, rotate the ratchet clockwise. That will lift the jack head a little. Before raising the vehicle, do the following things.

Put your spare tire near the flat tire.

Remove the wheel trim.

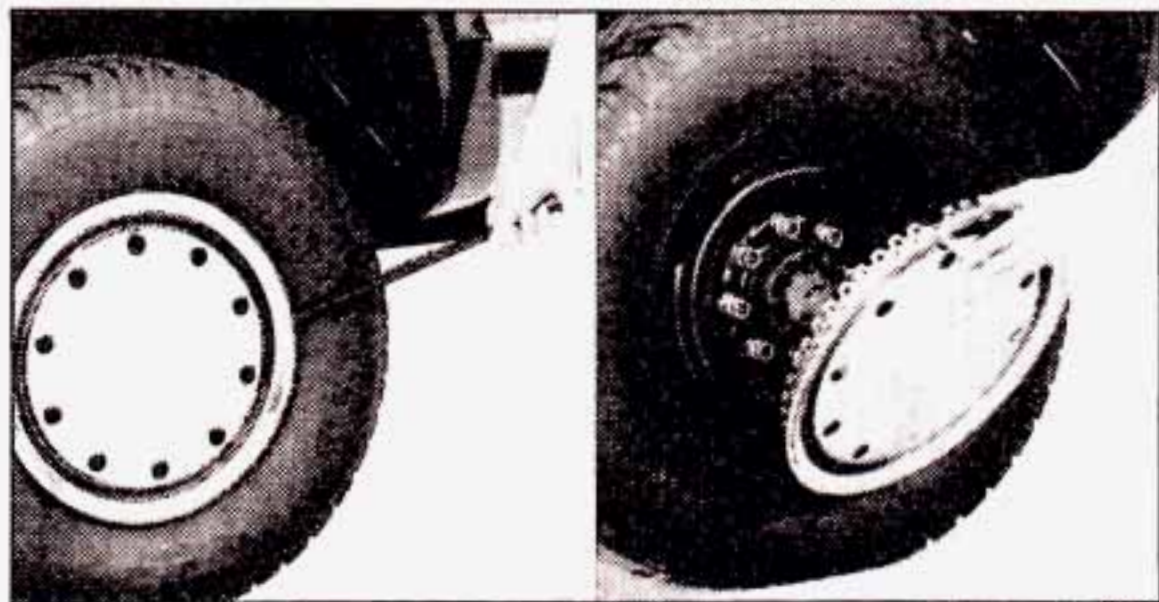

K2367

If there is a wheel cover, remove it by using the flat end of the socket. Pry along the edge of the wheel cover until it comes off. Be careful; the rim edges may be sharp. Don't try to remove it with your bare hands.

## Problems on the Road

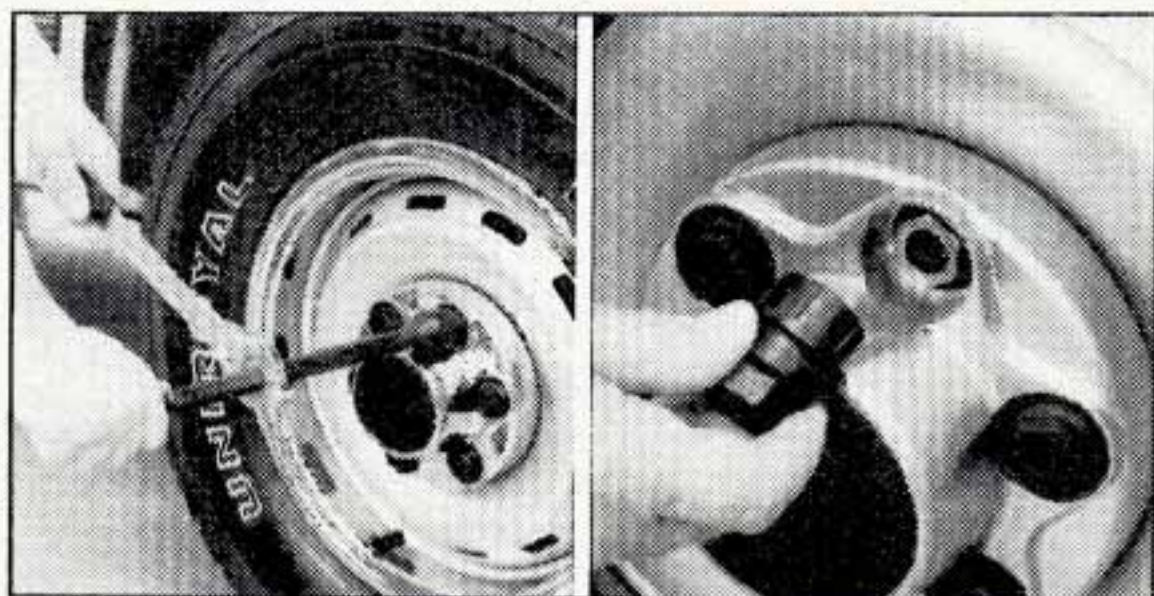

K2369

If your vehicle has wheel nut caps, remove them using the ratchet and socket. Use the ratchet with **DOWN** facing you to unscrew and take them off. Then take the hub cap off.

If the wheel has a trim ring, remove it by using the flat end of the socket.

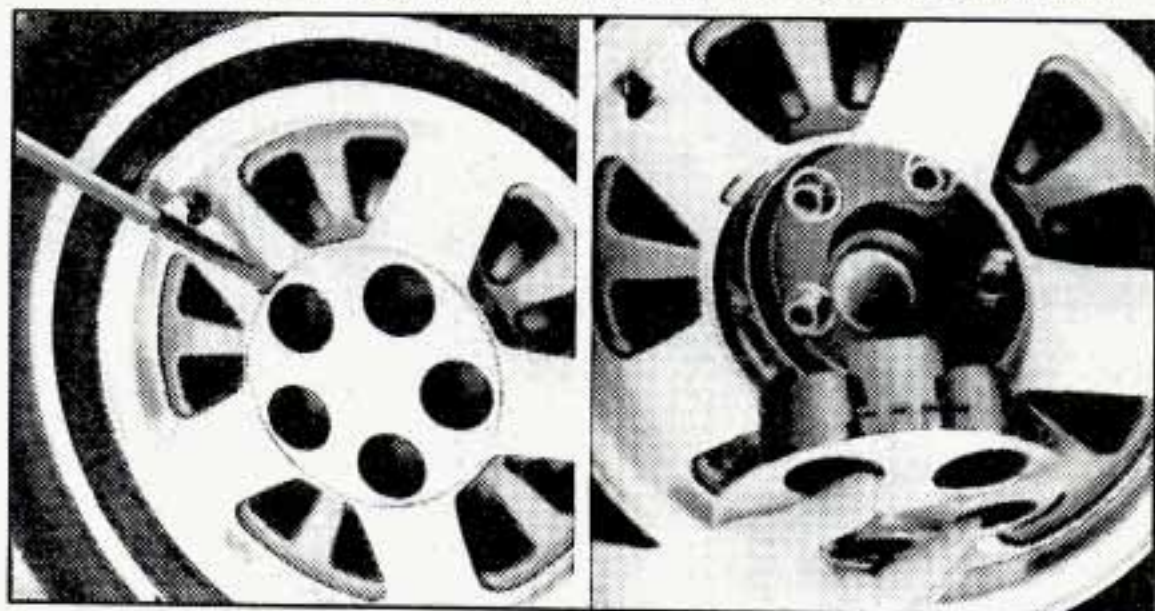

K2368

If the wheel has a smooth center piece or a center piece with recessed nuts, remove it using the flat end of the socket. Place the flat end of the socket in the slot on the wheel and pry out gently.

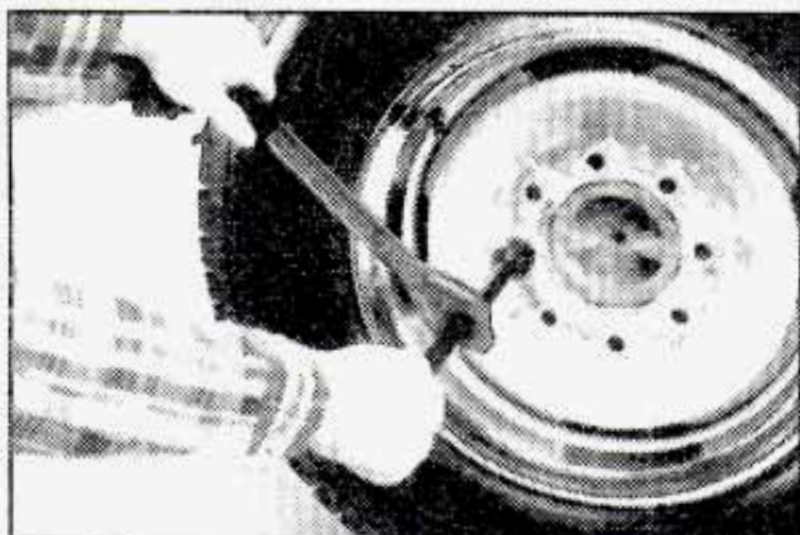

P0205

Using the socket and ratchet, with **DOWN** facing you, loosen all the wheel nuts. Don't remove them yet.

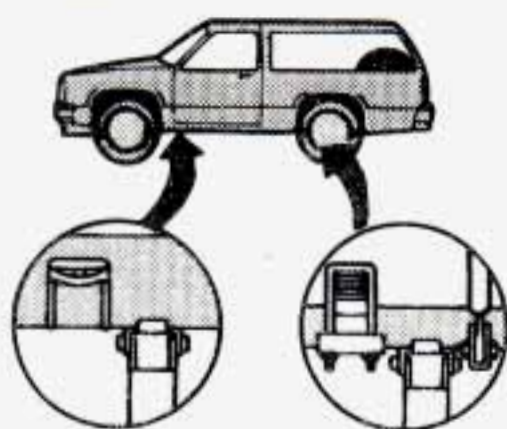

**JACK LOCATIONS/ALL MODELS**

K2120

Position the jack under the vehicle.

## CAUTION



Getting under a vehicle when it is jacked up is dangerous. If the vehicle slips off the jack, you could be badly injured or killed. Never get under a vehicle when it is supported only by a jack.

## Problems on the Road

### NOTICE

Raising your vehicle with the jack improperly positioned will damage the vehicle or may allow the vehicle to fall off the jack. Be sure to fit the jack lift head into the proper location before raising your vehicle.

*Front*

*Rear*

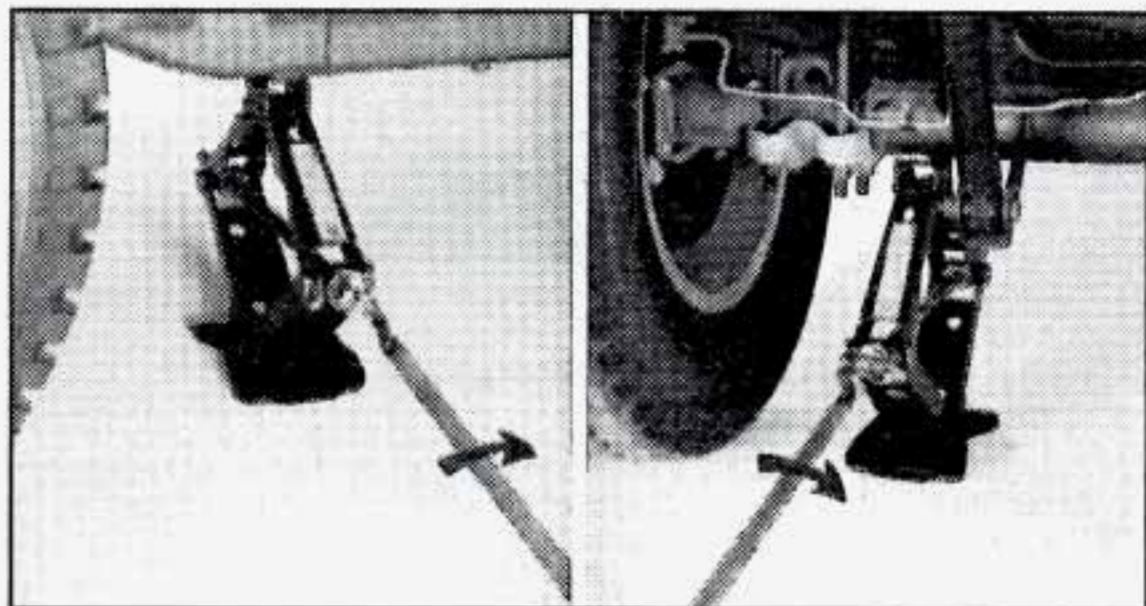

P0288

Raise the vehicle by rotating the ratchet clockwise. Make sure the **UP** marking faces you. Use the jack handle extensions if the flat tire is on the rear of the vehicle. Raise the vehicle far enough off the ground so there is enough room for the spare tire to fit.



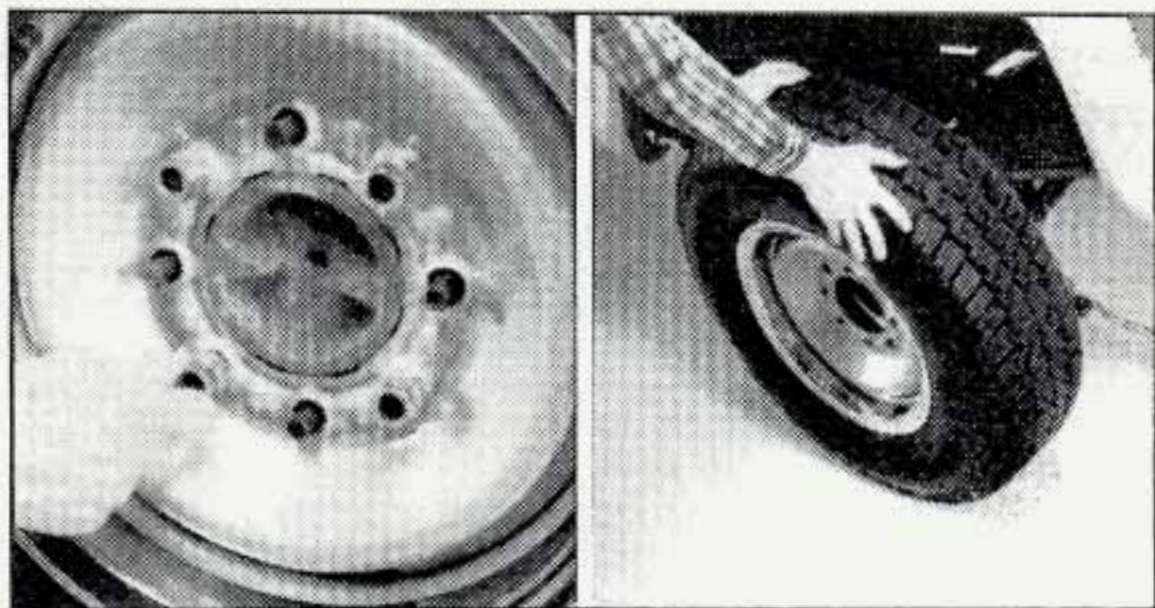

K2527

Remove all the wheel nuts and take off the flat tire.

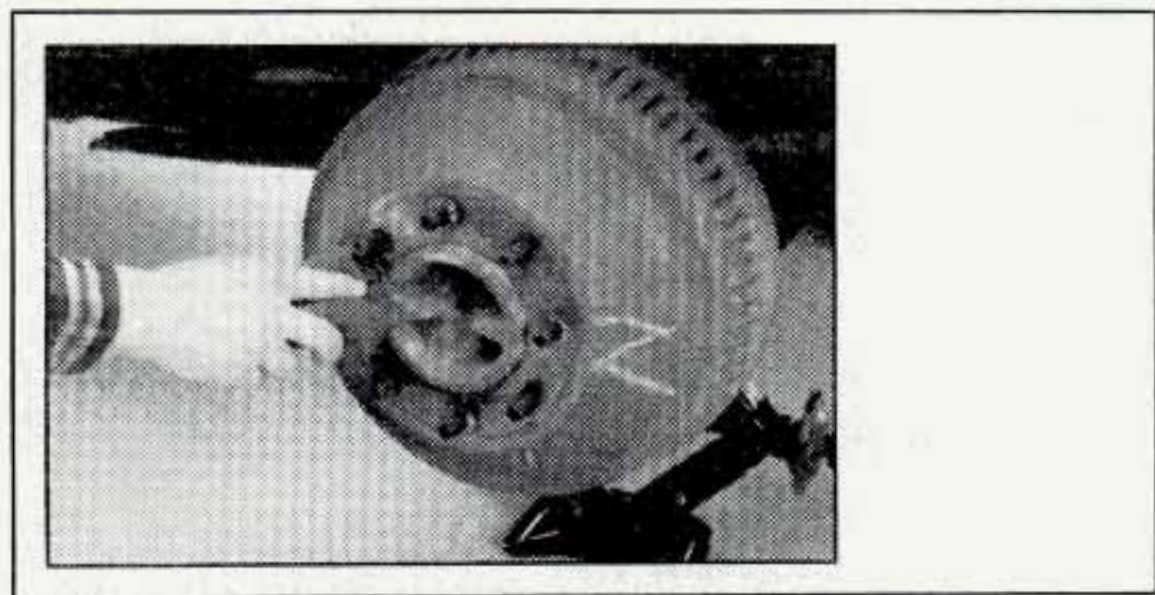

K2529

## Problems on the Road

### CAUTION



Rust or dirt on the wheel, or on the parts to which it is fastened, can make the wheel nuts become loose after a time. The wheel could come off and cause an accident. When you change a wheel, remove any rust or dirt from the places where the wheel attaches to the vehicle. In an emergency, you can use a cloth or a paper towel to do this; but be sure to use a scraper or wire brush later, if you need to, to get all the rust or dirt off.

Remove any rust or dirt from the wheel bolts, mounting surfaces or spare wheel. Place the spare on the wheel mounting surface.

### CAUTION



Never use oil or grease on studs or nuts. If you do, the nuts might come loose. Your wheel could fall off, causing a serious accident.

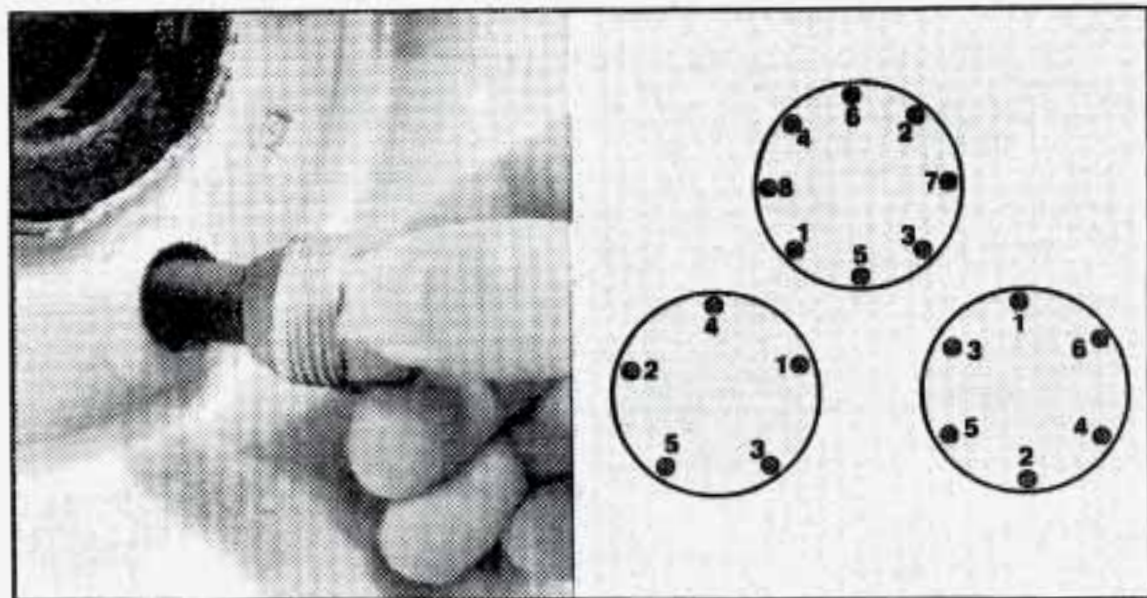

K2127

Replace the wheel nuts with the rounded end of the nuts toward the wheel. Tighten each wheel nut by hand until the wheel is held against the hub.

Front

Rear

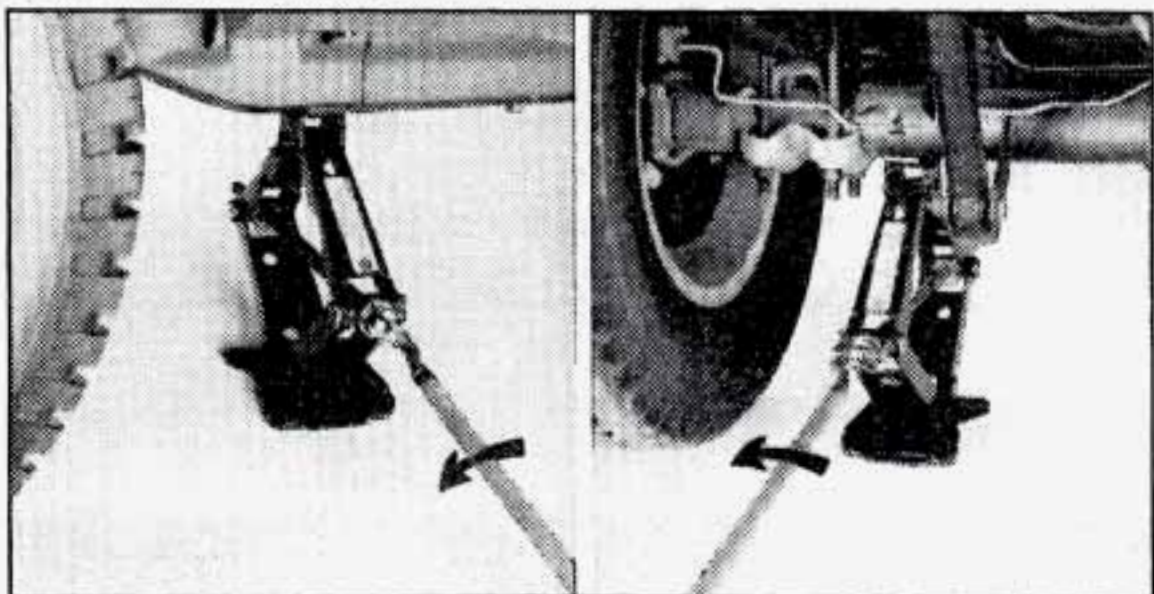

P0500

Lower the vehicle by rotating the ratchet counterclockwise. Lower the jack completely.

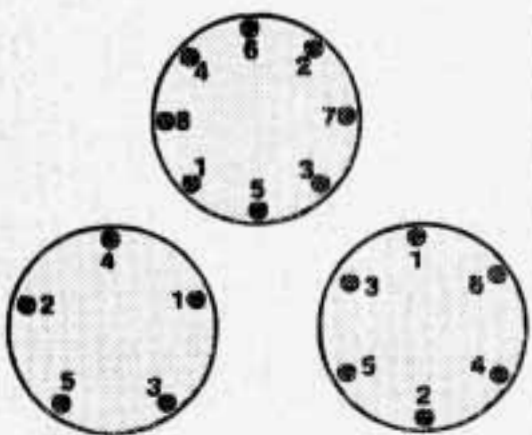
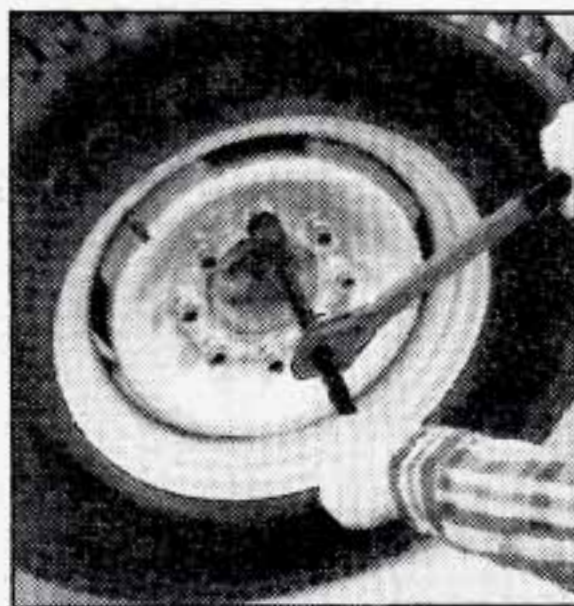

K2129

Tighten the nuts firmly in a criss-cross sequence as shown. Rotate the ratchet clockwise with the **UP** marking facing you.

## ***Problems on the Road***

---

### **CAUTION**



Incorrect wheel nuts or improperly tightened wheel nuts can cause the wheel to become loose and even come off. This could lead to an accident. Be sure to use the correct wheel nuts. If you have to replace them, be sure to get the right kind.

Stop somewhere as soon as you can and have the nuts tightened with a torque wrench to the proper torque.

For proper torque, see "Wheel Nut Torque" in the Index.

Put the wheel trim back on. For vehicles with plastic nut caps, tighten the caps until they are finger tight, then tighten them an additional one-half turn with the ratchet. Remove any wheel blocks.

### **CAUTION**



Storing a jack, a tire or other equipment in the passenger compartment of the vehicle could cause injury. In a sudden stop or collision, loose equipment could strike someone. Store all these in the proper place.

**JACKING TOOL STORAGE  
(ALL MODELS)**

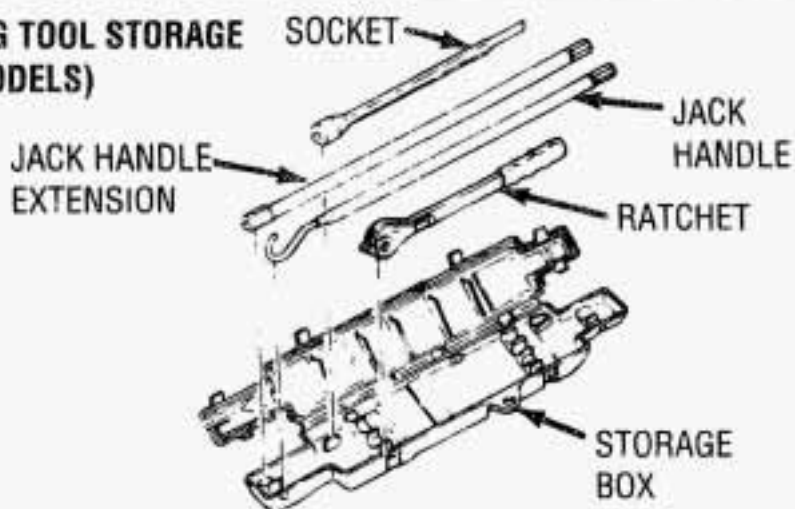

**JACK STORAGE  
(WAGON MODEL)**

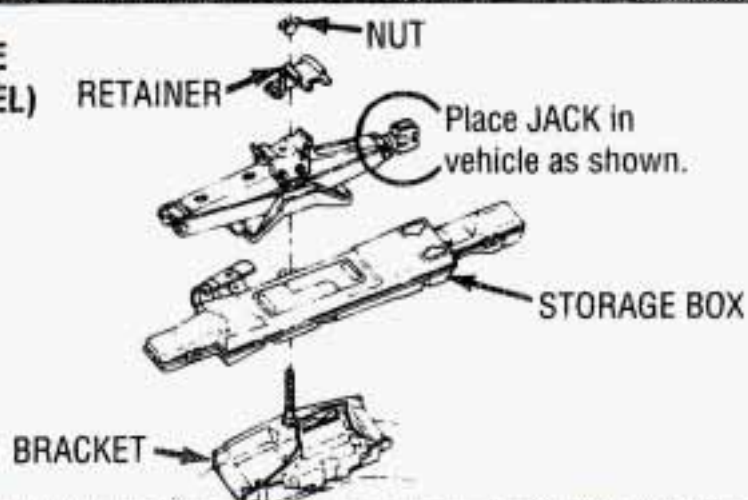

**JACK STORAGE  
(UTILITY MODEL)**

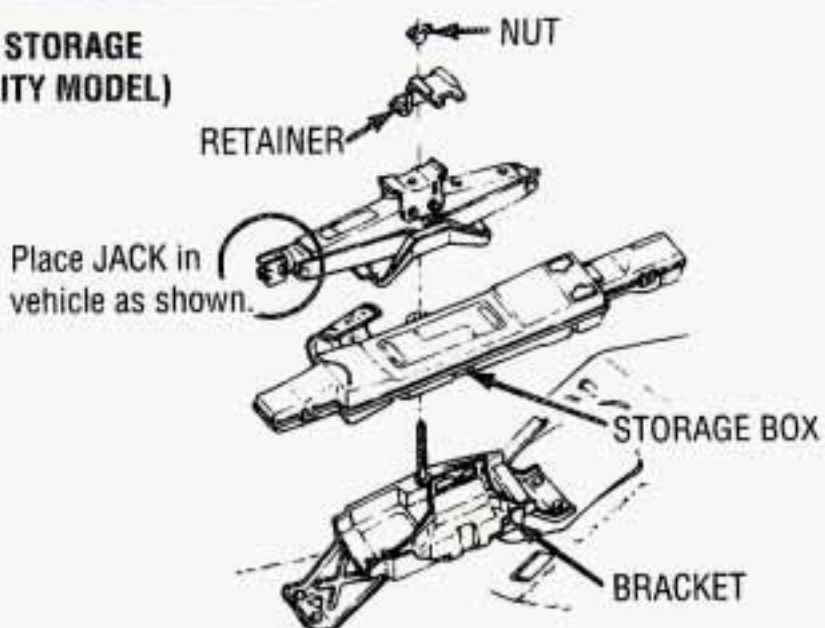

## ***Problems on the Road***

---

### ***Storing the Jack and Tire***

#### ***Storing the Jack***

Put the tools into the storage box and close it tightly. Fit the storage box into the bracket with the bolt through the box. Put the jack onto the box. Be sure the jack points in the right direction as shown for your model. Secure the emergency gloves, if your vehicle has them, to the jack using the provided strap.

Slide the retainer over the bolt onto the jack and put the wing nut on. Turn the nut clockwise until it is tight against the retainer.

Replace the jack storage cover, if your vehicle has one, by simply reversing the removal procedure described earlier.

#### ***Storing the Tire***

Be sure the J-bolt is hooked properly for your model or tire size as shown.

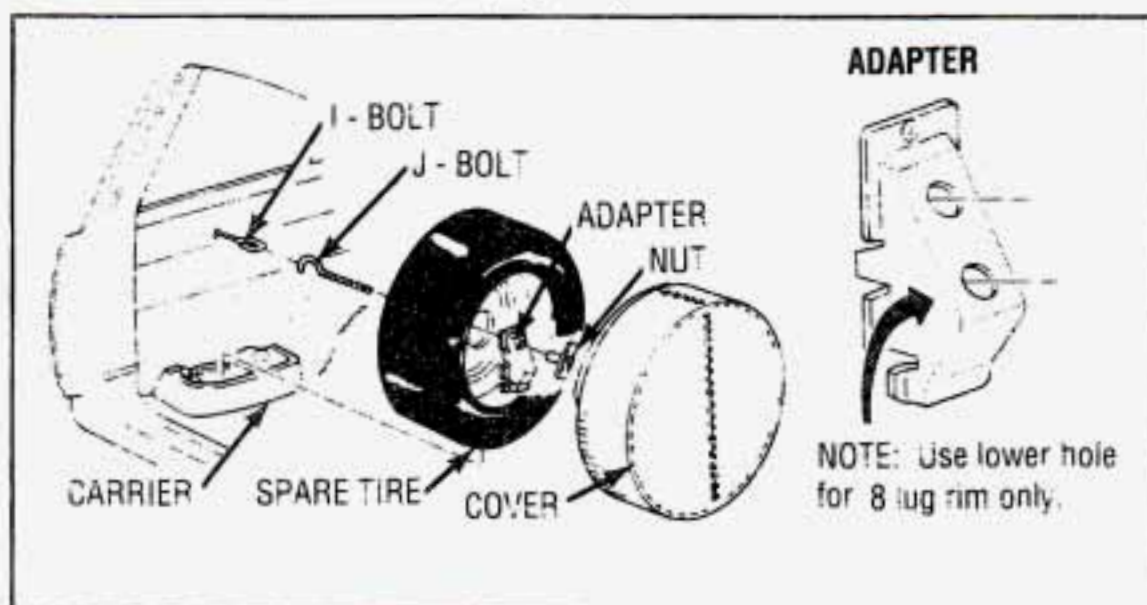

P0213

If you have a wagon model, use these locations.

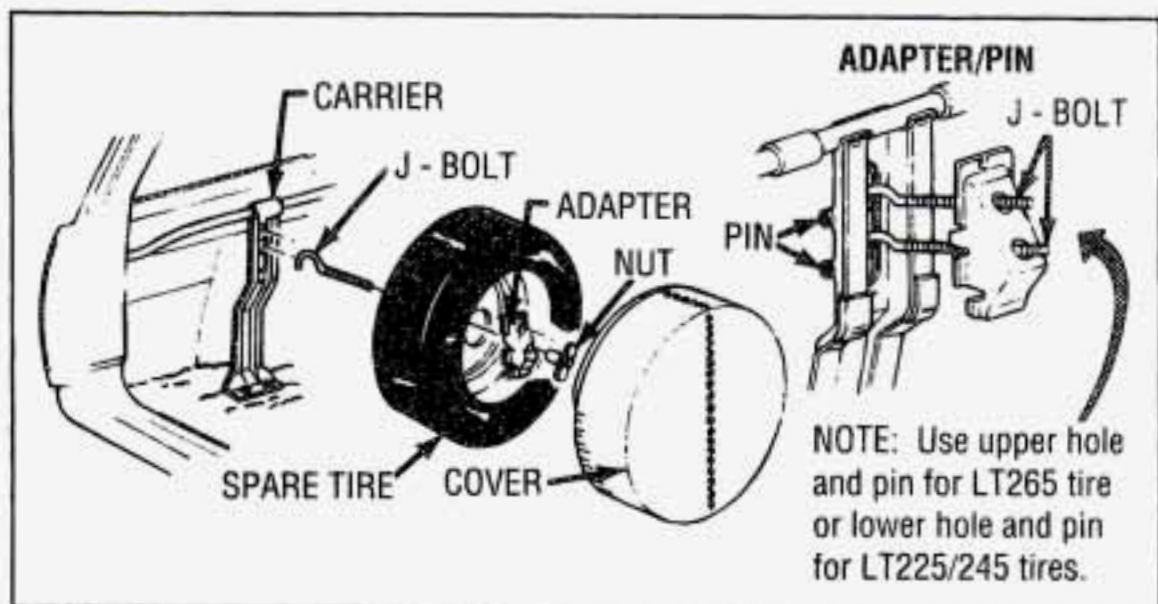

K2143

If you have a utility model, use these locations.

Put the cover back on the tire if your vehicle has one.

Put the tire into the vehicle, over the bolt. Slide the adapter onto the bolt in the proper location for your model, and put the wing nut on. Turn the wing nut clockwise until the adapter is tight against the wheel, then close the cover.

## ***If You're Stuck: In Sand, Mud, Ice or Snow***

What you **don't** want to do when your vehicle is stuck is to spin your wheels. The method known as "rocking" can help you get out when you're stuck, but you must use caution.

### **CAUTION**



If you let your tires spin at high speed, they can explode and you or others could be injured. And, the transmission or other parts of the vehicle can overheat. That could cause an engine compartment fire or other damage. When you're stuck, spin the wheels as little as possible. Don't spin the wheels above 35 mph (55 km/h) as shown on the speedometer.

## Problems on the Road

---

### NOTICE

Spinning your wheels can destroy parts of your vehicle as well as the tires. If you spin the wheels too fast while shifting your transmission back and forth, you can destroy your transmission.

#### ***Rocking your vehicle to get it out:***

First, turn your steering wheel left and right. That will clear the area around your front wheels. Then shift back and forth between **R** and a forward gear (or with a manual transmission, between First or Second gear and Reverse), spinning the wheels as little as possible. Release the accelerator pedal while you shift, and press lightly on the accelerator pedal when the transmission is in gear. If that doesn't get you out after a few tries, you may need to be towed out. Or, you can use your recovery hooks, if your vehicle has them. If you do need to be towed out, see "Towing Your Vehicle" in the Index.

#### ***Using the Recovery Hooks***

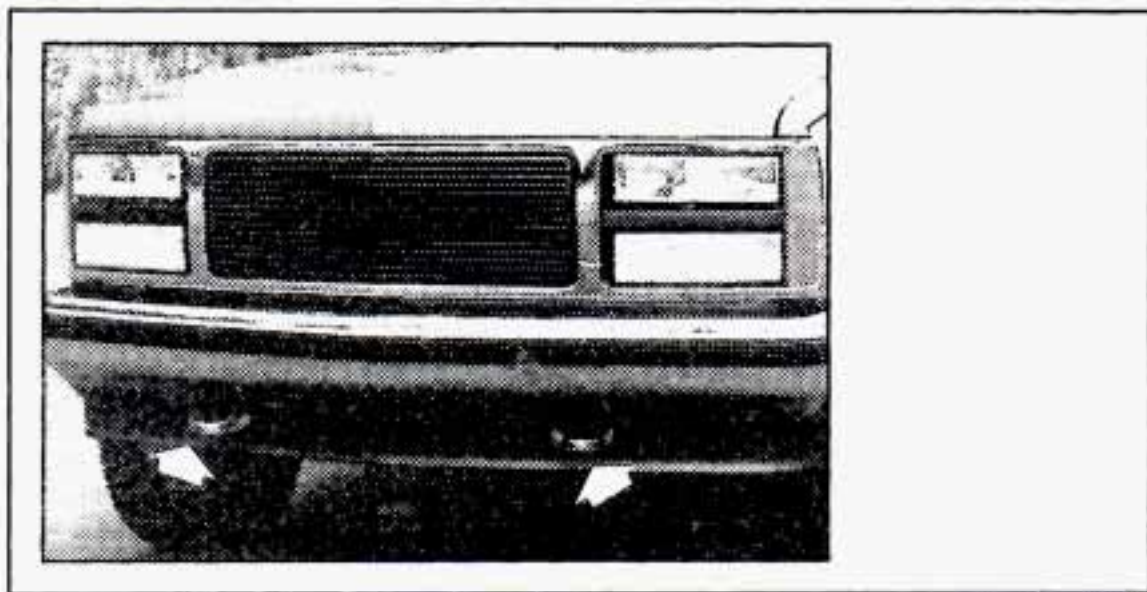

K2456

If you ever get stuck in sand, mud, ice or snow, your vehicle may be equipped with recovery hooks. The recovery hooks are provided at the front of your vehicle. You may need to use them if you're stuck off-road and need to be pulled to some place where you can continue driving.



## CAUTION



The recovery hooks, when used, are under a lot of force. Always pull the vehicle straight out. Never pull on the hooks at a sideways angle. The hooks could break off and you or others could be injured from the chain or cable snapping back.

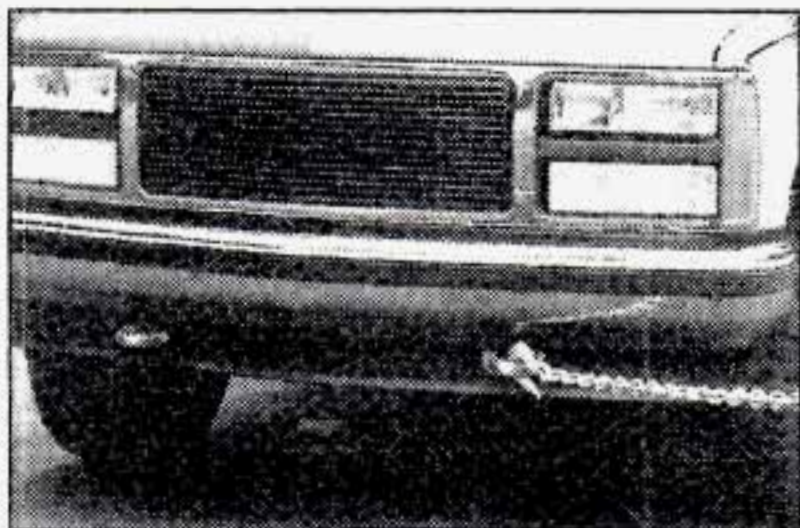

K2457

## NOTICE

Never use the recovery hooks to tow the vehicle. Your vehicle could be damaged and it would not be covered by warranty.



# **Service & Appearance Care**

---



## **Section**

Here you will find information about the care of your vehicle. This section begins with service and fuel information, and then it shows how to check important fluid and lubricant levels. There is also technical information about your vehicle, and a section devoted to its appearance care.

Service .....	6-3
Fuel .....	6-4
Checking Things Under the Hood .....	6-8
Hood Release .....	6-8
Engine Oil .....	6-9
Air Cleaner .....	6-16
Automatic Transmission Fluid .....	6-17
Manual Transmission Fluid .....	6-20
Hydraulic Clutch .....	6-21
Transfer Case .....	6-23
Front Axle .....	6-24
Rear Axle .....	6-24
Engine Coolant .....	6-25
Power Steering Fluid .....	6-29
Windshield Washer Fluid .....	6-31
Brake Master Cylinder .....	6-32

## ***Service & Appearance Care***

---

Replacing Brake System Parts .....	6-33
Other Maintenance Items .....	6-34
Lubrication.....	6-35
Electrical System .....	6-37
Battery .....	6-37
Bulb Replacement.....	6-37
Fuses and Circuit Breakers.....	6-43
Exhaust System.....	6-45
Loading Your Vehicle .....	6-46
Tires.....	6-48
Inflation—Tire Pressure .....	6-49
Tire Inspection and Rotation .....	6-52
When It's Time for New Tires.....	6-53
Buying New Tires .....	6-53
Uniform Tire Quality Grading.....	6-54
Wheel Alignment and Tire Balance .....	6-55
Wheel Replacement.....	6-55
Tire Chains.....	6-56
Appearance Care .....	6-57
Cleaning the Inside Of Your Vehicle .....	6-58
Cleaning the Outside Of Your Vehicle .....	6-61
Appearance Care Materials.....	6-64
Vehicle Identification Number .....	6-65
Service Parts Identification Label .....	6-67
Specification Charts.....	6-68

---

---

## Service

Your General Motors dealer knows your vehicle best and wants you to be happy with it. We hope you'll go to your dealer for all your service needs. You'll get genuine GM parts and GM-trained and supported service people.

We hope you'll want to keep your GM vehicle all GM. Genuine GM parts have one of these marks:



K1604

### ***Doing Your Own Service Work***

If you want to do some of your own service work, you'll want to get the proper General Motors Service Manual. It tells you much more about how to service your vehicle than this manual can. To order the proper service manual, see "Service Publications" in the Index.

You should keep a record with all parts receipts and list the mileage and the date of any service work you perform. See "Maintenance Record" in the Index.

## **CAUTION**



You can be injured if you try to do service work on a vehicle without knowing enough about it.

- Be sure you have sufficient knowledge, experience, and the proper replacement parts and tools before you attempt any vehicle maintenance task.
- Be sure to use the proper nuts, bolts and other fasteners. "English" and "metric" fasteners can be easily confused. If you use the wrong fasteners, parts can later break or fall off. You could be hurt.

## Service & Appearance Care

### NOTICE

If you try to do your own service work without knowing enough about it, your vehicle could be damaged.

### Maintenance Schedule

Section 7 of this manual, "Scheduled Maintenance Services", explains the maintenance your new vehicle needs, and when it should be done. It also has a form that you can use to record the maintenance work done on your vehicle. Be sure to read this information.

### Fuel

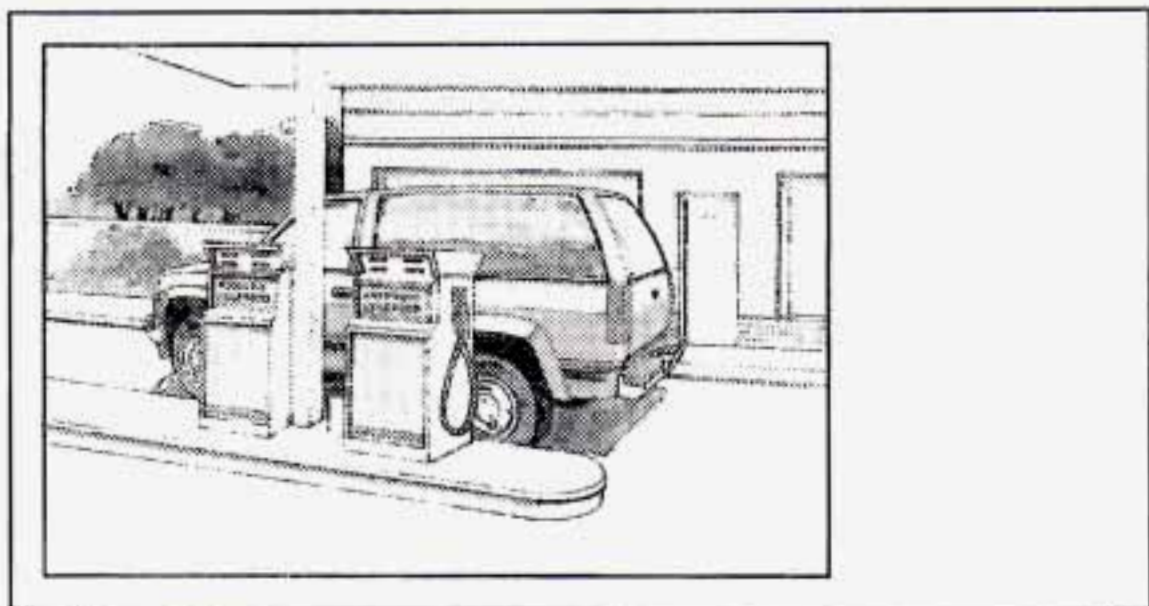

K2281

Use regular unleaded gasoline rated at 87 octane or higher. It should meet specifications ASTM D4814 in the U.S. and CGSB 3.5-92 in Canada. These fuels should have the proper additives, so you should not have to add anything to the fuel.

In the U.S. and Canada, it's easy to be sure you get the right kind of gasoline (unleaded). You'll see **UNLEADED** right on the pump. And only unleaded nozzles will fit into your vehicle's filler neck.

Be sure the posted octane is at least 87. If the octane is less than 87, you may get a heavy knocking noise when you drive. If it's bad enough, it can damage your engine.

---

If you're using fuel rated at 87 octane or higher and you still hear heavy knocking, your engine needs service. But don't worry if you hear a little pinging noise when you're accelerating or driving up a hill. That's normal and you don't have to buy a higher octane fuel to get rid of pinging. It's the heavy, constant knock that means you have a problem.

What about gasoline with blending materials that contain oxygen, such as MTBE or alcohol?

**MTBE** is "methyl tertiary-butyl ether." Fuel that is no more than 15% MTBE is fine for your vehicle.

**Ethanol** is ethyl or grain alcohol. Properly-blended fuel that is no more than 10% **ethanol** is fine for your vehicle.

**Methanol** is methyl or wood alcohol.

## NOTICE

Fuel that is more than 5% **methanol** is bad for your vehicle. Don't use it. It can corrode metal parts in your fuel system and also damage plastic and rubber parts. That damage wouldn't be covered under your warranty. And even at 5% or less, there must be "cosolvents" and corrosion preventers in this fuel to help avoid these problems.

### ***Gasolines for Cleaner Air***

Your use of gasoline with detergent additives will help prevent deposits from forming in your engine and fuel system. That helps keep your engine in tune and your emission control system working properly. It's good for your vehicle, and you'll be doing your part for cleaner air.

Many gasolines are now blended with materials that called oxygenates. General Motors recommends that you use gasolines with these blending materials, such as MTBE and ethanol. By doing so, you can help clean the air, especially in those parts of the country that have higher carbon monoxide levels.

In addition, some gasoline suppliers are now producing reformulated gasolines. These gasolines are specially designed to reduce vehicle emissions. General Motors recommends that you use reformulated gasoline. By doing so, you can help clean the air, especially in those parts of the country that have high ozone levels.

You should ask your service station operators if their gasolines contain detergents and oxygenates, and if they have been reformulated to reduce vehicle emissions.

## ***Service & Appearance Care***

---

### ***Fuels in Foreign Countries***

If you plan on driving in another country outside the U.S. or Canada, unleaded fuel may be hard to find. Do not use leaded gasoline. If you use even one tank full, your emission controls won't work well or at all. With continuous use, spark plugs can get fouled, the exhaust system can corrode, and your engine oil can deteriorate quickly. Your vehicle's three-way catalytic converter and oxygen sensor will be damaged. All of that means costly repairs that wouldn't be covered by your warranty.

To check on fuel availability, ask an auto club, or contact a major oil company that does business in the country where you'll be driving.

You can also write us at the following address for advice. Just tell us where you're going and give your Vehicle Identification Number (VIN).

General Motors of Canada Ltd.  
International Export Sales  
Post Office Box 828  
Oshawa, Ontario L1H 7N1, Canada

### ***Filling Your Tank***

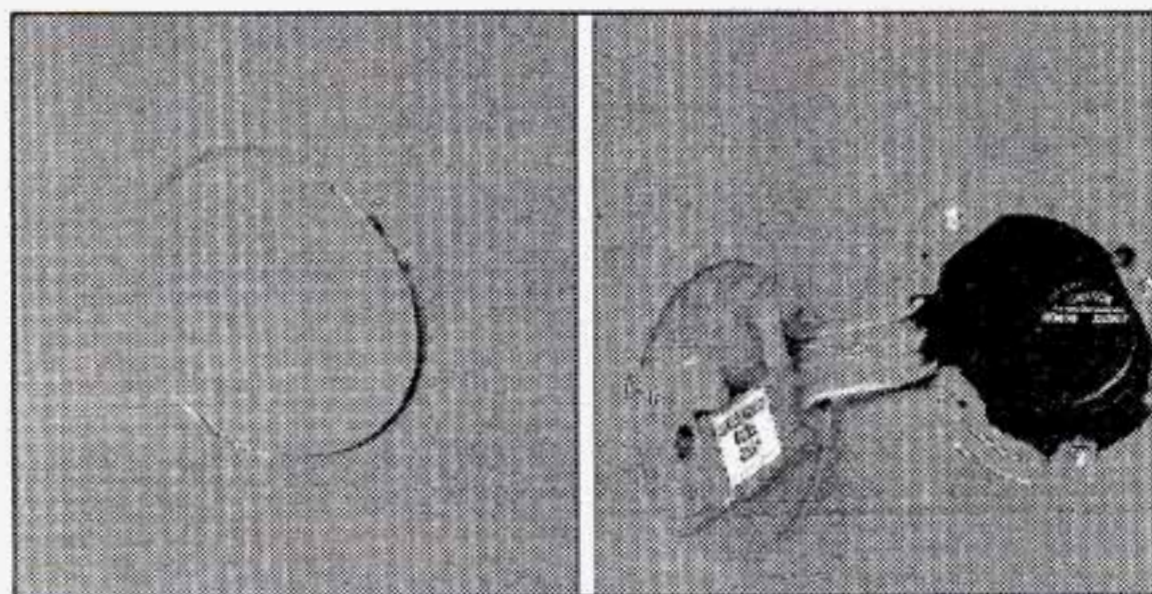

P0494

The fuel cap is behind a hinged door on the left side of your vehicle. To take off the cap, turn it slowly to the left (counterclockwise).



## CAUTION



Gasoline vapor is highly flammable. It burns violently, and that can cause very bad injuries. Don't smoke if you're near gasoline or refueling your vehicle. Keep sparks, flames, and smoking materials away from gasoline.

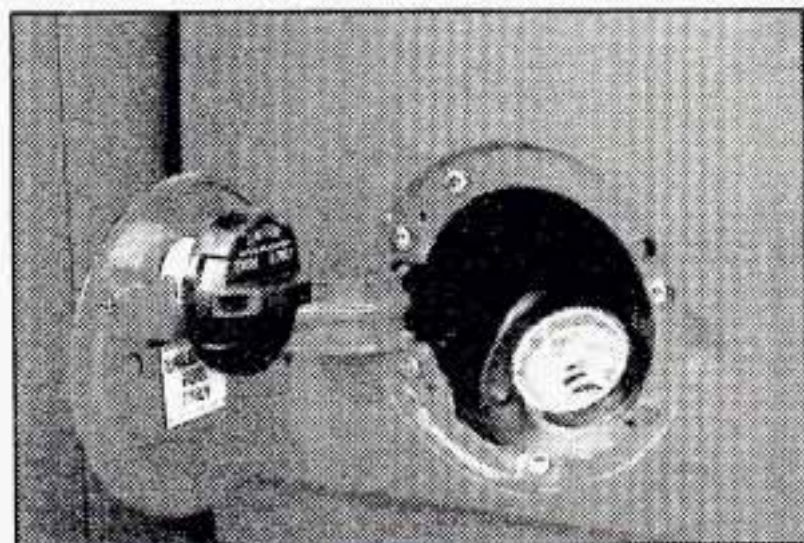

P0485

While refueling, hang the cap inside the fuel door.

## CAUTION



If you get gasoline on you and then something ignites it, you could be badly burned. Gasoline can spray out on you if you open the fuel filler cap too quickly. This spray can happen if your tank is nearly full, and is more likely in hot weather. Open the fuel filler cap slowly and wait for any "hiss" noise to stop.

Then unscrew the cap all the way.

When you put the cap back on, turn it to the right (clockwise) until you hear a clicking noise.

## NOTICE

If you need a new cap, be sure to get the right type. Your dealer can get one for you. If you get the wrong type, it may not fit or have proper venting, and your fuel tank and emissions system might be damaged.

## ***Service & Appearance Care***

---

### ***Checking Things Under the Hood***

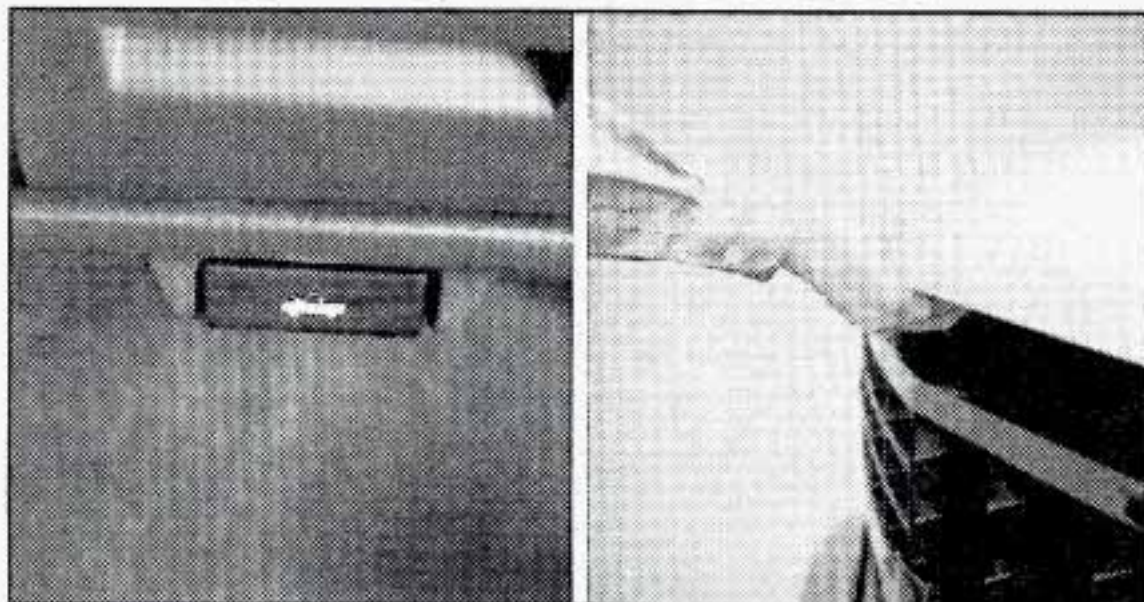

K2609

#### ***Hood Release***

To open the hood, first pull the handle inside the vehicle. Then go to the front of the vehicle and pull up on the secondary hood release. Lift the hood.

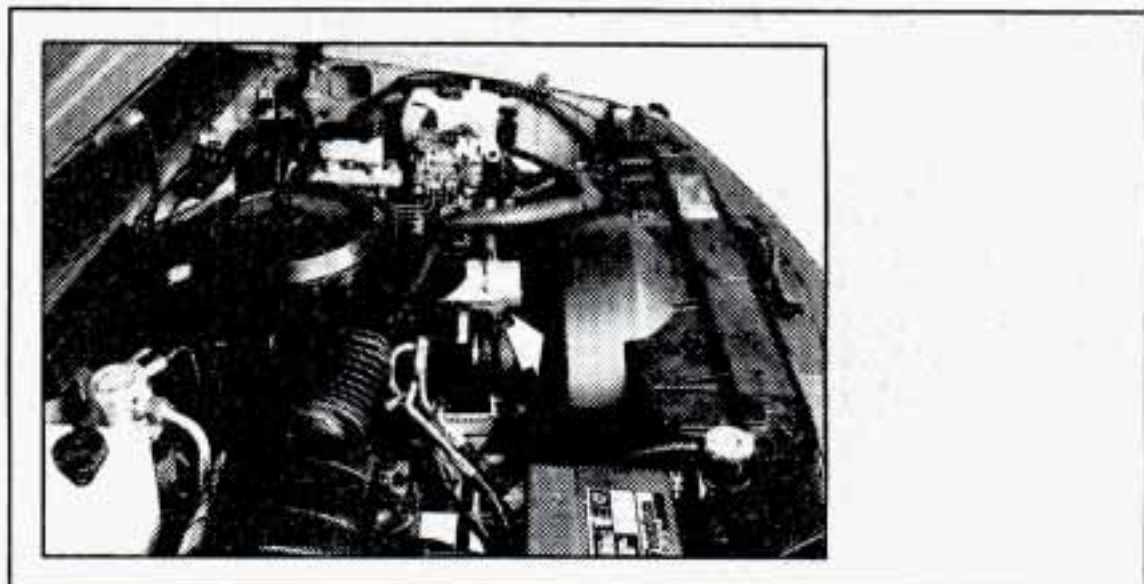

P0217

### **CAUTION**



If your vehicle has air conditioning, the auxiliary fan under the hood can start up and injure you even when the engine is not running. Keep your hands, clothing and tools away from any underhood electric fan, if you have one.

## CAUTION



Things that burn can get on hot engine parts and start a fire. These include liquids like gasoline, oil, coolant, brake fluid, windshield washer and other fluids, and plastic or rubber. You or others could be burned. Be careful not to drop or spill things that will burn onto a hot engine.

Before closing the hood, be sure all the filler caps are on properly. Then just pull the hood down and close it firmly.

### ***Engine Oil***

It's a good idea to check your engine oil every time you get fuel. In order to get an accurate reading, the oil must be warm and the vehicle must be on level ground.



K2389

Turn off the engine and give the oil a few minutes to get back down into the oil pan. If you don't, the oil dipstick might not show the actual level.

## Service & Appearance Care

---

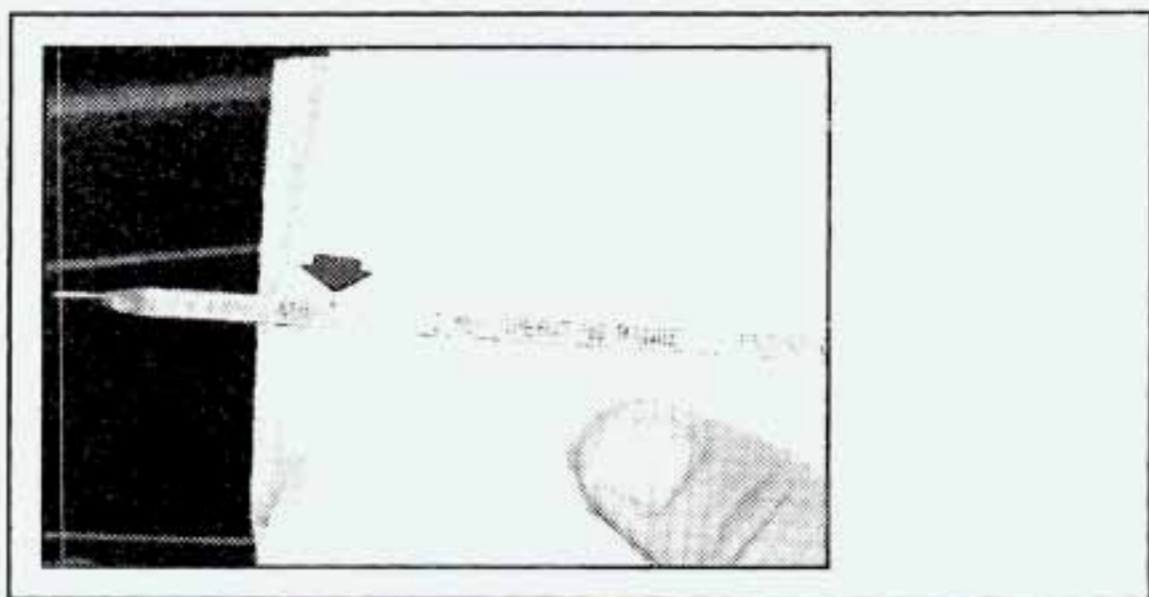

K2613

**To Check Engine Oil:** Pull out the dipstick and clean it with a paper towel or cloth, then push it back in all the way. Remove it again, keeping the tip lower.

**When to Add Oil:** If the oil is at or below the **ADD** mark, then you'll need to add some oil. But you must use the right kind. This part explains what kind of oil to use. For crankcase capacity, see "Capacities and Specifications" in the Index.

### NOTICE

Don't add too much oil. If your engine has so much oil that the oil level gets above the upper mark that shows the proper operating range, your engine could be damaged.

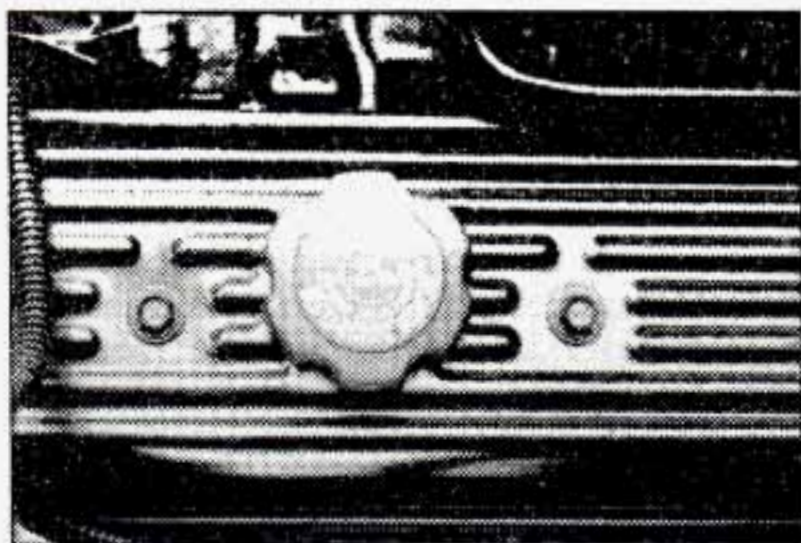

K2390

Just fill it enough to put the level somewhere in the proper operating range. Push the dipstick all the way back in when you're through.

## Service & Appearance Care

---

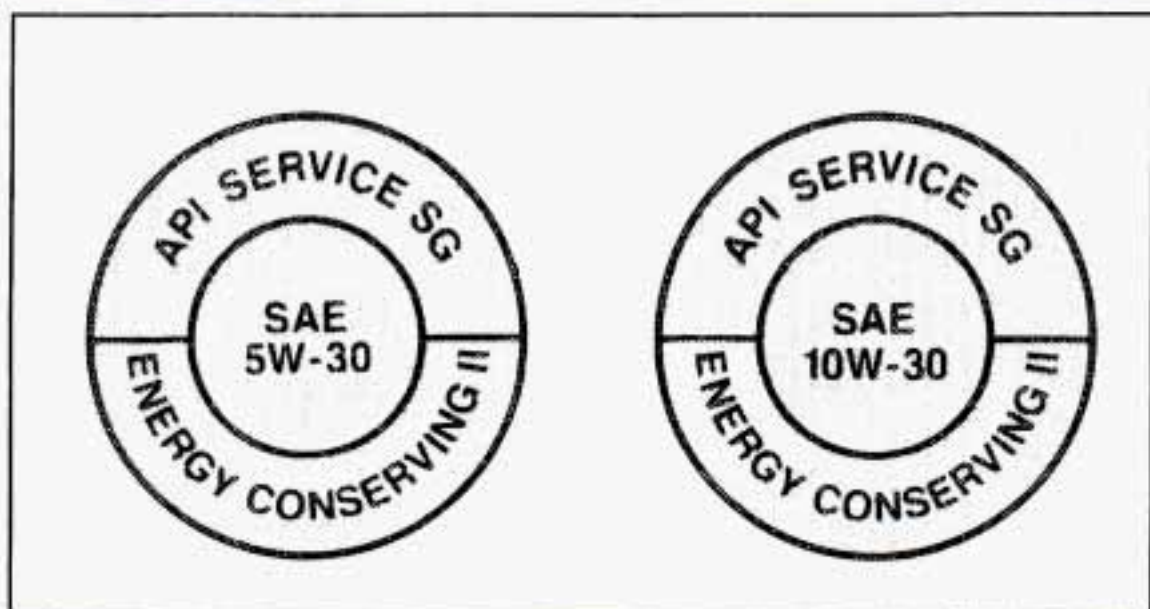

K2543

### **What Kind of Oil to Use:**

Look for three things:

- **SG**

**SG** must be on the oil container, either by itself or combined with other quality designations, such as **SG/CC**, **SG/CD**, **SF**, **SG**, **CC**, etc. These letters show American Petroleum Institute (API) levels of quality.

### **NOTICE**

If you use oils that don't have the "SG" designation, you can cause engine damage not covered by your warranty.

**LIGHT DUTY EMISSIONS GAS ENGINES  
RECOMMENDED SAE VISCOSITY GRADE ENGINE OILS**

**FOR BEST FUEL ECONOMY AND COLD STARTING, SELECT THE LOWEST  
SAE VISCOSITY GRADE OIL FOR THE EXPECTED TEMPERATURE RANGE.**

**HOT  
WEATHER**



**COLD  
WEATHER**

**LOOK  
FOR THIS  
LABEL**



**IF NEITHER SAE 5W-30 NOR SAE 10W-30  
GRADE OILS ARE AVAILABLE, SAE 30  
GRADE MAY BE USED AT TEMPERATURES  
ABOVE 40 DEGREES F (4 DEGREES C).**

**DO NOT USE SAE 10W-40, SAE 20W-50 OR  
ANY OTHER GRADE OIL NOT RECOMMENDED**

P0344

• **SAE 5W-30**

**Vehicles with Light Duty Emissions (8500 GVWR or less).**

As shown in this chart, SAE 5W-30 is best for your vehicle. However, you can use SAE 10W-30 if it's going to be 0°F (-18°C) or above.

# Service & Appearance Care

## HEAVY DUTY EMISSIONS — GASOLINE ENGINES RECOMMENDED SAE VISCOSITY GRADE ENGINE OILS

FOR BEST FUEL ECONOMY AND COLD STARTING, SELECT THE LOWEST SAE VISCOSITY GRADE OIL FOR THE EXPECTED TEMPERATURE RANGE

**HOT  
WEATHER**

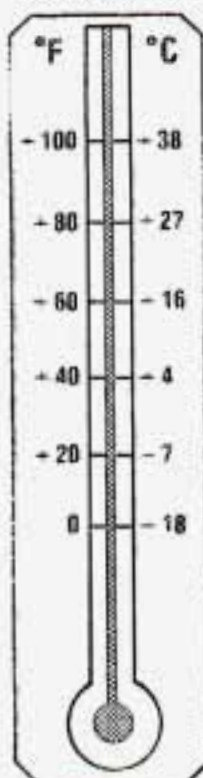

**COLD  
WEATHER**

**LOOK  
FOR THIS  
LABEL**



**SAE 5W-30**

**SAE 10W-30  
PREFERRED**  
above 0°F  
(-18°C)

IF NEITHER SAE 5W-30 NOR SAE 10W-30 GRADE OILS ARE AVAILABLE, SAE 30 GRADE MAY BE USED AT TEMPERATURES ABOVE 40 DEGREES F (4 DEGREES C).

DO NOT USE SAE 10W-40, SAE 20W-50 OR ANY OTHER GRADE OIL NOT RECOMMENDED

P0347

- **SAE 10W-30**

**Vehicles with Heavy Duty Emissions (8501 GVWR or more).**

As shown in this chart, SAE 10W-30 is best for your vehicle. However, you can use SAE 5W-30 if it's going to be colder than 60°F (16°C) before your next oil change. When it's very cold, below 0°F (-18°C), you should use SAE 5W-30.



---

These numbers on an oil container show its viscosity, or thickness.

Do not use other viscosity oils such as SAE 10W-40 or SAE 20W-50.

- **Energy Conserving II**

Oils with these words on the container will help you save fuel.

This doughnut-shaped logo (symbol) is used on most oil containers to help you select the correct oil.

You should look for this on the oil container, and use **only** those oils that display the logo.

GM Goodwrench<sup>®</sup> oil (in Canada, GM Engine Oil) meets all the requirements for your vehicle.

***Engine Oil Additives:***

Don't add anything to your oil. Your GM dealer is ready to advise if you think something should be added.

***When to Change Engine Oil:***

See if any one of these is true for you:

- Most trips are less than 4 miles (6 km).
- It's below freezing outside and most trips are less than 10 miles (16 km).
- The engine is at low speed most of the time (as in door to door delivery, or in stop-and-go traffic).
- You tow a trailer often.
- Most trips are through dusty places.
- The vehicle is frequently operated off-road.

If any one of these is true for your vehicle, then you need to change your **oil and filter** every 3,000 miles (5000 km) or 3 months—whichever comes first.

**Vehicles with Light Duty Emissions (8500 GVWR or less).**

If none of them is true, change the oil every 7,500 miles (12 500 km) or 12 months—whichever comes first. Change the filter at the first oil change and at every other oil change after that.

**Vehicles with Heavy Duty Emissions (8501 GVWR or more).**

If none of them is true, change the oil every 6,000 miles (10 000 km) or 12 months—whichever comes first. Change the filter at the first oil change and at every other oil change after that if mileage determines when you change your

## ***Service & Appearance Care***

---

oil. If time determines when you change your oil, change the filter each time you change your oil.

### ***Engine Block Heater:***

An engine block heater can be a big help if you have to park outside in very cold weather, 0°F (-18°C) or colder. If your vehicle has this option, see "Engine Block Heater" in the Index.

### ***What to Do with Used Oil:***

#### **CAUTION**



Used engine oil contains things that have caused skin cancer in laboratory animals. Don't let used oil stay on your skin for very long. Clean your skin and nails with soap and water, or a good hand cleaner. Wash or properly throw away clothing or rags containing used engine oil.

Used oil can be a real threat to the environment. If you change your own oil, be sure to drain all free-flowing oil from the filter before disposal. Don't ever dispose of oil by putting it in the trash, pouring it on the ground, into sewers, or into streams or bodies of water. Instead, recycle it by taking it to a place that collects used oil. If you have a problem properly disposing of your used oil, ask your dealer, a service station or a local recycling center for help.

### ***Air Cleaner***



P0216

Refer to the Maintenance Schedule to determine when to replace the air cleaner filter and crankcase ventilation filter. See "Scheduled Maintenance Services" in the Index.

## CAUTION



Operating the engine with the air cleaner off can cause you or others to be burned. The air cleaner not only cleans the air, it stops flame if the engine backfires. If it isn't there, and the engine backfires, you could be burned. Don't drive with it off, and be careful working on the engine with the air cleaner off.

## NOTICE

If the air cleaner is off, a backfire can cause a damaging engine fire. And, dirt can easily get into your engine, which will damage it. Always have the air cleaner in place when you're driving.

To remove the air cleaner filter on a gas engine, turn the wing nuts counterclockwise. Remove the cover and change the filter.

### ***Automatic Transmission Fluid***

#### ***When to Check and Change:***

A good time to check your automatic transmission fluid level is when the engine oil is changed. Refer to the Maintenance Schedule to determine when to change your fluid. See "Scheduled Maintenance Services" in the Index.

#### ***How to Check:***

Because this operation can be a little difficult, you may choose to have this done at a General Motors dealership Service Department.

If you do it yourself, be sure to follow all the instructions here, or you could get a false reading on the dipstick.

## NOTICE

Too much or too little fluid can damage your transmission. Too much can mean that some of the fluid could come out and fall on hot engine parts, starting a fire. Be sure to get an accurate reading if you check your transmission fluid.

Wait at least 30 minutes before checking the transmission fluid level if you have been driving:

- When outside temperatures are above 90°F (32°C).
- At high speed for quite a while.
- In heavy traffic—especially in hot weather.
- While pulling a trailer.

## ***Service & Appearance Care***

---

To get the right reading, the fluid must be at normal operating temperature, which is 180°F to 200°F (82°C to 93°C).

**To check the transmission fluid hot:** Get the vehicle warmed up by driving about 15 miles (24 km) when outside temperatures are above 50°F (10°C). If it's colder than 50°F (10°C), drive the vehicle in **D** (3rd gear) until the engine temperature gage moves and then remains steady for ten minutes. Then follow the hot check procedures.

**To check transmission fluid cold:** A cold check is made after the vehicle has been sitting for eight hours or more with the engine off and is used only as a reference. Let the engine run at idle for five minutes if outside temperatures are 50°F (10°C) or more. If it's colder than 50°F (10°C), you may have to idle the engine longer. A hot check must follow when fluid is added during a cold check.

**To check the fluid hot or cold:**

- Park your vehicle on a level place.
- Place the shift lever in **P** (Park) with the parking brake applied.
- With your foot on the brake pedal, move the shift lever through each gear range, pausing for about three seconds in each range. Then, position the shift lever in **P** (Park).
- Let the engine run at idle for three minutes or more.

***Then, without shutting off the engine, follow these steps:***

1. Flip the handle up and then pull out the dipstick and wipe it with a clean rag or paper towel.

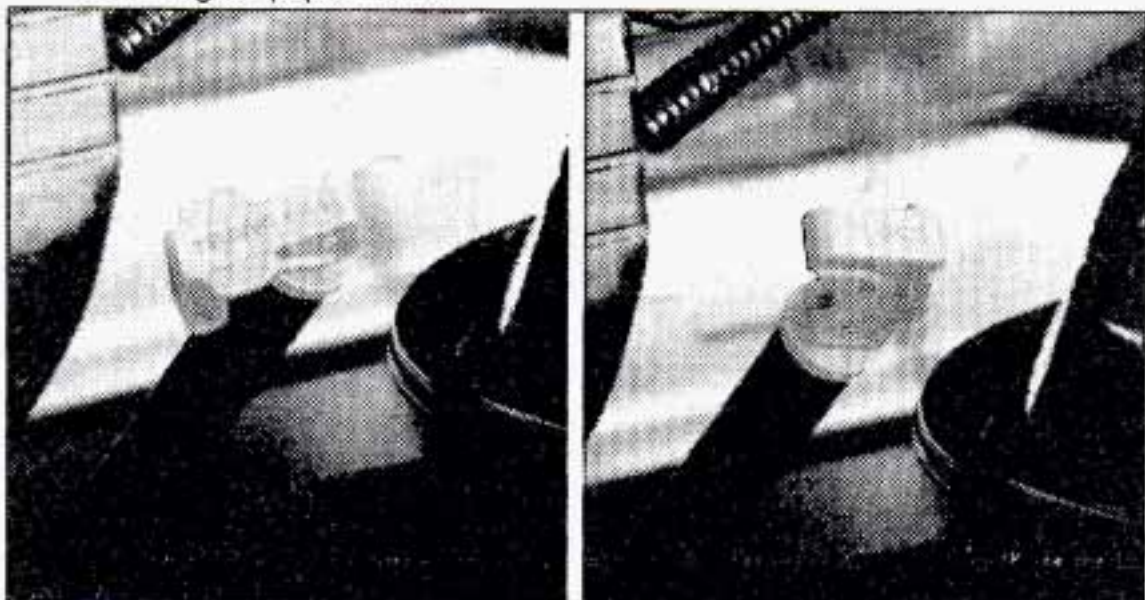

P0229

2. Push it back in all the way, wait three seconds and then pull it back out again.

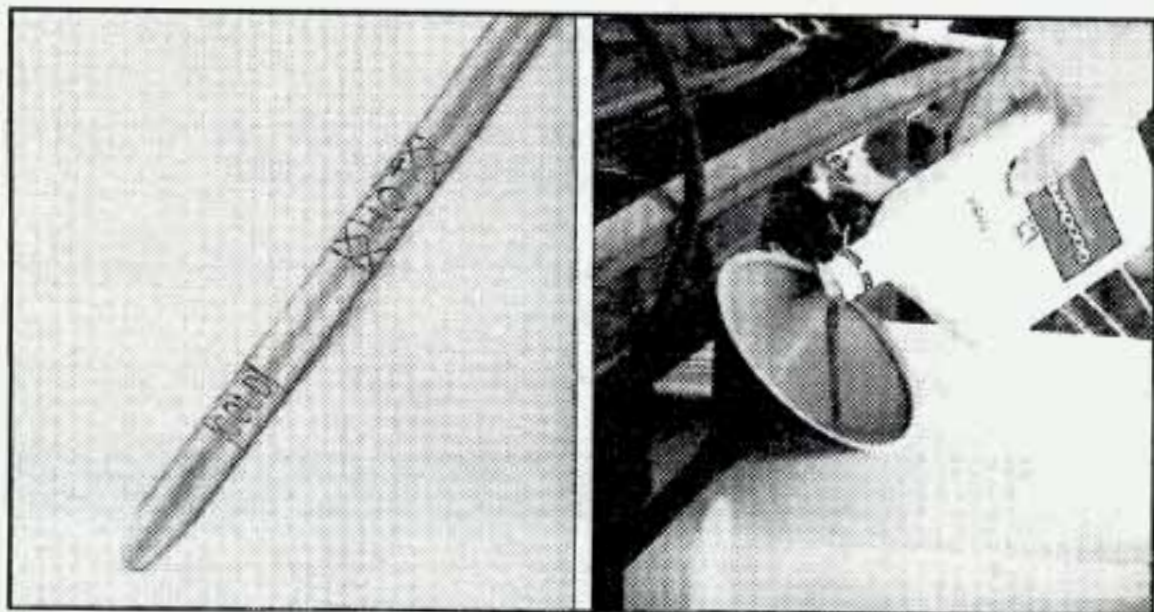

P0053

3. Check both sides of the dipstick, and read the lower level. The fluid level must be in the **COLD** area for a cold check or in the **HOT** area or cross-hatched area for a hot check.
4. If the fluid level is where it should be, push the dipstick back in all the way; then flip the handle down to lock the dipstick in place.

#### ***How To Add Fluid:***

Refer to the Maintenance Schedule to determine what kind of transmission fluid to use. See "Recommended Fluids and Lubricants" in the Index.

If the fluid level is low, add only enough of the proper fluid to bring the level up to the **COLD** area for a cold check or the **HOT** area for a hot check. It doesn't take much fluid, generally less than a pint. Don't overfill. We recommend you use only fluid labeled DEXRON®IIE, because fluids with that label are especially made for your automatic transmission. Damage caused by fluid other than DEXRON®IIE is not covered by your new vehicle warranty.

- After adding fluid, recheck the fluid level as described under "How To Check".
- When the correct fluid level is obtained, push the dipstick back in all the way; then flip the handle down to lock the dipstick in place.

## ***Service & Appearance Care***

---

### ***Manual Transmission Fluid***

#### ***When to Check:***

A good time to have it checked is when the engine oil is changed. However, the fluid in your manual transmission doesn't require changing.

#### ***How to Check:***

Because this operation can be a little difficult, you may choose to have this done at your dealership Service Department.

If you do it yourself, be sure to follow all the instructions here, or you could get a false reading.

### **NOTICE**

Too much or too little fluid can damage your transmission. Too much can mean that some of the fluid could come out and fall on hot engine parts, starting a fire. Be sure to get an accurate reading if you check your transmission fluid.

Check the fluid level only when your engine is off, the vehicle is parked on a level place and the transmission is cool enough for you to rest your fingers on the transmission case.

***Then, follow these steps:***

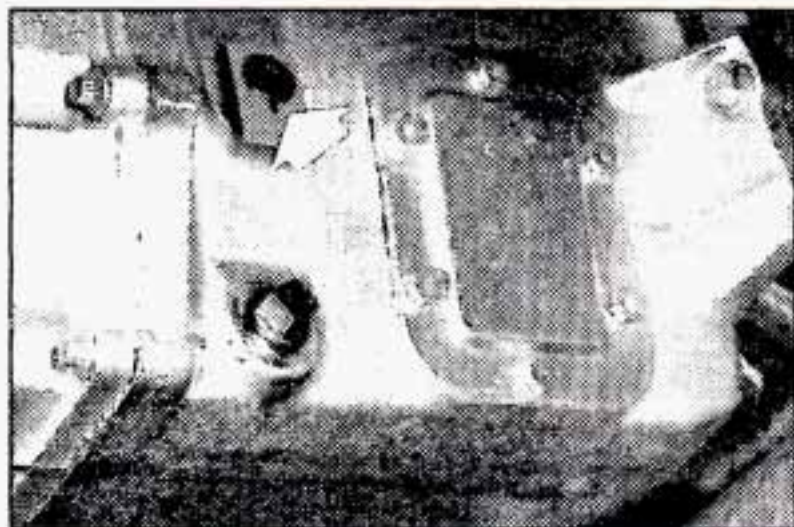

K2471

1. Remove the filler plug.
2. Check that the lubricant level is up to the bottom of the filler plug hole.
3. If the fluid level is good, install the plug and be sure it is fully seated. If the fluid level is low, add more fluid as described in the next steps.

---

---

### ***How to Add Fluid:***

Here's how to add fluid. Refer to the Maintenance Schedule to determine what kind of fluid to use. See "Recommended Fluids and Lubricants" in the Index.

1. Remove the filler plug.
2. Add fluid at the filler plug hole. Add only enough fluid to bring the fluid level up to the bottom of the filler plug hole.
3. Install the filler plug. Be sure that the filler plug is fully seated.

### ***Hydraulic Clutch***

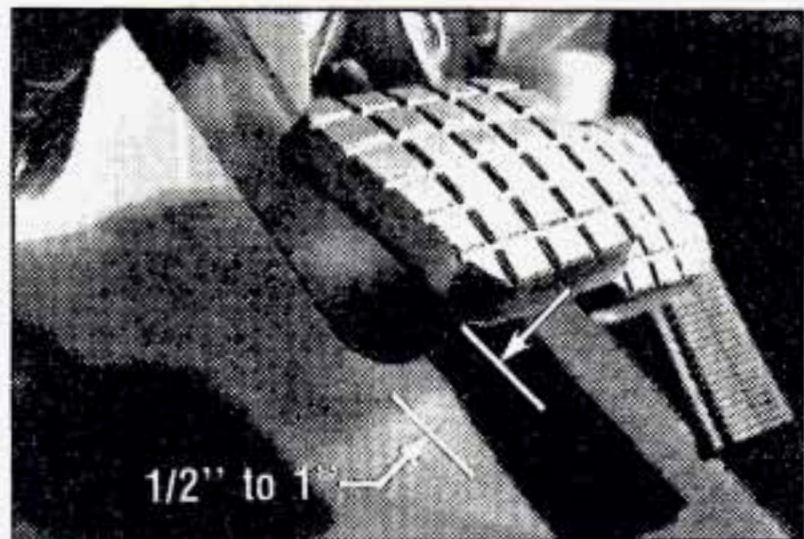

K2376

The hydraulic clutch in your vehicle is self-adjusting. A slight amount of play (1/2 inch to an inch) in the pedal is normal.

## ***Service & Appearance Care***

---

### ***When to Check and What to Use:***

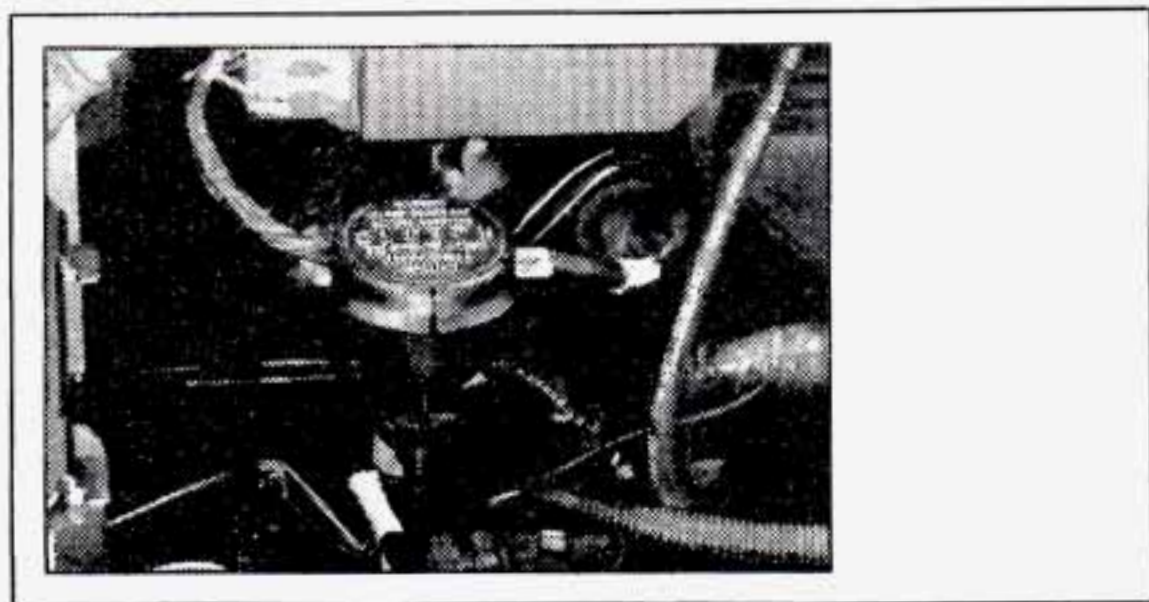

K2343

Refer to the Maintenance Schedule to determine how often you should check the fluid level in your clutch master cylinder reservoir and what to add. See "Owner Checks and Services" and "Recommended Fluids and Lubricants" in the Index.

### ***How to Check:***

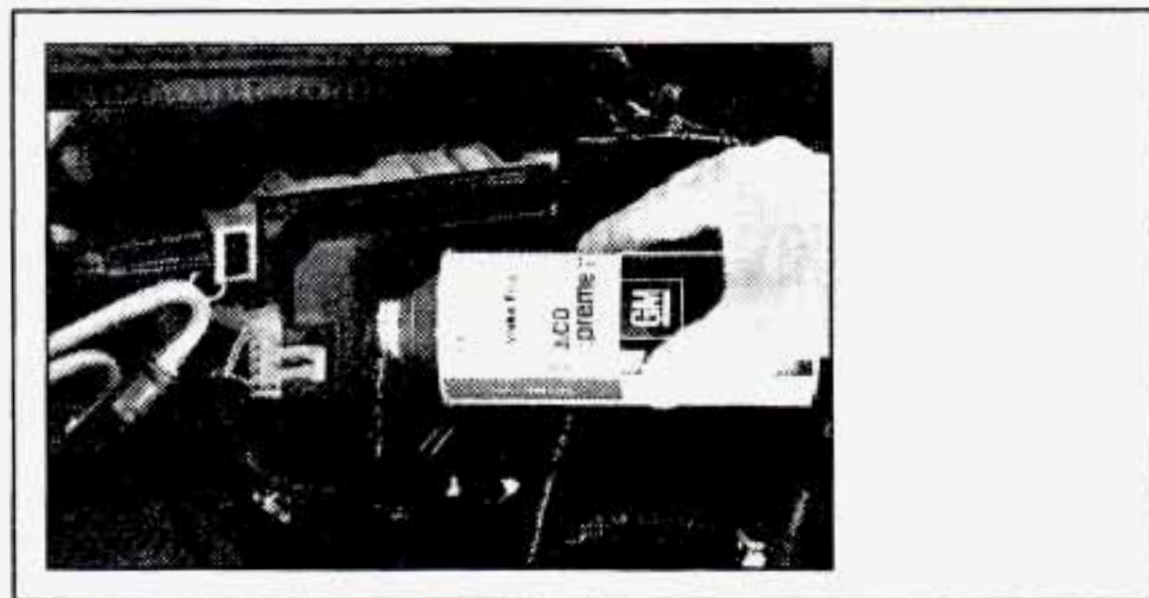

K2344

The proper fluid should be added if the level does not reach the bottom of the diaphragm when it's in place in the reservoir. See the instructions on the reservoir cap.



---

## ***Hydraulic Clutch Grease Fitting***

A grease fitting is on the clutch housing for lubricating the clutch fork ball stud. See your Maintenance Schedule for when to lubricate the clutch housing. See "Recommended Fluids and Lubricants" in the Index for the proper lubricant to use.

**Be sure not to over-fill because you could damage your clutch.**

## ***Four-Wheel Drive***

Most lubricant checks in this section also apply to four-wheel-drive vehicles. However, they have two additional systems that need lubrication.

## ***Transfer Case***

### ***When to Check Lubricant:***

Refer to the Maintenance Schedule to determine how often to check the lubricant. See "Periodic Maintenance Inspections" in the Index.

### ***How to Check and Add Lubricant:***

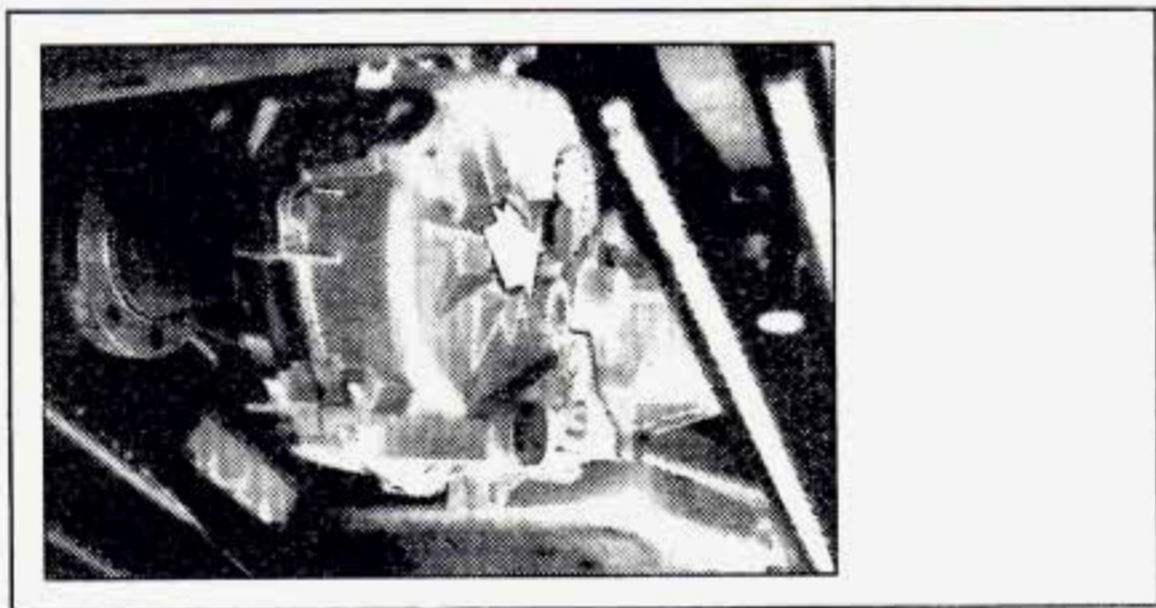

P0230

If the level is below the bottom of the filler plug hole, you'll need to add some lubricant. Add enough lubricant to raise the level to the bottom of the filler plug hole.

### ***What to Use:***

Refer to the Maintenance Schedule to determine what kind of lubricant to use. See "Recommended Fluids and Lubricants" in the Index.

# ***Service & Appearance Care***

---

## ***Front Axle***

### ***When to Check and Change Lubricant:***

Refer to the Maintenance Schedule to determine how often to check the lubricant and when to change it. See "Scheduled Maintenance Services" in the Index.

### ***How to Check Lubricant:***

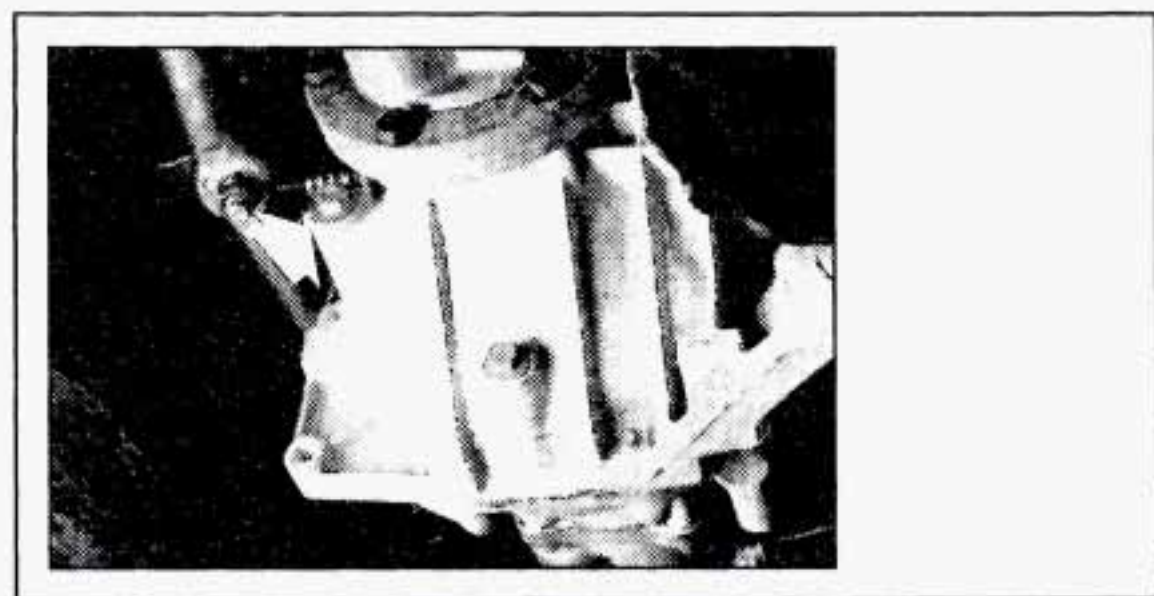

P0231

If the level is below the bottom of the filler plug hole, you'll need to add some lubricant. If the differential is at operating temperature (warm), add enough lubricant to raise the level to the bottom of the filler plug hole.

If the differential is cold, add enough lubricant to raise the level to 1/2 inch (12 mm) below the filler plug hole.

### ***What to Use:***

Refer to the Maintenance Schedule to determine what kind of lubricant to use. See "Recommended Fluids and Lubricants" in the Index.

## ***Rear Axle***

### ***When to Check and Change Lubricant:***

Refer to the Maintenance Schedule to determine how often to check the lubricant and when to change it. See "Recommended Fluids and Lubricants" in the Index.

---

## ***How to Check Lubricant:***

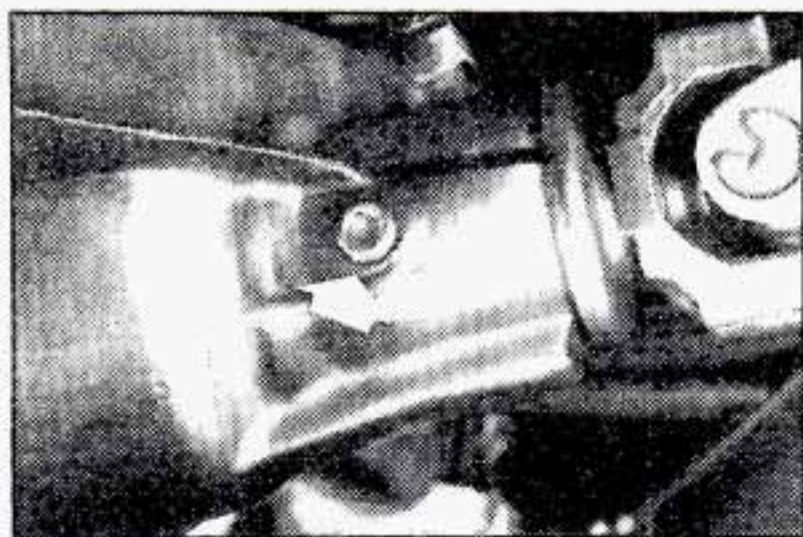

P0592

If the level is below the bottom of the filler plug hole, you'll need to add some lubricant. Add enough lubricant to raise the level to the bottom of the filler plug hole.

### ***What to Use:***

Refer to the Maintenance Schedule to determine what kind of lubricant to use. See "Recommended Fluids and Lubricants" in the Index.

## ***Engine Coolant***

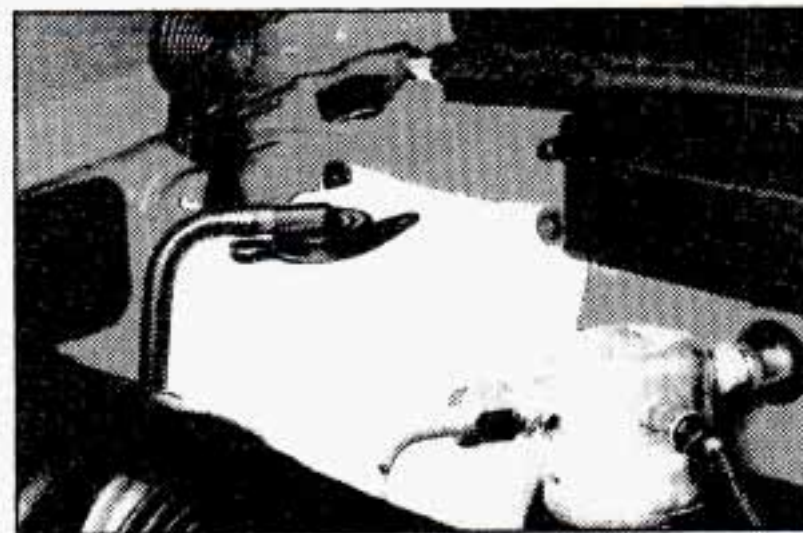

P0593

## ***Service & Appearance Care***

---

The following explains your cooling system and how to add coolant when it is low. If you have a problem with engine overheating, see "Engine Overheating" in the Index.

The proper coolant for your vehicle will:

- Give freezing protection down to -34°F (-37°C).
- Give boiling protection up to 258°F (125°C).
- Protect against rust and corrosion.
- Help keep the proper engine temperature.
- Let the warning lights and gages work as they should.

### ***What to Use:***

Use a mixture of **clean water** (preferably distilled), and antifreeze that meets "GM Specification 6038-M," which won't damage aluminum parts. Also use GM Engine Coolant Supplement (sealer) with a complete coolant change. If you use these, you don't need to add anything else.

### **CAUTION**



Adding only plain water to your cooling system can be dangerous. Plain water, or some other liquid like alcohol, can boil before the proper coolant mix will. Your vehicle's coolant warning system is set for the proper coolant mix. With plain water or the wrong mix, your engine could get too hot but you wouldn't get the overheat warning. Your engine could catch fire and you or others could be burned. Use a 50/50 mix of clean water and a proper antifreeze.

### **NOTICE**

If you use an improper coolant mix, your engine could overheat and be badly damaged. The repair cost wouldn't be covered by your warranty. Too much water in the mix can freeze and crack the engine, radiator, heater core and other parts.

Some conditions, such as air trapped in the cooling system, can affect the coolant level in the radiator. Check the coolant level when the engine is cold and follow the steps under "Adding Coolant" for the proper way to add coolant.

If you have to add coolant more than four times a year, have your dealer check your cooling system.

## NOTICE

If you use the proper coolant, you don't have to add extra inhibitors or additives which claim to improve the system. These can be harmful.

### *Adding Coolant*

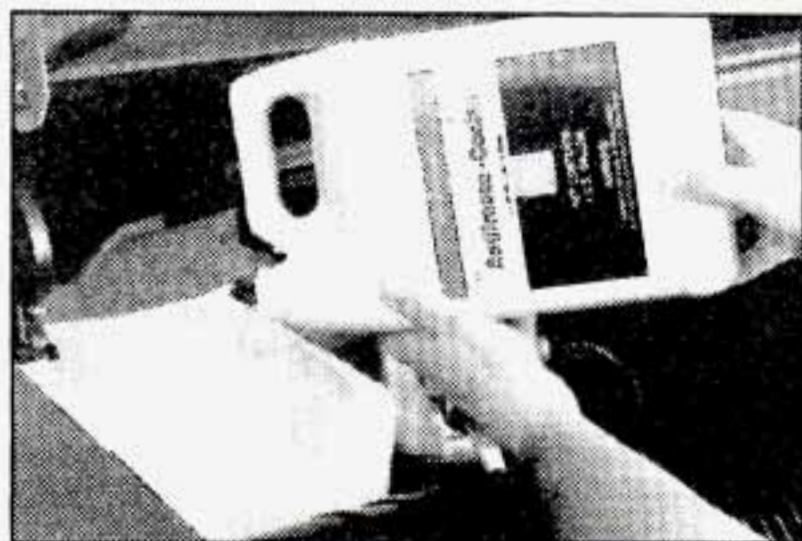

P0206

**To Check Coolant:** When your engine is cold, the coolant level should be at **COLD**, or a little higher. When your engine is warm, the level should be up to **HOT**, or a little higher.

**To Add Coolant:** If you need more coolant, **add the proper mix at the coolant recovery tank.**

## CAUTION



Turning the radiator pressure cap when the engine and radiator are hot can allow steam and scalding liquids to blow out and burn you badly. With the coolant recovery tank, you will almost never have to add coolant at the radiator. Never turn the radiator pressure cap—even a little—when the engine and radiator are hot.

Add coolant mix at the recovery tank, but be careful not to spill it.

## CAUTION



You can be burned if you spill coolant on hot engine parts. Coolant contains ethylene glycol, and it will burn if the engine parts are hot enough. Don't spill coolant on a hot engine.

## ***Service & Appearance Care***

---

### ***Radiator Pressure Cap***

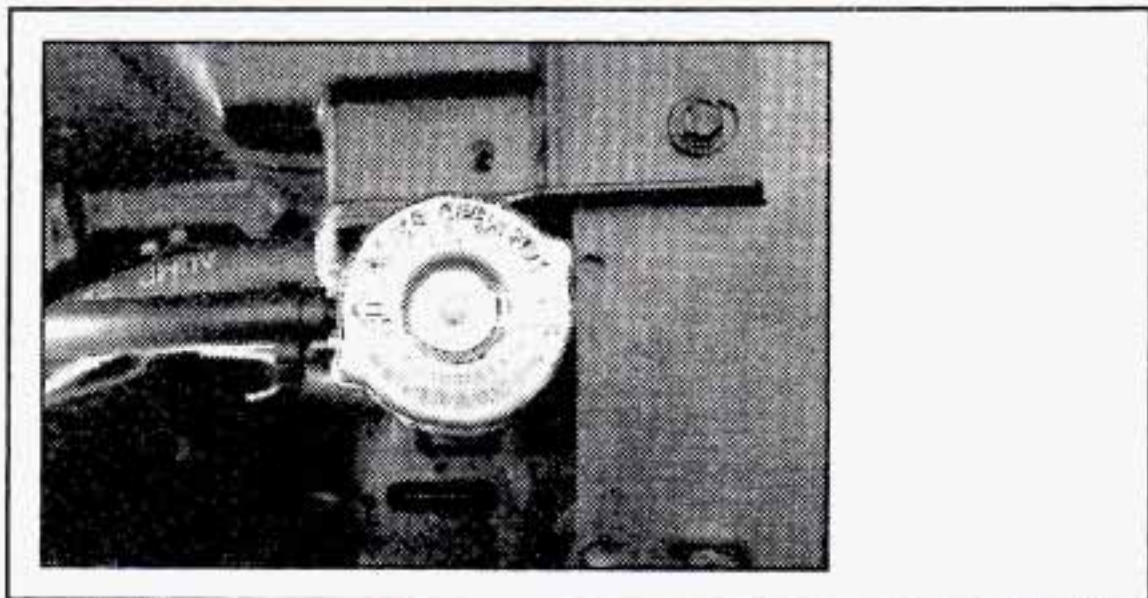

K2515

### **NOTICE**

Your radiator pressure cap is a 15 psi (105 kPa) pressure-type cap and must be tightly installed to prevent coolant loss and possible engine damage from overheating. Be sure the arrows on the cap line up with overflow tube on the radiator filler neck.

When you replace your radiator pressure cap, an AC<sup>®</sup> cap is recommended.

### ***Thermostat***

Engine coolant temperature is controlled by a thermostat in the engine coolant system. The thermostat stops the flow of coolant through the radiator until the coolant reaches a preset temperature.

When you replace your thermostat, an AC<sup>®</sup> thermostat is recommended.

---

## ***Power Steering Fluid***

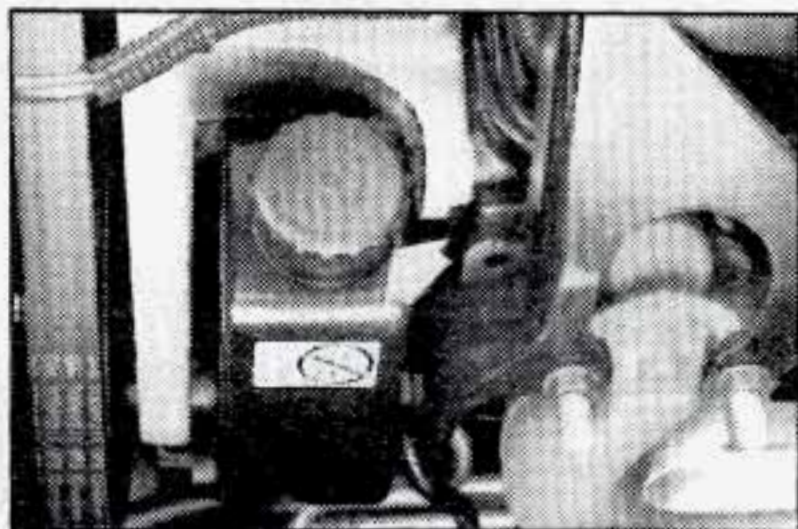

K2630

### ***How To Check Power Steering Fluid:***

Unscrew the cap and wipe the dipstick with a clean rag. Replace the cap and completely tighten it. Then remove the cap again and look at the fluid level on the dipstick.

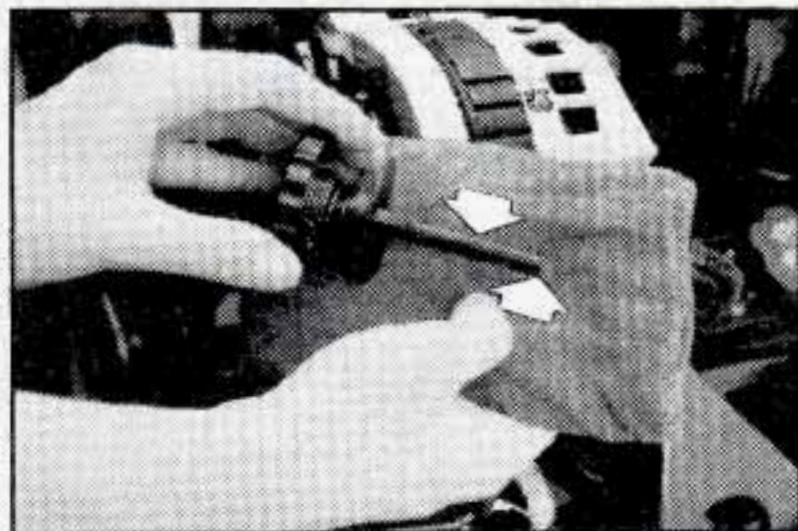

K2693

- When the engine compartment is hot, the level should be at the **FULL** mark.
- When the engine compartment is cool, the level should be at the **FULL COLD** mark.

## ***Service & Appearance Care***

---

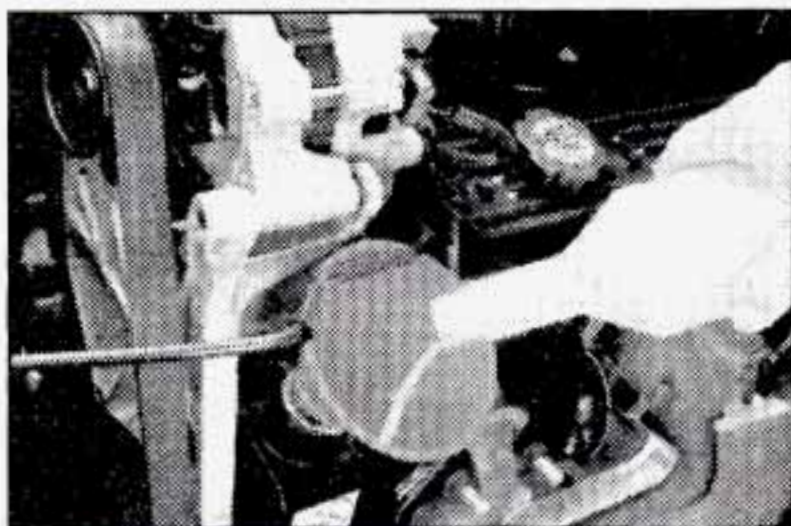

K2694

### ***What to Add:***

Refer to the Maintenance Schedule to determine what kind of fluid to use. See "Recommended Fluids and Lubricants" in the Index.

### **NOTICE**

When adding power steering fluid or making a complete fluid change, always use the proper fluid. Failure to use the proper fluid can cause leaks and damage hoses and seals.



---

## Windshield Washer Fluid

### To Add:

Open the cap labeled **WASHER FLUID ONLY**. Add washer fluid until the bottle is full.

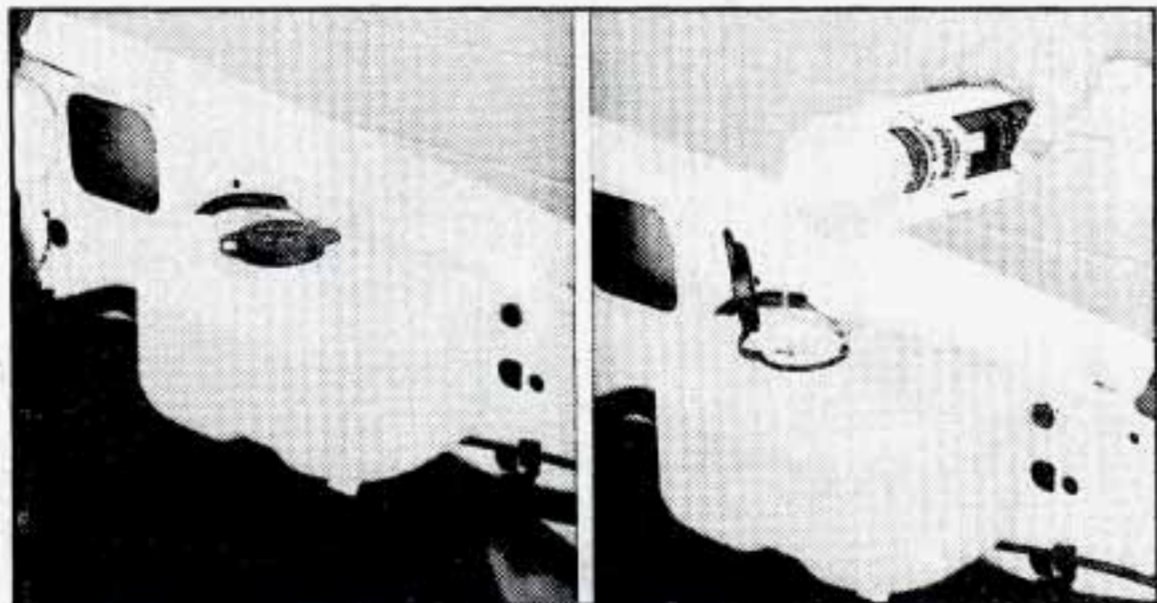

K2469

## NOTICE

- When using a concentrated washer fluid, follow the manufacturer's instructions for adding water.
- Don't mix water with ready-to-use washer fluid. Water can cause the solution to freeze and damage your washer fluid tank and other parts of the washer system. Also, water doesn't clean as well as washer fluid.
- Fill your washer fluid tank only 3/4 full when it's very cold. This allows for expansion, which could damage the tank if it is completely full.
- Don't use radiator antifreeze for your windshield washer. It can damage your washer system and paint.

## Service & Appearance Care

### Brake Master Cylinder

Your brake master cylinder is here. It is filled with DOT-3 brake fluid.



K2470

There are only two reasons why the brake fluid level in your master cylinder might go down. The first is that the brake fluid goes down to an acceptable level during normal brake lining wear. When new linings are put in, the fluid level goes back up. The other reason is that fluid is leaking out of the brake system. If it is, you should have your brake system fixed, since a leak means that sooner or later your brakes won't work well, or won't work at all. So, it isn't a good idea to "top off" your brake fluid. Adding brake fluid won't correct a leak. If you add fluid when your linings are worn, then you'll have too much fluid when you get new brake linings. You should add (or remove) brake fluid, as necessary only when work is done on the brake hydraulic system.

### CAUTION



If you have too much brake fluid, it can spill on the engine. The fluid will burn if the engine is hot enough. You or others could be burned, and your vehicle could be damaged. Add brake fluid only when work is done on the brake hydraulic system.

Refer to the Maintenance Schedule to determine when to check your brake fluid. See "Periodic Maintenance" in the Index.

### To Check Brake Fluid:

You can check the brake fluid without taking off the cap. Just look at the windows on the brake fluid reservoir. The fluid levels should be above the **MIN** mark. If they aren't, have your brake system checked to see if there is a leak.

---

---

After work is done on the brake hydraulic system, make sure the levels are above **MIN** and below the top of each window.

**What To Add:**

When you do need brake fluid, use only DOT-3 brake fluid—such as Delco Supreme 11<sup>®</sup> (GM Part No. 1052535). Use new brake fluid from a sealed container only.

**NOTICE**

- DOT-5 silicone brake fluid can damage your vehicle. Don't use it.
- Don't let someone put in the wrong kind of fluid. For example, just a few drops of mineral-based oil, such as engine oil, in your brake system can damage brake system parts so badly that they'll have to be replaced.
- Brake fluid can damage paint, so be careful not to spill brake fluid on your vehicle.

**Hydro-Boost Brake System (Hydraulic Pump)**

The power steering pump is also used as the Hydro-boost pump. Refer to "Power Steering System" in this section when checking fluid level or adding fluid.

**Replacing Brake System Parts**

The braking system on a modern vehicle is complex. Its many parts have to be of top quality and work well together if the vehicle is to have really good braking. Vehicles we design and test have top-quality GM brake parts in them, as your vehicle does when it is new. When you replace parts of your braking system—for example, when your brake linings wear down and you have to have new ones put in—be sure you get new genuine GM replacement parts. If you don't, your brakes may no longer work properly. For example, if someone puts in brake linings that are wrong for your vehicle, the balance between your front and rear brakes can change, for the worse. The braking performance you've come to expect can change in many other ways if someone puts in the wrong replacement brake parts.

## ***Service & Appearance Care***

---

### ***Other Maintenance Items***

#### ***Front Suspension and Steering Linkage***

Your maintenance schedule will tell you how often to lubricate the fittings. See "Recommended Fluids and Lubricants" in the Index for the proper lubricant to use.

#### ***Front Wheel Bearings***

Your vehicle has front wheel bearings that must be cleaned and repacked. Your maintenance schedule will tell you how often this must be done.

#### ***Front Shock Absorbers***

The front shock absorbers of your vehicle do many things. They help the vehicle ride smoothly and also control the travel of the suspension system. When the shock absorbers are serviced, any replacement shock absorbers must be the same as the original equipment shock absorbers in both extended length and strength.

### **NOTICE**

If you use shock absorbers that are not the same as the original shock absorbers, the shock absorbers or suspension system could be damaged.

#### ***Wheel Nut Torque***

For vehicles with dual wheels, when the vehicle, wheel or fasteners are new, have the torque set at the first 100, 1,000 and 6,000 miles (160, 1600 and 9600 km). Use the torque specified in the appropriate Specification Chart later in this section.

#### ***Single Belt Accessory Drive***

If your new vehicle uses a serpentine belt, it is lighter, and more durable than systems with several belts.

The belt runs over or around the pulleys on the engine. A tensioner is used to keep the belt tight at all times. The tensioner also makes replacing the belt easier. If you need to replace the belt, be sure to get the correct replacement belt. Your dealership or parts supplier can help you with this. The Accessory Drive Belt Routing label on your vehicle will show you how to route the belt your vehicle uses.

---

## **Windshield Wiper Blade Inserts**

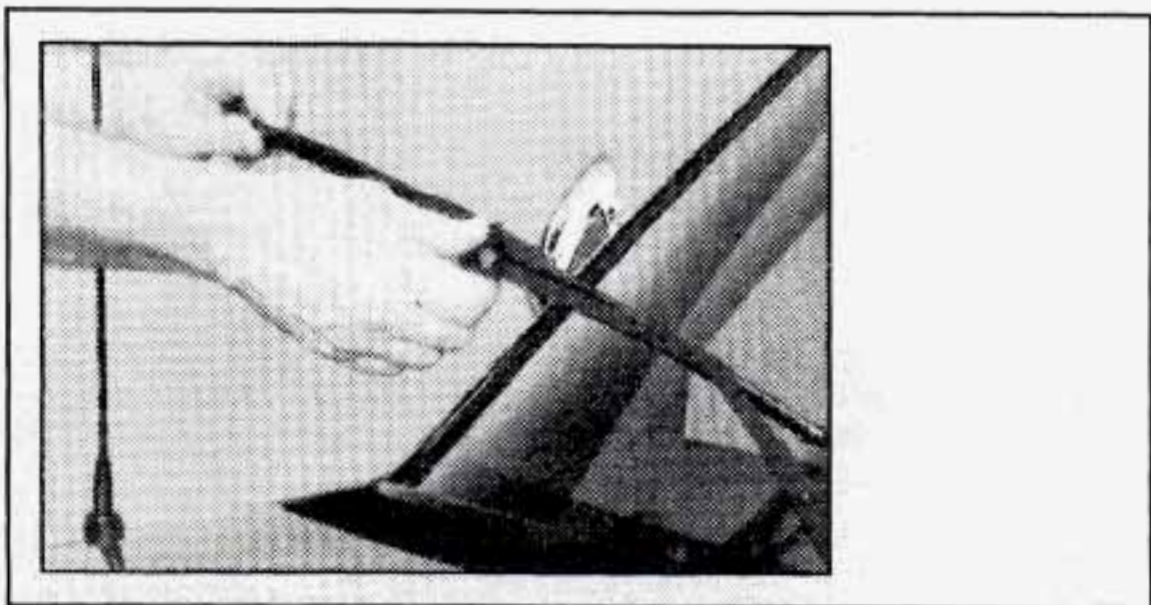

P0232

To replace the windshield wiper blade insert, lift the wiper arm and rotate the blade until it is facing away from the windshield. Unlatch the end of the insert from the holding clips. Remove the insert and slide a new one in place. Make sure the blade is secured in the clips.

### **Air Conditioning**

Every now and then have your dealership check your air conditioning system to be sure it has not lost any cooling ability. If you think the system is not working properly, have your dealership check it out as soon as possible.

The air conditioning will not work when the temperature is below 40°F (4°C).

### **Fluid Leak Check**

After the vehicle has been parked for a while, inspect the surface under the vehicle for water, oil, fuel or other fluids. Water dripping from the air conditioning system after it has been used is normal. If you notice fuel leaks or fumes, the causes should be found and corrected at once.

## **Lubrication**

### **Accelerator Control System**

Your maintenance schedule will tell you how often the accelerator linkage pivot points must be lubricated. See "Recommended Fluids and Lubricants" in the Index for the proper lubricant to use.

Accelerator cables and cruise control cables should not be lubricated. Any cables that are worn or are hard to pull should be replaced.

## ***Service & Appearance Care***

---

### ***Hood Latches and Hood Hinge***

Your maintenance schedule will tell you how often to lubricate the hood latch and hood hinge assembly. See "Recommended Fluids and Lubricants" in the Index for the proper lubricant to use.

### ***Propeller Shaft Slip Splines***

See your maintenance schedule to find out how often the slip splines must be lubricated. See "Recommended Fluids and Lubricants" in the Index for the proper lubricant to use.

### ***Constant Velocity Joints***

See your maintenance schedule to find out how often the constant velocity joints must be lubricated. See "Recommended Fluids and Lubricants" in the Index for the proper lubricant to use.

### ***Body***

Normal use of your vehicle will cause metal to metal wear at some points on the cab and body if they are not lubricated.

For exposed surfaces, such as door checks, door lock bolts, lock striker plates, dovetail bumper wedges, etc., a thin film of engine oil should be applied.

The seat adjusters and seat track should be lubricated with chassis grease.

Door weather strips and rubber hood bumpers should be lightly coated with a rubber lubricant.

Never use too much of any lubricant and be sure to wipe up any extra lubricant when you are finished.

Your maintenance schedule will tell you how often to lubricate these items. See "Recommended Fluids and Lubricants" in the Index for the proper lubricant to use.

### ***Lock Cylinders***

To be sure your locks operate properly, they must be lubricated. Your vehicle's maintenance schedule will tell you how often to lubricate them. See "Recommended Fluids and Lubricants" in the Index for the proper lubricant to use.

You should not use penetrating oils because they could wash out the factory installed lubricant and cause the lock to bind. De-icers which contain alcohol could also wash away the lubricant, so be sure to lubricate the lock after using a de-icer of this type.

---

## ***Tailgate Handle***

The tailgate handle pivot points on your vehicle should be lubricated to keep it working smoothly.

Your maintenance schedule will tell you how often to lubricate the handle. See "Recommended Fluids and Lubricants" in the Index for the proper lubricant to use.

## ***Electrical System***

### ***Battery***

Every new GM vehicle has a Delco Freedom<sup>®</sup> battery. You never have to add water to one of these. When it's time for a new battery, we recommend a Delco Freedom<sup>®</sup> battery. Get one that has the catalog number shown on the original battery's label.

### ***Vehicle Storage***

If you're not going to drive your vehicle for 25 days or more, take off the black, negative (—) cable from the battery. This will help keep your battery from running down.

## **CAUTION**



Batteries have acid that can burn you and gas that can explode. You can be badly hurt if you aren't careful. See "Jump Starting" in the Index for tips on working around a battery without getting hurt.

Contact your dealer to learn how to prepare your vehicle for longer periods.

### ***Bulb Replacement***

Before you replace any bulbs, be sure that all the lights are off and the engine isn't running.

# Service & Appearance Care

## Sealed Beam Headlights

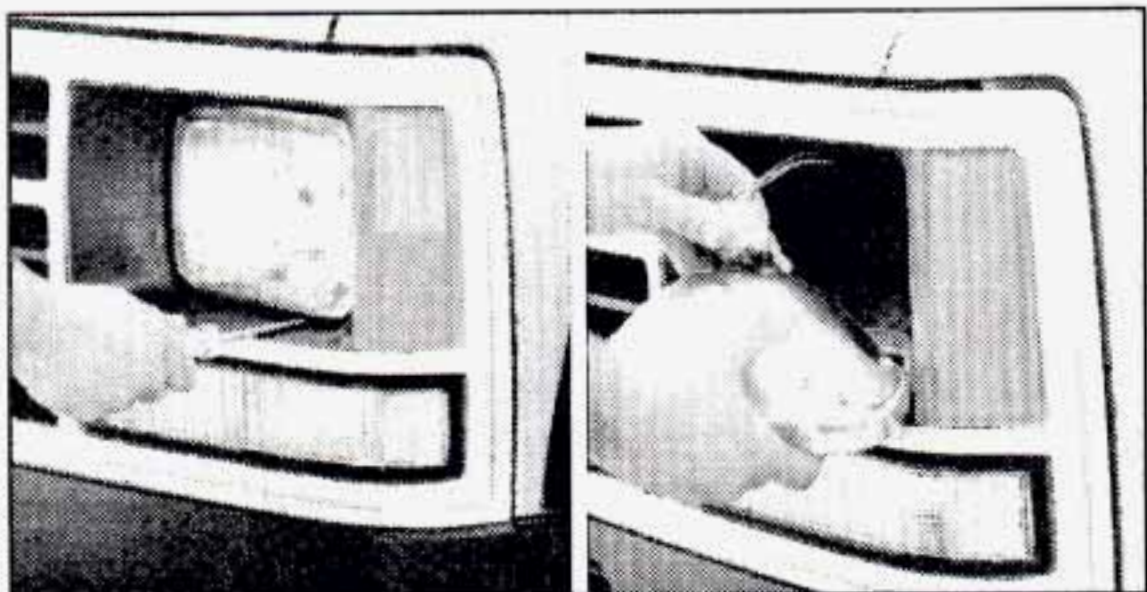

K2678

1. Remove the four screws from the headlight retainer.
2. Pull the headlight out and remove the retainer.
3. Unplug and remove old headlight.
4. Plug in the new headlight and put it in place.
5. Install the retainer to the headlight.
6. Install the screws.

## Halogen Bulbs

### CAUTION



Halogen bulbs have pressurized gas inside and can burst if you drop or scratch the bulb. You or others could be injured. Take special care when handling and disposing of halogen bulbs.

### NOTICE

Avoid touching the bulb or letting it come in contact with anything damp. Oil from your skin or moisture on the bulb can cause the bulb to explode when it is turned on. If either comes in contact with the bulb, clean it with alcohol or a suitable degreaser and wipe the bulb dry.



---

---

## *Composite Headlights*

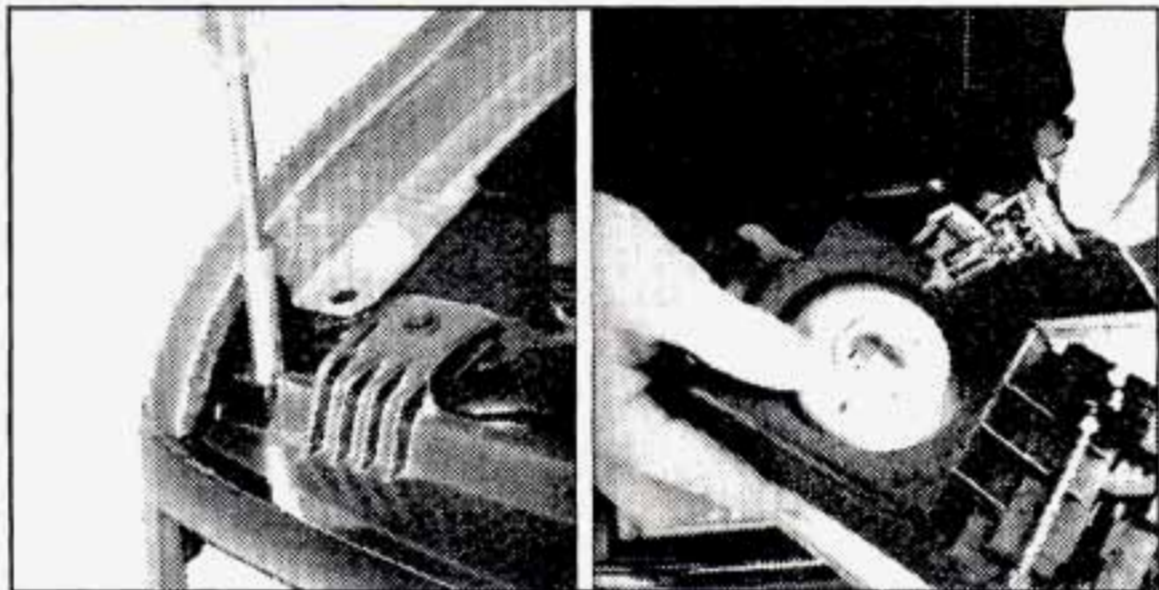

P0234

1. Remove the two screws at the top of the radiator support.
2. Pull the composite headlight lens out.
3. Unplug the electrical connector.
4. Turn the bulb counterclockwise and remove it.
5. Put the new bulb in and turn it clockwise until it is tight.
6. Plug in the electrical connector.
7. Put the headlight back into the vehicle and tighten the two screws.

## ***Service & Appearance Care***

---

### ***Front Parking/Turn Signal Lights***

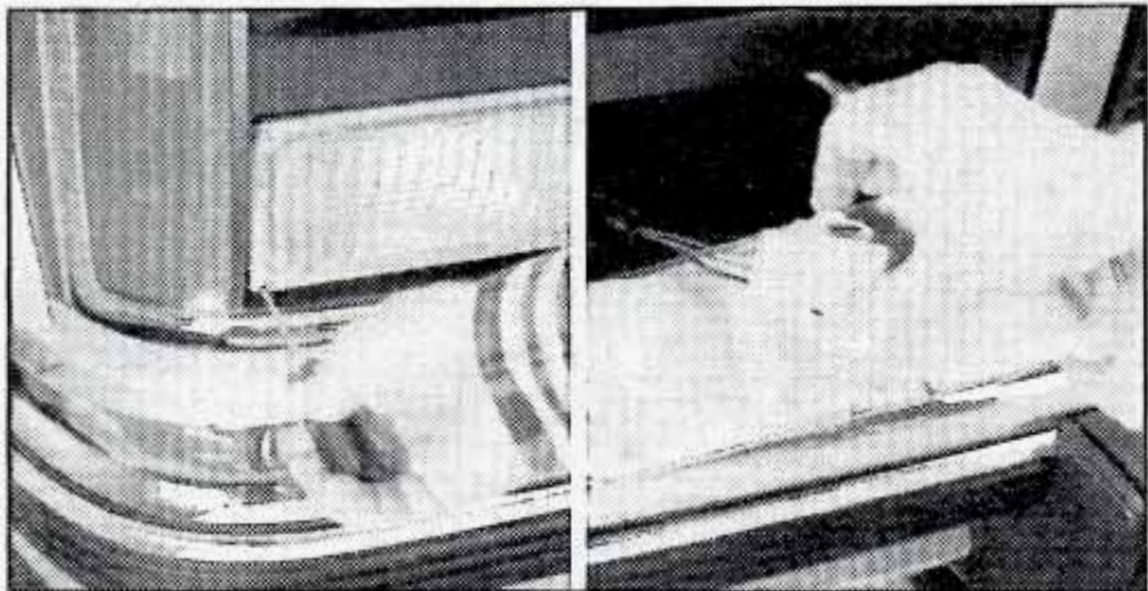

K2681

1. Remove the screws and take out the parking/turn signal light assembly.

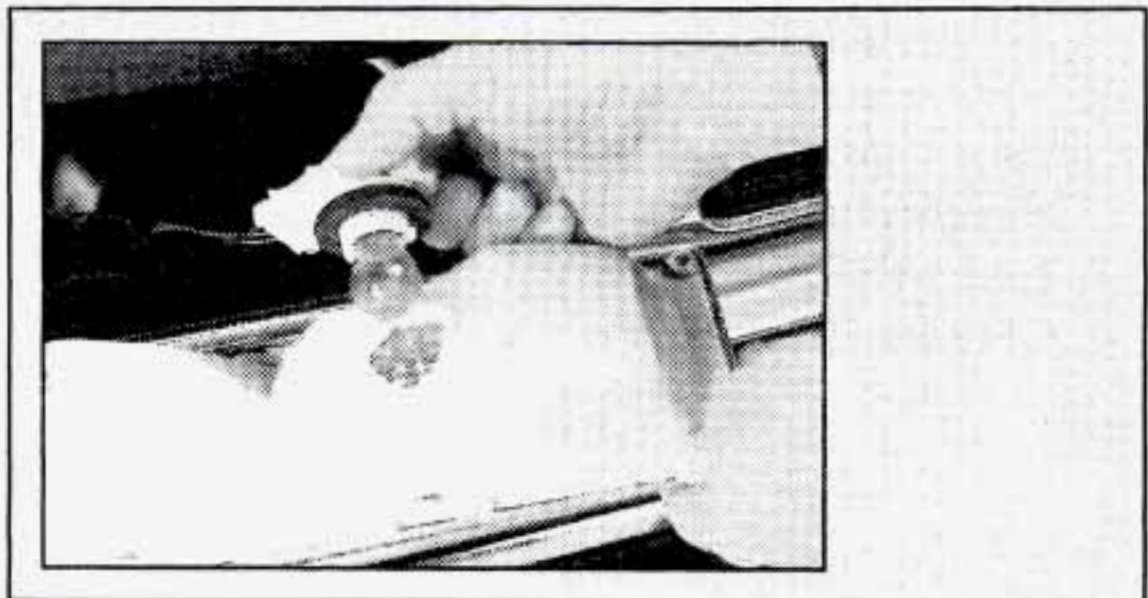

K2682

2. Squeeze the tab on the side of the light socket while turning the socket counterclockwise.
3. Pull out the socket.
4. Push in gently on the bulb, turn it counterclockwise and remove it from the socket.

- 
- 
5. Put the new bulb into the socket, gently press in on the bulb and turn it clockwise until it is tight.
  6. Put the socket back into the light assembly and turn it clockwise until it locks.
  7. Put the parking/turn signal light assembly back into the vehicle and tighten the screws.

### ***Side Marker Bulb***

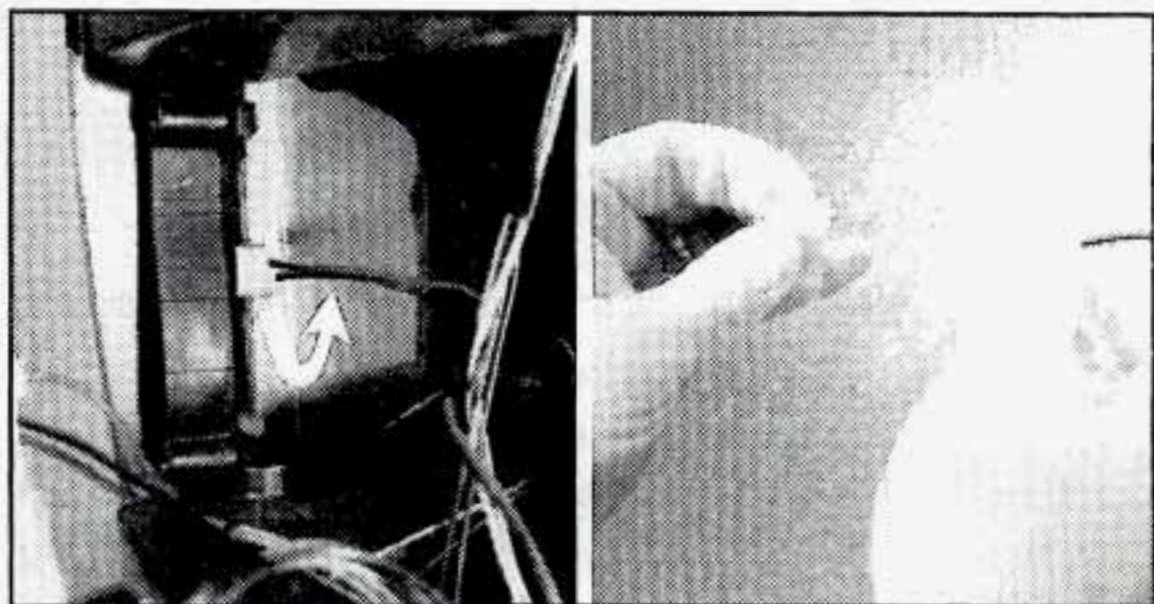

K2683

1. Remove the screws and pull out the parking/turn signal light assembly.
2. Reach through the opening and turn the side marker bulb socket counterclockwise and remove it.
3. Pull the bulb straight out of the socket.
4. Put a new bulb into the socket and push it in until it is tight.
5. Put the socket back into the side marker assembly and turn it clockwise to tighten it.
6. Replace the parking/turn signal light assembly and tighten the screws.

## ***Service & Appearance Care***

---

### ***Roof Marker Lights***

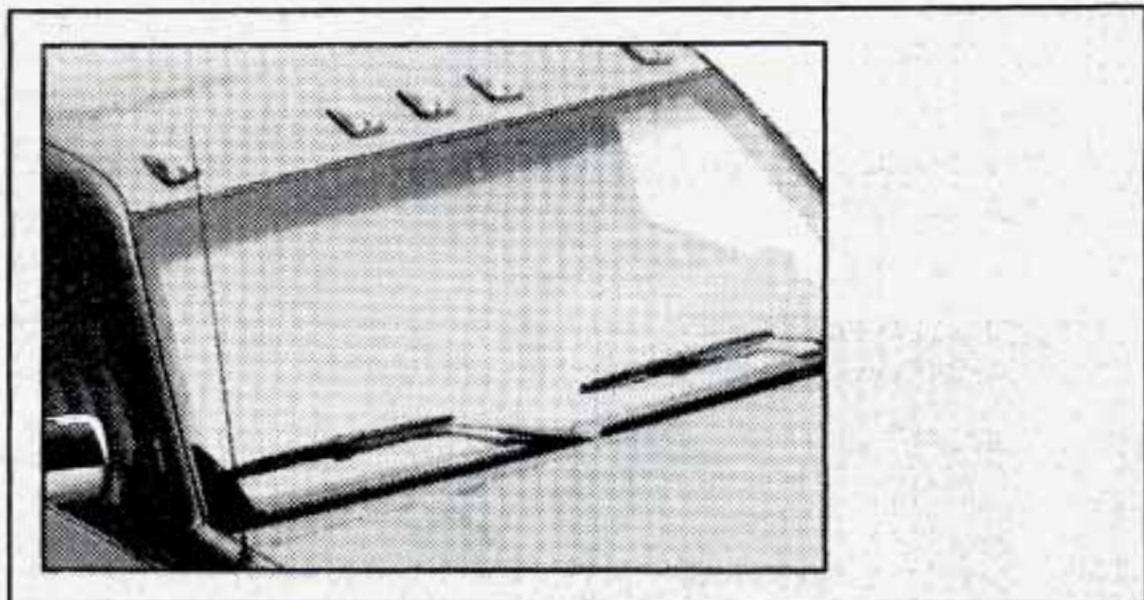

P0247

1. Remove the screws and lift off the lens.
2. Pull the bulb straight out of the socket
3. Put a new bulb into the socket and push it in until it is tight.
4. Replace the lens and tighten the screws.

### ***Rear Lights***

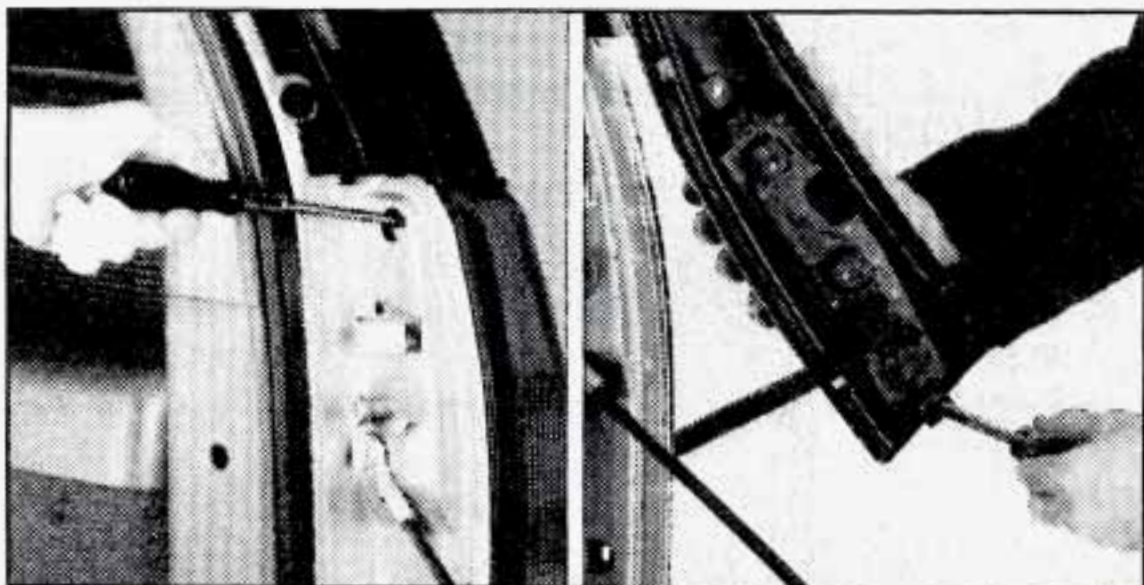

P0498

1. Open the tailgate or rear doors.

2. Remove the two black plastic plugs in the rear light assembly access holes.
3. Remove the two rear light assembly screws inside the fender and pull out the light assembly. You may want to use a magnetic screwdriver when removing the screws.



P0499

4. Remove the screws from the bulb retainer and take the bulb retainer off of the light assembly.
5. Pull the old bulb straight out of the socket
6. Put in a new bulb and push it in until it is tight.
7. Replace the bulb retainer.
8. Replace the rear light assembly and tighten the screws. You may want to use a magnetic screwdriver when installing the screws.
9. Close the tailgate or rear doors.

### ***Fuses and Circuit Breakers***

The wiring circuits in your vehicle are protected from short circuits by a combination of fuses, circuit breakers, and fusible thermal links in the wiring itself. This greatly reduces the chance of fires caused by electrical problems. See "Fuses and Circuit Breakers" in the Index for more information.

### ***Headlights***

The headlight wiring is protected by a circuit breaker in the light switch. An electrical overload will cause the lights to go on and off, or in some cases to remain off. If this happens, have your headlight wiring checked right away.

## ***Service & Appearance Care***

---

### ***Windshield Wipers***

The windshield wiper motor is protected by a circuit breaker and a fuse. If the motor overheats due to heavy snow, etc., the wiper will stop until the motor cools. If the overload is caused by some electrical problem and not snow, etc., be sure to get it fixed.

### ***Power Windows and Other Power Options***

Circuit breakers in the fuse panel protect the power windows and other power accessories. When the current load is too heavy, the circuit breaker opens and closes, protecting the circuit until the problem is fixed or goes away.

### ***Trailer Wiring Harness***

The optional seven-wire trailer wiring harness is protected by an in-line fuse in the battery feed wire. This fuse is near the junction block. See "Trailer Wiring Harness" in the Index for more information.

### ***Fuse Block***

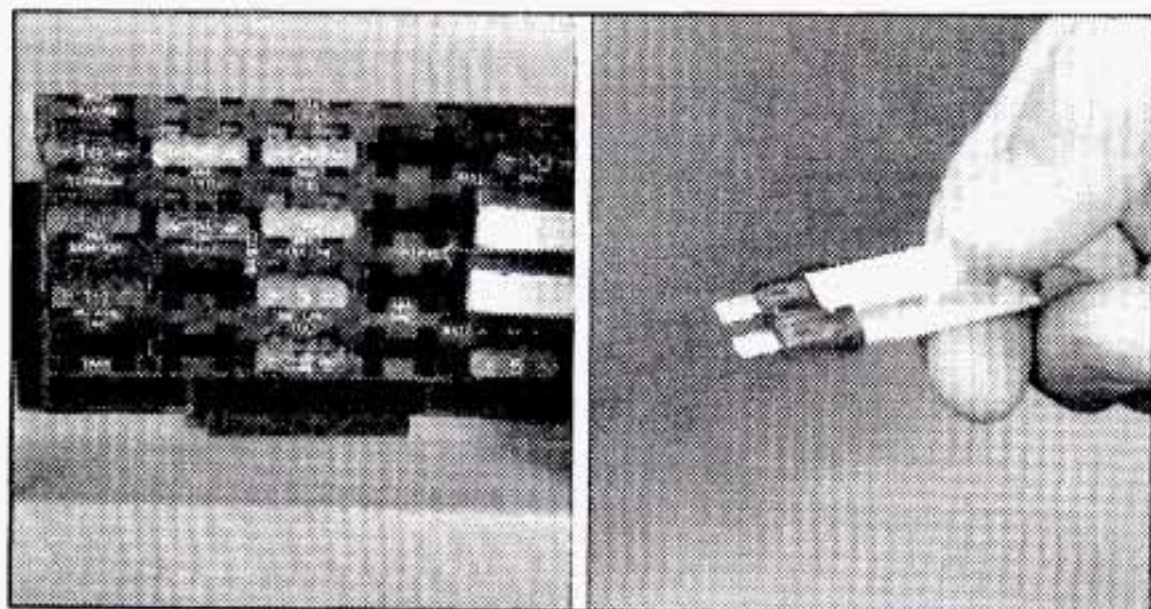

K2644

The fuse block is in the instrument panel on the driver's side.

You can remove fuses with a fuse extractor, if you have one. To remove fuses if you don't have one, hold the end of the fuse between your thumb and index finger and pull straight out.

Be sure to use the correct fuse. If you ever have a problem on the road and don't have a spare fuse, you can "borrow" one of the correct value. Just pick some feature of your vehicle that you can get along without—like the radio or cigarette lighter—and use its fuse, if it is of the value you need. Replace it as soon as you can. See "Fuses and Circuit Breakers" in the Index for more information.

---

---

## ***Exhaust System***

To help prevent damage to your exhaust system, do not continue to drive your vehicle if you notice:

- Engine misfiring
- Loss of performance
- Other unusual operating conditions

Have your engine and exhaust system serviced regularly.

### ***Three-Way Catalytic Converter***

Your vehicle's three-way catalytic converter is designed to reduce the pollutants in your vehicle's exhaust. Use only unleaded fuel in your vehicle. If you use leaded fuel, you could damage your three-way catalytic converter, and other engine components.

### ***Computer Command Control System***

This system has an oxygen (OS) sensor that helps keep your engine's air-fuel mixture at a proper level. Use only unleaded fuel in your vehicle. If you use leaded fuel, you could damage your oxygen (OS) sensor and three-way catalytic converter.

The Malfunction Indicator Lamp (**SERVICE ENGINE SOON**) on your instrument panel lets you know when your emission control system needs service. The light will come on briefly when you start your engine to let you know that the system is working. If it does not come on when you start your engine, or if it comes on and stays on while you're driving your system may need service. Your vehicle should still be driveable, but you should have your system serviced right away.

### ***Secondary Air Injection (AIR) System***

You may have this system. It lets you know if your engine control module, wiring harness or solenoid need service. If the Malfunction Indicator Lamp (**Service Engine Soon**) comes on, you need service.

# Service & Appearance Care

## Loading Your Vehicle

MFD BY GENERAL MOTORS CORP				
	GVWR	GAWR FRT	GAWR RR	LB/KG
THIS VEHICLE CONFORMS TO ALL APPLICABLE FEDERAL MOTOR VEHICLE SAFETY STANDARDS IN EFFECT ON THE DATE OF MANUFACTURE SHOWN ABOVE.				
<b>EXAMPLE</b>				
MODEL	SPEED			
TIRE SIZE	RTG	RIM	PSI/KPA (COLD)	
FRT				
RR				
SPA				
SEE OWNERS MANUAL FOR ADDITIONAL INFORMATION				

K2134

The Certification/Tire label is found on the rear edge of the driver's door. The label shows the size of your original tires and the inflation pressures needed to obtain the gross weight capacity of your vehicle. This is called the GVWR (Gross Vehicle Weight Rating). The GVWR includes the weight of the vehicle, all occupants, fuel and cargo.

The Certification/Tire label also tells you the maximum weights for the front and rear axles, called Gross Axle Weight Rating (GAWR). To find out the actual loads on your front and rear axles, you need to go to a weigh station and weigh your vehicle. Your dealer can help you with this. Be sure to spread out your load equally on both sides of the centerline.

Never exceed the GVWR for your vehicle, or the Gross Axle Weight Rating (GAWR) for either the front or rear axle.

And, if you do have a heavy load, you should spread it out.

### CAUTION



Do not load your vehicle any heavier than the GVWR or the maximum front and rear GAWRs. If you do, parts on your vehicle can break, or it can change the way your vehicle handles. These could cause you to lose control. Also, overloading can shorten the life of your vehicle.

Using heavier suspension components to get added durability might not change your weight ratings. Ask your dealer to help you load your vehicle the right way.



## NOTICE

Your warranty does not cover parts or components that fail because of overloading.

If you put things inside your vehicle—like suitcases, tools, packages, or anything else—they will go as fast as the vehicle goes. If you have to stop or turn quickly, or if there is a crash, they'll keep going.

## CAUTION



Things you put inside your vehicle can strike and injure people in a sudden stop or turn, or in a crash.

- Put things in the cargo area of your vehicle. Try to spread the weight evenly.
- Never stack heavier things, like suitcases, inside the vehicle so that some of them are above the tops of the seats.
- When you carry something inside the vehicle, secure it whenever you can.
- Don't have a seat folded down unless you need to.

### *Trailing Package*

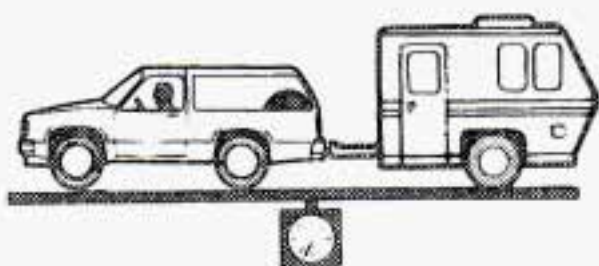

**GROSS COMBINATION WEIGHT RATING  
(GCWR)**

P0340

If your vehicle comes with the Trailing Package, there is also a load rating which includes the weight of the vehicle and the trailer it tows. This rating is called the Gross Combination Weight Rating (GCWR).

## ***Service & Appearance Care***

---

When you weigh your trailer, be sure to include the weight of everything you put in it. And, remember to figure the weight of the people inside as part of your load.

Your dealer can help you determine your GCWR.

### ***Add-On Equipment***

When you carry removable items, like snow plow blades, you may need to put a limit on how many people you carry inside your vehicle. Be sure to weigh your vehicle before you buy and install the new equipment.

### **NOTICE**

Your warranty doesn't cover parts or components that fail because of overloading.

### ***Tires***

We don't make tires. Your new vehicle comes with high quality tires made by a leading tire manufacturer. These tires are warranted by the tire manufacturers and their warranties are delivered with every new vehicle. If your spare tire is a different brand than your road tires, you will have a tire warranty folder from each of these manufacturers.

## CAUTION



Poorly maintained and improperly used tires are dangerous.

- Overloading your tires can cause overheating as a result of too much friction. You could have an air-out and a serious accident. See "Loading Your Vehicle" in the Index.
- Underinflated tires pose the same danger as overloaded tires. The resulting accident could cause serious injury. Check all tires frequently to maintain the recommended pressure. Tire pressure should be checked when your tires are cold.
- Overinflated tires are more likely to be cut, punctured, or broken by sudden impact, such as when you hit a pothole. Keep tires at the recommended pressure.
- Worn, old tires can cause accidents. If your tread is badly worn, or if your tires have been damaged, replace them.
- Even if it's legal, don't drive over 85 mph (135 km/h) if you have 16 inch tires.

See "Special Tire Inflation" in this section for more information on loading and inflation pressures at speeds above 65 mph (105 km/h).

### ***Inflation—Tire Pressure***

The Certification/Tire label which is on the rear edge of the driver's door, or on the incomplete vehicle document in the cab, shows the correct inflation pressures for your tires, when they're cold. "Cold" means your vehicle has been sitting for at least three hours or driven no more than a mile.

You can operate some vehicles at reduced inflation pressures only when you'll be carrying reduced loads. On those vehicles, the minimum cold inflation pressures for a typical reduced load are printed on the "Improved Ride Tire Pressure" label located on the driver's door. Weigh the vehicle to find the load on each tire and see the label for the minimum cold inflation pressures for that load.

## ***Service & Appearance Care***

---

### **NOTICE**

Don't let anyone tell you that underinflation or overinflation is all right. It's not. If your tires don't have enough air (underinflation) you can get:

- Too much flexing
- Too much heat
- Tire overloading
- Bad wear
- Bad handling
- Bad fuel economy.

If your tires have too much air (overinflation), you can get:

- Unusual wear
- Bad handling
- Rough ride
- Needless damage from road hazards.

**When to Check:** Check your tires once a month or more. Also, check the tire pressure of the spare tire.

**How to Check:** Use a good quality pocket-type gage to check tire pressure. Simply looking at the tires will not tell you the pressure, especially if you have radial tires—which may look properly inflated even if they're underinflated.

If your tires have valve caps, be sure to put them back on. They help prevent leaks by keeping out dirt and moisture.

### ***Special Tire Inflation***

- If you have **16 inch tires** on your vehicle, and:
  - You'll be driving for very long at speeds of 66 mph (105 km/h) to 75 mph (120 km/h) where legal, inflate tires 10 psi (70 kPa) more than the recommended cold inflation pressure.
  - You'll be driving for very long at speeds of 76 mph (120 km/h) to 85 mph (135 km/h) where legal, cold inflation pressure should be increased by 10 psi (70 kPa) and you must also reduce axle load capacity by 10%. **Do not drive over 85 mph (135 km/h) even if it's legal.**
  - Inflation pressures should never exceed 10 psi (70 kPa) above the inflation specified for the maximum load of the tire.

TIRE LOAD LIMIT CHART

(TIRE LOAD LIMITS ARE SHOWN. VEHICLE LOADING MUST BE LIMITED SUCH THAT THE TIRE INFLATION PRESSURE OR LOAD LIMITS ARE NOT EXCEEDED.)

RADIAL TIRE SIZE AND LOAD LIMITS-LBS. (kg) -  
Metric Radial Tires

Tire Size	Load Range	Inflation Pressure ... PSI (kPa)				
		36 (250)	44 (300)	51 (350)	58 (400)	65 (450)
L1225/75R16	C	1543 (700)	1753 (795)	1940 (880)	-	2150 (970)
L1225/75R16	D	1943 (700)	1753 (795)	1940 (880)	2141 (970)	2340 (1060)
L1245/75R16	C	1742 (790)	1987 (900)	2207 (1000)	-	-
L1245/75R16	E	1742 (790)	1987 (900)	2207 (1000)	2426 (1100)	2647 (1200)
L1265/75R16	E	1960 (890)	2230 (1010)	2472 (1120)	-	-

## Service & Appearance Care

### Tire Inspection and Rotation

To make your tires last longer, have them inspected and rotated at the mileages recommended in the Maintenance Schedule. See "Scheduled Maintenance Services" in the Index.

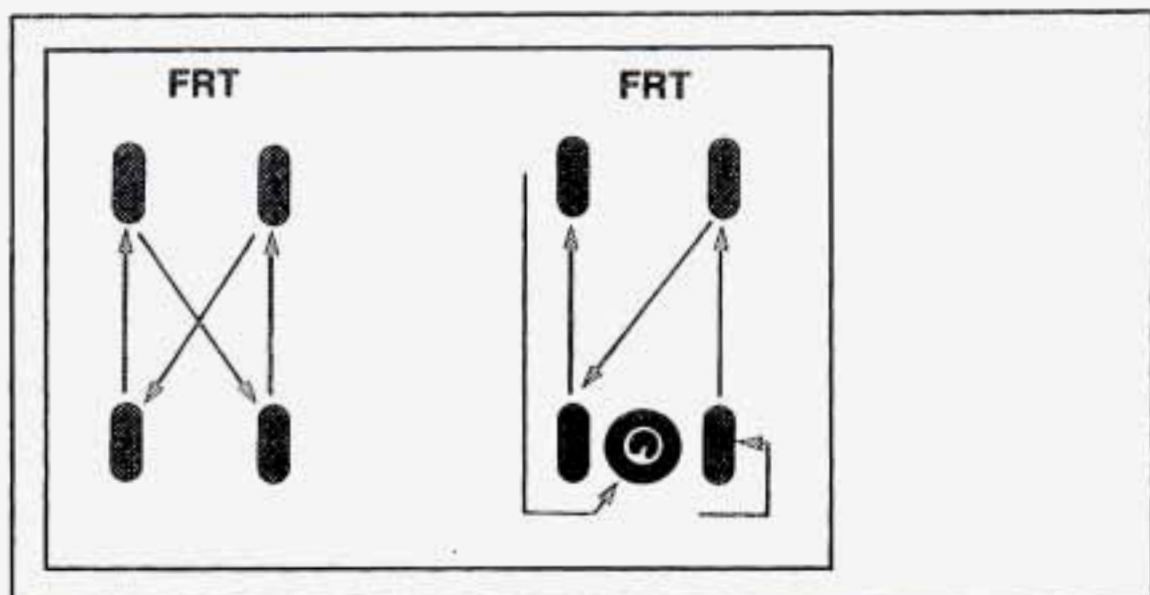

K2655

Use this rotation pattern.

If your vehicle has front tires with different load ratings or tread designs (such as all season vs. on/off road) than the rear tires, don't rotate your tires front to rear.

After the tires have been rotated, adjust the front and rear inflation pressure as shown on the Certification/Tire label. Make certain that all wheel nuts are properly tightened. See "Wheel Nut Torque" in the Index.

### CAUTION



Rust or dirt on a wheel, or on the parts to which it is fastened, can make the wheel nuts become loose after a time. The wheel could come off and cause an accident. When you change a wheel, remove any rust or dirt from places where the wheel attaches to the vehicle. In an emergency, you can use a cloth or paper towel to do this; but be sure to use a scraper or wire brush later, if you need to, to get all the rust or dirt off. (See "Changing a Flat Tire" in the Index.)

---

## ***When It's Time for New Tires***

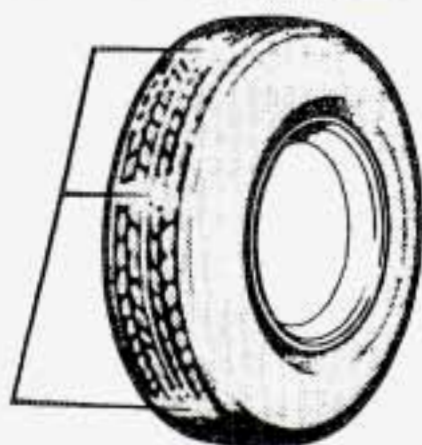

**TREAD WEAR INDICATORS**

K1656

One way to tell when it's time for new tires is to check the treadwear indicators, which will appear when your tires have only 2/32 inch (1.6 mm) or less of tread remaining.

You need a new tire if:

- You can see the indicators at three places around the tire.
- You can see cord or fabric showing through the tire's rubber.
- The tread or sidewall is cracked, cut or snagged deep enough to show cord or fabric.
- The tire has a bump, bulge or split.
- The tire has a puncture, cut, or other damage that can't be repaired well because of the size or location of the damage.

### ***Buying New Tires***

To find out what kind and size of tires you need, look at the Certification/Tire label. The tires installed on your vehicle when it was new had a Tire Performance Criteria Specification (TPC Spec) number on each tire's sidewall. When you get new tires, get ones with that same TPC Spec number. That way, your vehicle will continue to have tires that are designed to give proper endurance, handling, speed rating, traction, ride and other things during normal service on your vehicle. If your tires have an all-season tread design, the TPC number will be followed by a "MS" (for mud and snow).

## ***Service & Appearance Care***

---

If you ever replace your tires with those not having a TPC Spec number, make sure they are the same size, load range, speed rating and construction type (bias, bias-belted or radial) as your original tires.

### **CAUTION**



Mixing tires could cause you to lose control while driving. If you mix tires of different sizes or types (radial and bias-belted tires) the vehicle may not handle properly, and you could have a crash. Be sure to use the same size and type tires on all wheels.

### ***Uniform Tire Quality Grading***

The following information relates to the system developed by the United States National Highway Traffic Safety Administration which grades tires by treadwear, traction and temperature performance. (This applies only to vehicles sold in the United States.)

#### ***Treadwear***

The treadwear grade is a comparative rating based on the wear rate of the tire when tested under controlled conditions on a specified government test course. For example, a tire graded 150 would wear one and a half (1 1/2) times as well on the government course as a tire graded 100. The relative performance of tires depends upon the actual conditions of their use, however, and may depart significantly from the norm due to variations in driving habits, service practices and differences in road characteristics and climate.

#### ***Traction—A, B, C***

The traction grades, from highest to lowest are: A, B, and C. They represent the tire's ability to stop on wet pavement as measured under controlled conditions on specified government test surfaces of asphalt and concrete. A tire marked C may have poor traction performance.

Warning: The traction grade assigned to this tire is based on braking (straight-ahead) traction tests and does not include cornering (turning) traction.

#### ***Temperature—A, B, C***

The temperature grades are A (the highest), B, and C, representing the tire's resistance to the generation of heat and its ability to dissipate heat when tested under controlled conditions on a specified indoor laboratory test wheel. Sustained high temperature can cause the material of the tire to degenerate and reduce tire life, and excessive temperature can lead to sudden tire failure. The grade C corresponds to a level of performance which all passenger car tires must meet under the Federal Motor Vehicle Safety



---

Standard No. 109. Grades B and A represent higher levels of performance on the laboratory test wheel than the minimum required by law.

Warning: The temperature grade for this tire is established for a tire that is properly inflated and not overloaded. Excessive speed, underinflation, or excessive loading, either separately or in combination, can cause heat buildup and possible tire failure.

Those grades are molded on the sidewalls of passenger car tires.

While the tires available as standard or optional equipment on General Motors vehicles may vary with respect to these grades, all such tires meet General Motors performance standards and have been approved for use on General Motors vehicles. All passenger type (P Metric) tires must conform to Federal safety requirements in addition to these grades.

### ***Wheel Alignment and Tire Balance***

The wheels on your vehicle were aligned and balanced carefully at the factory to give you the longest tire life and best overall performance.

In most cases, you will not need to have your wheels aligned again. However, if you notice unusual tire wear or your vehicle pulling one way or the other, the alignment may need to be reset. If you notice your vehicle vibrating when driving on a smooth road, your wheels may need to be rebalanced.

### ***Wheel Replacement***

Replace any wheel that is bent, cracked or badly rusted. If wheel nuts keep coming loose, the wheel, wheel bolts, and wheel nuts should be replaced. If the wheel leaks air out, replace it (except some aluminum wheels, which can be repaired). See your GM truck dealer if any of these conditions exist. Your dealer will know what kind of wheel you need.

Each new wheel should have the same load carrying capacity, diameter, width, offset, and be mounted the same way as the one it replaces.

If you need to replace any of your wheels, wheel bolts, or wheel nuts, replace them only with **new** GM original equipment parts. This way, you will be sure you have the right wheel, wheel bolts, and wheel nuts for your vehicle.

## ***Service & Appearance Care***

### **CAUTION**



Using the wrong replacement wheels, wheel bolts or wheel nuts on your vehicle can be dangerous. It could affect the braking and handling of your vehicle, make your tires lose air and make you lose control. You could have an collision in which you or others could be injured. Always use the correct wheel, wheel bolts, and wheel nuts for replacement.

### **NOTICE**

The wrong wheel can also cause problems with bearing life, brake cooling, speedometer/odometer calibration, headlight aim, bumper height, vehicle ground clearance, and tire or tire chain clearance to the body and chassis.

### ***Used Replacement Wheels***

### **CAUTION**



Putting a used wheel on your vehicle is dangerous. You can't know how it's been used or how many miles it's been driven. It could fail suddenly and cause an accident. If you have to replace a wheel, use a **new** GM original equipment wheel.

### ***Tire Chains***

### **NOTICE**

If your vehicle has LT265/75R16 size tires, don't use tire chains; they can damage your vehicle.

If you have a tire size other than LT265/75R16, use tire chains only when you must. Use only SAE Class "S" type chains that are the proper size for your tires. Install them on the tires of the rear axle. Tighten them as tightly as possible with the ends securely fastened. Drive slowly and follow the chain manufacturer's instructions. If you can hear the chains contacting your vehicle, stop and retighten them. If the contact continues, slow down until it stops. Driving too fast with chains on will damage your vehicle.

---

---

## Appearance Care

### CAUTION



Cleaning products can be hazardous. Some are toxic. Others can burst into flame if you strike a match or get them on a hot part of the vehicle. Some are dangerous if you breathe their fumes in a closed space. When you use anything in a container to clean your vehicle, be sure to follow the instructions. And always open your doors or windows when you're cleaning the inside.

**Never** use these to clean your vehicle:

- Gasoline
- Benzene
- Naphtha
- Carbon Tetrachloride
- Acetone
- Paint Thinner
- Turpentine
- Lacquer Thinner
- Nail Polish Remover

They can all be hazardous—some more than others—and they can all damage your vehicle, too.

### NOTICE

Don't use any of these unless this manual says you can. In many uses, they will damage your vehicle:

- Laundry Soap
- Bleach
- Reducing Agents

## ***Service & Appearance Care***

---

### ***Cleaning the Inside of Your Vehicle***

Use a vacuum cleaner often to get rid of dust and loose dirt. Wipe vinyl with a clean, damp cloth.

Your GM dealer has two GM cleaners—a solvent-type spot lifter and a foam-type powdered cleaner. They will clean normal spots and stains very well.

Here are some cleaning tips:

- Always read the instructions on the cleaner label.
- Clean up stains as soon as you can—before they set.
- Use a clean cloth or sponge, and change to a clean area often. A soft brush may be used if stains are stubborn.
- Use solvent-type cleaners in a well ventilated area only. If you use them, don't saturate the stained area.
- If a ring forms after spot cleaning, clean the entire area immediately or it will set.

### ***Using Foam-Type Cleaner on Fabric***

- Vacuum and brush the area to remove any loose dirt.
- Always clean a whole trim panel or section. Mask surrounding trim along stitch or welt lines.
- Mix Multi-Purpose Powdered Cleaner following the directions on the container label.
- Use suds only and apply with a clean sponge.
- Don't saturate the material.
- Don't rub it roughly.
- As soon as you've cleaned the section, use a sponge to remove the suds.
- Rinse the section with a clean, wet sponge.
- Wipe off what's left with a slightly damp paper towel or cloth.
- Then dry it immediately with an air hose, a hair dryer or a heat lamp.

### **NOTICE**

Be careful with a hair dryer or heat lamp. You could scorch the fabric.

- Wipe with a clean cloth.

---

### ***Using Solvent-Type Cleaner on Fabric***

First, see if you have to use solvent-type cleaner at all. Some spots and stains will clean off better with just water and mild soap.

If you need to use it, then:

- Gently scrape excess soil from the trim material with a clean, dull knife or scraper. Use very little cleaner, light pressure and clean cloths (preferably cheesecloth). Cleaning should start at the outside of the stain, "feathering" toward the center. Keep changing to a clean section of the cloth.
- When you clean a stain from fabric, immediately dry the area with an air hose, hair dryer, or heat lamp to help prevent a cleaning ring. (See previous NOTICE.)

### ***Fabric Protection***

Your vehicle has upholstery that has been treated with Scotchgard™ Fabric Protector, a 3M product. Scotchgard™ protects fabrics by repelling oil and water, which are the carriers of most stains. Even with this protection, you still need to clean your upholstery often to keep it looking new.

Further information on cleaning is available by calling 1-800-433-3296 (in Minnesota, 1-800-642-6167).

### ***Special Cleaning Problems***

**Greasy or Oily Stains:** Like grease, oil, butter, margarine, shoe polish, coffee with cream, chewing gum, cosmetic creams, vegetable oils, wax crayon, tar and asphalt.

- Carefully scrape off excess stain.
- Then follow the solvent-type instructions above.
- Shoe polish, wax crayon, tar and asphalt will stain if left on a vehicle seat fabric. They should be removed as soon as possible. Be careful, because the cleaner will dissolve them and may cause them to bleed.

**Non-Greasy Stains:** Like catsup, coffee (black), egg, fruit, fruit juice, milk, soft drinks, wine, vomit, urine and blood.

- Carefully scrape off excess stain, then sponge the place with cool water.
- If a stain remains, follow the foam-type instructions above.
- If an odor lingers after cleaning vomit or urine, treat the area with a water/baking soda solution: 1 teaspoon (5 ml) of baking soda to 1 cup (250 ml) of lukewarm water.
- Finally, if needed, clean lightly with solvent-type cleaner.

## ***Service & Appearance Care***

---

**Combination Stains:** Like candy, ice cream, mayonnaise, chili sauce and unknown stains.

- Carefully scrape off excess stain, then clean with cool water and allow to dry.
- If a stain remains, clean it with solvent-type cleaner.

### ***Cleaning Vinyl or Leather***

Just use warm water and a clean cloth.

- Rub with a clean, damp cloth to remove dirt. You may have to do it more than once.
- Things like tar, asphalt and shoe polish will stain if you don't get them off quickly. Use a clean cloth and solvent-type vinyl/leather cleaner.

### ***Cleaning the Top of the Instrument Panel***

Use only mild soap and water to clean the top surfaces of the instrument panel. Sprays containing silicones or waxes may cause annoying reflections in the windshield and even make it difficult to see through the windshield under certain conditions.

### ***Care of Safety Belts***

Keep belts clean and dry.

## **CAUTION**



Do not bleach or dye safety belts. If you do, it may severely weaken them. In a crash they might not be able to provide adequate protection. Clean safety belts only with mild soap and lukewarm water.

### ***Glass***

Glass should be cleaned often. GM Glass Cleaner (GM Part No. 1050427) or a liquid household glass cleaner will remove normal tobacco smoke and dust films.

Don't use abrasive cleaners on glass, because they may cause scratches. Avoid placing decals on the inside rear window, since they may have to be scraped off later. If abrasive cleaners are used on the inside of the rear window, an electric defogger element may be damaged. Any temporary license should not be attached across the defogger grid.

---

---

### ***Cleaning the Outside of the Windshield and Wiper Blades***

If the windshield is not clear after using the windshield washer, or if the wiper blade chatters when running, wax or other material may be on the blade or windshield.

Clean the outside windshield with GM Windshield Cleaner, Bon-Ami Powder™ (GM Part No. 1050011). The windshield is clean if beads do not form when you rinse it with water.

Clean the blade by wiping vigorously with a cloth soaked in full strength washer solvent. Then rinse the blade with water.

Wiper blades should be checked on a regular basis and replaced when worn.

### ***Cleaning the Outside of Your Vehicle***

The paint finish on your vehicle provides beauty, depth of color, gloss retention and durability.

#### ***Washing Your Vehicle***

The best way to preserve your vehicle's finish is to keep it clean by washing it often with lukewarm or cold water.

Don't wash your vehicle in the direct rays of the sun. Don't use strong soaps or chemical detergents. Use liquid hand, dish or car washing (non-detergent) soaps. Don't use cleaning agents that contain acid or abrasives. All cleaning agents should be flushed promptly and not allowed to dry on the surface, or they could stain. Dry the finish with a soft, clean chamois or a 100% cotton towel to avoid surface scratches and water spotting.

High pressure vehicle washes may cause water to enter your vehicle.

#### ***Finish Care***

Occasional waxing or mild polishing of your vehicle may be necessary to remove residue from the paint finish. You can get GM approved cleaning products from your dealer. (See "Appearance Care and Materials" in the Index.)

Your vehicle has a "basecoat/clearcoat" paint finish. The clearcoat gives more depth and gloss to the colored basecoat.

### **NOTICE**

Machine compounding or aggressive polishing on a basecoat/clearcoat paint finish may dull the finish or leave swirl marks.

## ***Service & Appearance Care***

---

### ***Protecting Exterior Bright Metal Parts***

Bright metal parts should be cleaned regularly to keep their luster. Washing with water is all that is usually needed. However, you may use GM Chrome Polish on chrome or stainless steel trim, if necessary.

Use special care with aluminum trim. To avoid damaging protective trim, never use auto or chrome polish, steam or caustic soap to clean aluminum. A coating of wax, rubbed to a high polish, is recommended for all bright metal parts.

### ***Aluminum Wheels (If So Equipped)***

Your aluminum wheels have a protective coating similar to the painted surface of your vehicle. Don't use strong soaps, chemicals, chrome polish, or other abrasive cleaners on them because you could damage this coating. After rinsing thoroughly, a wax may be applied.

## **NOTICE**

If you have aluminum wheels, don't use an automatic vehicle wash that has hard silicon carbide cleaning brushes. These brushes can take off the protective coating.

### ***White Sidewall Tires***

Your General Motors dealer has a GM White Sidewall Tire Cleaner. You can use a stiff brush with it.

### ***Weatherstrips***

These are places where glass or metal meets rubber. Silicone grease there will make them last longer, seal better, and not stick or squeak. Apply silicone grease with a clean cloth at least every six months.

### ***Sheet Metal Damage***

If your vehicle is damaged and requires sheet metal repair or replacement, make sure the body repair shop applies anti-corrosion material to the parts repaired or replaced to restore corrosion protection.

### ***Foreign Material***

Calcium chloride and other salts, ice melting agents, road oil and tar, tree sap, bird droppings, chemicals from industrial chimneys, and other foreign matter can damage your vehicle's finish if they remain on painted surfaces. Use cleaners that are marked safe for painted surfaces for these stains.

### ***Finish Damage***

Any stone chips, fractures or deep scratches in the finish should be repaired right away. Bare metal will corrode quickly and may develop into a major repair expense.



---

Minor chips and scratches can be repaired with touch-up materials available from your dealer or other service outlets. Larger areas of finish damage can be corrected in your dealer's body and paint shop.

### ***Underbody Maintenance***

Chemicals used for ice and snow removal and dust control can collect on the underbody. If these are not removed, accelerated corrosion (rust) can occur on the underbody parts such as fuel lines, frame, floor pan, and exhaust system even though they have corrosion protection.

At least every spring, flush these materials from the underbody with plain water. Clean any areas where mud and other debris can collect. Dirt packed in closed areas of the frame should be loosened before being flushed. Your dealer or an underbody washing system can do this for you.

### ***Chemical Paint Spotting***

Some weather and atmospheric conditions can create a chemical fallout. Airborne pollutants fall upon and attack painted surfaces on your vehicle. This damage can take two forms: blotchy, ringlet-shaped discolorations, and small irregular dark spots etched into the paint surface.

Although no defect in the paint job causes this, General Motors will repair, at no charge to the owner, the surfaces of new vehicles damaged by this fallout condition within 12 months or 12,000 miles (20 000 km) of purchase, whichever comes first.

## ***Service & Appearance Care***

---

### ***Appearance Care Materials***

<b>PART NUMBER</b>	<b>SIZE</b>	<b>DESCRIPTION</b>	<b>USAGE</b>
1050172	16 oz. (0.473L)	Tar and Road Oil Remover	Removes old waxes, polishes, tar and road oil
1050173	16 oz. (0.473L)	Chrome Cleaner and Polish	Removes rust and corrosion on chrome and stainless steel
1050174	16 oz. (0.473L)	White Sidewall Tire Cleaner	Cleans white and black tires
1050214	32 oz. (0.946L)	Vinyl/Leather Cleaner	Spot and stain removal on leather or vinyl
1050244	16 oz. (0.473L)	Fabric Cleaner	Spot and stain removal on cloth and fabric
1050427	23 oz. (0.680L)	Glass Cleaner	Glass cleaning and spot cleaning on vinyls
1050429	6 lbs. (2.72 kg)	Multi-Purpose Powder Cleaner	Cleans vinyl and cloth on door trim, seats, and carpet—also tires and mats
1050729	8 oz. (0.237L)	Vinyl Top Cleaner	Cleaning of vinyl tops
1051055	16 oz. (0.473L)	Preservatone	Vinyl top dressing
1051398	8 oz. (0.237L)	Spot Lifter	Spot and stain removal on cloth and fabric
1052870	16 oz. (0.473L)	Wash-Wax (conc.)	Exterior wash
1050201	16 oz. (0.473L)	Magic Mirror Cleaner-Polish	Exterior cleaner and polish

T0077

---

## **Vehicle Identification Number (VIN)**

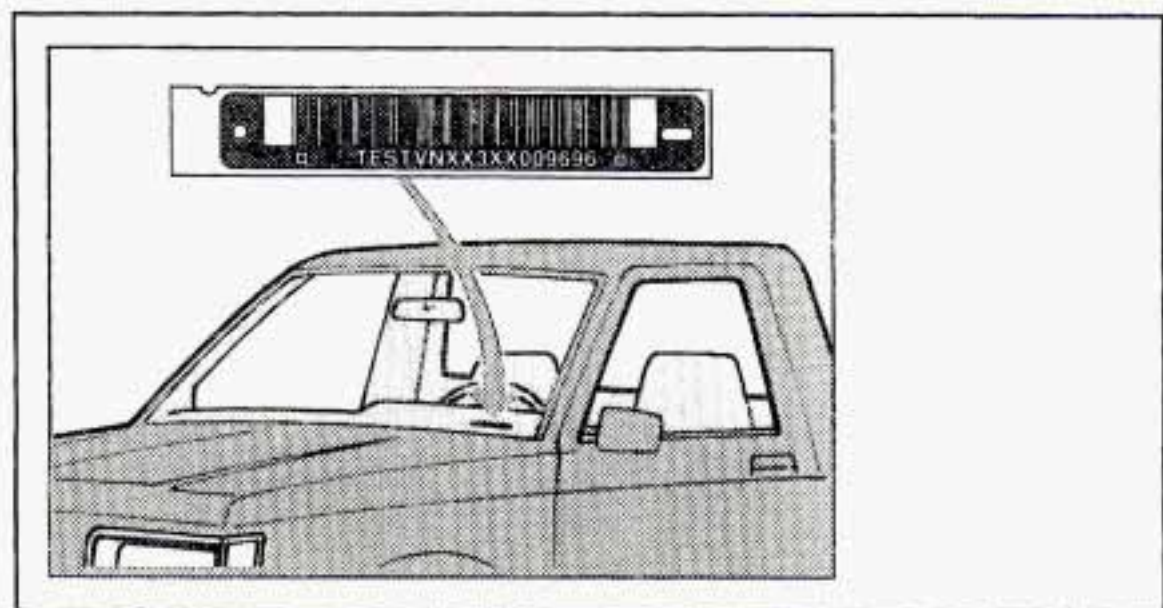

K0541

This is the legal identifier for your vehicle. It appears on a plate in the front corner of the instrument panel, on the driver's side. You can see it if you look through the windshield from outside your vehicle. The VIN also appears on the Vehicle Certification and Service Parts labels and the certificates of title and registration.

### **Engine Identification**

The eighth character in your VIN is the engine code for your GM engine. This code will help you identify your engine, specifications, and replacement parts in this section.

# Service & Appearance Care

## VEHICLE IDENTIFICATION NUMBER (VIN)

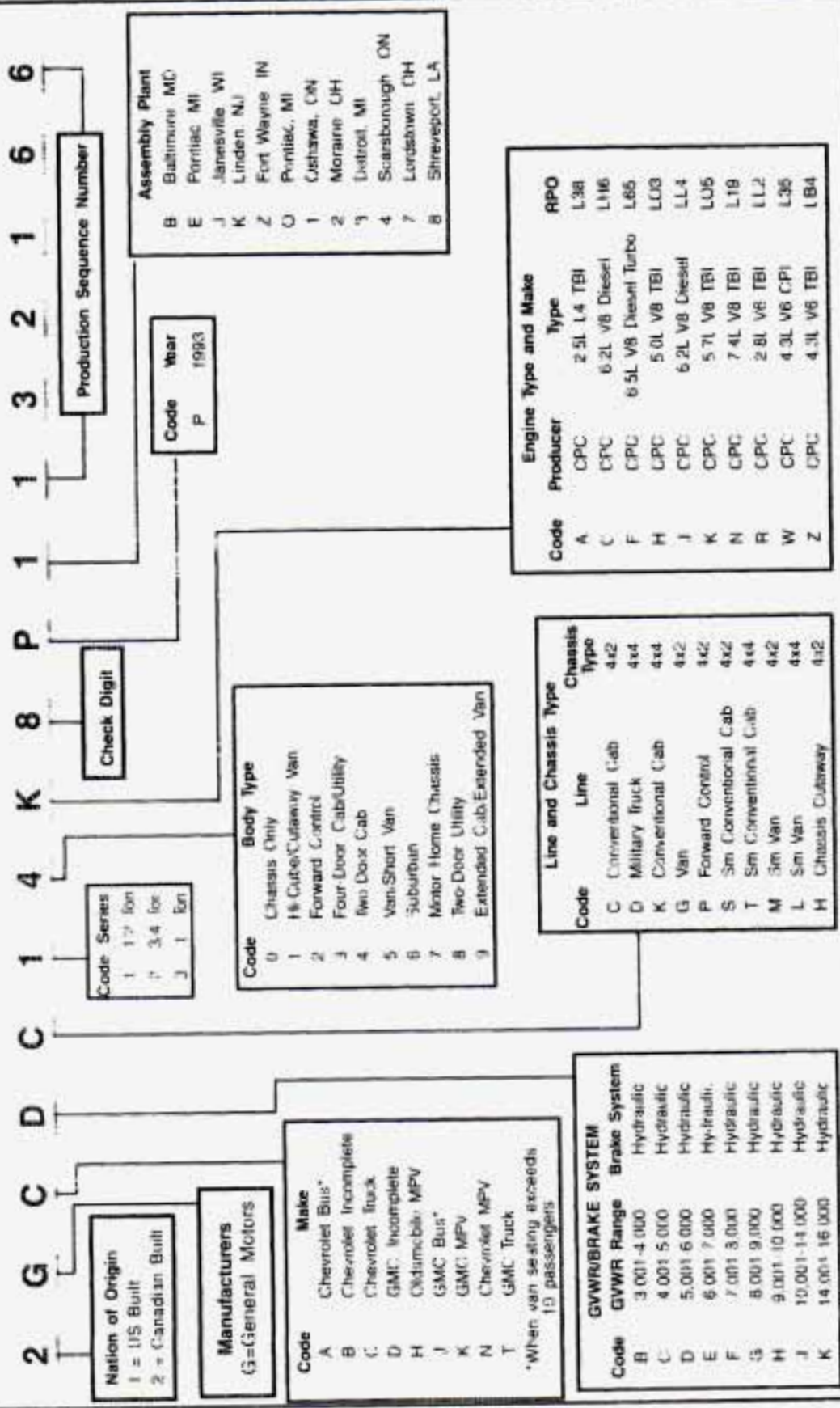

## Service Parts Identification Label

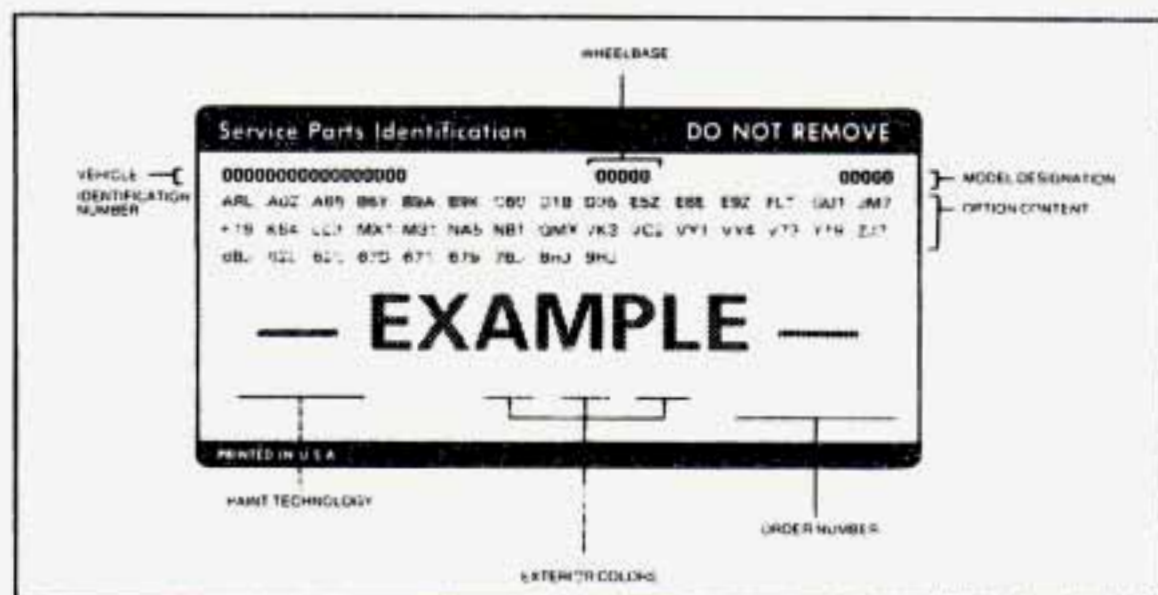

K2580

You'll find this label on the inside of the glove box. It's very helpful if you ever need to order parts. On this label is:

- Your VIN.
- Its model designation.
- Paint information.
- A list of all production options and special equipment.

Be sure that this label is not removed from the vehicle.

### **Add-On Electrical Equipment**

#### **NOTICE**

Don't add anything electrical to your vehicle unless you check with your dealer first. Some electrical equipment can damage your vehicle and the damage wouldn't be covered by your warranty. Some of it can just keep other things from working as they should.

# Service & Appearance Care

## Specification Charts

### Replacement Parts

Replacement part numbers listed in this section are based on the latest information available at the time of printing, and are subject to change. If a part listed in this manual is not the same as the part used in your vehicle when it was built, or if you have any questions, please contact your GM truck dealer.

### Engine Identification

Liter Displacement	Type	VIN Engine Code	Fuel System	Produced By	Emissions
5.7	V8	K	TBI	U.S., Can.	*
7.4	V8	N	TBI	U.S.	*

\*Light Duty Emissions with 8500 GVWR and below or:  
Heavy Duty Emissions with 8501 GVWR and above.

T0291

### Wheel Nut Torque

MODEL	DESCRIPTION	TORQUE
C 1500	5 bolts (14mm)	120 ft. lbs. (160 N-m)
K 1500, C-K 2500	6 bolts (14mm)	120 ft. lbs. (160 N-m)
C-K 2500	8 bolts (14mm)	120 ft. lbs. (160 N-m)

T0295

### Cooling System Capacity

ENGINE	VIN CODE	QUANTITY*	
		Without A/C	With A/C
5.7L	K	17.5 Quarts (16.5 Liters)	18 Quarts (17 Liters)
7.4L	N	23 Quarts (22 Liters)	25 Quarts (23.5 Liters)

\*All quantities are approximate.  
\*After refill, the level MUST be checked as outlined under "Engine Cooling System" in Section 5.

T0292

### ***Crankcase Capacity***

ENGINE	VIN CODE	QUANTITY*	
		Without Filter	With Filter
5.7L	K	4 Quarts (3.8 Liters)	5 Quarts (4.8 Liters)
7.4L	N	6 Quarts (5.7 Liters)	7 Quarts (6.6 Liters)

\*All quantities are approximate.

\*After refill, the level MUST be checked as outlined under "Engine Oil And Filter Recommendations" in Section 5.

T0296

### ***Air Conditioning Refrigerant Capacity***

TYPE*	QUANTITY
Refrigerant R-12	Front A/C 3.0 lbs. (1.360 kg) Front and Rear A/C 4.25 lbs. (1.927 kg)

\*Not all air conditioning refrigerants are the same. If the air conditioning system in your vehicle needs refrigerant, be sure the proper refrigerant is used. If you're not sure, ask your GM dealer.

T0302

### ***Fuel Tank Capacity***

TYPE	QUANTITY
Utility Model—Standard	30 Gallons (113 Liters)
Wagon Model—Standard	42 Gallons (159 Liters)

All quantities are for a completely dry tank and are approximate.

T0297

### ***Service Replacement Part and Filter Recommendations***

Engine (VIN)	Oil Filter	Air Cleaner	PCV Valve	Spark** Plugs	Fuel Filter	Radiator Cap
4.3 (Z)	PF51	A178CW	CV789C	.CR43TS	GF481	RC36
5.0 (H)	PF35†	A348C	CV774C	.CR43TS	GF481	RC36
5.7 (K)	PF35†	A348C	CV774C	.CR43TS	GF481	RC36
6.2 (C)	PF35	A644C	-	-	TP1006	RC32
6.2 (J)*	PF35	A644C	-	-	TP1006	RC32
6.5 (F)*	PF35	A917C	-	-	TP1006	RC32
7.4 (N)	PF35	A348C	CV774C	.CR43TS	GF481	RC36

†Four Wheel Drive Vehicles use a PF51 oil filter

\*Heavy Duty Emission Engine

\*\*Use AC copper-cored resistor type spark plugs.

T0039

# Service & Appearance Care

## Fuses and Circuit Breakers

Name	Circuits Protected	Fuse	Circuit Breaker
Gages	Cruise Control, 4 WD Display Illum. Rear Window Defogger Timer, Aux. Batt. Relay Feed, Safety Belt Buzzer Timer, Cluster Ign. Feed	20 Amp	
Turn-B/U	Back-up Lamps, Turn Signals	15 Amp	
EMC/Ign	T.C.C., Air Diverter, E.S.C., E.G.R., E.C.M. Ign., R.W.A.L. Brake Switch	10 Amp	
Inj. A	Throttle Body Injectors	10 Amp	
Brake	A.B.S., Cluster-Speedo	15 Amp	
AC/Htr	H.V.A.C. 4 WD, Aux. Batt. Relay	25 Amp	
Ctsy	Dome Lamp, Ctsy. and Glove Box Lps. (TR-9), Radio (Memory-Clock)	20 Amp	
Park LP	Horn Relay, Horn Feed, Park Lamps	20 Amp	
P. Lps	C49 SW Illum., Headlamp "On" Warning, Radio Illum., H.V.A.C. Illum.	5 Amp	
Stop/Haz.	Haz. Flasher, Seat Belt Buzzer, Stop Lmps., A.B.S. Memory	15 Amp	
Wiper	Windshield Wiper, Washer	25 Amp	
Radio	Radio Feed	10 Amp	
Acc/Ign.	Pwr. Windows		30 Amp
Acc/Batt.	Door Locks, Rear Window Defogger		30 Amp
Crank	Crank, Discreet	5 Amp	
4WD	Four Wheel Drive	25 Amp	
DRL	Daytime Running Lights	15 Amp	
RR Wpr	Rear Window Wiper/Washer	25 Amp	
T/G Rel	Cigar Lighter, Rear Hatch Release	25 Amp	

\*An inline fuse is used for the underhood lamp

**Do not use fuses of higher amperage than those recommended above.**

T0294



FUSE LEGEND	
5 AMP	TAN
7.5 AMP	BROWN
10 AMP	RED
15 AMP	BLUE
20 AMP	YELLOW
25 AMP	CLEAR
30 AMP	GREEN

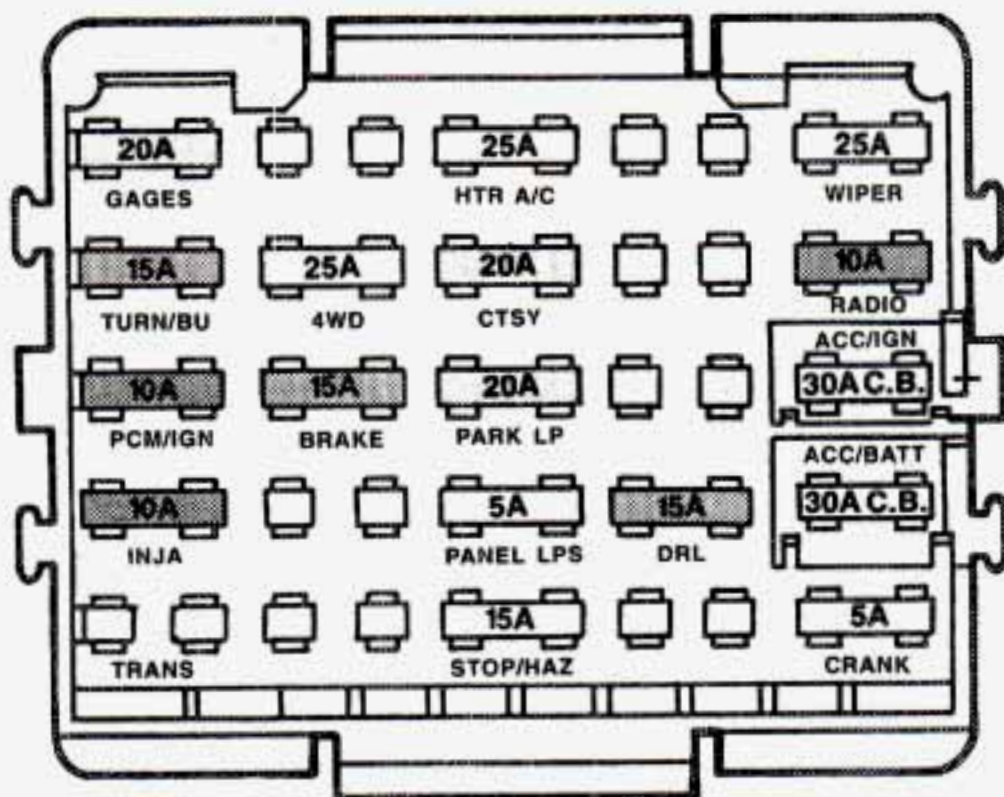

# Service & Appearance Care

## Light Bulb Data

Lamp or Bulb	Trade No.	Power Rating at 12.8V, Watts	Quantity
<b>Exterior Lights:</b>			
Headlamps: 2 Headlamp System Halogen (Opt.)	6052	55/65	2
	H6054	35/65	2
Headlamps: 4 Headlamp System (Composite)	9005	65	2
	9006	55	2
<b>Candle Power</b>			
Front Marker Lamp	194	2	2
Front Park and Turn Lamp	2357NA	30/2	4
Rear Parking Lamp	3057	32-2	2
Rear Stop and Turn Lamp	3057	32-2	2
Backup Lamp	3156	32	2
Roof Marker Lamp*	194	2	5
License Plate Lamp	194	2	2
Underhood Lamp	93	15	1
Reel Lamp	232	10	1
<b>Interior Lights:</b>			
Dome Lamps	211-2	12	2
Reading Lamps	211-2	12	4
Roof Console Lamps	168	3	2
Courtesy Lamp	1003	15	2
Heater or A/C Control Lamp	194	2	1
Four Wheel Drive Indicator	161	1	1
Four Wheel Drive Shift Lever	194	1	1
Instrument Panel Compartment Lamp	194	2	1
Ashtray Lamp	194	2	1
Sunshade Vanity Mirror	74	0.7	4
<b>Instrument Panel Lights</b>			
Transmission Indicator (PRNDL)	161	1	1
Daytime Running Lights Indicator†	74	.7	1
Charging System Indicator Lamp	74	.7	1
Instrument Cluster Gage	194	.2	4
Illuminating Lamps W. Tach	194	.2	6
Headlamp Beam Indicator	74	.7	1
Directional Signal Indicator	74	.7	2
Brake Warning Indicator	74	.7	1
Safety Belt Warning	74	.7	1
Check Gages Indicator	74	.7	1
Malfunction Indicator ("Service Engine Soon")	74	.7	1
Upshift Indicator	74	.7	1

\*Suburban only †Canadian Vehicles only

T0293

# Scheduled Maintenance Services



## Section

# 7

This section covers the maintenance required for your General Motors vehicle. Your vehicle needs these services to retain its safety, dependability, and emission control performance.

A Word About Maintenance .....	7-3
Your Vehicle and the Environment .....	7-3
Recording Maintenance Services .....	7-3
Scheduled Maintenance Services .....	7-4
Selecting The Proper Maintenance Services .....	7-4
Gasoline Engines with Light Duty Emissions—	
Maintenance Schedule I .....	7-6
Gasoline Engines with Light Duty Emissions—	
Maintenance Schedule II .....	7-8
Gasoline Engines with Heavy Duty Emissions—	
Maintenance Schedule I .....	7-10
Gasoline Engines with Heavy Duty Emissions—	
Maintenance Schedule II .....	7-12
6.2L and 6.5L Diesel Engines—	
Maintenance Schedule I .....	7-14
6.2L and 6.5L Diesel Engines—	
Maintenance Schedule II .....	7-16

# ***Scheduled Maintenance Services***

---

Explanation of Scheduled Maintenance Services.....	7-18
Owner Checks and Services.....	7-22
Recommended Fluids & Lubricants.....	7-25
Maintenance Record .....	7-27
Service Station Checks.....	7-28

---

---

## ***A Word About Maintenance***

We at General Motors want to help you keep your vehicle in good working condition. But we don't know exactly how you'll drive it. You may drive very short distances only a few times a week. Or you may drive long distances all the time in very hot, dusty weather. You may use your vehicle in making deliveries. Or you may drive it to work, to do errands, or in many other ways.

Because of all the different ways people use their GM vehicles, maintenance needs vary. You may even need more frequent checks and replacements than you will find in the schedules in this section. So please read this section and note how you drive. If you have any questions on how to keep your vehicle in good condition, see your GM dealer, the place many GM owners choose to have their maintenance work done. Your dealer can be relied upon to use proper parts and practices.

## ***Your Vehicle and the Environment***

Proper vehicle maintenance not only helps keep your vehicle in good working condition, but also helps the environment. All recommended maintenance procedures are important. Improper vehicle maintenance or the removal of important components can significantly affect the quality of the air we breathe. Improper fluid levels or even the wrong tire inflation can increase the level of emissions from your vehicle. To help protect our environment, and to help keep your vehicle in good condition, please maintain your vehicle properly.

## ***Recording Maintenance Services***

The Maintenance Record near the end of this section provides a place for you to record the maintenance performed on your vehicle. Whenever any maintenance is performed, be sure to write it down in the Maintenance Record. This will help you determine when your next maintenance should be done. In addition, it is a good idea to keep your maintenance receipts. They may be needed to qualify your vehicle for warranty repairs.

### **CAUTION**



Performing maintenance work on a vehicle can be dangerous. In trying to do some jobs, you can be seriously injured. Do your own maintenance work only if you have the required know-how and the proper tools and equipment for the job. If you have any doubt, have a qualified technician do the work.

If you are skilled enough to do some work on your vehicle, you will probably want to get the service information GM publishes. For information on how to obtain various service publications for your vehicle, see "Service Publications" in the Index. You will find a list of publications and an order form in the back of the book.

# **Scheduled Maintenance Services**

## ***Scheduled Maintenance Services***

This part tells you the maintenance services that you should have done and the times you should schedule them. Your GM dealer knows your vehicle best and wants you to be happy with it. If you go to your dealer for your service needs, you'll know that GM-trained and supported service people will perform the work using genuine GM parts.

These schedules are for vehicles that:

- carry passengers and cargo within the recommended limits. You will find these limits on your vehicle's Certification Label. See "Loading Your Vehicle" in the Index.
- are driven on regular road surfaces, and within legal driving limits.
- are driven off-road in the recommended manner. See the Index Under "Off Road Driving With Your Four Wheel Drive Vehicle."
- use the recommended fuel. See "Fuel" in the Index.

## ***Selecting The Proper Maintenance Services***

To find the proper maintenance schedule for your vehicle, you must know two things. What engine your vehicle has, and how you use your vehicle. Your engine type will tell you which chart to use, and your driving conditions will tell you which schedule to use. The charts are found later in this section.

### ***Selecting the Proper Maintenance Chart***

Your engine type (Gasoline or Diesel) and its emissions classification (Light Duty or Heavy Duty Emissions) will tell you which maintenance chart to use. Find your Vehicle Identification Number (VIN), and look at the eighth character to see what your engine code is. Then use the following Engine Emissions Classifications table to find your emissions classification.

- Your VIN is on the plate on the top left corner of your instrument panel, the Certification Label and on the Service Parts Identification Label. See "Vehicle Identification Number" in the Index.
- If your engine has more than one emissions classification, look at your Certification Label to see what your Gross Vehicle Weight Rating (GVWR) is. See "Loading Your Vehicle" in the Index.

**ENGINE EMISSIONS CLASSIFICATION**

VIN Code	Engine Description	Emissions
Z	4.3L V6/TBI with 8500 GVWR and below	LD
	with 8501 GVWR and above	HD
H	5.0L V8/TBI	LD
K	5.7L V8/TBI with 8500 GVWR and below	LD
	with 8501 GVWR and above	HD
C	6.2L V8/Diesel	LD
J	6.2L V8/Diesel	HD
F	6.5L V8/Diesel	HD
N	7.4L V8/TBI Except 454 SS Model	HD
	with 454 SS Model	LD

T0268

NOTE: TBI is a throttle body injection system.

**Selecting the Proper Maintenance Schedule**

Here is how to tell which schedule to follow once you find the proper maintenance chart to use.

**MAINTENANCE SCHEDULE I**

Is any one of these true for your vehicle?

- Most trips are less than 4 miles (6 kilometers).
- Most trips are less than 10 miles (16 kilometers), and the outside temperatures are below freezing.
- The engine is at low speed most of the time (as in door-to-door delivery, stop-and-go traffic, or commercial use).
- You operate in dusty areas or off-road frequently.
- You tow a trailer

If any one (or more) of these is true for your driving, follow Schedule I. Schedule I is shown by a plus sign (+) on the chart.

**MAINTENANCE SCHEDULE II**

Follow Schedule II ONLY if none of the above conditions are true. Schedule II is shown by a dot (•) on the chart.

# Scheduled Maintenance Services

## GASOLINE ENGINES WITH LIGHT DUTY EMISSIONS—

Item No.	Service	If your driving conditions meet those specified in "Scheduled Maintenance Services" in this section, use Maintenance Schedule I (+).							
		Miles (000)	3	6	7.5	9	12	15	18
		Kilometers (000)	5	10	12.5	15	20	25	30
1	Engine Oil Change*—Every 3 Months, or		+	+		+	+	+	+
	Oil Filter Change*—Every 3 Months, or		+	+		+	+	+	+
2	Chassis Lubrication—Every 12 Months, or		+	+		+	+	+	+
3	Clutch Fork Ball Stud Lubrication								
5	Cooling System Service*—Every 24 Months or								
6	Air Cleaner Filter Replacement*								
7	Front Wheel Bearing Repack							+	
8	Transmission Service**								
10	Fuel Filter Replacement*								
11	Spark Plugs Replacement*								
12	Spark Plug Wire Inspection*								
14	Electronic Vacuum Regulator Valve (EVRV) Inspection*								
15	Engine Timing Check*								
16	Fuel Tank, Cap and Lines Inspection*								
18	Engine Accessory Drive Belt(s) Inspection*								
24	Tire and Wheel Rotation**								
25	Drive Axle Service**								
26	Brake Systems Inspection**								

### FOOTNOTES:

\*An Emission Control Service

\*\*See "Explanation of Scheduled Maintenance Services" in this section.

†To determine the emissions classification of your engine refer to "Selecting the Proper Maintenance Chart" in this section.

T0337





# Scheduled Maintenance Services

## GASOLINE ENGINES WITH LIGHT DUTY EMISSIONS—

		If your driving conditions meet those specified in "Scheduled Maintenance Services" in this section, use Maintenance Schedule I (+).							
Item No.	Service	Miles (000)	3	6	7.5	9	12	15	18
		Kilometers (000)	5	10	12.5	15	20	25	30
1	Engine Oil Change*—Every 12 Months, or				•			•	
	Oil Filter Change*—Every 12 Months, or				•				
2	Chassis Lubrication—Every 12 Months, or				•			•	
3	Clutch Fork Ball Stud Lubrication								
5	Cooling System Service*—Every 24 Months or								
6	Air Cleaner Filter Replacement*								
7	Front Wheel Bearing Repack								
8	Transmission Service**								
10	Fuel Filter Replacement*								
11	Spark Plugs Replacement*								
12	Spark Plug Wire Inspection*								
14	Electronic Vacuum Regulator Valve (EVRV) Inspection*								
15	Engine Timing Check*								
16	Fuel Tank, Cap and Lines Inspection*								
18	Engine Accessory Drive Belt(s) Inspection*								
24	Tire and Wheel Rotation**								
25	Drive Axle Service**								
26	Brake Systems Inspection**								

### FOOTNOTES:

\*An Emission Control Service

\*\*See "Explanation of Scheduled Maintenance Services" in this section.

†To determine the emissions classification of your engine refer to "Selecting the Proper Maintenance Chart" in this section.

T0332



# Scheduled Maintenance Services

## GASOLINE ENGINES WITH HEAVY DUTY EMISSIONS—

Item No.	Service	If your driving conditions meet those specified in "Scheduled Maintenance Services" in this section, use Maintenance Schedule I (+).					
		Miles (000)		3	6	9	12
		Kilometers (000)		5	10	15	20
1	Engine Oil Change*—Every 3 Months, or			+	+	+	+
	Oil Filter Change*—Every 3 Months, or			+	+	+	+
2	Chassis Lubrication—Every 12 Months, or			+	+	+	+
3	Clutch Fork Ball Stud Lubrication						
5	Cooling System Service*—Every 24 Months or						
6	Air Cleaner Filter Replacement▲*						
7	Front Wheel Bearing Repack						+
8	Transmission Service**						
10	Fuel Filter Replacement*						+
11	Spark Plugs Replacement*						
12	Spark Plug Wire Inspection*						
13	EGR System Inspection*						
14	Electronic Vacuum Regulator Valve (EVRV) Inspection*						
15	Engine Timing Check▲*						
16	Fuel Tank, Cap and Lines Inspection*						
17	Thermostatically Controlled Air Cleaner Inspection▲*						
18	Engine Accessory Drive Belt(s) Inspection*						+
19	Evaporative Control System Inspection*						
20	Shields and Underhood Insulation Inspection▲■						+
21	Air Intake System Inspection▲■						
22	Thermostatically Controlled Engine Cooling Fan Check ▲■— Every 12 Months or						+
24	Tire and Wheel Rotation**						
25	Drive Axle Service**						
26	Brake Systems Inspection**						

### FOOTNOTES:

\* An Emission Control Service

\*\*See "Explanation of Scheduled Maintenance Services" in this section.

▲ Also a Noise Emission Control Service

■ Applicable only to vehicles sold in the United States

† To determine the emissions classification of your engine refer to "Selecting the Proper Maintenance Chart" in this section.

T0339



# Scheduled Maintenance Services

## GASOLINE ENGINES WITH HEAVY DUTY EMISSIONS—

Item No.	If your driving conditions meet those specified in "Scheduled Maintenance Services" in this section, use Maintenance Schedule I (+).					
	Service	Miles (000)	3	6	9	12
		Kilometers (000)	5	10	15	20
1	Engine Oil Change*—Every 12 Months, or			*		*
	Oil Filter Change*—Every 12 Months, or			*		
2	Chassis Lubrication—Every 12 Months, or			*		*
3	Clutch Fork Ball Stud Lubrication					
5	Cooling System Service*—Every 24 Months or					
6	Air Cleaner Filter Replacement▲*					
7	Front Wheel Bearing Repack					
8	Transmission Service**					
10	Fuel Filter Replacement*					
11	Spark Plugs Replacement*					
12	Spark Plug Wire Inspection*					
13	EGR System Inspection*					
14	Electronic Vacuum Regulator Valve (EVRV) Inspection*					
15	Engine Timing Check▲*					
16	Fuel Tank, Cap and Lines Inspection*					
17	Thermostatically Controlled Air Cleaner Inspection▲*					
18	Engine Accessory Drive Belt(s) Inspection*					*
19	Evaporative Control System Inspection*					
20	Shields and Underhood Insulation Inspection▲■					*
21	Air Intake System Inspection▲■					
22	Thermostatically Controlled Engine Cooling Fan Check ▲■— Every 12 Months or					*
24	Tire and Wheel Rotation**					
25	Drive Axle Service**					
26	Brake Systems Inspection**					

FOOTNOTES:  
 \* An Emission Control Service  
 \*\*See "Explanation of Scheduled Maintenance Services" in this section.  
 ▲ Also a Noise Emission Control Service  
 ■ Applicable only to vehicles sold in the United States  
 † To determine the emissions classification of your engine refer to "Selecting the Proper Maintenance Chart" in this section.

T0334



# Scheduled Maintenance Services

## 6.2L AND 6.5L DIESEL ENGINES—

		If your driving conditions meet those specified in "Scheduled Maintenance Services" in this section, use Maintenance Schedule I (+).						
Item No.	Service	Miles (000)	2.5	5	7.5	10	12.5	15
		Kilometers (000)	4	8	12	16	20	24
1	Engine Oil Change*—Every 3 Months, or		+	+	+	+	+	+
	Oil Filter Change*—Every 3 Months, or		+	+	+	+	+	+
2	Chassis Lubrication—Every 12 Months, or		+	+	+	+	+	+
3	Clutch Fork Ball Stud Lubrication							
4	Engine Idle Speed Adjustment*			+				
5	Cooling System Service*—Every 24 Months or							
6	Air Cleaner Filter Replacement*★							
7	Front Wheel Bearing Repack							+
8	Transmission Service**							
9	CDRV System Inspection*							
10	Fuel Filter Replacement*							
13	EGR System Inspection*							
18	Drive Belt(s) Inspection							
20	Shields and Underhood Insulation Inspection■▲					+		
21	Air Intake System Inspection■▲					+		
22	Thermostatically Controlled Engine Cooling Fan Check■▲—Every 12 Months or					+		
23	Exhaust Pressure Regulator Valve Inspection*							
24	Tire and Wheel Rotation**							
25	Drive Axle Service**							
26	Brake Systems Inspection**							

### FOOTNOTES:

★ Change filter every 15,000 miles (24 000 km), except when operating in dusty conditions. Dusty conditions may require more frequent filter replacement. Extreme dust and dirt operating conditions (off-road), may require the air filter to be checked as often as every 300 miles (483 km) and replaced as necessary.

\* An Emission Control Service

\*\* See "Explanation of Scheduled Maintenance Services" in this section.

■ Applicable only to trucks sold in the United States.

▲ Also, a Noise Control Service (applicable to vehicles with engine VIN Code J).

† This maintenance schedule applies to all diesel engines available.

T0330



## MAINTENANCE SCHEDULE I†

If your driving conditions do NOT meet those specified in "Scheduled Maintenance Services" in this section, use Maintenance Schedule II (°).

17.5	20	22.5	25	27.5	30	32.5	35	37.5	40	42.5	45	47.5	50	52.5	55	57.5	60
28	32	36	40	44	48	52	56	60	64	68	72	76	80	84	88	92	96
+	+	+	+	+	+	+	+	+	+	+	+	+	+	+	+	+	+
+	+	+	+	+	+	+	+	+	+	+	+	+	+	+	+	+	+
+	+	+	+	+	+	+	+	+	+	+	+	+	+	+	+	+	+
					+												+
					+												+
					+												+
					+						+						+
					+												+
																	+
																	+
																	+
	+				+				+				+				+
	+				+				+				+				+
	+				+				+				+				+
																	+

THE SERVICES SHOWN ON THIS CHART UP TO 60,000 MILES (100 000 km) ARE TO BE DONE AFTER 60,000 MILES AT THE SAME INTERVALS.

T0341

# Scheduled Maintenance Services

## 6.2L AND 6.5L DIESEL ENGINES—

Item No.	If your driving conditions meet those specified in "Scheduled Maintenance Services" in this section, use Maintenance Schedule I (+).							
	Service	Miles (000)	2.5	5	7.5	10	12.5	15
		Kilometers (000)	4	8	12	16	20	24
1	Engine Oil Change*—Every 12 Months, or			•		•		•
	Oil Filter Change*—Every 12 Months, or			•		•		•
2	Chassis Lubrication—Every 12 Months, or			•		•		•
3	Clutch Fork Ball Stud Lubrication							
4	Engine Idle Speed Adjustment*			•				
5	Cooling System Service*—Every 24 Months or							
6	Air Cleaner Filter Replacement*							
7	Front Wheel Bearing Repack							
8	Transmission Service**							
9	CDRV System Inspection*							
10	Fuel Filter Replacement*							
13	EGR System Inspection*							
18	Drive Belt(s) Inspection							
20	Shields and Underhood Insulation Inspection■▲					•		
21	Air Intake System Inspection■▲					•		
22	Thermostatically Controlled Engine Cooling Fan Check■▲—Every 12 Months or					•		
23	Exhaust Pressure Regulator Valve Inspection*							
24	Tire and Wheel Rotation**							
25	Drive Axle Service**							
26	Brake Systems Inspection**							

### FOOTNOTES:

• An Emission Control Service

\*\* See "Explanation of Scheduled Maintenance Services" in this section.

■ Applicable only to trucks sold in the United States.

▲ Also, a Noise Control Service (applicable to vehicles with engine VIN Code J).

† This maintenance schedule applies to all diesel engines available.

T0331



# ***Scheduled Maintenance Services***

---

## ***Explanation Of Scheduled Maintenance Services***

Below are explanations of the services listed in the maintenance charts.

The proper fluids and lubricants to use are listed in this section. Make sure whoever services your vehicle uses these. All parts should be replaced and all necessary repairs done before you or anyone else drives the vehicle.

1. **ENGINE OIL AND OIL FILTER CHANGE\*** —ALWAYS USE SG OR SG/CE QUALITY, ENERGY CONSERVING II OILS OF THE PROPER VISCOSITY. To determine the preferred viscosity oil for your vehicle's engine (e.g. SAE 5W-30 or 10W-30), see "Engine Oil" in the Index.
2. **CHASSIS LUBRICATION** —Lubricate the front suspension, king pin bushings, steering linkage, transmission, and transfer case shift linkage, parking brake cable guides, propshaft splines (2 wheel drive), brake pedal springs, and clutch pedal springs at the intervals specified.

If you have a 3500 HD, lubricate the king pins and king pin bushings every 1,500 miles (2500 km) for Maintenance Schedule 1, or every 3,000 (5000 km) for Maintenance Schedule 2.

Ball joints and king pin bushings should not be lubricated unless their temperature is 10°F (-12°C), or higher. When the weather is cold, let them warm up before lubrication or they could be damaged.

Also, be sure to check all the vehicle fluid levels at this time.

3. **CLUTCH FORK BALL STUD LUBRICATION** —Lubricate the clutch fork ball stud through the fitting on the clutch housing. Lubricant must be added "sparingly" to the fitting, as only .0066 lb. (.003 kg) is required to lubricate the ball stud surface. Do not add lubricant more often than the intervals in the Maintenance Charts. **Too much lubricant will damage the clutch assembly.**
4. **ENGINE IDLE SPEED ADJUSTMENT (DIESEL ENGINES)\*** —Adjust to the specifications shown on the underhood label. You must use calibrated test equipment.
5. **COOLING SYSTEM SERVICE\*** —Drain, flush and refill system with new coolant. See "Engine Coolant" in the Index for the proper coolant and mixture to use in your vehicle.

Also inspect the hoses and replace them if they are cracked, swollen, or deteriorated. Tighten all hose clamps (except constant tension clamps). Remove debris and clean the outside of the radiator and air conditioning condenser. Wash the radiator neck. To ensure proper operation, pressure test the radiator and cap.

\* An Emission Control Service

- 
6. **AIR CLEANER FILTER REPLACEMENT\*** —Replace at every 30,000 miles (50 000 km) or more often under dusty conditions. Ask your dealer for the proper replacement intervals for your driving conditions.
  7. **FRONT WHEEL BEARING REPACK (2 WHEEL DRIVE ONLY)** —Clean and repack the front wheel bearings at each brake relining, or at the specified interval, whichever comes first.
  8. **TRANSMISSION SERVICE**

**Automatic Transmission** —Change the transmission fluid and filter every 15,000 miles (25 000 km) for vehicles under 8,600 GVWR or every 12,000 miles (20 000 km) for vehicles over 8,600 GVWR if the vehicle is mainly driven under one or more of these conditions:

- In heavy city traffic.
- Where the outside temperature regularly reaches 90°F (32°C) or higher.
- In hilly or mountainous terrain.
- Frequent trailer pulling.
- Uses such as taxi, police, delivery or other commercial service.

If the vehicle is not used mainly under any of these conditions, change the fluid and filter every 30,000 miles (50 000 km) for vehicles under 8600 GVWR or every 24,000 miles (40 000 km) for vehicles over 8600 GVWR. See "Automatic Transmission Fluid" in the Index for more information.

**Manual Transmission** —Transmission fluid does not require periodic changing.

9. **CDRV SYSTEM INSPECTION\*** —Check the Crankcase Depression Regulator Valve System for any worn, plugged or collapsed hoses. Have the system checked as described in the Service Manual.
10. **FUEL FILTER REPLACEMENT\*** —Replace the fuel filter at the specified interval or sooner if clogged.
11. **SPARK PLUGS REPLACEMENT\*** —Replace spark plugs with the type listed in Section 6. See "Specification Charts" in the Index.
12. **SPARK PLUG WIRE INSPECTION\*** —Clean wires and inspect for burns, cracks or other damage. Check the wire boot fit at the distributor and at the spark plugs. Replace wires as needed.

\*An Emission Control Service

## ***Scheduled Maintenance Services***

---

13. **EGR SYSTEM INSPECTION\*** —Conduct EGR SYSTEM CHECK as described in the Service Manual.
14. **ELECTRONIC VACUUM REGULATOR VALVE (EVRV) INSPECTION\*** —Inspect filter for excessive contamination or plugging. If required, clean element with a solution of biodegradable soap and water, let dry and reinstall element.
15. **ENGINE TIMING CHECK AND DISTRIBUTOR CHECK (SOME MODELS)\*** —Adjust timing to underhood label specifications. Inspect the inside and outside of the distributor cap and rotor for cracks, carbon tracking and corrosion. Clean or replace as needed.
16. **FUEL TANK, CAP AND LINES INSPECTION\*** —Inspect the fuel tank, cap and lines for damage or leaks. Remove fuel cap, inspect gasket for an even filler neck imprint, and any damage. Replace parts as needed.
17. **THERMOSTATICALLY CONTROLLED AIR CLEANER INSPECTION\***  
▲—(If so equipped.) Inspect all hoses and ducts for proper hookup. Make sure valve works properly.
18. **ENGINE ACCESSORY DRIVE BELT(S) INSPECTION\*** —Inspect belts. Look for cracks, fraying, wear, and proper tension. Adjust or replace as needed.
19. **EVAPORATIVE CONTROL SYSTEM (ECS) INSPECTION\*** —Check all fuel and vapor lines and hoses for proper hookup, routing, and condition. Check that the purge valve works properly, if equipped. Replace as needed.
20. **SHIELDS AND UNDERHOOD INSULATION INSPECTION ▲■**—Inspect shields and underhood insulation for damage or looseness. Adjust or replace as required.
21. **AIR INTAKE SYSTEM INSPECTION▲■**—Check the air intake system installation to see that gaskets are seated properly and all hose connections, fasteners, and other components are tight. Also check to be sure that the air cleaner housing is properly seated, that the cover fits tightly, and the wing nuts are tight. Tighten connections and fasteners or replace damaged parts as required.
22. **THERMOSTATICALLY CONTROLLED ENGINE COOLING FAN INSPECTION▲■**—(If so equipped.) With the engine off and below normal operating temperature, check to see that the fan can be rotated by hand on fluid coupling or viscous drives. Replace as necessary.

\*An Emission Control Service

▲ Also a Noise Emission Control Service

■ Applicable only to vehicles sold in the United States

- 
23. **EXHAUST PRESSURE REGULATOR VALVE INSPECTION\*** —Check that the valve works properly. Correct any binding. Inspect hoses for cracks, chafing or decay. Replace parts as needed.
24. **TIRE AND WHEEL ROTATION AND INSPECTION** —For proper wear and maximum tire life, rotate tires at the first 6,000 miles (10 000 kilometers) for Schedule I (+) or 7,500 miles (12 500 kilometers) for Schedule II (\*) and then every 15,000 miles (25 000 kilometers) thereafter. Follow the instructions and patterns shown in Section 6. Check tires for uneven wear or damage. If irregular or premature wear is apparent, check wheel alignment. Also, check for damaged wheels. See "Tires" in the Index for more information.

For dual wheels, whenever the vehicle, wheels, or fasteners are new, have the wheel fastener torque set at the first 100, 1,000 and 6,000 miles (160, 1600 and 10 000 km).

For 3500 H.D. Models, block the tires opposite those being removed to keep the vehicle from rolling.

25. **DRIVE AXLE SERVICE** —Check rear/front axle fluid level and add as needed. Check constant velocity joints and axle seals for leaking.
- **Locking differential**—Drain fluid at first oil change and refill. Check fluid level and add as needed at subsequent oil changes. In dusty areas, or trailer towing applications drain fluid at every 15,000 miles (24 135 kilometers) and refill.†
  - **Standard differential** —Check fluid level and add as needed at every oil change. In dusty areas, or trailer towing applications, drain fluid every 15,000 miles (24 135 kilometers) and refill.†
  - More frequent lubrication may be required on heavy-duty or off-road use.
26. **BRAKE SYSTEM INSPECTION** —When the engine oil is changed, inspect the lines and hoses for proper hookup, binding, leaks, cracks, chafing, etc. Check the parking brake adjustment, and the fluid level in the master cylinder. A low fluid level can indicate worn disc brake pads which may need to be serviced.†

\*An Emission Control Service

†A fluid loss in these systems may indicate a problem. Have them inspected and repaired at once.

## ***Scheduled Maintenance Services***

---

When the wheels are removed for rotation, inspect disc brake pads for wear and rotors for surface condition. Also inspect drum brake linings for wear and cracks. Inspect other brake parts, including drums, wheel cylinders, parking brake, etc., at the same time. Remove any rust or dirt from the wheel and mounting surfaces before mounting the wheel.

**Inspect brakes more often if driving habits or conditions result in frequent braking.**

### ***Owner Checks and Services***

Listed below are owner checks and services which should be made at the time period specified to help ensure proper safety, emission performance, and dependability of your vehicle.

Be sure any necessary repairs are completed at once. Whenever any fluids or lubricants are added to your vehicle, make sure they are the proper ones, as shown in this Section.

#### ***At Least Once a Month***

**Tire inflation pressure check** —Check the tires for proper inflation. If they are low, inflate them to the level specified on the certification label or on the tire inflation charts. See "Loading Your Vehicle" or "Inflation-Tire Pressure" in the Index.

#### ***At Least Once a Year***

**Key lock cylinder lubrication** —Lubricate key lock cylinders with engine oil. See the "Recommended Fluid and Lubricants" chart in this section.

**Transmission neutral or clutch start switch operation**

### **CAUTION**



When you are doing this check, the vehicle could move suddenly. If it does, you or others could be injured. Follow the steps below.

1. Before you start, be sure you have enough room around the vehicle.
2. Firmly apply both the manual parking brake and the regular brake. See "Brakes" and "Parking Brake" in the Index. Do not use the accelerator pedal.
3. Be ready to turn off the engine immediately if it starts.
4. On automatic transmission vehicles, try to start the engine in each gear. The starter should work only in **P** (Park) or **N** (Neutral).



---

On manual transmission vehicles, put the shift lever in **N** (Neutral), push the clutch down halfway, and try to start the engine. The starter should work only when the clutch is pushed down all the way to the floor.

**Steering column lock operation** —While parked, try to turn the key to **Lock** in each gear shift position.

With an automatic transmission, the key should turn to **Lock** only when the gear shift is in **P** (Park).

On vehicles with a key release lever, try to turn the key to **Lock** without pressing the lever. The key should turn to **Lock** only with the key lever depressed.

On all vehicles, the key should come out only in **Lock**.

**Parking brake and transmission P (PARK) mechanism operation** —

## CAUTION



When you are doing this check, your vehicle could begin to move. You or others could be injured and property could be damaged. Make sure there is room in front of your vehicle in case you begin to roll. Be ready to apply the regular brake at once should the vehicle begin to move.

Park on a fairly steep hill, with the vehicle facing downhill. Keeping your foot on the regular brake, set the manual parking brake.

- To check the parking brake: With the engine running and the transmission in **N** (Neutral), slowly remove foot pressure from the regular brake pedal. Do this until the vehicle is held by the parking brake only.
- To check the "Park" mechanism's holding ability: Apply the regular brake and shift to **P** (Park). Release the manual parking brake, then slowly release the regular brake.

**Lap and shoulder belts condition and operation** —Inspect belt system, including: webbing, buckles, latch plates, retractors, guide loops and anchors. Have a belt assembly replaced if the webbing has been cut or otherwise damaged.

**Body Lubrication Service** —Lubricate all body door hinges with engine oil. Also lubricate the tailgate, tailgate handle pivot points, and tailgate mounted spare tire carrier (if equipped). Lubricate the body hood, fuel door and rear compartment hinges, latches and locks including interior glove box and console doors, and any folding seat hardware. Lubricate the hood safety lever pivot and prop rod pivot. More frequent lubrication may be required when exposed to a corrosive environment.

# ***Scheduled Maintenance Services***

---

## ***Periodic Maintenance Inspections***

Listed below are inspections and services which should be performed at least twice a year (for instance each spring or fall). You should let your GM dealer's service department or other qualified service center do these jobs. Make sure any necessary repairs are completed at once.

**Steering and Suspension Inspection†** —Inspect front and rear suspension and steering system for damaged, loose or missing parts, signs of wear or lack of lubrication. Inspect power steering lines and hoses for proper hook-up, binding, leaks, cracks, chafing, etc. (On vehicles equipped with manual steering gear, check for seal leakage.) Lubricate the steering linkage.

**Accelerator Control System** —Lubricate all pivot points with engine oil, except the TBI throttle shaft. Remove all external deposits from the injector pump face cam on 6.2L and 6.5L engines. Do this when the engine is cold and not running. Do not oil any accelerator or cruise control cables. Replace any cables that have high effort or excessive wear.

**Exhaust System Inspection** —Inspect the complete system including the three-way catalytic converter. Inspect the body near the exhaust system. Look for broken, damaged, missing or out-of-position parts, as well as, open seams, holes, loose connections or other conditions which could cause a heat buildup in the floor pan or could let exhaust fumes seep into the passenger compartments.

**Drive Axle Service** —Check rear/front axle fluid level and add as needed. Check constant velocity joints and axle seals for leaking.

**Transfer Case (four-wheel drive) Inspection†** —Every 12 months or at oil change intervals, check front axle and transfer case and add lubricant when necessary. Oil the control lever pivot point and all exposed control linkage. Check vent hose at transfer case for kinks and proper installation. More frequent lubrication may be required on heavy-duty or off-road use.

†A fluid loss in these systems may indicate a problem. Have them inspected and repaired at once.

## Recommended Fluids & Lubricants

**NOTE:** Fluids and lubricants identified below by name, part number or specification may be obtained from your GM Dealer.

USAGE	FLUID/LUBRICANT
Engine Oil	GM Goodwrench Motor Oil or equivalent for API Service SG or SG/CE of the recommended viscosity.
Engine Coolant	Mixture of water and a good quality ethylene glycol base antifreeze conforming to GM-6038-M (GM Part No. 1052103).
Hydraulic Clutch System	Hydraulic Clutch Fluid (GM Part No. 12345347 or equivalent).
Hydraulic Brake Systems	Delco Supreme 11 <sup>®</sup> brake fluid (GM Part No. 1052535 or DOT-3).
Parking Brake Cables	Chassis grease meeting requirements of NLGI Grade 2, Category LB or GC-LB (GM Part No. 1052497).
Power Steering System	GM Power Steering Fluid (GM Part No. 1050017) or equivalent conforming to GM spec 9985010.
Manual Steering Gear	GM Lubricant (GM Part No. 1052182) or equivalent.
Automatic Transmission	DEXRON <sup>®</sup> IIE Automatic Transmission Fluid (GM Part No. 1051855).
<b>Manual Transmission:</b>	
a. 5-Speed with Low Gear	a. Castrol <sup>®</sup> Syntorq or equivalent (GM Part No. 12346074).
b. 5-Speed without Low Gear	b. Standard Transmission Fluid (GM Part No. 12345349).
<b>Differential:</b>	
a. Standard (Saginaw) Front and Rear Axle	a. SAE-80W-90 gear lubricant (GM Part No. 1052271).
b. Locking	b. SAE-80W-90 gear lubricant (GM Part No. 1052271).
Transfer Case	Dexron <sup>®</sup> IIE Automatic Transmission Fluid (GM Part No. 12345881).
Gas Line	Gas Line De-Icer (GM Part No. 1051516).
Weather Strips	Spray-A-Squeek (GM Part No. 1052277).
Column Shift, Transfer Case Shift Lever, and Propeller Shaft.	Chassis grease meeting requirements of NLGI Grade 2, Category LB or GC-LB (GM Part No. 1052497).
Clutch Fork Ball Stud	Chassis grease meeting requirements of NLGI Grade 2, Category LB or GC-LB (GM Part No. 1052497).
	(Continued next page) T0391

# **Scheduled Maintenance Services**

## **Recommended Fluids & Lubricants (Cont'd.)**

Hood Latch Assembly a. Pivots and spring anchor b. Release Pawl	a. Engine oil (GM Part No. 1050109). b. Chassis grease meeting requirements of GM-6031-M (GM Part No. 1052497).
Front Wheel Bearings	Chassis grease meeting requirements of NLGI Grade 2, Category LB or GC-LB (or GM Part No. 1052497).
Propeller Shaft Spline/Universal Joint	Chassis grease meeting requirements of GM-6031-M (GM Part No. 1052497)
Automatic Transmission Shift Linkage, Floor Shift Linkage, Hood and Door Hinges, Body Door Hinge Pins, Tailgate Hinge and Linkage, Folding Seat, Fuel Door Hinge	Engine oil
Key Lock Cylinders	Use regular engine oil or a synthetic light weight engine oil (SAE 5W-30).
Chassis Lubrication	Chassis grease meeting requirements of GM-6031 (GM Part No. 1052497).
Windshield Washer Solvent and Anti-Freeze	GM Optikleen washer solvent (GM Part No. 1051515) or equivalent.
Weatherstrip	Silicone grease (GM Part No. 12345579) or equivalent.
Outer Tailgate Handle Pivot Points	Multi-purpose lubricant meeting requirements of GM Part No. 12345120.
	T0392



# ***Scheduled Maintenance Services***

---

## ***Service Station Checks***

It is important for you or a service station attendant to perform these under-hood checks at each fuel fill.

- Check the engine oil level and add if necessary.
- Check the engine coolant level in the recovery bottle and add if necessary.
- Check the windshield washer fluid level and add if necessary.

See these items in the Index for information on how to check them.

*Engine Oil*

See Page 6-9

See Page 6-31

*Fuel*

For gasoline engines. Use unleaded gas only. 87 octane or higher. For capacity.

See Page 6-69

See Tire-Loading sticker on the inside of the rear edge of the driver's door.

See Page 6-46

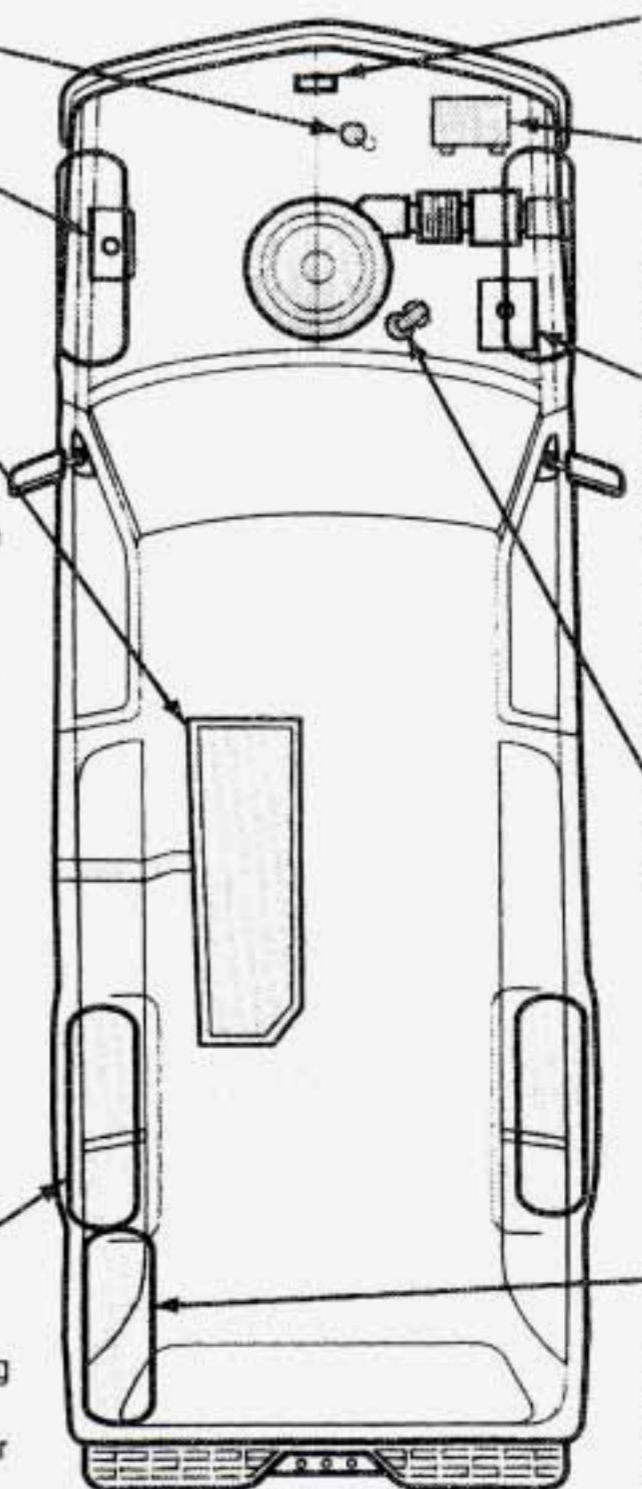

See Page 6-8

The Delco Freedom battery needs no water.

See Page 6-37

Check and add coolant **only** at the coolant recovery bottle. The fluid should be at the **COLD LEVEL** mark.

See Page 6-25

*Transmission Fluid*

See Page 6-17

See Tire-Loading sticker on the inside of the rear edge of the driver's door.

See Page 6-46





# ***Customer Assistance Information***

---



## ***Section***

Here you will find out how to contact GMC Truck if you need assistance. This section also tells you how to obtain service publications and how to report any safety defects.

Customer Satisfaction Procedure .....	8-2
Customer Assistance for Hearing/Speech Impaired .....	8-3
GM Participation in Better Business Bureau Mediation/Arbitration Program....	8-3
Reporting Safety Defects.....	8-4
Roadside Assistance .....	8-5
Service Publications .....	8-6

# ***Customer Assistance Information***

---

## ***Customer Satisfaction Procedure***

Your satisfaction and goodwill are important to your dealer and GMC Truck. Normally, any concerns with the sales transaction or the operation of your vehicle will be resolved by your dealer's Sales or Service Departments. Sometimes, however, despite the best intentions of all concerned, misunderstandings can occur. If your concern has not been resolved to your satisfaction, the following steps should be taken:

**STEP ONE** —Discuss your concern with a member of dealership management. Complaints can often be quickly resolved at that level. If the matter has already been reviewed with the Sales, Service, or Parts Manager, contact the owner of the dealership or the General Manager.

**STEP TWO** —If after contacting a member of Dealership Management, it appears your concern cannot be resolved by the dealership without further help, contact the GMC Truck Consumer Relations Manager by calling 1-800-GMC-TRUCK (1-800-462-8782). In Canada, contact the GM of Canada Customer Assistance Center in Oshawa by calling 1-800-263-3777 (English) or 1-800-263-7854 (French).

In Mexico, call (525) 254-3777. In Puerto Rico or U.S. Virgin Islands, call 1-809-763-1315. In all other overseas locations, contact GM International Export Sales in Canada by calling 1-416-644-4112.

For prompt assistance, please have the following information available to give the Customer Assistance Representative:

- Your name, address, telephone number
- Vehicle Identification Number (This is available from the vehicle registration or title, or the plate attached to the left top of the instrument panel and visible through the windshield).
- Dealership name and location
- Vehicle delivery date and present mileage
- Nature of concern

We encourage you to call the toll-free number listed previously in order to give your inquiry prompt attention. Information on offices outside the U. S. which can assist you can also be found in the Warranty and Owner Assistance Information booklet.

If you need to contact us in writing, please contact Consumer Relations by writing: GMC Truck, 31 E. Judson Street 1607-07, Pontiac, Michigan 48342-2230.

---

When contacting GMC Truck, please remember that your concern will likely be resolved in the dealership, using the dealership's facilities, equipment and personnel. That is why we suggest you follow Step One first if you have a concern.

## **Customer Assistance for the Hearing or Speech Impaired (TDD)**

To assist owners who have hearing difficulties, GMC Truck has installed special TDD (Telecommunications Devices for the Deaf) equipment at its Customer Assistance Center. Any hearing or speech impaired customer who has access to a TDD or conventional teletypewriter (TTY) can communicate with GMC Truck by dialing:

In the United States ..... 1-800-GMC-TKTD

In Canada ..... 1-800-263-3830.

## **GM Participation in Better Business Bureau Mediation/Arbitration Program\***

\*This program may not be available in all states, depending on state law. Canadian owners refer to your Warranty and Owner Assistance Information booklet.

General Motors reserves the right to change eligibility limitations and/or to discontinue its participation in this program.

Our experience has shown that the Customer Satisfaction Procedure described earlier in this section has been very successful in achieving customer satisfaction. However, if you have not been substantially satisfied, GMC Truck wants you to be aware of GM's voluntary participation in a no-charge mediation/arbitration program called BBB AUTO LINE. This program is administered by the Council of Better Business Bureaus through local Better Business Bureaus. The program can resolve individual disputes involving vehicle repairs and the interpretation of your New Vehicle Limited Warranty.

We prefer that you not resort to BBB AUTO LINE until after a final decision is made under the Customer Satisfaction Procedure. However, you may file a claim at any time by contacting your local Better Business Bureau (BBB) at the following toll-free number: 1-800-955-5100. For further information about filing a claim, you may also write to: BBB AUTO LINE, Council of Better Business Bureaus, 4200 Wilson Boulevard, Suite 800, Arlington, Virginia 22203.

## ***Customer Assistance Information***

---

In order to file a claim, you will have to provide your name and address, the vehicle identification number (VIN) of your vehicle, and a statement of the nature of your complaint. BBB staff may try to help resolve your dispute through mediation. If mediation is not successful, or if you do not wish to participate in mediation, eligible customers may present their case to an impartial third-party arbitrator at an informal hearing. The arbitrator will render a decision in your case, which you may accept or reject. If you accept a valid arbitrator decision, GM will be bound by that decision. The entire dispute settlement process should ordinarily take about 40 days from the time you file your complaint to the time a decision is rendered (or 47 days if you did not first contact your dealer or GMC Truck).

We encourage you to use this program before or instead of resorting to the courts. We believe it offers advantages over courts in most jurisdictions because it is fast, free of charge, and informal (lawyers are not usually present, although you may retain one at your expense if you choose). Arbitrators make decisions based on the principals of fairness and equity, and are not required to duplicate the functions of courts by strictly applying state or federal law. If you wish to go to court, however, we do not require that you first file a claim with BBB AUTO LINE\* unless state law provides otherwise. Whatever your preference may be, remember that if you are unhappy with the results of BBB AUTO LINE, you can still go to court because an arbitrator's decision is binding on GM but not on you, unless you accept it.

Eligibility is limited by vehicle age/mileage and other factors. For further information concerning the program, call the BBB at 1-800-955-5100. You may also call GMC Truck's Customer Relations Manager.

\*Some states may require that you file a claim with BBB AUTO LINE before resorting to state-operated procedures (including court).

### ***Reporting Safety Defects to the United States Government***

If you believe that your vehicle has a defect which could cause a crash or could cause injury or death, you should immediately inform the National Highway Traffic Safety Administration (NHTSA), in addition to notifying General Motors.

If NHTSA receives similar complaints, it may open an investigation, and if it finds that a safety defect exists in a group of vehicles, it may order a recall and remedy campaign. However, NHTSA cannot become involved in individual problems between you, your dealer, or General Motors.

---

To contact NHTSA, you may either call the Auto Safety Hotline toll-free at 1-800-424-9393 (or 366-0123 in the Washington, D.C. area) or write to: NHTSA, U.S. Department of Transportation, Washington, D.C. 20590. You can also obtain other information about motor vehicle safety from the Hotline.

### ***Reporting Safety Defects to the Canadian Government***

If you live in Canada, and you believe that your vehicle has a safety defect, you should immediately notify Transport Canada, in addition to notifying General Motors of Canada Limited. You may write to: Transport Canada at Box 8880, Ottawa, Ontario K1G 3J2.

### ***Reporting Safety Defects to General Motors***

In addition to notifying NHTSA (or Transport Canada) in a situation like this, we certainly hope you'll notify us. Please call us at 1-800-GMC-TRUCK (1-800-462-8782), or write: GMC Truck, Consumer Relations, 31 E. Judson Street 1607-07, Pontiac, Michigan 48342-2230. In Canada, please call us at 1-800-263-3777 (English) or 1-800-263-7854 (French). Or, write: General Motors of Canada Limited, Customer Assistance Center, 1908 Colonel Sam Drive, Oshawa, Ontario L1H 8P7.

### ***Roadside Assistance***

GMC Truck's Roadside Assistance provides stranded owners with over-the-phone roadside repairs or towing service for disabled vehicles. This service combines the efforts of technically trained telephone representatives with a network of GMC Truck's dealer services.

Just dial GMC Truck Roadside Assistance at 1-800-GMC-TRUCK (1-800-462-8782) to reach a qualified representative who can assist you in repair or arrange a tow. Other recommended services can also be arranged for situations such as retrieving locked-in keys, changing a tire, or delivering gasoline, at a charge to the owner. We also provide dealer information at no charge such as location of the nearest GMC Truck dealer and their hours of operation.

Roadside Assistance is available 24 hours a day, seven days a week, 365 days a year, including weekends and holidays. Should you have any questions about Roadside assistance, call the GMC Truck Roadside Assistance Center or Contact your dealer.

In Canada, call 1-800-268-6800 for details on Roadside Assistance.

# **Customer Assistance Information**

## ***Service Publications***

Information on how to obtain Product Service Publications, Subscriptions and Indexes as described below is applicable only in the fifty U.S. states (and the District of Columbia) and only for light trucks with GVWR less than 10,000 pounds (4536 kg).

In Canada, information pertaining to Product Service Bulletins and Indexes can be obtained by writing to: General Motors of Canada Limited, Service Publications Department, 1908 Colonel Sam Dr., Oshawa, Ontario L1H 8P7.

GMC Truck regularly sends its dealers useful service bulletins about GMC Truck products. GMC Truck monitors product performance in the field. We then prepare bulletins for servicing our products better. Now, you can get these bulletins too.

Bulletins cover various subjects. Some pertain to the proper use and care of your vehicle. Some describe costly repairs. Others describe inexpensive repairs which, if done on time with the latest parts, may avoid future costly repairs. Some bulletins tell a technician how to repair a new or unexpected condition. Others describe a quicker way to fix your vehicle. They can help a technician service your vehicle better.

Most bulletins apply to conditions affecting a small number of trucks. Your GMC Truck dealer or a qualified technician may have to determine if a specific bulletin applies to your vehicle.

You can subscribe to all GMC Truck bulletins. This way you'll get them as they come out. You can wait a while and get an index to the bulletins. You can also get individual bulletins. However, you'll need the index to identify them.

## ***Subscriptions***

You can subscribe to all GMC Truck Product Service Publications (PSP's). This will include bulletins for all light trucks (less than 10,000 lbs. [4536 kg] GVWR) sold by GMC Truck and will not be limited to PSP's applicable to any particular model. When you buy a subscription, you will receive the PSP's in periodic mailings, shortly after they come out. A subscription costs U.S. \$75.00 (\$85.00 including a special binder) and it entitles you to all PSP's published by GMC Truck during the model year. You can purchase a subscription by sending a check or money order to GMC Truck Service Publications, Post Office Box 436006, Pontiac, Michigan 48343 along with the order form located at the end of this section. You may get additional subscription ordering forms by calling the toll-free number shown in this section, or you can find them at participating dealerships.

---

### ***Individual PSP's***

If you don't want to buy all the PSP's issued by GMC Truck for all models in the model year, you can buy individual PSP's, such as those which may pertain to a particular model. To do this, you will first need to see our index of PSP's. It provides a variety of information. Here's what you'll find in the index and how you can get one:

#### ***What You'll Find in the Index:***

- A list of all PSP's published by GMC Truck in a model year (1989 or later). PSP's covering all models of GMC Truck light trucks (less than 10,000 pounds [4536 kg] GVWR) are listed in the same index.
- Ordering information so you can buy the specific PSP's you may want.
- Price information for the PSP's you may want to buy.

#### ***How You Can Get an Index:***

Indexes are published periodically. Most of the PSP's which could potentially apply to the most recent GMC Truck models will be listed in the most recent publication for that model year. This means you may want to wait until the end of the model year before ordering an index, if you are interested in buying PSP's pertaining to a current model year truck.

Some PSP's pertaining to a particular model year vehicle may be published in later years, and these would be listed in the later year's index. When you order an index for a model year that is not over yet, we'll send you the most recently published issue. Check the ordering form for indexes for earlier model years.

Cut out the ordering form, fill it out, and mail it in. We will then see to it that an index is mailed to you. There is no charge for indexes for the 1989-1993 model years.

#### ***Toll-Free Telephone Number***

If you want an additional ordering form for an index or a subscription, just call toll-free and we'll be happy to send you one. Automated recording equipment will take your name and mailing address. The number to call is 1-800-551-4123.

# ***Customer Assistance Information***

---

## ***Copies at Participating Dealers***

Copies of Indexes and individual PSP's are at your participating GMC Truck dealer. You can ask to see them.

**A VERY IMPORTANT REMINDER:** These PSP's are meant for technicians. They are not meant for the "do-it-yourselfer." Technicians have the equipment, tools, safety instructions, and know-how to do a job quickly and safely.

GMC Truck reserves the right to change these procedures without notice after November, 1992.

## ***GMC Truck Service Publications***

You can get these Product Service Publications by using the order form at the end of this book. You can also get Service Manuals and Owner Publications.



**Section**

**9**

**A**

Accelerator Control System.....6-35  
 Air Cleaner.....6-16  
 Air Conditioning.....3-5, 6-69  
     Rear (Wagon Models).....3-8  
     Refrigerant Capacity.....6-69  
     System Controls.....3-6  
 Antenna, Fixed Mast.....3-21  
 Antilock Brakes (See "Brakes")  
     System Warning Light.....2-70  
 Appearance Care.....6-57  
     Materials.....6-64  
 Arbitration Program.....8-3  
 Audio Systems.....3-12  
     AM Radio.....3-13  
     AM-FM Stereo Audio System  
         with Cassette Deck.....3-14  
     AM-FM Stereo Audio System  
         with Cassette Deck  
         and Equalizer.....3-17, 3-19  
 Cassette Deck.....3-16  
 Cassette Tape Player Care.....3-21  
 Automatic Transmission.....2-17  
     Fluid.....6-17  
 Axle  
     Front.....2-32, 6-24  
     Rear.....6-24  
     Rear Locking.....2-22

**B**

Battery.....6-37  
 Belts (See "Safety Belts")  
 Better Business Bureau  
     Mediation.....8-3  
 Blizzard.....4-55  
 Brakes  
     Adjustment.....4-18  
     Antilock.....4-15  
     Antilock Warning Light.....2-70  
     Fluid.....6-32  
     Four-Wheel Antilock.....4-16  
     Hydro-Boost System  
         (Hydraulic Pump).....6-33  
     Master Cylinder.....6-32  
     Parking.....2-23  
     Pedal Travel.....4-18  
     Rear Drum Brakes.....4-18  
     Replacing Parts.....6-33  
     System Warning Light .2-69, 4-17  
     Trailer.....4-60  
     Wear Indicators.....4-17  
 Braking.....4-13  
     In Emergencies.....4-18  
 Break-In, New Vehicle.....2-11  
 Bulb Replacement.....6-37  
     Replacement Chart.....6-72

# INDEX

## C

- Capacities and Specification
  - Charts.....6-68
- Carbon Monoxide.....2-7, 2-28,  
2-29, 4-55, 4-61
- Cassette Tape Player  
(See "Audio Systems")
- Catalytic Converter.....6-45
- Certification/Tire Label.....6-46
- Changing a Flat Tire.....5-16, 5-20
- Chemical Paint Spotting.....6-63
- Child Restraints  
(See "Safety Belts")
- Cigarette Lighter/Ashtrays.....2-55
- Circuit Breakers (See "Fuses")
- Cleaning
  - Finish Care.....6-61
  - Glass.....6-60
  - Inside of Vehicle.....6-58
  - Instrument Panel, Top.....6-60
  - Outside of Vehicle.....6-61
  - Special Problems.....6-59
  - Vinyl or Leather.....6-60
  - Wheels and Tires.....6-62
  - Windshield.....6-60
- Clock.....3-15 3-18
- Comfort Controls.....3-2
- Console
  - Floor.....2-56
  - Overhead.....2-58
- Convenience Net.....2-80
- Coolant (See "Engine")
- Cooling System Capacity.....6-68
- Crankcase Capacity.....6-69
- Cruise Control.....2-41
  - Increase Speed.....2-43
  - On Hills.....2-45
  - Passing.....2-45
  - Reduce Speed.....2-44
  - Resume.....2-43
  - Set.....2-42
  - To Get Out Of.....2-45

- Cup Holder.....2-57
- Customer Assistance for the  
Hearing or Speech Impaired....8-3
- Customer Satisfaction Procedure 8-2

## D

- Daytime Running Lights  
(Canada Only).....2-47
  - Indicator Light.....2-47, 2-73
- Dome Lights.....2-48
- Doors.....2-5
  - Locks.....2-6
  - Panel.....2-9
- Driving
  - Across an Incline.....4-31, 4-32
  - After Off-Road Driving.....4-34
  - At Night.....4-35
  - Braking.....4-13
  - Control of A Vehicle.....4-13
  - Defensive.....4-9
  - Downhill.....4-30
  - Freeway.....4-43
  - Guidelines.....4-24
  - High Beams.....4-36
  - Highway Hypnosis.....4-46
  - Hydroplaning.....4-38
  - In Blizzard.....4-55
  - In City.....4-42
  - In Fog, Mist and Haze 4-40, 4-41
  - In Rain.....4-37, 4-39
  - In Sand, Mud, Ice,  
Or Snow.....4-33, 5-31
  - In Water.....4-34
  - Long Distance.....4-44
  - Loss of Control.....4-23
  - Night Vision.....4-35
  - Off-Roading.....4-24
  - On Curves.....4-18
  - On Grades.....4-62
  - On Hill and Mountain Roads 4-47
  - On Off-Road Hills.....4-27
  - On Snow or Ice.....4-53
  - Passing.....4-21, 4-61

Skidding .....	4-23
Stuck in Deep Snow ....	4-56, 5-31
Through Water .....	2-15, 4-34
Uphill .....	4-28
Winter .....	4-53
With a Trailer .....	4-60
Drunken Driving .....	4-10

## E

Electrical System .....	6-37
Add-On Equipment .....	6-67
Engine	
Adding Coolant ...	5-11, 5-13, 6-27
Air Cleaner .....	6-16
Block Heater .....	2-16, 3-5, 6-16
Computer Command Control System .....	6-45
Coolant .....	6-25, 6-68
Coolant Temperature Gage .....	2-77
Cooling System .....	5-10
Crankcase .....	6-69
Exhaust .....	2-28
Fan Noise .....	5-16
Identification .....	6-65, 6-68
Leaving Vehicle While Running .....	2-26
Oil (See "Oil")	
Overheating .....	5-8
Running While Parked .....	2-29
Starting .....	2-14
Equipment, Add-On .....	6-48
Exhaust System .....	6-45

## F

Fan Noise .....	5-16
Filter Replacement Chart .....	6-69
Finish	
Care .....	6-61
Damage .....	6-62
Fluid	
Automatic Transmission .....	6-17
Brake .....	6-32

Capacities .....	6-68
Coolant .....	5-11
Front Axle .....	6-24
Hydraulic Clutch .....	6-21
Leak Check .....	6-35
Manual Transmission .....	6-20
Power Steering .....	6-29
Radiator .....	5-13
Rear Axle .....	6-24
Recommended Fluids .....	7-25
Transfer Case .....	6-23
Windshield Washer .....	2-40, 6-31
Four-Wheel Drive .....	2-30, 6-23
Transfer Case .....	2-30, 6-23
Front Axle .....	6-24
Fuel .....	6-4
Filling Your Tank .....	6-6
Foreign Countries .....	6-6
Gage .....	2-76
Gasolines for Cleaner Air .....	6-5
Tank Capacity .....	6-69
Fuses and Circuit Breakers .....	6-43
Fuse Block .....	6-44
Headlights .....	6-43
Power Windows and Other Power Options .....	6-44
Trailer Wiring Harness .....	6-44
Windshield Wipers .....	6-44

## G

Gages .....	2-66, 2-76
Coolant Temperature Gage ....	2-77
Fuel Gage .....	2-76
Odometer .....	2-66
Oil Pressure Gage .....	2-78
Speedometer .....	2-66
Tachometer .....	2-67
Trip Odometer .....	2-67
Voltmeter .....	2-79
Glove Box .....	2-56

# INDEX

## H

- Halogen Bulbs ..... 6-38
- Hazard Warning Flashers ..... 5-2
- Head Restraints ..... 1-5
- Headlights ..... 2-46, 6-38, 6-43
  - Composite ..... 6-39
  - High Beam Indicator Light ..... 2-74
  - High-Low Beam ..... 2-38, 4-36
  - Reminder ..... 2-47
  - Replacement ..... 6-37, 6-72
  - Sealed Beam ..... 6-38
- Heating System (with A/C) ..... 3-5
  - Rear (Wagon Models) ..... 3-8
  - Rear Window Defogger ..... 3-11
  - System Controls ..... 3-6
- Heating System (without A/C) ..... 3-4
  - Fan Knob ..... 3-4
  - Function Lever ..... 3-4
  - Rear Window Defogger ..... 3-11
  - Temperature Lever ..... 3-4
- Highway Hypnosis ..... 4-46
- Hitches ..... 4-59
- Hood
  - Latches and Hinge ..... 6-36
  - Release ..... 6-8
- Horn ..... 2-35
- Hydraulic Clutch ..... 6-21
  - Grease Fitting ..... 6-23
- Hydroplaning ..... 4-38

## I

- If You're Stuck In Sand, Mud,
  - Ice or Snow ..... 5-31
- Ignition Switch ..... 2-11
- Inflation-Tire Pressure ..... 6-49
- Instrument Panel ..... 2-62
  - Standard Cluster ..... 2-64

## J

- Jack and Tools ..... 5-18
  - Removal ..... 5-18
  - Storage ..... 5-29, 5-30
- Jump Starting ..... 5-3

## K

- Key Release Lever ..... 2-13
- Keys ..... 2-3

## L

- Lights ..... 2-46
  - Brake System Warning ..... 4-17
  - Bulb Replacement ..... 6-37
  - Charging System Light ..... 2-71
  - Check Gages Light ..... 2-73
  - Dome ..... 2-48
  - Front Parking/Turn Signal ..... 6-40
  - Headlights (See "Headlights")
  - Indicator ..... 2-68
  - Operation ..... 2-37
  - Reading ..... 2-49
  - Roof Marker ..... 6-42
  - Service Engine Soon ..... 2-72, 6-45
  - Rear ..... 6-42
  - Replacement Chart ..... 6-72
  - Side Marker ..... 6-41
  - Underhood Reel ..... 2-50
- Loading Your Vehicle ..... 4-25, 6-46
  - Add-On Equipment ..... 6-48
- Lubrication ..... 6-35
  - Accelerator Control System ..... 6-35
  - Body ..... 6-36
  - Constant Velocity Joints ..... 6-36
  - Front Axle ..... 6-24
  - Front Shock Absorbers ..... 6-34
  - Front Suspension and
    - Steering Linkage ..... 6-34
  - Front Wheel Bearings ..... 6-34
  - Tailgate Handle ..... 6-37
- Hydraulic Clutch
  - Grease Fitting ..... 6-23
- Hood Latches and Hinge ..... 6-36
- Lock Cylinders ..... 6-36
- Propeller Shaft Slip Splines ..... 6-36
- Rear Axle ..... 6-24
- Recommended Lubricants ..... 7-25
- Transfer Case ..... 6-23
- Luggage Carrier ..... 2-80

---

---

## M

Maintenance	
Other Items .....	6-34
Periodic Inspections .....	7-24
Record .....	7-3, 7-27
Scheduled Maintenance ..	7-4, 7-18
Underbody .....	6-62
When Towing a Trailer .....	4-63
Master Cylinder (See "Brakes")	
Mirrors .....	2-51
Convex Outside .....	2-52
Electric Outside .....	2-52
Inside .....	2-51
Model Reference .....	iii
Multifunction Lever .....	2-36
Turn Signal/Lane Change Indicator .....	2-37, 2-75

## O

Odometer .....	2-66
Off-Road Driving (See "Driving")	
Off-Road Recovery .....	4-20
Oil .....	6-9
Additives .....	6-15
Disposal of Used .....	6-16
Pressure Gage .....	2-78
To Check .....	6-10
What Kind to Use .....	6-12
When to Add .....	6-10
When to Change .....	6-15
Owner Checks and Services .....	7-22

## P

Parking	
On Hills .....	4-49
Over Things That Burn .....	2-27
Torque Lock (Automatic Transmission) .....	2-24, 4-52
Your Vehicle (Manual Transmission) .....	2-26
Parking Brake .....	2-23
Passing Other Vehicles ....	4-21, 4-61
Pavement Markings .....	4-8

Periodic Maintenance	
Inspections .....	7-24
Power	
Door Locks .....	2-7
Steering .....	4-18
Steering Fluid .....	6-29
Winches .....	4-64
Product Service Publications .....	8-6

## R

Radiator Pressure Cap .....	6-28
Radio (See "Audio Systems")	
Rear Window Defogger .....	3-11
Recommended Fluids And Lubricants .....	7-25
Recovery Hooks .....	5-32
Replacement Parts .....	6-68
Reporting Safety Defects .....	8-4
Road Signs .....	4-2
Roadside Assistance .....	8-5
Rocking Your Vehicle .....	5-32

## S

Safety Belts .....	1-13
Adults .....	1-20
Center Passenger .....	1-27, 1-29
Cleaning .....	6-60
Checking Restraint System ....	1-47
Child Restraints .....	1-36
Children .....	1-34
Driver Position .....	1-20
Extender .....	1-46
Lap Shoulder .....	1-21
Larger Children .....	1-44
Proper Wear .....	1-20
Questions and Answers .....	1-18
Rear Seat .....	1-30
Reminder Light .....	1-19
Replacing After a Crash .....	1-47
Right Front Passenger .....	1-27
Small Children and Babies ....	1-34
Use During Pregnancy .....	1-26
Why They Work .....	1-15

# INDEX

- Safety Chains ..... 4-60  
Safety Warnings and Symbols..... 0-2  
Scheduled Maintenance  
    Services ..... 7-4, 7-18  
Seats  
    Controls ..... 1-2  
    Easy Entry Seat ..... 1-6  
    Manual Front ..... 1-2  
    Power Driver's ..... 1-3  
    Rear Folding ..... 1-8  
    Reclining ..... 1-3  
    Removable ..... 1-11  
    Seatback Latches ..... 1-5  
Secondary Air Injection  
    (AIR) System ..... 6-45  
Service  
    Do-It-Yourself ..... 6-3  
    Parts Identification Label ..... 6-67  
    Publications ..... 8-6, 8-8  
    Replacement Parts and Filter  
        Recommendations ..... 6-69  
Service Engine Soon Light ..... 2-72  
Service Station Checks ..... 7-28  
Shift Indicator Light ..... 2-22, 2-74  
Shifting Into Park ..... 2-24  
Single Belt Accessory Drive ..... 6-34  
Spare Tire ..... 5-18  
    Removal ..... 5-20  
    Storage ..... 5-30  
Specification Charts ..... 6-68  
Speedometer ..... 2-66  
Starting Your Engine ..... 2-14  
Steering ..... 4-18  
    Column Shift Lever ..... 2-25  
    In Emergencies ..... 4-19  
    Tips ..... 4-18  
Storage Compartments ..... 2-55  
    Other ..... 2-61  
Sun Visors ..... 2-53
- T**
- Tachometer ..... 2-67  
Tailgate ..... 2-7  
    Electric Glass Release ..... 2-34  
Theft ..... 2-10  
Thermostat ..... 6-28  
Tilt Wheel ..... 2-35  
Tires ..... 6-48  
    Balancing ..... 6-55  
    Chains ..... 6-56  
    Changing a Flat ..... 5-16, 5-20  
    Flat ..... 5-16  
    Hub Caps/Wheel Nut Caps ..... 5-22  
    Inspection and Rotation ..... 6-52  
    Loading ..... 6-46  
    New ..... 6-53  
    Pressure ..... 6-49  
    Spare (See "Spare Tire")  
    Uniform Tire Quality Grading ..... 6-54  
Torque Lock ..... 2-24, 4-52  
Towing  
    A Trailer ..... 4-56  
    Backing Up ..... 4-61  
    Following Distance ..... 4-61  
    Hitches ..... 4-59  
    Maintenance ..... 4-63  
Towing Your Vehicle ..... 5-7  
Traffic Lights ..... 4-7  
Trailer Brakes ..... 4-60  
    Towing ..... 4-56  
    Wiring Harness ..... 2-82  
Trailer Package ..... 6-47  
Transfer Case ..... 2-30, 6-23  
Transmission  
    Automatic ..... 2-17  
    Five-Speed Manual ..... 2-20  
    Fluid ..... 6-17, 6-20  
    Fluid, To Add ..... 6-19, 6-21  
    Fluid, To Check ..... 6-18, 6-20

Four-Wheel (See "Four-Wheel Drive")	
Shift Light.....	2-22
Torque Lock (Automatic Transmission) .....	2-24, 4-52
Trip Odometer .....	2-67

## V

Vehicle	
Damage Warnings.....	0-3
Identification Number....	6-65, 6-66
Loading.....	4-25, 6-46
Storage.....	6-37
Symbols .....	0-4
Ventilation System .....	3-2
Air Vents.....	3-3
Tips.....	3-2
Voltmeter.....	2-79

## W

Warning Lights, Gages and Indicators .....	2-68, 2-76
(Also See "Lights") Devices, Other.....	5-3
Wheels	
Alignment and Tire Balance...	6-55
Aluminum .....	6-62
Hub Caps/Wheel Nut Caps....	5-22
Nut Torque .....	6-34, 6-68
Replacement .....	6-55
Used Replacement.....	6-56
Windows.....	2-33
Windshield Washer .....	2-40
Rear Window .....	2-54
Washer Fluid .....	2-40, 6-31
Winter Driving.....	4-53
Wipers, Windshield .....	2-39
Blade Chatter.....	6-60
Blade Inserts .....	6-35
Cleaning Blades.....	6-60
Rear Window .....	2-54

## 1993 SERVICE PUBLICATIONS ORDERING INFORMATION

You can get manuals that tell how to operate and service your vehicle. To order them, fill out the order form on the next page and send it to the address below.

GMC Truck Service Publications  
Post Office Box 436006  
Pontiac, MI 48343

If you have questions or would like to order using your credit card,  
**call us TOLL FREE at 1-800-627-5699.**

From outside the Continental United States, please call 1-313-455-801

### GLOVE BOX LITERATURE FOR YOUR YUKON AND SUBURBAN

Manual	Form Number	Price
Owner's Manual	X-9309	\$5.50
Warranty Manual	X-9317	\$2.00
Vehicle Storage Manual	X-0101	—

You can also order the Glove Box Literature in a vinyl portfolio which includes all of these publications. Ask for form number 15690053—costs \$14.00.

### SERVICE MANUALS FOR ALL LIGHT DUTY TRUCKS

\*Includes Fuel and Emissions Manual X-9336

Model	Form Number	Price*
1993 C/K Models	X-9331	\$62.00
1993 G Van	X-9357	\$70.00
1993 P3 Models	X-9332	\$64.00
1993 Safari	X-9330	\$62.00
1993 S/T Models	X-9329	\$61.00

There are other service manuals you can buy that cover the electrical systems and unit repair. Call us to get a catalogue listing of all these manuals.

### PRODUCT SERVICE PUBLICATIONS

Description	Form Number	Price
• 1990 Model Year Index	PSP 1 90	Free
• 1991 Model Year Index	PSP 1 91	Free
• 1992 Model Year Index	PSP 1 92	Free
• 1993 Model Year Index	PSP 1 93	Free
• 1993 Model Year Product Service Publication Subscription	PSP 93	\$75.00
• Above Subscription With Binder	PSP 93B	\$85.00
• Binder Only	PSP B	\$15.00

**Prices subject to change without notice.**



# SERVICE PUBLICATIONS ORDER FORM

**NOTE: Please complete form below (Print or Type) and MAIL TO:**

**GMC Truck Service Publications, P.O. Box 436006, Pontiac, MI 48342**

**ORDER TOLL FREE  
1-800-627-5699**

From outside the Continental United States,  
please call 1-313-455-8016

- Refunds or exchanges will not be accepted after 30 days.
- Routine orders will be shipped within 10 days of receipt.
- For an additional charge of \$9.00, Rush Orders will be shipped within 24 hours of receipt.
- Please allow adequate time for postal service.
- We also offer UPS-Overnight Express-Call for Rates.
- Prices subject to change without notice

## SHIP TO

### FROM:

Adistra Corporation  
Attn: GMC Service Publications  
171 Hamilton St.  
Plymouth, MI 48170

### TO:

(COMPANY NAME)

(NAME)

(STREET ADDRESS)

(APT. NO.)

(CITY)

(STATE)

(ZIP CODE)

This is your shipping label

Please Print Clearly

## ORDER

Publication Form Number	Description	Qty.	Price Each	Total Price
<b>TOTAL MATERIAL</b>				
Michigan Purchasers add 4% sales tax				
Rush Order Charge				
Overnight Delivery				
<b>GRAND TOTAL</b>				

## PAYMENT

MasterCard

VISA

American Express

Check or Money Order Enclosed.

Please be sure to sign your check!

**Make Checks Payable to Adistra Corporation (No Stamps)**

Card

Number

Expiration

Date mo/yr.

CUSTOMER SIGNATURE

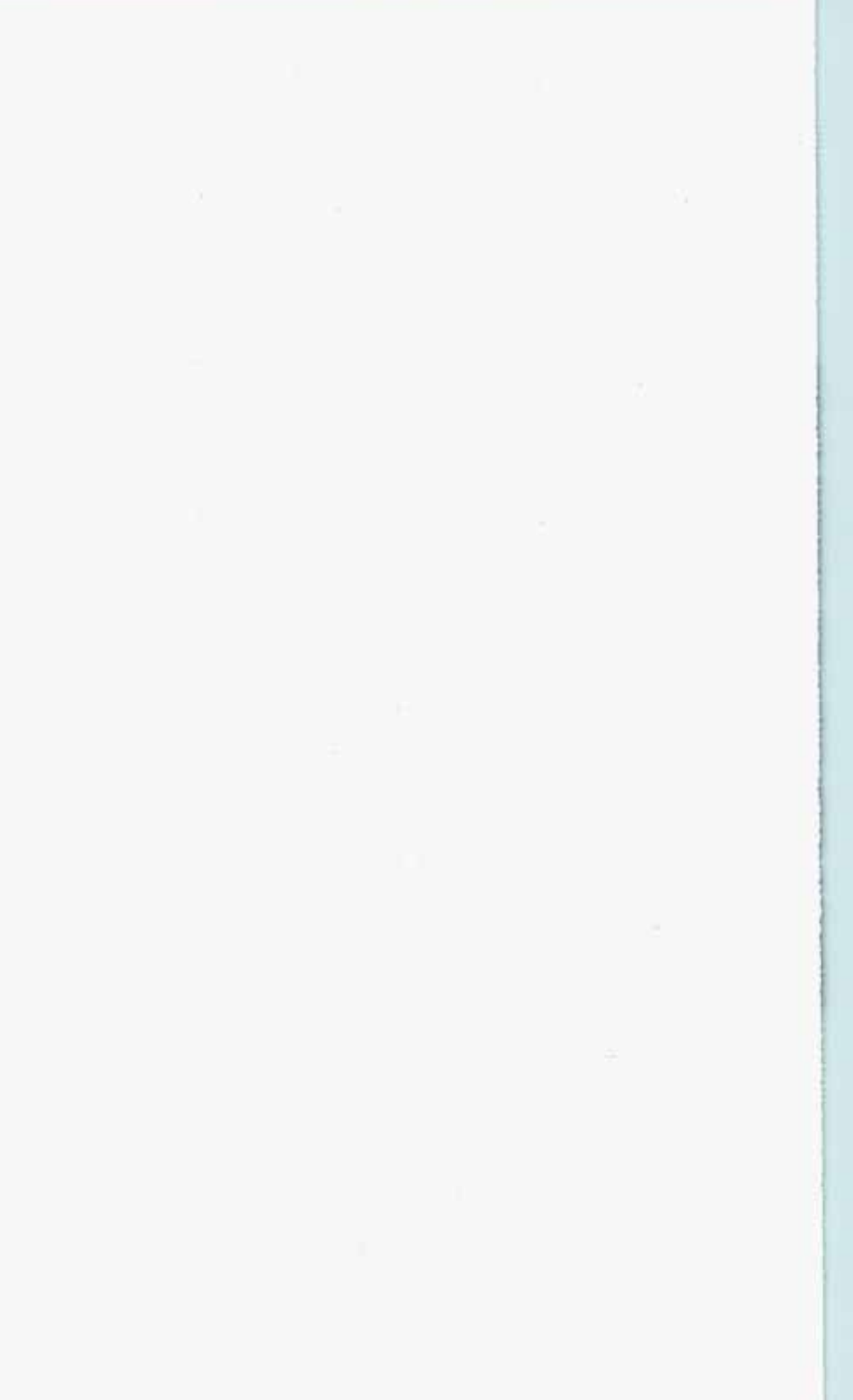



X-9309

Keep with vehicle at all times.  
Contains Important Operating, Safety,  
and Maintenance Instructions.



WE SUPPORT  
VOLUNTARY TECHNICIAN  
CERTIFICATION THROUGH

National Institute for  
**AUTOMOTIVE  
SERVICE  
EXCELLENCE**



**GMC**TRUCK