



PD808B INSTRUCTION MANUAL

Contents

Warnings & Precautions	2
Important Safety Instructions	3
In the Box & Features	4
Powering the Unit	5
Compatible Storage Devices	6
Playing & Programming a CD	7
Playing & Programming a DVD	8
Using the USB Input	9
Using the SD/MMC Memory Card Slot	10
AV Output: Connecting a Television	11
S-Video Output: Connecting a Television	12
Coaxial Audio Output: Connecting a Stereo System	13
The Setup Menu	14-15
Controls & Control Definitions	16-23
Service Information	24

Warnings and Precautions

TO PREVENT FIRE OR SHOCK HAZARDS, DO NOT EXPOSE THIS UNIT TO RAIN OR MOISTURE.



This symbol, located on back or bottom of the unit, is intended to alert the user to the presence of uninsulated “dangerous voltage” within the product’s enclosure that may be of sufficient magnitude to constitute a risk of electric shock to persons.



This symbol, located on back or bottom of the unit, is intended to alert the user to the presence of important operating and maintenance (servicing) instructions in the literature accompanying the appliance.



This product utilizes a Class 1 laser to read Compact Discs. This laser Compact Disc Player is equipped with safety switches to avoid exposure when the CD door is open and the safety interlocks are defeated. Invisible laser radiation is present when the CD Player’s lid is open and the system’s interlock has failed or been defeated. It is very important that you avoid direct exposure to the laser beam at all times. Please do not attempt to defeat or bypass the safety switches.

CAUTION: TO PREVENT ELECTRIC SHOCK, MATCH WIDE BLADE OF PLUG TO WIDE SLOT, FULLY INSERT.

To reduce the risk of electric shock, do not remove cover (or back). There are no user-serviceable parts inside. Please refer any servicing to qualified service personnel.

WARNING: Changes or modifications to this unit not expressly approved by the party responsible for compliance could void the user’s authority to operate the equipment.

WARNING: There is a danger of explosion if you attempt to charge standard Alkaline batteries in the unit. Only use rechargeable NiMH batteries.

WARNING: Danger of explosion if the remote control’s batteries are incorrectly installed. Replace only with the same or equivalent battery.

WARNING: The remote control’s button cell battery contains mercury. Do not put in the trash, instead recycle or dispose of as hazardous waste

WARNING: Lithium ion batteries, like all rechargeable batteries are recyclable and should be recycled or disposed of in normal household waste. Contact your local government for disposal or recycling practices in your area. They should never be incinerated since they might explode.

WARNING: Use of this unit near fluorescent lighting may cause interference regarding use of the remote. If the unit is displaying erratic behavior move away from any fluorescent lighting, as it may be the cause.

NOTE: This equipment has been tested and found to comply with the limits for a Class B digital device, pursuant to Part 15 of the FCC Rules. These limits are designed to provide reasonable protection against harmful interference in a residential installation. This equipment generates, uses, and can radiate radio frequency energy and, if not installed and used in accordance with the instructions, may cause harmful interference to radio communications. However, there is no guarantee that interference will not occur in a particular installation. If this equipment does cause harmful interference to radio or television reception, which can be determined by turning the equipment off and on, the user is encouraged to try to correct the interference by one or more of the following measures:

- Reorient or relocate the receiving antenna.
- Increase the separation between the equipment and receiver.
- Connect the equipment into an outlet on a circuit different from that to which the receiver is connected.
- Consult the dealer or an experienced radio/TV technician for help.

Important Safety Instructions

- 1. Read Instructions** - All the safety and operating instruction should be read before the product is operated.
- 2. Retain Instructions** - The safety and operating instruction should be retained for future reference.
- 3. Heed Warnings** - All warning on the product and in the operating instructions should be adhered to.
- 4. Follow instructions** - All operating and use instructions should be followed.
- 5. Cleaning** - Unplug this product from the wall outlet before cleaning. Do not use liquid cleaners or aerosol cleaners. Clean only with a dry cloth.
- 6. Attachments** - Do not use attachments not recommended by the product manufacturer as they may cause hazards.
- 7. Water and Moisture** - Do not use this product near water - for example, near a bath tub, wash bowl, kitchen sink, or laundry tub; in a wet basement, or near a swimming pool, and the like. The apparatus shall not be exposed to dripping or splashing and that no objects filled with liquids, such as vases, shall be placed on apparatus.
- 8. Accessories** - Do not place this product on an unstable cart, stand, tripod, bracket, or table. The product may fall, causing serious injury to a child or adult, and serious damage to the product. Use only with a cart, stand, tripod, bracket, or table recommended by the manufacturer, or sold with the product. Any mounting of the product should follow the manufacturer's instructions, and should use a mounting accessory recommended by the manufacturer.
- 9. A product and cart combination** should be moved with care. Quick stops, excessive force, and uneven surfaces may cause the appliance and cart combination to overturn.

See figure:



- 10. Ventilation** - Slots and openings in the cabinet are provided for ventilation and to ensure reliable operation of the product and to protect it from overheating, and these openings must not be blocked or covered. The openings should never be blocked by placing the product on a bed, sofa, rug, or other similar surface. This product should not be placed in a built-in installation such as a bookcase or rack unless proper ventilation is provided or the manufacturer's instruction have been adhered to.
- 11. Power Sources** - This product should be operated only from the type of power source indicated on the marking label. If you are not sure of the type of power supply to your home, consult your product dealer or local power company. For products intended to operate from battery power, or other sources, refer to the operating instruction.
- 12. Grounding or Polarization** - This product may be equipped with a polarized alternating-current line plug (a plug having one blade wider than the other). This plug will fit into the power outlet only one way. This is a safety

feature. If you are unable to insert the plug fully into the outlet, try reversing the plug. If the plug should still fail to fit, contact your electrician to replace your obsolete outlet. Do not defeat the safety purpose of the polarizes plug.

Alternate Warnings - This product is equipped with a three-wire grounding-type plug, a plug having a third (grounding) pin. This plug will only fit into a grounding-type power outlet. This is a safety feature. If you are unable to insert the plug into the outlet, contact your electrician to replace your obsolete outlet. Do not defeat the safety purpose of the grounding-type plug.

- 13. Power-Cord Protection** - Power supply cords should be routed so that they are not likely to be walked on or pinched by items placed upon or against them, paying particular attention to cords at plugs, convenience receptacles, and point where they exit from the product.
- 14. Protective Attachment Plug** - The product is equipped with an attachment plug having overload protection. This is a safety feature. See Instruction Manual for replacement or resetting of protective device. If replacement of the plug is required, be sure the service technician has used a replacement plug specified by the manufacturer that has the same overload protection as the original plug.
- 15. Outdoor Antenna Grounding** - If an outside antenna is connected to the receiver, be sure the antenna system is grounded so as to provide some protection against voltage surges and built-up static charges. Article 810 of the National Electrical Code, ANSI/NFPA 70, provides information with regard to proper grounding of the mast and supporting structure, grounding of the mast and supporting structure, grounding of the lead-in wire to an antenna-discharge unit, size of grounding conductors, location of antenna-discharge unit, connection to grounding electrodes, and requirements for the grounding electrode.

See figure:

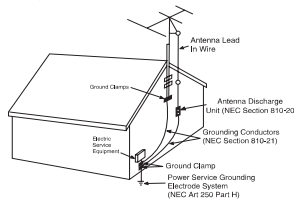

- 16. Lightning** - For added protection for this product during a lightning storm, or when it is left unattended and unused for long periods of time, unplug it from the wall outlet and disconnect the antenna or cable system. This will prevent damage to the product due to lightning and power-line surges.
- 17. Power Lines** - An outside antenna system should not be located in the vicinity of overhead power lines or other electric light or power circuits, or where it can fall into such power lines or circuits. When installing an outside antenna system, extreme care should be taken to keep from touching such power lines or circuits as contact with them might be fatal.
- 18. Overloading** - Do not overload wall outlets, extension cords, or integral convenience

receptacles as this can result in a risk of fire or electric shock.

- 19. Object and Liquid Entry** - Never push objects of any kind into this product through openings as they may touch dangerous voltage points or short-out parts that could result in a fire or electric shock. Never spill liquid of any kind on the product.
- 20. Servicing** - Do not attempt to service this product yourself as opening or removing covers may expose you to dangerous voltage or other hazards. Refer all servicing to qualified service personnel.
- 21. Damage Requiring Service** - Unplug this product from the wall outlet and refer servicing to qualified service personnel under the following conditions:
 - When the power-supply cord or plug is damaged,
 - If liquid has been spilled, or objects have fallen into the product,
 - If the product has been exposed to rain or water,
 - If the product does not operate normally by following the operating instructions. Adjust only those controls that are covered by the operating instructions as an improper adjustment of other controls may result in damage and will often require extensive work by a qualified technician to restore the product to its normal operation.
 - If the product has been dropped or damaged in any way, and
 - When the product exhibits a distinct change in performance - this indicates a need for service.
- 22. Replacement Parts** - When replacement parts are required, be sure the service technician has used replacement parts specified by the manufacturer or have the same characteristics as the original part. Unauthorized substitutions may result in fire, electric shock, or other hazards.
- 23. Safety Check** - Upon completion of any service or repairs to this product, ask the service technician to perform safety checks to determine that the product is in proper operating condition.
- 24. Wall or Ceiling Mounting** - The product should be mounted to a wall or ceiling only as recommended by the manufacturer.
- 25. Heat** - The product should be situated away from heat sources such as radiators, heat registers, stoves, or other products (including amplifiers) that produce heat. Battery shall not be exposed to excessive heat such as sunshine, fire, or the like.
- 26. Main plug** is used as disconnect device and it should remain readily operable during intended use. In order to disconnect the apparatus from the mains completely, the mains plug should be disconnected from the mains socket outlet completely.
- 27. Excessive sound pressure** from earphones and headphones can cause hearing loss.

In the Box

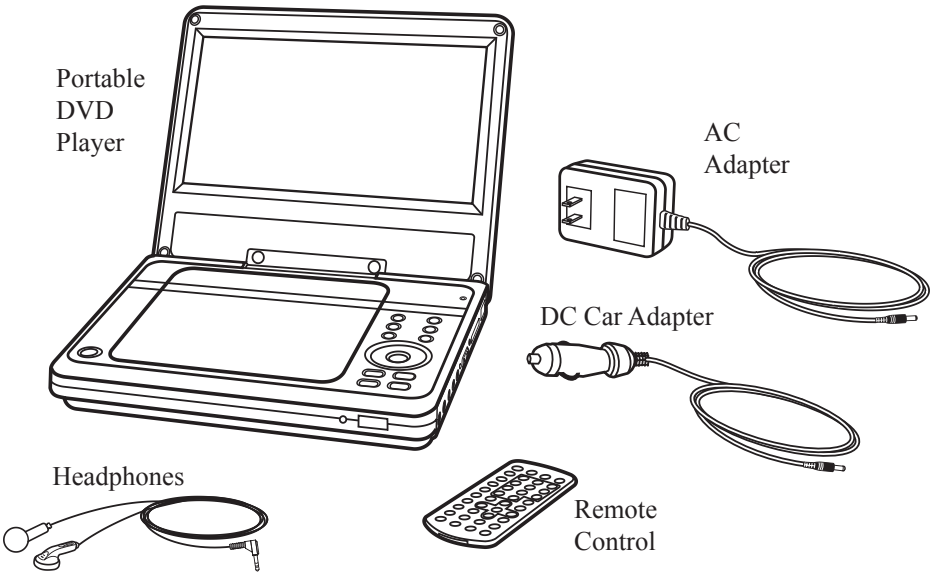

-
- Portable DVD Player
 - Headphones
 - AC Adapter
 - DC Car Adapter
 - Remote Control

Features

- Plays DVD-R/RW, DVD+R/RW & JPEG Discs
 - Plays CD & CD-R/RW Discs
 - Chapter/Title Search & Select
 - Supports Multiple Languages and Language Subtitles
 - Zoom Feature
 - OSD: On Screen Display
 - Multi-Angle Play
 - Still Picture & Slow Motion
 - NTSC
 - Programmable CD Tracks
 - Skip/Search Tracks
 - 8.4" TFT LCD Screen
 - Digital Coaxial Output
 - S-Video Output
 - Dual Stereo Headphone Jacks
 - USB Jack for Thumb Drives
 - SD Card Slot
 - Video/Audio Output Jack, 3.5mm type
-

Powering the Unit

AC Power

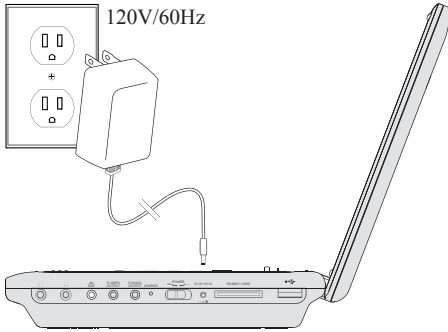

1. When plugged into a compatible AC outlet, the unit's built-in battery will charge.

DC Power

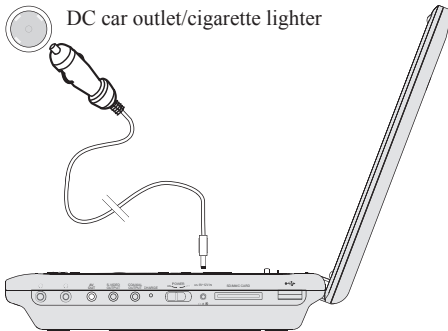

1. When plugged into a compatible DC car outlet, the unit's built-in battery will charge.

Battery Power

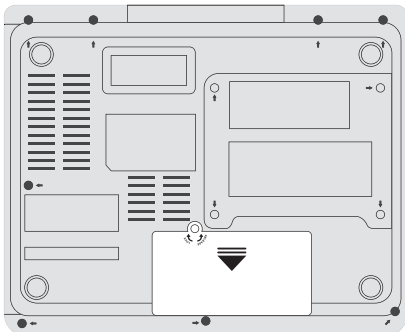

1. To charge the unit, simply connect it to an AC outlet using the AC/DC Adapter, or connect it to a DC car outlet using the DC Car Adapter.
2. It takes approximately 4-5 hours to charge the unit completely.

Compatible Storage Devices

The following types of digital storage devices can be connected to the unit to play photos, movies, and music on the unit.

The MMC and SD memory cards cannot play audio files when connected to the unit.

USB Mass Storage Device
(not included)

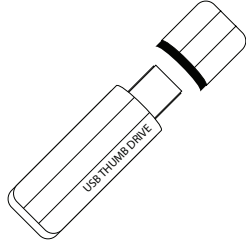

Memory Cards
(not included)

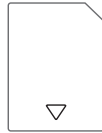

MMC



SD

Playing a CD

• Besides playing Audio CDs, the unit is capable of playing AVI files and JPEG files off of CDs.

1. Plug the unit into a standard 120V outlet, and turn the power on by moving the **Power Switch** into the *ON* position. If the internal battery is charged, the unit does not have to be plugged in.
2. Press the **Open Button** and load a CD into the unit's DVD-Drive. Close the DVD Door, and the CD will start automatically.
3. If the CD doesn't start, switch the unit to *DVD Mode* by pressing and holding **DVD/SD/USB Function Button**.
4. Press the **Play & Pause Buttons** to play and pause the CD.
5. Press the **Previous & Next Buttons** to skip backwards and forwards through CD tracks.

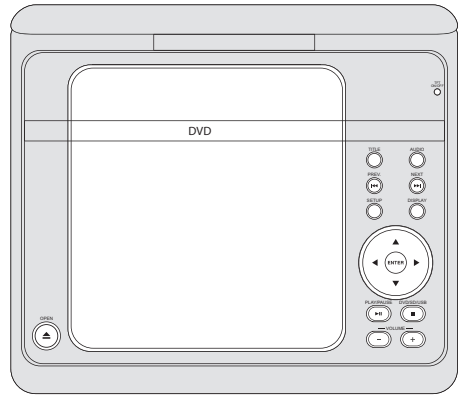
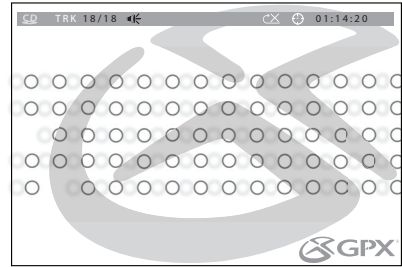

Programming a CD

1. Insert a CD into the unit. *See the "Playing a CD" operation.*
2. After the CD is inserted and loaded, press the **Program Button** on the remote control to display the *Program Menu*.
3. Use the **Directional Buttons** to move through the sixteen different program slots.
4. Highlight a slot and enter CD track numbers using the **Number Keypad** on the remote control. Repeat steps 3 and 4 until the desired tracks are programmed.
5. Highlight the "Play" button, on screen, using the **Directional Buttons**, and press the **Enter Button** to begin playing the programmed tracks.

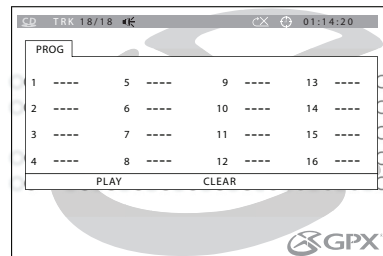

Playing a DVD

1. Plug the unit into a standard 120V outlet, and turn the power on by moving the **Power Switch** into the *ON* position. If the internal battery is charged, the unit does not have to be plugged in.
2. Press the **Open Button** and load a DVD into the unit's DVD-Drive. Close the DVD Door, and the DVD will start automatically.
3. If the DVD doesn't start, switch the unit to *DVD Mode* by pressing and holding the **DVD/SD/USB Function Button**.
4. Use the **Directional Buttons** to navigate through the DVD menu.
5. Press the **Play Button** or **Enter Button** to make selections in the DVD menu.
6. Press the **Pause Button** to pause a DVD during play.
7. Press the **Previous & Next Buttons** to skip backwards and forwards through DVD chapters.
8. Press the **Menu Button** to go back to the DVD's main menu.

Programming a DVD

1. Insert a DVD into the unit. *See the "Playing a DVD" operation on page 16.*
2. After the DVD is inserted and loaded, press the **Program Button** on the remote control to display the *Program Menu*.
3. Use the **Directional Buttons** to move through the sixteen different program slots.
4. Highlight a slot and enter a *Title (T)* number and *Chapter (C)* number using the **Number Keypad** on the remote control. Repeat steps 3 and 4 until the desired titles and chapters are programmed.
5. Highlight the "Play" button, on screen, using the **Directional Buttons**, and press the **Enter Button** to begin playing the programmed titles and chapters.

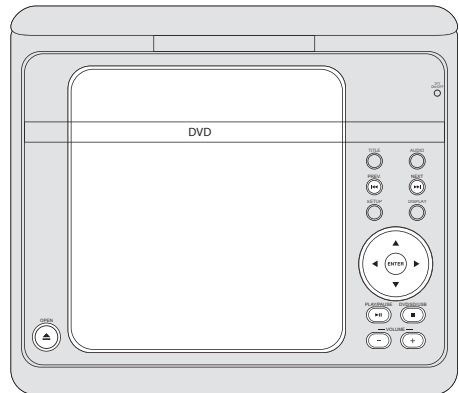
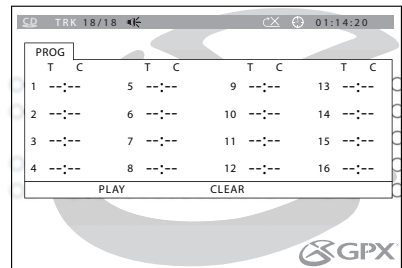

Using the USB Input

1. Plug a USB thumb drive into the **USB Input**.
2. Switch the unit to *USB Mode* by pressing and holding the **DVD/SD/USB Function Button**. The following display will appear.
3. Use the **Directional Buttons** to select videos, music, or images. Press the **Enter Button** to play a selected video, or image.

- *The unit will play some mainstream, AVI movie files, and JPEG image files from USB thumb drives. The different file types must be separated into folders for the unit to read them.*

- *Please note, loaded memory cards will not play audio files.*

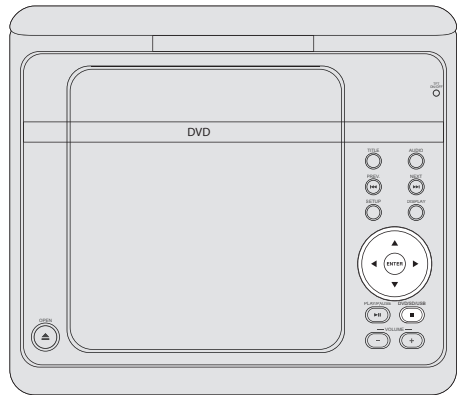
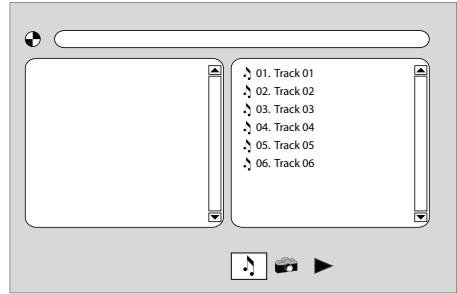

USB Mass Storage Device
(not included)

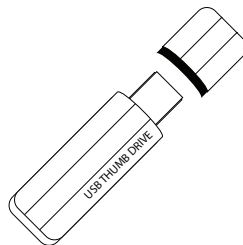

Using the SD/MMC Memory Card Slot

1. Plug an SD or MMC memory card into the **SD/MMC Memory Card Slot**.
2. Switch the unit to *SD Mode* by pressing and holding the **DVD/SD/USB Function Button**. The following display will appear.
3. Use the **Directional Buttons** to select videos or images. Press the **Enter Button** to play a selected video or image.

- *The unit will play AVI movie files and JPEG image files from SD or MMC memory cards. The different file types must be separated into folders for the unit to read them.*

- *Please note, loaded memory cards will not play audio files.*

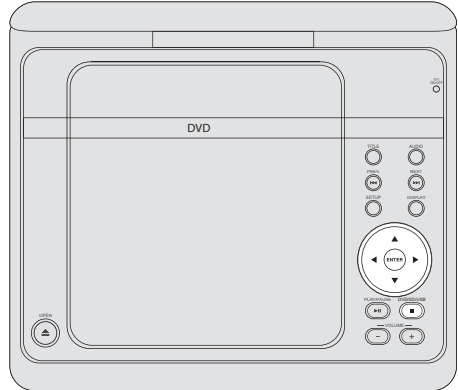
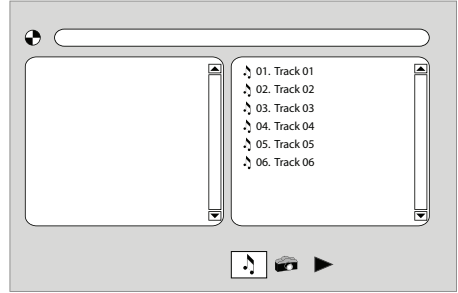

Memory Cards
(not included)



MMC

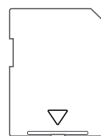

SD

AV Output: Connecting a Television

When connecting two products using an RCA Cable, match the colored ports with the same colored connection. (Red to Red, White to White, and Yellow to Yellow)

1. Connect the 3.5mm - RCA Cable (not included) to the **AV Output** on the unit and the audio/video inputs on the Television
2. Turn the unit on by adjusting the **Power Button** to the *On* position.
3. Change the television to the correct audio/video input setting.
4. Audio and video played through the unit will now be seen and heard on the connected television.

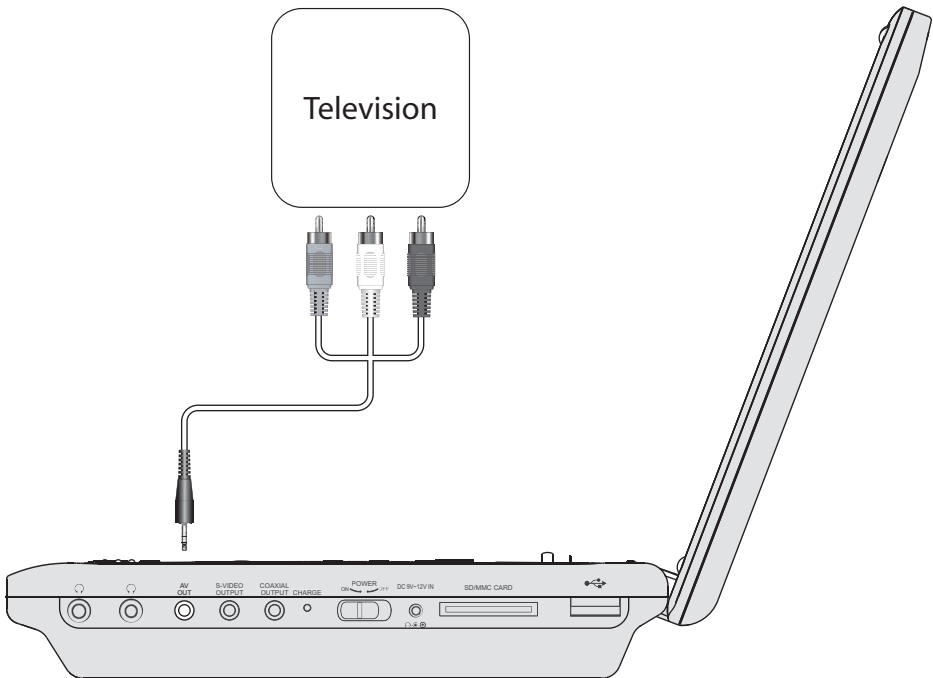

S-Video Output: Connecting a Television

When connecting two products using an RCA Cable, match the colored ports with the same colored connection. (Red to Red, White to White, and Yellow to Yellow)

1. Connect a 3.5mm - S-Video Cable (not included) to the **S-Video Output** on the unit and the S-Video Input on the Television.
2. Turn the unit on by adjusting the **Power Button** to the *On* position.
3. Change the television to the correct audio/video input setting.
4. Video played through the unit will now be seen on the Television.

To connect audio to a television when using the S-Video connection for video, connect the AV Output, or Coaxial Audio Output to the television.

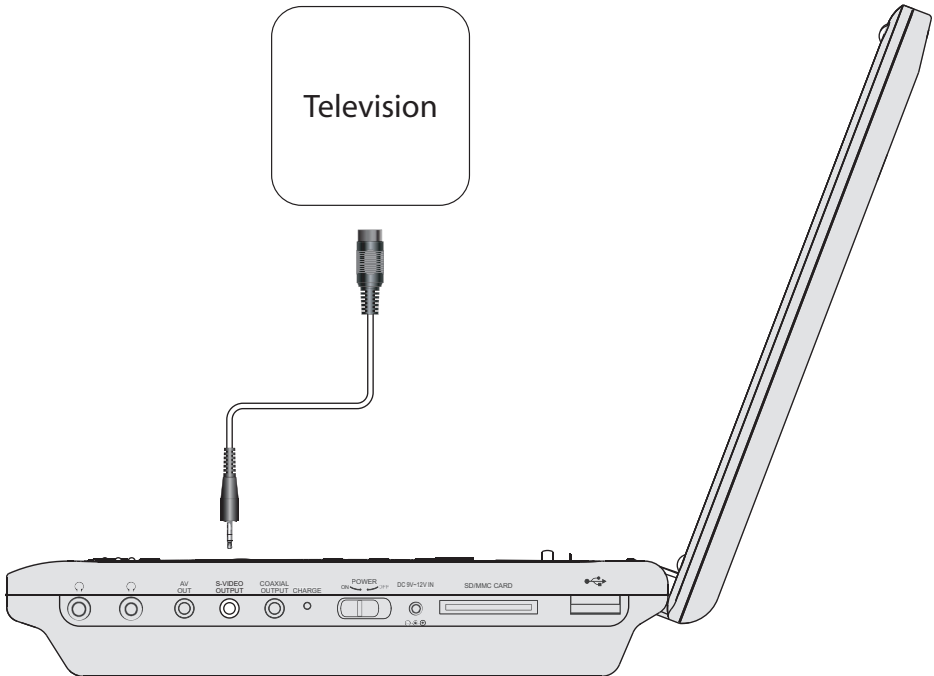

Coaxial Audio Output: Connecting a Stereo System

When connecting two products using an RCA Cable, match the colored ports with the same colored connection. (Red to Red, White to White, and Yellow to Yellow)

1. Connect a 3.5mm - RCA Cable (not included) to the **Coaxial Audio Output** on the unit and the coaxial audio input on a surround sound system.
2. Turn the unit on by adjusting the **Power Button** to the *On* position.
3. Change the stereo system to the correct audio input setting.
4. Audio played through the unit will now be heard on the connected television or stereo system.

To connect video to a television when using the Coaxial Audio Output connection for audio, connect the AV Output, or S-Video Output to a television.

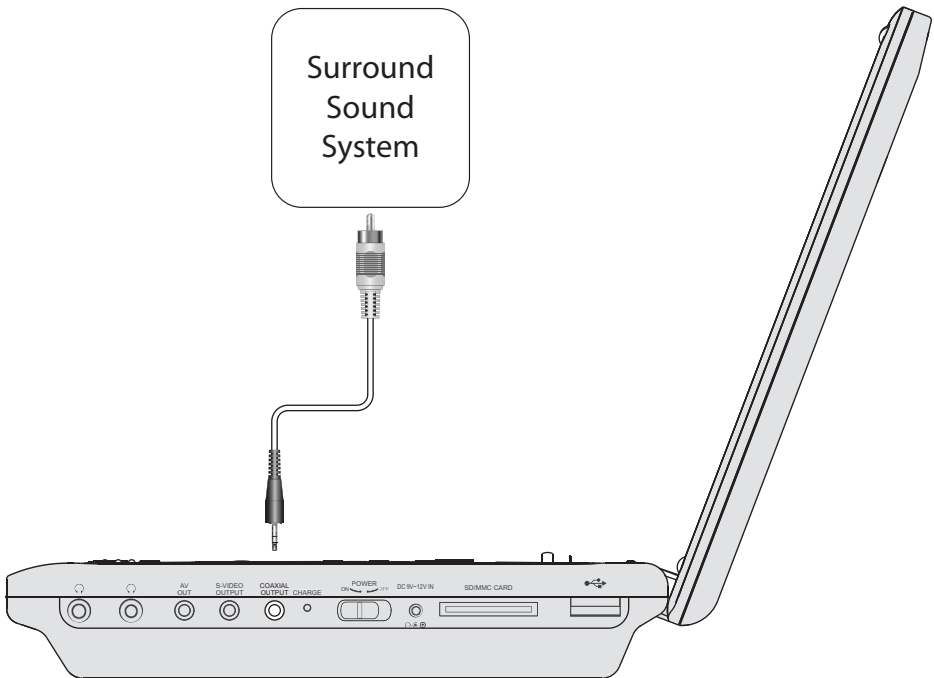

The Setup Menu

To enter the Setup Menu, press the **Setup Button** on the unit or the **DVD Setup Button** on the remote.

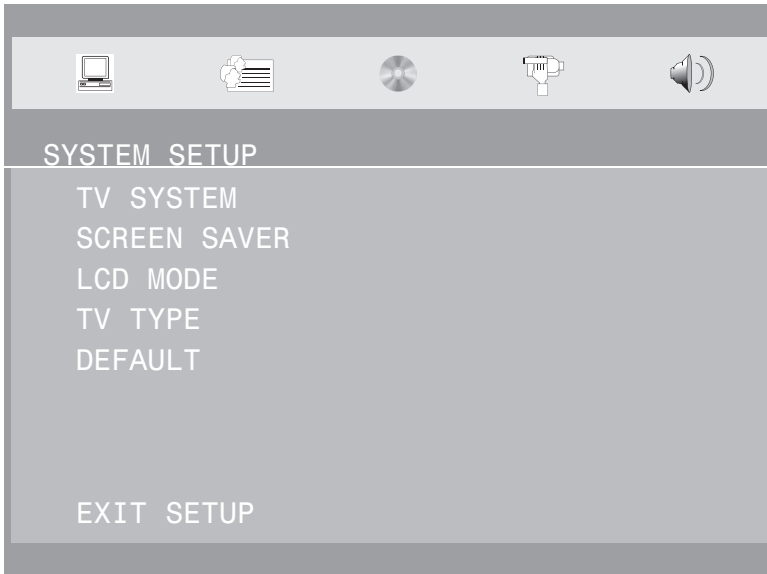

System Setup

TV System Select the TV system that's consistent with the connected television. NTSC is the standard TV System setting for the U.S.A., Canada, and Mexico.

Screen Saver Turn the unit's Screen Saver on or off.

LCD Mode

- **4:3LB** The 4:3LB (Letterbox) ratio shows the DVD movie in a original format, but with black bars at the top and bottom to fits on a standard TV screen.
- **16:9** The 16:9 ratio shows the DVD movie in its wide screen format. Use this setting when viewing a movie on a wide screen TV.
- Press the **Wide Button**, on the remote, to switch between 4:3 and 16:9 LCD Modes without accessing the Setup Menu.

TV Type The ratio of the width of an image to its height.

- **4:3PS** The 4:3PS (Pan & Scan) ratio shows the DVD movie in full screen on a Standard TV.
- **4:3LB** The 4:3LB (Letterbox) ratio shows the DVD movie in a original format, but with black bars at the top and bottom to fits on a standard TV screen.
- **16:9** The 16:9 ratio shows the DVD movie in its wide screen format. Use this setting when viewing a movie on a wide screen TV.

Default The **Default Button** will change all settings back to the original factory defaults.

The Setup Menu

Language Setup

Use the Language Section of the Setup Menu to change the language of the DVD Player's interfaces as well as the DVD subtitles, audio, and menu. Subtitle, Audio and DVD Menu Languages are dependent on the DVD.

OSD Language In the OSD (On Screen Display) Language Section choose from English, French, and Spanish as different OSD Languages

Audio Language Use the Audio setting to select the audio language of the DVD. The Audio setting is dependent on the DVD's language offerings.

Subtitle Language The Subtitle setting allows the user to turn subtitles on and change the subtitle language. The Subtitle setting is dependent on the DVD's language offerings.

Menu Language Use the DVD Menu setting to select the written language on the DVD's main menu. The DVD Menu setting is dependent on the DVD in the player.

Audio Setup

Audio Out

- **Off** The Off setting is used when the Coaxial Audio Output is not connected.
- **RAW** The RAW setting will automatically enable **PCM** in circumstances where it can be used, and automatically disable it when it cannot be used. Like **PCM**, this option also requires the Coaxial Audio Output to be connected to a surround sound receiver.
- **PCM** The Coaxial Audio Output must be connected to a surround sound receiver to take advantage of this feature.

Video Setup

Brightness The **Brightness** can be set to any number between 0 and 12. The default **Brightness** setting is 6.

Contrast The **Contrast** can be set to any number between 0 and 12. The default **Contrast** setting is 6.

Hue The **Hue** can be set to any number between -6 and +6. The default **Hue** setting is 0.

Saturation The **Saturation** can be set to any number between 0 and 12. The default **Saturation** setting is 6.

Sharpness The **Sharpness** can be set to any number between 0 and 8. The default **Sharpness** setting is 0.

Speaker Setup

Downmix The **Downmix** can be set to RT/LT or STEREO.

- *When connecting to a mono speaker system, use the RT/LT setting.*
- *When connecting to a stereo or surround sound system, use the Stereo Setting.*

Location of Controls

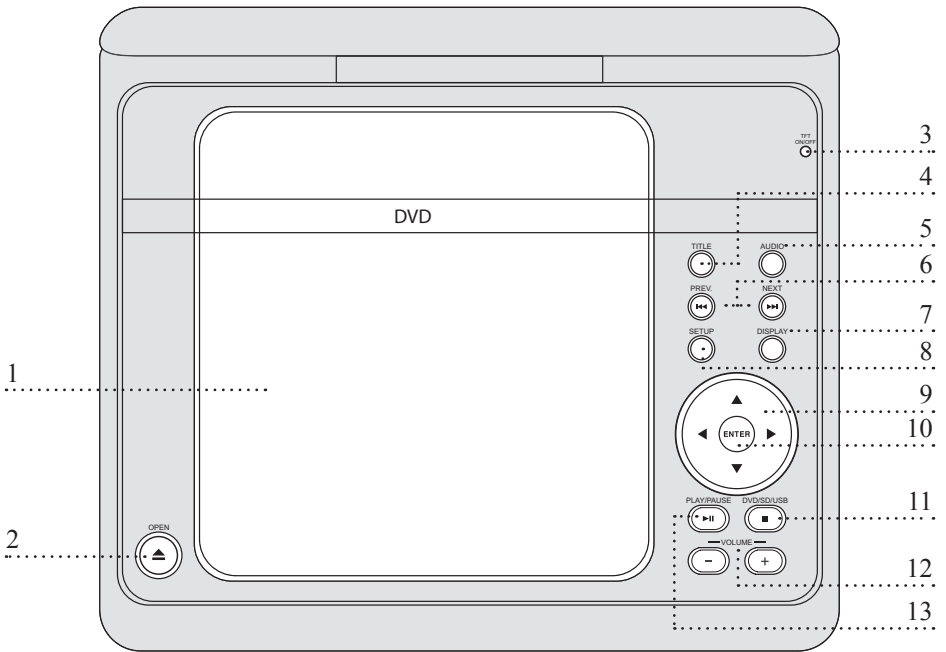

Control Definitions

- 1 DVD Door** The DVD Door houses the DVD/CD Drive.

- 2 Open Button** Press the Open Button to open the DVD Door.

- 3 TFT On/Off** The TFT On/Off Button keeps the TFT Display from staying on when the unit is folded up.

- 4 Title Button** Press the Title Button to see the Title Menu on a DVD.

- 5 Audio Button** Press the Audio Button to adjust the DVD's audio language.

- 6 Previous & Next Buttons** Press the Previous & Next Buttons to skip backwards and forwards through CD tracks, and DVD chapters.

- 7 Display Button** In *CD or DVD Mode*, press the Display Button to view the track or title and chapter information, as well as the play time.

- 8 Setup Button** Press the Setup Button in DVD Mode to access the unit's DVD Setup Menu.

- 9 Directional Buttons** Use the Directional Buttons to navigate through a DVD or CD.

- 10 Enter Button** Press the Enter Button to select media on a DVD or CD.

- 11 DVD/SD/USB Function Button** Press and hold the Function Button to switch between DVD, SD, and USB modes.

- 12 Volume Buttons** Press the Volume Buttons to increase (+) or decrease (-) the volume.

- 13 Play & Pause Button** Press the Play & Pause Button to play or pause a DVD or CD.

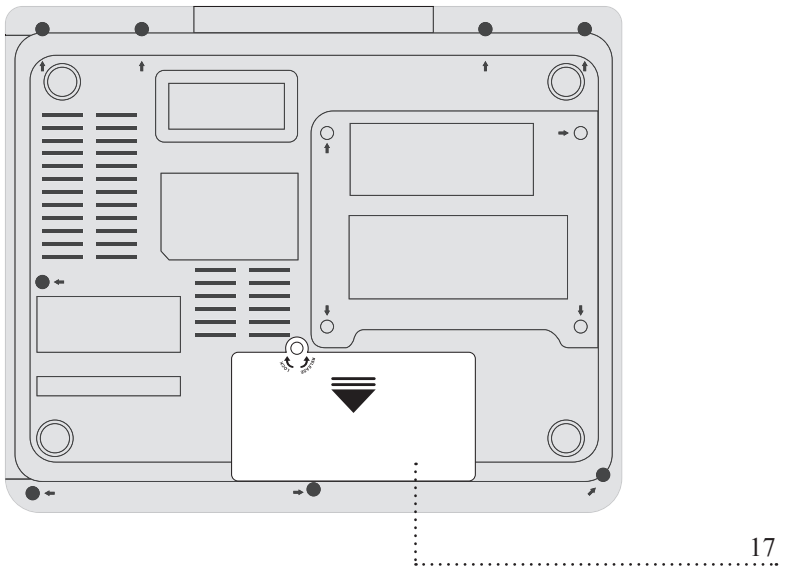
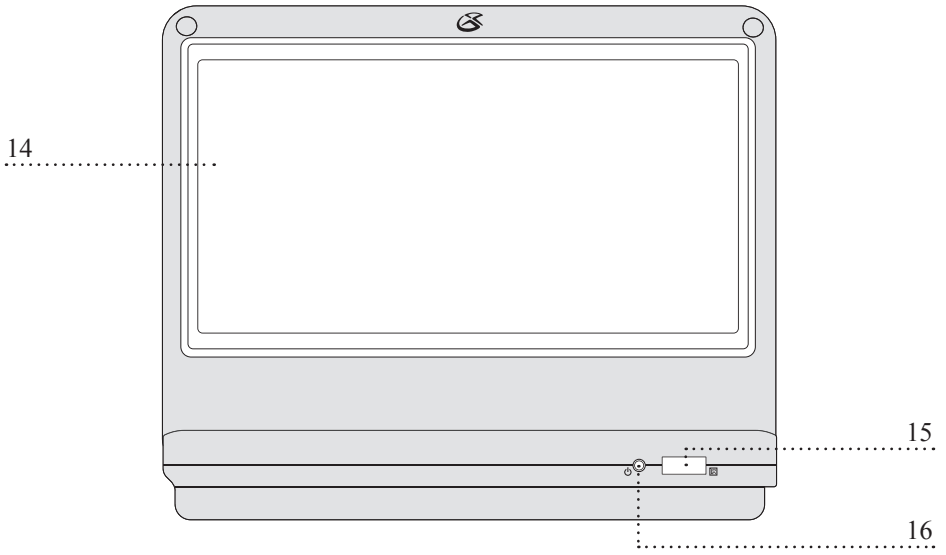

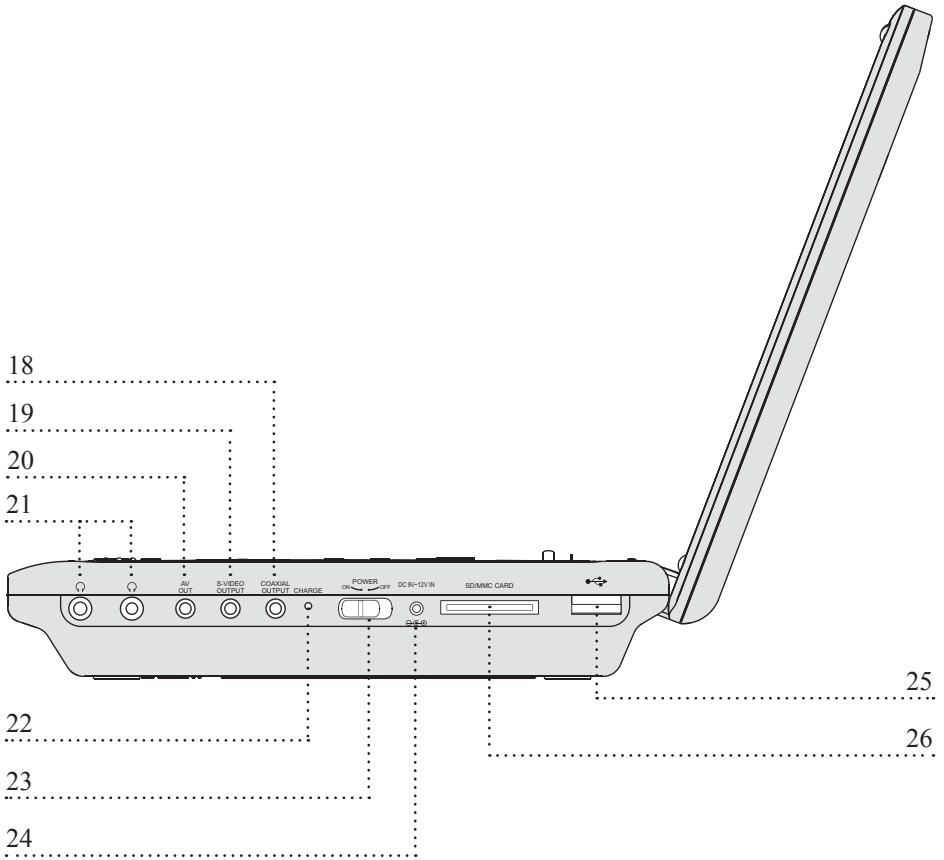

Control Definitions

- 14 TFT Display** The full-color TFT Display is a 8 inch display. The brightness, contrast, hue, and saturation of the TFT Display can be adjusted in the *DVD Setup Menu*.
-
- 15 Infrared Receiver** The Infrared Receiver receives signals sent from the remote control.
-
- 16 Power Indicator** The Power Indicator lights when the unit is turned on.
-
- 17 Battery Compartment** The Battery Compartment holds a Lithium Polymer Battery that powers the unit when charged. The battery can be charged by plugging the unit into an AC or DC power source using the included adapters.
-
- 18 Coaxial Audio Output** Use the Coaxial Audio Output to play audio from the unit on a connected stereo system. (Requires a Coaxial - 3.5MM Cable, not included)
-
- 19 S-Video Output** Use the S-Video Output connection to send a higher quality standard video signal to the TV. (Requires an S-Video - 3.5MM Cable, not included)
-
- 20 Audio & Video Output** Use the Audio & Video Output to play audio or video from the unit on an external system. (Requires an RCA - 3.5 MM Cable, not included)
-
- 21 Headphone Output 1 & 2** Use the Headphone Output 1 & 2 to listen to the unit through a set of headphones. (Requires Headphones, one set included)
-
- 22 Charge Indicator** The Charge Indicator blinks when the unit's internal battery is being charged. The Charge Indicator remains lit, without blinking, when the battery is fully charged.
-
- 23 Power Switch** Adjust the Power Switch to turn the unit off and on.
-
- 24 DC Power Input (9V - 12V)** Connect the DC Power Input to power the unit and charge the internal battery. (AC Adapter & DC Car Adapter included)
-
- 25 USB Input** Use the USB Input to connect a USB Thumb Drive to the unit. Media stored on the USB Thumb Drive can be played on the unit by switching to USB mode.
-
- 26 SD/MMC Memory Card Slot** The SD/MMC Memory Card Slot accepts SD and MMC memory card formats. Media stored on a loaded memory card can be played on the unit by switching to SD mode.
- *The unit will only play some mainstream audio, AVI, JPG, and JPEG formats from SD or MMC Memory Cards.*
-

Location of Controls

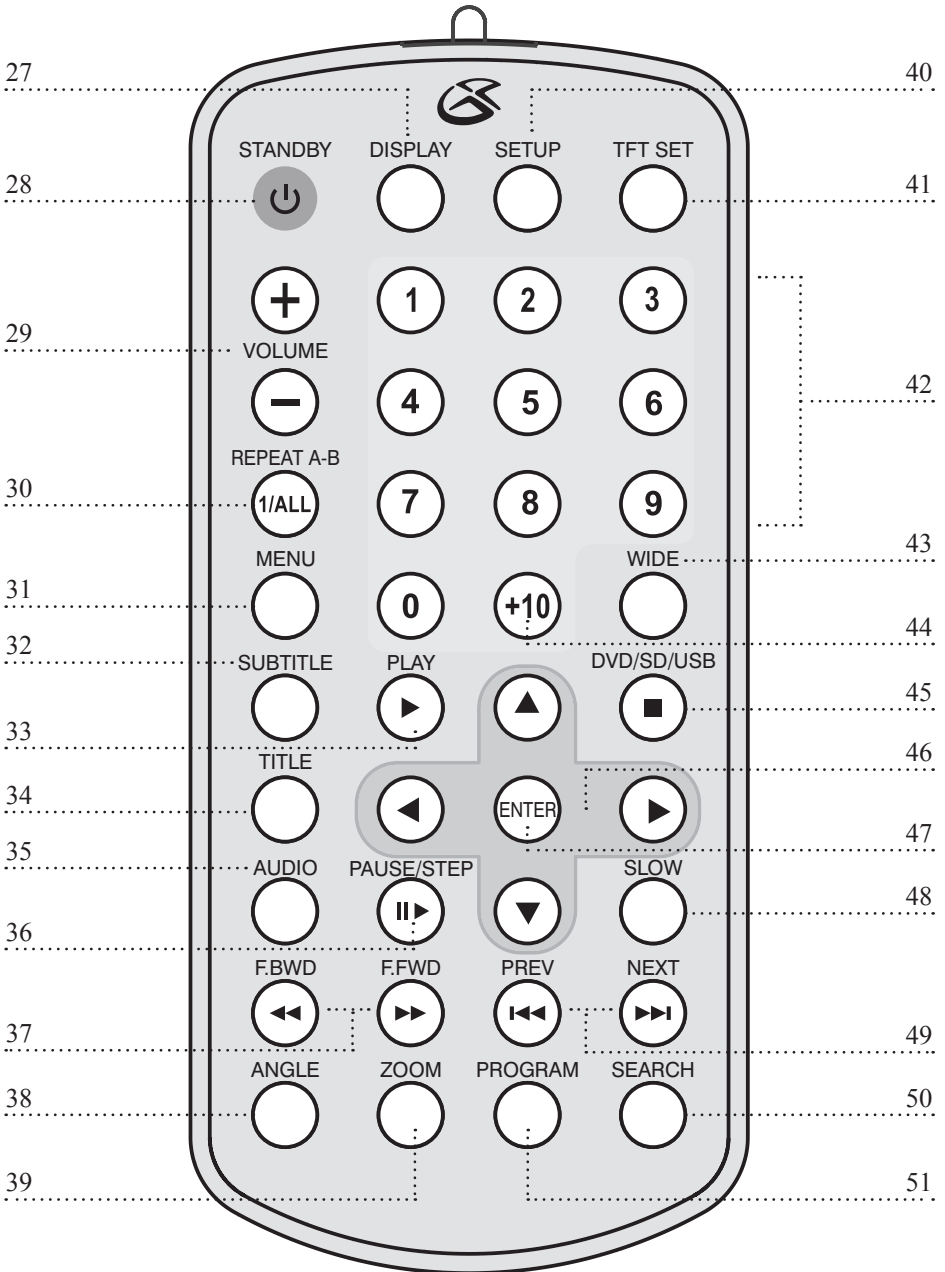

Control Definitions

- 27 Display Button** In CD or DVD Mode, press the Display Button to view the track or title and chapter information, as well as the play time.
-
- 28 Standby Button** Press the Standby Button to turn the unit off and on.
-
- 29 Volume Buttons** Press the Volume Buttons to increase or decrease the volume.
-
- 30 A-B Repeat Button** When playing a DVD, press the A-B Repeat Button once to designate an “A” point. Press the A-B Repeat Button a second time to designate a “B” point and repeat the section of DVD movie between point “A” and point “B”. When playing a CD, press the Repeat Button once to repeat an individual track of a CD. Press the Repeat Button twice to repeat an entire CD.
-
- 31 Menu Button** Press the Menu Button in DVD Mode to access a DVD’s main menu.
-
- 32 Subtitle Button** In DVD Mode, press the Subtitle Button to cycle through available subtitle options for a specific DVD.
-
- 33 Play Button** Press the Play Button to play a loaded CD or DVD.
-
- 34 Title Button** In DVD Mode, press the Title Button to view the title screen on a DVD.
- *The Title Button will only work with compatible DVDs.*
-
- 35 Audio Button** In DVD Mode, press the Audio Button to cycle through available audio languages for a specific DVD.
-
- 36 Pause & Step Button** In DVD Mode, press the DVD Pause & Step Button once to pause a DVD during play. Press the DVD Pause & Step Button consecutively to skip one frame at a time while playing a DVD.
-
- 37 Rewind & Fast Forward Buttons** Press the Rewind & Fast Forward Buttons to rewind or fast forward through a CD track or DVD movie.
-
- 38 Angle Button** In DVD Mode, press the Angle Button to view alternate angles.
- *The Angle Button will only work with compatible DVDs.*
-
- 39 Zoom Button** In DVD Mode, press and hold the Zoom Button to zoom in and out during a DVD movie.
-
- 40 Setup Button** In DVD Mode, press the DVD Setup Button to access the DVD Setup Menu.
-
- 41 TFT Set Button** Press the TFT Set Button to adjust the Contrast, Brightness, or Color of the TFT Display.
-
- 42 Number Keypad** Use the Number Keypad when entering numbers in for operations.
-

Control Definitions

- 43 Wide Button** In DVD Mode, press the Wide Button to switch between a 4:3 viewing ratio and a 16:9 (wide screen) viewing ratio.
-
- 44 +10 Button** Press the +10 Button when entering numbers greater than 10.
-
- 45 Function Button (DVD/SD/USB)/ Stop Button** Press the Function Button to switch between DVD, SD, and USB mode. Press the Stop Button to stop a CD or DVD during play.
-
- 46 Directional Buttons** Use the Directional Buttons to navigate through a DVD or CD.
-
- 47 Enter Button** Press the Enter Button to select media on a DVD or CD.
-
- 48 Slow Button** In DVD Mode, press the Slow Button to view a DVD movie in slow motion.
-
- 49 Previous & Next Buttons** Press the Previous & Next Buttons to skip backwards and forwards through CD tracks, and DVD chapters.
-
- 50 Search Button** In *DVD Mode*, press the Go To Button to type in, using the Number Keypad, a specific title and chapter number or DVD time, and go to that spot on the DVD immediately.
-
- 51 Program Button** In CD or DVD Mode, press the Program Button to program tracks or chapters and titles to play in a designated order. (See the Operations section for instructions on Programming a CD or DVD)
-



Service Information

Address 2116 Carr Street, St. Louis MO, 63106

Phone 1-314-621-2881

Fax 1-314-588-1805

Email prodinfo@gpx.com

Website www.gpx.com

To download this Instruction Manual in English, Spanish, or French visit the Support section at www.gpx.com.

Para descargar este manual de instrucción en inglés, español, o francés visite la sección de la ayuda en www.gpx.com.

Pour télécharger ce manuel d'instruction en anglais, espagnol, ou le Français visitez la section de soutien à www.gpx.com.
