

Model XK-1

Thank you, and congratulations on your choice of a Hammond XK-1.

In order to get the most out of this instrument for many years to come, first take the time to read this manual in full.

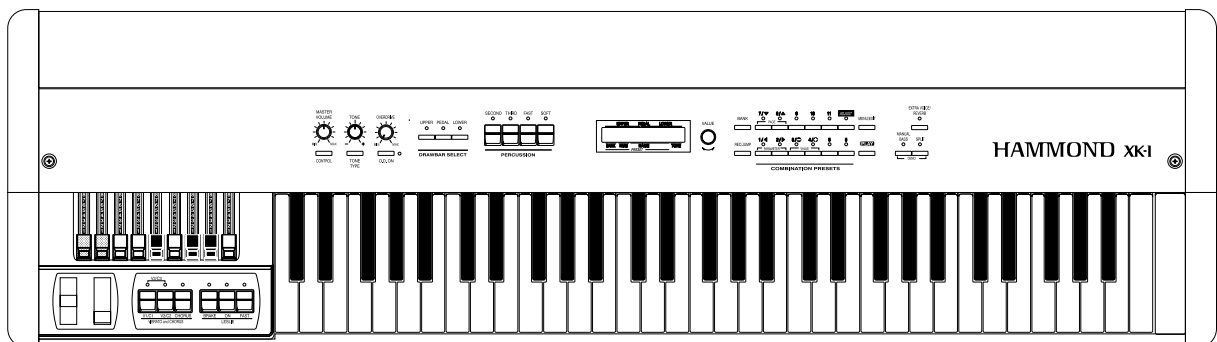

Owner's Manual

IMPORTANT SAFETY INSTRUCTIONS

Read these instructions.

Keep these instructions.

Heed all warnings.

Follow all instructions.

Do not use this apparatus near water.

Clean only with dry cloth.

Do not block any ventilation openings.

Install in accordance with the manufacturer's instructions.

Do not install near any heat sources such as radiators, heat registers, stoves or other apparatus (including amplifiers) that produce heat.

Do not defeat the safety purpose of the polarized or grounding-type plug. A polarized plug has two blades with one wider than the other. A grounding type plug has two blades and a third grounding prong. The wider blade or third prong is provided for your safety. If the provided plug does not fit into your outlet, consult an electrician for replacement of the obsolete outlet.

Protect the power cord from being walked on or pinched, particularly at plugs, convenience receptacles, and the point where they exit from the apparatus.

Only use attachments/accessories specified by the manufacturer.

Use only with the cart, stand, tripod, bracket, or table specified by the manufacturer, or sold with the apparatus. When cart is used: use caution when moving the cart/apparatus combination to avoid injury from tip-over.

PORTABLE CART WARNING



S3125A

Unplug this apparatus during lightning storms, or when unused for long periods of time.

Refer all servicing to qualified service personnel. Servicing is required when the apparatus has been damaged in any way, such as power-supply cord or plug is damaged, liquid has been spilled or objects have fallen into the apparatus, the apparatus has been exposed to rain or moisture, does not operate normally, or has been dropped.

Apparatus shall not be exposed to dripping or splashing and no objects filled with liquids, such as vases, shall be placed on the apparatus.

WARNING: To reduce the risk of fire or electric shock, do not expose this apparatus to rain or moisture.



注意 : 感電の恐れあり キャビネットをあけるな

ATTENTION : RISQUE DE CHOC ELECTRIQUE NE PAS OUVRIIR

WARNING : TO REDUCE THE RISK OF FIRE OR ELECTRIC SHOCK,
DO NOT EXPOSE THIS APPLIANCE TO RAIN OR MOISTURE.



The lightning flash with arrowhead symbol within an equilateral triangle, indicates that dangerous voltage constituting a risk of electric shock is present within this unit.



The exclamation point within equilateral triangle, indicates that there are important operating and maintenance instructions in the literature accompanying this unit.



In case if in the future your instrument gets too old to play/use or malfunctions beyond repair, please observe the instructions of this mark, or, if any question, be sure to contact your dealer or your nearest town or municipal office for its proper disposal.



FOR UNITED KINGDOM:

FOR YOUR SAFETY, PLEASE READ THE FOLLOWING TEXT CAREFULLY

This appliance is supplied with a molded 3-pin mains plug for your safety and convenience.

A 5 amp fuse is fitted in this plug.

Should the fuse need to be replaced, please ensure that the replacement fuse has a rating of 5 amps and that it is approved by ASTA or BSI to BS11362.

Check for the ASTA mark  or the BSI mark  on the body of the fuse.

If the plug contains a removable fuse cover, you must ensure that it is refitted when the fuse is replaced.

If the fuse is lost, the plug must not be used until a replacement cover is obtained.

A replacement fuse cover can be obtained from your local Hammond Dealer.

IF THE FITTED MOULDED PLUG IS UNSUITABLE FOR THE SOCKET OUTLET IN YOUR HOME, THEN THE FUSE SHOULD BE REMOVED AND THE PLUG CUT OFF AND DISPOSED OF SAFELY.

THERE IS A DANGER OF SEVERE ELECTRICAL SHOCK IF THE CUT-OFF PLUG IS INSERTED INTO ANY 13 AMP SOCKET.

If a new plug is to be fitted please observe the wiring code as shown below.

If in any doubt, please consult a qualified electrician.

IMPORTANT - The wires in this mains lead are coloured in accordance with the following code:

Blue:	Neutral
Brown:	Live

As the colours of the wires in the mains lead of this unit may not correspond with the coloured marking identifying the terminals in your plug, proceed as follows.

The wire which is coloured BLUE must be connected to the terminal in the plug which is marked with the letter N or coloured BLACK.

The wire which is coloured BROWN must be connected to the terminal in the plug which is marked with the letter L or coloured RED.

Under no circumstances should either of these wires be connected to the earth terminal of the three-pin plug, marked with the letter E or the Earth Symbol .

How to replace the fuse. Open the fuse compartment with a screwdriver and replace the fuse and fuse cover.

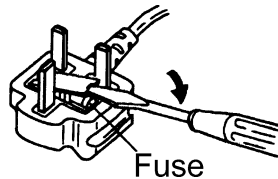

IMPORTANT - PLEASE READ

Your Hammond XK-1 Drawbar Keyboard is designed to give you the true and authentic sound of Hammond Harmonic Drawbars, as well as provide you a large variety of features to allow great flexibility in how you want to use the keyboard. This Owner's Manual is designed to explain the operating features of your Hammond XK-1 as simply and graphically as possible.

Because we want to make this manual, as well as the keyboard itself, as easy to understand as possible, the explanations in this manual are grouped by subject matter, and not in the order in which they necessarily appear in the display (the screen in the left of the keyboard front panel). For example, all functions pertaining to Drawbars are grouped together, all Percussion features are treated as a group, and so on.

Also, each feature is treated as an explanation unto itself, and does not require you to already have prior working knowledge of some other feature. The explanations are presented such that, if you follow the steps, will be identical to that shown in the manual at that stage of the explanation.

Do not be daunted by the number of steps required to perform each operation. Each step is simple. Simply bear these things in mind:

1. Read each step carefully.
2. Don't skip any of the steps.
3. Don't perform the steps out of sequence.

With these guidelines, you are well on your way to mastering all of the many sounds and features of your Hammond XK-1.

BATTERY BACK UP

Your XK-1 uses a battery-backed RAM to remember your changes to the Parameters. When the battery voltage becomes low, the Display will show:

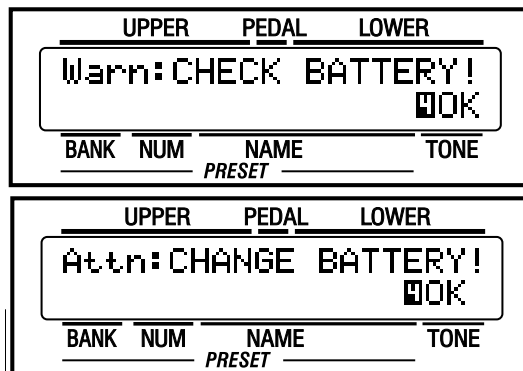

If you see these messages, you should immediately back up your parameter changes, if you have made any. If there is no battery installed in the unit, or if the battery is completely dead, the Display will show:

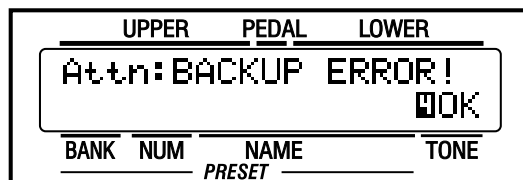

After the above message is displayed, the XK-1 will re-initialize itself, and the factory default settings will be restored. Therefore, it is a good idea to periodically save your data to CompactFlash card.

CAUTION: In order to change batteries, be sure to ask your dealer or store.

Table Of Contents

IMPORTANT SAFETY INSTRUCTIONS	2
IMPORTANT - PLEASE READ	4
BATTERY BACK UP	5
MAIN FEATURES	9
NAMES AND FUNCTIONS	10
Front Panel	10
End Block	12
Rear Panel	13
HOOK-UP	15
BASIC HOOK-UP	16
CONNECTING THE LESLIE SPEAKER	17
STANDARD HOOK-UP	17
USING MIDI CONTROL	17
CONNECTING THE MIDI KEYBOARD	18
TURN ON AND PLAY	19
POWER ON	20
HOW TO POWER ON	20
BACK-UP	20
RESET TO THE FACTORY SETTINGS	20
LISTEN TO THE DEMONSTRATION PERFORMANCE	21
USING THE COMBINATION PRESETS	22
HOW TO RECALL THE PRESETS	22
1. Selecting preset BANK	22
2. Selecting preset NUMBER	22
PLAY WITH THE CONTROLLERS	23
PITCH BEND WHEEL	23
EXPRESSION PEDAL	23
FOOT SWITCH	23
MAKING YOUR OWN SOUNDS	24
TOUCH THE DRAWBAR SELECT [UPPER]	24
SELECT THE PRESET BUTTON [ADJUST]	24
PULL OUT THE DRAWBARS	24
ADD PERCUSSION	24
ADD EFFECTS	25
VIBRATO/CHORUS	25
OVERDRIVE	25
LESLIE	25
USING EXTRA VOICES	25
Divide the keyboard into two parts - left and right. [SPLIT]	26
Add bass part on the manual keyboard. [MANUAL BASS]	26
What is "Part"?	26
STORING REGISTRATIONS IN COMBINATION PRESET	27
EX. Memorize to "6 - 3".	27
SETTING UP	29
SOUND ENGINE STRUCTURE	30
SYSTEM STRUCTURE OF XK-1 KEYBOARD	30
DRAWBARS™	32
WHITE DRAWBARS	33
BLACK DRAWBARS	33
BROWN DRAWBARS	33
PEDAL DRAWBARS	33
DRAWBAR REGISTRATION PATTERNS	34
DRAWBAR SELECT	36
ASSIGN THE DRAWBARS FOR EACH PART	36
MATCH THE REGISTRATION TO DRAWBARS	36
PERCUSSION	37
NOTES	37
"Percussion does not sound!"	37
DRAWBAR CANCEL	37
VIBRATO/CHORUS	38
OVERDRIVE	39
LESLIE	40
EQUALIZER & REVERB	41
EQUALIZER	41
REVERB	41
COMBINATION PRESETS	42
BANK AND NUMBER	42
NAME THE COMBINATION PRESETS	43
RECORD A NEW THE COMBINATION PRESET	44
USING THE CONTROL PANEL	45
OPERATION CONTROL PANEL	46
PLAY MODE	47
HOW TO READ THE DISPLAY	47
MENU MODE	48
HOW TO READ THE DISPLAY	48
BUTTON OPERATION IN THIS MENU	48
FUNCTION MODE	49
HOW TO READ THE DISPLAY	49
BUTTON OPERATION IN THIS MODE	49
Example of operation	50
SHORT CUT TO THE FUNCTION MODE	52
Example of operation	52
STORING THE PAGE YOU FREQUENTLY USE	52
Example of operation	52

SETTING THE PARAMETERS	53
DRAWBAR	54
◆ Setting the Manual (LOWER and UPPER)	54
◆ Setting the PEDAL	55
PRESET	56
◆ PRESET NAME	56
◆ PRESET LOAD	56
EFFECTIVE USE OF LINK-LOWER/PEDAL	57
WHEN LINK LOWER/PEDAL IS ON:	57
WHEN LINK LOWER/PEDAL IS OFF:	57
CONTROL	58
◆ PITCH BEND	58
◆ MODULATION	59
◆ EXPRESSION	59
◆ FOOT SWITCH	60
◆ EXTRA VOICE / REVERB	61
◆ DISPLAY	61
ADJUSTING THE EXPRESSION PEDAL	62
TUNE	63
CUSTOM TONEWHEELS	64
PERCUSS (PERCUSSION)	65
LESLIE	66
◆ CABINET NUMBERS	66
◆ LESLIE PARAMETERS	66
RECORD THE CABINETS	68
OD/VIB (OverDrive / VIBrato)	69
◆ OVERDRIVE	69
◆ VIBRATO/CHORUS	69
EQUALIZ (EQUALIZer)	70
REVERB	71
DEFAULT	72
SYSTEM	73
EXVOICE (EXtra VOICE)	74

MIDI	75
MIDI	76
What is "MIDI"?	76
MIDI TERMINALS ON THIS KEYBOARD	76
WHAT THE MIDI CAN DO ON YOUR KEYBOARD	76
MIDI CHANNEL	77
MAJOR MIDI MESSAGE	77
CHANNEL MESSAGE	77
SYSTEM MESSAGE	77
MIDI STRUCTURE OF THIS KEYBOARD	78
◆ KEYBOARD CHANNEL	78
◆ EXTERNAL ZONE CHANNEL	78
EXPANDING THE KEYBOARD	79
RECORDING AND PLAYING	80
◆ Recording to the Sequencer or the Computer	80
◆ Playback from the Sequencer or the Computer	80
CONTROLLING THE EXTERNAL MIDI EQUIPMENTS	81
ZONES	82
◆ INTERNAL ZONE	82
◆ EXTERNAL ZONE	82
MIDI	84
◆ MIDI TEMPLATE	84
◆ MASTER	84
◆ KEYBOARD CHANNEL	85
TROUBLE SHOOTING	87
TROUBLE SHOOTING	88
APPENDIX	89
Custom Tone-wheel	90
MIDI Templates	91
Part and MIDI Messages	93
MIDI Information	94
Drawbar Data List	95
System Exclusive Message	96
Global Parameters	97
Bank Parameters	97
Preset Parameters	98
Leslie Parameters	100
System Parameters	100
Combi. and Bank/Program Messages	101
Specifications	102
Demonstration Songs and Composers	103
Factory Presets	104
SERVICE	107

IN THIS MANUAL:

NOTE:s and **tips** appear frequently.

The **NOTE**: is a supplementary explanation.

The **tips** are explanations of terms and applications.

◆ **ACCURATELY REPRODUCES THE TONE-WHEEL SOUND.**

Your new XK-1 contains (96) independent oscillating digital tone-wheels and accurately reproduces the sound of the Vintage B-3.

In addition, this keyboard has full polyphony.

◆ **DIGITAL LESLIE / VIBRATO EFFECTS.**

The XK-1 keyboard is equipped with a DSP effect generator to simulate the Scanner-Vibrato and Leslie Speaker.

The range of sounds that you can create is expanded by the use of Vibrato and Chorus effects, and by the real sounding Leslie effects which effectively simulates the rotation of the two Rotors which are present in traditional Leslie.

◆ **8-PIN LESLIE SPEAKER SOCKET.**

Your new XK-1 contains a 8-pin Leslie speaker socket for direct connection to Leslie 21 System Speakers.

◆ **BUILT-IN EXTRA VOICE.**

This keyboard has built-in 8 Extra Voices such as Electric Piano and Clavi., to which you can switch from Drawbar voices or Percussion voices.

◆ **CAN BE EXPANDED BY USE OF EXTERNAL MIDI PRODUCTS.**

You can expand your keyboard by connecting and playing with additional external MIDI equipment. This includes keyboards, sequencers, etc.

◆ **LIGHT WEIGHT AND COMPACT BODY.**

The XK-1 is light and compact, but sounds and functions like deluxe model.

Front Panel

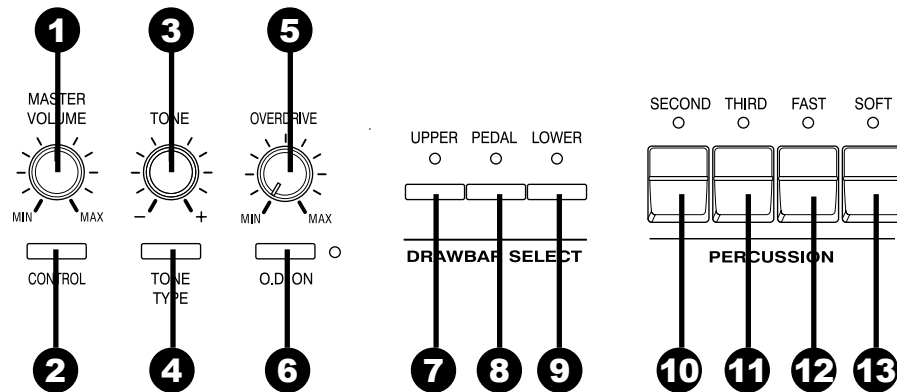

◆ UPPER LEFT

1. MASTER VOLUME Knob

Controls the total volume.

2. CONTROL Button

Sets up various controls.

3. TONE Knob

Controls the tone quality.

4. TONE TYPE Button

Assigns the function of TONE CONTROL (3).

5. OVERDRIVE Knob

Controls the distortion of the Upper and Lower part.

6. O.D. ON Button

Switches the overdrive effect On / Off.

◆ DRAWBAR SELECT

7. UPPER Button**8. PEDAL Button****9. LOWER Button**

These buttons select which part of the registration. The drawbars(27) will be active.

◆ PERCUSSION

10. SECOND Button

Adds 4' Percussion (Decay sound) to UPPER part.

11. THIRD Button

Adds 2 2/3' Percussion (Decay sound) to UPPER part.

12. FAST Button

Changes Decay time of Percussion.

13. SOFT Button

Changes Percussion volume.

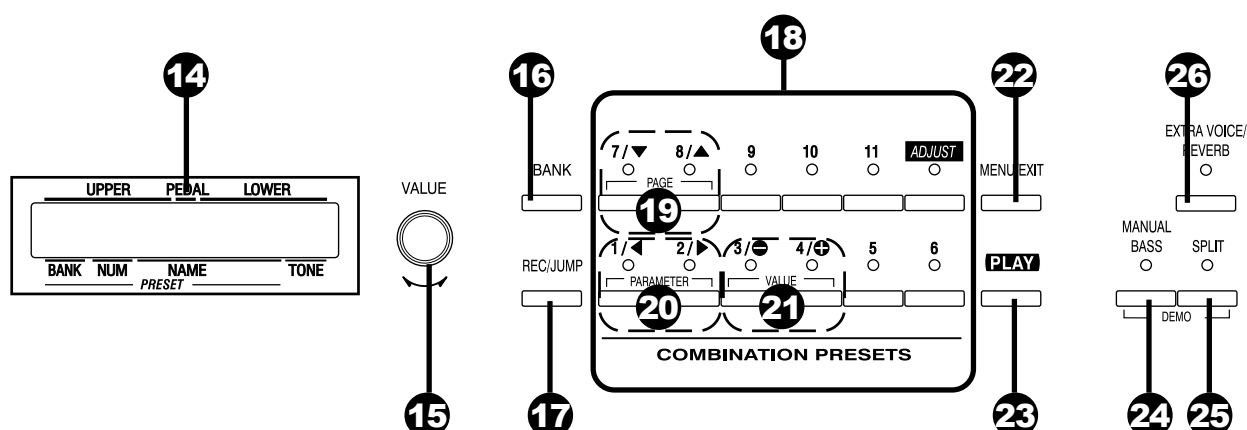

◆ CONTROL PANEL

14. DISPLAY

Displays various information.

15. VALUE Knob

Adjusts the value of selected parameter.

16. BANK Button

Selects the BANK of the Combination Presets. To select the bank, Touch a Combination Preset button while holding the BANK button.

17. REC/JUMP Button

Records Presets. This is also used to allow you to quickly page through the various choices within each function.

18. Combination Presets

Select the NUMBER of the Combination Preset. These buttons are also used for the PAGE, PARAMETER and VALUE functions listed below.

19. PAGE Buttons

Selects Pages in the menu.

20. PARAMETER Buttons

Selects Parameters.

21. VALUE Buttons

Increases and decreases the value of selected parameter.

22. MENU/EXIT Button

Recalls the MENU screen. This is also used to return from each function screen.

23. PLAY Button

Jumps to the PLAY screen, the basic screen.

◆ UPPER RIGHT

24. MANUAL BASS Button

Allows Pedal sound to be played from the lowest notes on the manual keyboard.

25. SPLIT Button

Divides the keyboard into two parts: UPPER and LOWER.

26. EXTRA VOICE / REVERB Button

Switches On / Off the Extra Voice, Reverb effect etc. (assignable)

End Block

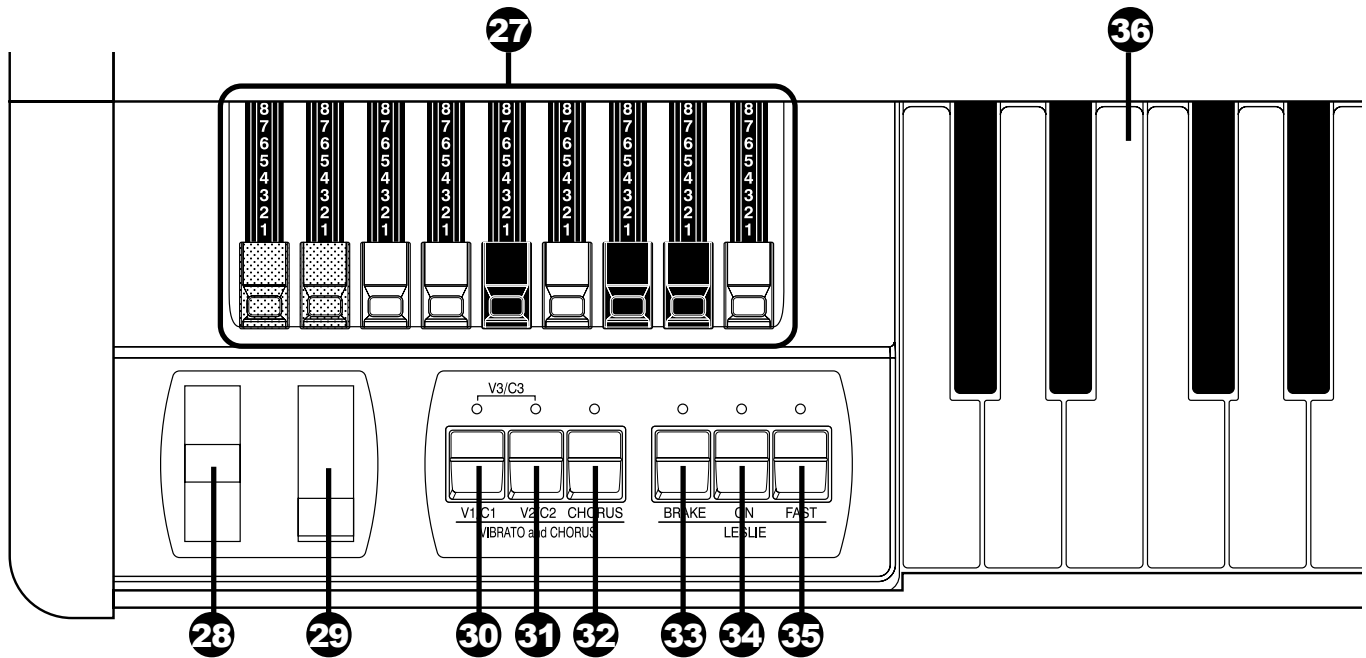

◆DRAWBARS

27. DRAWBARS

Controls harmonics of part that is selected by DRAWBAR SELECT (7 - 9). The setting of the Drawbars is called a “Registration”.

◆WHEEL

28. PITCH BEND Wheel

Slides the pitch up or down.

The pitch goes up when moved up, and goes down when moved down.

29. MODULATION Wheel

On this keyboard, this is used mainly to send MIDI information to connected MIDI equipment, to add effect to Extra Voice.

◆VIBRATO/CHORUS

30. V1/C1 Button**31. V2/C2 Button**

Controls the depth of Vibrato / Chorus Effects on the Upper and Lower parts. V1 is light effect, V2 is medium, and the V3 (both V1 and V2 are On) is heavy.

32. CHORUS Button

Switch from Vibrato or Chorus effect. When the LED is ON, the Chorus effect is “ON”.

◆LESLIE

33. LESLIE BRAKE Button

This button selects whether to produce sound from the stopped rotor (=Brake) or not to use the Leslie effect (=Through) when the LESLIE ON(34) Button is “Off”. Brake is ON when the LED is on.

34. LESLIE ON Button

When it is turned ON, the rotor turns and the sound come from the Rotor.

When the lamp is lighting, it is “ON”.

35. LESLIE FAST Button

Changes the speed of the Rotor from Slow to Fast. It is FAST when the LED is ON.

◆KEYBOARD

38. MANUAL KEYBOARD

This keyboard contains 61 waterfall shaped keys. Keyboard is velocity sensitive.

Rear Panel



◆ POWER SUPPLY

37. AC Inlet

Connects the A.C. Power Cable.

38. POWER Switch

This switches on and off the keyboard.

◆ SOUND OUTPUT TERMINAL

39. LINE OUT L/MONO Jack

If your amplifier has only a single (1) female 1/4" audio input connector (MONO input), use this Jack.

40. LINE OUT R Jack

This is the Right channel output of the XK-1.

Use the Left and Right output Jacks if your mixer or amplifier has stereo input.

Use only the L/MONO terminal, if the input is monaural.

The built-in Leslie Effect is only on L (the left), when the Leslie Speaker (42) is connected.

41. HEADPHONE Jack

This is for connecting a stereo headphones.

Sound is sent out from the LINE-OUTS (39, 40) and LESLIE 8PIN (42), also when this terminal is used.

The built-in LESLIE is only on L (the left), when the LESLIE SPEAKER (42) is connected.

42. LESLIE 8PIN Jack

This is for connecting the Leslie 21 System Speaker. Read "CONNECTING THE LESLIE SPEAKER" for more details.

XK-1

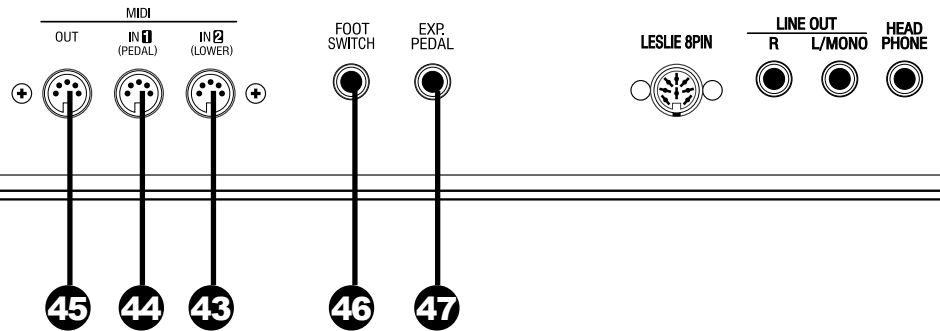

◆ MIDI TERMINAL

43. MIDI IN 1 (PEDAL) Jack

Sends out the performance information of this keyboard.

44. MIDI IN 2 (LOWER) Jack

This is the MIDI IN Terminal used mainly for the Pedal Keyboard.

[The factory setting] The MIDI information received by channel. You can set that through this terminal functions as PEDAL, regardless of the channel.

45. MIDI IN 2 (LOWER) Jack

This is the MIDI IN Terminal used mainly for the Lower Keyboard.

[The factory setting] The MIDI information received by channel. You can set that through this terminal functions as LOWER, regardless of the channel.

◆ CONTROLLER TERMINAL

46. FOOT SWITCH Jack

This terminal is for the Foot Switch (FS-9H - optional). You can switch the speed of the Leslie effect and the Combination Preset, etc. while playing.

47. EXP. PEDAL Jack

This terminal is for the Expression Pedal (V-20R - optional.)

You can control the volume while you play.

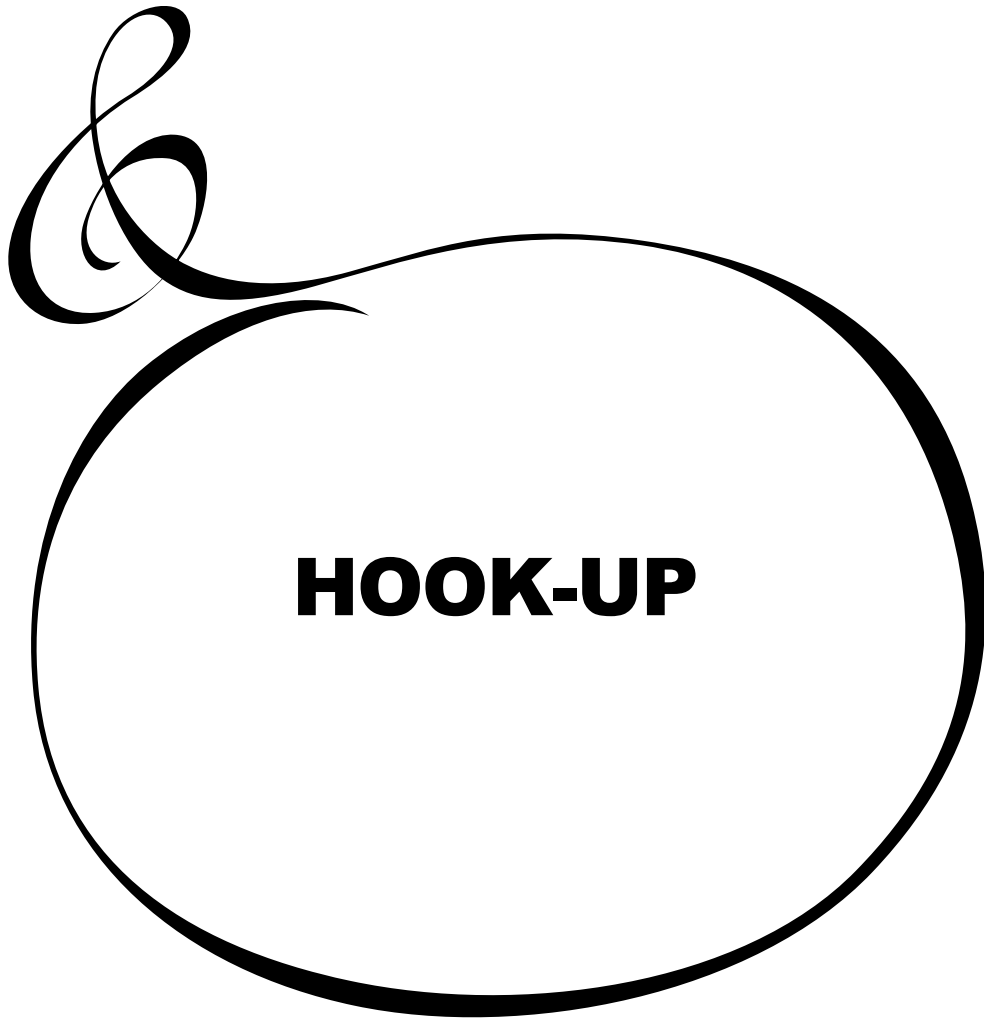

BASIC HOOK-UP

See the figure below for connection.

Amplifiers or speakers are not mounted in this keyboard.

You must connect an external amplifiers and speakers (or Powerd Speaker) in order to hear the keyboard sounds.

You can also enjoy playing this keyboard by connecting Stereo Headphones to the Headphone Jack.

Be sure to make the connection with the Power OFF on this keyboard and all connected equipment.

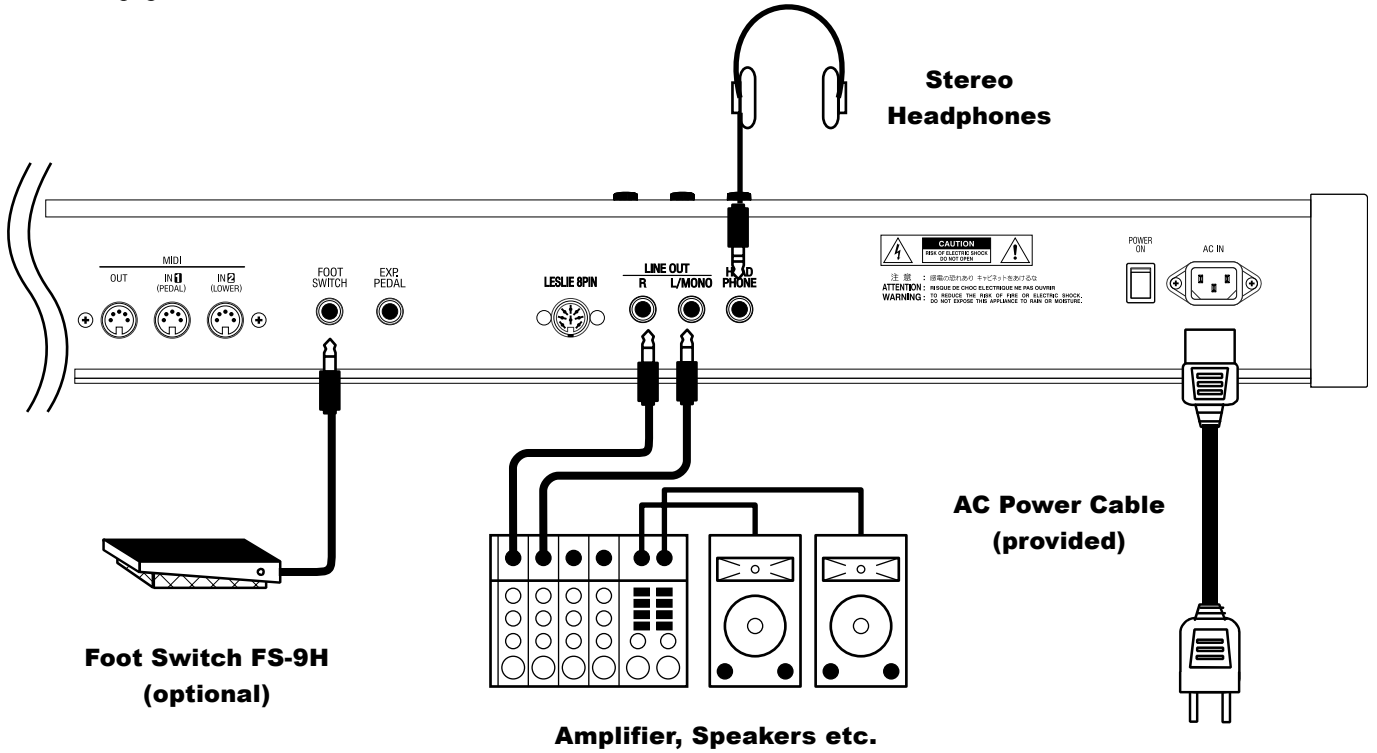

This keyboard is equipped with a 8-Pin Leslie Connector, so you can directly connect the Leslie 21 System Speaker.

❖ *Make this connection with switch power OFF on the equipment.*

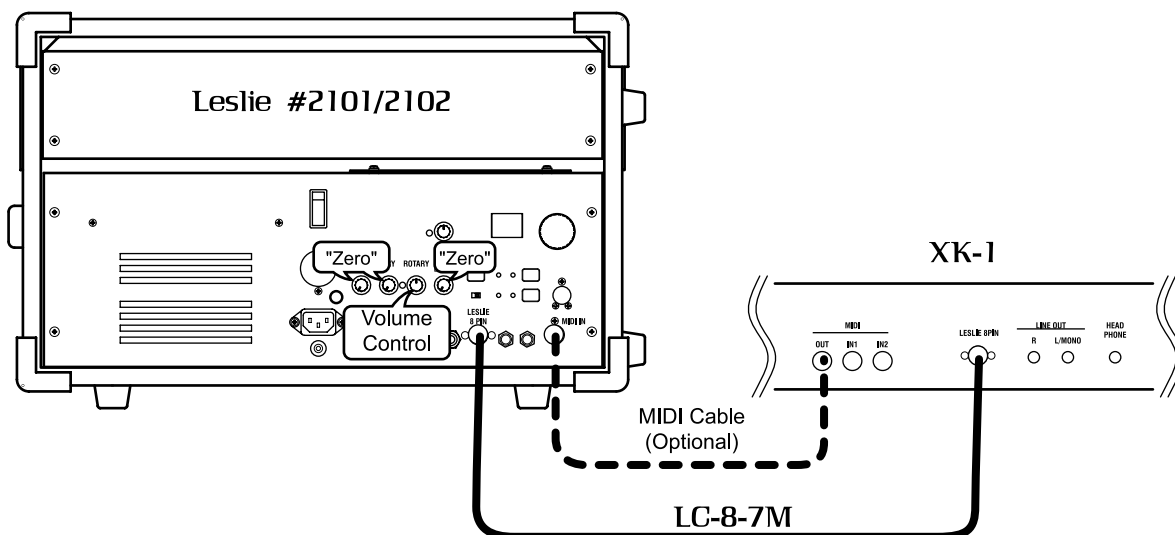

STANDARD HOOK-UP

Connect the Leslie Speaker to the 8-Pin Jack on the keyboard, with the exclusive 8-Pin Leslie Cable (LC-8-7M - to be separately purchased - with the other Leslie Speaker accessories).

Note: 8-Pin Jack is mouted. This keyboard can not use 11-pin Leslie speakers.

To control the volume of Leslie Speaker #2101/2102, use ROTARY Knob. Set the STATIONARY knob for minimum. Because this keyboard has 1 channel (rotary) audio circuit for the Leslie Speaker.

Please carefully read the User's Guide of the Leslie Speaker.

USING MIDI CONTROL

To control the parameters of the Leslie 21 System Speaker (i.e. finely adjust the rotor, rise time etc.) using this keyboard, follow below instructions;

1. Connect the MIDI OUT of this keyboard and MIDI IN of the Leslie Speaker by MIDI cable.
2. Set the Keyboard Channel - Upper of this keyboard and MIDI Channel of the Leslie Speaker to same channel. (P. 85)
3. Set the MIDI - Leslie Parameter to "21". (P. 84)

CONNECTING THE MIDI KEYBOARD

You can upgrade this keyboard to an organ by connecting an external MIDI Keyboard and pedal keyboard.

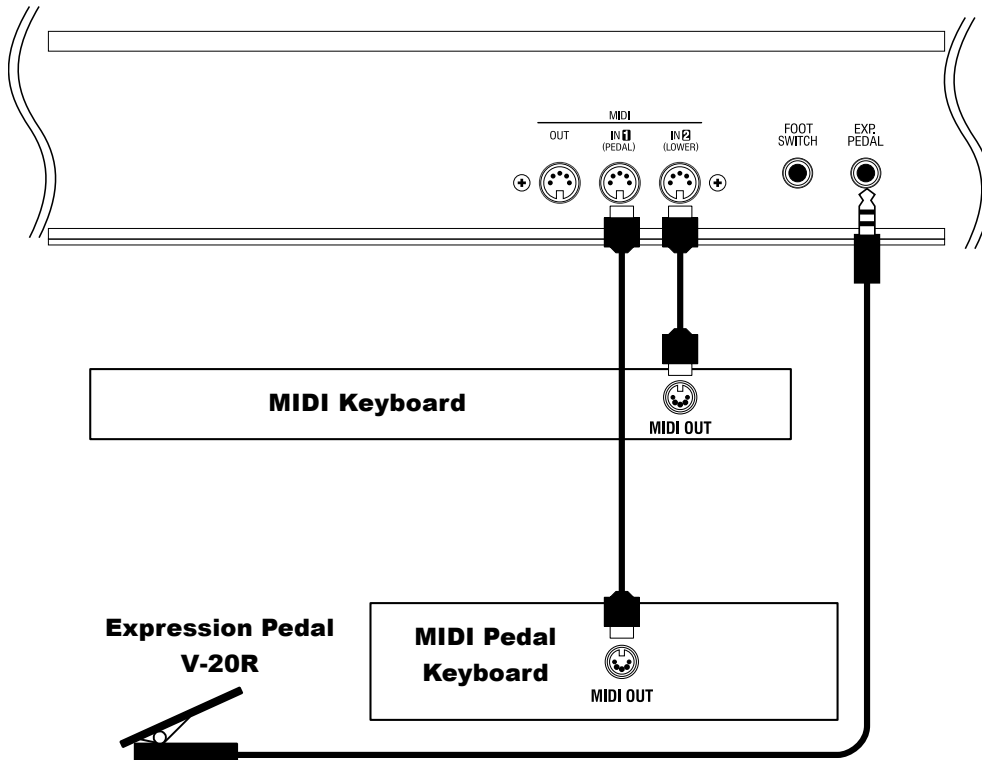

1. Hook-up external MIDI keyboard and pedal keyboard per the figure above.
2. Use the MIDI Template "Seq. Record" of this keyboard. (P. 84)
3. To use Expression Pedal, set the parameter "EXPRESSION SOURCE" for the model of expression pedal that you have connected. (P. 59)

The MIDI Keyboard connected to the PEDAL Terminal functions as the PEDAL (part), and the one connected to the LOWER Terminal as the LOWER (part).

Please also read the User's Guide of the connected MIDI Keyboard.

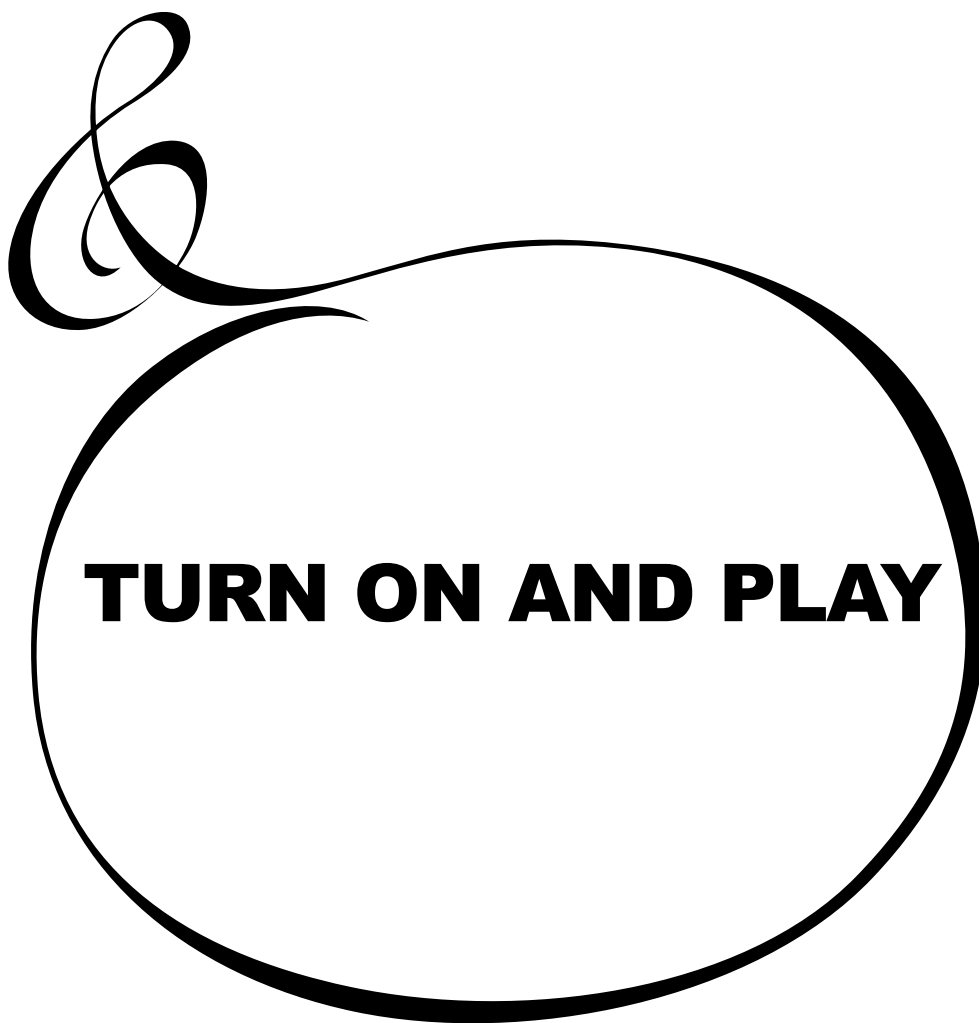

HOW TO POWER ON

After connecting your XK-1 to the power outlet, please perform the following steps before switching on the power. To avoid possible damages to speakers, please do not change the order of the steps.

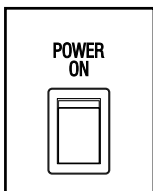
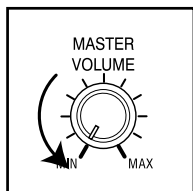

STEPS TO TAKE

1. Set the MASTER VOLUME Knob at 0 (minimum), before switching the power on.
2. Switch on the POWER on the rear panel. "PLAY" Mode appears, following the TITLE, in the Display window.
 - ❖ *It takes a few seconds before the XK-1 gets ready, because of the circuit-protection devices.*
3. Switch on the power of the amplifiers etc. connected to the XK-1.
4. Holding down a key, adjust the MASTER VOLUME by turning the Knob.
5. Adjust the volume of the amplifiers etc.
 - ❖ *Reverse the above steps when you switch off the power. (Switch off the power of the amplifiers etc. first.)*

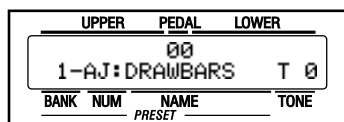

BACK-UP

Your XK-1 memorizes the setting of the keyboard immediately before it is switched off. So, The keyboard will start with these settings when it is switched on again. This is called "Back-up". The XK-1 is initially shipped from the factory with the Preset Button [ADJUST] in "pressed" status.

- ❖ *The Preset Button [ADJUST] does not produce sound when initially first turned on. Draw the left Drawbar(s), or press either of the Preset Buttons [2] - [11] to start.*

RESET TO THE FACTORY SETTINGS

Please perform the following steps to reset the XK-1 to the initial default setting.

STEPS TO TAKE

1. Switch off the power of the XK-1.
2. Hold the [REC/JUMP] Button, and switch on the power.
3. Continue to hold down / Keep pressing the [REC/JUMP] Button until "Loading Default..." appears on the Display.
4. After 5 seconds if everything is in order, PLAY Mode appears on the Display. (Completed)

In your XK-1, the demonstration performance is built in for introducing the features and sound.

STEPS

1

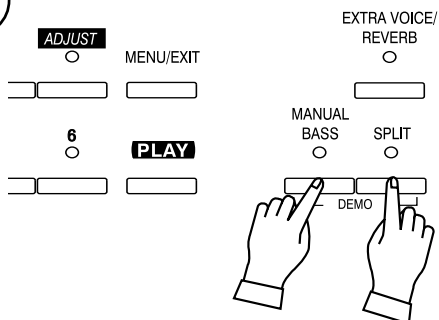

Touch and hold the [MANUAL BASS] and [SPLIT] Button for 2 seconds.

The Display will be as shown step 2.

NOTE: You can locate this mode another way. Touch the [MENU] Button to display the MENU, touch the [PAGE] Button and select page E, and touch the [2]DEMO.

2

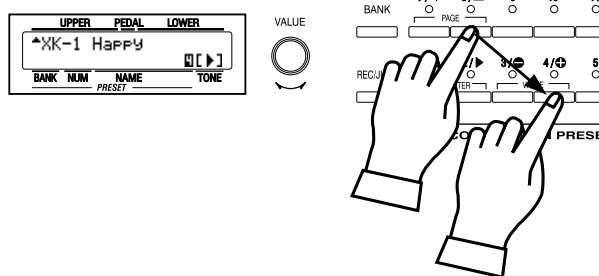

Press the [PAGE] Button and select a desired song.

The performance starts when the [4]“▶” Button is pressed.

NOTE: After the song is over, the next one starts automatically.

To select a new song while you are playing, touch the [4]“▶” Button again. The performance that is playing will stop.

NOTE: You can not operate the controllers while playing the demonstration, except [MASTER VOLUME], [LESLIE BRAKE], [LESLIE ON], [LESLIE FAST], and [VIBRATO & CHORUS].

3

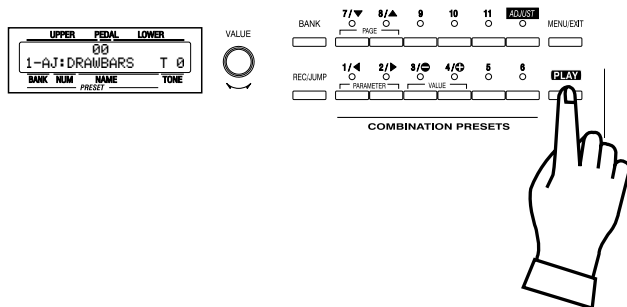

If you press the [MANUAL BASS] and [SPLIT](holding 2 seconds), [MENU/EXIT] or [PLAY] Button, the performance stops.

USING THE COMBINATION PRESETS

You can record various settings to the Preset Buttons mounted on the right-hand side of the XK-1. This is called "Combination Preset".

The Combination Preset consists of the "BANK" and the preset "NUMBER", and Such as "1 - 3" appears for each setting on the Display. The first letter is Bank and the

second is Number.

The Preset data is recorded in the Banks 1 to 12 at the factory. Thus you can start playing immediately.

Combination Presets

		Number											
		1	2	3	4	5	6	7	8	9	10	11	Ad
Bank	1												
	2												
	3												
	4												
	5												
	6												
	7												
	8												
	9												
	10												
	11												
	12												

The chart on the left is for the Combination Preset. The "BANK" is shown vertically (line) and the "NUMBER" horizontally (column). Select one combination from this chart and play.

"1 - ADJUST" is initially selected at the factory.

The example below recalls this.

NOTE: The Preset Button "1" creates no sound (, if combined) with any Bank in default. This is called "Cancel".

HOW TO RECALL THE PRESETS

EX. Select "6 - 8"

1

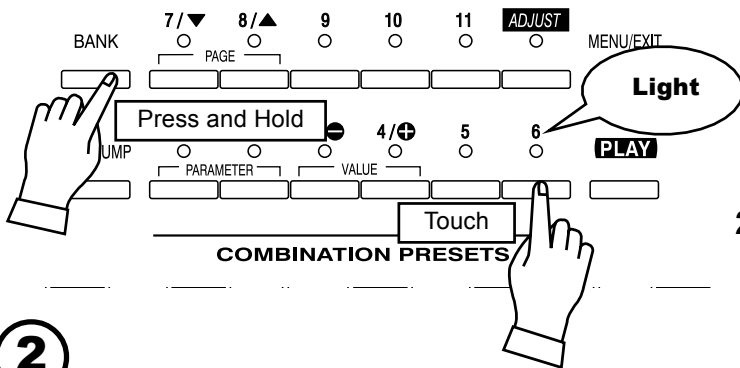

1. Selecting preset BANK

While holding down the [BANK] Button, touch the Preset Button [6].

NOTE: The LED for the Preset Button indicates the "BANK", while the [BANK] Button is pressed.

2

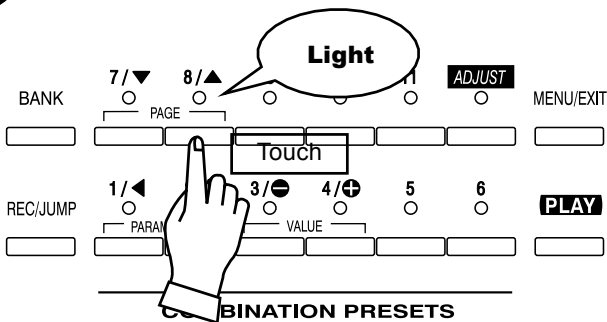

2. Selecting preset NUMBER

Touch the Preset Button [8].

At this time the Preset is selected and the setting changes.

NOTE: While the [BANK] Button is released, the LED indicates the "NUMBER".

"6 - 8" appears on the bottom left of the Display.

Recall various Combination Presets and play.

When you recall a Combination Preset, not only Drawbars but also the Effects such as Leslie and Reverb change altogether.

However, the BANK 12 of the factory setting changes only the Drawbars. This action is the same as on B-3 or C-3.

NOTE: You can set the types of the Parameter you recall. (P. 56)

Your performance will be more expressive, if you play using the controllers. You will see on this page how to use the controllers generally used with the electronic musical instruments. (How to use the exclusive Hammond Organ controllers is shown on the next page.)

PITCH BEND WHEEL

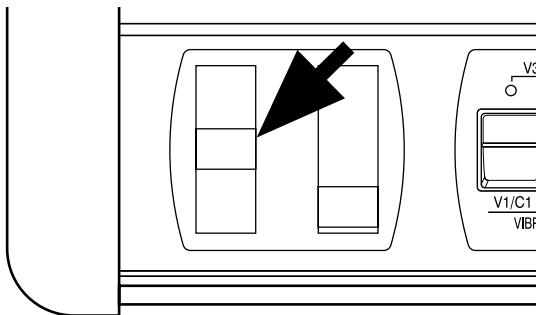

This is used to slide the pitch up or down while playing. The frequency goes up when you move it back, and it goes down when you move it forward.

When you release your hand from the PITCH BEND wheel, it returns automatically to the center position.

NOTE: You can adjust the value of the wheel change. (P. 58)

The [MODULATION WHEEL] on the right is not usually used. It is used when you transmit the modulation information to external MIDI equipment (P.83), or to add effect to Extra Voice (P. 74).

EXPRESSION PEDAL

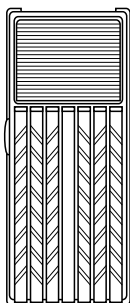

Fig.: V-20R (optional)

Generally, organs can not express dynamics or the velocity of the key touch. However, if you connect the Expression Pedal to the organ, you can express the velocity, corresponding to the degree of your foot-pressure on the pedal, and add intonation to make your music more expressive. [The Expression Pedal is to be separately purchased.]

The volume is loudest when you fully press down by means of your toe, and it is quietest when you fully press down by means of your heel.

NOTE: Set the parameter at “Expression source” for the model of expression pedal that you have conneted. (P. 59)

FOOT SWITCH



Fig.: FS-9H (optional)

This switch is used to operate and control the organ by your foot instead of pressing various switches by your hand while playing. [The Foot Switch is to be separately purchased.]

The initial factory assignment is “LESLIE FAST”.

NOTE: You can change the Foot switch assignment. (P. 60)

You will be able to freely produce your own sound by using the exclusive features of your HAMMOND ORGAN, such as Drawbars and Percussion sound, as well as Vibrato and the Leslie effects. The steps to take are as follows:

TOUCH THE DRAWBAR SELECT [UPPER]

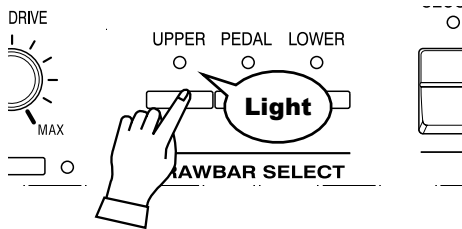

Select the button [UPPER] of Drawbar Select. These buttons allow to control the drawbar registration each Part by drawbars which are mounted on the left side of the keyboard.

Note: What is "Part"? (P. 26)

Touch the [UPPER] this time, it is mostly used.

SELECT THE PRESET BUTTON [ADJUST]

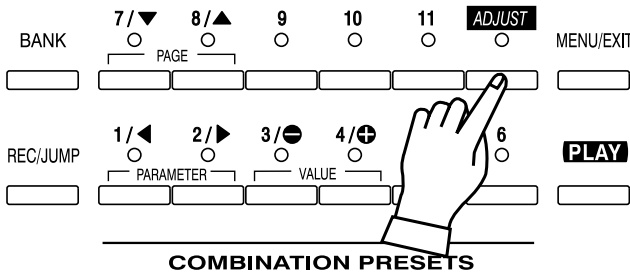

Select the Preset Button [ADJUST].

This is a special button, also called "Adjust Preset". While this button is selected, your setting is always memorized, and the Drawbar registration on the panel (= the length of the Drawbars) always corresponds with the internal registration.

NOTE: You can initialize the contents to the default setting. (P. 72)

PULL OUT THE DRAWBARS

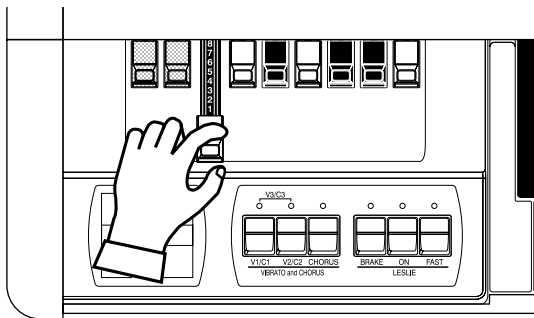

Pull out the Left Drawbars on the left-hand side to your desired length, while pressing a key on the keyboard.

The tone varies corresponding to the extent or the length of the Drawbar. So it is the Drawbars that make the fundamental tones of this keyboard.

The volume gets loudest when each Drawbar is pulled out to the full length. The XK-1 gets silent when it is totally pushed in. The tones of the Drawbars gradually get higher in frequency from left to right.

The most popular patterns or registrations are (1) to pull out only all the three left side Draw-bars to the full, (2) to pull the far-left and only the white bars to the full, or (3) to pull out all the Drawbars.

NOTE: You can change the characteristics of the Draw-bars. (P. 54)

NOTE: The present registration is shown on the "Play" mode display. (P. 47)

ADD PERCUSSION

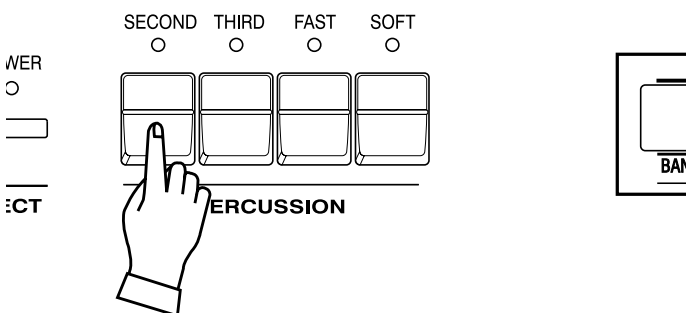

The "Percussion" referred to here is not a percussion instrument itself, but it is a "decay" to add a clear-cut "attack" to the organ sound. You can add this "attack" to mix with the Drawbar sound when you want.

If you turn on the [SECOND], [THIRD] Buttons, decays of the harmonic overtones (= one octave higher "C" and "G") are added. If you turn on the [FAST] Button, the decay is quick. And, if you press on the [SOFT] Button, the Percussion volume reduces.

NOTE: You can do fine volume setting etc. of the percussion. (P. 65)

ADD EFFECTS

VIBRATO/CHORUS

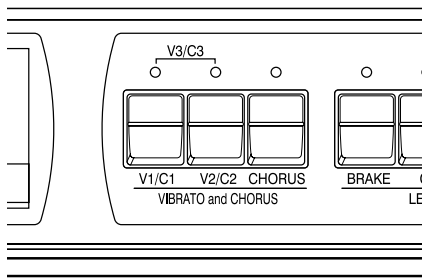

“Vibrato and Chorus” slightly changes the Drawbar pitch at a certain ratio and add warmth to the sound.

[V1/C1], [V2/C2] Button

Controls the Vibrato Depth and Switches on and off the Vibrato effect. The LED turns on when it is ON.

The Vibrato effect is OFF when the two LEDs are OFF and are at maximum Vibrato Depth when the two LEDs are ON (V3).

[CHORUS] Button

It mixes Vibrato and original sound (= Chorus Effect) and adds richness to the sound.

NOTE: You can set the speed of Vibrato/Chorus. (P. 69)

OVERDRIVE

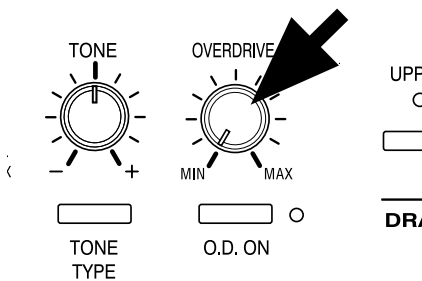

The overdrive effect simulates the effect of applying an excessively high signal to the amplifier input which causes distortion of the sound.

[O.D. ON] Button

Press this button to switch on the LED, and get the Overdrive Effect.

[OVERDRIVE] Knob

This knob controls the degree of distortion. The Overdrive effect is minimum when the knob is turned fully counter clockwise “MIN”. The Overdrive effect gets maximum when it turned to “MAX” clockwise.

LESLIE

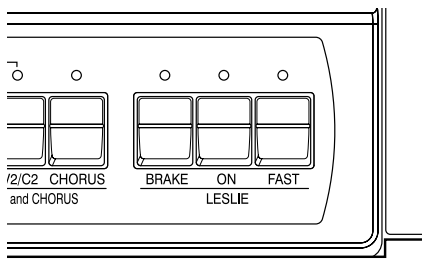

The bass rotor and the rotating horns produce the effect of the spatial, dynamic and lively theater stage performance.

[LESLIE ON] Button

Touch “ON” to switch on, the LED is lit.

[LESLIE FAST] Button

This button controls the two rotor speeds. When the LED is ON, it is FAST. When the LED is OFF, it is SLOW. The most effective and popular way to use this is to mainly play SLOW and lead to the climax by changing to FAST.

[LESLIE BRAKE] Button

This is to set the action when the LESLIE ON Button is OFF.

When the LED is ON, BRAKE is on. The rotation gradually slows down and stops finally). When the light is OFF, it is THROUGH. The Leslie effect is by-passed.

NOTE: You can control the rotors by these buttons when you connect the LESLIE to the external equipment.

NOTE: You can finely adjust the rotation speed etc. of the internal LESLIE Effect. (P. 66)

USING EXTRA VOICES

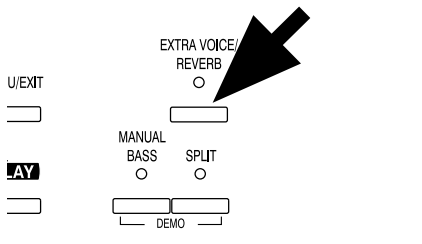

You can use Extra Voices (i.e. Electric Piano, Clav, etc.) instead of organ sounds.

[EXTRA VOICE / REVERB] Button

To use the Extra Voice, touch the button and switch on the LED.

NOTE: You can select the Extra Voice. (P. 74)

Divide the keyboard into two parts - left and right. [SPLIT]

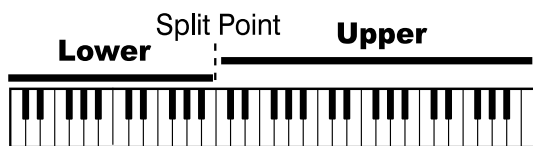

This keyboard has only a single manual. But you can change the setting and play it as it was a double keyboard organ, using this “SPLIT” function.

[SPLIT] Button

Switch on the LED by pressing the button, to “split” the manual.

The factory “SPLIT” setting is to divide it between B2 and C3 in the center.

NOTE: Split Point or Octave can be moved. (P. 82)

NOTE: The Split function does not work, when the MIDI IN jack is used for “LOWER/PEDAL”. (P. 84)

The right-hand side of the split point is called UPPER to make sound by the Drawbars (switch Drawbar Select [UPPER]) and Percussion. The left-hand side is called LOWER and makes sound with the Drawbars (switch Drawbar Select [LOWER]). Percussion does not sound with LOWER.

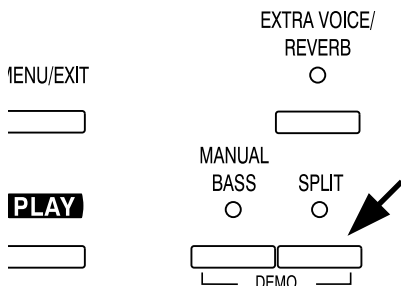

Add bass part on the manual keyboard. [MANUAL BASS]



You can play the Bass using the lowest keys.

This is called “Manual Bass”.

Manual Bass

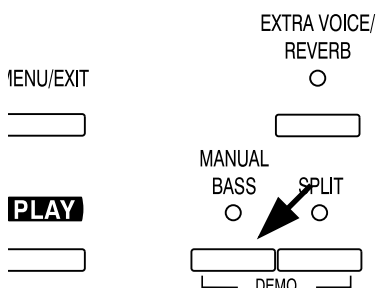

[MANUAL BASS] Button

To use the Manual Bass function, press the button and switch on the LED.

Not to interfere with the Melody performance, this function is limited only upto B2 in the center when it leaves the factory.

NOTE: You can move the upper limit of the Manual Bass. (P. 82)

NOTE: The Manual Bass function is controlled by connected MIDI keyboard when the purpose of the MIDI IN jack is at “LOWER/PEDAL”. (P. 84)

The bass part obtained by the Manual Bass is called the PEDAL, and makes sound controlled by the Drawbars (switch Drawbar Select [PEDAL]). This is designed so that the Bass is played by the pedal keyboard as on the three-keyboard organ.

NOTE: You can choose sounding polyphonic (POLY) or lowest note (MONO). (P. 55)

You can use both the Manual Bass and the Split at the same time. So, you will be able to play Bass, Chord and Melody all by yourself.

What is “Part”?

A “PART” plays like a “musician” in a band or an orchestra does.

Like the three-keyboard organs, this keyboard has three parts, UPPER, LOWER and PEDAL, and so you can play three different parts.

This keyboard has only a single manual, but it is possible to play plural parts, using the SPLIT and/or using MIDI keyboards to expand the keyboard.

NOTE: The function for plural tones is called “Multi-timbre”.

STORING REGISTRATIONS IN COMBINATION PRESET

All the afore-mentioned settings can be memorized to the Combination Preset.

The data stored at the factory can also be freely re-written.

EX. Memorize to “6 - 3”.

①

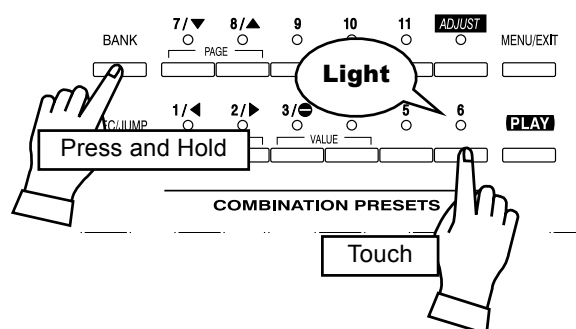

1. While pressing the [BANK] Button, touch the Preset Button [6].

This turn on Preset BANK 6. The LED on the Preset Button indicates BANK while the [BANK] Button is pressed.

NOTE: The LED goes out if you release the button. This means the Preset NUMBER is not decided.

-Now that we are in Bank 6. Let's record Number 3.

②

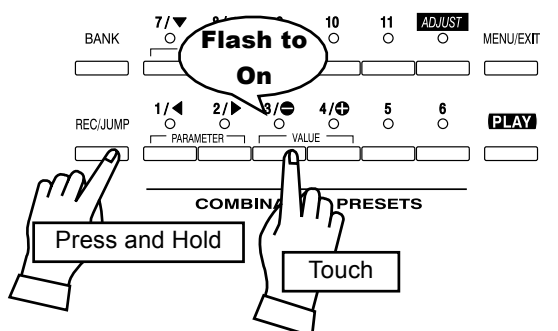

2. While pressing the [REC/JUMP] Button, touch the Preset Button [3].

The Preset is stored and Recording Preset appears on the display for a while.

When the recording is completed, the LED on the Preset Button [3] flashes for a few seconds and then stays on. The Display returns to the previous mode.

The recorded Preset will be automatically selected.

❖ *The Preset Button [ADJUST] can not memorize registrations by this operation.*

NOTE: The recorded Preset data is retained in memory if the power is switched off.

NOTE: See the “Preset Parameters” in Appendix section for detail of the parameters will be saved.



SYSTEM STRUCTURE OF XK-1 KEYBOARD

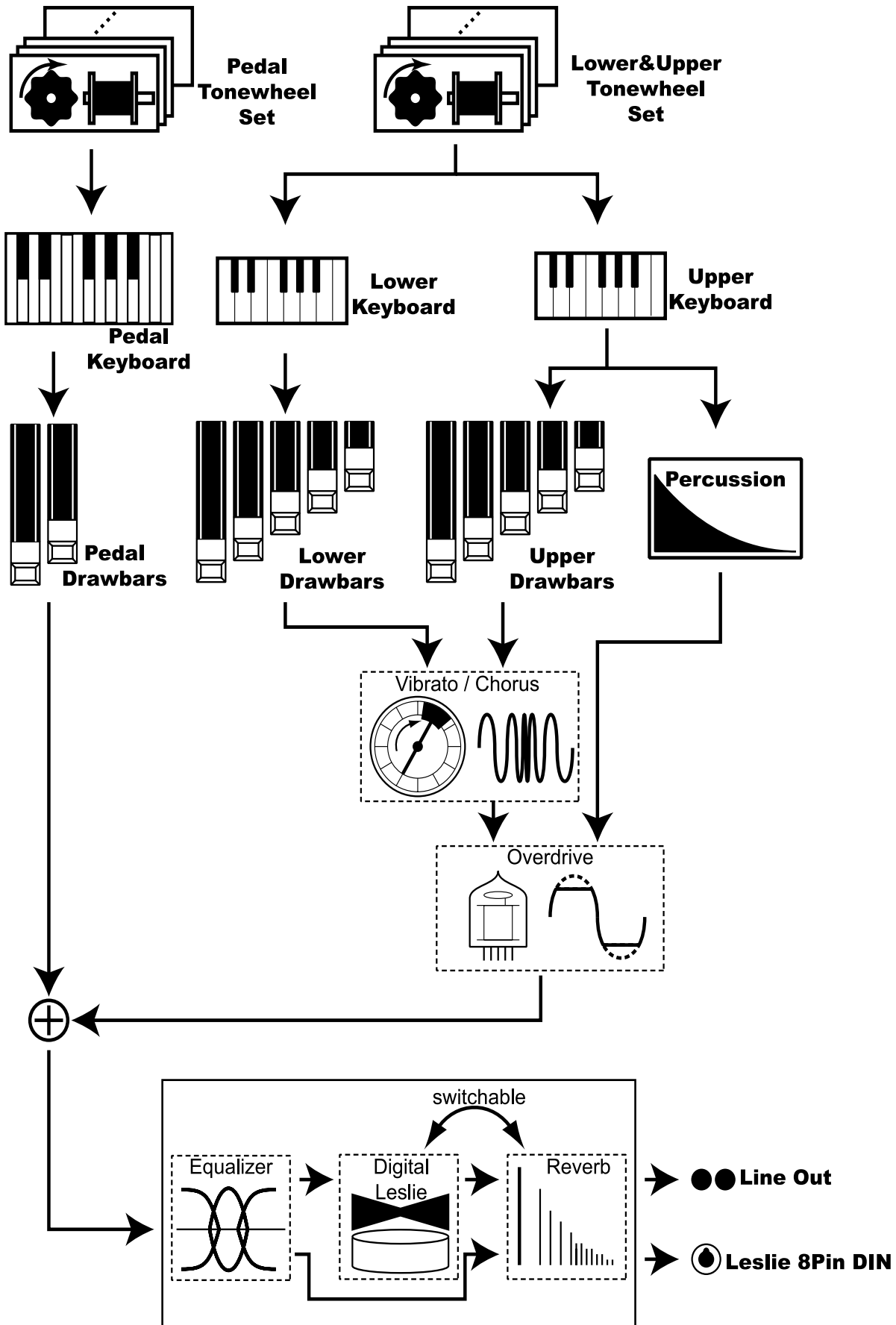

To fully enjoy playing this keyboard, please read the following section of this manual.

See the illustrated System Structure of your keyboard on the left page.

tone-wheels

The sound source or “engine” of Hammond Organ is the Tone-wheels. They are like the strings and pick-ups on the electric guitar. While running, each of the 96 digital Tone-wheels keeps oscillating at a different pitch/frequency.

keys

Each of the sound signals made by the 96 digital Tone-wheels is switched at each key. Each signal corresponding with each pitch and harmonic is distributed to each key (as an example, 9 signals for the manual keyboard). The keys are switched on and off by depressing and releasing the keys.

drawbars

The Draw-bars prepare the basic sounds. Each bar adjusts the value of a harmonic (as an example, 9 harmonics for the manual keyboard).

percussion

The Percussion makes decay sound, synchronizing with the key touch of the UPPER part.

vibrato/chorus

Vibrato gives vibration to the pitch. By mixing the vibrato sound with the fundamental sound, Chorus effect is obtained.

NOTE: On this keyboard the scanner circuit of the B-3/C-3 is simulated, which gives more effects than the changes of the pitch.

overdrive

Overdrive adds the fuzzy, raspy, “dirty” sound created by the vacuum tubes of a tube-style Leslie Speaker when its volume is pushed past its sound limit.

The PEDAL Part, however, is designed not to pass through the Vibrato/Chorus or the Overdrive, in order to obtain the clear Bass-line.

equalizer, leslie and reverb

The sound comes out of the output terminal, after passing the spatial effects: the Equalizer (for tone regulation), the Leslie (for the rotating speaker effects) and the Reverb (for resonance). (The built-in Leslie Effect does not work at the Leslie 8-pin terminal.

NOTE: The built-in Leslie Effect is designed to smoothly simulate the rotations of the two rotors.

tips TONE-WHEEL SET

The Tone-wheel Sets are divided into the Manual Keyboard and the Pedal Part. This is to give the Pedal Part the Decay (= the sound gradually fading out while pressing the key) or Sustain Effect. (= the sound gradually fading out after the key is released).

tips HARMONICS

Harmonic is a pitch of a different ratio to a certain pitch; for example, the one octave higher C to the middle C. The more Harmonics, the brighter and richer the sound.

The 9 Drawbars on this keyboard are used to make the basic sounds. Each Drawbar is marked with the numbers 1 - 8. If you push back the Drawbar until you can not see any number at all, the sound of the Drawbar is not heard. If you pull it out to the fullest position THE SOUND LEVEL is maximum.

Except when the Preset Button is [ADJUST], the actual Drawbar Registration is the value displayed in the (display-)window. The "Drawbar Registration" shows the length of the pulled-out Drawbar(s). The display shows only the Drawbar(s) you operate.

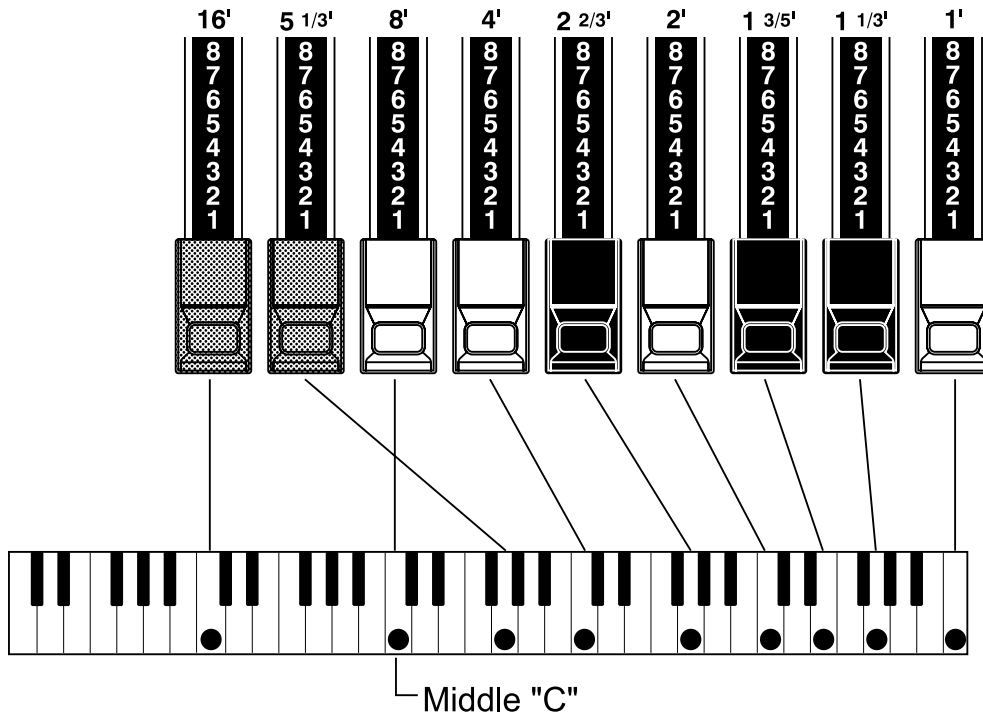

The pitch of each Drawbar is as shown above, when the middle C is depressed. The footage marked (') on each Drawbar is originated from the length of the pipes of the pipe organ.

The numbers 1 - 8 on each Drawbar indicate the volume of the sound to be produced as well as the guide to simply set the Drawbar.

For example, when you blow clarinet, the internal air vibrates, and the fundamental (8') and the third harmonic (2 2/3') plus the fifth harmonic (1 3/5') come out at the same time. On this keyboard, if you pull out 3 Drawbars, you can get the clarinet sound. If you pull out the right hand side one of the 3 Drawbars a little longer and the left hand side one a little shorter, the element/component of the high pitch increases and a hard sound comes out. If you pull out the left hand one a little longer, on the contrary, the sound gets mellow.

Thus, you can make delicate changes to the sound, depending on the flow of the tune/music or your choice/preference, by fully utilizing the Drawbars.

NOTE: You can change the characters of the Drawbars. (P. 54)

WHITE DRAWBARS

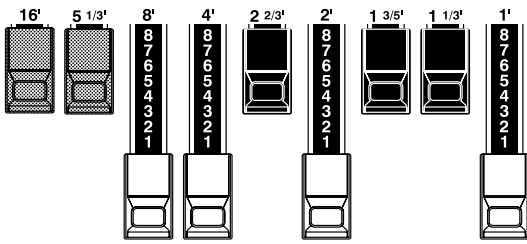

In each Drawbar set, the white Drawbar (8') on the left end makes the basic/fundamental sound. The other white Drawbars get higher by the octave to the right.

BLACK DRAWBARS

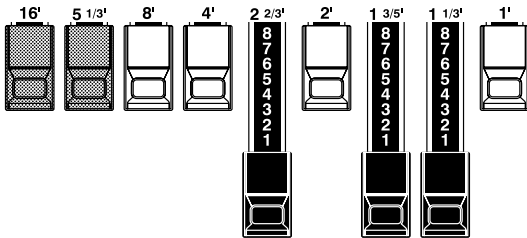

The sounds of the black Drawbars, too, play important roles in building rich tones. Their pitches are fifth and third to the fundamental. They contain the elements of all different harmonics of such as the sweet and soft horn, mellow strings and so on.

BROWN DRAWBARS

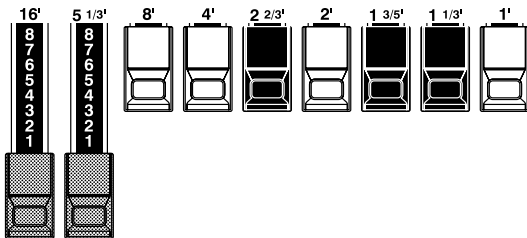

The two brown Drawbars on the far left have the role to give depth and richness to the sound. The left 16' is one (1) octave lower than the 8', and 5 1/3' is the third harmonic of the 16' fundamental. Normally, the tones are built on the 8' fundamental, but, if you want to add depth to the tone or to expand the playing range on the manual by one (1) octave, the tones are built on the 16' fundamental.

PEDAL DRAWBARS

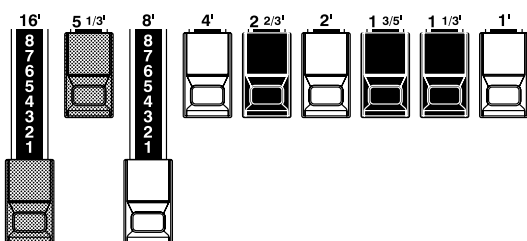

The Pedal Part for playing the bass line usually, using the only two Drawbars -16' and 8'. Others are not use. The first Pedal Drawbar produces a tone at 16' pitch for a deep foundation bass, while the second Pedal Drawbar produces a tone at 8' pitch, or one octave higher. The registration of the Pedal Part is displayed on the center of the display, left one is 16', and the right one is 8'.

DRAWBAR REGISTRATION PATTERNS

The Drawbar Registration is matched by the number value of each Drawbar as shown below on right side of Drawbar settings name. However, it is rather reasonable to remember the typical combinations of the 9 Drawbars by their forms/shapes.

Flute family (2 step pattern)

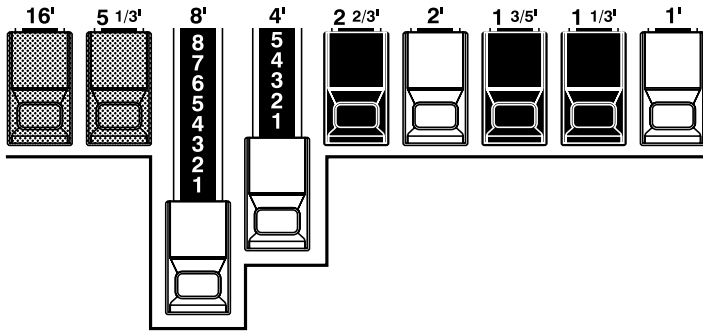

Accompaniment Flute 8' I	00 8460 000
Accompaniment Flute 8' II	00 3220 000
Accompaniment Flute 8' III	00 8600 000
Chorus of Flutes 16'	80 8605 002
Orchestral Flute 8'	00 3831 000
Piccolo 2'	00 0006 003
Stopped Flute 8'	00 5020 000
Tibia 8'	00 7030 000
Tibia 4'	00 0700 030
Tibia (Theater) 16'	80 8605 004
Wooden Open Flute 8'	00 8840 000

Reed family (triangle pattern)

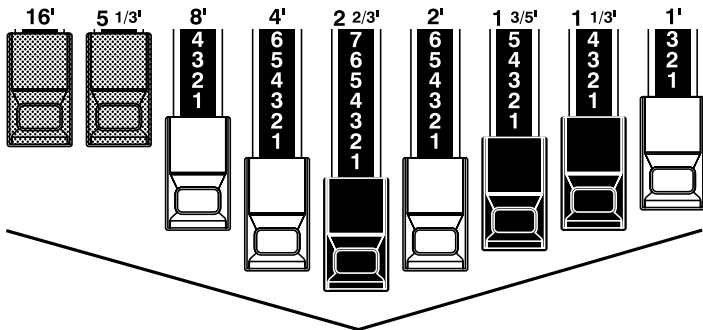

Bassoon 16'	44 7000 000
Clarinet 8'	00 6070 540
English Horn 8'	00 3682 210
Flugel Horn 8'	00 5777 530
French Horn	00 7654 321
Kinura 8'	00 0172 786
Oboe 8'	00 4764 210
Trombone 8'	01 8777 530
Trumpet 8'	00 6788 650
Tuba Sonora 8'	02 7788 640
Vox Humana 8'	00 4720 123

Diapason family (check mark pattern)

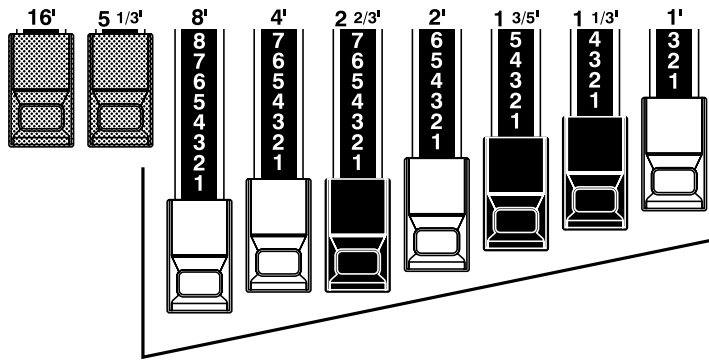

Accomp. Diapason 8'	00 8874 210
Chorus Diapason 8'	00 8686 310
Diapason 8'	00 7785 321
Echo Diapason 8'	00 4434 210
Harmonic Diapason 16'	85 8524 100
Harmonic Diapason 8'	00 8877 760
Harmonic Diapason 4'	00 0606 045
Horn Diapason 8'	00 8887 480
Open Diapason 8'	01 8866 430
Solo Diapason	01 8855 331
Wood Diapason 8'	00 7754 321

String family (bow pattern)

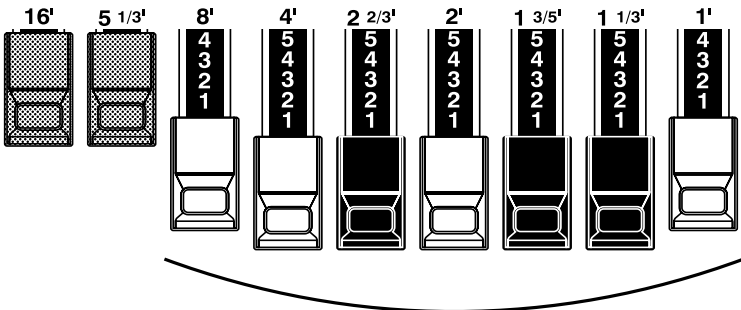

Cello 8'	00 3564 534
Dulciana 8'	00 7770 000
Gamba 8' I	00 3484 443
Gemshorn 8'	00 4741 321
Orchestral String 8'	00 1464 321
Salicional 8'	00 2453 321
Solo Viola 8'	00 2474 341
Solo Violin 8'	00 3654 324
Viola da Gamba 8'	00 2465 432
Violina 4'	00 0103 064
Violone 16	26 3431 000

DRAWBAR SELECT

ASSIGN THE DRAWBARS FOR EACH PART

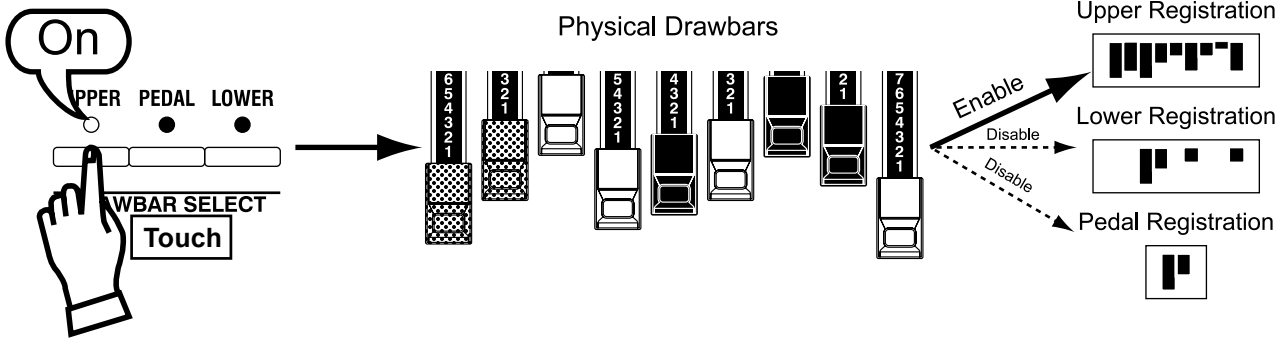

On this keyboard, there are 3 Parts: UPPER, LOWER and PEDAL, and each of them has the corresponding Drawbars. The manual on the keyboard is usually assigned to the UPPER position. If you want to play the LOWER or PEDAL Part, use the Split or Manual Bass functions, or connect a MIDI keyboard and assign each part.

There is one set of Drawbars on this keyboard, though this keyboard has 3 Parts. Use Drawbar Select Buttons for assignment of the Drawbars for each of the Parts.

The Drawbar Select Buttons [UPPER], [PEDAL], [LOWER] are used for selecting “which Part the Drawbars will be assigned to”.

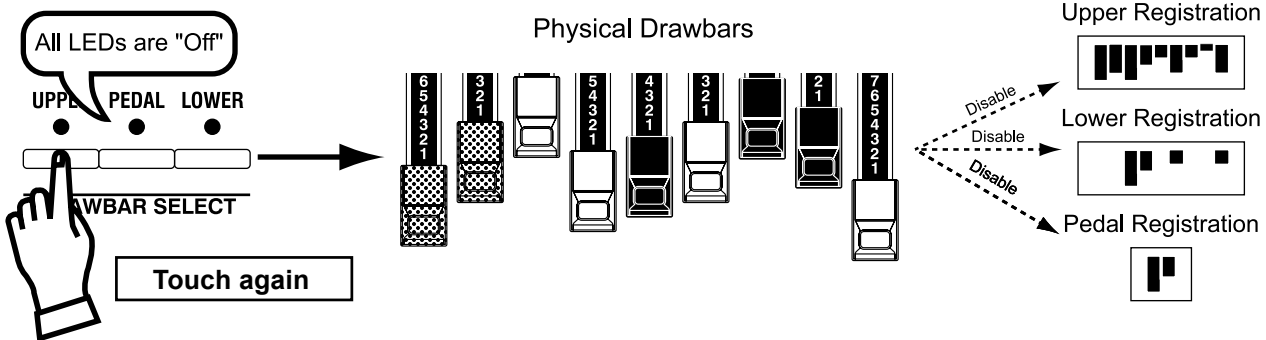

The Drawbar Select Button can be turned off by re-touching, and the no works to tell the controlling Drawbars. This means that you can make the new resistration while playing and

change it.

To match the registration, use the function below.

MATCH THE REGISTRATION TO DRAWBARS

If you recall the Combination Preset, the Drawbar Registration is not physical but is replaced with the recorded/memorized one. If you move any Drawbar at this stage, only the Footage moved is changed.

To match only the Registration to the Drawbars while using the

content of the Combination Preset, keep depressing the Preset Key for a while. The Combination Preset is recalled and then the physical Drawbar Registration is reflected.

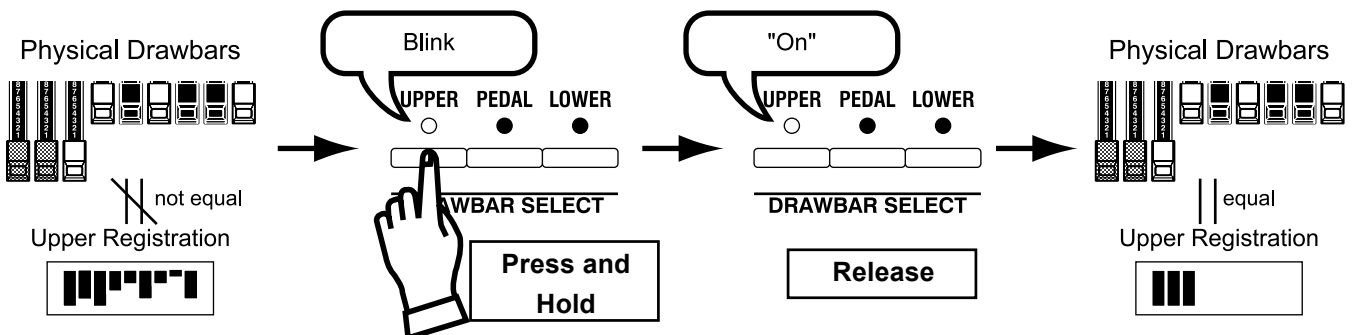

The Percussion attack sound is a Hammond exclusive. Percussion is usually used with the Drawbar sound.

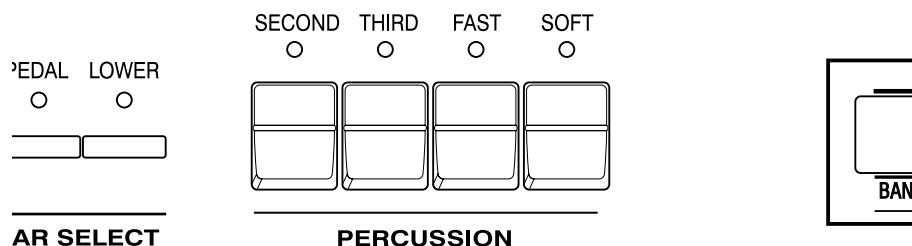

[SECOND] BUTTON

The second harmonic, or 4' Drawbar decay, is added to the UPPER Part. To use this, press the [SECOND] button, and the LED will light.

[THIRD] BUTTON

The third harmonic, or 2 2/3' Drawbar decay, is added to the UPPER Part. By mixing it with the Drawbars, a distinctive sound is obtained. To use this, press the [THIRD] button, and the LED will light.

[FAST] BUTTON

This provides a short decay time for Percussion. It is effective if you use this to play with a clear-cut rhythm in an up-tempo piece. When the LED is OFF, it is SLOW. It goes "FAST" when you press the [FAST] button, and the LED will light.

[SOFT] BUTTON

This reduces the volume of Percussion. When the LED is OFF, it is NORMAL. If you press the [SOFT] button, the percussion level is soft, and the LED will light.

NOTE: You can fine-adjust Percussion. (P. 65)

tips DECAY

The piano sound gradually goes out even if you keep the key down. This is called "decay". The violin, on the contrary, keeps sounding at a certain volume. This is called "sustain".

NOTES

"Percussion does not sound!"

The factory default setting: Percussion does not produce sound except at the Preset Key [ADJUST], if the Combination Preset is Bank 12. (See left.) This setting is the same as on the B-3/C-3.

NOTE: You can set any Preset Key to sound Percussion. (P. 56)

DRAWBAR CANCEL

When either the [SECOND] or the [THIRD] button is ON, 1' in the Upper Part Drawbars does not produce sound. This is the same action as on the B-3/C-3.

NOTE: You can set to play 1' Drawbar, while Percussion is ON. (P. 65)

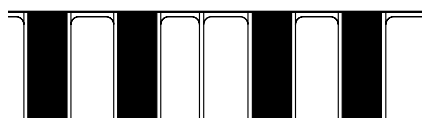
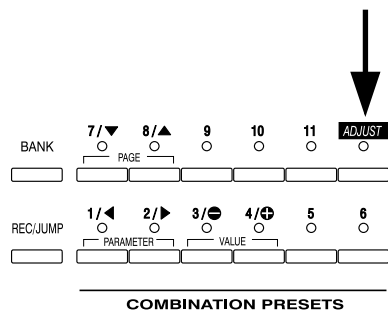

VIBRATO/CHORUS

VIBRATO adds warmth to the tone, by slightly changing the Drawbar pitch at a certain speed.

You can also add richness to the sound by mixing the Vibrato sound with the fundamental (= Chorus Effect).

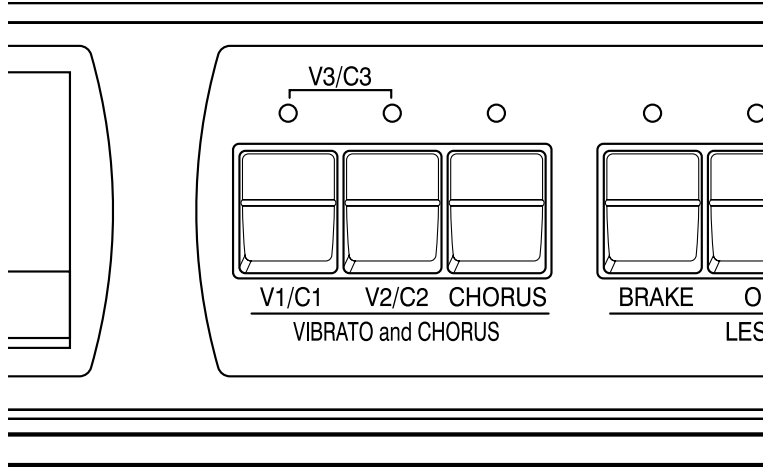

[V1/C1], [V2/C2] BUTTON

This switches ON/OFF Vibrato/Chorus Effects and sets the its depth. It affects on the UPPER and LOWER Part.

To get this effect, touch the button and the LED will light.

- V-1: Comparatively slight Vibrato (on only [V1/C1])
- V-2: Standard depth Vibrato (on only [V2/C2])
- V-3: Deepest Vibrato (on both [V1/C1] and [V2/C2])

[CHORUS] BUTTON

This switches Vibrato or Chorus Effects.

To get the Chorus Effect, touch the button and the LED will light.

NOTE: You can change the speed of the Vibrato Effect. (P. 69)

tips BUTTONS AND STATUS

Button			State
V1/C1	V2/C2	CHORUS	Effect
Off	Off	Off	Through
Off	Off	On	
On	Off	Off	
Off	On	Off	V-2
On	On	Off	V-3
On	Off	On	C-1
Off	On	On	C-2
On	On	On	C-3

The Overdrive produces the distorted sound like that of an over-driven amplifier. By changing the amount of the Drive, various Tube Sounds are obtained, from the unclipped clean to the hard-distorted fuzzy, raspy Overdrive sound.

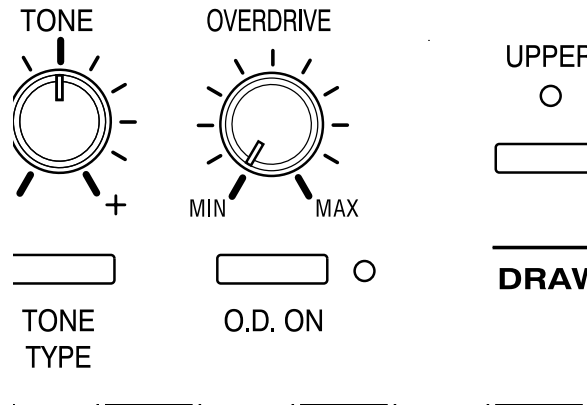

[O.D. ON] BUTTON

This button switches on/off the Overdrive Effect.
Press this button to switch on the LED, and get the Overdrive Effect.

[OVERDRIVE] KNOB

This is for adjusting the distortion value of the Overdrive Effect.
It does not clip, if turned to the left all the way (by-passed the effects).
As you turn it to the right, the distortion value increases.

NOTE: You can fine-set the distortion degree. (P. 69)

LESLIE EFFECT is the simulated sound of rotating speakers.

If you connect the real Leslie speakers to this keyboard, it controls those (speakers)

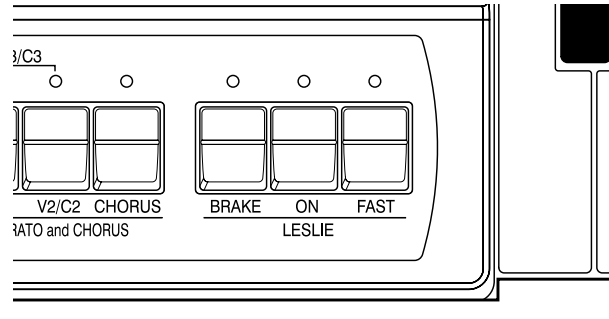

[ON] BUTTON

If you touch this button, the LED will light, and the rotor starts turning. Also the voice is heard thru the rotary channel.

[FAST] BUTTON

This switches the speed of the rotor in two steps. It switches every time you touch it. When the LED is ON, it is FAST, and when the LED is off, it is SLOW.

[BRAKE] BUTTON

This button sets the action when the [ON] button is OFF. When the LED is ON, it is in BRAKE mode (= The speed gradually slows down and stops.) and if the LED is OFF, it is THROUGH. (= The Leslie effect is by-passed and the voice comes out of the stationary channel.)

- NOTE: You can not to control the Break or Through on external Leslie Speakers.
- NOTE: You can fine-set the LESLIE effect i.e. speeds. (P. 66)

tips BUTTONS AND LESLIE STATES

Button			State	
BRAKE	ON	FAST	External Leslie Speaker	Internal Leslie Effect
On	On	On	Fast	
Off	On	On	Fast	
On	On	Off	Slow	
Off	On	Off	Slow	
On	Off	On	Brake	
On	Off	Off	Brake	
Off	Off	On	Fast	Through
Off	Off	Off	Slow	Through

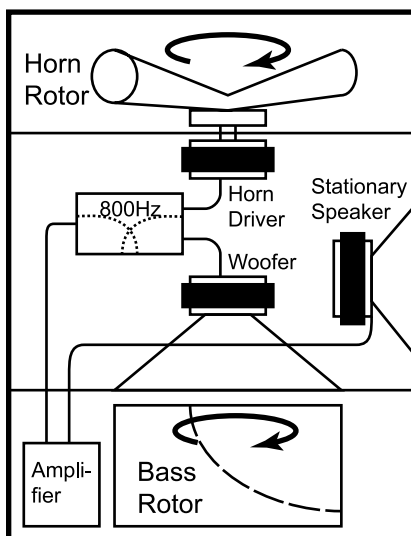

tips WHAT IS THE LESLIE EFFECT?

In the Leslie speakers, generally, an amplifier and two rotors are incorporated, i.e. the "Horn Rotor" responsible for the treble and the "Bass Rotor" for the bass.

Each rotor has a speaker or speakers and a motor for controlling speed to give the unique tremolo sound gained by the Doppler effect.

There are also models as have not only the rotors but stationary speakers - switchable.

The circuit to send the sound to the rotor is called "Rotary Channel" and that to the stationary speaker is called "Stationary Channel".

The built-in Leslie Effect simulates them and you can get the best effect when connected stereophonic.

The Equalizer and the Reverb effects give the final touch to the tone.

The Equalizer regulates the tone, and the Reverb adds the resonance of the hall performance.

You can control these functions with the panel buttons and knobs

EQUALIZER

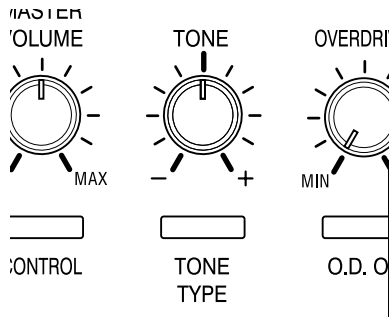

[TONE] KNOB

Can be setup to control any one of the three tone types.

When delivered from the factory, TREBLE is assigned, and, as you turn it to the right, the treble is emphasized, and, to the left, the treble is reduced.

[TONE TYPE] BUTTON

This assigns the settings to the [TONE] KNOB.

At every touch, the assignment changes in the order of TREBLE, BASS and MIDDLE. The initial letter of the word is displayed in the PLAY mode.

NOTE: For further details, please read the section "EQUALIZER" (P. 70)



The illustration indicates
TREBLE is at +9.

REVERB

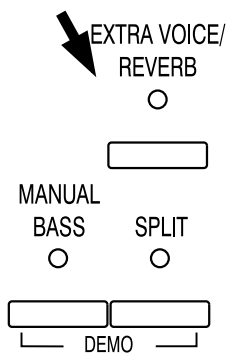

[EXTRA VOICE / REVERB] BUTTON

This is for switching ON and OFF the Reverb Effect when the assignment for this button is REVERB (P. 61).

NOTE: You can change the time and the depth of the Reverb. (P. 71)

COMBINATION PRESETS

The settings you have made can be recorded into the Combination Presets.

BANK AND NUMBER

Combination Presets

		Number											
		1	2	3	4	5	6	7	8	9	10	11	Ad
Bank	1												
	2												
	3												
	4												
	5												
	6												
	7												
	8												
	9												
	10												
	11												
	12												

The combination preset chart to the left, shows the [BANK] and the [NUMBER], information.

Access is made by the Preset Buttons. To select the [BANK], press the key, holding down the [BANK] button. To select the [NUMBER], just press the Preset Button.

Recording and recall is determined when the Number is designated. Only selecting the Bank does not affect the recording or recall.

Refer to the illustration on the left bottom for each Button and Name.

The [ADJUST] button on the right end is a special Preset, called "Adjust Preset". Here the Drawbar Registration on the panel always matches the internal registration.

NOTE: The setting of the Preset Buttons [C] to [A] on the B-3/C-3 is fixed, and the [A#] and [B] are used to switch the Drawbar Registration on the panel. However, on this model, you can change the setting by moving the Drawbars, even while using the buttons [1] to [11].

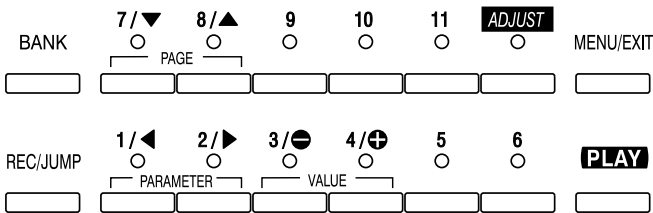

COMBINATION PRESETS

tips COMBINATION PRESETS

On the original B-3 organ, the preset keys only stored drawbar registration information. On the XK-1 however, in addition to drawbar registration, you can store many various parameters to a preset. Thus the name "Combination Preset".

NOTE: The parameters to be recalled by the Preset Keys can be limited Bank by Bank. (P. 56)

NAME THE COMBINATION PRESETS

- 1 Go to the MENU.

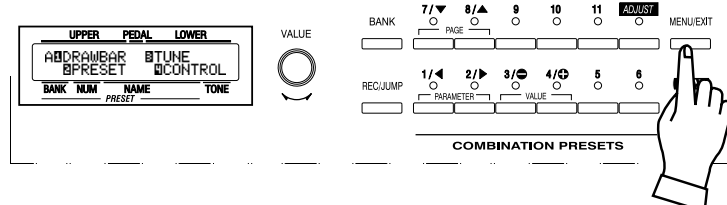

Touch the [MENU/EXIT] button.
The MENU mode will be displayed.

- 2 Go to PAGE A.

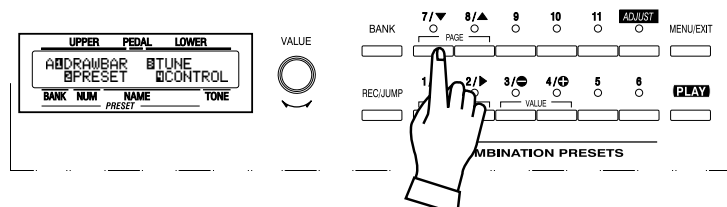

If the PAGE A is not displayed, touch the [PAGE] button and go to PAGE A.

- 3 Go to the PRESET FUNCTION mode.

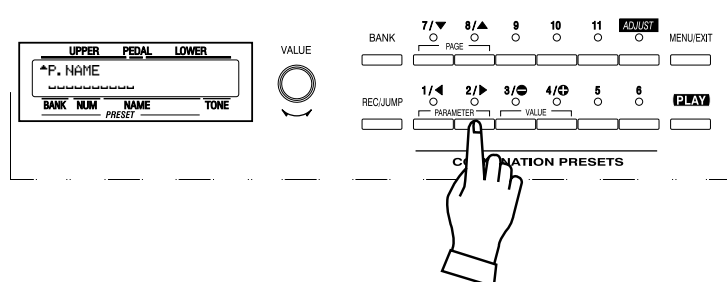

Touch the [2] PRESET button and go to the PRESET FUNCTION mode.

- 4 Input THE NAME.

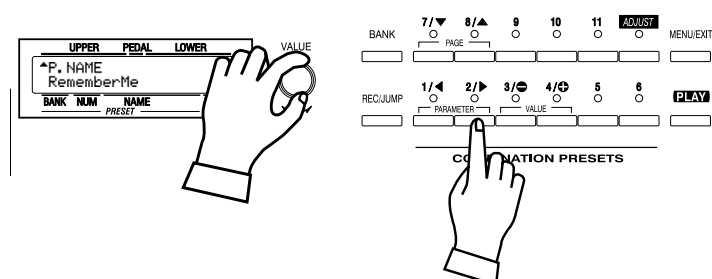

You can store names up to 10 letters.

[PARAMETER] Button: moves the cursor.

[VALUE] Button: selects letters.

You can use all the Alphabet letters large and small, signs/symbols and digits.

To jump to the beginning of each list, hold down the [REC/JUMP] button, and touch the [VALUE] button. You can select letters etc. by the [VALUE] knob, as well.

The name put here is only temporary. Do the recording operation to save it, as explained on the next page.

RECORD A NEW THE COMBINATION PRESET

EXAMPLE: Record into “6-3”.

- 1 Go to the PLAY mode.

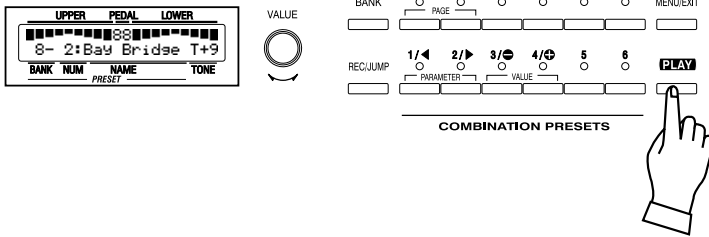

If the display is not in PLAY mode, touch the [PLAY] button to back to the PLAY mode.

This operation is not necessary, if the display is in PLAY mode.

- 2 Select the Bank.

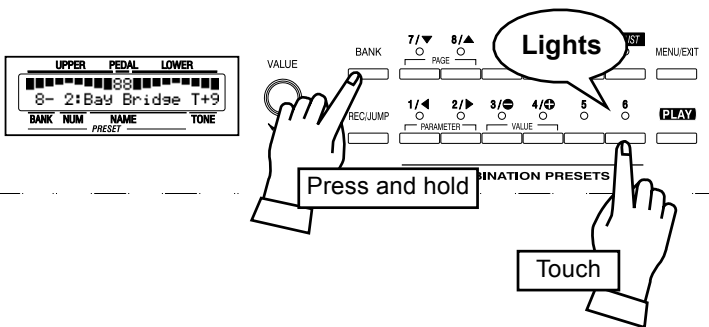

While holding down the [BANK] button, touch the Preset Button [6].

The LED on the Preset Key indicates the BANK while you are holding down the [BANK] button.

NOTE: The LED will be OFF, if you release the button. This means the Preset is not stored.

This operation is not necessary, if you do not change the Bank.

- 2 Select the Number.

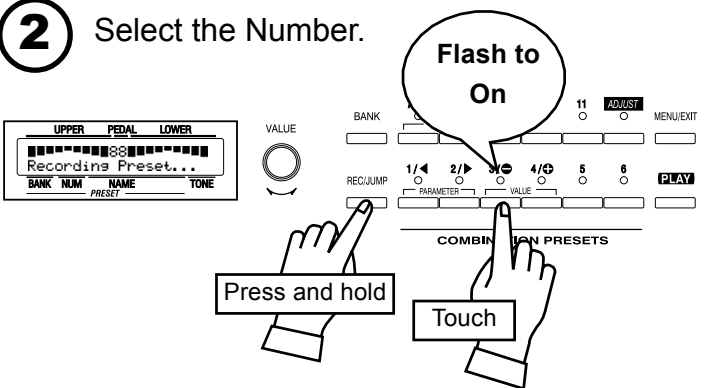

Press the Preset Button [3], while holding down the [REC/JUMP]. The Preset becomes final and the display shows as follows for a few seconds.

Recording Preset...

When the recording is completed, the LED on the Preset Button [D] flashes for a while. (The recorded Preset Number will be automatically selected.)

The display will return to the previous screen.

- ❖ You can not record to the Preset Button [ADJUST] by using this procedure.

NOTE: The Preset data recorded will not be lost even after you switch off the power.



**USING THE
CONTROL PANEL**

OPERATION CONTROL PANEL

You now know you can control many settings by using the buttons and knobs on your keyboard. You can do even finer settings like the delicate speed of the Leslie Effect or the MIDI equipment, using the display buttons on the Control Panel.

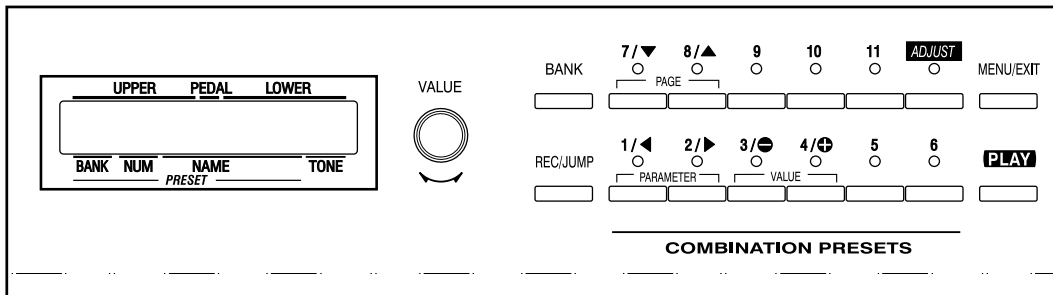

There are PLAY, MENU and FUNCTION modes in the display.
The buttons and knobs in each mode is explained on the following pages.

PLAY mode	<pre> ██████████88██████████ 8- 2: Bay Bridge T+9 </pre>
MENU mode	<pre> A DRAWBAR B TUNE PRESET C CONTROL </pre>
FUNCTION mode	<pre> HORN SLOW FAST LEV SPD 48 435 -12▶ </pre>

The PLAY MODE is the basic display for all the operations. The necessary informations for the normal play will be displayed.

There are two types of PLAY MODE screens to display the Drawbar Registration. One is by showing the length of the Drawbars and the other by digits.

How to show this display:

1. Immediately after powered ON and the start up process is complete, the PLAY mode is displayed.
2. If a different mode is displayed, touch the [PLAY] button.

HOW TO READ THE DISPLAY

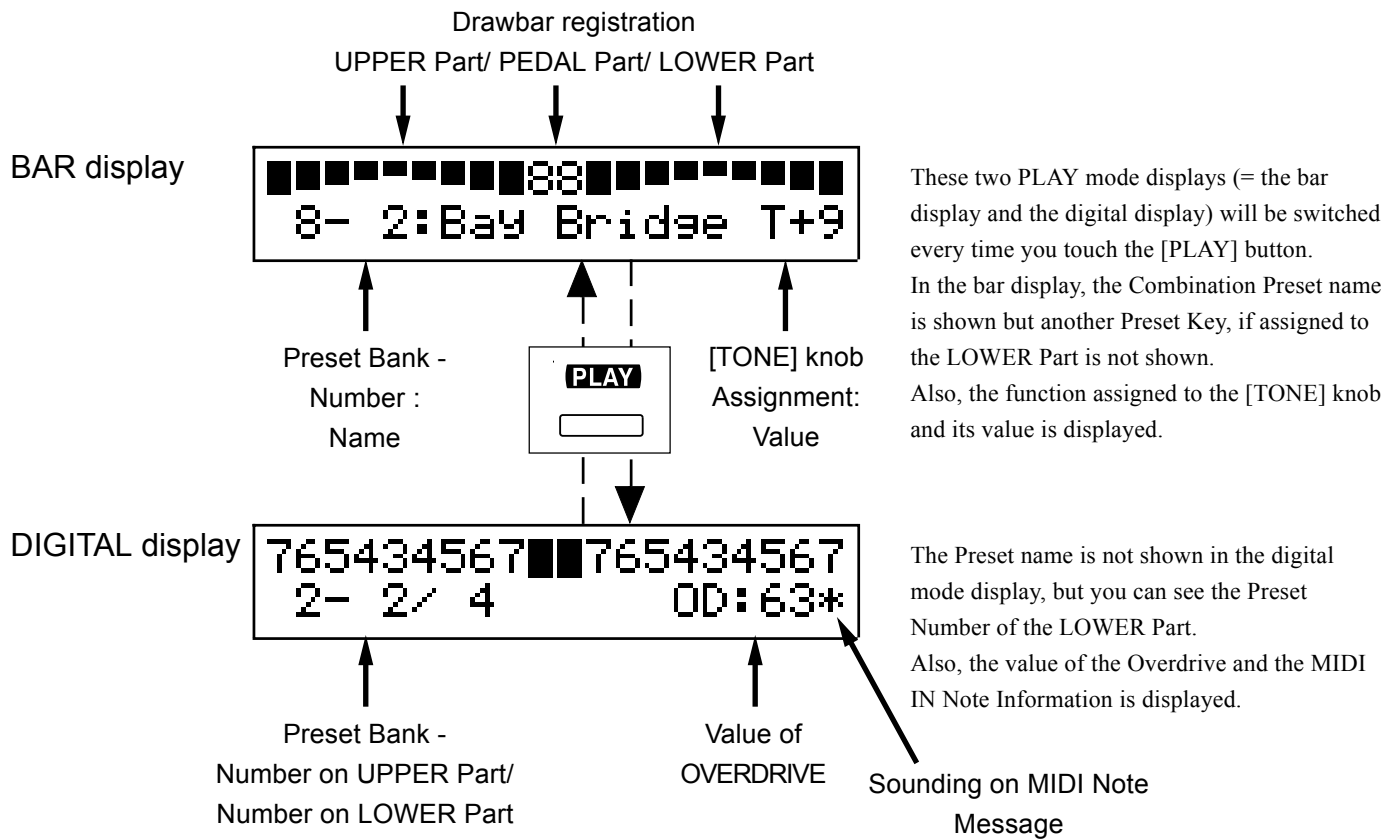

MENU MODE

The MENU mode is the path for each function.

How to show this display:

Touch the [MENU] button.

There are several pages which contains many various FUNCTION displays. Move from page to page and find the item where you want to go and touch the numbered button to see the desired display.

HOW TO READ THE DISPLAY

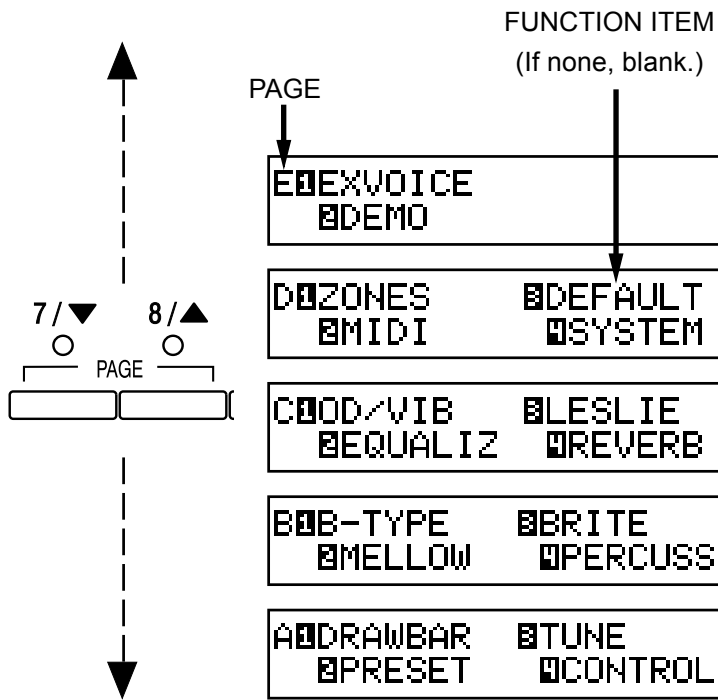

BUTTON OPERATION IN THIS MENU

Moves from a page to another.
You can jump to the top or bottom page by touching these buttons with holding down the [REC/JUMP] Button.

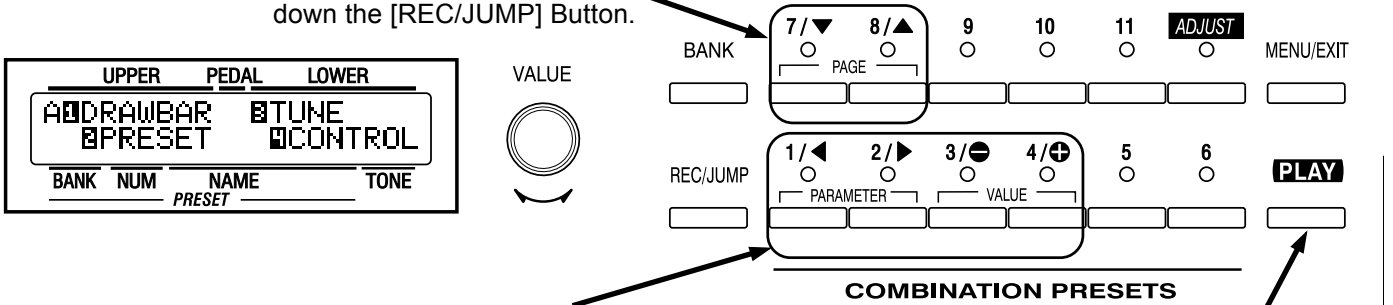

These are for entering each FUNCTION MODE corresponding with the item displayed.

Returns to the PLAY mode.

The FUNCTION MODE is for making each setting and adjustment.
There are many displays, but the basic operation is the same.

HOW TO READ THE DISPLAY

This shows there are PAGES
above (or below).

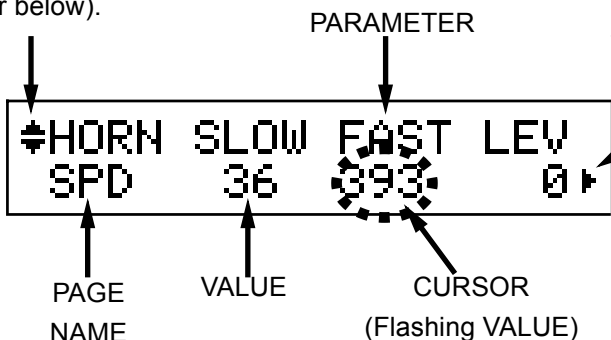

This shows there is a PAGE on the
right (or on the left).

tips CURSOR

In the display window of this keyboard, the CURSOR is displayed in the flashing style, while the most popular indicator-cursor used on the PC, the mobo, etc. is in the shape of an arrow, a square or an I-shape.

BUTTON OPERATION IN THIS MODE

Moves from a page to another.
You can jump to the top or bottom page by touching these
buttons with holding down the [REC/JUMP] Button.

Returns to the
PLAY mode.

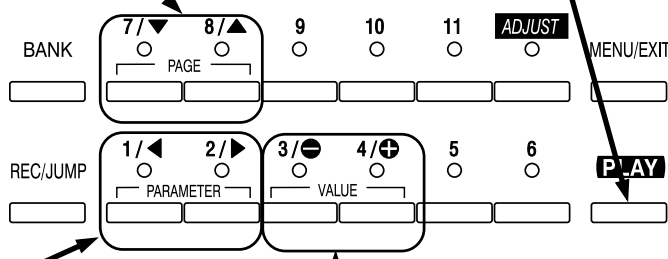
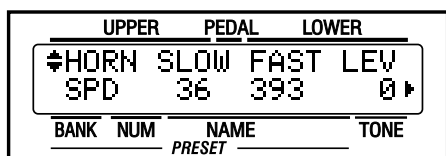

This button is used to move the CURSOR
right or left for selecting the PARAMETER to
change.
The CURSOR moves to the edge of the
display and on to the next page (on the right
or left), if there is one.
Touching this button while holding [REC/
JUMP] button, you can move to the right or
left page regardless where the cursor is.

The CURSOR increases or decreases
the value of the Parameter.
Holding it increases (or decreases) the
value continuously.
Touching it while holding the [REC/
JUMP] button increases (or decreases)
the value quickly.
The value can also be changed by the
[VALUE] knob on the left.

Example of operation:

Adjusting the DECAY TIME of the Percussion [FAST]

1 Go to the MENU Mode.

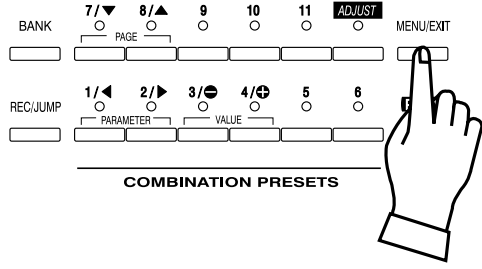
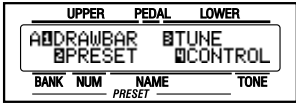

Touch the [MENU] button.
The [MENU] mode is displayed.

2 Select the PAGE.

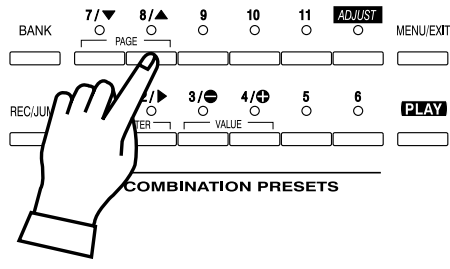
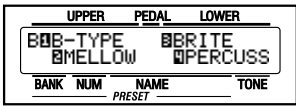

Search for the PERCUS page, using the [PAGE] button.
“PERCUS” is on PAGE B. So select PAGE [B].

3 Touch the Number button.

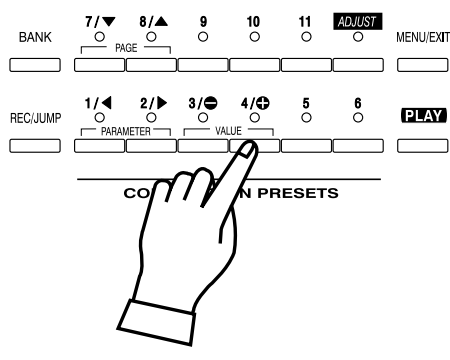
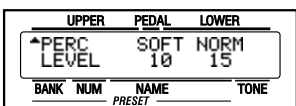

Touch the [4] button for “PERCUS”.
Now you are on the (first page) of the Percussion Function display.

4 Move the CURSOR to the Parameter you want to change.

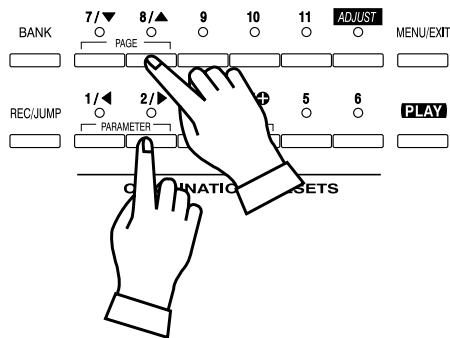
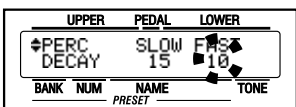

DECAY TIME is on the “DECAY” PAGE.
Move to that page using the [PAGE] button.
“FAST” is on the right end. Move the CURSOR (flashing value) to underneath “FAST” using the [PARAMETER] button.

5 Change the value.

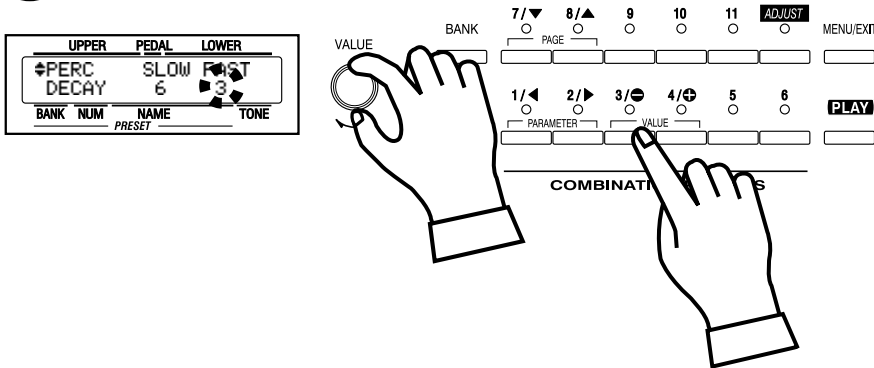

Decrease the value, using the [VALUE] button or the [VALUE] knob on the left.

NOTE: Repeat the operation 1 - 5, if you want to change other parameters, too.

6 Back to PLAY mode.

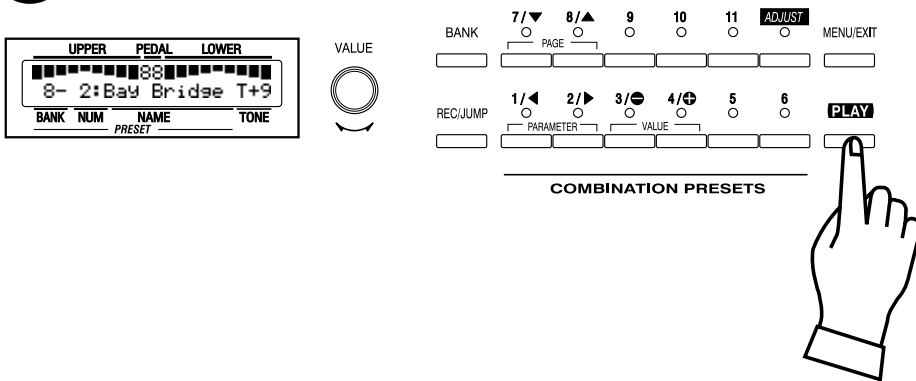

Touch the [PLAY] button to return to the PLAY mode.

7 Record a new Combination Preset.

The “DECAY FAST” is a Preset Parameter. It will go back to the set value if you call out the other (or current) Combination Preset.

If you want to continue to use the changed value hereafter, you must record the value into the Combination Preset.

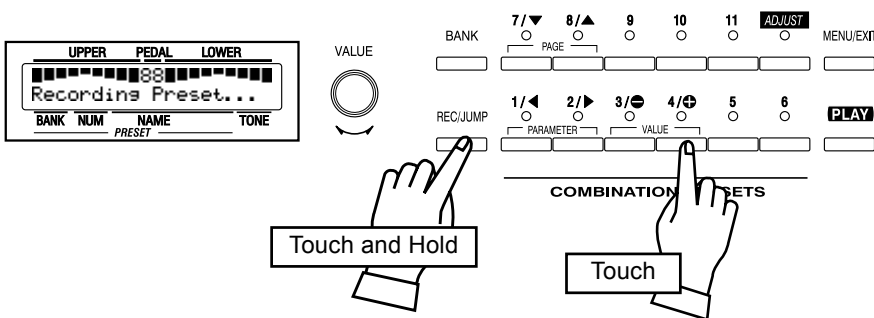

tips PRESET PARAMETERS

They are the Parameters to be recorded into each Combination Preset. They include the Parameters for setting the status of the buttons/knobs on the panel, “Decay Fast” and many others. The overall/general common Parameters (which are not included in the Combination Presets) are called “Global Parameters.”

SHORT CUT TO THE FUNCTION MODE

Each button on the panel has a “SHORT-CUT” capability, so that you can easily go to each Function mode. By holding down the button, you can easily go to the desired mode display. The “SHORT-CUT” mode can save time by going directly to the parameters you want to change.

Example of operation: Move to the Percussion Function Mode.

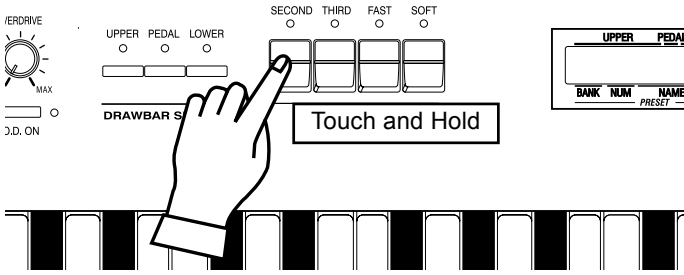

For example, if you want change the Percussion setting, you can go to the PERCUSSION FUNCTION MODE display, by holding down either [SECOND], [THIRD], [FAST], or [SOFT] for a few seconds. This enables the “SHORT CUT” mode.

Short-cut buttons will be explained in the next Chapter “SETTING THE PARAMETER”.

NOTE: You can change the time for holding down the button for “SHORT CUT”. (P. 61)

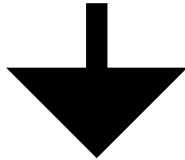

STORING THE PAGE YOU FREQUENTLY USE

You can store the page which your usually use, and go to that page by only touching the [CONTROL] button.

Example of operation: Storing the Drawbar - Pedal Function



Go to the page to be stored by using MENU etc.

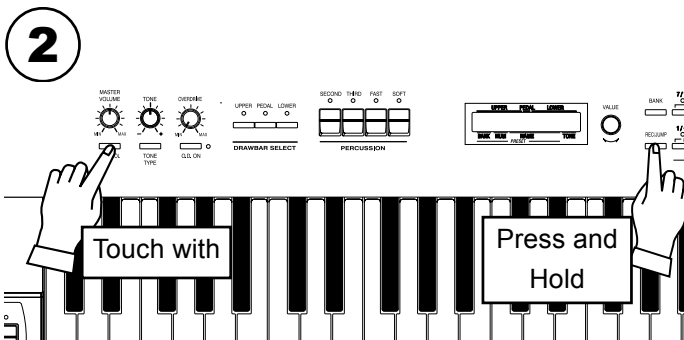

Touch and hold the [REC/JUMP] , and touch the [CONTROL] button.

Next time, you can come to this page by only touching the [CONTROL] button.

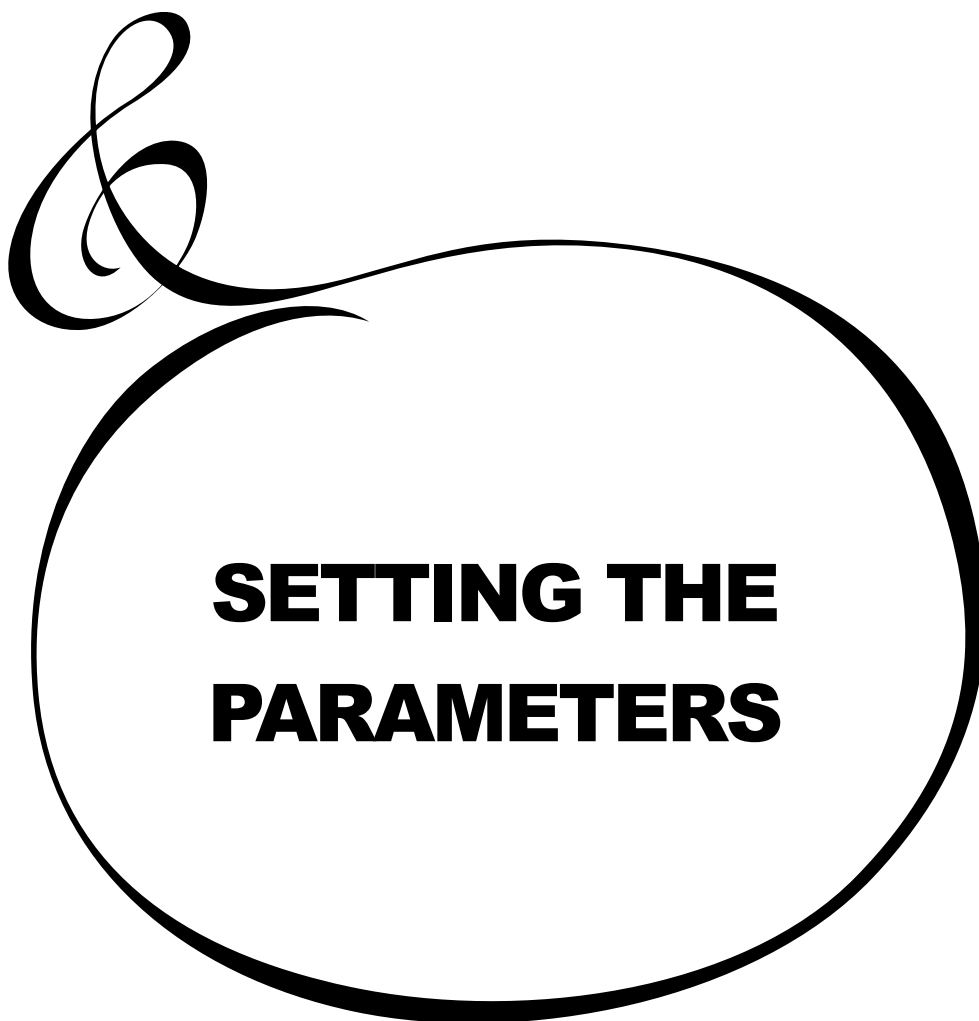

In this mode, you can set the Parameter relating to the Drawbar sound of each part.

To locate the Drawbar mode:

Touch the [MENU/EXIT] button and display MENU, touch the [PAGE] button and select PAGE A and choose [1] DRAWBAR.

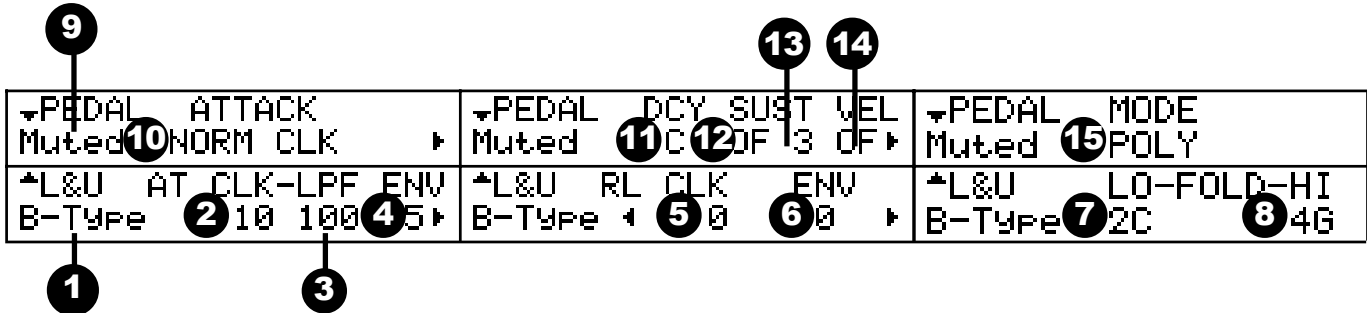

◆ Setting the Manual (LOWER and UPPER)

1. TONE-WHEEL

Select the TONE-WHEEL SET (waveform) for the manual part.

- B-type: The traditional Tonewheel Sound of B-3/C-3
- Mellow: Sine wave
- Brite: The analog sound represented by X-5

2. CLICK - ATTACK LEVEL

This allows you to set the Key-Click VOLUME of the ATTACK (= when you touch the key). The larger the value, the louder it gets. No key-click at 0.

NOTE: When this parameter is changed, also 4. Envelope - Attack Rate will be changed to its suitable value automatically.

3. CLICK - LPF

This allows you to set the tone of the Key-Click.

The setting range is 0 - 127. The larger the value, the brighter it gets.

4. ENVELOPE - ATTACK RATE

This allows you to set the speed of the Drawbar at Attack (when you touch the key).

The more the value, the slower it gets. The volume will be maximum (= loudest) at 0 at the time you touch the key.

5. CLICK - RELEASE LEVEL

This allows you to set the volume of the Key-Click at RELEASE (= when you release the key). The larger the value, the louder it gets. No Key-Click at 0.

NOTE: When this parameter is changed, also 6. Envelope - Release Rate will be changed to its suitable value automatically.

6. ENVELOPE - RELEASE RATE

This allows you to set the Decaying Speed of the Drawbar Sound at Release (when you release the key). The higher the value, the slower the RELEASE gets. The sound dies at 0 at the same time as you release the key.

7. FOLD-BACK - LOW

This allows you to set at which key the 16' Drawbar starts the FOLD-BACK. (Fold-back: Repeating the same octave in a certain range on the keyboard.)

The first key (= the far left key on the manual, next to the Preset Keys) is displayed as "1C". The setting range is 1C - 2C.

tips TONE-WHEEL SET

Each Tone-wheel Set allows you to make finer adjustment. (P. 64)

tips KEY-CLICK

The "Key Click" is the noise heard every time the key is touched or released on the B-3/C-3, as the voice is generated by mechanically switching ON and OFF on these models. The function on this model simulates the good old noise.

Loudness

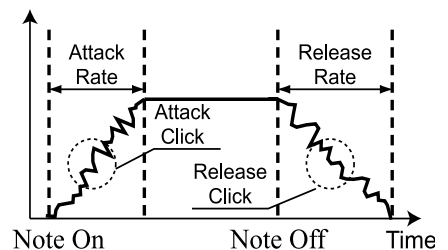

oscillation of
Tone-Wheel

Env - At. Rate = 0: **Pop**

Env - At. Rate = 8: **Smooth**

Note On

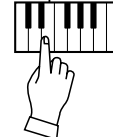

tips FOLD-BACK

As the number of the tonewheels was limited on the B-3/C-3, the organs were designed to repeat the same octave in the upper-most or lower-most range. The feature of this model is to simulate that.

8. FOLD-BACK - HIGH

This allows you to set which key the 1' Drawbar starts to FOLD-BACK (= repeat the same octave) in the upper-most range. The set range is 4G - 5C.

NOTE: The FOLD-BACK can be set not only on the 1' but also 1 1/3', 1 3/5', 2' and 2 2/3' Drawbars.

◆Setting the PEDAL

9. TONE-WHEELS

This allows you to select the Tone-wheel waveform of the PEDAL.

- Normal: The traditional B-3/C-3 Tone-wheel sound
- Muted: Analog sound represented by the X-5.
- Synth1: Sawtooth waveform with swept filter.
- Synth2: Dull square waveform.

NOTE: You can come to this page by holding down the [MANUAL BASS] Button as well.

10. ATTACK

This allows you to set the Attack Rate and the Key-Click Volume at ATTACK and RELEASE.

- MAX CLK: Immediately attacks and the key-click is loud.
- NORM CLK: Immediately attacks and the key-click is normal.
- SOFT CLK: Immediately attacks and the key-click is soft.
- NO CLK: A slightly slower attacks without key-click
- SLOW ATK: Slow attack without key-click

11. DECAY RATE

This allows you to determine whether to keep voicing or to decay, or set the decay time, while holding down the key.

The setting range is 1 - 5 and C. The longer the value gets, the longer gets the decay time. No decay at C.

12. SUSTAIN - ON

This allows you to set whether or not to use the Sustain function.

13. SUSTAIN - LENGTH

This allows you to set the Release Rate (= the decay time after you release the key), when the SUSTAIN - ON (item #12) is ON.

1 is the shortest. And 5 is the longest.

14. VELOCITY

This allows you to set the response to the Velocity. The setting range is OF and 1 - 4.

At OF, the volume does not change however hard you touch the key. As the value increases from 1 - 4, the sound gets louder even if you touch the key softly.

15. KEY MODE

This allows you to set the Pedal polyphony.

- POLY: Makes it possible to play chords (up to 3 notes)
- MONO: Only the lowest note will sound, when you play a chord.

NOTE: The previously released note will be cut when you touch the new one, even when the PEDAL is in the POLY mode and SUSTAIN is ON.

NOTE: When the note-data of the Pedal are received from the MIDI IN terminal while the value of the parameter [MIDI IN] (P. 84 #2) is "IN1/IN2", the Pedal produces polyphonic sound, regardless of the value.

NOTE: All the parameters in these modes are Preset Parameters. They are recorded into the Combination Preset.

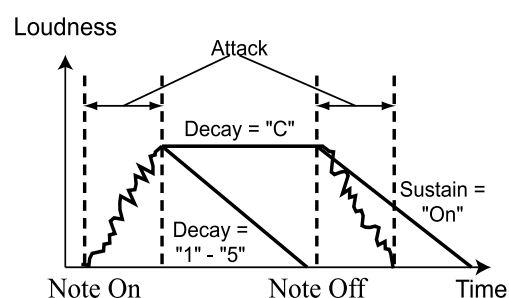

tips SUSTAIN

This is the function that the volume slowly fades out after the key is released, not like that of the synthesizers.

tips VELOCITY

"Velocity" is the speed a key is depressed. When you touch the piano hard, the hammer hits the string hard and so the sound is loud. The organ key is, on the other hand, generally only the switch to open the valve, and so the sound does not change however hard you may touch the key. So this function is effective if you use when the Decay Rate is other than C, or Decay.

In this mode, you can name the Combination Presets.

To locate this mode:

Touch the [MENU/EXIT] button and display MENU, then touch the [PAGE] button to select PAGE A and touch the [2] PRESET button.

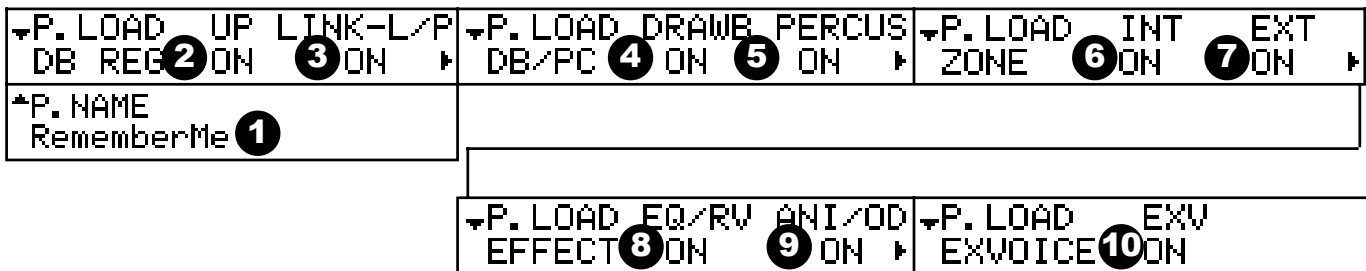

◆PRESET NAME

1. Preset Name (P)

This allows you to name the present Combination Presets using up to 10 letters.

Move the cursor with the [PARAM] button, and choose the letters with the [VALUE] button or the [VALUE] knob.

This change will be lost if you do not record it, same as the other Preset Parameters.

NOTE: The parameters by the names with (P) on the tail are Preset Parameters, and are recorded to each Combination Preset.

◆PRESET LOAD

This allows you to set the operation when you depress the Preset Key.

2. PRESET LOAD - UPPER (B)

This allows you to set whether or not to recall the Drawbar Registration of UPPER Part.

3. PRESET LOAD - LINK LOWER/PEDAL (G)

This allows you to determine whether or not to recall the Drawbar Registration of the LOWER and PEDAL Part.

4. PRESET LOAD - DRAWBAR (B)

This allows you to determine whether or not to recall the Parameters relating to the Drawbars of each Part, such as the Tonewheel Set.

5. PRESET LOAD - PERCUSSION (B)

This allows you to determine whether or not to select PERCUSSION by the Preset buttons other than [ADJUST] key and recall the Parameters relating to Percussion.

6. PRESET LOAD - INTERNAL ZONE (B)

This allows you to determine whether or not to recall the Parameters relating to the Internal Zone such as SPLIT or MANUAL BASS.

7. PRESET LOAD - EXTERNAL ZONE (B)

This allows you to determine whether or not to recall the Parameters relating to the External Zone to control the outside MIDI equipment.

8. PRESET LOAD - EQ/RV (B)

This allows you to determine whether or not to recall the Parameters relating to the EQUALIZER and REVERB.

9. PRESET LOAD - ANI/OD (B)

This allows you to determine whether or not to recall the Parameters relating to VIBRATO, OVERDRIVE and LESLIE.

10. PRESET LOAD - EXTRA VOICE (B)

This allows you to determine whether or not to recall the Parameters relating to EXTRA VOICE.

NOTE: Each Parameter (B) of Preset Load is a Bank Parameter (except Link Lower/Pedal). It is set only for the BANK currently selected. Link Lower/Pedal is a Global Parameter. It is common on all the banks.

EFFECTIVE USE OF LINK-LOWER/PEDAL

This is the function to switch/record only from the connected MIDI equipment, and not to operate the Preset for LOWER and PEDAL on this keyboard.

The Preset Keys on B-3/C-3 are independent, key by key, and so they were operated independently. This function simulates that.

WHEN LINK LOWER/PEDAL IS ON:

When you recall the Combination Preset by the Preset Key, the content of all UPPER/LOWER and PEDAL will change.

If you want to change the Lower to another Preset Key, send the Program Change corresponding with the key by the MIDI keyboard connected to MIDI IN (LOWER) (hereinafter “Lower Keyboard”).

NOTE: Refer to the Appendix for the details on Program Change and Keys.

The recording to the Combination Preset is made to all the UPPER/ LOWER and PEDAL on this keyboard. It is made only to the LOWER on the Lower Keyboard.

To record to the LOWER Preset, send the Program Change from the Lower Keyboard, depressing the [REC/JUMP] button of this keyboard.

WHEN LINK LOWER/PEDAL IS OFF:

If you recall the Combination Preset by the Preset Key of this keyboard, the content of only the UPPER Parts will be switched.

To recall LOWER Part Preset, send the Program Change corresponding to the key by the Lower Keyboard.

To the Combination Presets, on this keyboard, only the UPPER is recorded by the Preset Keys, and only the LOWER is recorded by the Lower Keyboard.

If different Preset Keys are selected between the UPPER and the LOWER/PEDAL, the display will be like this.

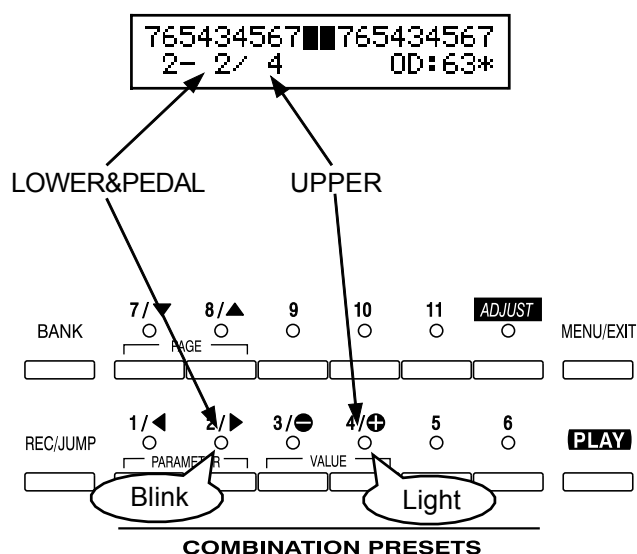

In this mode, you can do the setting relating to each controller.

You may change the roles of several knobs and switches mounted on this keyboard. Also, on the rear panel are two terminals for connecting the Foot-switch and the Expression Pedal. You must choose either of them in this

mode.

To locate this mode:

1. Touch the [MENU/EXIT] button and display the MENU and select PAGE A by the [PAGE] button, and then touch the [4] CONTROL button.
2. Or, you may touch the [CONTROL] button (in default).

↓DISP SH. CUT TIMEOUT 18 1 sec 19 NO		
↕REVERB ASSIGN 17 REVERB		
↕FOOT TIP SW 15 LESLIE S/F ALT	↕FOOT RING SW 16 LESLIE S/F ALT	
↕EXP- SOURCE MON RESS 9 PED (NORM) 10 127	↕EXP. LEV LF-LIM-HF MIN 11 35 12 25 13 30	↕EXP. GAIN MON CALIB 14 100% 10 127
↕MOD LES. SPEED 8 OF		
↕BEND -L&U+ -PED+ RAN 1 12 2 2 3 12 4 2	↕BEND MODE TIME AMP OPT 5 BEND 6 3.5 7 OF	

◆PITCH BEND

1. BEND - L&U DOWN (P)
2. BEND - L&U UP (P)
3. BEND - PEDAL DOWN (P)
4. BEND - PEDAL UP (P)

These are for setting the changing range of the PITCH-BEND WHEEL by the semi-tone. Both the LOWER and the UPPER PARTS change at the same time, as they use the same Tone-Wheels.

The setting range is 0 - 12 for up, 0 - 24 for down.

5. BEND - MODE (P)

It switches the function of the PITCH BEND wheel.

BEND:

You can slide the pitch by rotating the PITCH BEND wheel.

MOTOR:

You can control the TONE-WHEEL motor. The motor turns on when it is in the center or in the neutral position, stops when you rotate it forward (toward yourself), and accelerates when you push it back.

6. BEND - TIME (P)

This sets the time for slowing down to stop or accelerating the motor when it [= MODE(5)] is in the MOTOR mode.

The value ranges from 0.1[s] to 5.0[s].

7. BEND - AMPLIFIER (P)

This decides whether to turn off the amplifier or not by rotating the PITCH BEND wheel forward (toward the player).

tips MOTOR

There is no pitch-bend function on the B-3/C-3. So some musicians turned off the power while playing in order to get that effect.

If the B-3/C-3 is turned off, the Tone-wheel motor gradually slows down and stops, and the amplifier does as well. This function is to simulate that on this model.

tips HOW PITCH BEND MODE WORKS

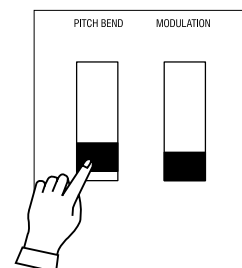

BEND: The pitch immediately falls.

MOTOR: The pitch gradually falls down to the set point.

When the value of this parameter is “OF”, the pitch goes down and the sound gradually fades out.

◆MODULATION

8. MODULATION - LESLIE (P)

Assigns the Modulation Wheel to Leslie Speed Function.

ON: If you push back and pull forward the Modulation Wheel, the speed of Leslie effect changes fast to slow continuously.

OF: Does not function.

◆EXPRESSION

9. EXPRESSION - SOURCE (G)

Determines what to use for operating the Expression.

PED1(NORM):

Uses V-20R etc.

PED1(REV):

Uses KORG XVP-10 etc.

EXP-100:

Uses EXP-100F etc.

MIDI IN:

Uses the Expression Information received at the keyboard channel UPPER.

10. EXPRESSION - MONITOR

Displays the present Expression Value. You can find the causes for such troubles as “no sound”, “non-function” of the Expression Pedal, by checking if the Expression Value changes normally. Also, this can be a guide when you want to play the “fade in” from “quiet”.

11. EXPRESSION - MINIMUM LEVEL (G)

It sets the output level when the Expression is minimum.

The setting range is OFF, -60db to 0db. “OFF” makes no sound when the Expression is minimum, “0dB” does not reduce volume level.

12. EXPRESSION - LIMIT LF (G)

13. EXPRESSION - LIMIT HF (G)

These are for setting the level to maintain for low and high frequencies when the Expression is minimum.

The setting range is OFF, -60dB to 0dB. This function does not work at “OFF”.

Otherwise the level is maintained even if the Expression is minimum.

14. EXPRESSION - GAIN (S)

This is for adjusting the gain (=range of the change) of the connected expression pedal.

It sometimes occurs that, even if you press the expression pedal all the way down, the expression value does not reach the maximum value (127), due to the difference of each expression pedal model from model. In such a case, adjust this parameter for getting the maximum range of the change.

NOTE: This parameter is a System Parameter. This parameter will be recorded when set. It is common in each Combination Preset.

NOTE: The parameters by the names with (P) on the tail are Preset Parameters, and are recorded to each Combination Preset. (G) is for “Global”. These parameters will be recorded when set, and are common in each Combination Preset.

tips BRAKE ON MODULATION

If you want to “Brake” the Leslie effect by pull forward the modulation wheel, set the Slow Speed to “0” on Leslie Parameter (P. 66).

tips EXPRESSION LIMIT

One of the human ear’s characteristics is that, when the volume falls, the sound of high or low frequency becomes difficult to hear.

On this model, it is rectified. The volume is maintained above a certain level even when the volume goes down by using the Expression, in order to keep the sound of high or low frequency audible.

The similar function is adopted on most home audio equipments. It is called the “loudness” function.

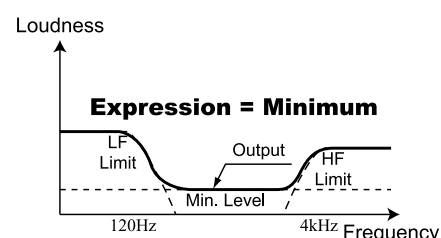
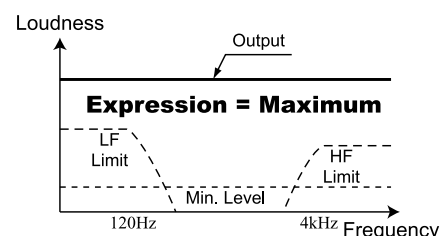

↕DISP SH. CUT TIMEOUT 18 1 sec 19 NO		
↕REVERB ASSIGN 17 REVERB		
↕FOOT TIP SW 15 LESLIE S/F ALT ▶		↕FOOT RING SW 16 LESLIE S/F ALT
↕EXP- SOURCE MON RESS 9 PED (NORM) 10 127	↕EXP. LEV LF-LIM-HF MIN 11 35 12 25 13 30 ▶	↕EXP. GAIN MON CALIB 14 100% 10 127
↕MOD LES. SPEED 8 OF		
↕BEND -L&U+ -PED+ RAN 1 12 2 2 3 12 4 2 ▶		↕BEND MODE TIME AMP OPT 5 BEND 6 3.5 7 OF

◆ FOOT SWITCH

15. FOOT-SWITCH - TIP (G)

This is for setting the function for the Foot Switch 1 terminal.

If you are using the Foot Switch with the stereo plug, this sets the function on the tip side.

OFF:

Does not work.

LESLIE S/F ALT:

LESLIE S/F MOM:

These are for switching SLOW/FAST of the Leslie Effect.

At ALT, it switches at each press and, at MOM, the Leslie effect gets Fast, as long as you keep pressing the foot switch, and it gets Slow if you release it.

DAMPER UPPER:

DAMPER LOWER:

DAMPER PEDAL:

They sustain the Notes of the UPPER, LOWER and PEDAL Parts, respectively, as long as you keep depressing the footswitch.

PRESET FWD:

PRESET REV:

They are for switching one Combination Preset to the right (FWD) or the left (REV).

SPRING:

This is for producing a sound of the old Spring Reverb.

DELAY TIME:

It sets the delay time of the reverb effect (P. 71) along the kicked intervals.

16. FOOT-SWITCH - RING (G)

This is for setting the function on the RING side, if you use the FOOT SWITCH equipped with the Stereo plug.

tips DAMPER

The word "Damper" comes from the damper pedal of the piano.

The piano stops sounding when you release your finger from the key. This is because of the damper system. While you hold the damper pedal, the system does not work and so it keeps sounding even after you release the key.

tips SPRING REVERB

The Spring Reverb is a reverb effect to obtain the reverberation using the spring resilience. It was easily affected by a shock and it used to give a big "clang" if it was bumped.

However, this drawback has come to be used as an effect in the genre of progressive rock. This keyboard gives the simulated sound.

tips TIP AND RING

When you look at the plug of the stereo headphones, there are 3 metal parts. The head portion is called "Tip" and the middle portion is the "Ring". And the part on the cord side is called "Sleeve".

The ordinary foot-switch has only the Tip and the Sleeve, but the footswitch with two switches in one plug or two footswitches using the L/R converting cable can be connected.

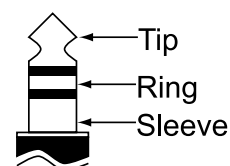

◆EXTRA VOICE / REVERB

17. EXTRA VOICE / REVERB (G)

This is for setting the function for the [EXTRA VOICE / REVERB] BUTTON.

- EXVOICE: Switches the Organ sound and Extra Voice.
- REVERB: Switches On/Off the Reverb Effect.
- PEDAL SUS: Switches On/Off Sustain of the PEDAL.
- EX. ZONE: Switches On/Off the External Zone transmission.
- LOWER OCT: Switches 0/+1 of the LOWER Octave.
- LES. BRAKE: Means the [LESLIE BRAKE] Button.
- LES. ON: Means the [LESLIE ON] Button.
- LES. FAST: Means the [LESLIE FAST] Button.
- LESONREV: Switches On/Off the Leslie On Reverb.

◆DISPLAY

18. DISPLAY - SHORT CUT (G)

It sets the time limit in seconds for the short cut function.

The range is 0s to 2s and NO short cut. The short cut function does not work when the value is in "NO".

19. DISPLAY - TIME OUT (G)

It sets the time limit to return to the previous screen from the one displayed by using the short cut operation.

The range is 4s to 16s and NO time out. The time out function does not work when the value is in "NO".

NOTE: The parameters by the names with (P) on the tail are Preset Parameters, and are recorded to each Combination Preset. (G) is for "Global". These parameters will be recorded when set, and are common in each Combination Preset.

ADJUSTING THE EXPRESSION PEDAL

When you use the expression pedal V-20R, we suggest you follow the adjust procedure as below.

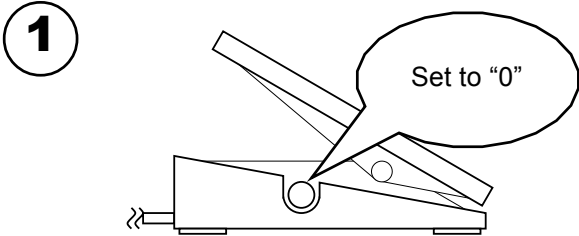

1 Plug-in the Expression Pedal V-20R to the this keyboard, set the Minimum Volume to Zero.

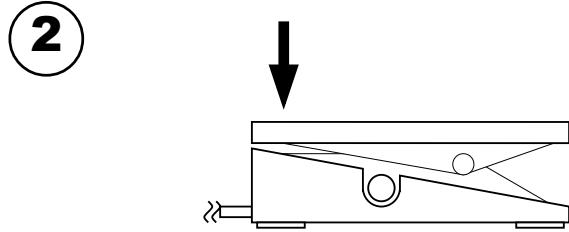

2 Step on the Expression Pedal to the toe side maximum.



3 Set the 9. Expression - Source to "PED (NORM)".

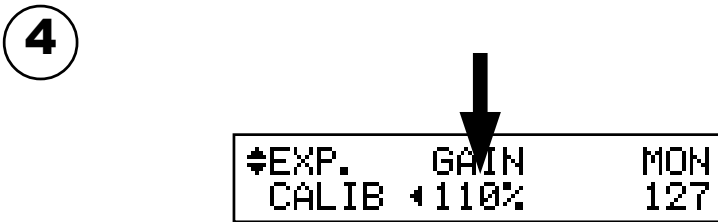

4 Adjust the 14. Expression - Gain to the minimum value that the 10. Monitor displays "127".

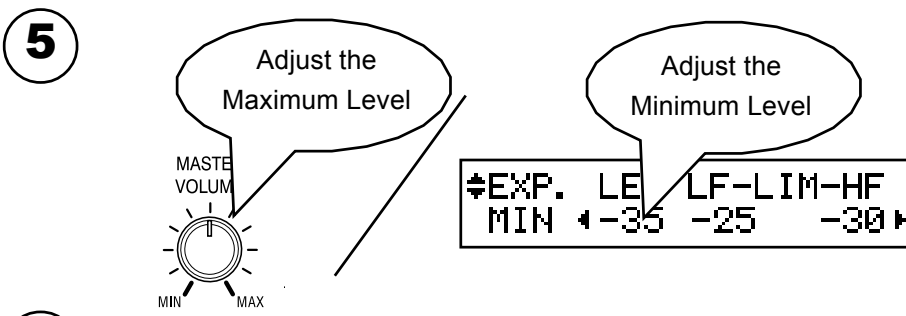

5 Set the Master Volume knob for maximum level that step on the Expression Pedal to the toe side, and set the 11. Expression - Minimum Level for minimum level that step on the Expression Pedal to the heel side.

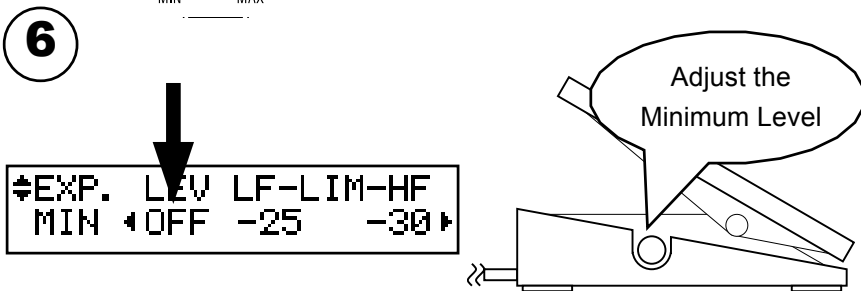

6 Another way to setting the minimum level: Set the 11. Expression - Minimum Level to "OFF", adjusting it using Minimum Volume of the Expression Pedal V-20R.

In this mode, you can tune and transpose for playing in ensemble with the other instruments.

To locate to this mode:

Touch the [MENU/EXIT] button (MENU will displayed), select PAGE A by the [PAGE] button and touch the [3] TUNE button.



1. TRANSPOSE

You can transpose the entire keyboard in semi-tone increments.

The setting range is -6 to +6.

Transpose effects:

- ♦ between the manual keyboard and the built-in sound engine, and
- ♦ between MIDI IN and the built-in sound engine.
- ♦ The Master Course Tune of RPN is sent to the External Zone.
- ♦ If you connect the MIDI Pedalboard XPK-100, the parameter will be changed by the transpose operation, too.

2. MASTER TUNE

This is for changing the PITCH of this entire keyboard.

The setting range is A = 430 - 450 Hz.

NOTE: The parameters in this mode are the Global Parameters. They are recorded when the value is set. Also, they are common at each Combination Preset.

In this mode, you can select and regulate each the Tone-Wheel Set for the Manual Keyboard.

We call this “CUSTOM TONEWHEELS”.

The typical 3 (or 4) types of settings are recorded when delivered from the factory.

To locate this mode:

Touch the [MENU/EXIT] button and display MENU, select PAGE B by the [PAGE] button, and then touch either [1] B-type, [2] Mellow, or [3] Brite button for the desired Tonewheel Set.

Also, the Temporary (= the present setting) automatically switches to the



CUSTOM NUMBER
B-Typ 1:Real B-3

1. CUSTOM NUMBER

This is for selecting the “CUSTOM NUMBER” to use.

Each Custom Number has parameters that wheel-by-wheel “Level”, “Cut Off Frequency” etc.

For example, to the B-type, “Real B-3” simulating the well-preserved B-3/C-3 and “80's Clean” with less leakage noise, rough sound “Noisy”, and “Noisy 60” louder leakage noise is stored.

NOTE: This parameter is a Global Parameter. It is common for the same Tone-wheel Set (= “B-type” here) of each Combination Preset.

NOTE: You can not edit the wheel-by-wheel parameters on this model.

tips LEAKAGE NOISE

On the B-3/C-3, the signal leaks in the route from the pick-up mounted for the Tonewheels to the output terminal, thus noise (= mixed Tone-wheel sound) was also heard, This is called “Leakage Noise”.

The “Leakage Noise” is an obstacle in making pure tones, but it is recognized as a character now. “Mellow” and “Brite” does not include the “Leakage Noise”.

In this mode, you can set the parameter of the PERCUSSION sound.

To locate this mode:

1. Touch the [MENU/EXIT] button and display MENU, then select PAGE B by the [PAGE] button and touch [4] PERCUSS button.
2. Or, hold down either [SECOND],[THIRD],[FAST],or [SOFT] button for a certain length of time.

▼PERC DRAWB	1' CANCEL ON	LEVEL -3dB
◆PERC KBD	TOUCH ON	VEL KTRK OFF
◆PERC DECAY	SLOW 3	FAST 4
▲PERC LEVEL	SOFT 1	NORM 2

1. LEVEL - SOFT

2. LEVEL - NORMAL

These are for setting the Volume of Percussion. SOFT is the volume when the [SOFT] button is ON, and NORMAL is the volume when the [SOFT] button is OFF.

3. DECAY - SLOW

4. DECAY - FAST

These are for setting the Speed of the Decay of the Percussion. SLOW is the speed when the [FAST] button is OFF, and FAST is the speed when the [FAST] button is ON.

The setting range is 1 - 9 and C. The more the value gets, the longer gets the Decay Time. At C, no decay (= continuous).

5. KEYBOARD - TOUCH

This is for setting the method of sound production of Percussion.

ON: If you play legato, the notes including and after the second note do not sound. (The envelope will not be reset.)

OF: Even if you play legato, all the notes produce sound, like the piano.

6. KEYBOARD - VELOCITY

Controls the Volume of Percussion with key Velocity.

ON: The faster a key is pressed, the louder the sound.

OF: It sounds at a certain volume regardless of how fast a key is pressed.

7. KEYBOARD - KEY TRACK

Changes the Percussion Volume by the note.

ON: The higher notes reduce the volume.

OF: It sounds at a certain volume regardless of notes.

8. DRAWBAR - 1' CANCEL

This mutes the 1' of the UPPER PART while using PERCUSSION.

ON: Mute

OF: Does not mute.

9. DRAWBAR - LEVEL

Decreases the volume of UPPER DRAWBARS while using PERCUSSION.

-3dB:Decreases the volume

0dB:Does not decrease the volume

NOTE: This parameter works only when the [SOFT] is OFF.

NOTE: The parameters in those modes are all Preset Parameters. They are recorded to each Combination Preset.

tips TOUCH

The B-3/C-3 had only one built-in Envelope Generator, and was not recharged until all the UPPER Manuals were released. This looks like a drawback, but it had the advantage that the sound did not get loose when chords were roughly played.

tips 1' CANCEL

The B-3/C-3 had no key contact exclusive for percussion but uses the 1' contact for percussion. On this keyboard, this is simulated.

tips DRAWBAR LEVEL

On the B-3/C-3, the Drawbar Volume got slightly smaller, if percussion works This is simulated on this keyboard.

In this mode, you can create your own setting for the built-in Leslie Effect.

There are many parameters for the built-in Leslie Effect, and so you create various settings, but not per each Combination Preset independently.

The parameters are treated by the group called "CABINET". You can select the CABINET NUMBER in the

Combination Presets.

To locate this mode:

1. Touch the [MENU/EXIT] button to display the MENU. Then select PAGE C by the [PAGE] button and touch [3] LESLIE.
2. Or, hold down either [LESLIE BREAK], [LESLIE ON] or [LESLIE FAST].

▾MIC ANGLE DISTANCE ⑩120° ⑪0.6m		
⚡BASS SLOW FAST LEV SPD ⑩36 ⑪393 ⑫0 ▶	⚡BASS RISE FALL BRAK TIME ⑬7 ⑭5 ⑮10	
⚡HORN SLOW FAST LEV SPD ③36 ④393 ⑤0 ▶	⚡HORN RISE FALL BRAK TIME ⑥2.2 ⑦1 ⑧1.2 ▶	⚡HORN CHARACTER TYPE ⑨FLAT
⚡CAB. NAME 147-Type ②		
⚡LESLIE CABINET ①: 147-Type		

◆CABINET NUMBERS

1. LESLIE CABINETS

Here you select the CABINET NUMBER to use in the Combination Presets. The setting range is 1 - 8. The "*" will displayed when the Leslie Parameters are changed from this Cabinet Number.

◆LESLIE PARAMETERS

2. CABINET NAME

This is for putting the Cabinet Names. Move the cursor by the [PARAMETER] button and select letters by the [VALUE]. In this mode, only the present value "Temporary" changes and there is no determining operation. You must record the name by doing "Recording the Cabinet" as explained in the next paragraph. Otherwise the data will be lost.

3. SLOW SPEED - HORN

10. SLOW SPEED - BASS

Here the Speed of the Rotor is set for Slow Speed. The setting range is 0, 24 - 318 rpm. It does not rotate at 0.

4. FAST SPEED - HORN

11. FAST SPEED - BASS

Here the Speed of the Rotor is set for Fast mode. The setting range is 0, 375 - 453 rpm. It does not rotate at 0.

tips

CONCEPT OF THE CABINET NUMBERS

Each Cabinet represents one imaginary Leslie Speaker prepared by the Leslie Parameter. This parameter is the only Preset Parameter in this mode.

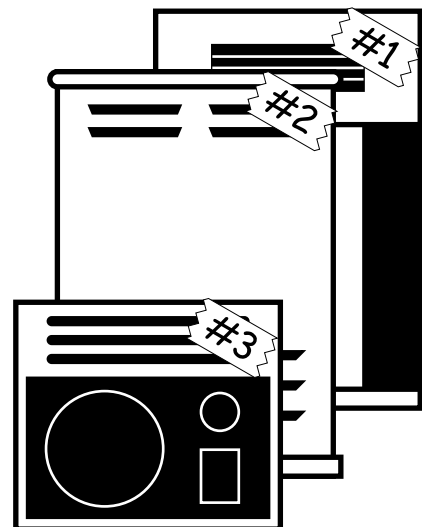

5. HORN LEVEL

12. BASS LEVEL

The Volume of each Rotor is set. The setting range is 0 to -12dB.

6. RISE TIME - HORN

13. RISE TIME - BASS

Here the Time is set for the Rotor to reach the Fast Speed, when you go from Slow or Break to Fast. The setting range for the Horn Rotor is 0.2 - 5.0s, and that for the Bass Rotor is 0.5 - 12.5s.

7. FALL TIME - HORN

14. FALL TIME - BASS

Here the Time is set for the Rotor to reach the Slow speed, when you go from Fast to Slow Speed. The setting range for the Horn Rotor is 0.2 - 5.0s, and that for the Bass Rotor is 0.5 - 12.5s.

8. BREAK TIME - HORN

15. BREAK TIME - BASS

Here the Time is set for the Rotor to stop, when you go from Fast state to Break. The setting range for the Horn Rotor is 0.2 - 5.0s, and that for the Bass Rotor is 0.5 - 12.5s.

9. HORN CHARACTER

Here the Tone of the Horn Rotor is set.

"FLAT" is a flat tone, and the others are the tones with each "peaky" characteristic.

16. MIC - ANGLE

This is the parameter to set the LOCATIONS of the two Microphones for the imaginary Leslie Speaker.

The ANGLE decides the distance between the two mikes.

The setting range is 0 - 180 degrees. The farther, the more stereophonic feeling it gives.

17. MIC - DISTANCE

This is the parameter to set the DISTANCE between the imaginary Leslie Speaker and the Microphones.

The setting range is 0.3 - 2.7m. The more the value increases, the less effective it gets.

NOTE: When you operate the parameters 2 - 17, the setting range will be lost after the power is switched off, if you do not do the recording operation of the next page.

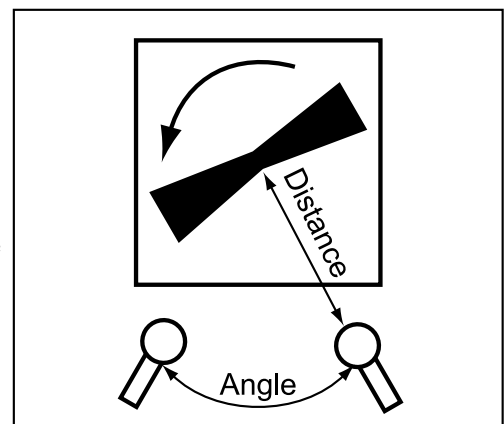
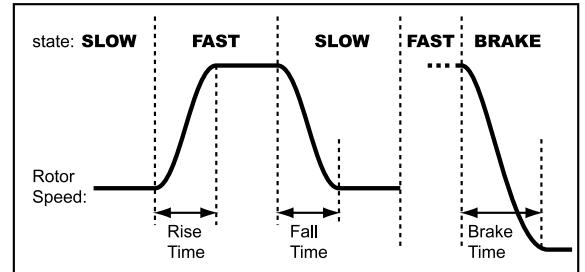

RECORD THE CABINETS

The Leslie parameters (2 - 17 of the previous paragraph) can be recorded with the Cabinet Numbers, and you can choose and use them in each Combination Preset.



Enter the name for the Cabinet as you want.

2

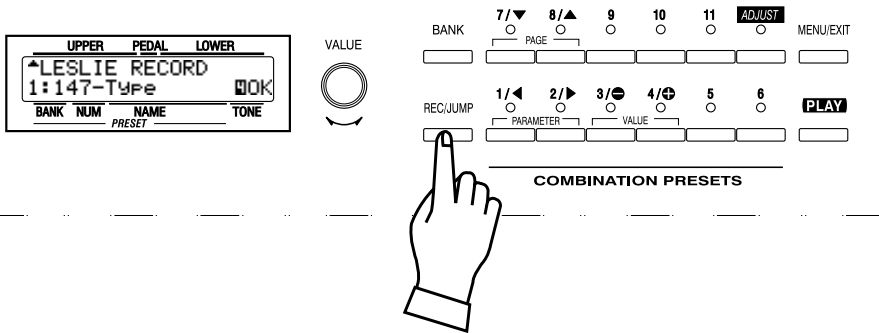

Touch the [REC/JUMP] button in the setting mode of the Leslie Parameter.
The Cabinet Selection mode is displayed.

3

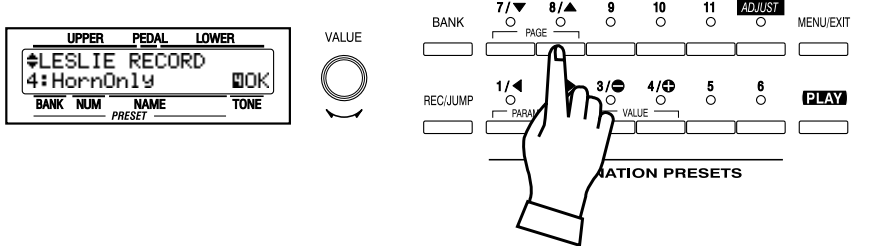

Select the Cabinet Number to record by the [PAGE] button.

4

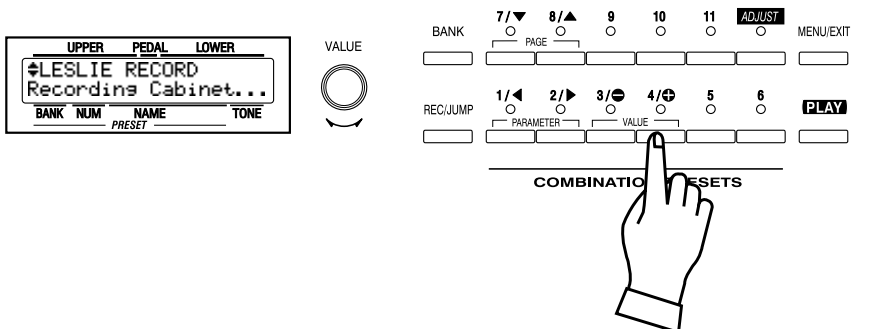

Touch [4] OK, and it is recorded.
The display during the recording treatment shows as illustrated.

NOTE: If you do not want to record, just touch the [MENU/EXIT].

In this mode, you can change the setting relating to each Effect for Overdrive and Vibrato/Chorus.

To locate this mode:

1. Touch the [MENU/EXIT] button to display the MENU, select PAGE C by the [PAGE] button, and then touch the [1] OD/VIB button.
2. Or, hold down the [O.D. ON] button for a while (OVERDRIVE page), [V1/C1], [V2/C2] or [CHORUS] button for a while (VIBRATO/CHORUS page).

▾VIB V1 V2 V3 DEPTH 6 13 7 10 8 14	▾VIB C1 C2 C3 DEPTH 9 8 10 11 11 14
⬆VIB RATE TREM V&C 3 5.83Hz 4 10	⬆VIB EMPHASIS CHO. 5 9
*OD DRIV EXP. MAST 1 15 2 EX+OD	

◆OVERDRIVE

1. DRIVE

This is for adjusting the Overdrive Value.
 The higher value gets, the more distortion you can get.
 This is linked with the [OVERDRIVE] knob on the front panel.
 The setting range is 0 to 63.

2. EXPRESSION

This is for varying the amount of Overdrive by changing the Expression value.

EX→OD:

If you operate the Expression pedal, not only the volume but also the distortion will be changed.

OD→EX:

The Expression pedal affects only the volume and not the distortion value.

OD ONLY:

The Expression pedal affects only the distortion value and not the volume.

6. VIBRATO - DEPTH V1

7. VIBRATO - DEPTH V2

8. VIBRATO - DEPTH V3

9. VIBRATO - DEPTH C1

10. VIBRATO - DEPTH C2

11. VIBRATO - DEPTH C3

These are for setting the Depth of the each Vibrato/Chorus Effect mode.

The setting range is 0 - 15.

NOTE: The parameters in these modes are Preset Parameters and are recorded to each Combination Preset.

◆VIBRATO/CHORUS

3. VIBRATO - RATE

This is for setting the Speed of the Vibrato/Chorus Effect.
 The setting range is 6.10 - 7.25 Hz.

4. VIBRATO - TREMOLO

This is for setting the Tremolo (amplitude modulation) of the Vibrato/Chorus Effect.
 The setting range is 0 - 15.

5. VIBRATO - EMPHASIS

This is for setting the Emphasis (boost the high frequency) of the Chorus Effect (C1/C2/C3).
 The setting range is 0 - 9dB.

EQUALIZ (EQUALIZER)

In this mode, you can change the setting for the Equalizer.

Equalizer is an effect to adjust the tonal quality. The built-in Equalizer consists of 3 bands. With the 3 bands from bass to treble, you can boost or cut them.

To locate this mode:

1. Touch the [MENU/EXIT] button for the MENU, select PAGE C by the [PAGE] button, and then touch the [2] EQUALIZE button.
2. Touch and hold the [TONE TYPE] button.

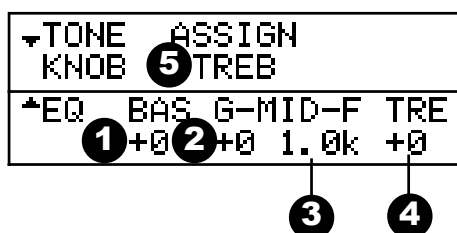

1. EQ BOOST/CUT - BASS
2. EQ BOOST/CUT - MIDDLE
4. EQ BOOST/CUT - TREBLE

This is for changing the Boost/Cut of Bass, Mid-range and Treble respectively.

The setting range is -9 to +9. The gain is flat at 0.

3. EQ FREQUENCY - MIDDLE

This is for changing the center frequency range - Middle (item #2).

The frequency center range is 480Hz - 2.9kHz.

5. TONE - ASSIGN

This function allows you to assign any of the EQ bands, Bass, Middle or Treble, to the [TONE] knob. You can change this while playing.

NOTE: These parameters are Preset Parameters and are recorded to each Combination Preset.

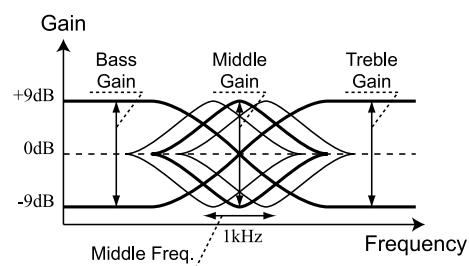

tips

THE EFFECTIVE USE OF THE MIDDLE FREQUENCY

The frequency response of the horn rotor in the Leslie speaker is not flat. It has a peak from 1kHz to 3kHz that sensitive range for human ears.

When you use this keyboard on line out, without Leslie speaker, you can get the similar effect by setting the FREQUENCY - MIDDLE to about 2kHz, and the GAIN - MIDDLE to "+".

tips PRESET PARAMETERS

Equalizer is a Preset Parameter, designed to actively use as one of the tone-making parameters.

However, it is not practical to use Equalizer as a tonal complementary tool to match the location. In such a case, if you switch OFF the PLOAD RV/EQ in the PRESET function mode, the Equalizer value does not change when the preset is recalled. (P. 56)

In this mode, you can change the setting for the REVERB EFFECT.

To locate this mode:

1. Touch the [MENU/EXIT] button for the MENU display, select PAGE C by the [PAGE] button, and then touch the [4] REVERB button.
2. Or, hold down the [EXTRA VOICE / REVERB] button for a while .

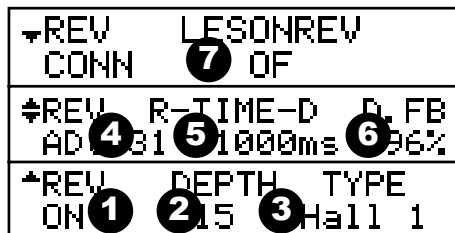

1. REVERB ON

This parameter switches on/off the Reverb Effect.

You can link this parameter with the [EXTRA VOICE / REVERB] button on the front panel. (P.61)

2. DEPTH

This sets the Depth (= Volume) of the Reverb Effect.

The setting range is 0 - 15. If you increase the value, it will give the audience the impression that the player is performing in a larger room.

3. TYPE

This sets the Types of Reverb Effect.

- Room 1: Inside the room (short)
- Room 2: Inside the room (long)
- Live: Live house
- Hall 1: Concert Hall (long)
- Hall 2: Concert Hall (short)
- Church: Church
- Plate: Iron-plate Reverb
- Delay: Delay
- PanDly: Panning Delay
- RevDly: Reverb + Delay

4. REVERB TIME

When the Type (3) is set at Room 1 to Plate, it sets the Time for Reverb to fade out.

The setting range is 0 - 31. The higher the value, the greater the impression of large building.

5. DELAY TIME

When the Type (3) is set at Delay, PanDly, RevDly, it sets the delaying time.

The setting range is 4.7 - 1000 ms. The higher the, the longer the delay gets.

6. DELAY FEEDBACK

When the Type (3) is at Delay, PanDly, RevDly, it sets the amount of the Feedback. (The delaying sound repeats.)

The setting range is 0 - 96%. The more value, the higher Feedbacks you get.

6. LESLIE ON REVERB

This sets the route of the Reverb and Leslie Effect.

- OF: Leslie to Reverb
- ON: Reverb to Leslie

NOTE: These parameters are Preset Parameters and are recorded to each Combination Preset.

tips PRESET PARAMETERS

Reverb is a Preset Parameter, designed to be actively used as one of the tone-making parameters.

However, it is not practical to use Reverb as a tonal complementary tool to match the room/stage/hall. In such a case, if you switch off the PLOAD RV/EQ in the Preset function mode, the Reverb On/Off value does not change when the preset is recalled. (P. 56)

In this mode, you can return entirely or partially to the default setting as set at the factory.

To locate this mode:

Touch the [MENU/EXIT] button for the MENU display, select PAGE D by the [PAGE] button, and then touch the [3] DEFAULT button.

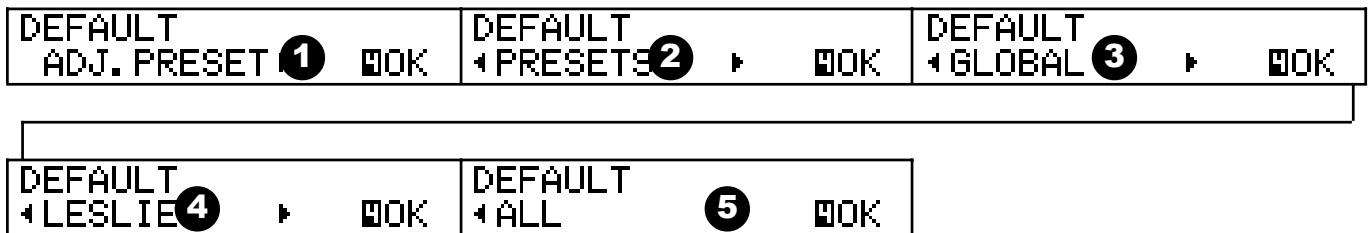

To initialize each parameter, touch the [PARAM] button and then [4] OK.

1. ADJUST PRESET

Initializes the content of the Preset Key [B].

If the Drawbar Control mode is at “UPPER A#/B”, the content of [A#] is also initialized.

If you do this operation before you start a new setting, you can start from the factory setting.

2. PRESET

Initializes the content of all Combination Presets.

3. GLOBAL

Initializes the Global Parameters such as Master tune or assignment of the Foot Switch.

4. LESLIE

Initializes the content of all Cabinets.

5. ALL

Initializes all parameters of this keyboard.

If anything caused an unstable trouble on this keyboard system, the trouble would be cleared.

NOTE: You can also totally initialize your keyboard by switching the Power ON while touching the [REC/JUMP] button.

In this mode, display information of this keyboard.

To locate this mode:

Touch the [MENU/EXIT] button to display the MENU, select PAGE D by the [PAGE] button, and then touch the [4] SYSTEM button.

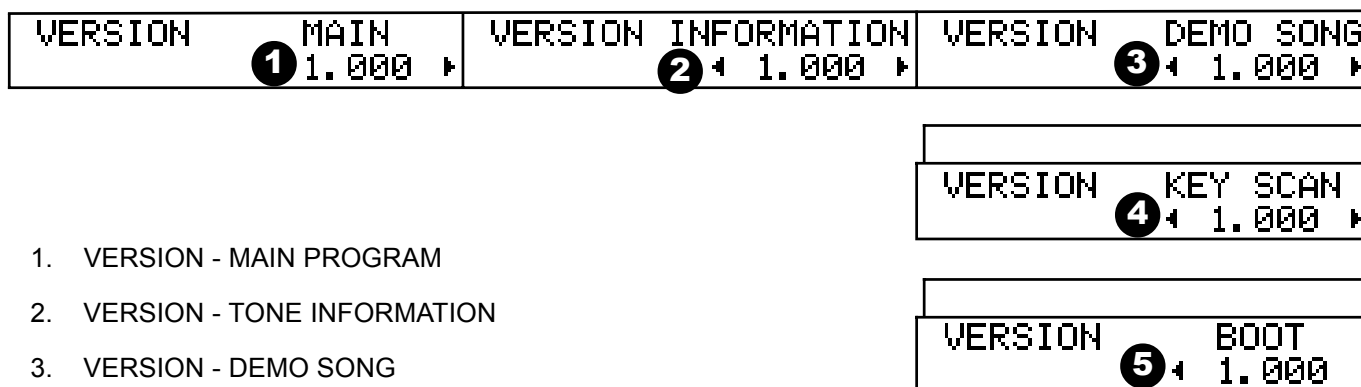

1. VERSION - MAIN PROGRAM
2. VERSION - TONE INFORMATION
3. VERSION - DEMO SONG
4. VERSION - KEY SCAN PROGRAM
5. VERSION - BOOT PROGRAM

These are the versions of each software built in this keyboard.
 These are only for displaying, and not items to set.

In this mode, you can set the EXTRA VOICE.

Your keyboard has built-in tones such as Electric Piano and Clavi., to which you can switch from Drawbar or Percussion voice.

To locate this mode:

Touch the [MENU/EXIT] button to display the MENU, select PAGE F by the [PAGE] button, and then touch the [1] EXVOICE button.

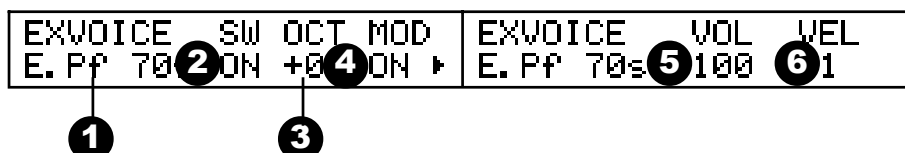

1. INSTRUMENT

Selects the Extra Voice instrument.

- EPf60's: Narrow range Old style Electric Piano.
- EPf70's: Electric Piano of the 70's, very popular in Jazz and Fusion.
- EPf80's: Electric Piano in the 80's with brilliant tones suitable for ballades.
- Clav 1: Vintage sound Clavi.
- Clav 2: Bright Clavi.
- Vibes: Vibraphone suited for Leslie effect.
- Saw Lead: Synth Lead using Sawtooth waveform.
- Funny Ld: Synth Lead with sweep filter.

2. SWITCH

Switches ON/OFF the Extra Voice. This is linked with the [EXTRA VOICE / REVERB] button on the front panel in default.

If switched ON, the Drawbars of UPPER / LOWER and Percussion do not sound, and, instead, the Extra Voice sounds.

3. OCTAVE

Sets the Pitch of the Extra Voice.

The setting range is -2 - +2 Octave.

4. MODULATION - EXTRA VOICE

Assigns the Modulation Wheel to Extra Voice.

- ON: By moving back the Modulation Wheel, Tremolo, Wah or Vibrato effect is added to the Extra Voice.
- OF: Does not function.

5. VOLUME

Sets the Volume of the Extra Voice.

6. VELOCITY

Sets the Response to the Velocity of the Extra Voice.

The setting range is OF, 1 - 4. At OF, the sound comes out at a certain volume regardless of the key pressure, and at 1 - 4, the higher the value, the louder the sound, even if the key is hit lightly.

tips EXCLUSIVE USAGE

While using the EXTRA VOICE, the Drawbars for the UPPER and LOWER Parts or Percussion do not sound.

tips EFFECTS AVAILABLE

The Effects to be added to the Extra Voice are OVERDRIVE, EQUALIZER, LESLIE and REVERB. VIBRATO/CHORUS is not available.

tips PLAY MODE

The Play mode when the Extra Voice is "On", the Extra Voice instrument is displayed instead of Upper Drawbar registration. And you can choose the Extra Voice instrument by [VALUE] knob.

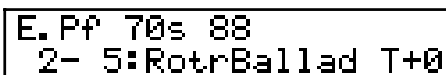

NOTE: The presets in these modes are the Preset Parameters, and are recorded to the Combination Presets.

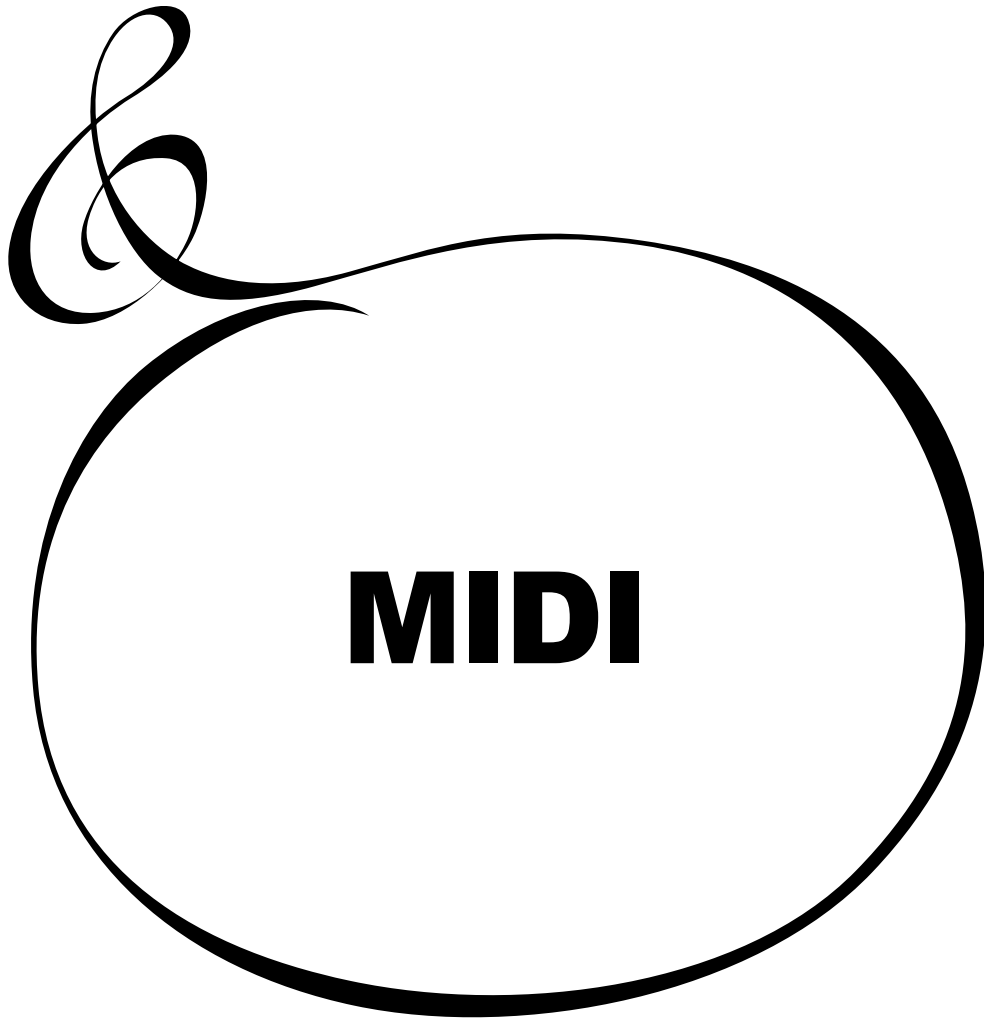

What is “MIDI”?

MIDI stands for Musical Instrument Digital Interface. (The capital letters of these four words.)

MIDI is for exchanging the performance information between an electronic musical instrument and a sequencer etc.

MIDI is an international standard, by which instruments made by different manufacturers can be connected to communicate with each other.

The control information is exchanged, such as the performance information. of a key being touched/released and the tone being switched, the damper pedal being pressed/released.

MIDI TERMINALS ON THIS KEYBOARD

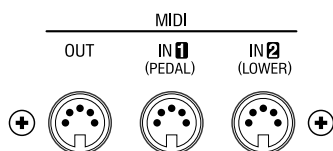

MIDI OUT

Sends Performance Informations.

MIDI IN 1 (PEDAL)

MIDI IN 2 (LOWER)

These receives the MIDI Signal. Each MIDI terminal is set to do the same function, when this keyboard is delivered from the factory.

NOTE: Each MIDI IN terminal can be set for exclusively receiving the LOWER and PEDAL PART. (P. 84)

WHAT THE MIDI CAN DO ON YOUR KEYBOARD

On this keyboard, the MIDI terminals are intended to do the following:

- ♦ expand the keyboard and use this as an organ.
- ♦ record or playback your performance to external computer or sequencer.
- ♦ control the external sound source such as a synthesizer and a sampler.

Also, to do the setting simply, a “MIDI Template” function is available.

MIDI CHANNEL

MIDI has the “MIDI CHANNELS” 1 - 16. Thus, you can send your playing information divided into 16 channels through one MIDI cable.

However, the channel must match between the sender and the receiver. Otherwise, you can not “hear” what the other “says”.

MAJOR MIDI MESSAGE

The MIDI information is grouped into the channel message for each of the 16 channels and the system message for the total channels. The main MIDI message is as follows: See for details in the MIDI IMPLEMENTATION CHART.

CHANNEL MESSAGE

◆ NOTE ON

This is for the 3 datafunctions: which key (Note Number), at what Speed (Velocity) and Play (Note ON).

The sound engine of this keyboard receives velocity only for Percussion and Pedal. Manual Drawbars play at a certain volume, regardless of the velocity.

◆ PROGRAM CHANGE

KEYBOARD CHANNEL:

Switches the Combination Presets.

EXTERNAL ZONE:

Switches the program of the External Sound Modules.

◆ CONTROL CHANGE

Data will be sent/received corresponding to the action of the Expression Pedal, Foot Switch, Modulation, etc.

SYSTEM MESSAGE

◆ SYSTEM EXCLUSIVE MESSAGE

These messages are for sending and receiving the characteristic data between the same models or the products made by the same manufacturer.

This keyboard has the Memory Dump (transmit the all of setup) and can record the data to the External Sequencer.

MIDI STRUCTURE OF THIS KEYBOARD

The XK-1 has only a single keyboard but the sound engine has the three parts: UPPER, LOWER and PEDAL.

Also this has three “EXTERNAL ZONES” to control the external MIDI equipment.

For these reasons, there are 6 MIDI CHANNELS on this keyboard.

Keymap Overview

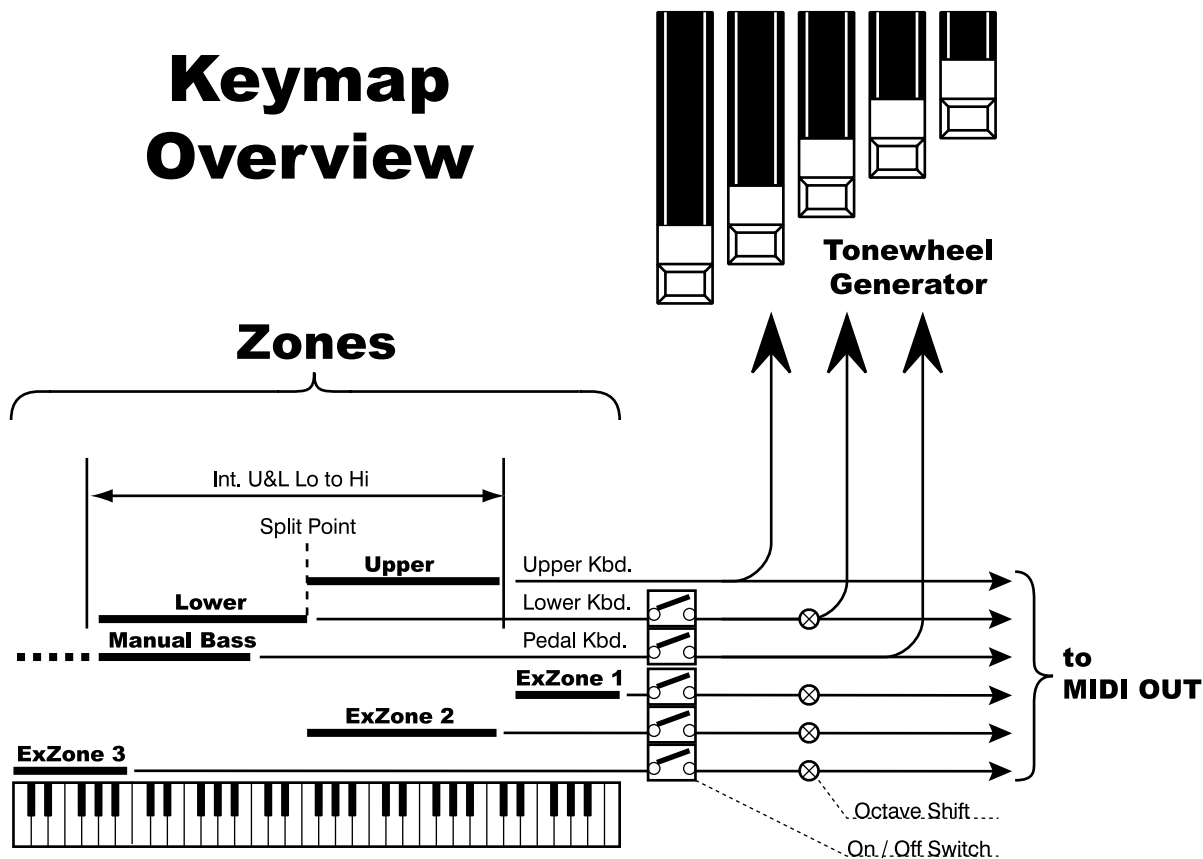

◆ KEYBOARD CHANNEL

UPPER

This is for sending and controlling the UPPER Part performance information, switching the Combination Presets and sending/receiving Expression.

LOWER

This is for the LOWER Part performance information not only for controlling but switching data of the Preset for the LOWER Part independently.

PEDAL

This is for sending and receiving the PEDAL Part performance information and controlling.

◆ EXTERNAL ZONE CHANNEL

EX. ZONE 1, EX. ZONE 2, EX. ZONE 3

You can use your XK-1 as a simple Master Keyboard, by assigning the range of the full scale keyboard through the channel to control each External MIDI equipment. You can have different settings for each Combination Preset.

This is the method how to connect the XK-1 to the MIDI keyboard and play on the full manual (3 keyboard) instrument.

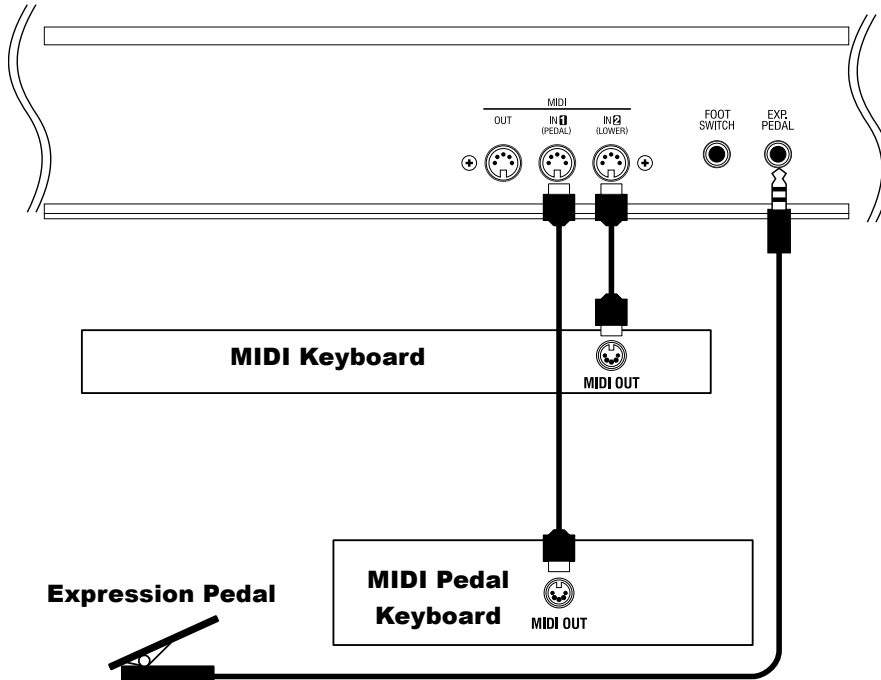

1. Hook up as shown above.
2. Recall "Seq. Record" by using a MIDI template.

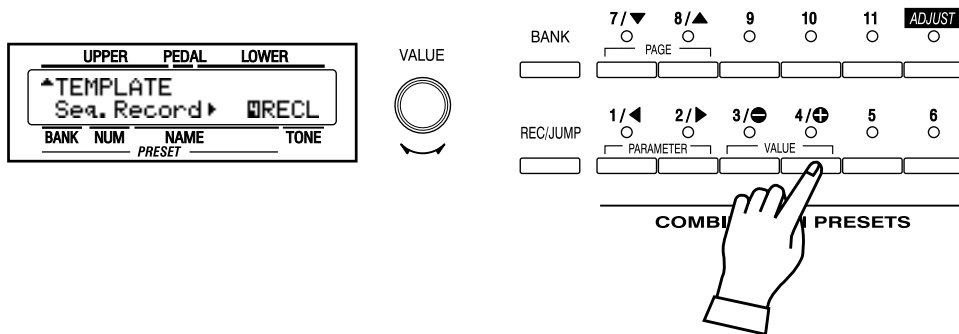

3. If you use the Expression Pedal, set the "Expression Source" corresponding to the connected Expression Pedal. (P. 59)

When you play the MIDI keyboard connected to the MIDI IN (LOWER) terminal of the XK-1 (LOWER keyboard), the LOWER Part will sound, and when you play the MIDI pedal keyboard connected to the MIDI IN (PEDAL) terminal, the PEDAL Part will sound. Also, if you send the Program Change by the LOWER Keyboard, the Preset of the LOWER Part will be switched.

The Manual Bass Function is effective on the Lower Keyboard instead of the XK-1 Manual.

This is the method to record and playback your performance, by connecting the Sequencer or Computer to your XK-1.

◆Recording to the Sequencer or the Computer

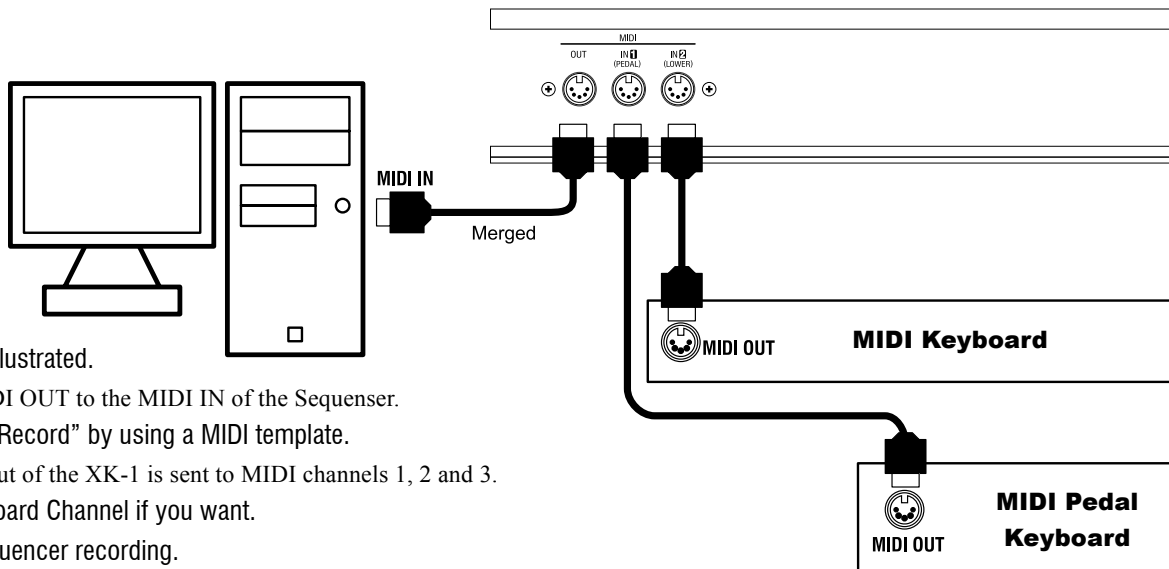

1. Hook up as illustrated.

Connect the MIDI OUT to the MIDI IN of the Sequencer.

2. Recall "Seq. Record" by using a MIDI template.

By this, the output of the XK-1 is sent to MIDI channels 1, 2 and 3.

3. Set the Keyboard Channel if you want.
4. Start the Sequencer recording.
5. Send the Memory Dump if you want.
6. Start playing.

NOTE: If the MIDI Keyboard is connected to the MIDI IN terminal of this keyboard, these performance information will be transmitted to each MIDI channel and sent out of the MIDI OUT terminal.

◆Playback from the Sequencer or the Computer

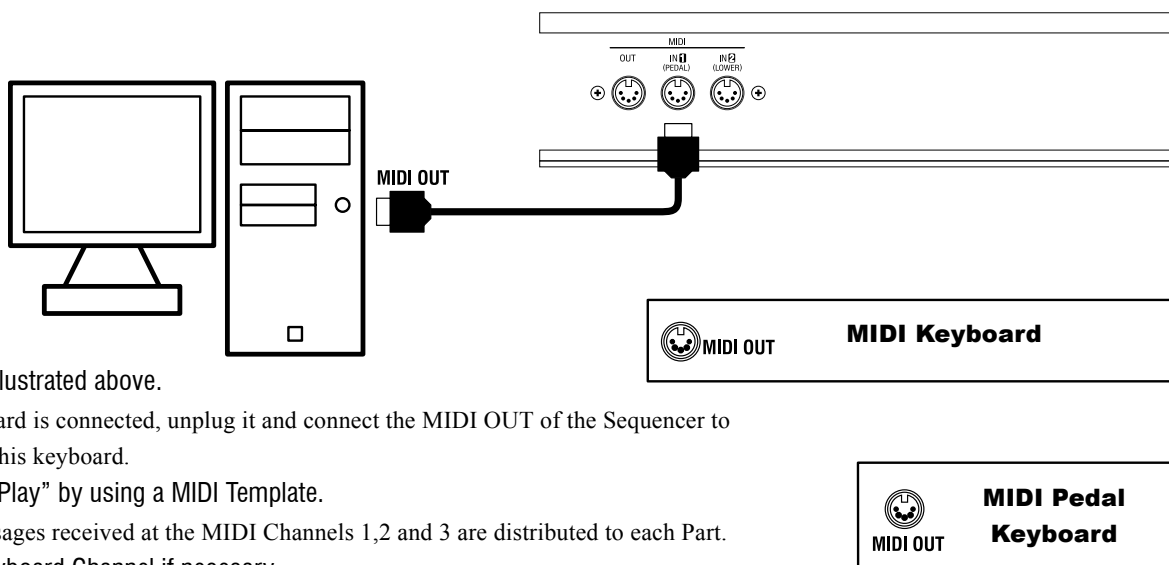

1. Hook up as illustrated above.

If a MIDI keyboard is connected, unplug it and connect the MIDI OUT of the Sequencer to the MIDI IN of this keyboard.

2. Recall "Seq. Play" by using a MIDI Template.

By this, the messages received at the MIDI Channels 1,2 and 3 are distributed to each Part.

3. Setup the Keyboard Channel if necessary.
4. Start Playback on the Sequencer.

❖ *Only the built-in sound source can be recorded. The control of the External Zone is not played back.*

You can control External MIDI Equipment such as a Sound Modules, upto 3 Zones by your XK-1.

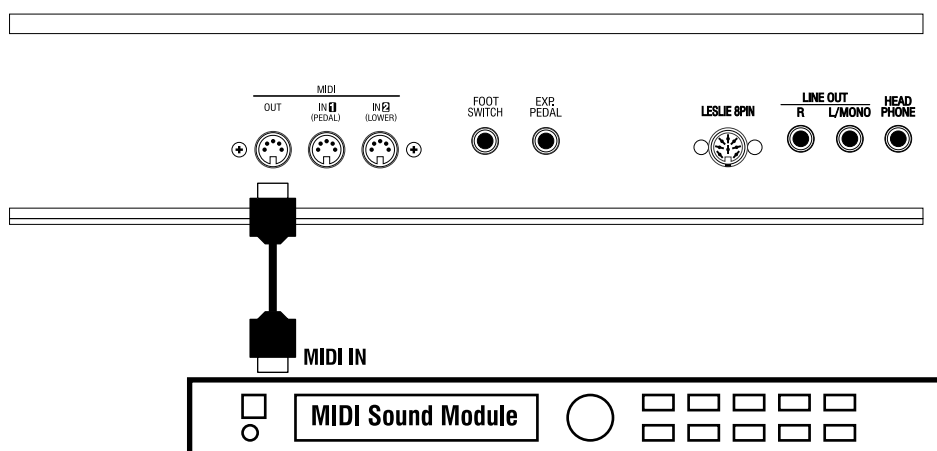

1. Hook up as illustrated above.
Connect the MIDI OUT to the MIDI IN of the Equipment you want to control.
2. Recall the MIDI template "Use EX Zone".
By this, the transmission of the Keyboard Channel stops and the infos. of the External Zone is sent from MIDI OUT.
3. Set the Zone, and the data is recorded to the Combination Preset, if necessary.
See "ZONES" on the next page for how to set the Zone.

To control the external sound module, a certain range of the manual keyboard of this keyboard is used for that. Each of them is called the “EXTERNAL ZONE”. At the same time, you can set the playing range (= “INTERNAL ZONE”) of the built-in sound engine and play on the same single keyboard.

To locate this mode:

Touch the [MENU/EXIT] button to display the MENU, select PAGE D by the [PAGE] button, and then touch [1] ZONES.

EX3 CH ZONE 3	LO-MAP-HI 1C 2B	EX3 M-BNK-L PROG 0 0 1	EX3 OCT VOL PAN VEL NOTE +0 100 -C- OF
EX2 CH ZONE 2	LO-MAP-HI 1C 2B	EX2 M-BNK-L PROG 0 0 1	EX2 OCT VOL PAN VEL NOTE +0 100 -C- 2
EX1 CH ZONE 6 1 7 3C 8 6C	LO-MAP-HI 3C 6C	EX1 M-BNK-L PROG 9 0 10 0 11 1	EX1 OCT VOL PAN VEL NOTE +0 100 14 -C- 15 2
INT PED ZONE 1 3C 2 1C 3 6C	LO-L&U-HI 3C	INT POINT SPLIT 4 3C	L OCT 5 +1

◆INTERNAL ZONE

1. PEDAL
2. LOWER & UPPER - LOW
3. LOWER & UPPER - HIGH

This is for setting the playing range of each part of the built-in sound engine by the keyboard.

Set the lowest note at LO and the upper most note at HI. The upper most function of the manual bass is set at PED.

4. SPLIT POINT

If you use the Split function, set the KEY on where to split the LOWER and the UPPER Parts on the keyboard.

The setting value is the highest note used in the LOWER Part.

NOTE: You can jump to this mode by holding down the [SPLIT] button as well.

NOTE: For 1 to 4, you can set the value by touching the [REC/JUMP] button, while holding down a note on the keyboard.

5. LOWER OCTAVE

This is for setting the pitch of the split LOWER Part by the octave.

If you use the SPLIT function, the pitch of the LOWER Part may go down too low for the harmony play. In that case, you can move up the Lower octave upto the pitch suitable for harmony play.

◆EXTERNAL ZONE

6. MIDI CHANNEL

This is for choosing the MIDI channel to send to the External Zone.

The range is 1 - 16 and OF. At 0, no sending to this Zone.

7. MAP - LOW

8. MAP - HIGH

This is for setting the playing range of this zone on the keyboard.

NOTE: For 7 and 8, you can set the value by touching the [REC/JUMP] button, while holding down a note on the keyboard.

9. PROGRAM - BANK MSB

10. PROGRAM - BANK LSB

11. PROGRAM - BANK PROGRAM CHANGE

This is for setting the Bank Select and Program Change to send to this Zone.

Generally, the tone of the synthesizer or the Sampler is switched by the Bank Select and the Program Change. There are such models as do not receive the Bank Select. The receiving range is different from equipment to equipment. You can choose 0 - 127 in the Bank MSB and the Bank LSB, and 1 - 128 in the Program Change.

12. NOTE - OCTAVE

This is for moving the octave to send to this zone. You can set the pitch to be sent to the key by the octave, if the desired range is different from that prepared by MAP LO/HI.

▼EX3 MIN-MAX CC# EXP. ◀ 40 127 11:EXP ▶	▼EX3 BND DMP MOD MSGs ◀ON TIP ON
◆EX2 MIN-MAX CC# EXP. ◀ 40 127 11:EXP ▶	◆EX2 BND DMP MOD MSGs ◀ON TIP ON
◆EX1 MIN-MAX CC# EXP. 1640 1727 18:EXP ▶	◆EX1 BND DMP MOD MSGs 19ON 20TI 21ON

13. NOTE - VOLUME

This is for setting the volume (= Control Change #7) of this zone. However, the set value will be null, if the CC# (item #18) is at "7.VOL".

14. NOTE - PAN

This is for setting the Pan (= Control Change #10) of this Zone.

15. NOTE - VELOCITY

This is for setting the Velocity Curve to send to this zone. The setting range is OF, 1 - 4. The velocity of OF is fixed at 100. At 1 - 4, the more the value increases, the intense velocity is sent regardless how light the key is touched.

16. EXPRESSION - MINIMUM

17. EXPRESSION - MAXIMUM

This is for setting the range of the expression to "compress" to send to this Zone.

If the expression pedal is connected to this keyboard, generally, the electronic organ will sound, even when the expression pedal is at minimum, or at 0.

With the GM sound engine, the sound does not come out at the same setting. This parameter is needed to balance it.

You can select 0 - 63 by MIN, and 64 - 127 by MAX.

18. EXPRESSION - CONTROL NUMBER

This is for setting the Control Number of the Expression Pedal. There are various methods for controlling volume, depending on the connected equipment. you can here set the number to control the volume of the connected equipment by this parameter.

19. MESSAGE - PITCH BEND

20. MESSAGE - DAMPER

21. MESSAGE - MODULATION

This is for determining whether or not to send the control information to this zone.

For example, by using two zones, suppose you have set to sound the piano and sax by touching one key. The damper is effective on the piano but strange on sax. On the other hand, Pitch Bend is suitable for sax but not necessary for the piano. Now, you need to limit the message to send to each zone.

ON sends the message, but OF does not.

You can also select which footswitch to use for sending the damper.

OFF:

does not send the damper information.

TIP, RNG:

each sends the damper information by the tip and ring of the footswitch.

NOTE: All the parameters in these modes are Preset Parameters. They can be recorded to the Combination Preset. See the Appendix for details of the Preset Parameters.

This is the mode to do the basic setting of MIDI.

To locate this mode:

Touch the [MENU] button to display the MENU, select PAGE D by the [PAGE] button, and then touch the [2] MIDI button.

↙CH UPPER LOWER PEDL ①① ②② ③③		
♣MAST ② MIDI IN LOWER/PEDAL ▶	♣MAST LOCAL NRPN LES ③ ON ④ ON ⑤ XK ▶	♣MAST PROG REGI WHEL Tx&Rx ⑥ ON ⑦ ON ⑧ ON ▶
▲TEMPLATE ① Seq. Record ▶ RECL	▲TEMPLATE Seq. Play ▶ RECL	▲TEMPLATE Use EX Zone RECL

◆MIDI TEMPLATE

1. MIDI TEMPLATE

This is the mode for setting each function simply.
Typical settings can be recalled, by touching the [PARAM] button to select the usage and touching [4] RECL.

◆MASTER

2. MIDI IN

This is for setting the behavior of the two MIDI IN terminals.

UPPER / PEDAL:

Each MIDI IN terminal acts as a receiving terminal for the LOWER and PEDAL Parts, regardless of the channel.

This assigns the Manual Bass Function to the MIDI IN (LOWER) terminal.

The Split function will be disabled. (Disregard the [SPLIT] Button.)

The input from each MIDI IN terminal will be resent by each Keyboard Channel of 12 and 13.

IN 1/IN 2:

Each acts in accordance with each designated channel.

Assigns the Manual Bass Function to the Manual Keyboard of this keyboard.

The Pedal Part produces polyphonic sound, regardless of the value of the Key Mode (POLY/MONO).

3. LOCAL

This is for switching ON/OFF the LOCAL CONTROL (internal).

If ON, the keyboard of this module and the sound engine are connected.

If OFF, the keyboard and the sound engine are cut off. The keyboard does not sound, if touched.

You can treat this module as if it is a two different equipment: a MIDI keyboard and a Sound Module.

4. NRPN

This is for switching ON/OFF the transmission of (= send and return) of NRPN (Non-Registered Parameter Number). On this keyboard, it switches ON/OFF whether to send/receive the message of Drawbar Fold-Back, Leslie ON, etc. At ON, the message is sent/received. At OFF, the message is not sent.

5. LESLIE

This is for controlling how to send Leslie Parameters.

XK:

The Leslie Parameters will be sent out on XK-1 original NRPN address and data.

21:

The Leslie Parameters will be sent out for Leslie 21 series NRPN address and data.

When the Combination Preset is selected, the parameters are sent out also.

6. PROGRAM CHANGE

This is for switching the sending and receiving of the Program Change/Bank Select by the Keyboard Channel. On this keyboard, this is for switching the Combination Preset using the Program Change and the Bank Select. When ON, this does send/receive. When OFF, no data is sent.

7. REGISTRATION

This is for switching ON/OFF the Drawbar Registration send/receive at the Keyboard Channel.

This is to select whether or not to send/return the information of the movement of each footage of the Drawbars.

When ON, it transmits/receives. When OFF, it does not.

8. WHEEL

This switches ON/OFF the Send/Receive of the Pitch Bend and Modulation information at the Keyboard Channel.

When ON, it transmits/receives. When OFF, it does not.

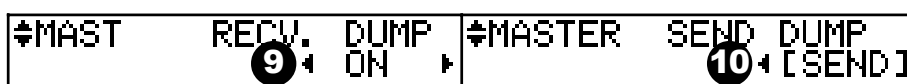

9. RECEIVE DUMP

This is for determining whether or not to receive the MEMORY DUMP.

On this module, you can transmit/receive the current settings by the System Exclusive Message as the MEMORY DUMP, but you must switch this OFF, if you do not want the settings of this keyboard to be changed. When ON, it receives. But, at OFF, it does not.

10. SEND DUMP

This is for sending the MEMORY DUMP.

If you touch [4] SEND in this mode, the whole setup data is sent from the MIDI OUT terminal.

◆KEYBOARD CHANNEL

11. UPPER

12. LOWER

13. PEDAL

This is for setting which MIDI CHANNEL you use to send/receive each Part.

You can choose 1 - 16 and OFF. If OFF, nothing is sent/received.

❖ *To avoid confusion of the MIDI signals, be careful not to duplicate each MIDI channel, including the External Zone.*

NOTE: The settings in this MENU are not recorded in to the Combination Presets. This is common with all Presets.

tips

DETAILS OF THE MIDI TEMPLATES

For the details at each Template's call out, refer to the Appendix.

tips CONTENT OF MEMORY DUMP

The PRESET Parameters, GLOBAL Parameters and SYSTEM Parameters of TEMPORARY (= the current status) are sent and received. The content of each Combination Preset and that of each Leslie Cabinet are sent or received also.

tips THE "PANIC" FUNCTION

When any trouble happens in the MIDI system, it sometimes causes sticking notes(cyphers). In such a case, you can send the command messages "All Notes Off" and "Reset All Controllers" by touching the [BANK] button and the [REC/JUMP] button at the same time. This is called "Panic" function.



TROUBLE SHOOTING

- ◆ **Malfunction of the buttons, the keys, etc.**
 - ◆ Turn off the POWER switch once, then turn it on again. If this procedure is not successful, turn off the POWER switch once. Then, while pressing [REC/JUMP] button, turn the POWER switch on again. (Note that, in this case, all parameters return to their factory-preset status.)
- ◆ **Malfunction of the Combination Presets.**
 - ◆ The Display is in MENU or any FUNCTION modes.
Go back to PLAY mode by touching the [PLAY] button.
- ◆ **No sound is produced when the keys are pressed.**
 - ◆ The MASTER VOLUME is at the minimum setting. Adjust the volume with the MASTER VOLUME control. (P. 10)
 - ◆ The LOCAL CONTROL is set to OFF. Set the local control to ON. (P. 84)
- ◆ **Expression does not change.**
 - ◆ The EXPRESSION - SOURCE is not the correctly set. Set the EXPRESSION - SOURCE in the “CONTROL” screen correctly. (P. 59)
- ◆ **The sound is distorted.**
 - ◆ The sound is distorted not as the [OVERDRIVE] knob screen shows.
If you are playing this keyboard using the Combination Preset, the actual value of the drive is different from the position of the knob.
Turn the [OVERDRIVE] knob to the left, to the point where it is not distorted.
- ◆ **The sound does not come out immediately after switched on.**
 - ◆ The [TUBE AMP] button is ON. A Vacuum Tube circuit is mounted in this keyboard. It takes approximately 10 to 20 seconds after the [TUBE AMP] button is switched ON. Before you will hear the sound.
- ◆ **The sound is not distorted if the [OVERDRIVE] knob is turned.**
 - ◆ When the Overdrive Expression is at “EX→OD” or “OD ONLY”, it does not distort if the value if the Expression is low. In such a case, increase the Expression value, or, set the Overdrive Expression at “OD→EX”, if you want to distort regardless of the Expression value. (P. 69)
- ◆ **The sound stops upon changing the Combination Preset during playing.**

This keyboard stops the sound when the some parameter has changed that listed below;

 - ◆ Internal Zone - Key Range, Octave
 - ◆ Tone-Wheel set
 - ◆ Reverb Type (reverb sound only)

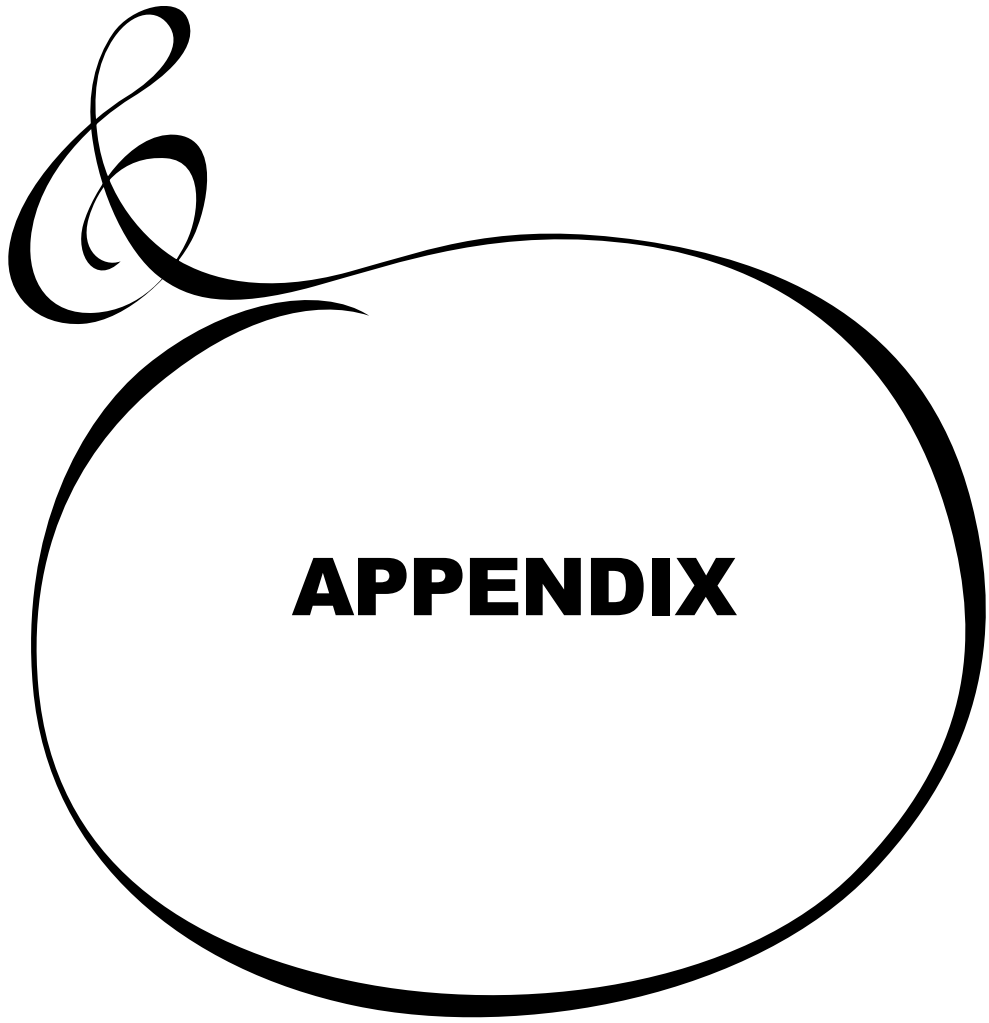

Custom Tone-wheel

B-Type

Real B-3

This template faithfully simulates the classic model, B-3. It contains low motor hum and some leakage noise.

80's Clean

This template simulates the B-3 sounds in the 80's. It contains reduced leakage noise.

Noisy

This template is for passing all sounds of picked-up signal. It contains full motor hum and leakage noise.

Noisy 60

This template boosts noise sounds. It contains full motor hum and leakage noise.

Mellow

Full Flats

This template simulates the most ideal tone-wheel set. Their values are same at each wheel.

Husky

This template has the characteristic of dropped middle range.

Flute Lead

This template has the characteristic of dropped bass and treble, contrasting "Husky".

Brite

Classic X-5

This template faithfully simulates the classic model, X-5. It contains dull triangle waveform and flat output levels on every wheel.

Voxy Full

This template has the most bright sounds. It is suitable for surfin' music.

Cheap Tr.s

This template simulates junk transistor organ. It contains insufficient bass and treble.

MIDI Templates

Template		Seq. Record	Seq. Play	Use Ex.Zone	Data Range
MIDI In		Lower / Pedal	In1 / In2	Lower / Pedal	Lower / Pedal , In1 / In2
Messages	Local Control	On	Off	On	Off/On
	NRPN	On	On	Off	Off/On
	Program Chg.	On	On	Off	Off/On
	Registration	On	On	Off	Off/On
	Wheel	On	On	Off	Off/On
Transmit Channel	Upper Kbd.	1	1	Off	Off, 1 - 16
	Lower Kbd.	2	2	Off	Off, 1 - 16
	Pedal Kbd.	3	3	Off	Off, 1 - 16
Receive Channel	Upper Kbd.	1	1	Off	Off, 1 - 16
	Lower Kbd.	2	2	Off	Off, 1 - 16
	Pedal Kbd.	3	3	Off	Off, 1 - 16
		Use this template for connecting the organ to an external MIDI sequencer <u>without</u> the "Echo Back" function, and recording songs.	Use this template for connecting the organ to an external MIDI sequencer for playing back songs.	Use this template for connecting the organ to an external MIDI sound generator, such as a synthesizer or sound module, and playing it from the organ.	

[Hammond Combo Organ]
Model: XK-1

MIDI Implementation Chart

Date: 15-Oct-2005
Version: 1.0

Function		Transmitted	Recognized	Remarks
Basic Channel	Default Changed	1 1 - 16	1 1 - 16	Upper Channel *1
Mode	Default Messages Altered	3 X *****	3 X X	
Note Number	: True Voice	12 - 120 *****	36 - 96 36 - 96	
Velocity	Note ON Note OFF	O X	O X	
After Touch	Key's Ch's	X X	X X	
Pitch Bender		O	O	
Control Change	0,32	O	O	Bank Select MSB, LSB
	1	O	O	Modulation
	6,38	O	O	Data Entry MSB, LSB
	7	O	X	Volume
	10	O	X	Pan
	11	O	O	Expression
	16	O	O	Spring Shock
	64	O	O	Hold 1
	80,81,82	O	O	Drawbar Reg. U, L, P
	98,99	O	O	NRPN LSB, MSB
	100, 101	O	X	RPN LSB, MSB
120	X	O	All Sound Off	
121	O	O	Reset All Controllers	
Program Change	: True #	O *****	0 - 127 0 - 127	
System Exclusive		O	O	
System Common	: Song Position	X	X	
	: Song Select	X	X	
	: Tune	X	X	
System Real Time	: Clock	X	X	
	: Commands	X	X	
Aux Messages	: Local On/Off	X	X	
	: All Notes Off	O	O	
	: Active Sense	O	O	
	: Reset	X	X	

Mode 1: OMNI ON, POLY

Mode 2: OMNI ON, MONO

O: Yes

Mode 3: OMNI OFF, POLY

Mode 4: OMNI OFF, MONO

X: No

*1: Lower Channel = 2, Pedal Channel = 3

Part and MIDI Messages

	External Zone (Tx. Only)	Upper Keyboard	Lower Keyboard	Pedal Keyboard
Note	O	O	O	O
Pitch Bend	O	O *1	X	O
Modulation (1)	O	O	X	X
Volume, Pan (7, 10)	O	X	X	X
Expression (11)	O *2	O *3	X	X
Hold 1 (64)	O	O	O	O
Drawbar Reg.	X	CC#80	CC#81	CC#82
Spring Shock (16)	X	O	X	X
RPN (100, 101)	O *4	X	X	X
NRPN (98, 99)	X	O	X	X
All Notes Off (123)	O	O	O	O
All Sounds Off (120)	X	O *5	O *5	O *5
Reset All Ctrl. (121)	O	O	O	O
After Touch	X	X	X	X
Bank Select (0, 32)			X	
Program Change	Change voice each zone.	Combination Presets	Lower Presets	Combination Presets

*1: It works for both Upper and Lower.

*2: It works for each zone.

*3: It work for all parts (audio controlled).

*4: Coarse Tune (for transpose)

*5: For Rx. only.

MIDI Information

[Channel Voice Message]

Note Off

Status	2nd Byte	3rd Byte
8n	kk	vv
9n	kk	00

n=MIDI Channel Number: 0 - F(Ch.1 - 16)
 kk=Note Number: 00 - 7F(0 - 127)
 vv=Velocity(disregard): 00 - 7F(0 - 127)

Note On

Status	2nd Byte	3rd Byte
9n	kk	vv

n=MIDI Channel Number: 0 - F(Ch.1 - 16)
 kk=Note Number: 00 - 7F(0 - 127)
 vv=Velocity: 00 - 7F(0 - 127)

Control Change

The value set by the Control Change is not reset even when Program Change messages etc. are received.

Bank Select

Status	2nd Byte	3rd Byte
Bn	00	mm
Bn	20	ll

n=MIDI Channel Number: 0 - F(Ch.1 - 16)
 mm,ll=Bank Number: 00 00 - 7F 7F
 Default Value = 00 00
 This device process the Lower Byte (ll) of the Bank Number as 00. However, when you send the Bank Select, be sure to send both Upper Byte(mm) and Lower Byte(ll). Until you send the Program Change, the Bank Select process is reserved.

Modulation

Status	2nd Byte	3rd Byte
Bn	01	vv

n=MIDI Channel Number: 0 - F(Ch.1 - 16)
 vv=Modulation Depth: 00 - 7F

Volume

Status	2nd Byte	3rd Byte
Bn	07	vv

n=MIDI Channel Number: 0 - F(Ch.1 - 16)
 vv=Volume: 00 - 7F(0 - 127)
 Default Value = 64(100)

It controls the volume of the Part corresponding to the MIDI Channel of the received message. The volume message is used to set the volume balance of each Ex. zone.

Pan

Status	2nd Byte	3rd Byte
Bn	0A	vv

n=MIDI Channel Number: 0 - F(Ch.1 - 16)
 vv=Pan: 00(Left) - 40(Center) - 7F(Right)
 Default Value = 40(64)

Expression

Status	2nd Byte	3rd Byte
Bn	0B	vv

n=MIDI Channel Number: 0 - F(Ch.1 - 16)
 vv=Expression: 00 - 7F(0 - 127)
 Default Value = 7F(127)

Spring Shock

Status	2nd Byte	3rd Byte
Bn	10	vv

n=MIDI Channel Number: 0 - F(Ch.1 - 16)
 vv=Any:

Hold 1

Status	2nd Byte	3rd Byte
Bn	40	vv

n=MIDI Channel Number: 0 - F(Ch.1 - 16)
 vv=Control Value: 00 - 7F(0 - 127) 0-63 = Off, 64-127 = On

Program Change

Status	2nd Byte
Cn	pp

n=MIDI Channel Number: 0 - F(Ch.1 - 16)
 pp=Program Number
 Upper Channel: Change Combination Preset.
 Lower Channel: Change Lower Preset only.

Pitch Bend Change

Status	2nd Byte	3rd Byte
En	ll	mm

n=MIDI Channel Number: 0 - F(Ch.1 - 16)
 mm=Upper Byte
 ll=Lower Byte 00 00(-8192) - 40 00(0) - 7F 7F(8191)

[Channel Mode messages]

All Sounds Off

Status	2nd Byte	3rd Byte
Bn	78	00

n=MIDI Channel Number: 0 - F(Ch.1 - 16)
 When this message is received, all currently-sounding notes on the corresponding channel will be turned off immediately.

Reset All Controllers

Status	2nd Byte	3rd Byte
Bn	79	00

n=MIDI Channel Number: 0 - F(Ch.1 - 16)
 When this message is received, the following controllers will be set to their reset values.

Controller	Reset Value
Pitch Bend Change	±0 (Center)
Modulation	0 (off)
Expression	127 (Maximum)
Hold 1	0 (off)
RPN	unset; previously set data will not change
NRPN	unset; previously set data will not change

All Notes Off

Status	2nd Byte	3rd Byte
Bn	7B	00

n=MIDI Channel Number: 0 - F(Ch.1 - 16)
 When All Notes Off is received, all notes on the corresponding channel will be turned off. However if Hold 1 is On, the sound will be continued until these are turned off.

NRPN MSB/LSB

Status	2nd Byte	3rd Byte	
Bn	63	mm	(MSB)
Bn	62	ll	(LSB)

n=MIDI Channel Number: 0 - F(Ch.1 - 16)

mm=Upper Byte of the Parameter Number designated by NRPN[MSB].

ll=Lower Byte of same[MSB].

The value set by NRPN is not reset even if "Program Change", "Reset All controllers", etc. are received.

NRPN- "Non Registered Parameter Number"

The expansive range named NRPN is provided in the Control Change, which function is specific on each equipment and not defined in the MIDI Standard.

When you use it, designate the parameter to control, by giving NRPN MSB and NRPN LSB (cc#98 and 99), and then set the value of the designated parameter by the Data Entry MSB(cc#6).

Once the NRPN parameter is designated, all the data entry received into the same channel after that is regarded as the change of the value of the parameter. To avoid any mis-operation, we suggest you to set RPN Null (RPN = 7F 7F), after setting the necessary parameter value.

On this sound module you can change the voice parameter by using NRPN.

Data Entry

Status	2nd Byte	3rd Byte	
Bn	06	mm	(MSB)
Bn	26	ll	(LSB)

n=MIDI Channel Number: 0 - F(Ch.1 - 16)

mm,ll=Value for the Parameter designated by RPN/NRPN.

RPN MSB/LSB

Status	2nd Byte	3rd Byte	
Bn	65	mm	(MSB)
Bn	64	ll	(LSB)

n=MIDI Channel Number: 0 - F(Ch.1 - 16)

mm=Upper Byte of the Parameter Number designated by RPN[MSB].

ll=Lower Byte of same[MSB].

The Value set by RPN is not reset by receiving the "Program Change", "Reset All Controllers", etc.

RPN- "Registered Parameter Number"

The expansive range named RPN is provided in the Control Change, which function is specific on each equipment and not defined in the MIDI Standard.

When you use it, designate the parameter to control, by giving RPN MSB and RPN LSB(cc#101 and 100), and then set the value of the designated parameter by the Data Entry MSB(cc#6).

Once the RPN parameter is designated, all the data entry received into the same channel after that is regarded as the change of the value of the parameter. To avoid any mis-operation, we suggest you to set RPN Null, after setting the necessary parameter value.

Master Coarse Tuning

RPN MSB	RPN LSB	DATA MSB
00	02	3A - 40 - 46 (-6 - 0 - +6 semitones)

This message will sent as Transpose for external zones.

Drawbar Data List

Control number: Upper 50h(80)
 Lower 51h(81)
 Pedal 52h(82)

Data Map:

Level	Upper/Lower									Pedal	
	16'	5 1/3'	8'	4'	2 2/3'	2'	1 3/5'	1 1/3'	1'	16'	8'
0	00h(0)	09h(9)	12h(18)	1Bh(27)	24h(36)	2Dh(45)	36h(54)	3Fh(63)	48h(72)	00h(0)	09h(9)
1	01h(1)	0Ah(10)	13h(19)	1Ch(28)	25h(37)	2Eh(46)	37h(55)	40h(64)	49h(73)	01h(1)	0Ah(10)
2	02h(2)	0Bh(11)	14h(20)	1Dh(29)	26h(38)	2Fh(47)	38h(56)	41h(65)	4Ah(74)	02h(2)	0Bh(11)
3	03h(3)	0Ch(12)	15h(21)	1Eh(30)	27h(39)	30h(48)	39h(57)	42h(66)	4Bh(75)	03h(3)	0Ch(12)
4	04h(4)	0Dh(13)	16h(22)	1Fh(31)	28h(40)	31h(49)	3Ah(58)	43h(67)	4Ch(76)	04h(4)	0Dh(13)
5	05h(5)	0Eh(14)	17h(23)	20h(32)	29h(41)	32h(50)	3Bh(59)	44h(68)	4Dh(77)	05h(5)	0Eh(14)
6	06h(6)	0Fh(15)	18h(24)	21h(33)	2Ah(42)	33h(51)	3Ch(60)	45h(69)	4Eh(78)	06h(6)	0Fh(15)
7	07h(7)	10h(16)	19h(25)	22h(34)	2Bh(43)	34h(52)	3Dh(61)	46h(70)	4Fh(79)	07h(7)	10h(16)
8	08h(8)	11h(17)	1Ah(26)	23h(35)	2Ch(44)	35h(53)	3Eh(62)	47h(71)	50h(80)	08h(8)	11h(17)

ex: Set Lower 8' to level 7 via MIDI...

Bx 51 19

(x=Lower Channel)

System Exclusive Message

Memory Dump

1. Each Packet

F0	System Exclusive
55	SUZUKI ID
00	Device ID
10	Model ID MSB
15	Model ID LSB
11	Command: Data Packet
[TYPE]	Data Type 02h= Setup Dump
[PNH]	Packet Number MSB
[PNL]	Packet Number LSB
[DATA]	64 Bytes Data 128 Bytes nibblized ASCII ex: 7Eh = 37h, 45h
[CHD]	Check Digit Lower 7 bits of XOR [DATA]
F7	End of Exclusive

2. Acknowledge

F0	System Exclusive
55	SUZUKI ID
00	Device ID
10	Model ID MSB
15	Model ID LSB
14	Command: Acknowledge
[AK]	Result: 00h=OK 05h=Check Digit Error 06h=Receive Protected
[PNH]	Packet Number MSB
[PNL]	Packet Number LSB
F7	End of Exclusive

3. Hand shake communication

Master	Slave
Packet 0 ->	<- Acknowledge 0
Packet 1 ->	<- Acknowledge 1
.....	

This device will wait for 20ms if no acknowledges is received and transmit the next data of the packet number. (One Way Transfer)

NRPN Switch

F0	System Exclusive
55	SUZUKI ID
00	Device ID
10	Model ID MSB
15	Model ID LSB
02	Command: NRPN Sw.
[DATA]	00h=Off, 7Fh=On
F7	End Of Exclusive

When this device receives this message, switch Tx&Rx NRPN in Control channel.

Mode Setting Exclusive Message

Full Parameters Reset

F0	System Exclusive
55	SUZUKI ID
10	Device ID for DT1
42	Model ID for DT1
12	Command: DT1
40	Address MSB
00	Address
7F	Address LSB
7F	Reset
42	Check Sum
F7	End of Exclusive

When this device receives this message, it is reset to the initial status of Full Parameter, and gets ready for receiving the music data for the this device correctly. It takes about 50ms to process this message. Take an interval before the next message.

Global Parameters

Category	Global Parameters					
	Parameter	NRPN		DATA MSB (06)	Default	Description
		LSB (62)	MSB (63)			
Tune	Transpose	01	00	3A - 40 - 46 (-6 - 0 - 6)	40	0
	Master Tune	01	02	032E - 0338 - 0342 (430 - 440 - 450)	0338	440
Expression	Source	02	00	00 - 02 00: Exp. Pedal (Normal) 01: Exp. Pedal (Reverse) 02: MIDI IN	00	Exp. Pedal (Normal)
	Min. Level	02	08	00 - 0D	06	-35dB
	Min. Limit LF	02	09	(Off, -60dB - -0dB)	09	-20dB
	Min. Limit HF	02	0A		07	-30dB
Foot Switch	Mode FS1 Tip	02	02	00 - 09 00: Off 01: Leslie Fast(alternate) 02: Leslie Fast(momentaly)	01	Leslie Fast (alternate)
	Mode FS1 Ring	02	03	03: Damper Upper 04: Damper Lower 05: Damper Pedal 06: Preset Fwd. 07: Preset Rev. 08: Spring Shock 09: Delay Time	01	Leslie Fast (alternate)
Tone Knob	Mode	02	05	00 - 02 (Bass / Mid / Treble)	02	Treble
Ex.Voice/ Reverb Button	Mode	02	07	00 - 08 00: Extra Voice 01: Reverb 02: Pedal Sustain 03: External Zone 04: Lower Octave 05: Leslie Brake 06: Leslie On 07: Leslie Fast 08: Leslie On Reverb	00	Extra Voice
Tone- Wheel set	B-Type	03	00	00 - 03	00	Real B-3
	Mellow	03	01	00 - 02	00	Full Flats
	Brite	03	02	00 - 02	00	Classic X-5

Bank Parameters

Category	Bank Parameters					
	Parameter	NRPN		DATA MSB (06)	Default	Description
		LSB (62)	MSB (63)			
Combi. Preset Load	Link Lower/Pedal(Link L/P)	50	00	00, 01 (Off/On)	01	On
	Upper Regist. (UK)	6b	00	00, 01 (Off/On)	01	On
	Split, ManBs (INT)	6b	01	00, 01 (Off/On)	01	On
	External Zone (EXT)	6b	02	00, 01 (Off/On)	01	On
	Reverb, Equalizer (RV/EQ)	6b	03	00, 01 (Off/On)	01	On
	Leslie, Vibrato (ANI/OD)	6b	04	00, 01 (Off/On)	01	On
	Drawbar (DRAWB)	6b	05	00, 01 (Off/On)	01	On
	Percussion (PERCUS)	6b	06	00, 01 (Off/On)	01	On
	Extra Voice (EXV)	6b	07	00, 01 (Off/On)	01	On

*b: Bank Number
00 - 0B (C - B)*

Preset Parameters

Category	Combination Preset Parameters				
	Parameter	NRPN		DATA MSB (06)	P. load
		LSB (62)	MSB (63)		
Name	10 Characters				always
Drawbar Effect	Leslie On	09	00	00, 01 (Off/On)	ANI/OD
	Leslie Fast	09	01	00, 01 (Slow/Fast)	
	Leslie Brake	09	06	00, 01 (Through / Brake)	
	Leslie Cabinet	09	07	00 - 07 (1 - 8)	
	Leslie Mod. Ctrl	09	08	00, 01 (Off/On)	
	Vibrato Mode	09	02	00 - 03 (Off, 1 - 3)	
	Vibrato / Chorus	09	03	00 - 01	
	Vibrato Rate	09	04	00 - 04 (6.1 - 7.25Hz)	
	Vibrato Tremolo	09	15	00 - 0F (0 - 15)	
	Vibrato Cho. Emphasis	09	16	00 - 09 (0 - 9)	
	Vibrato Depth V1	09	0F	00 - 0F (0 - 15)	
	Vibrato Depth V2	09	10	00 - 0F (0 - 15)	
	Vibrato Depth V3	09	11	00 - 0F (0 - 15)	
	Vibrato Depth C1	09	12	00 - 0F (0 - 15)	
Vibrato Depth C2	09	13	00 - 0F (0 - 15)		
Vibrato Depth C3	09	14	00 - 0F (0 - 15)		
OD On	09	09	00, 01 (Off/On)	ANI/OD	
OD Drive Level Master	09	05	00 - 3F (0 - 63)		
OD Exp. Ctrl	09	0C	00 - 02 00: OD to Exp 01: Exp to OD 02: OD Only	ANI/OD	
EQ Bass Gain	0A	00	00 - 09 - 12 (-9 - 0 - +9 dB)	EQ/REV	
EQ Mid Gain	0A	01	00 - 09 - 12 (-9 - 0 - +9 dB)		
EQ Treble Gain	0A	02	00 - 09 - 12 (-9 - 0 - +9 dB)		
EQ Mid Freq	0A	03	00 - 0A (480 - 2.9kHz)		
Reverb On	0A	04	00, 01 (Off/On)	EQ/REV	
Reverb Type	0A	05	00 - 09 00: Room 1 01: Room 2 02: Live House 03: Hall 1 04: Hall 2 05: Church 06: Plate 07: Delay 08: Panning Delay 09: Reverb + Delay		
Reverb Depth	0A	06	00 - 0F (0 - 15)		
Reverb Time	0A	07	00 - 1F (0 - 31)		
Reverb Delay Feedback	0A	08	00 - 1F (0 - 96%)		
Reverb Delay Time	0A	09	00 - 3F (4.7 - 1000ms)		
Leslie On Reverb	0A	0A	00, 01 (Off/On)		

Category	Combination Preset Parameters				
	Parameter	NRPN		DATA MSB (06)	P. load
		LSB (62)	MSB (63)		
Internal Zone	Split On	07	00	00, 01 (Off/On)	INT
	Manual Bass On	07	01	00, 01 (Off/On)	
	L&U Key Range Low	07	02	24 - 5F	
	L&U Key Range High	07	03	25 - 60	
	Pedal Key Range High	07	04	24 - 60	
	Split Point	07	05	24 - 5F	
	Split Lower Octave	07	06	00, 01 (0, +1)	
External Zone	Channel	4p	00	00 - 10 (1 - 16, Off)	EXT
	Bank MSB	4p	01	00 - 7F	
	Bank LSB	4p	02	00 - 7F	
	Program Change	4p	03	00 - 7F	
	Octave Shift	4p	0A	3E - 40 - 42 (-2 - 0 - +2)	
	Volume	4p	04	00 - 7F	
	Pan	4p	05	00 - 40 - 7F (Left - Center - Right)	
	Vel. Curve	4p	06	00 - 04 (Off, Normal - Easy)	
	Exp. Min	4p	08	00 - 3F (0 - 63)	
	Exp. Max	4p	09	40 - 7F (64 - 127)	
	Exp. CC#	4p	07	00, 01 (7, 11)	
	Tx. Bend On	4p	0B	00, 01 (Off/On)	
	Tx. Modulation On	4p	0C	00, 01 (Off/On)	
	Tx. Damper Source	4p	0D	00 - 02 (Off, Tip, Ring)	
Key Range Low	4p	0E	24 - 5F		
Key Range High	4p	0F	25 - 60		
			<i>p: Zone Number 00 - 02 (Zone 1 - 3)</i>		

Extra Voice	ExV On	30	00	00, 01 (Off/On)	EXV
	ExV Instrument Number	30	01	00 - 07 00: E. Pf 60's 01: E. Pf 70's 02: E. Pf 80's 03: Clavi. 1 04: Clavi. 2 05: Vibes 06: Saw Lead 07: Funny Lead	
	ExV Octave	30	02	3E - 40 - 42 (-2 - 0 - +2)	
	ExV Volume	30	03	00 - 7F	
	ExV Vel. Curve	30	04	00 - 04 (Off, Normal - String)	
	ExV Mod Wheel	30	05	00, 01 (Off/On)	

Category	Combination Preset Parameters				
	Parameter	NRPN		DATA MSB (06)	P. load
		LSB (62)	MSB (63)		
Upper/ Lower Drawbar Voice	Voice Type	20	00	00 - 02 00: B-Type 01: Mellow 02: Brite	DRAWB
	Drawbar Click Attack	20	01	00 - 0F (0 - 15)	
	Drawbar Click Release	20	02	00 - 0F (0 - 15)	
	Drawbar Env. Attack	20	03	00 - 0F (0 - 15)	
	Drawbar Env. Release	20	04	00 - 0F (0 - 15)	
	Fold Back Low	20	05	00 - 0C (C1 - C2)	
	Fold Back High	20	06	2B - 30 (G4 - C5)	
	Bend Range Down	20	07	00 - 18 (0 - 24)	
	Bend Range Up	20	08	00 - 0C (0 - 12)	
	Bend Mode	20	0A	00 - 01 (Bend / Motor)	
	Bend Time	20	0B	00 - 31 (0.1 - 5.0s)	
	Bend Amplitude	20	0C	00 - 01 (Off/On)	
	Drawbar Click LPF	20	09	00 - 7F (0 - 127)	
	Percussion Voice	Second On	08	00	
Third On		08	01	00, 01 (Off/On)	
Decay Fast		08	02	00, 01 (Off/On)	
Soft		08	03	00, 01 (Off/On)	
Level Soft		08	04	00 - 0F (1 - 16)	
Level Normal		08	05	00 - 0F (1 - 16)	
Decay Fast		08	06	00 - 09 (1 - 9, C)	
Decay Slow		08	07	00 - 09 (1 - 9, C)	
Touch		08	08	00, 01 (Off/On)	
Velocity		08	09	00, 01 (Off/On)	
Key Track		08	0A	00, 01 (Off/On)	
Drawbar 1' Cancel		08	0B	00, 01 (Off/On)	
Drawbar Level		08	0C	00, 01 (0, -3dB)	
Upper Drawbars		16'	see Drawbar Data List for details		
	5 1/3'				
	8'				
	4'				
	2 2/3'				
	2'				
	1 3/5'				
	1 1/3'				
	1'				

Category	Lower Preset Parameters				
	Parameter	NRPN		DATA MSB (06)	P. load
		LSB (62)	MSB (63)		
Lower Drawbars	16'	see Drawbar Data List for details			Link L/P
	5 1/3'				
	8'				
	4'				
	2 2/3'				
	2'				
	1 3/5'				
	1 1/3'				
Pedal Drawbar Voice	Voice Type	22	00	00 - 03 00: Normal 01: Muted 02: Synth 1 03: Synth 2	Link L/P
	Drawbar Attack	22	01	00 - 04 00: Slow Attack 01: No Click 02: Soft Click 03: Normal Click 04: Max Click	
	Bend Range Down	22	02	00 - 18 (0 - 24)	
	Bend Range Up	22	03	00 - 0C (0 - 12)	
	Sustain On	22	04	00, 01 (Off/On)	
	Sustain Length	22	05	00 - 04 (1 - 5)	
	Pedal Key Mode	22	06	00, 01 (Mono/Poly)	
	Decay Length	22	07	00 - 05 (1 - 5, Cont.)	
	Velocity	22	08	00 - 04 (Off, 1 - 4)	
	Pedal Drawbars	16'	see Drawbar Data List for details		
8'					

Leslie Parameters

Category	Leslie Parameters						
	Parameter	NRPN on XK		NRPN on 21		DATA	Default
		LSB (62)	MSB (63)	LSB (62)	MSB (63)	MSB (06)	
Cabinet #1 - 8	Name					(10 Characters)	
	Slow Speed Horn	06	00	7F	00	00 - 63(0, 24 - 318rpm)	05 (36rpm)
	Slow Speed Bass	06	01	7F	01	00 - 63(0, 24 - 318rpm)	05 (36rpm)
	Fast Speed Horn	06	02	7F	02	00 - 1A(0, 375 - 453rpm)	07 (393rpm)
	Fast Speed Bass	06	03	7F	03	00 - 1A(0, 375 - 453rpm)	07 (393rpm)
	Rise Time Horn	06	04	7F	04	00 - 18(0.2 - 5.0s)	0A (2.2s)
	Rise Time Bass	06	05	7F	05	00 - 18(0.5 - 12.5s)	0D (7.0s)
	Fall Time Horn	06	06	7F	06	00 - 18(0.2 - 5.0s)	04 (1.0s)
	Fall Time Bass	06	07	7F	07	00 - 18(0.5 - 12.5s)	09 (5.0s)
	Brake Time Horn	06	08	7F	08	00 - 18(0.2 - 5.0s)	05 (1.2s)
	Brake Time Bass	06	09	7F	09	00 - 18(0.5 - 12.5s)	13 (10s)
	Volume Horn	06	0A	--	--	00 - 0C(-12 - 0dB)	0C (0dB)
	Volume Bass	06	0B	--	--	00 - 0C(-12 - 0dB)	0C (0dB)
	Mic. Angle	06	0C	7F	0A	00 - 06(0 - 180deg)	04 (120deg)
	Mic. Distance	06	0D	7F	0B	00 - 08(0.3 - 2.7m)	02 (0.9m)
Horn Character	06	0E	--	--	00 - 02(Flat, Mid, Deep)	00 (Flat)	

System Parameters

Category	System Parameters		
	Parameter	Data Range	Default
MIDI	MIDI In Port	Lower/Pedal , In1/In2	In1/In2
	Local	Off / On	On
	TRx. NRPN	Off / On	On
	Tx. Leslie Param.	XK / 21	XK
	TRx. Prog. Change	Off / On	On
	TRx. Drawbar Regi.	Off / On	On
	TRx. Wheel Control	Off / On	On
	Rx. Dump	Off / On	On
	TRx. Channel Upper	1 - 16, Off	1
	TRx. Channel Lower	1 - 16, Off	2
TRx. Channel Pedal	1 - 16, Off	3	
Display	To Shortcut	0, 1, 2s, No	1s
	Time Out	4, 8, 16, No	No
Key	Depth	Normal / Deep	Normal
Drawbars	Drawbar Select	Upper, Pedal, Lower	Upper
Expression	Gain	70 - 130%	110%

Combi. and Bank/Program Messages

	1	2	3	4	5	6	7	8	9	10	11	12
Program Change												
Bank Select												
MSB	1	2	3	4	5	6	7	8	9	10	11	AD
0												
1												
2												
3												
4												
5												
6												
7												
8												
9												
10												
11												
12												

ex: Change to Bank 5 - Number 2 via MIDI... Bx 00 04 Cx 01 (x=Upper Channel)

Sound Generator

2 x VASE III as
Digital Tone-wheels

Keyboard

61 notes
Water Fall type with Velocity

Harmonic Drawbars

Knobs

9 Pitches

Drawbar Select Tabs

Upper, Pedal, Lower

Waveform

B-type/Mellow/Brite (Upper
and Lower)
Muted/Normal/Synth1/Synth2
(Pedal)

Percussion

Tabs

Second On, Third On,
Fast Decay, Soft

Adjustable

Touch, Velocity,
Decay (Fast, Slow)
Level (Soft, Normal)

Extra Voice

8 Instruments

Tuning

Master

430 - 450 1Hz Steps

Transpose

-6 - 0 - +6 semitones

Effects

Internal Leslie

On, Fast, Brake
Digital, 2 Rotors

Vibrato and Chorus

V1, V2, V3, C1, C2, C3
Upper&Lower On/Off
Speed: 5(6.10 - 7.25Hz)

Overdrive

Digital Overdrive

Equalizer

3 Bands

Reverb

10 Programs

Sustain

5 Lengths (Pedal)

Internal Zone

Tabs

Split
Manual Bass

Adjustable

Map Low, High
Split Point
Lower Octave
Pedal Top key

Combination Presets

12 banks x 11 Numbers
+ Adjust
Switchable: Link/Independent

Controllers

Switches

Power On / Off

Rotary Controllers

Master Volume
Overdrive
Tone

Wheels

Pitch Bend
Modulation

Display

20-characters, 2 lines
with 9 control switches
and Rotary encoder

Storage

None

MIDI

Templates: 3 modes
Zoned 3 parts
and Keyboard Ch.

Connections

AC Inlet
MIDI In1, In2, Out
Exp. Pedal (Phone Jack),
Foot Switch,
Line Out L/Mono, R,
Headphones,
8-pin Leslie

Dimension

116(W) x 33.4 (D) x 11(H)cm

Weight

13kg

Demonstration Songs and Composers

Playing the demonstration performance:

1. Touch and hold the [SPLIT] and [MANUAL BASS] Button 2 seconds.
2. Select the song by using [PAGE] Button.
3. Touch the [4]▶ Button to play.

Songs / Composers

1. **Liberation**
Takanobu Masuda
2. **XK-1 Happy**
Joey DeFrancesco
3. **Acid Wash**
Tony Monaco
4. **Shooting Star**
Daisuke Kawai
5. **B-3 Cookin'**
Deryl Winston
6. **Somthing Slow**
Joey DeFrancesco
7. **Shakin'**
Joey DeFrancesco
8. **Amazing Grace**
Traditional

Joey DeFrancesco

Joey started playing at the age of four. He recalls, "I could just play. I was already hearing Jimmy Smith and stuff like that around the house. Then one time my Dad, "Papa John" DeFrancesco, brought the Hammond organ home from a gig. When I heard that sound I really got into it. My Dad guided me in the right direction, the do's and the don'ts, but he was never very forceful about it." At the age of 10, Joey was already playing for money on weekend gigs. By high school, he was working steadily around Philadelphia, receiving first-hand instruction from the top-shelf organists who come through the city such as Jimmy Smith, Jack McDuff, and numerous others. His high visibility career kicked off when Miles Davis asked Joey to join his late 80s band. Joey then signed a contract with Columbia that resulted in five records from 1989 to 1994. With the release of his album, "All of Me" in 1989, Joey emerged on the jazz scene. The global jazz community has credited Joey and his recordings, from the late 1980s and early 1990s, as the singular sensation for rekindling a love for the Hammond B-3 organ. In 2003, Joey and his band released their latest hit CD, "Falling in Love Again". This CD featured the Hammond "New" B-3 organ. For the year 2002/2003, the maga-

zine Downbeat chose Joey as "the Jazz Organist of the Year". Currently Joey is very active at Hammond Suzuki. Besides participating at dealer promotions, national conventions, concerts, and clinics, he contributes to Hammond product development.

Tony Monaco

Tony started playing the accordion when he was eight years old. When he was twelve, he was given a Jimmy Smith album and instantly knew that Jazz Organ was his calling. Tony began playing in Jazz nightclubs around Columbus Ohio while he was still learning the art of Hammond B3 organ. He was influenced by hometown Organists such as Hank Marr and Don Patterson. Tony's newfound fascination led him to jazz organ legends Jimmy McGriff, Richard "Groove" Holmes, Charles Earland, Jack McDuff, and Dr. Lonnie Smith. Here he found an unlimited source of inspiration ; he just couldn't get enough! On Tony's sixteenth birthday, he received a phone call from Jimmy Smith. This was a great honor and really boosted his enthusiasm as an organist. When he was twenty, Jimmy Smith invited Tony to come play with him at his club in Woodland Hills LA., California. An experience Tony would never forget. In April 2000, Tony met jazz Organist Joey DeFrancesco while Joey was playing in Columbus, Ohio. The two of them became instant friends. Joey recognized Tony's talents right away and offered to produce a CD for him. Tony's recording "Burnin' Grooves" sparked international attention. Tony now travels and plays the "New B3" organ as his relationship with Hammond Suzuki has grown.

Daisuke Kawai

Started music career as a studio musician in 1989. Has supported Cornelius, Shinji Takeda and, recently, the Morning Musume, Ayumi Hamasaki, and coba, etc. Actively performing with his own band "Tone Wheels", and the new unit "Opus".

Deryl Winston

Deryl Winston is a long time resident of San Diego. He began playing the Hammond Organ at age 14 while still living in his native home of Seattle Washington. Deryl was tutored by two of the finest Gospel musicians in the form of his mother Alice Winston (a concert pianist) and Aunt Jean McGraw (Hammond Organist). It was not long before many in the Seattle area became familiar with Deryl and the amazing talent and skill he showed on the Hammond Organ. By early 2000, Deryl was introduced to the Executives at Hammond Suzuki USA. They were very impressed with Deryl and invited him to the Annual Namm Convention in Anaheim Ca. to become one of their artist's. Deryl still continues to travel in the capacity as a Hammond Concert Artist. He provides dedication concerts and conducts seminars on Hammond Organ and it's importance in Gospel music. He's very thankful and proud to represent such a fine company as Hammond Suzuki USA. Deryl's motto is "You ain't Jammin, unless there's a Hammond"!

Takanobu Masuda

Started playing the organ when small. Has been interested in the Hammond Organ since about 15. Purchased the new X-5 and Leslie #760 at the age of 18, then studied mainly Rock style performance and approach.

Later, as a session keyboardist, joined the recordings and lives of various artists. Now gives advice to the makers (Hammond Suzuki) about the XB/XM series from the viewpoint of a professional musician.

- ◆ All the copyrights of these demo-songs belong to Suzuki Musical Inst. Mfg. Co., Ltd.
- ◆ Reproducing these demo-songs for use other than listing individually is prohibited by law.
- ◆ While the demo-songs are playing, the controllers do not function, except [MASTER VOLUME], [LESLIE BRAKE], [LESLIE ON], [LESLIE FAST], and [VIBRATO & CHORUS].

Factory Presets

	1	2	3	4	5	6	7	8	9	10	11	12
Program Change	1	2	3	4	5	6	7	8	9	10	11	12
Bank Select MSB	Preset Number											
0	1	2	3	4	5	6	7	8	9	10	11	AD
1	Cancel	Jimmy	Lo & Hi 1	Warmth	Groove	Funky	Purple	Funky 2	Full Tibias	Full Organ	Full Church	
2	Cancel	Jimmy 1	Jimmy 2	Jimmy 3	Burner	Groove	Smooth Bass	Shirley	Jimmy MC	Fat Bass	All Nine	
3	Cancel	Gospel 1	Gospel 2	Gospel 3	Gospel 4	Praise 1	Praise 2	Praise 3	Praise 4	Meditation	Full Gospel	
4	Cancel	Purple	Perc Holow	Some Lovin	Booker	Rock 1	Rock 2	Rock 3	Full 1	Full 2	Full Overd	
5	Cancel	Theatre C#	Theatre D	Theatre D#	Theatre E	Theatre F	Theatre F#	Theatre G	Theatre G#	Theatre A	Full Theatre	
6	Cancel	Tibia 8 & 4	Tibia 8 & 2	Tibia & Vox	Tibia 8,4 & 2	Tibia 16 & 8	Tibia 16 & 4	Tibia 16, 8 & 4	Tibia 16,8,4&2	Tibia 16,8,4,2,1	Full Tibia	
7	Cancel	Gedeckt 8	Flute 8 & 4	Princip 8	Princ Chrs	Rohr Flute	Gamba Clst	Cornet	Sesquialtr	Chrs & Mxt	Sforzando	
8	Cancel	Lo & Hi 1	Lo & Hi 2	Lo & Hi 3	Odd Harm	M3 Low Man	Perc 16 & 4	Solo 16 & 2	Cute Solo	Eddie-wind	Full Hamm	
9	Cancel	White Shade	Percuss Bass	Four Beat	Funk Bass	Surf Coast	Blue Tigers	10th Avenue	Popcorn	Triplet 120	N. E. S.	
10	Cancel	Soloist	Choke Nose	S.F. 4ever	Tea Lounge	Le Femme	Triplet 90	Triplet 100	Triplet 110	Triplet 120	Triplet 130	
11	Cancel	XK-1 Happy 1	XK-1 Happy 2	XK-1 Happy 3	AcidWash 1	AcidWash 2	B-3 Cookin'	Shooting 1	Shooting 2	Liberatio 1	Liberatio 2	
12	Cancel	Stopped Fl	Dulciana	Fr. Horn	Salicional	Flutes 8 & 4	Oboe Horn	Diapason	Trumpet	Full Swell	Full Church	

ex: Change to Bank 5 - Number 2 via MIDI... Bx 00 04 Cx 01 (x=Upper Channel)

**HAMMOND SUZUKI, LTD.
LIMITED 1-YEAR WARRANTY**

HAMMOND SUZUKI, LTD. ("HAMMOND") warrants to the original consumer/purchaser that this product shall be free from any defect in material and workmanship for a period of one year from the date of purchase.

If a defect covered by this warranty occurs during this one-year warranty period, you should return the product within such one year to:

A. The dealer from whom you purchased it, together with a copy of your sales slip or similar proof-of-purchase, and the dealer will repair the defective unit without charge for parts or labor.

OR

B. the nearest **HAMMOND** Authorized Service Center together with a copy of your sales slip or similar proof-of-purchase, and the authorized service center will repair the defective unit without charge for parts or labor.

the consumer/purchaser is responsible for any costs incurred for the transportation of the unit to and from the **HAMMOND** Authorized Service Center or Dealer.

This warranty does not cover damage or malfunction resulting from improper handling or abuse, accident, misuse, failure or electrical power, battery leakage, use on improper voltage or current, failure to follow normal procedures outlined in the User's Manual, use with other products not manufactured or approved by **HAMMOND**, alteration, damage while in transit for repairs, repairs attempted by any unauthorized person to agency, or any other reason not due to defects in materials or workmanship. This warranty is void if the serial number (if any) has been altered, defaced or removed.

ANY IMPLIED WARRANTIES ARISING OUT OF THE SALE OF THIS HARDWARE PRODUCT, INCLUDING BUT NOT LIMITED TO THE IMPLIED WARRANTIES OR MERCHANTABILITY AND FITNESS FOR A PARTICULAR PURPOSE, ARE LIMITED IN DURATION TO ABOVE ONE-YEAR PERIOD. LIABILITY IS LIMITED SOLELY TO THE REPAIR OR REPLACEMENT OF THE DEFECTIVE PRODUCT IN **HAMMOND'S** SOLE DISCRETION, AND IN NO EVENT SHALL INCLUDE DAMAGES FOR LOSS OF USE OR OTHER INCIDENTAL OR CONSEQUENTIAL COSTS, EXPENSES OR DAMAGES INCURRED BY THE PURCHASER, INCLUDING WITHOUT LIMITATION, ANY DATA OR INFORMATION WHICH MAY BE LOST OR RENDERED INACCURATE, EVEN IF HAMMOND HAS BEEN ADVISED OF THE POSSIBILITY OF SUCH DAMAGES.

HAMMOND shall have no obligation to enhance or update any PRODUCT once manufactured.

(over)

(Your Name and Address)

Place Stamp Here

(Name and Address of Hammond Distributor in your territory)

Some states do not allow limitations on how long any implied warranty lasts or the exclusion of incidental or consequential damages, so the above limitations or exclusion may not apply to you. This warranty gives you specific legal rights which vary from state to state. (Available in U.S.A. only)

IMPORTANT: THIS IS YOUR HAMMOND WARRANTY REGISTRATION. Fill out NOW and mail-DON'T DELAY!

To receive the protection of this limited one-year warranty, you **MUST** return registration card within 10 days after the date of purchase.

KEEP THIS PORTION FOR YOUR RECORD.

For further information or questions regarding the performance of warranty obligations, please write or call:

In the United States Contact:

HAMMOND SUZUKI USA, INC.
733 Annoreno Drive, Addison, Illinois 60101
TEL: (630)543-0277 FAX: (630)543-0279

In the EU Countries Contact:

HAMMOND SUZUKI EUROPE B.V.
Ir. D.S. Tuynmanweg 4A,
4131 PN VIANEN The Netherlands
TEL: (+31)347-370594 FAX: (+31)347-370621

Other Countries Contact:

Original retailer where product was purchased for additional warranty details.

PRODUCT NAME: XK-1

PART NO. _____ SERIAL NO. _____

DATE OF PURCHASE _____ PURCHASE FROM _____

HAMMOND

PRODUCT NAME: XK-1

PART NO. _____ SERIAL NO. _____

DATE OF PURCHASE _____ PRICE _____

PURCHASED FROM _____ CITY _____ STATE _____

USER'S NAME _____

COMPANY NAME _____

ADDRESS _____

CITY _____ STATE _____ ZIP _____

TELEPHONE NO. _____

COMMENTS: _____

Hammond maintains a policy of continuously improving and upgrading its instruments and therefore reserves the right to change specifications without notice. Although every attempt has been made to insure the accuracy of the descriptive contents of this Manual, total accuracy cannot be guaranteed.

Should the owner require further assistance, inquiries should first be made to your Authorized Hammond Dealer. If you still need further assistance, contact Hammond at the following addresses:

In the United States contact:

HAMMOND SUZUKI USA, Inc.
733 Annoreno Dr.
Addison, IL 60101
UNITED STATES

In Europe contact:

HAMMOND SUZUKI EUROPE
B.V.
IR. D.S. Tuynmanweg 4A
4131 PN Vianen
THE NETHERLANDS

All other countries contact:

HAMMOND SUZUKI Ltd.
25-11, Ryoke 2 Chome
Hamamatsu 430-0852
(Shizuoka)
JAPAN

Website:
www.hammondorganco.com

E-mail: Info@hammondsuzuki.com
Website: www.hammondsuzuki.com

Website: www.suzuki-music.co.jp

Technical materials are available and can be obtained by mailing a request to the appropriate address listed above marked ATTENTION: SERVICE DEPARTMENT.

Manufacturer:
SUZUKI MUSICAL INSTRUMENT MFG. CO., Ltd.
25-12, Ryoke 2 Chome
Hamamatsu 430-0852 (Shizuoka)
JAPAN

