

Model number
LE19S304

HITACHI
Inspire the Next

LCD HDTV



ENGLISH
ESPAÑOL

Owners Guide

Thank you for purchasing this Hitachi product. Please read these instructions carefully.
For additional assistance please Call Toll Free 1.800.289.0981 or visit our website at www.hitachi.us/tv.
Keep this owners guide for future reference.

Record the model name and serial number of your LED Television for future reference.
This information is located on the back and right side of the television.

MODEL NAME. _____ SERIAL NO. _____

TABLE OF CONTENTS

IMPORTANT SAFETY INSTRUCTIONS.....	2-6
FIRST TIME USE	9-14
TV OPERATION	15-23
CONNECTIONS TO OTHER EQUIPMENT	21-23
TROUBLE SHOOTING.....	25
LIMITED WARRANTY	27



ENGLISH

	CAUTION RISK OF ELECTRIC SHOCK DO NOT OPEN	
CAUTION: TO REDUCE THE RISK OF ELECTRIC SHOCK, DO NOT REMOVE COVER (OR BACK). NO USER-SERVICEABLE PARTS INSIDE. REFER SERVICING TO QUALIFIED SERVICE PERSONNEL.		



The lightning flash with arrowhead symbol, within an equilateral triangle is intended to alert the user to the presence of uninsulated dangerous voltage within the product's enclosure that may be of sufficient magnitude to constitute a risk of electric shock.



The exclamation point within an equilateral triangle is intended to alert the user to the presence of important operating and maintenance (servicing) instructions in the literature accompanying the appliance.

WARNING: TO PREVENT FIRE OR SHOCK HAZARD, DO NOT EXPOSE THIS APPLIANCE TO RAIN OR MOISTURE. TO PREVENT THE SPREAD OF FIRE, KEEP CANDLES OR OPEN FLAMES AWAY FROM THIS PRODUCT AT ALL TIMES.

CAUTION: TO PREVENT ELECTRIC SHOCK, DO NOT USE THIS POLARIZED PLUG WITH AN EXTENSION CORD, RECEPTACLE OR OTHER OUTLET UNLESS THE BLADES CAN BE FULLY INSERTED TO PREVENT BLADE EXPOSURE.

WARNING: This equipment has been tested and found to comply with the limits for a Class B digital device, pursuant to Part 15 of the FCC Rules. These limits are designed to provide reasonable protection against harmful interference in a residential installation. This equipment generates, uses and can radiate radio frequency energy and, if not installed and used in accordance with the instructions, may cause harmful interference to radio communications. However, there is no guarantee that interference will not occur in a particular installation. If this equipment does cause harmful interference to radio or television reception, which can be determined by turning the equipment off and on, the user is encouraged to try to correct the interference by one or more of the following measures:

- Reorient or relocate the receiving antenna.
- Increase the separation between the equipment and receiver.
- Connect the equipment into an outlet on a circuit different from that to which the receiver is connected.
- Consult the dealer or an experienced radio/TV technician for help.

CAUTION: Changes or modifications not expressly approved by the party responsible for compliance with the FCC Rules could void the user's authority to operate this equipment.

Location of the required Marking

The rating sheet and the safety caution are on the rear of the unit.

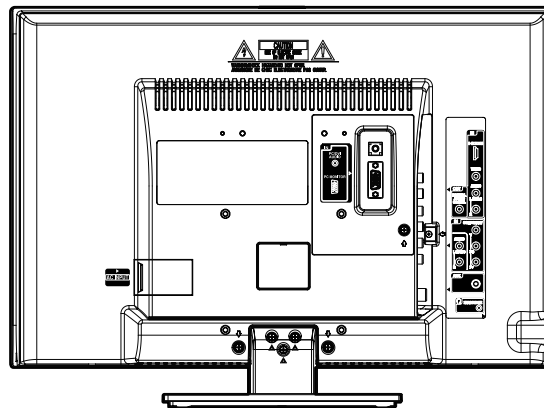

ENERGY STAR®

This television's factory default settings as shipped meet ENERGY STAR requirements. Please see the Convenience Functions section of this operating guide for more information on factory settings and the energy saving Auto Shut Off feature.

IMPORTANT SAFETY INSTRUCTIONS

ENGLISH

- 1) Read these instructions.
- 2) Keep these instructions.
- 3) Heed all warnings.
- 4) Follow all instructions.
- 5) Do not use this apparatus near water.
- 6) Clean only with dry cloth.
- 7) Do not block any ventilation openings. Install in accordance with the manufacturer's instructions.
- 8) Do not install near any heat sources such as radiators, heat registers, stoves, or other apparatus (including amplifiers) that produce heat.
- 9) Do not defeat the safety purpose of the polarized or grounding-type plug. A polarized plug has two blades with one wider than the other. A grounding type plug has two blades and a third grounding prong. The wide blade or the third prong are provided for your safety. If the provided plug does not fit into your outlet, consult an electrician for replacement of the obsolete outlet.
- 10) Protect the power cord from being walked on or pinched particularly at plugs, convenience receptacles, and the point where they exit from the apparatus.
- 11) Only use attachments/accessories specified by the manufacturer.
- 12) Use only with cart, stand, tripod, bracket, or table specified by the manufacturer, or sold with the apparatus. When a cart is used, use caution when moving the cart/apparatus combination to avoid injury from tip-over.
- 13) Unplug this apparatus during lightning storms or when unused for long periods of time.
- 14) Refer all servicing to qualified service personnel. Servicing is required when the apparatus has been damaged in any way, such as power-supply cord or plug is damaged, liquid has been spilled or objects have fallen into the apparatus, the apparatus has been exposed to rain or moisture, does not operate normally, or has been dropped.
- 15) Apparatus should not be exposed to dripping or splashing, and objects filled with liquids, such as vases, should not be placed on the apparatus.
- 16) An outside antenna system should not be located in the vicinity of overhead power lines or other electric light or power circuits, or where it can fall into such power lines or circuits. When installing an outside antenna system, extreme care should be taken to keep from touching such power lines or circuits, as contact with them might be fatal.
- 17) Do not overload wall outlets and extension cords, as this can result in a risk of fire or electric shock.
- 18) Do not push objects through any openings in this unit, as they may touch dangerous voltage points or short out parts that could result in fire or electric shock. Never spill or spray any type of liquid into the unit.
- 19) If an outside antenna or cable system is connected to the unit, be sure the antenna or cable system is grounded to provide some protection against voltage surges and built-up static charges, Section 810 of the National Electrical Code, ANSI/NFPA 70, provides information with respect to proper grounding of the mast and supporting structure, grounding of the lead-in wire to an antenna discharge unit, size of grounding conductors, location of antenna discharge unit, connection to grounding electrodes, and requirements for the grounding electrode.
- 20) When replacement parts are required, be sure the service technician uses replacement parts specified by the manufacturer or those that have the same characteristics as the original part.
Unauthorized substitutions may result in fire, electric shock or other hazards.
- 21) Upon completion of any service or repairs to this unit, ask the service technician to perform safety checks to determine that the unit is in proper operating condition.
- 22) When you connect the product to other equipment, turn off the power and unplug all of the equipment from the wall outlet. Failure to do so may cause an electric shock and serious personal injury. Read the owner's manual of the other equipment carefully and follow the instructions when making any connections.
- 23) Sudden high volume sound may cause hearing or speaker damage. When you use headphones, (if the unit is equipped with a headphone jack) keep the volume at a moderate level. If you use headphones continuously with high volume sound, it may cause hearing damage.

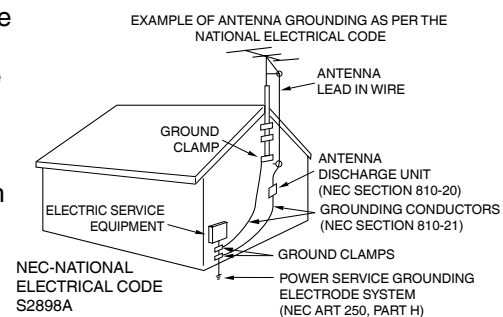



IMPORTANT SAFETY INSTRUCTIONS (continued)

- 24) Do not allow the product to output distorted sound for an extended period of time. It may cause speaker overheating and fire.
- 25) This reminder is provided to call the cable TV system installer's attention to Article 820-40 of the NEC that provides guidelines for proper grounding and, in particular, specifies that the cable ground shall be connected to the grounding system of the building, as close to the point of cable entry as practical.
- 26) The socket-outlet must be installed near the unit and easily accessible.
- 27) The mains plug is used as the disconnect and shall remain readily operable.

CONDENSATION

Moisture will form in the operating section of the unit if the unit is brought from cool surroundings into a warm room or if the temperature of the room rises suddenly. When this happens, unit's performance will be impaired. To prevent this, let the unit stand in its new surroundings for about an hour before switching it on, or make sure that the room temperature rises gradually. Condensation may also form during the summer if the unit is exposed to the breeze from an air conditioner. In such cases, change the location of the unit.

HOW TO HANDLE THE LCD PANEL

- Do not press hard or jolt the LCD panel. It may cause the LCD panel glass to break and injury may occur.
- If the LCD panel is broken, make absolutely sure that you do not touch the liquid in the panel. This may cause skin inflammation. If the liquid gets in your mouth, immediately gargle and consult with your doctor. Also, if the liquid gets in your eyes or touches your skin, consult with your doctor after rinsing for at least 15 minutes or longer in clean water.

Possible Adverse Effects on LCD Panel: If a fixed (non-moving) pattern remains on the LCD Panel for long periods of time, the image can become permanently engrained in the LCD Panel and cause subtle but permanent ghost images. This type of damage is NOT COVERED BY YOUR WARRANTY. Never leave your LCD Panel on for long periods of time while it is displaying the following formats or images:

- Fixed Images, such as stock tickers, video game patterns, TV station logos, and websites.
- Special Formats that do not use the entire screen. For example, viewing letterbox style (16:9) media on a normal (4:3) display (black bars at top and bottom of screen); or viewing normal style (4:3) media on a widescreen (16:9) display (black bars on left and right sides of screen).

The following symptoms are not signs of malfunction but technical limitation. Therefore we disclaim any responsibility for these symptoms.

- LCD Panels are manufactured using an extremely high level of precision technology, however sometimes parts of the screen may be missing picture elements or have luminous spots. This is not a sign of a malfunction.
- Do not install the LCD Panel near electronic equipment that produces electromagnetic waves. Some equipment placed too near this unit may cause interference.
- Effect on infrared devices – There may be interference while using infrared devices such as infrared cordless headphones.

Power source

This LED television is designed to operate on 120 volts 60 Hz, AC current. Insert the power cord into a 120 volt 60 Hz outlet. To prevent electric shock, do not use the LED television's (polarized) plug with an extension cord, receptacle, or other outlet unless the blades and ground terminal can be fully inserted to prevent blade exposure. Never connect the LED television to 50 Hz, direct current, or anything other than the specified voltage.

Warning

To reduce the risk of fire or electric shock, do not expose this apparatus to rain or moisture.

Caution

Never remove the back cover of the LED television as this can expose you to very high voltages and other hazards. If the television does not operate properly, unplug the LED television and call your authorized dealer or service center. Adjust only those controls that are covered in the instructions, as improper changes or modifications not expressly approved by Hitachi could void the user's warranty.

Declaration of Conformity

This device complies with part 15 of the FCC Rules. Operation is subject to the following two conditions:
 (1) This device may not cause harmful interference and (2) This device must accept any interference received, including interference that may cause undesired operation.
 For questions regarding this declaration, contact:

Hitachi America, Ltd.
 900 Hitachi Way
 Chula Vista, CA 91914-3556
 ATTN: Customer Relations



CHILD SAFETY NOTICE

CHILD SAFETY:

It Makes A Difference How and Where
You Use Your Flat Panel Display

ENGLISH

Congratulations on your purchase!

As you enjoy your new product, please keep these safety tips on mind:



HITACHI CARES!

- The consumer electronics industry is committed to making home entertainment enjoyable and safe.
- Please note the American Academy of Pediatrics discourages television viewing for children younger than two years of age.
- The home theater entertainment experience is a growing trend and larger flat displays are popular purchases. However, flat panel displays are not always supported on the proper stands or installed according to the manufacturer's recommendations.
- Flat Panel displays that are inappropriately situated on dresser, bookcases, shelves, desks, speakers, chest or carts may fall over and cause injury.

TUNE INTO SAFETY

- One size does NOT fit all. Follow the manufacturer's recommendations for the safe installation and use of your flat panel display.
- Carefully read and understand all enclosed instructions for proper use of this product.
- Don't allow children to climb on or play with furniture and television sets.
- Don't place flat panel displays on furniture that can easily be used as steps, such as a chest of drawers.
- Remember that children can become excited while watching a program, especially on a "larger than life" flat panel display. Care should be taken to place or install the display where it cannot be pushed, pulled over, or knocked down.
- Care should be taken to route all cords and cables connected to the flat panel display so that they cannot be pulled or grabbed by curious children.

WALL MOUNTING: IF YOU DECIDE TO WALL MOUNT YOUR FLAT PANEL DISPLAY, ALWAYS:

- Use a mount that has been recommended by the display manufacturer and/or listed by an independent laboratory (such as UL, CSA, ETL).
- Follow all instructions supplied by the display and wall mount manufacturers.
- If you have any doubts about your ability to safely install your flat panel display, contact your retailer about professional installation.
- Make sure that the wall where you are mounting the display is appropriate. Some wall mounts are not designed to be mounted to walls with steel studs or old cinder block construction. If you are unsure, contact a professional installer.
- A minimum of two people are required for installation. Flat panel displays can be heavy.



 **CEA**
Consumer Electronics Association
www.CE.org/safety

SAFETY PRECAUTIONS

The unit emits heat when in operation. Do not place any covers or blankets on the unit, this may cause overheating. Do not block ventilation holes, or set up near radiators. Do not place in direct sunlight. When placing on a shelf leave 4 inches (10 cm) free space around the entire unit.

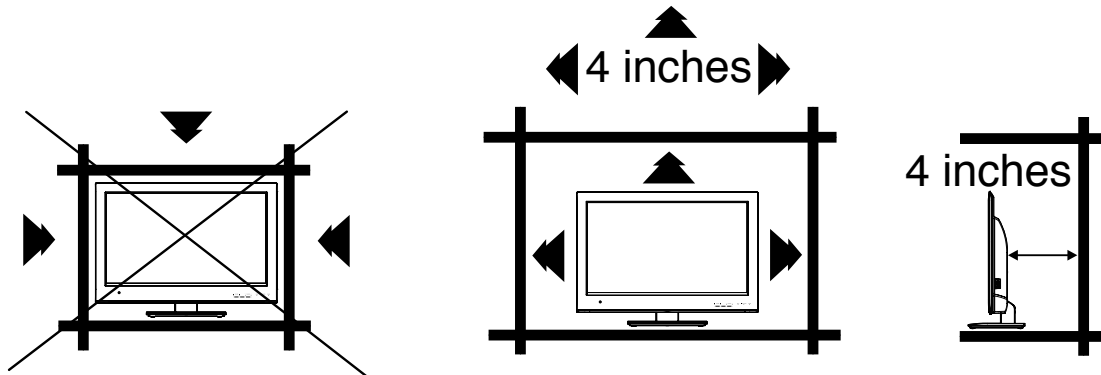

Notes when mounting the LED TV on a wall

If the unit is to be mounted on the wall, contact the retailer where you purchased the LED TV for advice, and have the equipment professionally installed. Incomplete or improper installation may cause injury to you, and/or damage to the LED TV.

The screws ISO M4 thread type should be used. The insertion length must be within 12 - 16mm.

If the insertion length is less than 12mm, the weight can not be maintained.

If the insertion length is more than 16mm, a space is created between the Wall Mount Bracket and the Television.

$(\text{Insertion Length}) = (\text{Screw Length}) - (\text{Washers Thickness}) - (\text{Mounting Bracket Thickness})$

Securing to a Wall

1. Using metallic wire fasten the set to the clamping screw on the rear of the LED TV as shown below.
2. Keep the LED TV 4 inches away from the wall except when mounted using the wall mount bracket and secure to the wall as shown below:

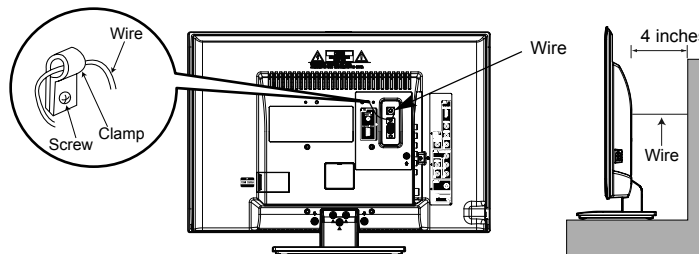

NOTICE FOR TV CABINET

If the unit is to be mounted on a cabinet smaller than length of the unit, it could result in an unstable location and the unit may tumble over, making a risk of personal, possibly fatal injury. Also, this would damage the product seriously. Accordingly, Hitachi accepts no responsibility or liability for any injuries or property damage resulting from the improper installation.

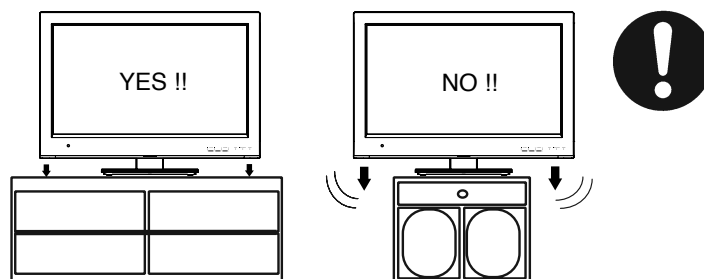

WARNING

Do not use this TV with wall mounts that allow the TV to tilt vertically. Vertical tilting wall mounts may cause structural damage to the TV. Use ONLY fixed or horizontal swiveling wall mounts with this TV.

How to attach the stand

NOTE:

- Unplug the AC cord from the AC INPUT terminal.
- Before beginning this process, assure that TV is laid on a clean, safe, and cushioned space to avoid any damage to the unit.
- Do not touch or press the LCD screen, the glass might break under pressure.

Place the TV on its front onto a table.
Align the stand's bottom-plate (supplied) as seen here.
It will fit in only one direction.
Hold the unit and attach the stand slowly.

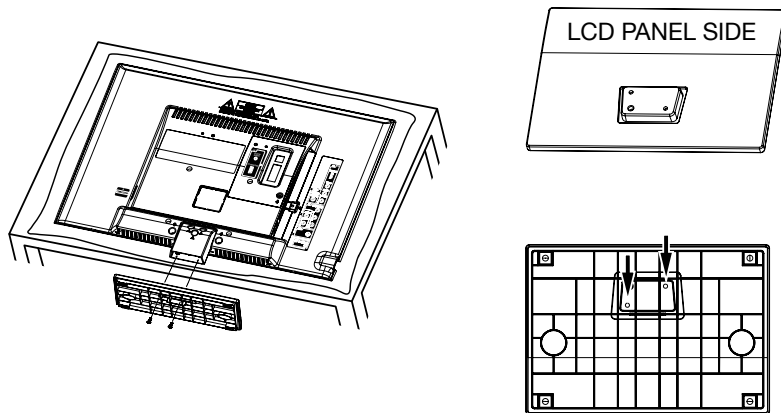

- Finally secure the bottom-plate with 2 screws (supplied).
- Be sure to follow the instructions. Incorrect installation of the stand may result in the TV falling over.

How to remove the stand

When you transport this product, remove the stand and pack flat against the back of the unit in the carton. To remove the stand, perform these steps in reverse order.

For wall mounting, the base must be removed. To disconnect the base/stand remove the 3 screws from the back.

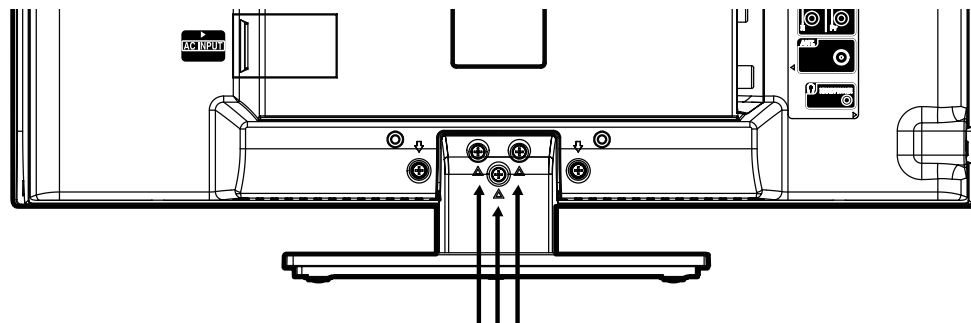

Features

LED color TV

Unique space saving design combines a 19" class LED color TV.

Integrated Digital Tuner - You can view digital broadcasts without using a Digital TV Set-Top Box.



Closed Caption Decoder With Full Text Mode - Displays text captions or full screen text on the screen for hearing impaired viewers.

Picture Adjustments Using The Remote Control - The On-Screen display allows precise remote control adjustment of BRIGHTNESS, CONTRAST, COLOR, TINT and SHARPNESS.

Programmable TV Sleep Timer - Operable from the remote control, the TV can be programmed for up to 120 minutes to turn off automatically.

On-Screen 3 Language Display - You can select one of 3 languages, English, Spanish or French for on-screen programming.

V-Chip - The V-Chip function can read the rating of a TV program or movie content if the program is encoded with this information. V-chip will allow you to set a restriction level.

This LED Television receiver will display television closed captioning, ( or ), in accordance with paragraph 15.119 and 15.122 of the FCC rules.

* HDMI, the HDMI Logo, and High-Definition Multimedia Interface are trademarks or registered trademarks of HDMI Licensing LLC in the United States and other countries.

* Manufactured under license from Dolby Laboratories. Dolby and the double-D symbol are trademarks of Dolby Laboratories.

* VGA and XGA are trademarks of International Business Machines Corporation.

* VESA is a registered trademark of the Video Electronics Standard Association.

Power source

TO USE AC POWER

1. Connect the AC cord plug into this unit's AC IN jack.
2. Connect the AC cord into an AC outlet.

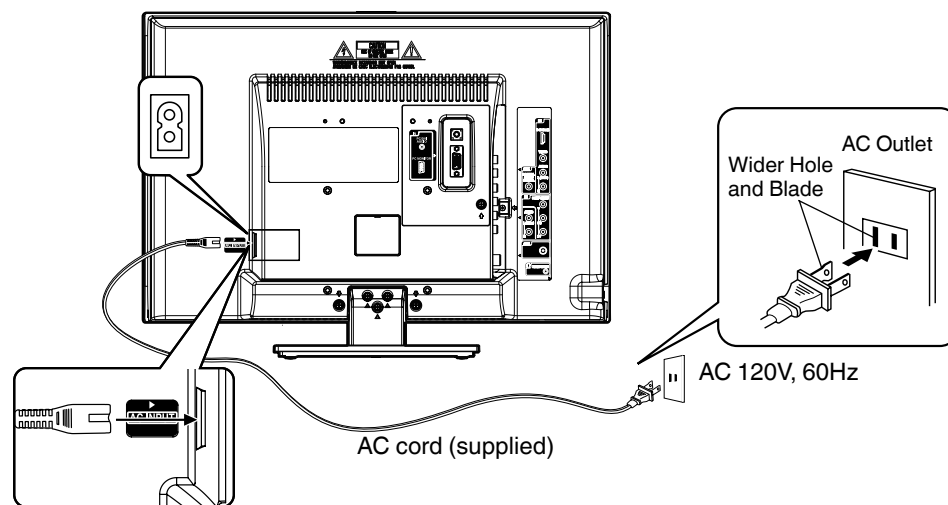

NOTE:

- Please make sure to insert the cord securely at both the LED TV and the wall outlet.
- The AC Cord has a polarized type AC line plug. If the supplied AC cord does not match your AC outlet, contact a qualified electrician.

WARNING:

- DO NOT CONNECT THIS UNIT TO THE POWER USING ANY DEVICE OTHER THAN THE SUPPLIED AC CORD. THIS COULD CAUSE FIRE, ELECTRICAL SHOCK, OR DAMAGE.
- DO NOT USE WITH A VOLTAGE OTHER THAN THE POWER VOLTAGE SPECIFIED. THIS COULD CAUSE FIRE, ELECTRICAL SHOCK, OR DAMAGE.

CAUTION:

- WHEN THIS UNIT IS NOT USED FOR A LONG TIME, (E.G., AWAY ON A TRIP) IN THE INTEREST OF SAFETY, BE SURE TO UNPLUG IT FROM THE AC OUTLET.
- DO NOT PLUG/UNPLUG THE AC CORD WHEN YOUR HANDS ARE WET. THIS MAY CAUSE ELECTRICAL SHOCK.
- IF YOU NEED TO REPLACE THE SUPPLIED AC ADAPTER OR AC CORD, THE SPECIFIED ONE IS RECOMMENDED. CONTACT THE DEALER THAT YOU PURCHASED THE UNIT FROM.

Contents

Before using your unit

IMPORTANT SAFETY INSTRUCTIONS.....	3
CHILD SAFETY NOTICE	5
SAFETY PRECAUTIONS	6
How to attach the stand	7
How to remove the stand	7
Features.....	8
Power source	8
Contents	9
Location of controls.....	10
Remote control	11
Antenna connections	12
Cable TV connections.....	12

TV operation

Starting setup	13
TV operation	13
Quick guide for menu operation.....	14
Convenience functions	15
Memorizing channels.....	16
Checking the digital-signal strength	17
Labeling channels.....	17
Labeling video inputs.....	17
Setting the Parental Control	17
Closed Caption	19
CC advanced.....	19
Aspect Switching	19

Additional information

Connections to other equipment.....	21
Reception disturbances	24
Troubleshooting	25
Specifications	26
LIMITED WARRANTY	27

ENGLISH

Location of controls

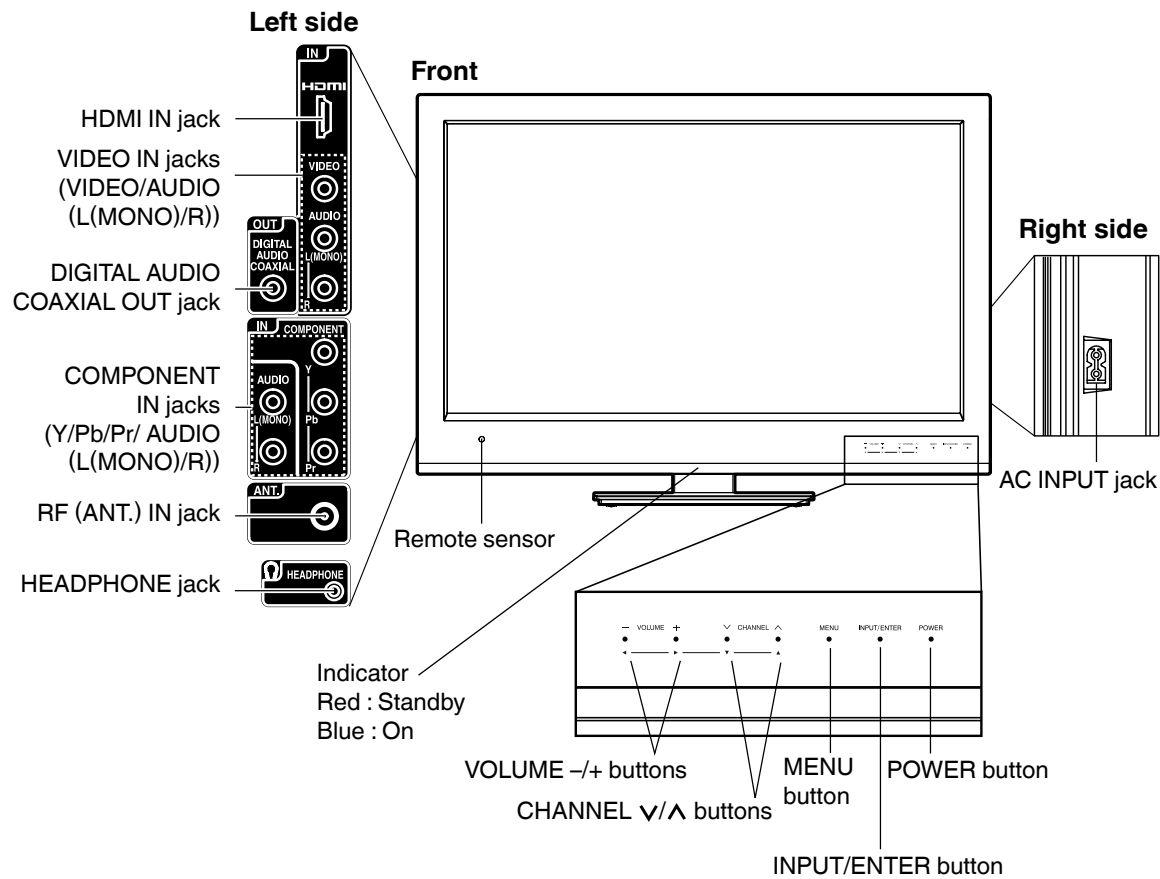

To display the menu screen.
 Touch **MENU** button to display the menu screen.
CHANNEL ∇/Δ buttons, **VOLUME $-/+$** buttons and **INPUT/ENTER** button can be used to select the desired setting during the menu screen operations.

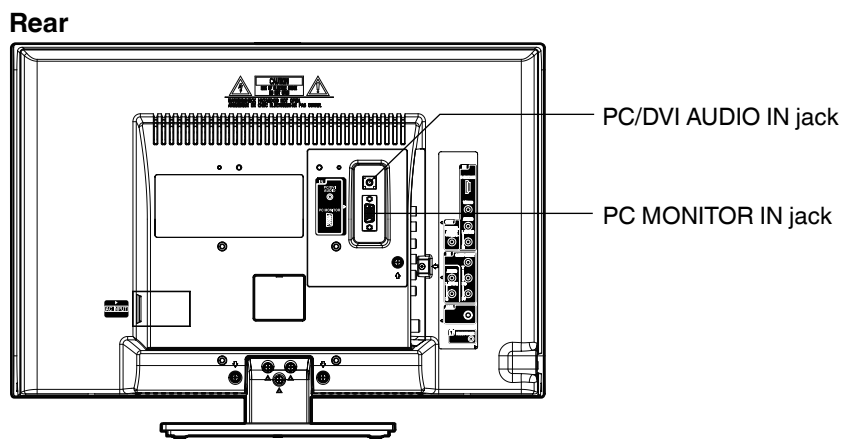

Remote control

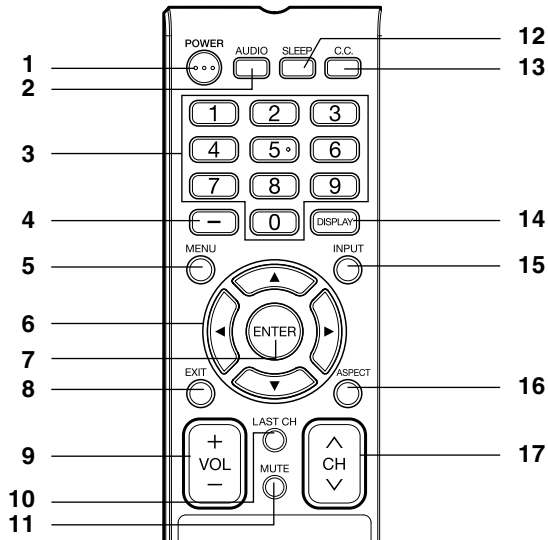

1. **POWER Button** - Press to turn the LED TV's power on/off.
2. **AUDIO Button** - Press to change the audio language.
3. **Direct Channel Selection Buttons (0-9)** - Allows direct access to any channel of the LED TV.
4. **- Button** - This button is the "-" button used when selecting digital channels.

5. **MENU Button** - Press to display the On-Screen menu.
6. **CURSOR ▲/▼/◀/▶ Buttons** - Use to navigate and select menu functions of the LED TV.
7. **ENTER Button** - Press to enter or select functions for the On-Screen menu.
8. **EXIT Button** - Press to exit the On-screen menu.
9. **VOL (VOLUME) + / - Buttons** - Press the + button to increase, or the - button to decrease the sound level.
10. **LAST CH Button** - Pressing this button allow you to go back to the previous channel selected. Press this button again to return to the channel you were watching.
11. **MUTE Button** - To turn off the sound, press this button once. The LED TV will be silenced and the "Mute" symbol will appear on the screen. The muting feature can be released by pressing the MUTE button again or by pressing either of the VOL (VOLUME) + or - buttons.
12. **SLEEP Button** - To set the LED TV to turn off after a preset amount of time, use the SLEEP button on the remote control.
13. **C.C. Button** - Used to display the Closed Caption menu screen.
14. **DISPLAY Button** - When you press this button, the current information will be displayed on the screen.
15. **INPUT Button** - Press to change the TV's input.
16. **ASPECT Button** - Press to change the picture size.
17. **CH (CHANNEL) ^ / v Buttons** - Press to change the channels of the LED TV.

Before using the remote control, batteries must first be installed.

HOW TO INSTALL BATTERIES

1. Open the battery compartment cover.

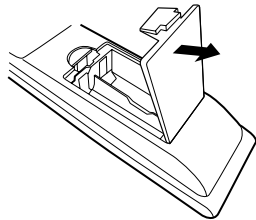

2. Install two "AA" batteries (supplied).

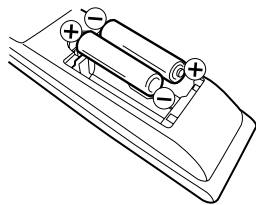

3. Replace the battery compartment cover.

Use two "AA" size batteries. The batteries may last approximately one year depending on how much the remote control is used. For best performance, it is recommended that batteries should be replaced on a yearly basis, or when the remote operation becomes erratic. Do not mix old and new batteries or different types.

BATTERY PRECAUTIONS

These precautions should be followed when using batteries in this device:

- Use only the size and type of batteries specified.
- Be sure to follow the correct polarity when installing the batteries as indicated in the battery compartment. Reversed batteries may cause damage to the device.
- Do not mix different types of batteries together (e.g. Alkaline and Carbon-zinc) or old batteries with fresh ones.
- If the device is not to be used for a long period of time, remove the batteries to prevent damage or injury from possible battery leakage.
- Do not try to recharge batteries not intended to be recharged; they can overheat and rupture. (Follow battery manufacturer's directions.)
- Please use caution when inserting batteries to avoid battery damage. If the spring terminal in the remote control remains in contact with a side of a damaged battery it can cause a short circuit. Never use damaged batteries as they can become very hot and are dangerous.

Antenna connections

If you are using an indoor or outdoor antenna, follow the instructions below that correspond to your antenna system. If you are using a Cable TV service, see Cable TV connections.

Combination VHF/UHF Antenna (Single 75 ohm cable)

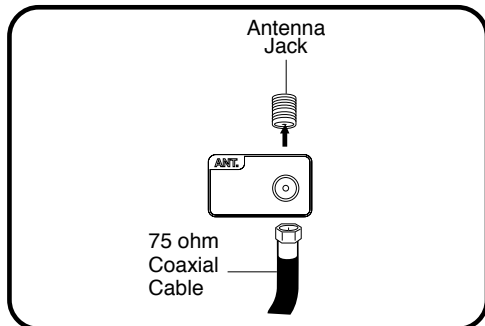

Connect the 75 ohm cable from the combination VHF/UHF antenna to the antenna jack.

Cable TV connections

This TV has an extended tuning range and can tune most cable channels without using a Cable TV Converter box. Some cable companies offer "premium pay channels" where the signal is scrambled. Descrambling these signals for normal viewing requires the use of a descrambler device which is generally provided by the Cable TV company.

For subscribers to basic Cable TV service

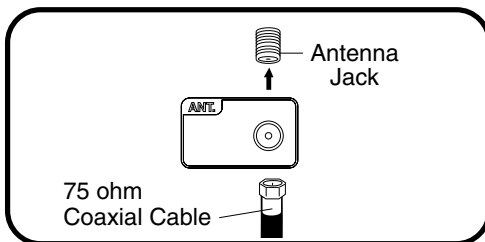

For basic Cable TV service not requiring a Converter/Descrambler box, connect the 75 ohm Coaxial Cable directly to the Antenna Jack on the back of the TV.

For subscribers to scrambled Cable TV service

If you subscribe to a Cable TV service which requires the use of a Converter/Descrambler box, connect the incoming 75 ohm Coaxial Cable to the Converter/Descrambler box. Using another 75 ohm Coaxial Cable, connect the output jack of the Converter/Descrambler box to the Antenna Jack on the TV. Follow the connections shown below. Set the TV to the output channel of the Converter/Descrambler box (usually channel 3 or 4) and use the Converter/Descrambler box to select channels.

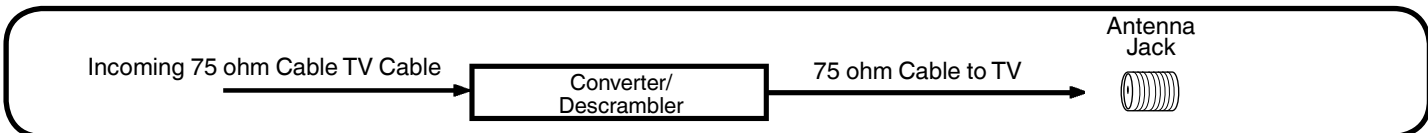

For subscribers to unscrambled Cable TV service with scrambled premium channels

If you subscribe to a Cable TV service in which basic channels are unscrambled and premium channels require the use of a Converter/Descrambler box, you may wish to use a signal Splitter and an A/B Switch box (available from the Cable TV company or an electronics supply store). Follow the connections shown below. With the switch in the "B" position, you can directly tune any unscrambled channels on your TV. With the switch in the "A" position, tune your TV to the output of the Converter/Descrambler box (usually channel 3 or 4) and use the Converter/Descrambler box to tune scrambled channels.

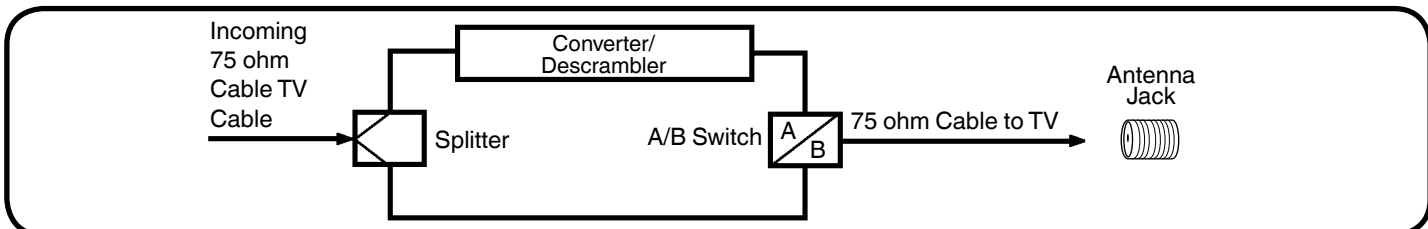

IMPORTANT NOTICE

The nationwide switch to digital television broadcasting will be complete on June 12, 2009, but your local television stations may switch sooner. After the switch, analog-only television sets that receive TV programming through an antenna will need a converter box to continue to receive over-the-air TV. Watch your local stations to find out when they will turn off their analog signal and switch to digital-only broadcasting. Information about the DTV transition is available from your local television stations, www.DTV.gov, or 1-888-CALL-FCC (TTY 1-888-TELL-FCC), and www.dtv2009.gov or 1-888-DTV-2009 (TTY 1-877-530-2634) for information about subsidized coupons for digital-to-analog converter boxes. Please review this Operating Guide for further information regarding such connections. Hitachi supports the DTV transition and as a member of the DTV Transition Coalition urges consumers to visit these web sites for interactive guides and further detailed information:

- www.dtvtransition.org
- www.myceknowhow.com
- www.dtv2009.gov

Starting setup

The Starting Setup menu appears the first time you turn on the TV. It will assist you to specify the Air/Cable setting and program your channels automatically.

IMPORTANT: Make sure that the antenna or cable TV system connection is made!

- 1 To turn on the TV, press **POWER** (POWER indicator on the front of the unit changes blue. It may take approx. 10 seconds for a picture to appear on screen.). The starting setup function begins.

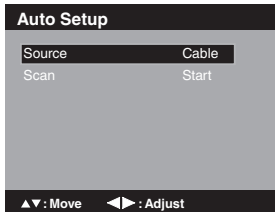

- 2 Press **▲** or **▼** to select "Source", then press **◀** or **▶** to select "Cable" or "Air".
- 3 Press **▲** or **▼** to select "Scan", then press **▶** or **ENTER**.
- 4 Now the "Auto Setup" starts. After the starting setup is completed, the TV channel appears on the screen.
 - Depending on the reception condition, it may take from 15 minutes to 30 minutes to complete memorizing digital cable channels. Please be patient.

NOTE:

- If you press **ENTER** in the process of "Auto Setup", the Starting Setup stops and changes to the normal screen.
- When you make a menu selection, your changes occur immediately. You do not have to press **EXIT** to see your changes.

TV operation

- 1 To turn on the TV, press **POWER**. (POWER indicator on the front of the unit changes blue. It may take approx. 10 seconds for a picture to appear on screen.)
- 2 Adjust the volume level by pressing **VOL +** or **-**. The volume level will be indicated on the screen by blue bars. As the volume level increases, so do the number of bars. If the volume decreases, the number of blue bars also decreases.
- 3 Set the Signal Type option to the appropriate position (see "Air/Cable selection" on page 16).
- 4 Press the **Direct Channel Selection (0-9, -)** buttons to select the channel. (If you press only the channel number, channel selection will be delayed for a few seconds.)

TO SELECT ANALOG CHANNELS

- 1-9: Press 1-9 as needed. Example, to select channel 2, press **2**, then press **ENTER**.
- 10-99: Press the 2 digits in order. Example, to select channel 12, press **1**, **2**, then press **ENTER**.
- 100-135: Press the 3 digits in order. Example, to select channel 120, press **1**, **2**, **0**, then press **ENTER**.

TO SELECT DIGITAL CHANNELS

Press the first 3 digits, then press the **-** button followed by the remaining number.

Example, to select channel 15-1, press **1**, **5**, **-**, **1**, then press **ENTER**.

- If a channel is selected with only audio content, "Audio Only" will be displayed on the screen.
- If a channel is selected with a weak digital signal, "Weak Signal or Channel not available." will be displayed on the screen.
- The same program may be available on either an analog channel or a digital channel. You may choose to watch either format.
- If a channel is selected to which you have not subscribed, "Digital channel is encrypted" will be displayed on the screen.

VHF/UHF/CABLE CHANNELS

Air	Cable
VHF 2-13	VHF 2-13
UHF 14-69	STD/HRC/IRC 14-36 (A) (W) 37-59 (AA) (WW) 60-85 (AAA) (ZZZ) 86-94 (86) (94) 95-99 (A-5) (A-1) 100-135 (100) (135) 01 (4A)

NOTE:

- If a channel with no broadcast is selected, the sound will automatically be muted.
- It may take a few seconds for a digital channel picture to appear on screen after being selected.

To select the video input source

To view a signal from another device connected to your LED TV, such as a VCR player, press **INPUT**, then press **▲/▼** or corresponding **Number buttons (0-4)**, then press **ENTER**. You can select TV, Video, Component, HDMI or PC depending on which input jacks you used to connect your devices.

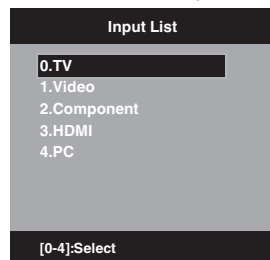

CH ^/∨

Press and release **CH ^/∨**. The channel automatically stops at the next channel set into memory.

For proper operation, before selecting channels, they should be set into the memory. See "Memorizing channels" on page 16.

DISPLAY

Press **DISPLAY** to display the current information on the screen.

When the TV receives a digital signal, the digital information will appear.

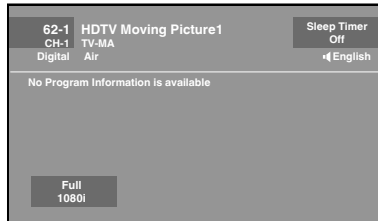

- Channel number
- Channel label (if preset)
- V-Chip rating
- Sleep timer
- Program guide
- Resolution
- Station name
- Broadcast program name
- Signal type
- Audio language
- Picture size

When the TV receives an analog signal, the analog information will appear.

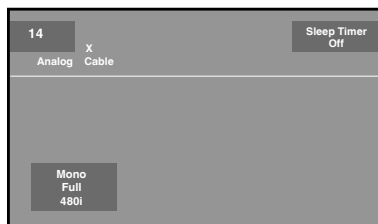

- Channel number
- Channel label (if preset)
- V-Chip rating
- Sleep timer
- Audio information (Stereo, SAP or Mono)
- Signal type
- Picture size
- Resolution

Press **DISPLAY** again to clear the display.

NOTE:

- After a few seconds, DISPLAY screen will return to normal TV-operation automatically.

LAST CH

This button allows you to go back to the last channel selected by pressing **LAST CH**. Press **LAST CH** again to return to the last channel you were watching.

MUTE

Press **MUTE** to switch off the sound. The TV's sound will be silenced and "Mute" will appear on the screen. The sound can be switched back on by pressing this button again or by pressing the **VOL +** or **-** buttons.

SLEEP

To set the TV to turn off after a preset amount of time, press **SLEEP** on the remote control. The clock will count up 10 minutes for each press of the **SLEEP** button (Off, 0h 10m, 0h 20m, ..., 2h 0m). After the sleep timer is programmed, the display will appear briefly every ten minutes to remind you that the sleep timer is operating. To confirm the sleep timer setting, press **SLEEP** and the remaining time will be displayed for a few seconds. To cancel the sleep timer, press **SLEEP** repeatedly until the display turns to Off.



Quick guide for menu operation

Example: Select Language.

- 1 Press **INPUT** to select TV mode.
- 2 Press **MENU**. The TV menu screen will appear.

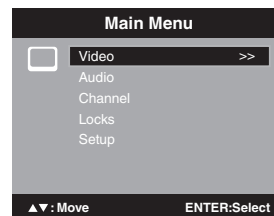

- 3 Press **▲** or **▼** to select "Setup", then press **▶** or **ENTER**.
- 4 Press **▲** or **▼** to select "Menu Language", then press **◀** or **▶** to select the desired language.
...on the following pages the menu can be called in the same way as here.
- 5 Press **EXIT** to return to the normal screen.

NOTE:

- If no buttons are pressed for more than 60 seconds, the menu screen will clear and the TV will return to normal viewing automatically.



Convenience functions

You can change the default settings to your preferred settings.

Icon	Selected Items	Setup hint	
Video	Picture Setting	Brightness / Contrast / Sharpness / Color / Tint	You can adjust the picture quality to your preference.
		Color Temperature	Bluish (Cool) / Neutral (Standard) / Reddish (Warm)
		Backlight	The Backlight feature adjusts the screen brightness for improved picture clarity.
	Picture Mode	Dynamic	Bright and dynamic picture (factory-set)
		Standard	Standard picture quality (factory-set)
		Movie	Movie-like picture setting (factory-set)
		Custom	Your personal preferences (set by you; see "Picture Setting")
	DBC	On / Off	Use this feature to change the Black level automatically according to the brightness of an image. The Black level will become dark in a dark scene.
	Aspect		See page 19.
	Auto Movie Mode	On/Off	A smoother motion may be obtained by setting the Auto Movie Mode to "On" when you view a DVD.
	PC Setting	H Position / V Position	Adjust the horizontal / vertical position of the image on the PC Monitor screen. Each video standard will require a different value for this setting.
		Clock	Minimize any vertical bars or stripes visible on the screen background.
		Phase	This must be adjusted after the frequency has been set optimize picture quality.
		Auto Adjust	Adjust the all PC settings automatically.
Noise Reduction	On/Off	Noise Reduction can reduce the roughness of the picture.	
Audio	Bass / Treble / Balance		You can adjust the sound quality to your preference.
	MTS	Stereo / SAP / Mono	The multi-channel TV sound (MTS) feature provides high-fidelity stereo sound. MTS also can transmit a second audio program (SAP) containing a second language or other audio information. When the TV receives a stereo or SAP broadcast, the word "Stereo" or "SAP" displays on-screen when you press DISPLAY .
	Surround	On/Off	The dynamic presence and sound created offers a thoroughly enjoyable listening experience.
	Audio Language		When two or more audio languages are included in a digital signal, you can select one of the audio language. (This function is available only for digital broadcast.)
	HDMI Audio	HDMI	When you connect the HDMI device to the TV, select this setting.
		DVI	When you connect the DVI device to the TV with an analog audio connection, select this setting.
Channel	Channel Manager		See page 16.
	Signal Meter		See page 17.
	Auto Channel Scan		See page 16.
	Channel Labels		See page 17.
Locks		See page 17.	
Setup	Closed Captions		See page 19.
	Menu Language		You can choose from three different languages (English, Français (French) and Español (Spanish)) for the on-screen displays. Select the language you prefer first, then proceed with the other menu options.
	Video Label		See page 17.
	On Timer	Off / 0h30m / 1h00m / 1h30m / 2h00m / 3h00m . . . 12h00m	You can set the On Timer to automatically turn on the TV. To cancel the On Timer select "Off".
	Auto Shut* Off	On/Off	If the Auto Shut Off feature is On, a station being viewed stops broadcasting and the TV is not operated, the TV will automatically shut itself off after 15 minutes.
	Power On/Off Sound	On/Off	When you turn on/off the TV a sound will output from TV.
	Power On LED	On/Off	When you turn on the TV, the Power indicator on the front of the TV will light.
	Reset		The Reset function returns your settings to the factory settings. "Aspect", "MTS", "Audio Language" and "HDMI Audio" cannot be reset by this function.

NOTE:

* If there is no input signal in the HDMI or PC mode after 1 minute, Auto Shut Off will be activated.

Memorizing channels

This TV is equipped with a channel memory feature which allows channels to skip up or down to the next channel set into memory, skipping over unwanted channels. Before selecting channels, they must be programmed into the TV's memory. To use this TV with an antenna, set the Source option to the Air mode. When shipped from the factory, this menu option is in the Cable mode.

Air/Cable selection

- 1 Select "Channel", then press ► or ENTER.
- 2 Press ▲ or ▼ to select "Auto Channel Scan", then press ► or ENTER.
- 3 Press ▲ or ▼ to select "Source".
- 4 Press ◀ or ▶ to select "Air" or "Cable".

Air - VHF/UHF channels
Cable - CABLE TV channels

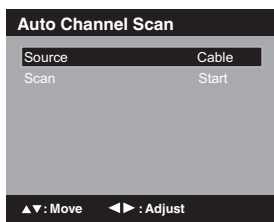

NOTE:

- It may take a few seconds for a digital channel picture to appear on screen after being selected.

Scan

- 1 Select "Channel", then press ► or ENTER.
- 2 Press ▲ or ▼ to select "Auto Channel Scan", then press ► or ENTER.
- 3 Press ▲ or ▼ to select "Scan", then press ► or ENTER.

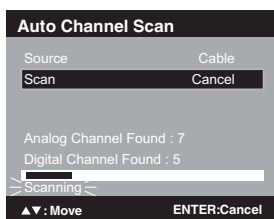

- 4 The TV will begin memorizing all the channels available in your area.
 - It may take from 15 minutes to 30 minutes to complete memorizing digital cable channels.
 - Depending on the reception condition, a bar display may not advance for several minutes, please be patient.

NOTE:

- Memorizing channels is best accomplished during evening "PRIMETIME" hours, as more stations are broadcasting digital signals. Memorizing channels can only be accomplished while a station is broadcasting a digital signal to set that channel into memory.
- If you are unsure of the digital channels available in your area, you may visit www.antennaweb.org to receive a list based on your address or zip code. Should you require further assistance you may call our toll-free customer service line at 1-800-289-0981.
- New digital channels may be added to your area periodically, it is recommended to perform the "Scan" procedure regularly.



Add Digital Channel

If you find a new unregistered digital channel, you can add the new channel into the channel memory.

- 1 Tune in the new channel.
- 2 Select "Channel", then press ► or ENTER.
- 3 Press ▲ or ▼ to select "Channel Manager", then press ► or ENTER.

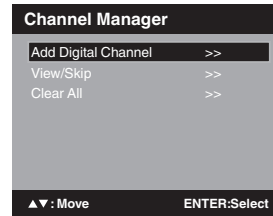

- 4 Press ▲ or ▼ to select "Add Digital Channel", then press ► or ENTER. The new channel will be added into the channel memory.

View/Skip channel

You can select the channel that you want to skip.

- 1 Select "Channel", then press ► or ENTER.
- 2 Press ▲ or ▼ to select "Channel Manager", then press ► or ENTER.
- 3 Press ▲ or ▼ to select "View/Skip", then press ► or ENTER.
- 4 Press ▲ or ▼ to select the channel that you want to skip.

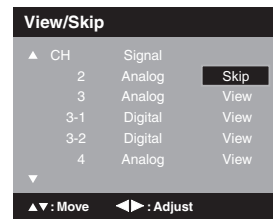

- 5 Press ◀ or ▶ to select "View" or "Skip", whichever function you want to perform.
- 6 Repeat steps 4 - 5 for other channels you want to view or skip.

Clear All

All channels are deleted from the channel memory.

- 1 Select "Channel", then press ► or ENTER.
- 2 Press ▲ or ▼ to select "Channel Manager", then press ► or ENTER.
- 3 Press ▲ or ▼ to select "Clear All", then press ► or ENTER.

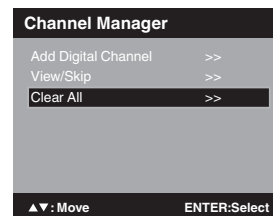

Checking the digital signal strength

This TV will allow you to view the digital signal meter for digital channels.

- 1 Select "Channel", then press **▶** or **ENTER**.
- 2 Press **▲** or **▼** to select "Signal Meter".
- 3 Press **▶** or **ENTER** to check the Digital Signal strength. The Digital Signal strength screen will appear. If necessary, adjust the direction of the antenna to obtain the maximum signal strength.

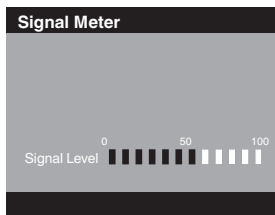

NOTE:

- Signal meter feature is not available for analog channels.
- After 240 seconds, the Signal Meter screen will clear and the TV will return to normal viewing automatically.

Labeling channels

Channel label appears with the channel number display each time you turn on the TV, select a channel, or press **DISPLAY**. You can choose any four characters to identify a channel.

To create channel labels

- 1 Select "Channel", then press **▶** or **ENTER**.
- 2 Press **▲** or **▼** to select "Channel Labels", then press **▶** or **ENTER**. The "Channel Labels" menu will appear.
- 3 Press **◀** or **▶** to select a channel you want to label, then press **▼**.

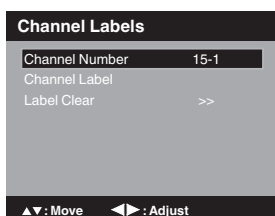

- 4 Press **◀** or **▶** repeatedly until the character you want appears in the first space.

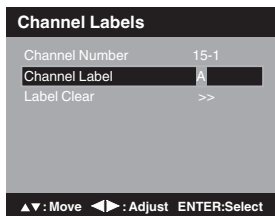

The characters rotation as follows:

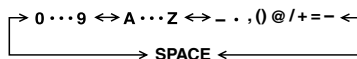

If the character which you desire appears, press **ENTER**. Repeat this step to enter the rest of the characters. If you would like a blank space in the label name, you must choose the empty space from the list of characters.

- 5 Repeat steps 3-4 for other channel. You can assign a label to each channel.
- 6 When you finish inputting the label name, press **EXIT** to return to the normal screen.

To clear a Channel Label

After step 3 above, press **▲** or **▼** to select "Label Clear", then press **▶** or **ENTER**.

NOTE:

- The channel labels will be reset after "Scan" on page 16.

Labeling video inputs

The Video Label feature allows you to label each input source for your TV.

- 1 Select "Setup", then press **▶** or **ENTER**.
- 2 Press **▲** or **▼** to select "Video Label", then press **▶** or **ENTER**.
- 3 Press **▲** or **▼** to select an input which you want to label.
- 4 Press **◀** or **▶** to select the desired label for that input source.

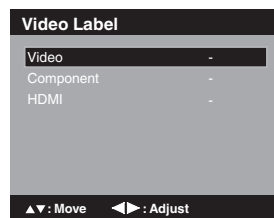

- : Uses the default label name
- VCR : Video cassette recorder
- DVD : DVD video
- DTV : Digital TV set-top box
- SAT : Satellite box
- CBL : Cable box
- HD : HDMI device (only for HDMI inputs)

Setting the Parental Control

An age limitation can be set to restrict children from viewing or hearing violent scenes or pictures that you may choose to exclude. The restriction applies to "TV" and "Movie" if this data is transmitted. You may set this restriction separately. To use the Parental Control function, you must register a password.

To register a password

- 1 Select "Locks", then press **▶** or **ENTER**.
- 2 Select and enter your password (4 digits) using **Number buttons (0-9)**, then press **ENTER**.

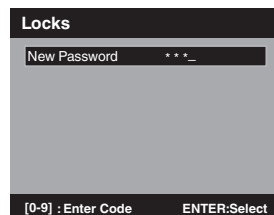

- 3 "∗" appears instead of the number. Enter the same password again to confirm, then press **ENTER**. The password is now registered.

NOTE:

- If you forget the password, contact Customer Service at 1-800-289-0981 for assistance. Your original remote control will be required.
- To avoid forgetting the password, write it down and keep in a safe place.

To set the Parental Control

- 1 Select "Locks" menu, then press ► or **ENTER**.
- 2 Use **Number buttons (0-9)** to enter your password, then press **ENTER**. Then Locks menu will appear.
- 3 Press ▲ or ▼ to select "Parental Control", then press ◀ or ▶ to select "On".
- 4 Press ▲ or ▼ to select "Ratings", then press ► or **ENTER**. The Ratings Menu appears.
- 5 Press ▲ or ▼ to select which rating will be used, then press ► or **ENTER**. Each rating below will appear.

TV Rating

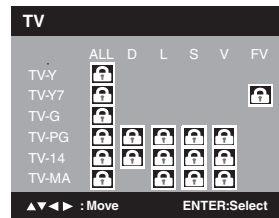

You can set the rating using age level and genre.

Age:

- TV-Y** : All children
- TV-Y7** : 7 years old and above
- TV-G** : General audience
- TV-PG** : Parental guidance
- TV-14** : 14 years old and above
- TV-MA** : 17 years old and above

Genre:

- ALL** : All
- D** : Dialogue
- L** : Language
- S** : Sex
- V** : Violence
- FV** : Fantasy Violence

Movie Rating

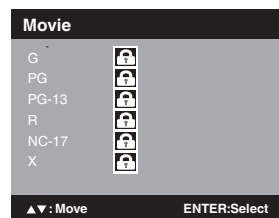

- G** : All ages
- PG** : Parental guidance
- PG-13** : Parental guidance less than 13 years old
- R** : Under 17 years old parental guidance suggested
- NC-17** : 17 years old and above
- X** : Adult only

- 6 Press ▲/▼/◀/▶ to select the desired rating, then press **ENTER**.
- 7 Press **EXIT** to return to the normal screen. Parental Control function is activated now.

To use the TV after the TV is protected.

When a program is received that is blocked by the Parental Control, press **MUTE**, then enter your password. The protection will be temporarily overridden. If the TV is turned off or the channel is changed, the Parental Control restriction will be reactivated.

NOTE:

- The Parental Control function is activated only on programs and input sources that include a rating signal.

To change the password

- 1 Select "Locks", then press ► or **ENTER**.
- 2 Use **Number buttons (0-9)** to enter your password, then press **ENTER**. The Locks menu will appear.
- 3 Press ▲ or ▼ to select "Change Password", then press ► or **ENTER**. The Change Password screen will appear.
- 4 Enter a new password using **Number buttons (0-9)**, then press **ENTER**.
- 5 Enter the same password again to confirm, then press **ENTER**. The password is now registered.

Downloading the additional Parental Control rating system

As a supplement to the standard Parental Control rating system, your television will be able to download an additional rating system, if such a system becomes available in the future.

To download the additional Parental Control rating system (when available)

- 1 Select "Locks", then press ► or **ENTER**.
- 2 Use **Number buttons (0-9)** to enter your password, then press **ENTER**. The Locks menu will appear.
- 3 Press ▲ or ▼ to select "Parental Control", then press ◀ or ▶ to select "On".
- 4 Press ▲ or ▼ to select "Region 5", then press ► or **ENTER**.
- 5 If the TV is not storing the additional rating system, the TV will begin downloading it, which may take some time to be completed.
- 6 Set your preferred content rating limits for the additional rating system.
- 7 You also need "Region 5 Update" procedure to update rating information.

NOTE:

- You can only download the additional Parental Control rating system when your TV is receiving a digital signal.
- When you download the additional rating system, it may take some time for the download to occur.
- The Parental Control rating information and system are not determined or controlled by the TV.
- The standard Parental Control rating system is available whether your TV is receiving a digital signal or not, and will block both analog and digital programs. To set the restriction level using the standard Parental Control rating system, select Parental Control Set in step 4.
- The downloadable Parental Control rating system is an evolving technology, and availability, content, and format may vary.
- You cannot select this feature if the TV is not receiving a digital signal for the current station.

To clear the all Parental Control settings

- 1 Select "Locks", then press ► or **ENTER**.
- 2 Use **Number buttons (0-9)** to enter your password, then press **ENTER**. The Locks menu will appear.
- 3 Press ▲ or ▼ to select "Reset", then press ► or **ENTER**. The Password screen will appear.
- 4 Use **Number buttons (0-9)** to enter your password, then press **ENTER**. All your settings return to the factory settings.

Closed Caption

WHAT IS CLOSED CAPTIONING?

This television has the capability to decode and display Closed Captioned television programs. Closed Captioning will display text on the screen for hearing impaired viewers.

Captions: This Closed Caption Mode will display text on the screen in English or another language if program supports other languages. Generally, Closed Captions in English are transmitted on CC1 and a Closed Caption in other languages is transmitted on CC2.

Text: The Text Closed Caption Mode will usually fill 1/2 of the screen with other text information such as weather if program supports this feature.

- 1 Select "Setup", then press ► or **ENTER**.
- 2 Press ▲ or ▼ to select "Closed Captions", then press ► or **ENTER**.
The Closed Caption menu will appear.
- 3 Press ◀ or ▶ to set "CC Display" to "On".
On: Captions will be displayed on the screen.
Off: Captions will not be displayed on the screen.
- 4 Press ▲ or ▼ to select "Analog Caption" or "Digital Caption".
When you select "Analog Caption", you can choose from CC1, CC2, CC3, CC4, Text1, Text2, Text3 and Text4.
When you select "Digital Caption", you can choose from Service1, Service2, Service3, Service4, Service5 and Service6.
- 5 Press ◀ or ▶ to select the desired Closed Caption mode for both Digital and Analog Caption.
- 6 Press ▲ or ▼ to select "CC Priority", then press ◀ or ▶ to select "Digital CC" or "Analog CC".

NOTE:

- Depending on the broadcast signal, some Analog Captions will function with a Digital broadcast signal. This step prevents that two kind of captions are overlapping.

NOTE:

- If the program or video you selected is not closed-captioned, no captions will display on-screen.
- If text is not available in your viewing area, a black rectangle may appear on-screen. If this happens, set the CC Display to "Off".
- When selecting Closed Captions, the captioning will be delayed approx. 10 seconds.
- If no caption signal is received, no captions will appear, but the television will remain in the Caption Mode.
- Misspellings or unusual characters may occasionally appear during Closed Captioning.
This is normal with Closed Captioning, especially with live programs. This is because during live programs, captions are also entered live. These transmissions do not allow time for editing.
- When Captions are being displayed, on-screen displays, such as volume and mute may be seen but may interfere with Closed Captions.
- Some cable systems and copy protection systems may interfere with the Closed Captioned signal.
- If using an indoor antenna or if TV reception is very poor, the Closed Caption Decoder may not appear or may appear with strange characters or misspelled words. In this case, adjust the antenna for better reception or use an outdoor antenna.

CC advanced

When you have selected Custom as the display method, you can adjust the various setting listed below as follows:

This feature is designed to customize Digital Captions only.

- 1 Select "Setup", then press ► or **ENTER**.
- 2 Press ▲ or ▼ to select "Closed Captions", then press ► or **ENTER**.
The Closed Caption menu will appear.
- 3 Press ◀ or ▶ to set "CC Display" to "On".
- 4 Press ▲ or ▼ to select "Digital CC Preset", then press ◀ or ▶ to select "Custom".
- 5 Press ▲ or ▼ to select "CC Advanced", then press ► or **ENTER**.
The CC Advanced menu will appear.
- 6 Press ▲ or ▼ to select the desired item, then press ◀ or ▶ to change the setting.

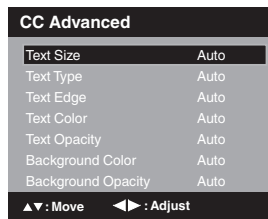

You can select from among the following items and parameters.

- Text Size:** Auto, Small, Standard, Large
- Text Type:** Auto, Style1, Style2, Style3, Style4, Style5, Style6, Style7
- Text Edge:** Auto, None, Raised, Depressed, Uniform, Left Shadow, Right Shadow
- Text Color:** Auto, Black, White, Red, Green, Blue, Yellow, Magenta, Cyan
- Text Opacity:** Auto, Solid, Transparent, Translucent, Flashing
- Background Color:** Auto, Black, White, Red, Green, Blue, Yellow, Magenta, Cyan
- Background Opacity:** Auto, Solid, Transparent, Translucent, Flashing

NOTE:

- You cannot set both "Text Color" and "Background Color" as a same color.
- You cannot set both "Text Opacity" and "Background Opacity" to "Transparent".

Aspect Switching

You can display the image at its optimum condition by selecting display aspect.

Selecting the picture format aspect ratio

- 1 Select "Video", then press ► or **ENTER**.
- 2 Press ▲ or ▼ to select "Aspect", then press ► or **ENTER** to display Aspect. Press ▲/▼ or corresponding **Number buttons (0-4)** to select the desired picture format aspect ratio, as described below.

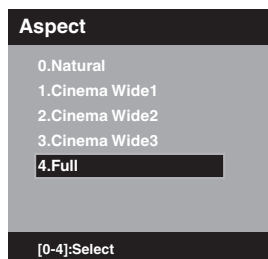

NOTE:

- Selectable picture format aspect ratios may vary depending on the input source or broadcast signal.
- Aspect menu also can be displayed by pressing **ASPECT** on the remote control.

Natural

In some cases, this image will display the size of standard 4:3 with a black side bar.

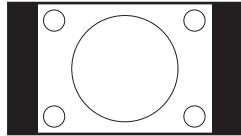

Cinema Wide1 (for 4:3 format programs)

To fill the screen, the right and left edges are extended. However, the center of the picture remains near its former ratio. The top and bottom edges of the picture may be hidden.

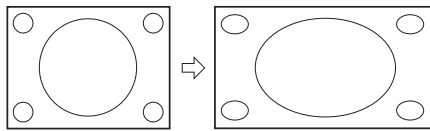

Cinema Wide2 (for letter box programs)

The entire picture is uniformly enlarged-it is stretched the same amount both wider and taller (retains its original proportion). The top and bottom edges of the picture may be hidden.

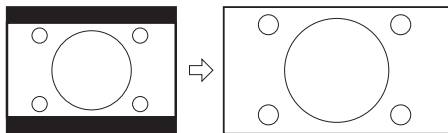

Cinema Wide3 (for letter box programs with subtitles)

To fill the width of the screen, it is extended horizontally. However, it is only slightly extended at the top and the bottom. The top and bottom edges of the picture may be hidden.

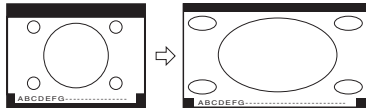

Full (for 16:9 source programs)

Full will display the picture at the maximum size.

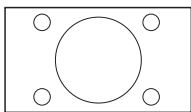

Native (for PC mode only)

Detects the resolution of the signal of the image and it will be shown on the screen with same amount of pixels.

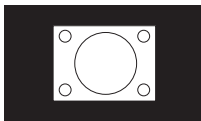

NOTE:

- Some High Definition and/or Digital broadcasts may not allow you to change the picture format aspect ratio.
- In HDMI or COMPONENT mode with a scanning rate of 720p, 1080i or 1080p (only HDMI), only the Cinema Wide2 and Full are available.
- In PC Mode, only the Natural, Full and Native are available. In PC Mode (WXGA), only the Full and Native are available.



Connections to other equipment

The exact arrangement you use to interconnect various video and audio components to this unit is dependent on the model and features of each component. Check the Owner's Manual provided with each component for the location of video and audio inputs and outputs.

To connect the LED TV to a VCR

Rear of the unit

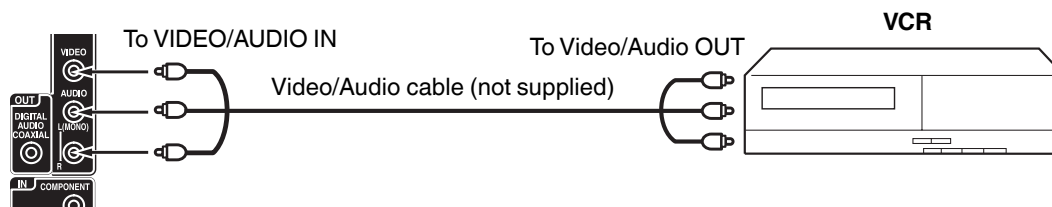

ENGLISH

To connect to a DVD player with Component Video Input

You can enjoy a high quality picture by connecting the unit's COMPONENT VIDEO OUT jacks of your DVD player with the COMPONENT video cables (not supplied).

Rear of the unit

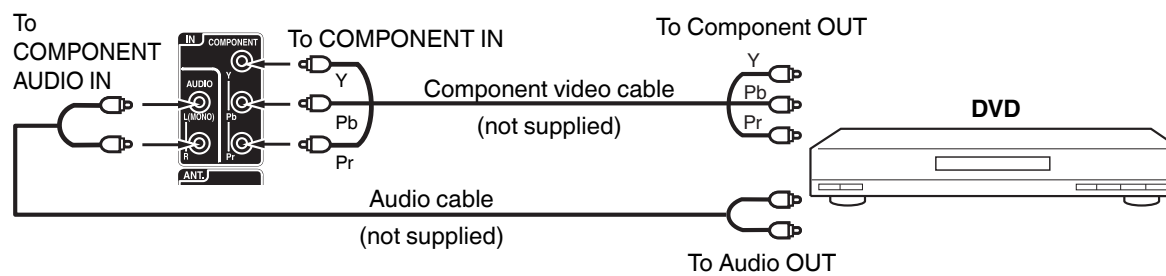

NOTE:

- Component Video input of the unit are for use with a device which output 480i/1080i interlaced signals and 480p/720p progressive signals.



Connections to other equipment

(continued)

To connect a HDMI or a DVI device to the unit

The HDMI input receives digital audio and uncompressed video from a HDMI device or uncompressed digital video from a DVI device. When you connect to a DVI device with a HDMI-to-DVI adapter cable, it transfers only video signal. Separate analog audio cables are required.

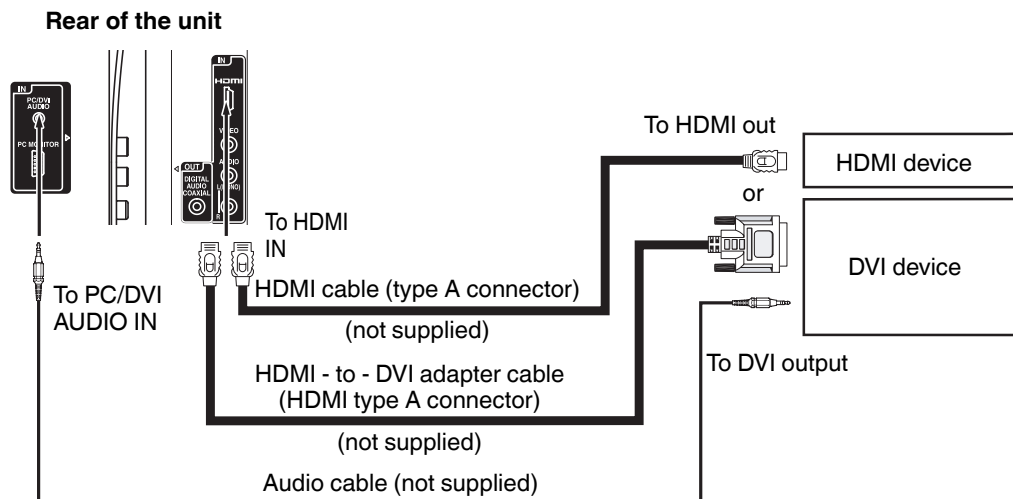

NOTE:

- When using HDMI to connect your HDMI or DVI devices, you must select the corresponding audio input source (HDMI or DVI) on the menu screen (see page 15). Otherwise you will only see the image with no sound.
 - If you connect an external component (cable box, satellite receiver, etc.) to this TV using an HDMI cable or a DVI to HDMI cable, the image will not display if the output resolution of the component is set to 480i. To receive the picture you must change the output resolution on the external component.
- Should you require further instruction, please contact the manufacturer of the external component.

Using an AV Amplifier with built-in digital surround

If you are using an Amplifier with built-in digital surround sound, you can enjoy various audio systems including Dolby Digital Surround audio that sounds just like the movie.

Connect an AV amplifier with built-in Dolby Digital decoder, DTS decoder, or MPEG decoder etc. as shown below.

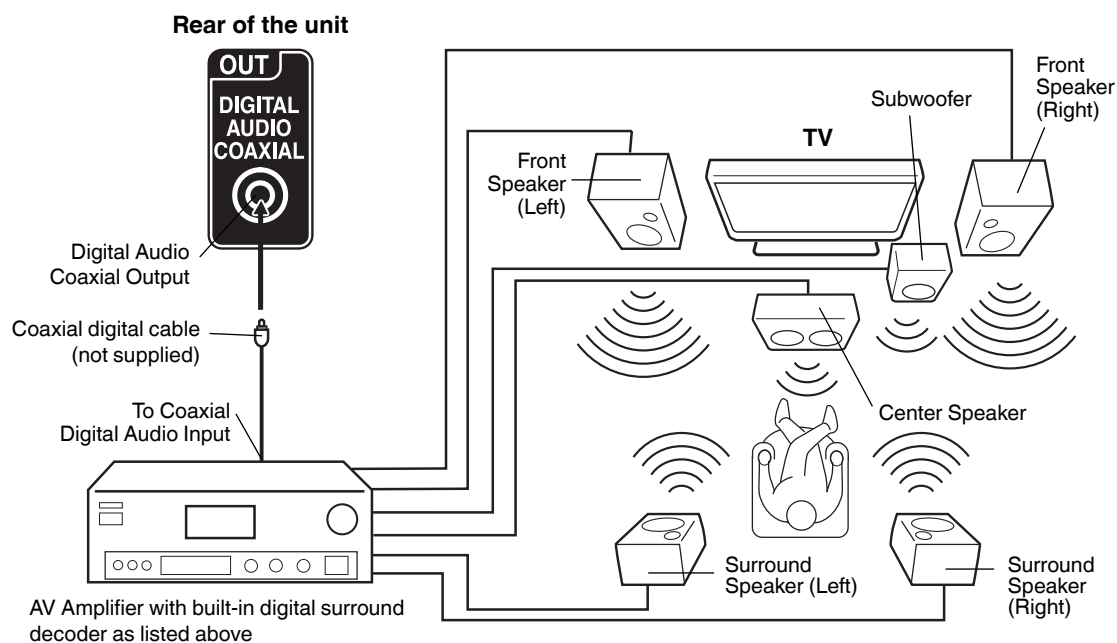

NOTE:

- When you are viewing digital broadcast, this unit will not work in conjunction with DTS audio or MPEG audio. There will be no sound output if connected to an AV amplifier with a built-in DTS decoder or MPEG decoder.

Connections to other equipment

(continued)

To connect the TV to a camcorder, or a TV Game

To play back from a camcorder, connect the camcorder to the unit as shown.

This unit can also be used as a display device for many video games. However, due to the wide variety of signals generated by these devices and subsequent hook-up variations required, they have not all been included in the suggested connection diagrams. You'll need to consult each component's Owner's Manual for additional information.

Rear of the unit

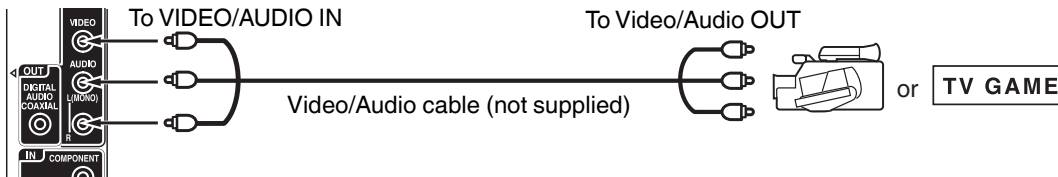

ENGLISH

To connect the TV to a PC (Personal Computer)

Before you connect this TV to your PC, change the adjustment of your PC's Resolution and Refresh rate (60 Hz).

Connect one end of a (male to male) VGA cable to the video card of the computer and the other end to the VGA connector PC MONITOR IN on the rear of the TV. Attach the connectors firmly with the screws on the plug. In case of a Multimedia computer, connect the audio cable to the audio output of your Multimedia computer and to the AUDIO connector of the PC/DVI AUDIO IN jack of the TV. You can also connect the PC with HDMI cable. If you use a HDMI cable, you don't have to connect the audio cable. If you use a DVI-to-HDMI cable, please connect the audio cable in the same way as the VGA cable.

Press **INPUT** on the remote control to select PC mode.

Switch on the computer. The TV can operate as the computer monitor.

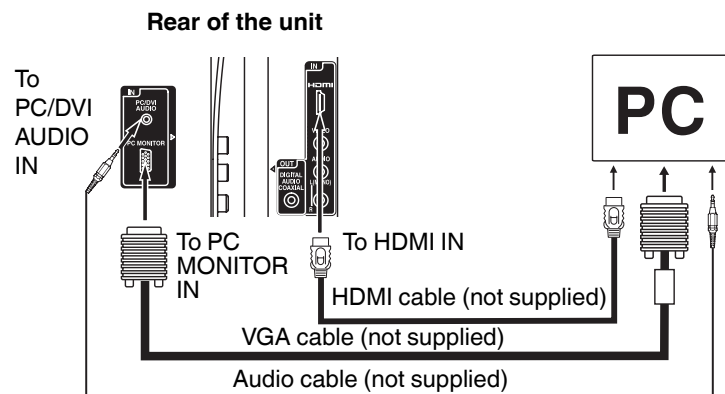

Monitor Display modes

MODE	Resolution	Refresh rate
VGA	640x480	60/ 72/ 75 Hz
VGA	720x400	70Hz
SVGA	800x600	56/ 60/ 72/ 75 Hz
XGA	1024x768	60/ 70/ 75 Hz
WXGA	1280x768	60Hz
WXGA	1280x720	60Hz
WXGA	1360x768	60Hz

To return to normal mode

Press **INPUT** again.

NOTE:

- The on-screen displays will have a different appearance in PC mode than in TV mode.
- If there is no video signal from the PC when the unit is in PC mode, "No signal" will appear on the TV screen.



Reception disturbances



IGNITION NOISE:

Black spots or horizontal streaks may appear, picture may flutter or drift. Usually caused by interference from automobile ignition systems, neon lamps, electrical drills, and other electrical appliances.



GHOSTS:

Ghosts are caused by the television signal following two paths. One is the direct path and the other is reflected from tall buildings, hills or some other objects. Changing the direction or position of the antenna may improve reception. Ghosting may also be caused by defects in the antenna system such as unshielded leads or connecting several sets to the same antenna without using multiple antenna couplers.



SNOW:

If your receiver is located in the fringe area of a television station where the signal is weak, your picture may be marred by the appearance of small dots. When the signal is extremely weak, it may be necessary to install a special antenna to improve the picture.



RADIO FREQUENCY INTERFERENCE:

The interference produces moving ripples or diagonal streaks, and in some cases, causes loss of contrast in the picture.

PREVENTION OF AN OBSTACLE TO RADIO RECEIVERS

This television has been designed pursuant to the FCC class B Rules. This is to prevent a problem to Radio receivers. If this television causes a problem to Radio receivers, then take the following steps:

- Keep the television away from Radio.
- Adjust Radio antennas in order for the television not to receive interference.
- The antenna cable of Radio should be kept away from the television.
- Use a coaxial cable for antenna.

You can check if this television influences Radio receivers by turning off all other equipment other than the television. If you find a problem receiving Radio when using the television, check the instructions mentioned above.



BLOCK NOISE or FREEZE (DIGITAL INPUT):

Fuzzy blocks may appear in some area or the whole area of the screen. This is usually caused by interference from automobile ignition systems, neon lamps, electrical drills, ghosting of the image and lost or weak receiving signals.

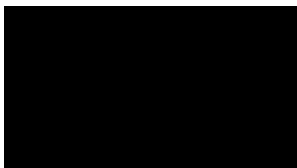

BLACK SCREEN:

When using an antenna, weak signals will display a black screen. It may be necessary to upgrade your antenna.

NOTE:

- The TV set can generate sound distortion in external devices such as a radio. Please separate radio equipment from the TV set to a considerable distance.



Troubleshooting

Use the following checklist for troubleshooting if you have problems with your LED TV. Consult your local dealer or service outlet if problems persist. Be sure all connections are properly made when using with other units.

SYMPTOMS	POSSIBLE SOLUTIONS
TV does not operate.	<ul style="list-style-type: none"> • Make sure the power cord is plugged in. • Try another AC outlet. • Power is off, check fuse or circuit breaker. • Unplug unit for an hour, then plug it back in.
Poor sound or no sound.	<ul style="list-style-type: none"> • Station or Cable TV experiencing problems, tune to another station. • Check sound adjustments (Volume and Mute). • Check for sources of possible interference.
Poor picture or no picture.	<ul style="list-style-type: none"> • Station or Cable TV experiencing problems, tune to another station. • Make sure channels are set into memory. • Check antenna or Cable TV connections, adjust antenna. • Check for sources of possible interference. • Check picture control adjustments.
Poor reception on some channels.	<ul style="list-style-type: none"> • Station or Cable TV experiencing problems, tune to another station. • Make sure channels are set into memory. • Station is weak, adjust antenna to receive desired station. • Check for sources of possible interference.
Poor color or no color.	<ul style="list-style-type: none"> • Station or Cable TV experiencing problems, tune to another station. • Make sure channels are set into memory. • Check picture control adjustments. • Check antenna or Cable TV connections, adjust antenna. • Check for sources of possible interference.
Picture wobbles or drifts.	<ul style="list-style-type: none"> • Station or Cable TV experiencing problems, tune to another station. • Make sure channels are set into memory. • Cable TV company is scrambling signal. • Adjust antenna.

SYMPTOMS	POSSIBLE SOLUTIONS
Digital broadcasting screen problem.	<ul style="list-style-type: none"> • Check digital signal strength.
No CATV reception.	<ul style="list-style-type: none"> • Check all Cable TV connections. • Set Air/Cable menu option to the Cable mode. • Station or Cable TV system problems, try another station.
Horizontal or diagonal bars on screen.	<ul style="list-style-type: none"> • Check antenna connections, adjust or re-direct antenna. • Check for sources of possible interference.
No reception above channel 13.	<ul style="list-style-type: none"> • Make sure Signal Type option is in the appropriate mode. • If using antenna, check UHF antenna connections.
No Remote operation.	<ul style="list-style-type: none"> • Batteries are weak, dead or inserted incorrectly. • Remote is out of range, move closer to TV (within 15 feet). • Make sure Remote is aimed at sensor. • Confirm there are no obstructions between the Remote and the TV. • Make sure the power cord is plugged in.
TV shuts off.	<ul style="list-style-type: none"> • Sleep Timer is set. • Power interrupted.
Closed - Caption is not activated.	<ul style="list-style-type: none"> • TV station experiencing problems or program tuned is not closed captioned. Try another channel. • Check Cable TV connection or VHF/UHF antenna, reposition or rotate antenna. • Set closed caption decoder in the menu.
TV is not shown in your language.	<ul style="list-style-type: none"> • Select proper language in the menu options.

ENGLISH

FOR CUSTOMER SERVICE, ADDITIONAL SET-UP AND OPERATING ASSISTANCE, OR TO ORDER ACCESSORIES PLEASE CALL:

1-800-289-0981

WHEN CALLING CUSTOMER SERVICE – PLEASE HAVE YOUR MODEL NUMBER READY

OR WRITE TO:
ORION SALES, INC.
 3471 N. UNION DR.
 OLNEY, ILLINOIS 62450

Specifications

GENERAL	
Power supply	AC 120V 60Hz
Power consumption	Operation: 20W Stand by: 0.3W
Weight	2.6 kg (5.7 lbs)
Dimensions	Width: 467 mm (18-3/8 inches) Height: 346 mm (13-5/8 inches) Depth: 143 mm (5-5/8 inches)
Operating temperature	5°C - 40°C
Operating humidity	Less than 80%
TELEVISION	
Type	47.0 cm (19" class/18.5" diagonal)
Display method	Transmission TFT color LED panel
Number of Pixels	1366 (H) x 768 (V)
Broadcasting system	US system M ATSC standard (8VSB), QAM
Receiving channels	VHF 2-13 UHF 14-69 CATV 14-36 (A)-(W) 37-59 (AA)-(WW) 60-85 (AAA)-(ZZZ) 86-94 (86)-(94) 95-99 (A-5)-(A-1) 100-135 (100)-(135) 01 (4A)
Tuner type	Frequency synthesized
Inputs	Video: 1.0 V p-p/75 ohms Audio: -8 dBm/50k ohms Component video: (Y) 1.0 V (p-p), 75 ohms (Pb)/(Pr) 0.7 V (p-p), 75 ohms HDMI: HDMI compliant (type A connector) HDCP compliant E-EDID compliant Suggested scan rates: 1080p, 1080i, 480p, 480i, 720p HDMI Audio: 2-channel PCM 32/44.1/48 kHz sampling frequency 16/20/24 bits per sample PC Monitor: Mini-Dsub 15pin x 1 Antenna: VHF/UHF In 75 ohms coaxial
Output	Digital audio: 0.5 Vp-p 75 ohms terminated
Speaker	25.4 mm x 68.6 mm (1 inches x 2-11/16 inches), 8 ohms x 2
Audio output power	1.5W + 1.5W
ACCESSORIES	
	Remote control/Batteries (AA) x 2/AC Cord/Clamp/Clamp Screw/Stand/Stand Screw x 2

- Designs and specifications are subject to change without notice.
- For information on our other products, please visit our website at www.hitachi.us



HITACHI

LIMITED WARRANTY

19" LED HDTV

ORION warrants this product to be free from manufacturing defects in material and workmanship under normal use and conditions for a period of 1 year from date of original purchase in the United States.

Should service be necessary under this warranty for any reason due to a manufacturing defect or malfunction during the first 12 months from date of original purchase, ORION will provide carry-in service only by an ORION authorized Independent Service Center at no charge. Also, if an original part fails due to manufacturing defect in material and workmanship within one year from date of original purchase we will replace the defective part, provided the defect or malfunction is verified along with dated proof of purchase.

There are ORION authorized Independent Service Centers located throughout the country. For the one nearest you, DIAL TOLL FREE: 1-800-289-0981. ORION will not be liable for damages incurred in shipment of the unit. If there are no ORION authorized Independent Service Centers in your area please call - 1-800-289-0981 for assistance.

Note: This warranty is void if the product is:

- (a) Damaged through negligence, misuse, abuse, or accident.
- (b) Used in a commercial application or rentals.
- (c) Modified or repaired by anyone other than an Independent Service Center authorized by ORION to effect warranty repairs to the class of product or by the ORION Factory Service Center.
- (d) Damaged because it is improperly connected to the equipment of other manufacturers.

This warranty does not cover:

- (a) Damage to equipment not properly connected to the product.
- (b) Costs incurred in the shipping of the product to an ORION authorized Independent Service Center or ORION Factory Service Center.
- (c) Damage or improper operation of unit caused by customer abuse, misuse, negligence, or failure to follow operating instructions provided with the product.
- (d) Ordinary adjustments to the product which can be performed by customer as outlined in the owner's manual.
- (e) Signal reception problems caused by external antenna or cable systems.

THIS WARRANTY IS NON TRANSFERABLE AND APPLIES ONLY TO THE ORIGINAL PURCHASER AND DOES NOT EXTEND TO SUBSEQUENT OWNERS OF THE PRODUCT. ANY APPLICABLE IMPLIED WARRANTIES, INCLUDING THE WARRANTY OF MERCHANTABILITY, ARE LIMITED IN DURATION TO A PERIOD OF THE EXPRESS WARRANTY AS PROVIDED HEREIN BEGINNING WITH THE DATE OF ORIGINAL PURCHASE AT RETAIL AND NO WARRANTIES, WHETHER EXPRESS OR IMPLIED SHALL APPLY TO THIS PRODUCT THEREAFTER. ORION MAKES NO WARRANTY AS TO THE FITNESS OF THE PRODUCT FOR ANY PARTICULAR PURPOSE AND USE.

UNDER NO CIRCUMSTANCES SHALL ORION BE LIABLE FOR ANY LOSS, DIRECT, INDIRECT, INCIDENTAL, SPECIAL, OR CONSEQUENTIAL DAMAGE ARISING OUT OF OR IN CONNECTION WITH THE USE OF THIS PRODUCT.

THIS WARRANTY IS VALID ONLY IN THE UNITED STATES OF AMERICA. THIS WARRANTY GIVES YOU SPECIFIC LEGAL RIGHTS, HOWEVER, YOU MAY HAVE OTHER RIGHTS WHICH MAY VARY FROM STATE TO STATE. SOME STATES DO NOT ALLOW LIMITATION ON IMPLIED WARRANTIES OR EXCLUSION OF CONSEQUENTIAL DAMAGE, THEREFORE THESE RESTRICTIONS MAY NOT APPLY TO YOU.

ORION SALES, INC.
3471 N. UNION DR.
OLNEY, ILLINOIS 62450

ENGLISH

