

IBM

Operating  
Instructions

IBM  
Correcting  
Selectric®  
Typewriter



IBM  
Selectric® II  
Typewriter

Refer to this photograph while reading the Operating Instructions to help you locate the individual features of your IBM Correcting "Selectric" Typewriter and IBM "Selectric" II Typewriter.

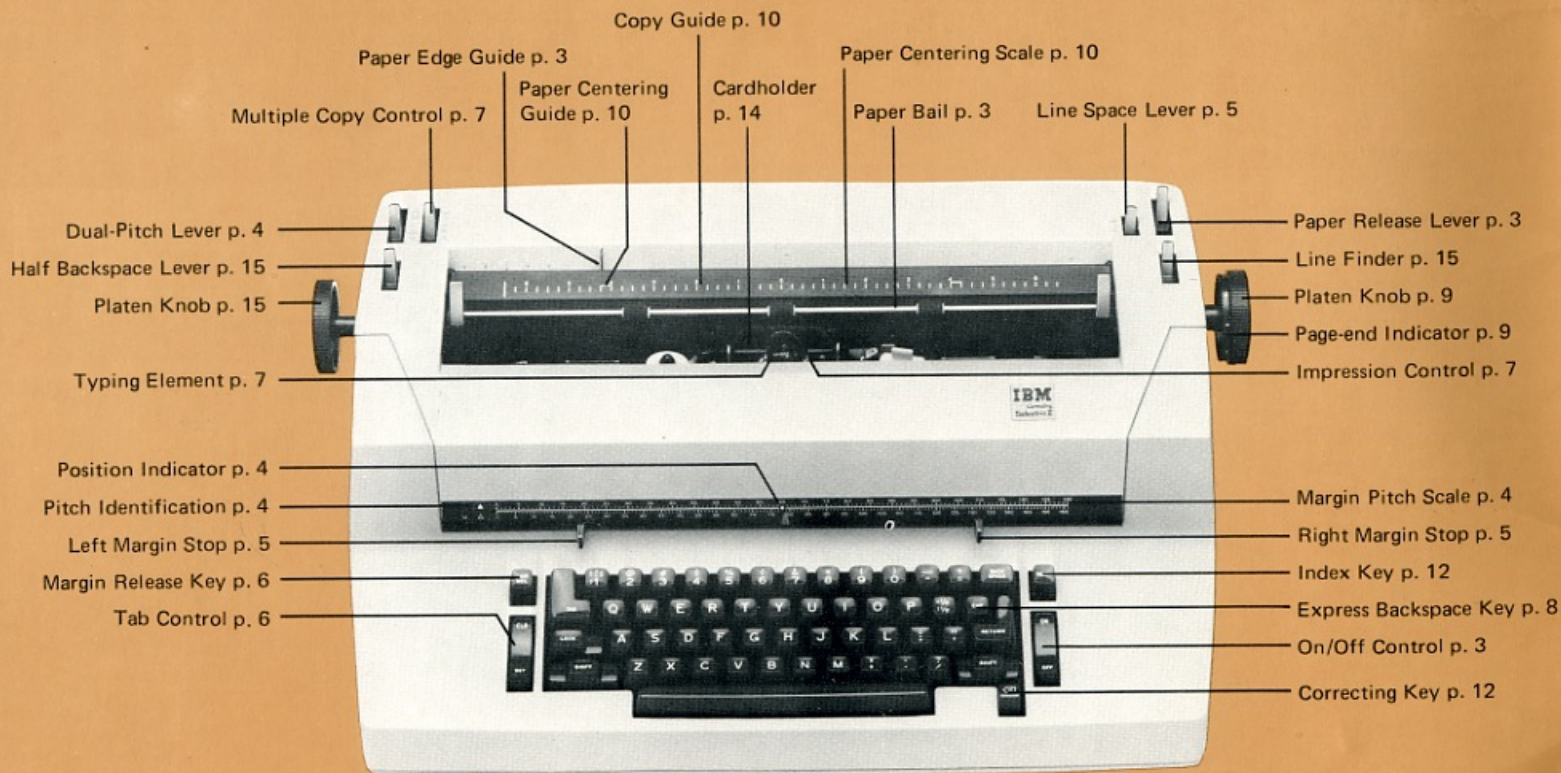

## Contents

<b>Preface</b>	2	<b>Making Corrections</b>	12	<b>IBM Supplies</b>	
		Cardholder	14	IBM Correctable Film Ribbon	20
<b>Preparation</b>		Platen Variable	15	IBM Lift-off Tape	20
On/Off Control	3	Line Finder	15	IBM Tech III Ribbon	20
To Insert the Paper	3	Half Backspace Lever	15	IBM Tech III Cover-up Tape	20
Paper Release	3			IBM Carbon Film Ribbon	21
Margin/Pitch Scale	4	<b>Care and Maintenance</b>		IBM Fabric Ribbon	21
Dual-Pitch Model Typewriter	4	Ribbon Systems	16	Carbon Papers	21
Margin/Dual-Pitch Scale	4	Selective Ribbon System	16	Typing Elements	22
Line Space Lever	5	To Remove a Ribbon	16	Suggested Element Sets	22
To Set the Margins	5	To Install a New Ribbon	16	Application Rating	23
Margin Release Key	6	Fabric Ribbon Mechanism	17		
To Set and Clear Tabs	6	To Remove a Fabric Ribbon	17	<b>Additional Optional Features</b>	
Multiple Copy Control	7	To Install a Fabric Ribbon	17	Velocity Control Dial	24
Impression Control	7	Ribbon Reverse Lever	17	Dead Key (Optional Feature)	24
Changing Typing Elements	7	Changing the Correcting Tape	18	Dead Key Disconnect (Optional Feature)	24
Shift Keys and Shift Lock	8	To Remove the Tape	18	Sound Reduction Option	25
Express Backspace Key	8	To Install New Tape	18		
Page-end Indicator	9	Cleaning the Typing Element	19		
Centering the Paper	10	Serial Number	19		
		IBM Maintenance Agreement	19		
<b>As You Type</b>		Checklist for Proper Typewriter Operation	19		
To Type Stencils	11				
Typamatic Keys	12				
Multiple Character Keys	12				

## Preface

With the introduction of the IBM Correcting "Selectric" Typewriter, typing errors, erasures, strikeouts, and messy corrections are now a thing of the past. Typing mistakes on originals can be corrected as easy as 1-2-3. The IBM Correctable Film Ribbon and IBM Lift-off Tape system allows you to lift incorrectly typed characters clean off the page. The IBM Correcting "Selectric" Typewriter also allows you to use the IBM Tech III Ribbon with the IBM Tech III Cover-up Tape for certain applications.

In addition, both the IBM Correcting "Selectric" Typewriter and the IBM "Selectric" II Typewriter utilize Single Element Typing technology. Simply stated, a small, spherical-shaped typing element skims across the paper impressing characters with greater speed and accuracy. Because there is no moving typewriter carriage, you have an unbroken line of sight in your immediate work area .

The following are available on both the IBM Correcting "Selectric" Typewriter and "Selectric" II Typewriter:

**Dual-Pitch Model** — choose a 10-pitch or 12-pitch typestyle to suit each application.

**Interchangeable Typing Elements** — a choice of over 20 available for every typing need.

**Half Backspace Lever** (dual-pitch models only) — ideal for creating ligatures or correcting already typed copy.

**Sound Reduction Option** — the perfect choice in sound-sensitive working areas.

**Express Backspace Key** — a major convenience factor when underscoring or rapidly backspacing.

**Impression Control** — easy to use and adjust to suit each typing application.

The following easy-to-follow instructions and illustrations provide a quick, convenient way to help you realize the full benefits of your new IBM typewriter.

## Preparation



### On/Off Control

To turn the typewriter on, press the top part of the Control (ON).

As a reminder to you, the red portion of the Control shows that the machine is on.

**WARNING:** Keep hair, fingers, and personal objects (such as bracelets, necklaces, neckties, etc.) out of the printing and ribbon area when the machine is on.

In order to prevent long hair, fingers, and personal articles from getting caught on the rotating shaft in the machine, you should comply with this warning and insure that other persons do also.

If the typing unit has a plastic accordion-like shield over the shaft, it should not be removed.

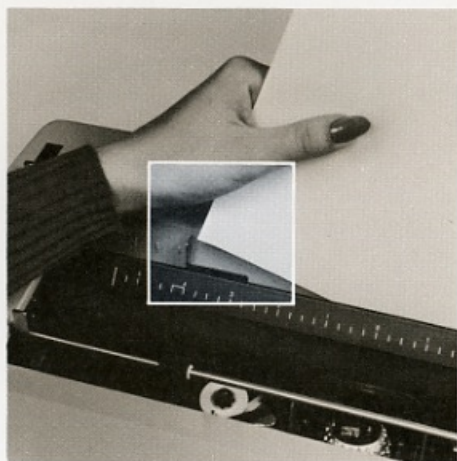

### To Insert the Paper:

Align the paper against the Paper Edge Guide.

Pull the Paper Bail forward. Press the Index Key to roll the paper into the typewriter.

**Note:** If you have the Sound Reduction Option, see page 25.

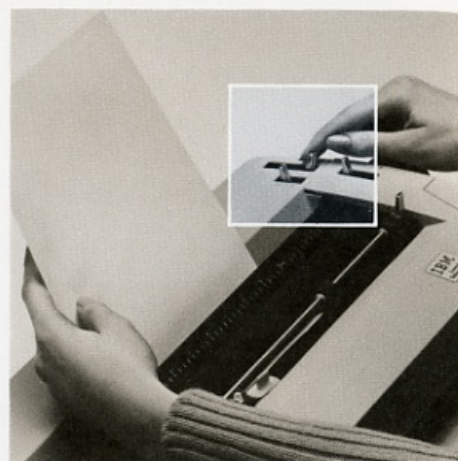

### Paper Release

To reposition the paper after it is inserted in the typewriter, move the Paper Release Lever forward.

Push this Lever back after the paper is in the desired position.

Use this feature when inserting a thick carbon pack and when removing paper from the typewriter.



#### Margin/Pitch Scale

The Margin/Pitch Scale is located directly above the keyboard. The 10 or 12 at the left of the Scale indicates the pitch\* of your typewriter; that is, the number of characters per inch. The Scale is numbered every five spaces from left to right.

A red pointer moves along the Scale with the Carrier indicating the position of the typing Element. It gives the typing position of the next character on your paper.

On top of the Element is a 10 or 12, indicating pitch. Use an Element with a 10 for a 10-pitch typewriter; 12 for a 12-pitch.

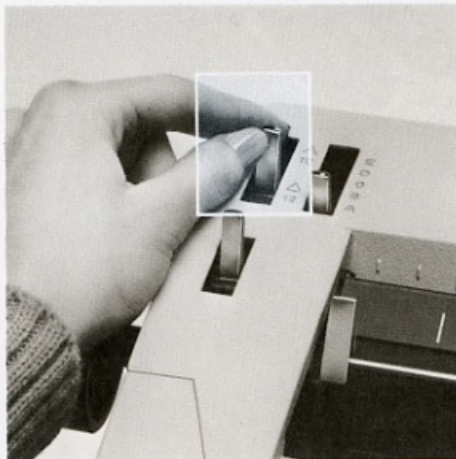

#### Dual-Pitch Model Typewriter

Your typewriter may be a dual-pitch model which is designed to allow typing in either 10 or 12-pitch.\*

For 12-pitch typing, move the Dual-pitch Lever toward you. To type 10-pitch copy, push the Lever away from you.



#### Margin/Dual-Pitch Scale

(Dual-Pitch Models Only)

Dual-pitch typewriters have both 10- and 12-pitch Scales. The top Scale is the 10-pitch Scale; the bottom, 12-pitch.

The typing Elements have a 10 or a 12, indicating pitch. Use an Element with a 10 when typing in 10-pitch. Use an Element with a 12 when typing in 12-pitch.

\*10-pitch type (pica):  
10 characters per inch  
12-pitch type (elite):  
12 characters per inch

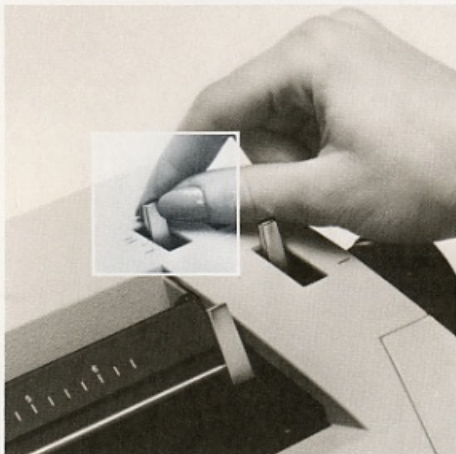

### Line Space Lever

#### To Select Single or Double Spacing:

Move the Line Space Lever toward you for single spacing; away from you for double.

#### Single, Space-and-a-Half, or Double Spacing (Optional Feature).

Move the Line Space Lever toward you for single spacing, to the middle mark for space-and-a-half spacing, and away from you for double.

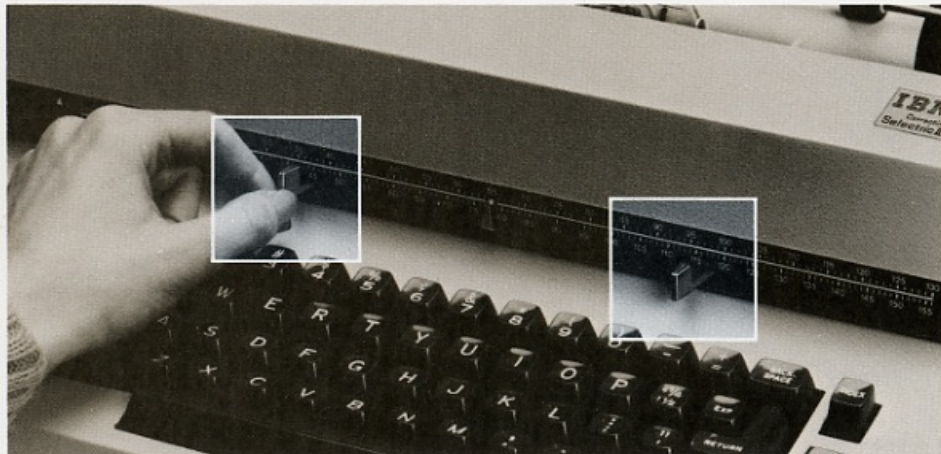

### To Set the Margins:

Push in and slide the Margin Stops to the new margin settings.

The left Margin Stop cannot be moved past the red pointer. Space the pointer out of the way before moving the Margin Stop.

The right Margin Stop prevents you from typing past the right margin; however, you can space or tab through it. To type past the right margin, press the Margin Release Key and continue typing (See p.6).

When using a dual-pitch typewriter, set your left margin at a numbered marking on the 10-pitch Scale if you plan to change pitch in the same document.



### Margin Release Key

To temporarily release the left margin, return the Carrier to the left margin, press the Margin Release Key, and backspace through the margin. To type through the right margin, after the keyboard has locked, press the Margin Release Key and continue typing.

### To Set and Clear Tabs:

Use the Tab Control to set and clear tabs. To set a tab, move the Carrier to the place where you want to set a tab. Then press SET.

To clear a tab, tab the Carrier to the stop you want to clear. Then press CLR.

To clear *all* tabs at once, tab the Carrier all the way to the right, then press and hold CLR as you press the Carrier Return or the Express Backspace Key.

When using a Dual-pitch typewriter, set your tabs at a numbered marking on the 10-pitch Scale if you plan to change pitch in the copy but want the same tab positions for both pitches.

On a Dual-pitch Typewriter, the Carrier should be at least two spaces to the left of a set tab stop in order to tab to that position. On single pitch typewriters, the requirement is one space or more.

### Time Savers

A partial carrier return can be used to type tabulated materials, such as columns of figures or addresses on envelopes. Set tab stops first. Then tap the Carrier Return followed by the Tab Key as soon as the Carrier passes the tab stop.

Typing forms is faster when you set tab stops at the points on the form where most of the typing begins. Use the partial Carrier Return to go directly to a predetermined point on the page; that is, tap the Carrier Return followed by the Tab Key as soon as the Carrier passes the tab stop.



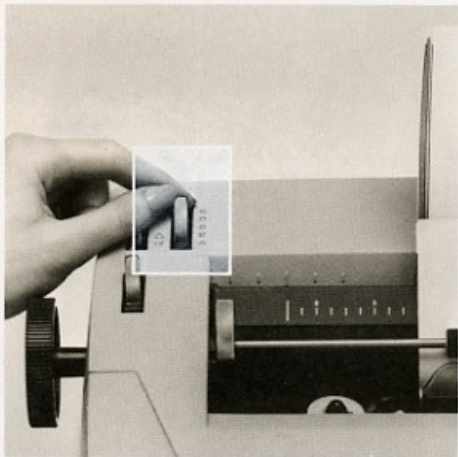

### Multiple Copy Control

The Multiple Copy Control adjusts the position of the Platen to compensate for the varying thicknesses of typing material.

Keep the control at "A" for normal typing requirements.

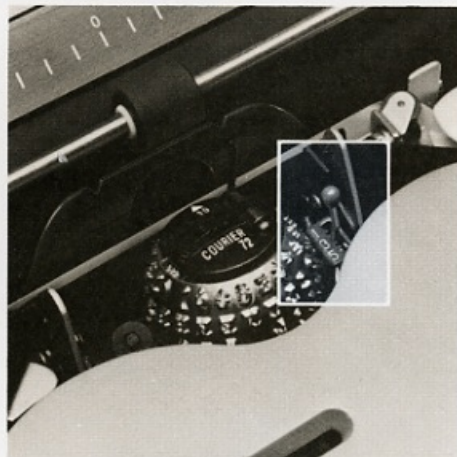

### Impression Control

The Impression Control enables you to adjust the striking force of the Element. For most jobs, set the Control on three.

Multiple carbon packs and stencils generally require greater striking force for good quality, so you may want to move the Impression Control to a higher number. Offset Masters generally require less force, so you may want to move the Control to a lower number. Be careful to move the Control to the right before changing position.



### Changing Typing Elements

Select the most appropriate style of type for each typing job. You can change the typing Element on your typewriter in seconds. Care should be taken not to drop the typing Element.

#### To Remove an Element:

- Touch the Shift Key to be sure it is not locked.
- Lift the lever on top of the Element until it clicks to the open position.
- Use the lever to lift the Element *straight up* off the Element Post.

#### To Put on an Element:

- Touch the Shift Key to be sure it is not locked.
- Open the lever on top of the Element until you hear it click.
- Holding the Element by the lever, place the Element on the post, pointing the triangle toward the Platen.
- Close the lever until it clicks in place.

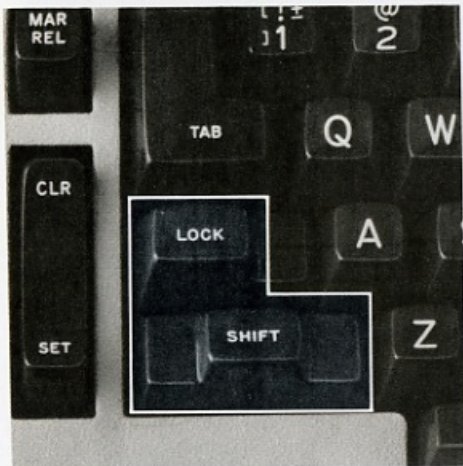

#### Shift Keys and Shift Lock

To type capital and other uppercase characters press either the left or right Shift Key.

To lock the Shift Key for continuous use, press Lock.

To unlock the Shift Key, press the left or right Shift Key.

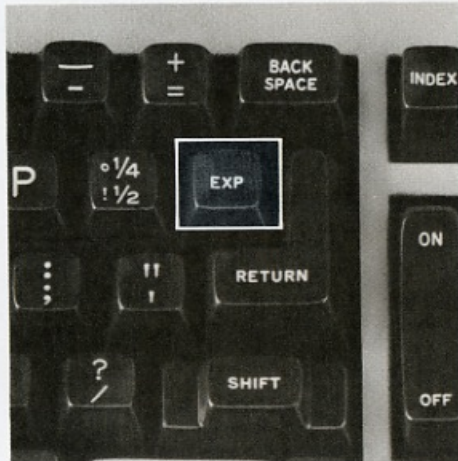

#### Express Backspace Key

Use this key to move rapidly backward on the same typing line for underscoring or repositioning the Carrier. With each depression of this key, the Carrier moves back, until it reaches the left Margin Stop.

## As You Type

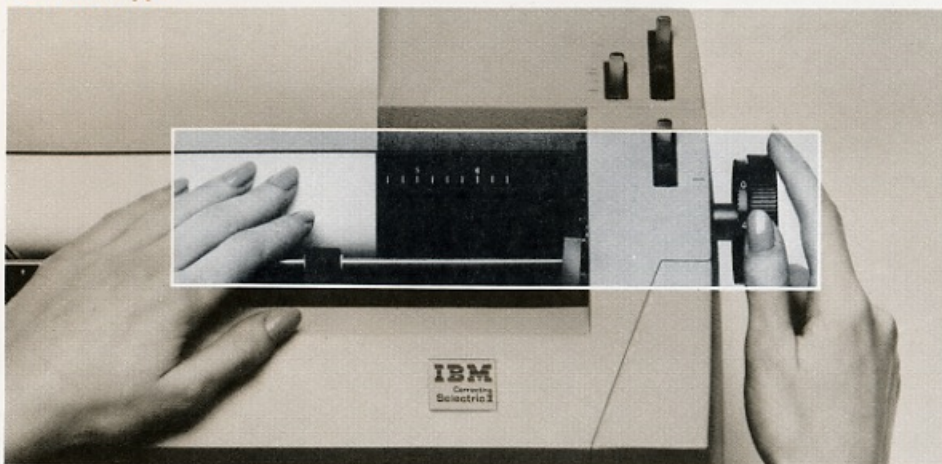

### Page-end Indicator

The Page-end Indicator shows the number of inches remaining to the bottom of the page.

- Align the paper with the top edge of the Copy Guide.
- Find the Indicator Setting opposite your paper length on the Reference Chart on this page.
- Rotate the Page-end Indicator until the correct setting is at the small horizontal mark to the left of the Platen Knob.

When the typing line is 4 inches or less from the bottom, the Indicator shows the actual inches to the bottom of the page.

Ready Reference for Page-End Indicator Settings  
(for paper 3" to 14" long)

Length of Paper (inches)	Indicator Setting
3"	1
3½"	1½
4"	2
4½"	2½
5"	3
5½"	3½
6"	4
6½"	0
7"	½
7½"	1
8"	1½
8½"	2
9"	2½
9½"	3
10"	3½
10½"	4
11" Standard Size	0
11½"	½
12"	1
12½"	1½
13"	2
13½"	2½
14"	3

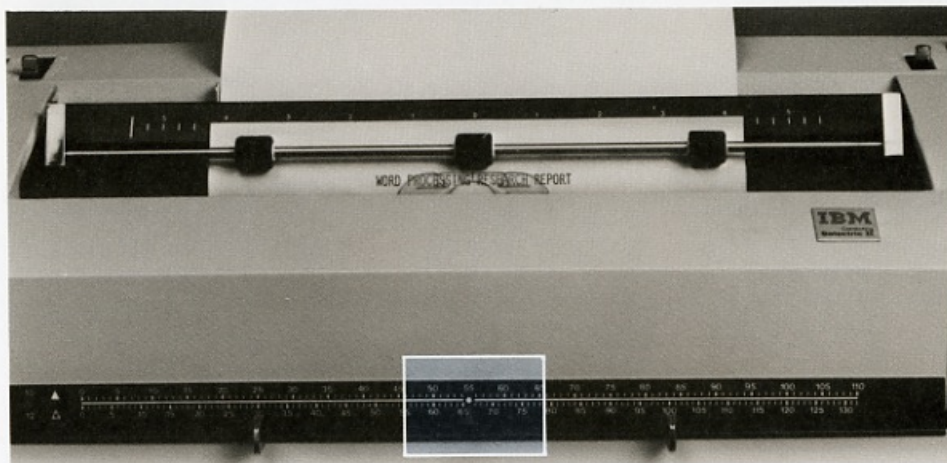

### Centering the Paper

To center paper  $8\frac{1}{2}$  inches wide, move the Paper Guide to the outer edge of the  $\boxed{4}$  on the Paper Centering Scale.

To center any width paper, insert the paper so that its left and right edges touch the same number on the Scale; for example, for eleven-inch wide paper both edges touch  $5\frac{1}{2}$ .

When paper is centered in the typewriter, the centered dot on the Margin/Pitch Scale or Margin/Dual-pitch Scale will be the center of the page.

### To Center: Horizontally

When the paper is centered in the typewriter, move the Carrier to the center dot on the Margin/Pitch Scale. Then, backspace once for every two characters to be centered. Type the material.

### Vertically

Normal typewriter spacing provides six vertical line spaces per inch, or 66 lines per standard page (eleven inches long).

Use the Page-end Indicator (see page 9) to gauge the bottom margin.

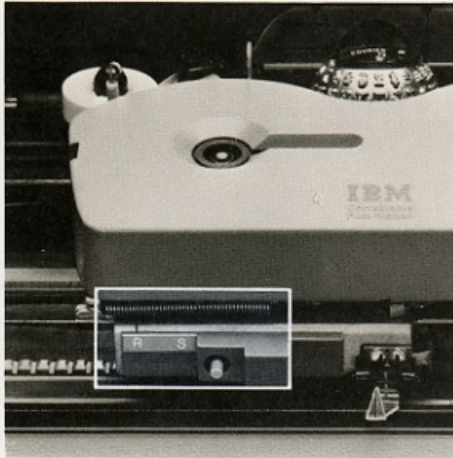

### To Type Stencils:

#### Selective Ribbon System

To type stencils, move the Ribbon/Stencil Control to the left so the "S" lines up under the mark and locks into position.

To return to regular typing, push the button on the Control. This automatically moves the Control to printing position.

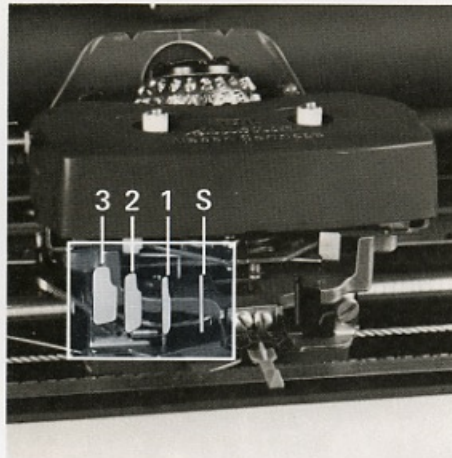

#### Fabric Ribbon Typewriter

To type stencils, move the Ribbon/Stencil Control to position "S".

For regular typing, set the Control on "1", "2", or "3" to type on the top, middle, or bottom portion of the ribbon. Change the position frequently to allow the ribbon to re-ink itself for longer life.

For red/black ribbons, set the Control at position "1" to type in black and at position "3" to type in red.



### Typamatic Keys

Typamatic keys have a repeat action when held down. Any of the six typamatic keys can be touched lightly for single action or held down for repeat action.

- Backspace Key
- Spacebar
- Hyphen/Underscore Key
- Return Key
- Index Key\*
- Correcting Key (Available on the IBM Correcting "Selectric" Typewriter only.)

\*The Index Key is used to space vertically without the Carrier returning to the left margin.

### Multiple Character Keys

On your typewriter there are two keys which show two or more sets of characters—Multiple Character Keys. However, only one pair of characters shown on each key is on any one Element. When you change Elements, be sure to check which of these sets of characters is on that particular Element.

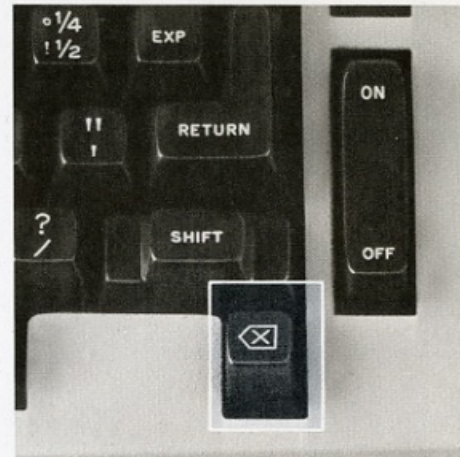

### Making Corrections

The IBM Correcting "Selectric" Typewriter with either the IBM Correctable Film Ribbon with IBM Lift-off Tape or the IBM Tech III Ribbon with IBM Tech III Cover-up Tape\* makes erasures, strikeouts, and messy corrections on originals a thing of the past. During the correcting cycle the typing element stays "in place" after the incorrect character is deleted. The correct character can be typed immediately without wasted motion. (It is necessary to match the appropriate tape and ribbon. Therefore, they are color coded for your convenience.)

\*When typing offset masters do not use:  
 1) the IBM Correctable Film Ribbon, or  
 2) the Correcting Key when using the IBM Tech III Ribbon.

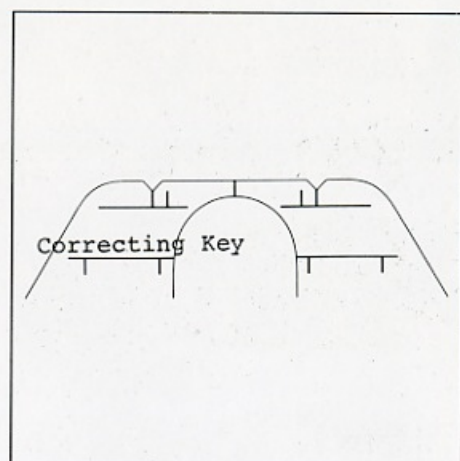
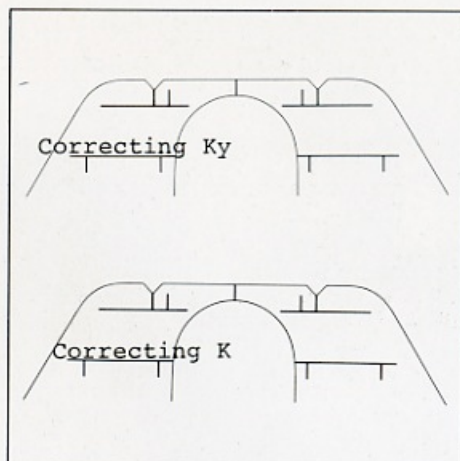
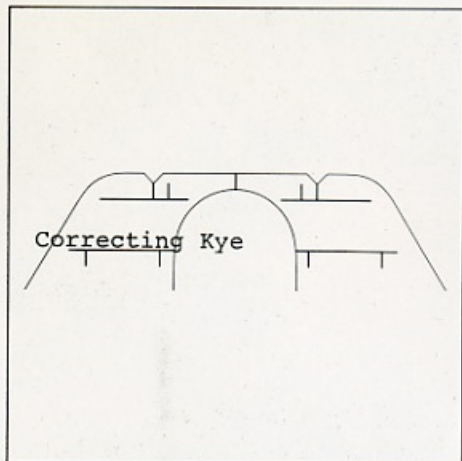

#### To Make a Correction:

- Press the Correcting Key to backspace to the last incorrectly typed character.

**Note:** The Correcting Key is typamatic (repeat), so you can quickly backspace to correct any character toward the beginning of the line.

- Restrike the last incorrectly typed character to delete it from the paper.\*
- Backspace with the Correcting Key to the next incorrect character and restrike it to delete it from the paper. Repeat until all incorrect characters are deleted.

If you are typing carbon copies, correct them in the usual way after deleting the character(s) from the original.

\*If you space after backspacing with the Correcting Key, the correcting process is deactivated.

- Type the correct character (s).

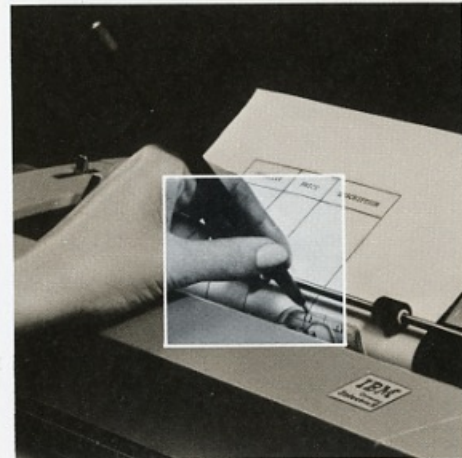
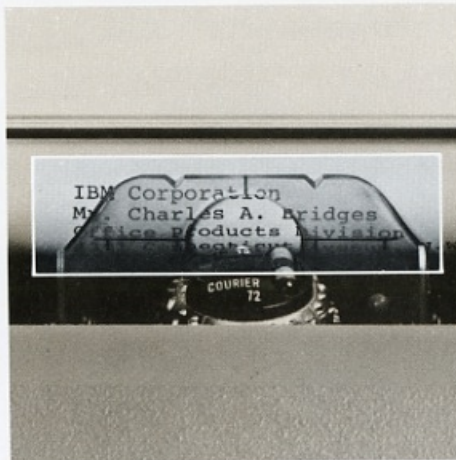
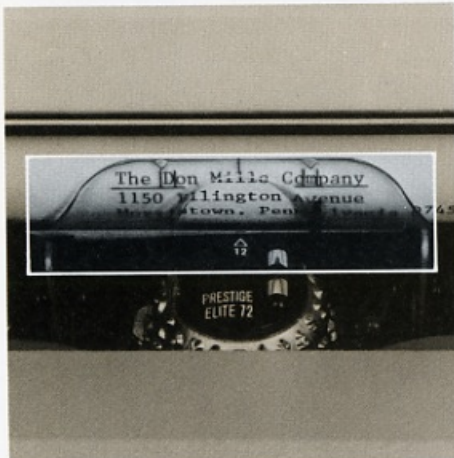

### Cardholder

The Cardholder holds paper, cards, and envelopes close to the Platen.

### IBM Correcting "Selectric" Typewriter

To realign characters for a correction, use the markings on the Cardholder as a guide. First, position the characters in the small vertical lines at the top of the Cardholder. Then, roll the paper down to the horizontal line toward the bottom of the Cardholder. This line indicates the base of the typing line. Position your paper so the bottom of each character rests just above the line as illustrated.

The red vertical line at the top center of the Cardholder indicates the position of the next character to be typed.

### IBM "Selectric" II Typewriter

To realign characters for a correction, position an "i" or an "l" directly under the vertical line at the top of the Cardholder. Then, roll the paper down to the horizontal line toward the bottom of the Cardholder. This line indicates the base of the typing line. Position your paper so the bottom of each character rests just above the line as illustrated.

The red vertical line at the top center of the Cardholder indicates the position of the next character to be typed.

### Drawing Lines

Another feature of the Cardholder is the capability for drawing lines.

Use one of the notches on the Cardholder to draw vertical lines by rolling the Platen manually. (Pull forward on the Line Finder Lever to achieve a free rolling motion. Remember to return the Lever to its home position for normal line spacing.)



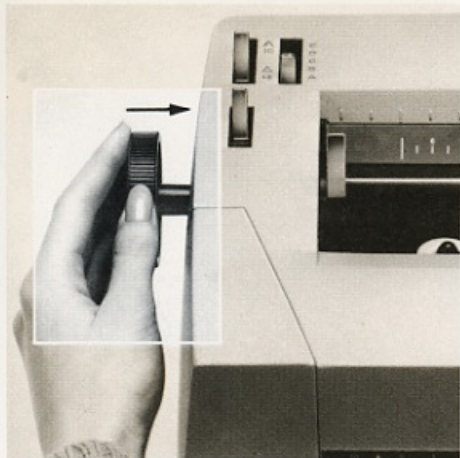

#### Platen Variable

Press in against the left Platen Knob to permanently change the position of the writing line or to realign a page for corrections or additions.

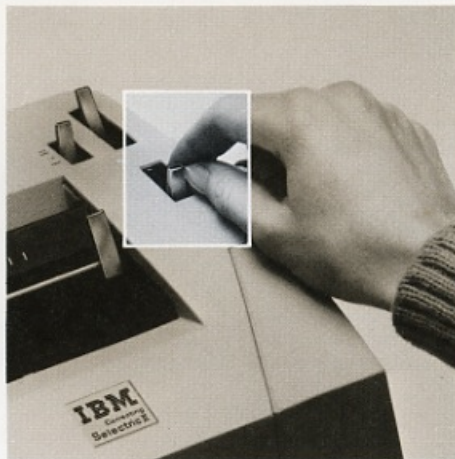

#### Line Finder

The Line Finder allows you to temporarily leave the original typing line to type a superscript, subscript, double underscore, form with irregular spacing, etc., or to draw lines.

- Pull the Line Finder Lever toward you.
- Turn the Platen Knob to move to the temporary typing line and type.
- Push the Lever away from you. The Platen can then be rolled back to the original typing line.

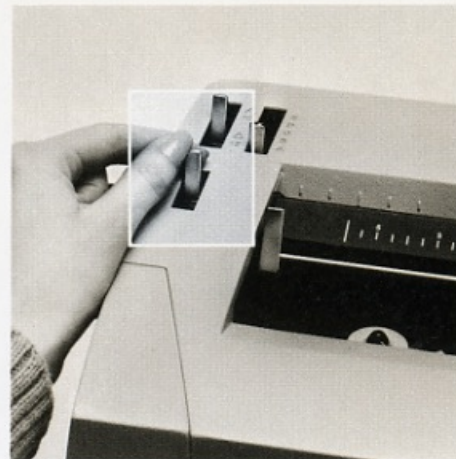

#### Half-Backspace Lever

(Dual-Pitch Models only)

Use this Lever to justify copy, insert a character, or create a ligature (example: æ ).

Move the Half-Backspace Lever toward you until the red vertical line at the top center of the Cardholder indicates the desired typing position for the next character to be typed. To move exactly one-half space, pull the Lever forward as far as it will go.

When the Lever is released, the Carrier will move forward to its normal position.

Typing with the Lever forward allows regular character spacing, but one-half space out of the normal typing position.

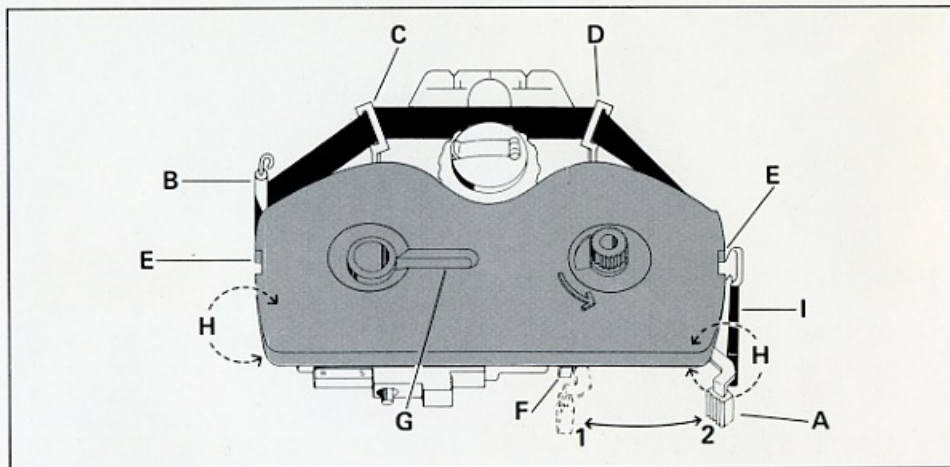

### Ribbon Systems

The IBM Correcting "Selectric" Typewriter offers a selective ribbon system: IBM Correctable Film Ribbon with IBM Lift-off Tape, or the IBM Tech III Ribbon with IBM Tech III Cover-up Tape. Both are quickly and easily installed. And, to avoid any confusion, both types are color coded—ribbon cartridge with corresponding correcting tape.

The IBM "Selectric" II Typewriter is equipped with a Selective Ribbon System which accepts either an IBM Tech III Ribbon or a carbon film ribbon. A fabric ribbon mechanism is also available.

Choose the following instructions that correspond to the ribbon mechanism on your typewriter.

### Selective Ribbon System

To see how much ribbon remains in the Cartridge, look at the Ribbon End Indicator G.

#### To Remove a Ribbon

- Center the Carrier and turn the motor OFF.
- Lift the cover.
- Keep the Paper Bail against the Platen.
- Move the Ribbon Load Lever A\* to the load position 1 until it snaps against the Stop F.
- Using both hands, hold the Ribbon Cartridge at the front corners H and lift straight up.

\* The Ribbon Load Lever on the IBM Correcting "Selectric" Typewriter cannot be moved if the Tape Load Lever 1 is in the load position.

#### To Install a New Ribbon

- Be sure the Ribbon Load Lever A is in the load position 1.
- Put the ribbon leader (uninked portion) over the *outside* of the Guidepost B and Ribbon Guides C and D. *Failure to do so will cause ribbon breakage.*
- Position the Ribbon Cartridge so that it fits between the Spring Clips E. Firmly push down both ends of the Cartridge.
- Thread the leader through Ribbon Guides C and D.
- Turn the Knob on the Cartridge in the direction of the arrow until the leader is past the right Ribbon Guide D.
- Move the Ribbon Load Lever A to the type position 2.
- Close the cover.

**Note:** The name and reorder number of each ribbon appear on the underside of the Ribbon Cartridge.

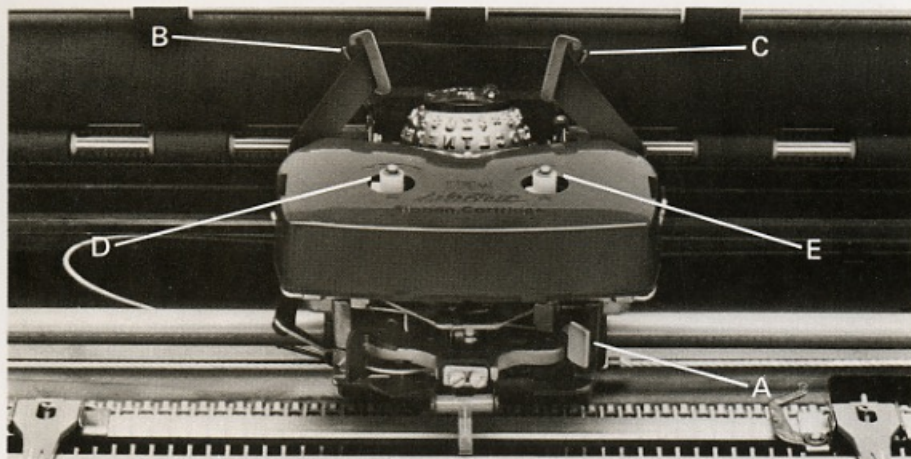

### Fabric Ribbon Mechanism

#### To Remove a Fabric Ribbon:

- Center the Carrier; then, turn the motor OFF.
- Lift the cover.
- Keep the Paper Bail against the Platen.
- Move the Ribbon Change Lever A to the far right to raise Ribbon Guides B and C.
- Lift the Cartridge upward and off the Spindles D and E.
- Ease the ribbon out of the Ribbon Guides B and C.

#### To Install a Fabric Ribbon:

- The Carrier should remain centered and the motor OFF.
- Keep the Paper Bail against the Platen.
- Be sure that the Ribbon Change Lever A is at the far right.
- Position the Cartridge in front of Ribbon Guides B and C and thread the ribbon through these Guides.
- Place the Cartridge on the Spindles D and E and press down.
- Move the Ribbon Change Lever A back to the left to lower the ribbon into typing position.
- To take up the slack in the ribbon, turn either Spindle D or E in the direction of the arrows.

**Note:** The name and reorder number of each ribbon appear on the underside of the Ribbon Cartridge.

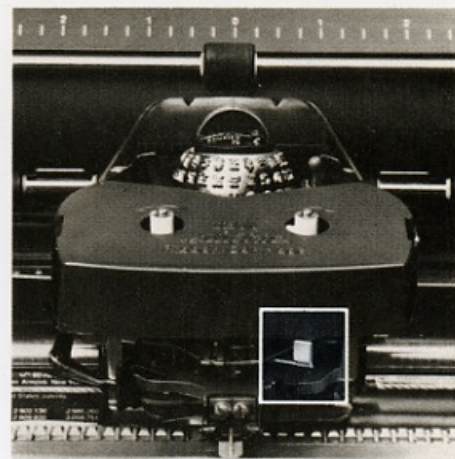

### Ribbon Reverse Lever

(Fabric Ribbon Model Only)

Fabric ribbons reverse automatically when either side of the Cartridge becomes empty. However, to manually reverse the ribbon, press the Ribbon Reverse Lever nearest you to the rear.

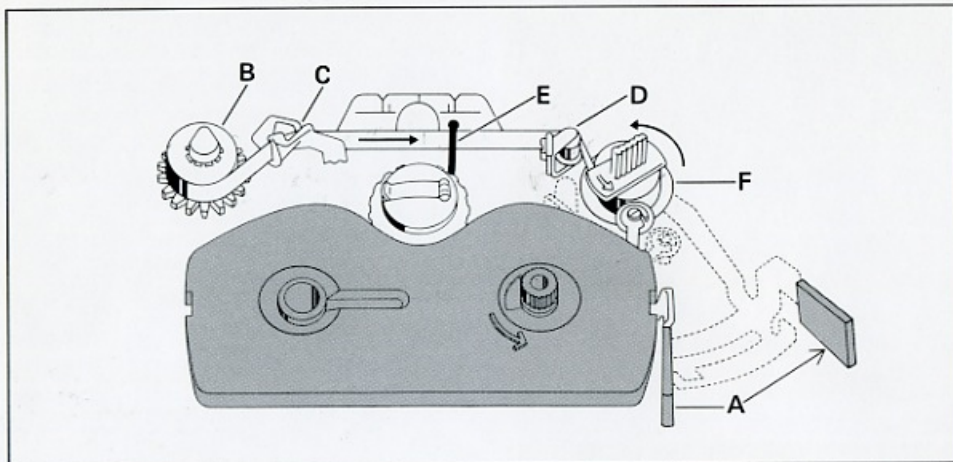

### Changing the Correcting Tape

#### To Remove the Tape:

- Move the Tape Load Lever A to the right.\*
- Lift off the empty Tape Spool B (twist slightly clock-wise); remove Take-up Spool.

\*The Tape Load Lever cannot be moved if the Ribbon Load Lever is in the load position.

#### To Install New Tape:

**Remember:** Use a tape with a yellow Spool with a ribbon which has a yellow Knob; a blue Spool with a ribbon which has a blue Knob.

- Gently separate the two spools, but keep them connected by the yellow or blue tape (leader).
- Place new Tape Spool B on the left Spindle.
- Thread the leader through the Guide C, behind the Separator Wire E, and behind the Roller D.
- Place the Take-up Spool F on the right Spindle. Turn the Take-up Spool in the direction of the arrow until the leader is past the Roller.
- Close the Tape Load Lever A. (The Lever must be closed before you begin to type.)



### Cleaning the Typing Element

Elements may be cleaned by using a dry IBM typewriter brush.

Position the Element on the end of the dual-purpose brush by inserting the handle of the brush into the hole under the Element and then closing the lever on the top of the Element.

Clean type by brushing up and away from you with the Element brush provided for this purpose.

Type cleaners in sheet form are also recommended since they may be used without removing the Element from the typewriter. Just insert the sheet, move the Ribbon/Stencil Control to stencil position, and type each character at least once.

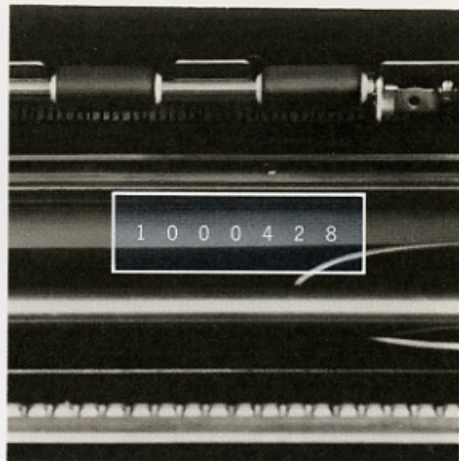

### Serial Number

To Locate the Serial Number:

- Tab the Carrier all the way to the right.
- Raise the typewriter cover.
- Locate the number directly below the Platen toward the left on the metal bar as shown in the illustration.

### Cleaning the Typewriter Cover

Use only a mild detergent to clean the plastic parts and painted portions of the typewriter since certain cleaning fluids may be harmful. Where stubborn stains persist, consult your local IBM Service Department.

### IBM Maintenance Agreement

An IBM Maintenance Agreement puts the latest service techniques at your disposal. You receive Preventive Maintenance, emergency service during business hours, and parts replacement (except Platens) without additional charge.

Call your local IBM Representative to purchase an IBM Maintenance Agreement.

### Checklist for Proper Typewriter Operation

- Be sure the electric cord is correctly plugged into the outlet.
- The ON portion of the On/Off Control should be depressed.
- Make certain that the Ribbon/Stencil Control is not in stencil position and that the Multiple Copy Control is appropriately set.
- If the Carrier will not move, turn the motor OFF for a few seconds, then ON. Press the Margin Release Key or Tab Key to release the Carrier.
- When erratic line spacing occurs, check to see that the Line Finder is engaged.
- Remove the Element to check for a broken tooth at the bottom. If a tooth is broken the Element will have to be replaced.
- On a fabric ribbon typewriter, reverse the ribbon *manually* (See p. 17) and continue typing.

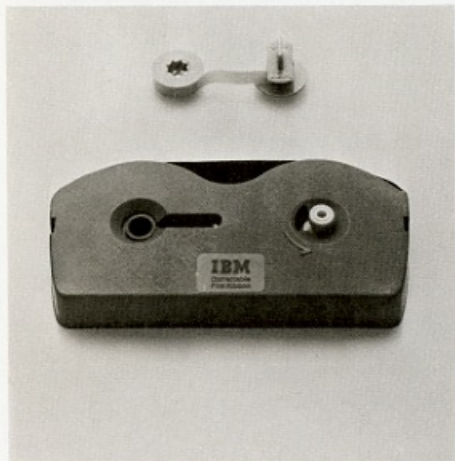

### IBM Correctable Film Ribbon

Reorder #1136432

IBM Correctable Film Ribbon is a correspondence ribbon specially formulated to work in tandem with IBM Lift-off Tape for total image removal. Character edge definition and print quality are best when using a smooth surfaced paper with an original and less than three carbon copies. Carbon paper weight should not exceed that of IBM 752 Carbon Paper. The IBM Tech III Ribbon is recommended for type styles larger than Courier.

Best results are obtained with the first original sheet being a 16-20 lb. unglazed smooth finish paper. Many 24 lb. bond papers will give satisfactory results on single copy applications. Other paper weights and finishes should be tested to ensure satisfactory results. Certain erasable or coated bond papers are not

receptive to the IBM Correctable Film Ribbon and may result in partially printed characters.

When typing negotiable instruments, the IBM Tech III Ribbon should be used. For direct offset masters and OCR applications, the IBM Film Ribbon is recommended. The IBM Correctable Film Ribbon is unsatisfactory for these applications. Available in black only.

### IBM Lift-off Tape Reorder #1136433

Designed to correct typing errors in an instant when used in combination with the IBM Correctable Film Ribbon. It lifts the character from the paper.

**Note:** As a reminder to you to match the appropriate tape and ribbon, they are color coded yellow for your convenience.

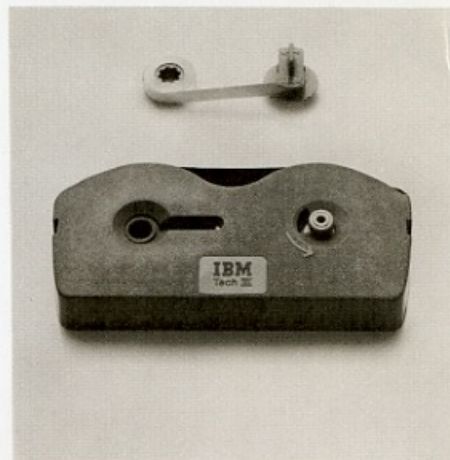

### IBM Tech III Ribbon Reorder #1136391

Provides a high quality, uniform image on a broader range of papers than carbon film ribbons, and reduces ribbon changes. Available in black only. It is virtually impossible to decipher any information on the IBM Tech III Ribbon after its use. The advanced fluid ink technology enables the ribbon to be struck several times in the same area . . . without reducing the clarity of the typewritten page.

### IBM Tech III Cover-up Tape

Reorder #1136435

Specially designed to work in tandem with the IBM Tech III Ribbon. The IBM Tech III Cover-up Tape provides complete coverage of the incorrectly typed image. Not satisfactory for making corrections on direct image offset masters, non-white paper, or OCR applications.

**Note:** As a reminder to you to match the appropriate tape and ribbon, they are color coded blue for your convenience.



#### **IBM Carbon Film Ribbon**

Reorder #1136390 for black

For the IBM "Selectric" II Typewriter, this high quality ribbon is supplied in a convenient cartridge that not only simplifies ribbon changing, but also reduces the number of ribbon changes.

In addition to black, Carbon Film Ribbons are available in a variety of colors—light blue, medium blue, dark blue, medium green, dark green, medium brown, dark brown, and red.



#### **IBM Fabric Ribbon**

Reorder #1136138 for black

IBM manufactures a complete line of nylon "Selectric" II Typewriter ribbons in easy-to-handle cartridges. They all offer uniform impression, excellent performance and long ribbon life. IBM Fabric Ribbons can be used only on IBM "Selectric" II Typewriters having a fabric ribbon mechanism. Ribbons are available in black, black and red, and four special colors: dark blue, medium blue, medium green and medium brown.



#### **IBM 752 Carbon Paper**

8½" x 11½"—Reorder #1023763

8½" x 14½"—Reorder #1023764

Ideal for typing jobs requiring up to five carbon copies. IBM 752 Carbon Paper contains a dry-writing ink that assures clean, smudge-free copies every time. In addition, the 752's sponge-like surface re-inks itself after each use to provide longer on-the-job life.



### Typing Elements

The IBM Correcting "Selectric" Typewriter and the IBM "Selectric" II Typewriter incorporate interchangeable Element technology for the greatest versatility and flexibility in typing. When changing typing applications, simply change the typing Element. They snap in and out in seconds.

On top of each Element is the following:

- The name of the type style; example, Courier 72.
- A 10 or 12 indicating pitch.
- The black Element Release Lever (except on Elements with a specially requested character which have a white Lever).
- A three-digit part number under the Element Release Lever.

The wide range of type styles available from IBM cover virtually every typing application. From general correspondence to specialized formats. You'll find one right for every typing job. You can even order type Elements applicable to specific industries and foreign languages—with special characters, punctuation marks, and symbols.

If you don't find the typing Elements just right for you among the standard keyboard arrangements, ask your IBM Representative about Custom Typing Elements.

**Note:** Using a typing Element of one pitch when the typewriter is set for the other pitch will alter only the amount of space between each character.

### Suggested Element Sets

#### Accounting:

Advocate  
Letter Gothic  
Manifold (006)  
Scribe  
Prestige Pica 72  
Bookface  
Academic 72

#### Correspondence:

Artisan 12  
Courier 12  
Courier 72  
Prestige Elite 72

#### Engineering and Scientific:

Delegate  
Dual Gothic  
Light Italic  
Symbol 10 or 12

#### Executive:

Courier 12  
Light Italic  
Orator  
Script  
Bookface  
Academic 72

#### Forms:

Artisan 12  
Courier 12  
Dual Gothic  
Manifold 72 (010)

#### General Typing:

Advocate  
Courier 12  
Letter Gothic  
Prestige Elite 72  
Prestige Pica 72  
Bookface  
Academic 72

#### Legal:

Large Elite  
Light Italic  
Pica 72 (legal)\*  
Prestige Elite 72  
Prestige Pica 72  
Bookface  
Academic 72

#### Library:

Delegate  
Elite 72 (library)\*  
Orator  
Script

#### Medical:

Advocate  
Courier 12  
Courier 12 italic  
Letter Gothic

#### Personnel:

Advocate  
Artisan 12  
Letter Gothic  
Orator

#### Sales:

Courier 72  
Dual Gothic  
Orator  
Prestige Elite 72

#### Statistical:

Artisan 12  
Light Italic  
Manifold 72 (019)  
Prestige Elite 72  
Prestige Pica 72

\* A specialized keyboard arrangement is available for this element.



## Element Application Rating\*

	Maximum Carbon Copies	Offset Masters	Spirit Masters	Stencils	Diazo	Office Copier Machines
Adjutant	B	A	B	B	A	A
Advocate	A	B	A	A	B	A
Artisan 12 (72)	B	B	B	B	B	A
Bookface Academic 72†	B	A	B	C	B	A
Courier 12	B	A	B	B	B	A
Courier 12 Italic	B	A	B	B	B	A
Courier 72	B	A	B	B	B	A
Delegate	B	A	B	C	A	A
Dual Gothic	B	B	B	A	B	A
Elite 72	A	A	A	A	A	A
Large Elite 72	A	A	A	A	A	A
Letter Gothic	A	A	B	B	B	A
Light Italic	A	A	A	A	A	A
Manifold 72	A	B	B	B	A	A
Orator†	C	C	C	C	C	A
Pica 72	A	A	A	A	A	A
Prestige Elite 72	A	A	A	A	A	A
Prestige Pica 72†	B	A	B	B	B	A
Scribe	A	B	A	A	A	A
Script	C	B	C	C	B	A

\* Ratings: A—Good; B—Fair; C—Marginal

† For best print quality, the IBM Tech III Ribbon is recommended for these large type styles.

Assumptions:

Proper setting of the Impression Control (see p. 7).

Proper selection of ribbon, carbon paper, stencils, etc.

Note: Symbol and OCR elements are special application type styles.

## Additional Optional Features



### Velocity Control Dial

(Optional Feature)

This Dial is used when typing with foreign language and technical typing Elements.

Hold the Dial at the thin mark to type small characters such as accent marks.

Move the Dial toward the thick line when typing in uppercase with Elements containing a ten-key numerical cluster, or some foreign language Elements with large characters in the keyboard positions normally reserved for punctuation.

For a standard Element, keep the Dial at the center position.

### Dead Key (Optional Feature)

If you regularly use a library, language, or trilingual typing Element, your typewriter should be equipped with the Dead Key Feature. With Dead Key, you can type accent marks without the Carrier advancing to the next space.

To use the feature, first type the accent mark; then, type the alphabetic character. The Carrier will move after the alphabetic character is typed.

You must space forward before pressing the Correcting Key when correcting a character on a Dead Key.



### Dead Key Disconnect (Optional Feature)

Standard correspondence Elements can also be used on typewriters equipped with Dead Keys through the use of the Dead Key Disconnect feature.

To allow normal use of a Dead Key, set the Dial at the "X" position when using a library, language, or trilingual typing Element.

Set the Dead Key Disconnect Dial at the "→" position for a correspondence Element. When the Dial is set here, the Carrier will space to the next typing position for all characters as they print.



### Sound Reduction Option

To insert paper into your typewriter:

- Lift front of Hood up and back.
- Insert and reposition paper (See p.3).
- Direct paper out back opening.
- Close Hood.

**Note:** Keep Hood up when typing direct image offset masters.

### Your IBM Sales Representative

Name \_\_\_\_\_

Telephone \_\_\_\_\_ Ext. \_\_\_\_\_

Address \_\_\_\_\_

### Your IBM Customer Engineer

Name \_\_\_\_\_

Telephone \_\_\_\_\_ Ext. \_\_\_\_\_

Address \_\_\_\_\_

### Your IBM Supplies Representative

Name \_\_\_\_\_

Telephone \_\_\_\_\_ Ext. \_\_\_\_\_

Address \_\_\_\_\_



International Business Machines Corporation  
Office Products Division  
For additional information,  
consult the nearest IBM Branch Office

OPD ADV Form No. G542-0054-3 Printed in USA 273/1176

PN/1206423