

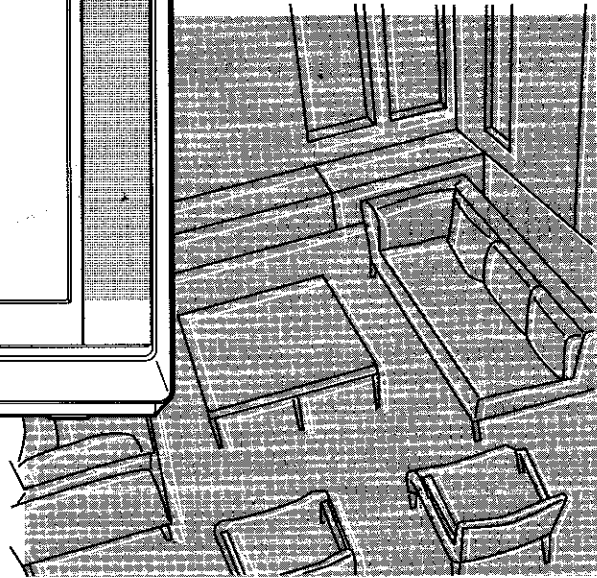

**OWNER'S MANUAL**  
**IWT3206**

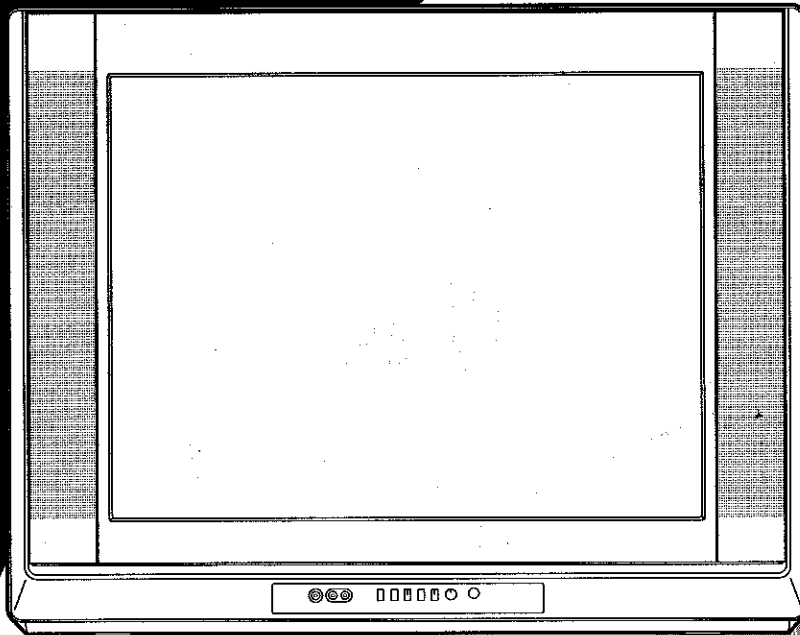

**32 INCH**  
**ANALOG / DIGITAL**  
**TELEVISION**

TO RECEIVE DIGITAL SIGNAL  
YOU MUST CONNECT ANTENNA

If you need additional operating assistance after reading this owner's manual or to order replacement accessories, please call **TOLL FREE : 1-800-474-0045** or visit our WEB SITE at <http://www.funai-corp.com>

## WARNING:

TO REDUCE THE RISK OF FIRE OR ELECTRIC SHOCK, DO NOT EXPOSE THIS APPLIANCE TO RAIN OR MOISTURE.



**CAUTION**  
**RISK OF ELECTRIC SHOCK**  
**DO NOT OPEN**



**CAUTION:** TO REDUCE THE RISK OF ELECTRIC SHOCK, DO NOT REMOVE COVER (OR BACK). NO USER SERVICEABLE PARTS INSIDE. REFER SERVICING TO QUALIFIED SERVICE PERSONNEL.



THIS SYMBOL INDICATES THAT DANGEROUS VOLTAGE CONSTITUTING A RISK OF ELECTRIC SHOCK IS PRESENT WITHIN THIS UNIT.



THIS SYMBOL INDICATES THAT THERE ARE IMPORTANT OPERATING AND MAINTENANCE INSTRUCTIONS IN THE LITERATURE ACCOMPANYING THE APPLIANCE.

The important note is located on the rear of the cabinet.

## IMPORTANT SAFEGUARDS

1. **READ INSTRUCTIONS**-All the safety and operating instructions should be read before the appliance is operated.
2. **RETAIN INSTRUCTIONS**-The safety and operating instructions should be retained for future reference.
3. **HEED WARNINGS**-All warnings on the appliance and in the operating instructions should be adhered to.
4. **FOLLOW INSTRUCTIONS**-All operating and use instructions should be followed.
5. **CLEANING**-Unplug TV from the wall outlet before cleaning. Do not use liquid cleaners or aerosol cleaners. Use a damp cloth for cleaning.  
**EXCEPTION:** A product that is meant for uninterrupted service and, that for some specific reason, such as the possibility of the loss of an authorization code for a CATV converter, is not intended to be unplugged by the user for cleaning or any other purpose, may exclude the reference to unplugging the appliance in the cleaning description otherwise required in item 5.
6. **ATTACHMENTS**-Do not use attachments not recommended by the TV manufacturer as they may cause hazards.
7. **WATER AND MOISTURE**-Do not use this TV near water, for example, near a bath tub, wash bowl, kitchen sink, or laundry tub, in a wet basement, or near a swimming pool, and the like.
8. **ACCESSORIES**-Do not place this TV on an unstable cart, stand, tripod, bracket, or table. The TV may fall, causing serious injury to someone, and serious damage to the appliance. Use only with a cart, stand, tripod, bracket, or table recommended by the manufacturer, or sold with the TV.

Any mounting of the appliance should follow the manufacturer's instructions and should use a mounting accessory recommended by the manufacturer. An appliance and cart combination should be moved with care. Quick stops, excessive force, and uneven surfaces may cause the appliance and cart combination to overturn.

PORTABLE CART WARNING



AMEUBLES- Cet appareil ne doit être placé que sur un meuble (avec ou sans roulettes) recommandé par le fabricant. Si vous l'installez sur un meuble à roulettes, déplacez les deux ensembles avec précaution. Un arrêt brusque, l'utilisation d'une force excessive et des surfaces irrégulières risquent de déstabiliser l'ensemble et de le renverser.

SYMBÔLE D'AVERTISSEMENT POUR LES COMPOSANTES APPAREIL ET MEUBLE À ROULETTES



9. **VENTILATION**-Slots and openings in the cabinet and the back or bottom are provided for ventilation and to ensure reliable operation of the TV and to protect it from overheating, these openings must not be blocked or covered. The openings should never be blocked by placing the TV on a bed, sofa, rug, or other similar surface. This TV should never be placed near or over a radiator or heat register. This TV should not be placed in a built-in installation such as a bookcase or rack unless proper ventilation is provided or the manufacturer's instructions have been adhered to.
10. **POWER SOURCES**-This TV should be operated only from the type of power source indicated on the marking label. If you are not sure of the type of power supply to your home, consult your appliance dealer or local power company. For TVs intended to operate from battery power, or other sources, refer to the operating instructions.
11. **GROUNDING OR POLARIZATION**-This TV is equipped with a polarized alternating-current line plug (a plug having one blade wider than the other). This plug will fit into the power outlet only one way. This is a safety feature. If you are unable to insert the plug fully into the outlet, try reversing the plug. If the plug should still fail to fit, contact your electrician to replace your obsolete outlet. Do not defeat the safety purpose of the polarized plug.
12. **POWER-CORD PROTECTION**-Power-supply cords should be routed so that they are not likely to be walked on or pinched by items placed upon or against them, paying particular attention to cords at plugs, convenience receptacles, and the point where they exit from the appliance.

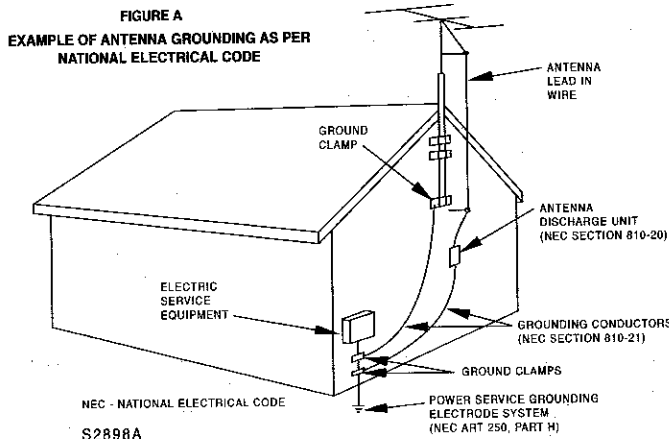

13. **OUTDOOR ANTENNA GROUNDING**-If an outside antenna or cable system is connected to the TV, be sure the antenna or cable system is grounded so as to provide some protection against voltage surges and built-up static charges. Article 810 of the National Electrical Code, ANSI/NFPA No. 70, provides information with respect to proper grounding of the mast and supporting structure, grounding of the lead-in wire to an antenna discharge unit, size of grounding conductors, location of antenna-discharge unit, connection to grounding electrodes, and requirements for the grounding electrode. (Fig. A)
14. **LIGHTNING**-For added protection for this TV receiver during a lightning storm, or when it is left unattended and unused for long periods of time, unplug it from the wall outlet and disconnect the antenna or cable system. This will prevent damage to the TV due to lightning and power-line surges.
15. **POWER LINES**-An outside antenna system should not be located in the vicinity of overhead power lines or other electric light or power circuits, or where it can fall into such power lines or circuits. When installing an outside antenna system, extreme care should be taken to keep from touching such power lines or circuits as contact with them might be fatal.
16. **OVERLOADING**-Do not overload wall outlets and extension cords as this can result in a risk of fire or electric shock.
17. **OBJECT AND LIQUID ENTRY**-Never push objects of any kind into this TV through openings as they may touch dangerous voltage points or short out parts that could result in a fire or electric shock. Never spill liquid of any kind on the TV.
18. **SERVICING**-Do not attempt to service this TV yourself as opening or removing covers may expose you to dangerous voltage or other hazards. Refer all servicing to qualified service personnel.
19. **DAMAGE REQUIRING SERVICE**-Unplug this TV from the wall outlet and refer servicing to qualified service personnel under the following conditions:
  - a. When the power supply cord or plug is damaged or frayed.
  - b. If liquid has been spilled, or objects have fallen into the TV.
  - c. If the TV has been exposed to rain or water.
  - d. If the TV does not operate normally by following the operating instructions. Adjust only those controls that are covered by the operating instructions, as improper adjustment of other controls may result in damage and will often require extensive work by a qualified technician to restore the TV to its normal operation.
  - e. If the TV has been dropped or damaged in any way.
  - f. When the TV exhibits a distinct change in performance, this indicates a need for service.
20. **REPLACEMENT PARTS**-When replacement parts are required, be sure the service technician uses replacement parts specified by the manufacturer that have the same characteristics as the original part. Unauthorized substitutions may result in fire, electric shock, injury to persons or other hazards.
21. **SAFETY CHECK**-Upon completion of any service or repairs to this TV, ask the service technician to perform routine safety checks to determine that the TV is in proper operating condition.
22. **HEAT**-This TV product should be situated away from heat sources such as radiators, heat registers, stoves, or other products (including amplifiers) that produce heat.

## SUPPLIED ACCESSORIES

- Owner's Manual (1EMN21491)



- Remote control unit (NE906UD)

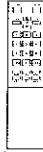

- Batteries ("AAA" x 2)



- If you need to replace these accessories, please refer to the PART NO, above the illustrations and call our help line mentioned on the front page.
- Depending on your antenna system, you may need different types of Combiners (Mixer) or Separator (Splitter). Contact your local electronics store for these items.

## PRECAUTIONS

- Place your TV in a room with adequate ventilation.
- Keep your TV set away from sources of direct heat, such as heat registers or direct sunlight.
- Do not place your TV on soft surfaces, such as rugs or blankets.
- Leave enough room for air to circulate around the bottom, top and back of the set.

**FCC WARNING:** This equipment may generate or use radio frequency energy. Changes or modifications to this equipment may cause harmful interference unless the modifications are expressly approved in the owner's manual. The user could lose the authority to operate this equipment if an unauthorized change or modification is made.

**CAUTION:** TO PREVENT ELECTRIC SHOCK, MATCH WIDE BLADE OF PLUG TO WIDE SLOT, FULLY INSERT.

**ATTENTION:** POUR ÉVITER LES CHOC ÉLECTRIQUES, INTRODUIRE LA LAME LA PLUS LARGE DE LA FICHE DANS LA BORNE CORRESPONDANTE DE LA PRISE ET POUSSER JUSQU'AU FOND.

**A NOTE ABOUT RECYCLING:** Batteries should never be thrown away or incinerated but disposed of in accordance with your local regulations concerning chemical wastes.

**Note to CATV system installer:**

*This reminder is provided to call the CATV system installer's attention to Article 820-40 of the NEC that provides guidelines for proper grounding and, in particular, specifies that the cable ground should be connected to the grounding system of the building as close to the point of cable entry as practical.*

The serial number of this product may be found on the back of the TV. No others have the same serial number as yours. You should record the number and other vital information here and retain this book as a permanent record of your purchase to aid identification in case of theft.

Model No.		Date of Purchase	
Serial No.		Dealer Phone No.	
Dealer Purchase from		Dealer Address	

## FEATURES

- **DTV/TV/CATV**

This TV lets you easily switch TV(NTSC) and DTV(ATSC) with the remote control. This feature enables you to simply view from conventional analog TV to Standard Definition TV, High Definition TV. You can also connect this TV to CATV if you have a CATV box.

- **Program Information Display (DTV)**

You can display the title, contents and other information of the current DTV program on the screen.

- **Auto Preset Channel**

This TV can automatically scan and memorize the channels receivable in your residential area. This feature eliminates the need of a difficult setting procedure.

- **V-CHIP**

This feature lets you set the viewing limitations to prevent your children from watching inappropriate programs.

- **Closed Caption Decoder**

This TV contains the built-in Closed Caption Decoder that displays text across the screen. It allows you to read the dialogue of a TV program or other information in the Closed Caption-supported programs.

- **MTS/SAP Tuner**

This feature allows you to select with the remote control your desired audio language.

- **Auto Shut Off Function**

The power of the main unit is automatically turned off when there has been no signal or key input for more than 15 minutes.

- **Sleep Timer**

This feature will automatically turn off the power of the main unit at a present time.

- **On-Screen Function Display (ENGLISH/SPANISH/FRENCH)**

This feature lets you select the language displayed in the menu screen from ENGLISH, SPANISH or FRENCH.

- **Stereo Sound Function**

- **Full-Function Remote Control**

- **PLL Frequency Synthesized Tuning**

- **S-VIDEO Input**

- **Front / Rear AV Input**

- **Component VIDEO Input**

- **Rear Digital Audio Output**

# CONTENTS

IMPORTANT SAFEGUARDS .....	2
SUPPLIED ACCESSORIES .....	4
PRECAUTIONS .....	4
FEATURES .....	5
<b>PREPARATION FOR USE .....</b>	<b>7</b>
CONNECTION .....	7
ANTENNA/BASIC CABLE CONNECTION .....	7
CONNECTION TO CABLE/SATELLITE BOX .....	8
COMPONENT CONNECTION .....	8
EXTERNAL CONNECTION .....	9
USING FRONT A/V CONNECTION .....	10
DIGITAL AUDIO CONNECTION .....	10
INSTALLING THE BATTERIES .....	11
BATTERY PRECAUTIONS .....	11
<b>FUNCTIONS .....</b>	<b>12</b>
REMOTE CONTROL AND FRONT PANEL FUNCTION .....	12
<b>WATCHING TV .....</b>	<b>13</b>
INITIAL SETTINGS .....	13
SWITCHING ANALOG MODE/DIGITAL MODE .....	15
CHANNEL SELECTION .....	15
VOLUME ADJUSTMENT .....	16
SWITCHING AUDIO .....	16
SCREEN INFORMATION .....	17
SWITCHING EXTERNAL INPUT .....	18
<b>OPTIONAL SETTINGS .....</b>	<b>19</b>
SLEEP TIMER .....	19
MENU SCREEN .....	19
PICTURE ADJUSTMENT .....	20
CLOSED CAPTION .....	21
V-CHIP .....	24
CHANGING THE SCREEN DISPLAY MODE .....	27
<b>OTHER SETTINGS .....</b>	<b>28</b>
AUTO PRESET CH .....	28
CHANNEL ADD/DELETE .....	30
LANGUAGE SELECTION .....	31
D. S. T. .....	32
TIME ZONE .....	33
<b>MISCELLANEOUS .....</b>	<b>34</b>
TROUBLESHOOTING GUIDE .....	34
GLOSSARY .....	36
MAINTENANCE .....	36
<b>SPECIFICATIONS .....</b>	<b>37</b>

## SYMBOLS USED IN THIS MANUAL

The following is the description for the symbols used in this manual.



: Settings only for the analog mode



: Settings only for the digital mode



: Common settings for the analog mode and digital mode

# PREPARATION FOR USE

## CONNECTION

This section describes how to connect this TV to reception and other sources.

### **MAKE SURE YOU HAVE AN ANTENNA**

**As DTV is only available over the air, you need an antenna to receive digital signal.**

#### [ANTENNA / BASIC CABLE CONNECTION]

##### 1) When connecting TV to antenna

Connect the RF cable or antenna cable on your home outlet to the ANT. IN jack of this TV.

##### 2) When connecting TV to basic cable (without box)

Connect the RF cable or incoming cable on your home outlet to the ANT. IN jack of this TV.

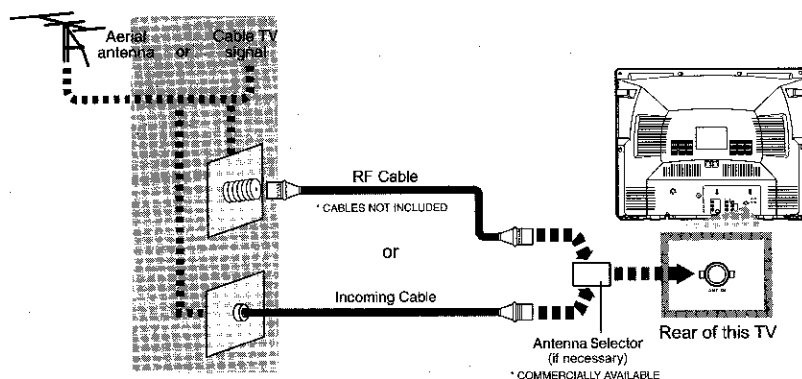

#### **NOTES:**

- For your safety and to avoid damages to the unit, unplug the antenna cable from the ANT. IN jack before moving the unit.
- If you use an antenna in order to receive analog TV, the same antenna generally will work for DTV reception. Outdoor or attic antennas will be more effective than set-top versions.
- Some cable channels cannot be viewed when the TV is connected to an aerial antenna because DTV program does not cover all cable channels. You can watch them by switching to the cable connected to CATV.
- To easily switch between antenna and cable wires, you can purchase "Antenna Selector" commercially available.

\*Once connections are completed, turn on the TV and begin initial setup.

Channel scanning is necessary for the TV to memorize all available channels in your area if using antenna or basic cable. (Refer to "INITIAL SETTINGS" on page 13.)

**[CONNECTION TO CABLE/SATELLITE BOX]**

- 1) Connect the antenna cable on your home outlet to the input jack of the CABLE/SATELLITE box.
  - 2) Use the corresponding cable to connect the ANT. IN jack of this TV and the output jack of the CABLE/SATELLITE box.
- \*Required cables in 2) and connecting methods differ depending on the CABLE/SATELLITE box. For more information, please contact the store where you purchased the CABLE/SATELLITE box or nearby electric appliance stores.

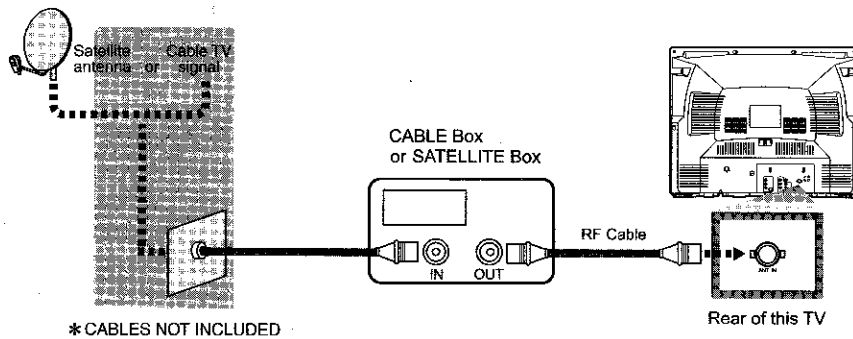

**[COMPONENT CONNECTION]**

- 1) This is the best method to connect this TV to video devices with the component output jack, such as DVD player, etc. It can minimize the deterioration of image quality. Use the component cable (commercially available) for connection.

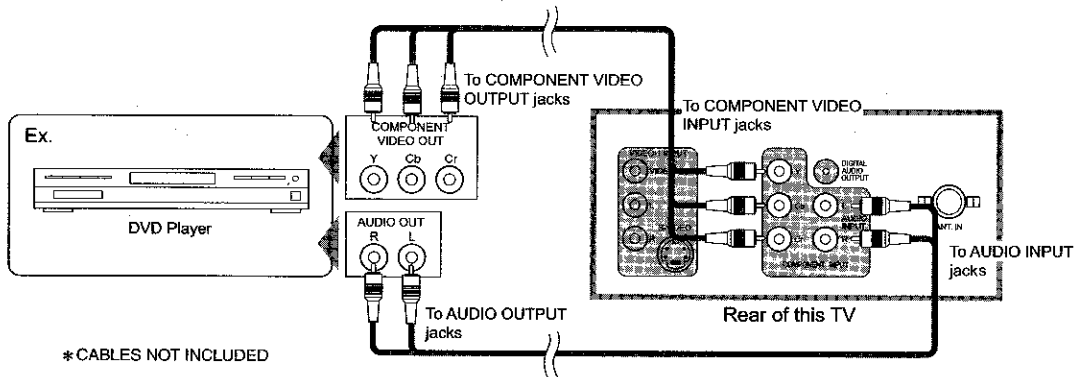

**NOTE:**  
 This TV can only accept a 480i (interlaced) video signal.



## [EXTERNAL CONNECTION]

### When using the Audio/Video cables

- 1) This is the general method to connect this TV to video devices with the video or audio output jacks, such as VCR etc.  
When the audio jack of video devices is monaural, connect this TV to the AUDIO L jack.

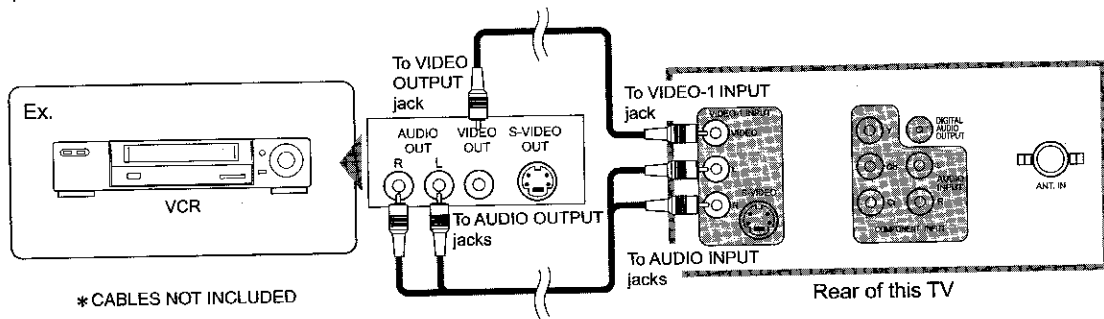

### When using the S-Video cable

- 1) This is how to connect this TV to the video devices with the S-Video output jack. You can expect better picture quality than the normal video cable connection.  
Use the S-Video cable (commercially available) for connection.

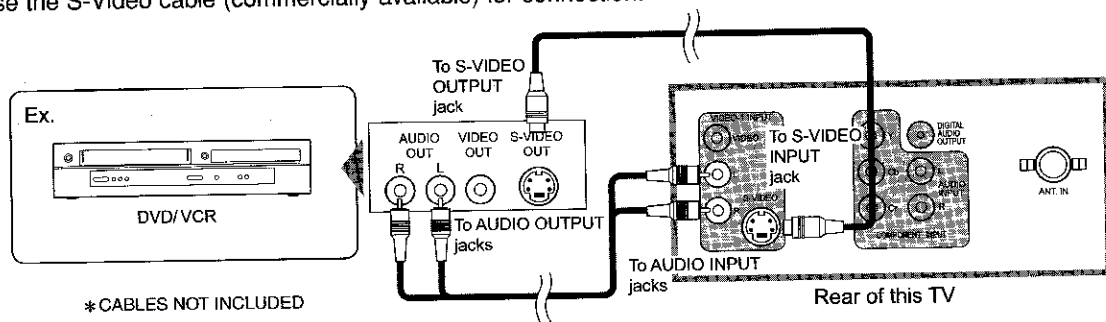

#### **NOTE:**

*If you connect to the S-VIDEO jack and the VIDEO jack at the same time, S-Video connection will have priority.*

### [USING FRONT A/V CONNECTION]

1) This is how to use the A/V jack in front of this TV and connect to external devices.

This is useful when you use game playing devices etc.

When the audio jack of external devices is monaural, connect this TV to the AUDIO L jack.

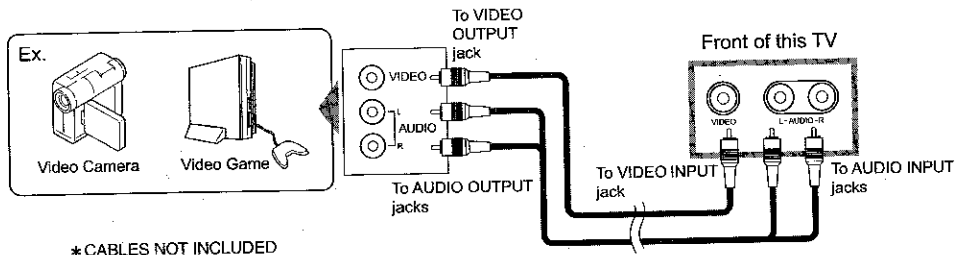

### [DIGITAL AUDIO CONNECTION]

1) If you connect this TV to the digital-supported audio devices, you can enjoy much more of the digital broadcasting programs with the feeling of being at a live program.

Use the digital audio coaxial cable (commercially available) for connection.

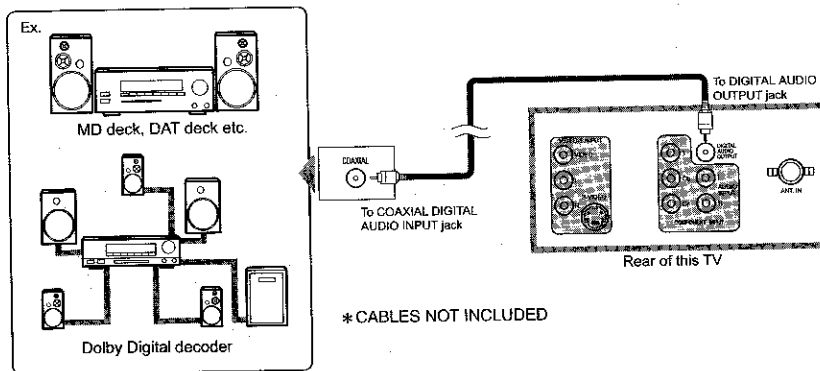

Manufactured under license from Dolby Laboratories. "Dolby" and the double-D symbol are trademarks of Dolby Laboratories.

## INSTALLING THE BATTERIES

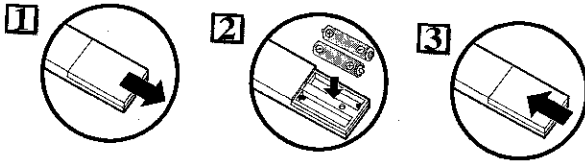

Install two AAA batteries (supplied) matching the polarity indicated inside battery compartment of the remote control.

### [BATTERY PRECAUTIONS]

- Be sure to follow the correct polarity as indicated in the battery compartment. Reversed batteries may cause damage to the device.
- Do not mix different types of batteries together (e.g. Alkaline and Carbon-Zinc) or old batteries with fresh ones.
- If the device is not to be used for a long period of time, remove the batteries to prevent damage or injury from possible battery leakage.
- Do not try to recharge batteries not intended to be recharged; they can overheat and rupture.

### Features of digital broadcasting

Digital broadcasting uses the newest broadcasting technology such as compression of audio and video signals and provides much more improved image and sound quality than analog broadcasting. For image quality, digital broadcasting have realized the High Definition Television (HDTV) that can display sharper and finer images than Standard Definition Television (SDTV) with double scanning lines, and can adopt the 16:9 wide screen format that fits more to range of human vision.

For audio quality, digital broadcasting offers the 5.1ch surround broadcast to give you the feeling of being at a stadium or a theater.

In addition, digital broadcasting enables to broadcast 2 or 3 programs of Standard Definition Television (SDTV), which is the analog television format, at the same time by 1 channel. This feature has made the program planning more diversified. In addition, digital broadcasting has overcome problems experienced with analog television such as ghosting or interference with digital technology.

### Minor channel of digital broadcasting

In digital broadcasting, the selected channel can have the sub channel. It is called the minor channel. Though the minor channel programs provide a little poorer image quality than the High Definition Television (HDTV) programs, they have such an advantage as it will not move back other programs even when a sport relay is extended.

# FUNCTIONS

## REMOTE CONTROL AND FRONT PANEL FUNCTION

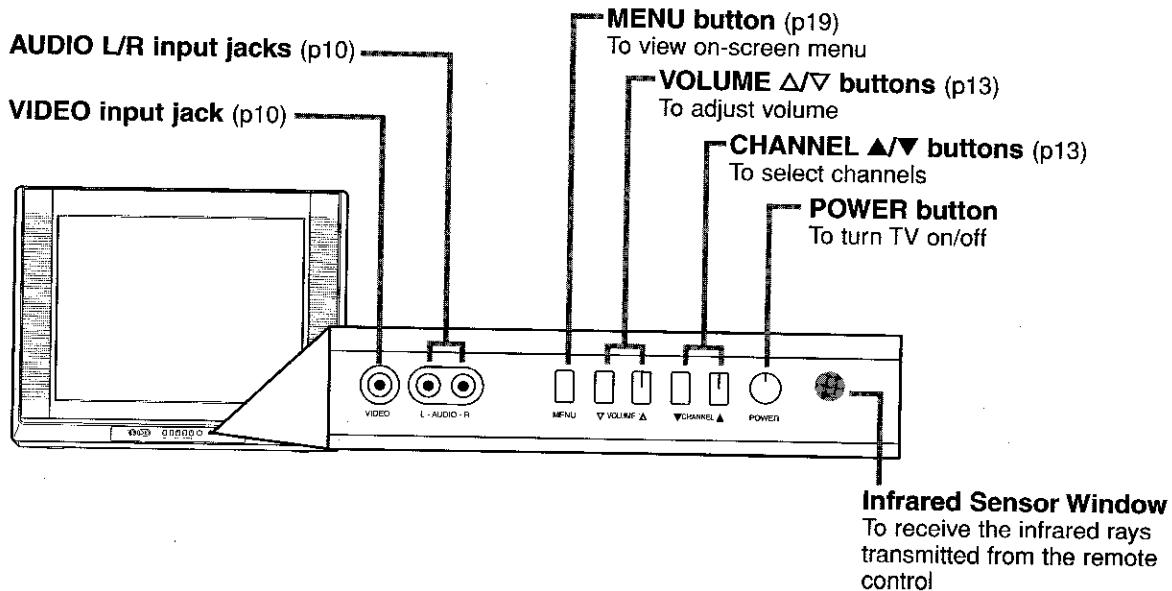
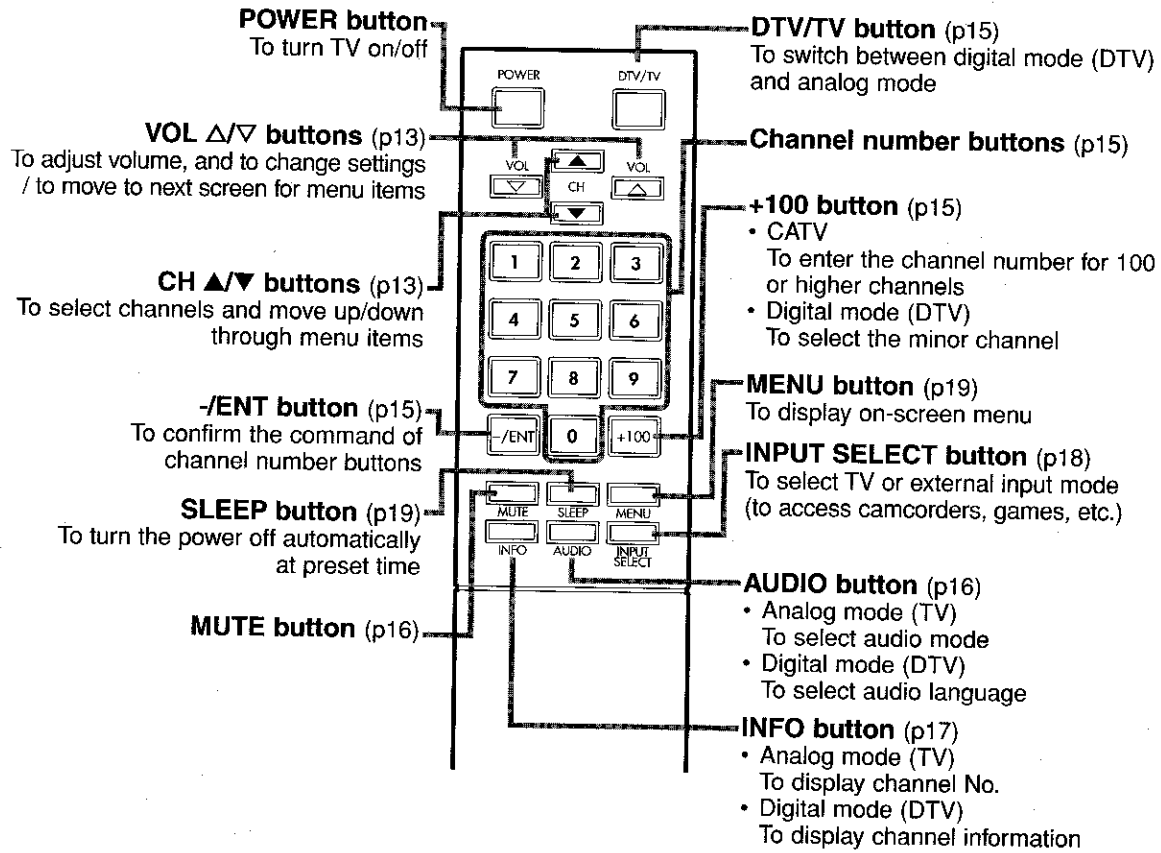

## INITIAL SETTINGS

This section describes the initial settings when you first turn on the power after purchase. The initial setting items are shown below.

**NOTE:**

Be sure that antenna or cable is connected properly before plugging the power cord.

### • LANGUAGE SELECTION

You can select the menu language displayed on the screen among English, Spanish and French.

### • D.S.T. (Daylight Saving Time)

You can set the air time display for digital broadcasting. When you set this function to ON, the date information adjusted for the area set by TIME ZONE will be adjusted to the one added by another 1 hour. In addition, the time difference will be adjusted as follows: 2 a.m. on first Sunday in April to 3 a.m., 1 hour ahead, and 2 a.m. on last Sunday in October to 1 a.m., 1 hour behind.

### • TIME ZONE

The EPG information in digital broadcasting is adjusted based on the area set in TIME ZONE.

### • AUTO PRESET CH (TV/DTV)

(When using antenna)

The channels broadcasted in TV and DTV are automatically scanned and memorized. Only the receivable channels in the area where this TV is used will be memorized.

### • AUTO PRESET CH (CATV)

(When using basic cable)

The channels broadcasted in CATV are automatically scanned and memorized.

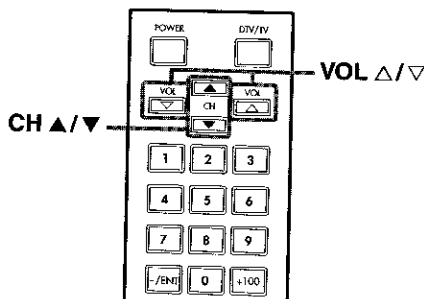

### 1 Select your language.

When you first turn on the power, the following screen is displayed.

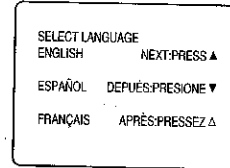

- At initial language screen, press [CH ▲] for English.
- press [CH ▼] for Spanish.
- press [VOL ▲] for French.

The next menu will be displayed in the selected language after you press the button.

### 2 Using [VOL ▲/▼], set "D.S.T. (Daylight Saving)" to [ON].

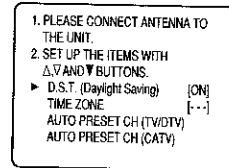

### 3 Using [CH ▲/▼], select "TIME ZONE".

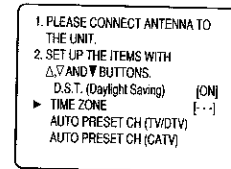

- Every time you press [VOL ▲/▼], the area will be switched as below.

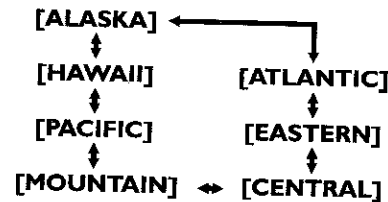

- Set your area.

**NOTE:**

You must set "D.S.T." and "TIME ZONE" before presetting channels.

#### 4 Set the AUTO PRESET CH.

##### NOTES:

- If "D.S.T. (Daylight Saving)" and "TIME ZONE" is not set, you cannot select "AUTO PRESET CH".
- Make sure if the TV is connected to antenna or cable. When antenna is connected, select "AUTO PRESET CH (TV/DTV)" at the procedure below. When connected to CATV, select "AUTO PRESET CH (CATV)".

Here describes the case for searching and memorizing channels for TV/DTV.

- Using [CH ▲/▼], select "AUTO PRESET CH(TV/DTV)".

1. PLEASE CONNECT ANTENNA TO THE UNIT.  
2. SET UP THE ITEMS WITH ▲, ▼ AND ▽ BUTTONS.  
D.S.T. (Daylight Saving) [ON]  
TIME ZONE [ALASKA]  
▶ AUTO PRESET CH (TV/DTV)  
AUTO PRESET CH (CATV)

- When you press [VOL ▲], the channel scanning in both analog and digital modes will automatically start.

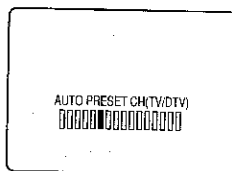

- When scanning is completed, the memorized smallest channel will be displayed.

##### NOTES:

- The initial AUTO PRESET CH function can be executed for either TV/DTV or CATV only once. If you want to scan both TV/DTV and CATV, you need to select "CHANNEL SET" in the MENU screen to scan and memorize other channels after initial presetting is completed. (Refer to page 28.)
- You can exit the initial AUTO PRESET menu by pressing [MENU].
- When you press [MENU] while scanning, the scanning is interrupted and the memorized smallest channel is displayed.
- If you press [POWER], the power will be turned off. When the scanning is not completed, initial AUTO PRESET CH screen is displayed every time you turn on the power.
- When no channel can be received by AUTO PRESET CH, "NO TV SIGNALS" is displayed on the screen.

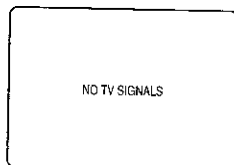

## SWITCHING ANALOG MODE / DIGITAL MODE

You can easily switch the TV (NTSC) and DTV (ATSC) with the remote control and enjoy viewing the High Definition TV programs as well as the Standard Definition TV programs with simple operation.

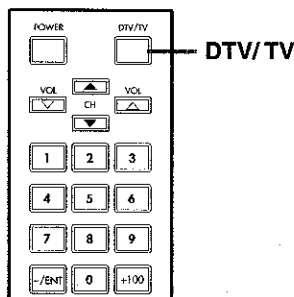

- 1 Press **[DTV/TV]** on the remote control.
  - The analog mode and digital mode switch alternately.
  - When you press **[DTV/TV]** in external input, the analog mode and digital mode will be switched.

### NOTE:

When you switch the analog mode to the digital mode, it may take a while until the digital channel selection is completed. The following screen is displayed while switching the mode.



## CHANNEL SELECTION

You can select the channel by using either **[CH ▲/▼]** or **Channel number buttons**. How to select the channel in each way is shown below.

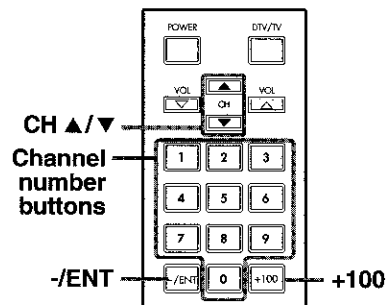

- 1 Using **[CH ▲/▼]**
  - Using **[CH ▲/▼]**, change the channel.
  - Same operation is available with **[CH ▲/▼]** on the front panel of the main unit.
- 2 Using **Channel number buttons**
  - When you select a channel from 1 to 99, press the channel number you want to view with **Channel number buttons**. The selected channel will be displayed.
  - When you select a channel larger than 100, press **[+100]** first. Then use **channel number buttons** to press the lower 2 digits.
  - To search the minor channel of the major channel currently viewed in DTV, press **[+100]**. If you know the minor channel while viewing the major channel with 1-digit channel number, press the major channel number and press **[-/ENT]**. Then, press the minor channel number you want to view. In case the major channel number is 2 digits, press the major channel number and press the minor channel number directly. If you press **[-/ENT]** after pressing the 2-digit major channel number, the smallest minor channel will be selected.

### NOTE:

In the DTV broadcasting, one channel sometimes broadcasts multiple programs depending on the air time. In this case, the main channel is called major channel and the sub channel is called minor channel.

## VOLUME ADJUSTMENT

This section describes how to adjust the volume when viewing TV. The MUTE function, which is useful when you have a visitor or a phone call, will be also described.

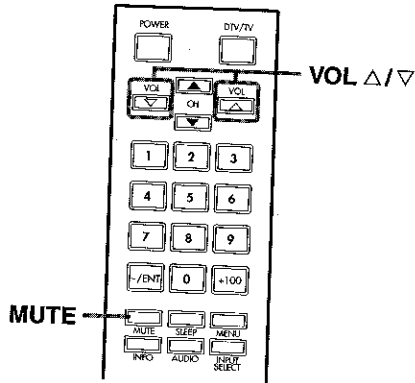

### 1 Using [VOL Δ/▽]

- You can adjust the audio volume with [VOL Δ/▽].
- The volume bar is displayed at the bottom of the screen when adjusting the volume.
- Same operation is available with [VOL Δ/▽] on the front panel of the main unit.

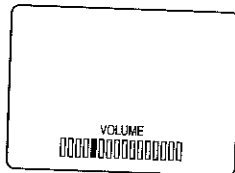

### 2 Using [MUTE]

- Press [MUTE] on the remote control to mute the sound.
- The colored volume bar is displayed on the screen while muting.

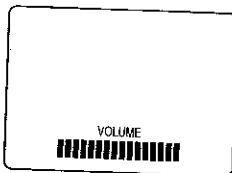

- To release the MUTE status, press [MUTE] again or press [VOL Δ/▽].

## SWITCHING AUDIO

This section describes how to switch the audio in the analog mode and how to switch the audio language in the digital mode.

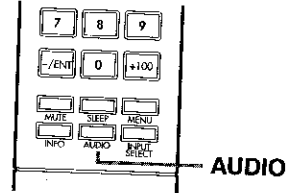

TV

### 1 Switch the audio.

- Every time you press [AUDIO], the audio will be switched as below.

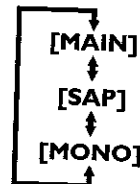

MAIN : Outputs main-audio

SAP : Outputs second audio channel

MONO : Outputs mono-audio

DTV

### 1 Switch the audio language.

- When you press [AUDIO], the currently selected language and the number of received languages will be displayed on the screen.

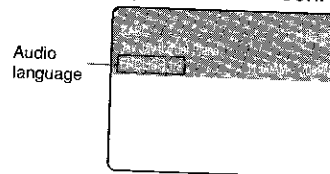

- Every time you press [AUDIO], the language will be switched.

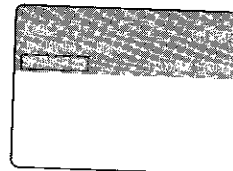

- Languages you can switch differ depending on the receiving broadcast.

#### NOTE:

Even if you press [AUDIO] in external input, the audio will not be switched.



## SCREEN INFORMATION

You can display the currently selected channel number or other information such as the audio mode on the screen for checking.

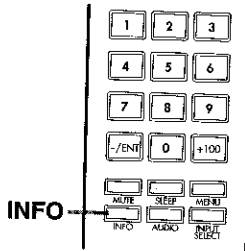

TV

In the analog mode, the currently selected channel number and the audio mode are displayed.

- 1 Display the channel number and the audio mode.

- Press **[INFO]** on the remote control. The currently selected channel number and the audio mode are displayed at the top right of the screen.

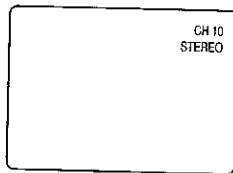

- To clear the display, press **[INFO]** again.
- The following screens are displayed when connecting to external devices:

- 1) When using video cable for connection

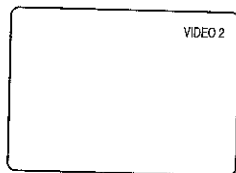

- 2) When using component video cable for connection

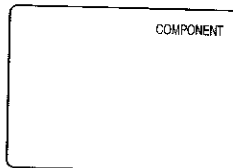

DTV

In the digital mode, the detailed information for the currently selected channel such as the program guide is displayed.

- 1 Display the detailed information for the channel.
  - Every time you press **[INFO]**, the display mode will be switched as below.

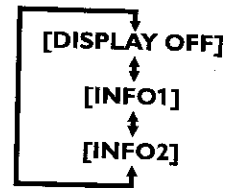

- The following information is displayed in the INFO1 mode.

- (1) Channel number
- (2) Channel title
- (3) Program title (max. 2 lines displayed)
- (4) Audio language ("OTHER" is displayed when the audio language cannot be acquired, or the acquired languages are other than ENGLISH, SPANISH or FRENCH.)
- (5) Program air time

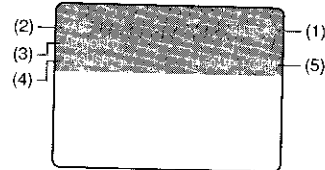

- The program guide added to the displayed information in the INFO1 mode is displayed in the INFO2 mode.

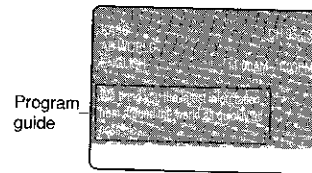

### NOTES:

- When the program guide is displayed in more than 6 lines, use **[VOL Δ/▽]** and scroll for reading.
- "No description provided" is displayed when the program guide is not provided.
- While the information is displayed in the INFO2 mode, the CLOSED CAPTION function is interrupted.



WATCHING TV

## SWITCHING EXTERNAL INPUT

When you connect external devices including a video cassette recorder and home audio system, you can easily switch the input mode with the remote control.

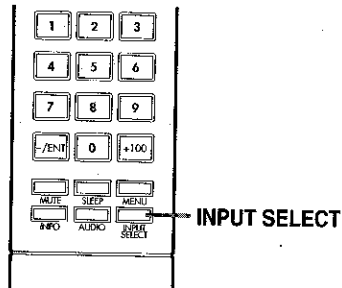

### 1 Switch the input mode.

- When you press **[INPUT SELECT]** on the remote control, the input mode will be switched as below.

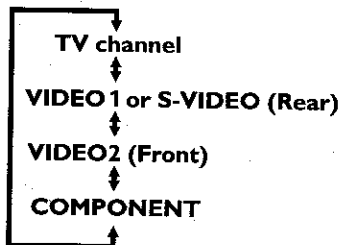

- To use the VIDEO-1 INPUT jacks on the rear of the TV, select "VIDEO1".  
(If you use the S-VIDEO jack, "S-VIDEO" is displayed.)
- To use the jacks on the front of the TV, select "VIDEO2".
- To use the COMPONENT VIDEO INPUT jacks on the rear of the TV, select "COMPONENT".

- When you press **[INFO]**, the current external input mode will be displayed at the top right of the screen.

### 1) When using VIDEO-1 INPUT jack

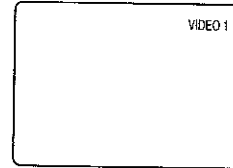

### 2) When using VIDEO-2 INPUT jack

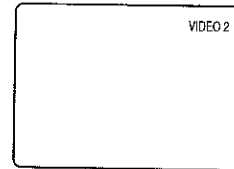

### 3) When using COMPONENT VIDEO INPUT jack

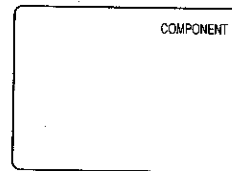

### 4) When using S-VIDEO INPUT jack

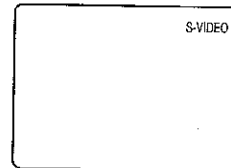

# OPTIONAL SETTINGS

## SLEEP TIMER

The SLEEP TIMER function will automatically turn off the power of the unit at a preset time.

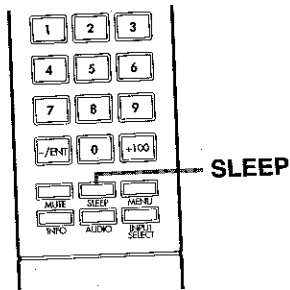

### 1 Use SLEEP TIMER.

- Press [**SLEEP**] on the remote control.
- The setting display for SLEEP TIMER is shown in the screen.

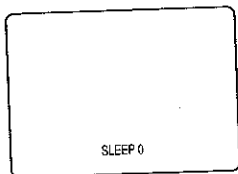

### 2 Set the timer.

- Every time you press [**SLEEP**], the time increases by 10 minutes.
- You can set the timer up to 90 minutes.
- After setting, you can check the remained time per 1 minute by pressing [**SLEEP**].

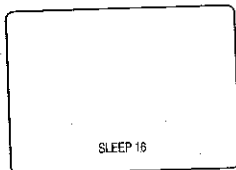

#### NOTES:

- When you disconnect the unit from the AC outlet or when a power failure occurs, the sleep timer setting will be canceled.
- To cancel the sleep timer, press [**SLEEP**] repeatedly until "SLEEP 0" is displayed.
- The Sleep Timer setting display will automatically disappear after 10 seconds.

## MENU SCREEN

This section describes the overview of the menu screen displayed when you press [**MENU**]. For more details, see the reference page for each item.

The menu screen consists of the function setting items below.

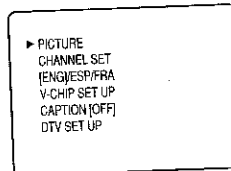

### • PICTURE

You can adjust the picture quality (BRIGHT, CONTRAST, COLOR, TINT, SHARPNESS).

(Refer to "PICTURE ADJUSTMENT" on page 20.)

### • CHANNEL SET

You can automatically scan the receivable channels and add or delete the channel as necessary.

(Refer to "AUTO PRESET CH" on page 28.)

### • ENG/ESP/FRA

You can change the language (ENGLISH, SPANISH, FRENCH) displayed in the menu screen.

(Refer to "LANGUAGE SELECTION" on page 31.)

### • V-CHIP SET UP

You can set the viewing limitations.

(Refer to "V-CHIP" on page 24.)

### • CAPTION

You can change the display format for CLOSED CAPTION, which displays the dialogue of a TV program or other information across the screen.

(Refer to "CLOSED CAPTION" on page 21.)

### • DTV SET UP DTV

You can set the screen display or CAPTION in the DTV mode.

(Refer to "CHANGING THE SCREEN DISPLAY MODE" on page 27.)

#### NOTES:

- "DTV SET UP" can be displayed only in the DTV mode.
- To move to the normal screen, press [**MENU**].

## PICTURE ADJUSTMENT

You can adjust the brightness, contrast, color, tint and sharpness of the picture.

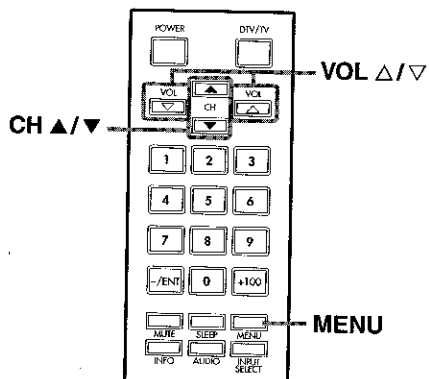

### 1 Display the menu screen.

- Press **[MENU]**.  
The following menu screen is displayed.

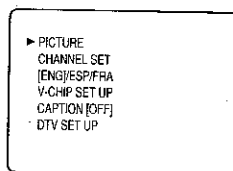

### 2 Select "PICTURE".

- Using **[CH ▲/▼]**, select "PICTURE" and press **[VOL ▲]** to confirm.

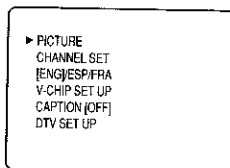

- The adjustment bar for picture quality item is displayed in the screen.

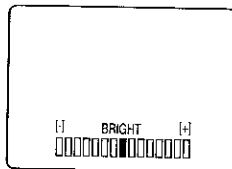

### 3 Adjust the picture quality.

- Using **[CH ▲/▼]**, select the picture quality item you want to adjust.

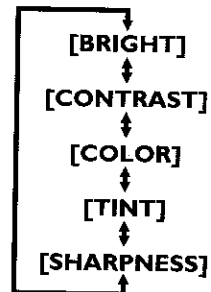

#### BRIGHT

- ▲: To increase brightness
- ▼: To decrease brightness

#### CONTRAST

- ▲: To increase contrast
- ▼: To decrease contrast

#### COLOR

- ▲: To brilliant
- ▼: To pale

#### TINT

- ▲: To green
- ▼: To purple

#### SHARPNESS

- ▲: To clear
- ▼: To soft

- Using **[VOL ▲/▼]**, adjust the picture quality.

#### NOTES:

- The display will disappear automatically after 10 seconds unless you press a button.
- Magnetism from nearby appliances and speakers might affect the color of the TV picture. If this happens, press **[POWER]** to turn off the TV and turn it on again after about 30 minutes.

## CLOSED CAPTION

You can view specially labeled (cc) TV programs, movies, news and prerecorded tapes, etc. with either a dialogue caption or text display added to the program.

You can also change the font size and font style of the caption in the digital broadcasting.

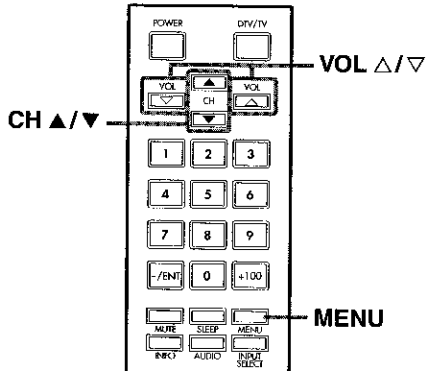

TV

### 1 Display the menu screen.

- Press **[MENU]**.

The following menu screen is displayed.

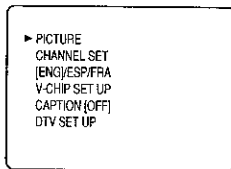

### 2 Select "CAPTION".

- Using **[CH ▲/▼]**, select "CAPTION".

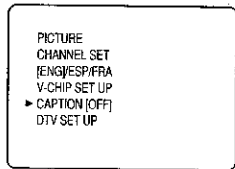

### 3 Switch the CAPTION mode.

- When you press **[VOL Δ/∇]**, CAPTION will be switched as below.

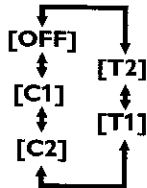

### [CAPTION MODE (C1, C2)]

- **CAPTION1 (C1)**

Displays standard closed captions (what a character is saying).

- **CAPTION2 (C2)**

Displays foreign language closed captions (foreign language words showing what a character is saying).

- There are three display modes according to programs:

**Paint-on mode:** Displays input characters on the screen immediately.

**Pop-on mode :** Once characters are stored in memory, they are displayed all at once.

**Roll-up mode :** Displays the characters continuously by scrolling (max. 4 lines).

### [TEXT MODE (T1, T2)]

- **TEXT1 (T1)** and **TEXT2 (T2)** display half-screen text by scrolling (such as a channel guide, schedule or announcement).

### 4 To exit the menu, press **[MENU]**.

#### NOTES:

- If the closed caption is not broadcasted, nothing is displayed.
- When your TV receives a special effects playback signal (i.e., Search, Slow and Still) from a VCR's video output channel (CH3 or CH4), the TV may not display the correct caption or text.
- Captions and texts may not match the TV voice exactly.
- Interference may cause the closed caption system not to function properly.
- The caption or text characters will not be displayed while the menu display or functions display is shown.
- If a black box appears on the screen, this means that the TV is set to TEXT mode. To clear screen, select CAPTION "C1", "C2" or "OFF".

DTV

### 1 Display the menu screen.

- Press **[MENU]**.

The following menu screen is displayed.

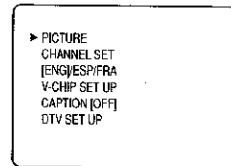

**2** Select "DTV SET UP".

- Using [CH ▲/▼], select "DTV SET UP".

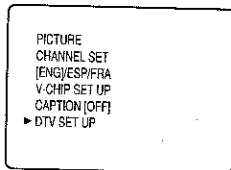

- Press [VOL Δ].  
The following screen is displayed.

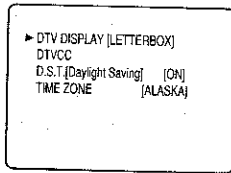

**3** Select "DTVCC".

- Using [CH ▲/▼], select "DTVCC".

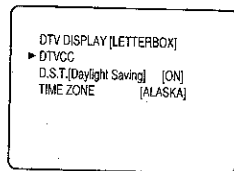

- Press [VOL Δ].  
The following screen is displayed.

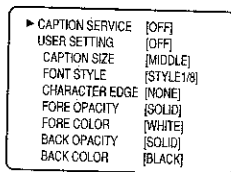

**4** Select "CAPTION SERVICE".

- When you press [VOL Δ/▼], you can switch CAPTION as below. Select CAPTION SERVICE you want to use.

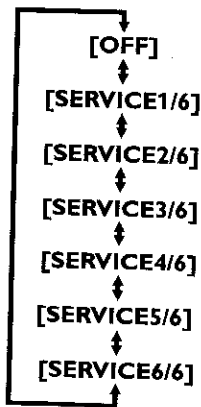

**NOTE:**

CAPTION SERVICE you can switch differs depending on the broadcast description.

**5** Use "USER SETTING".

- The "USER SETTING" function lets you change the caption size and font style.
- Using [CH ▲/▼], select "USER SETTING".

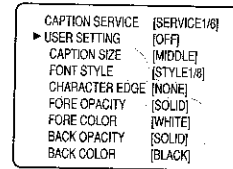

- Press [VOL Δ] and set "USER SETTING" to "ON".

**6** Set each item.

- When "USER SETTING" is set to "ON", you can set the following items.

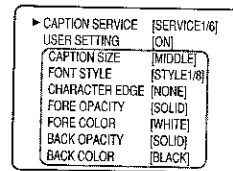

- Using [CH ▲/▼], select the item you want to set.
- You can switch the setting for each item with [VOL Δ/▼].
- The setting description for each item is shown below.

**[CAPTION SIZE]**

Text size of the displayed caption can be switched as below.

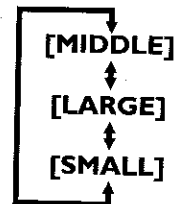

### [FONT STYLE]

Font style of the displayed caption can be switched as below.

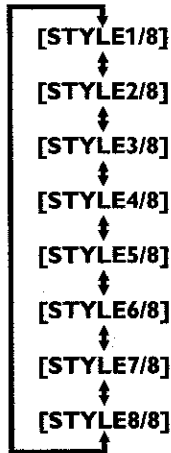

### [CHARACTER EDGE]

Text edging of the displayed caption can be switched as below.

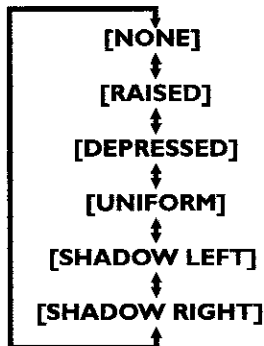

### [FORE OPACITY]

Text opacity of the displayed caption can be switched as below.

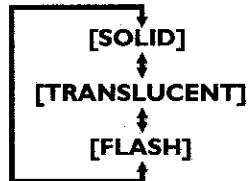

### [FORE COLOR]

Text color of the displayed caption can be switched as below.

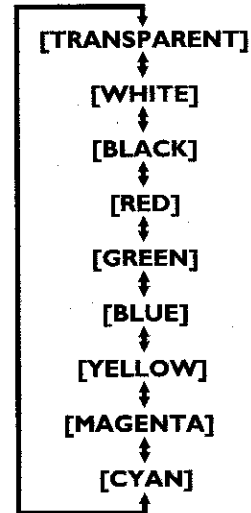

### [BACK OPACITY]

Background opacity of the displayed caption can be switched as below.

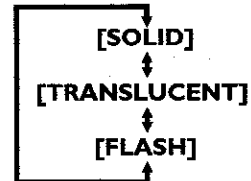

### [BACK COLOR]

Background color of the displayed caption can be switched as below.

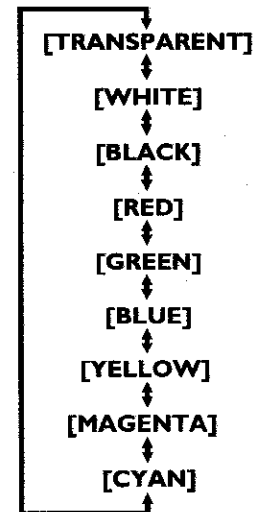

## V-CHIP

You can set the viewing limitations to prevent your children from watching inappropriate programs including disagreeable expression and description. The viewing limitations set for the program can be released by entering the access code.

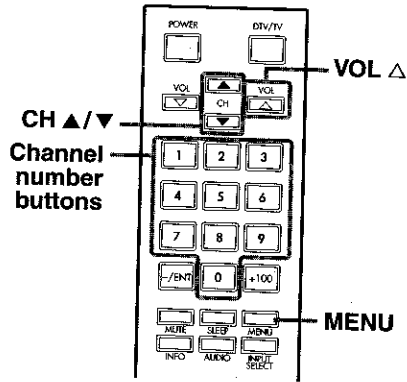

### 1 Display the menu screen.

- Press **[MENU]**.  
The following menu screen is displayed.

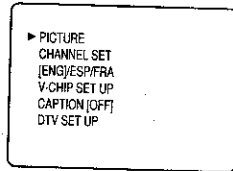

### 2 Select "V-CHIP SET UP".

- Using **[CH ▲/▼]**, select "V-CHIP SET UP".

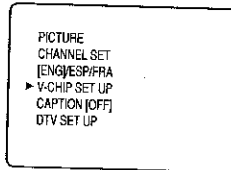

- Press **[VOL Δ]**.  
The access code entry screen is displayed.

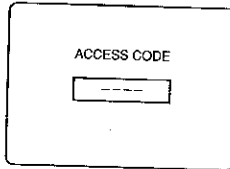

### 3 Enter the access code.

- Use **Channel number** buttons and enter the 4-digit number.
- When you have not set up your access code, enter 0000.
- When the access code is correct, the following "V-CHIP SET UP" screen is displayed.

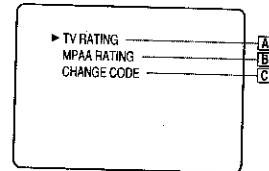

See the following description for setting each item.

### A TV RATING

### 4 Display the "TV RATING" screen.

- Using **[CH ▲/▼]**, select "TV RATING".  
Press **[VOL Δ]**.

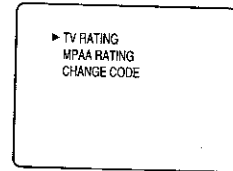

### 5 Set "TV RATING".

- Using **[CH ▲/▼]**, select the rating.

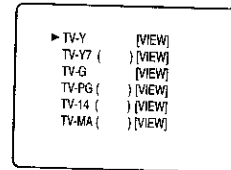

<Selection>	<Rating Category Explanations>
• TV-Y :	Appropriate for all children
• TV-Y7 :	Appropriate for children seven and older
• TV-G :	General Audience
• TV-PG :	Parental Guidance suggested
• TV-14 :	Unsuitable for children under 14
• TV-MA :	Mature audience only



**6** Set "BLOCK" or "VIEW".

- Press [VOL Δ] and set to "BLOCK" or "VIEW" for the rating without sub categories.

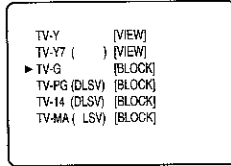

- For the rating with sub categories, they are displayed by pressing [VOL Δ] twice. Press [CH ▲/▼] and select the rating. Then press [VOL Δ] and set to "BLOCK" or "VIEW".

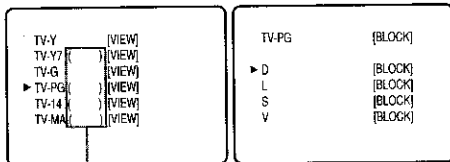

Sub categories

<Selection>	<Rating Category Explanations>
• TV-Y7	
FV :	Fantasy Violence
• TV-PG / TV-14 / TV-MA :	
D :	Suggestive Dialog (TV-PG, TV-14 only)
L :	Coarse Language
S :	Sexual Situation
V :	Violence

**7** To exit the menu, press [MENU].

**B** MPAA RATING

**4** Display the "MPAA RATING" screen.

- Using [CH ▲/▼], select "MPAA RATING".
- Press [VOL Δ].

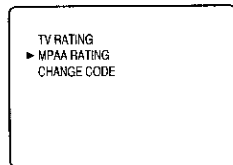

**5** Set "MPAA RATING".

- Using the [CH ▲/▼], select the rating.

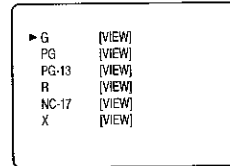

<Selection>	<Rating Category Explanations>
• G :	General Audience
• PG :	Parental Guidance suggested
• PG-13 :	Unsuitable for children under 13
• R :	Restricted; under 17 requires accompanying parent or adult guardian
• NC-17 :	No one under 17 admitted
• X :	Mature audience only

**6** Set "BLOCK" or "VIEW".

- Press [VOL Δ] and set to "BLOCK" or "VIEW".

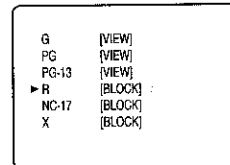

**7** To exit the menu, press [MENU].

**NOTES:**

for TV RATING and MPAA RATING

- You cannot access the setup menu when the "PROTECTED PROGRAM by ..." message appears. You need to move to an unblocked channel to access the setup menu.
- When you select a rating and set it to "BLOCK", the higher ratings will be blocked automatically. The lower ratings will be available for viewing.
- When you set the lowest rating to "VIEW", all other ratings will automatically be available for viewing.

---

## C CHANGE CODE

---

4 Display the "CHANGE CODE" screen.

- Using [CH ▲/▼], select "CHANGE CODE".

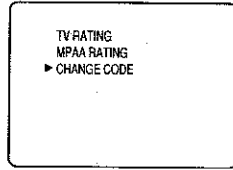

- Press [VOL Δ].

5 Change the access code.

- Use **Channel number** buttons on the remote control and enter the NEW CODE (4-digit).
- Enter code again in CONFIRM CODE box.

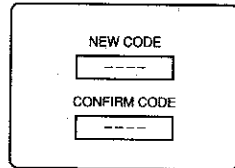

6 To exit the menu, press [MENU].

### NOTES:

- Make sure to enter the exact same new code in the "CONFIRM CODE" space as one in the "NEW CODE" space. If they are different, the "NEW CODE" space is cleared for reentering.
- Your personal access code will be erased and return to the default (0000) when a power failure occurs or when you turn off the power using a wall switch. If you forget the code, unplug the power cord for 10 seconds to restore the access code to 0000.

## CHANGING THE SCREEN DISPLAY MODE

2 types of display modes can be selected in the digital mode.

You can select your favorite display mode and enjoy the program.

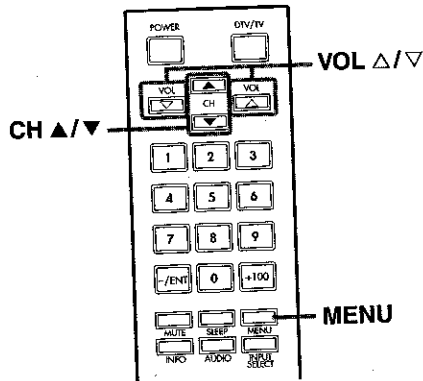

### 1 Display the menu screen.

- Press **[MENU]**.  
The following menu screen is displayed.

```

▶ PICTURE
CHANNEL SET
[ENG]/[ESP]/[FRA]
V-CHIP SET UP
CAPTION [OFF]
DTV SET UP
  
```

### 2 Select "DTV SET UP".

- Using **[CH ▲/▼]**, select "DTV SET UP".

```

PICTURE
CHANNEL SET
[ENG]/[ESP]/[FRA]
V-CHIP SET UP
CAPTION [OFF]
▶ DTV SET UP
  
```

- When you press **[VOL Δ]**, the menu screen will be displayed as below.

```

▶ DTV DISPLAY [LETTERBOX]
DTVCC
D.S.T. [Daylight Saving] [ON]
TIME ZONE [ALASKA]
  
```

### 3 Select the display mode.

- Every time you press **[VOL Δ/∇]**, "LETTERBOX" and "ZOOM" will be switched alternately.

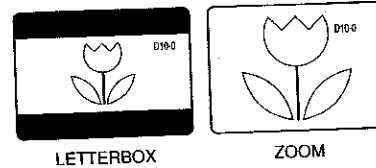

#### [LETTERBOX]

Display the digital-supported program in full-screen.

Black borders will spread in the upper and lower screen.

#### [ZOOM]

Enlarge and display the center area of the digital-supported program.

The right and left side of image will be cut off.

### 4 To exit the menu, press **[MENU]**.

#### NOTE:

You may not switch the display mode depending on the program.

# OTHER SETTINGS

## AUTO PRESET CH

If you switch wires (e.g. between antenna and CATV) or if you move the TV to a different area after the initial setting, or if you need to add the DTV channel you deleted, you will need to perform AUTO PRESET CH again. This function lets you easily select the receivable channels with [CH ▲/▼] and the TV memorizes them even if you switch wires.

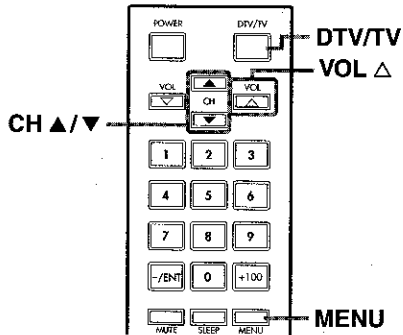

### NOTE:

- Make sure if the TV is connected to antenna or cable. When aerial antenna is connected, select "AUTO PRESET CH (TV)" or "(TV/DTV)" at step 4. When connected to CATV, select "AUTO PRESET CH (CATV)".

## TV

When scanning TV or CATV

**1** Select analog mode by pressing [DTV/TV].

**2** Display the menu screen.

- Press [MENU].  
The following menu screen is displayed.

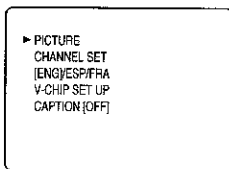

**3** Select "CHANNEL SET".

- Using [CH ▲/▼], select "CHANNEL SET".

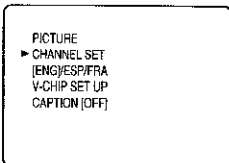

- Press [VOL Δ].

**4** For TV channels

- Using [CH ▲/▼], select "AUTO PRESET CH(TV)".

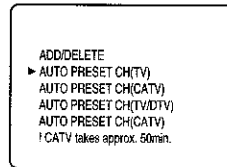

- Press [VOL Δ].  
Scanning and memorizing the channels automatically starts.

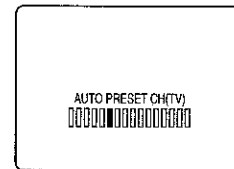

- When the scanning and memorizing are completed, the memorized smallest channel in the analog broadcasting will be displayed.

**4** For CATV channels

- Using [CH ▲/▼], select "AUTO PRESET CH(CATV)".

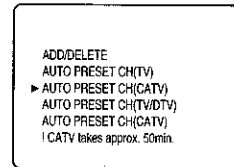

- Press [VOL Δ].  
Scanning and memorizing the channels automatically starts.



- When the scanning and memorizing are completed, the memorized smallest channel in the CATV will be displayed.

When scanning DTV

- 1 Select digital mode by pressing [DTV/TV].
- 2 Display the menu screen.
  - Press [MENU].

The following menu screen is displayed.

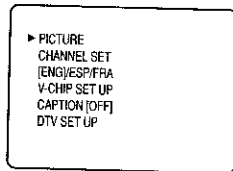

- 3 Select "CHANNEL SET".
  - Using [CH ▲/▼], select "CHANNEL SET".

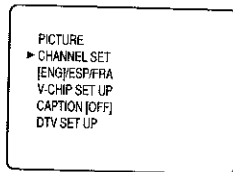

- Press [VOL Δ].

- 4 Using [CH ▲/▼], select "AUTO PRESET CH(DTV)".

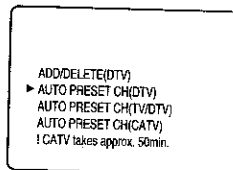

- Press [VOL Δ].
- Scanning and memorizing the channels automatically starts.

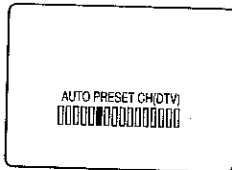

- When the scanning and memorizing are completed, the memorized smallest channel in the digital broadcasting will be displayed.

When scanning both TV and DTV at the same time

\* You can access this menu from both modes (analog / digital).

- 1 Display the menu screen and select "CHANNEL SET".
  - Press [MENU] and select "CHANNEL SET" using [CH ▲/▼].

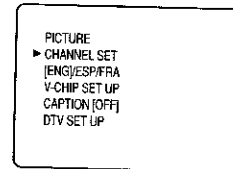

- Press [VOL Δ].

- 2 Using [CH ▲/▼], select "AUTO PRESET CH(TV/DTV)".

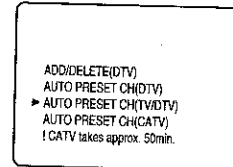

- Press [VOL Δ].
- Scanning and memorizing the channels automatically starts.

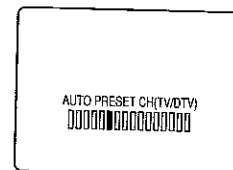

- When the scanning and memorizing are completed, the memorized smallest channel in the analog broadcasting will be displayed. If no analog channel is memorized, the memorized smallest channel in the digital broadcasting will be displayed.

**NOTES:**

- If you press [POWER] or [MENU] while setting AUTO PRESET CH, AUTO PRESET CH setting will be canceled.
- If there is no TV signal input, "NO TV SIGNALS" will appear on the display after the completion of channel scanning.

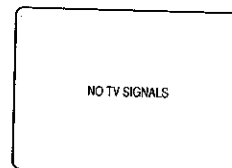

## CHANNEL ADD/DELETE

The CHANNEL ADD/DELETE function lets you add the channel that was not added by the AUTO PRESET CH function due to the bad reception status at the initial setting. You can also delete the unnecessary channels.

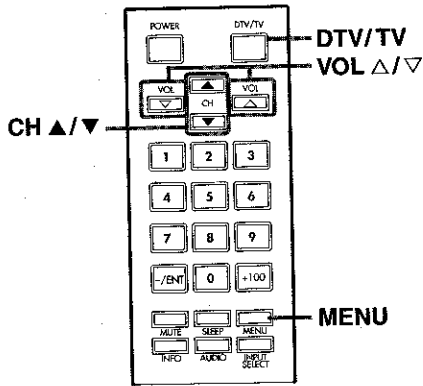

TV

**1** Select analog mode by pressing [DTV/TV].

**2** Display the menu screen.

- Press [MENU].  
The following menu screen is displayed.

```

▶ PICTURE
CHANNEL SET
[ENG]/ESP/FRA
V-CHIP SET UP
CAPTION [OFF]
    
```

**3** Select "CHANNEL SET".

- Using [CH ▲/▼], select "CHANNEL SET".

```

PICTURE
▶ CHANNEL SET
[ENG]/ESP/FRA
V-CHIP SET UP
CAPTION [OFF]
    
```

- Press [VOL Δ].  
The following CHANNEL SET screen is displayed.

```

▶ ADD/DELETE
AUTO PRESET CH(TV)
AUTO PRESET CH(CATV)
AUTO PRESET CH(TV/DTV)
AUTO PRESET CH(CATV)
! CATV takes approx. 50min.
    
```

**4** Select "ADD/DELETE".

- Using [CH ▲/▼], select "ADD/DELETE".

```

▶ ADD/DELETE
AUTO PRESET CH(TV)
AUTO PRESET CH(CATV)
AUTO PRESET CH(TV/DTV)
AUTO PRESET CH(CATV)
! CATV takes approx. 50min.
    
```

- Press [VOL Δ].

**5** Select the channel you want to add or delete.

- Using [CH ▲/▼] or Channel number buttons, select the channel.

```

15
ADD/DELETE-TV
    
```

- Select "ADD" or "DELETE" with [VOL Δ/∇].

### NOTE:

- Color of channel number displayed at the right top of the screen;  
-Blue/Green: The selected channel will be added.  
-Pink/Red: The selected channel will be deleted.

**6** To exit the menu, press [MENU].

DTV

**1** Select digital mode by pressing [DTV/TV].

**2** Display the menu screen.

- Press [MENU].  
The following menu screen is displayed.

```

▶ PICTURE
CHANNEL SET
[ENG]/ESP/FRA
V-CHIP SET UP
CAPTION [OFF]
DTV SET UP
    
```

**3** Select "CHANNEL SET".

- Using [CH ▲/▼], select "CHANNEL SET".

```

PICTURE
▶ CHANNEL SET
[ENG]/ESP/FRA
V-CHIP SET UP
CAPTION [OFF]
DTV SET UP
    
```

- Press [VOL Δ].

#### 4 Select "ADD/DELETE(DTV)".

- Using [CH ▲/▼], select "ADD/DELETE(DTV)".

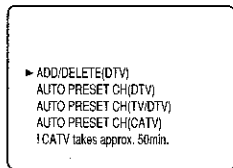

- Press [VOL Δ].

#### 5 Select the channel you want to add or delete.

- Using [CH ▲/▼] or **Channel number** buttons, select the channel.

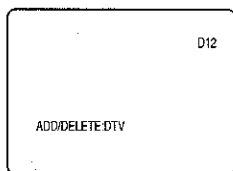

- Select "ADD" or "DELETE" with [VOL Δ/▽].

#### NOTE:

- **Color of channel number displayed at the right top of the screen;**
  - Blue/Green: The selected channel will be added.
  - Pink/Red: The selected channel will be deleted.

#### 6 To exit the menu, press [MENU].

#### NOTES:

- The menu will disappear automatically after about 10 seconds.
- In the digital mode (DTV), you can add or delete channels only for Major channel.
- Once you delete a DTV channel, you cannot add the channel again without performing AUTO PRESET CH again. (Refer to "AUTO PRESET CH" on page 28.)

## LANGUAGE SELECTION

You can change the language used on the menu screen. ENGLISH, SPANISH or FRENCH can be selected.

How to change the language in the menu screen shown below.

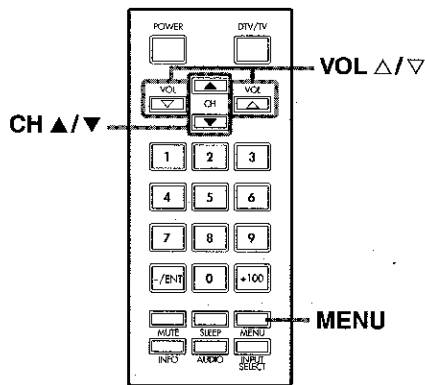

#### 1 Display the menu screen.

- Press [MENU].  
The following menu screen is displayed.

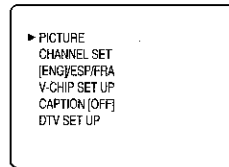

#### 2 Select "[ENG]/ESP/FRA".

- Using [CH ▲/▼], select "[ENG]/ESP/FRA".

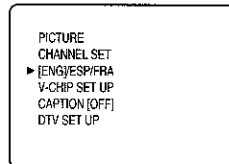

- Every time you press [VOL ▲/▼], the language will be switched as below. Select the language.

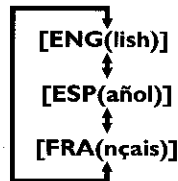

#### 3 To exit the menu, press [MENU].

## D.S.T.

After the initial setting you set when you first turned on the power, you can set the D.S.T. (Daylight Saving Time) again. When you set this function to ON, the clock will automatically move forward one hour at 2:00 a.m on the first Sunday in April and move back one hour at 2:00 a.m on the last Sunday in October.

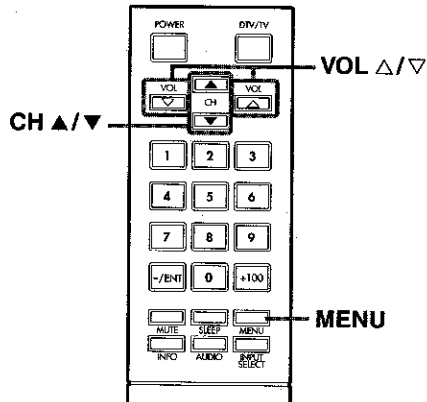

### 1 Display the menu screen.

- Press **[MENU]**.  
The following menu screen is displayed.

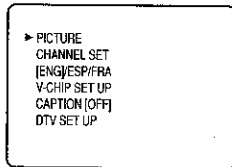

### 2 Select "DTV SET UP".

- Using **[CH ▲/▼]**, select "DTV SET UP".

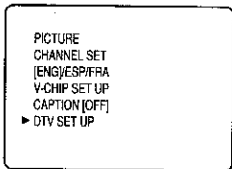

- When you press **[VOL ▲]**, the following menu screen is displayed.

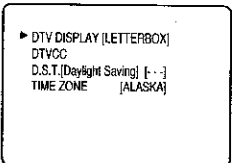

### 3 Select "D.S.T. (Daylight Saving)".

- Using **[CH ▲/▼]**, select "D.S.T. (Daylight Saving)".

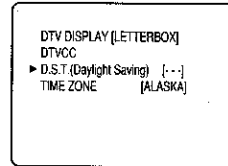

### 4 Set "D.S.T. (Daylight Saving)".

- Using **[VOL ▲/▼]**, set to "ON" or "OFF".

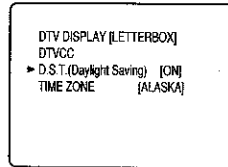

### 5 To exit the menu, press **[MENU]**.

#### NOTE:

When you set D.S.T. to "OFF", the date and time information adjusted for the area set by "TIME ZONE" is displayed.



## TIME ZONE

If you move the TV to a different area after the initial setting you set when you first turned on the power, you can set the area again.

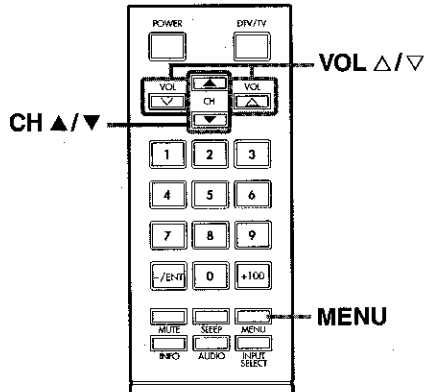

### 1 Display the menu screen.

- Press **[MENU]**.  
The following menu screen is displayed.

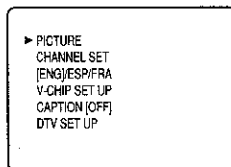

### 2 Select "DTV SET UP".

- Using **[CH ▲/▼]**, select "DTV SET UP".

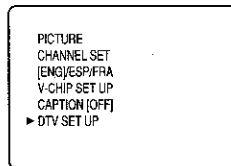

- When you press **[VOL ▲]**, the following menu screen is displayed.

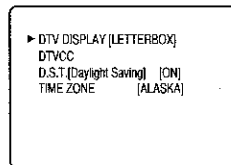

### 3 Select "TIME ZONE".

- Using **[CH ▲/▼]**, select "TIME ZONE".

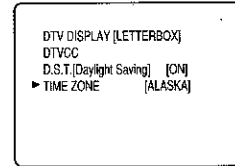

### 4 Select your "TIME ZONE".

- When you use **[VOL ▲/▼]**, the TIME ZONE will be switched as below.

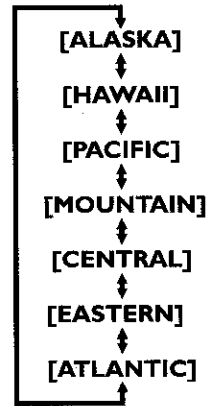

- Based on the world standard time information acquired from digital broadcasting, the time difference will be adjusted as below.

ALASKA	-9 hours
HAWAII	-10 hours
PACIFIC	-8 hours
MOUNTAIN	-7 hours
CENTRAL	-6 hours
EASTERN	-5 hours
ATLANTIC	-4 hours

### 5 To exit the menu, press **[MENU]**.

# MISCELLANEOUS

## TROUBLESHOOTING GUIDE

Before calling for service, check the following chart again.

Symptom	Remedy
No power	<ul style="list-style-type: none"><li>• Be sure the Power cord is connected to outlet.</li><li>• If a power failure occurs, unplug the power cord for 30 minutes to allow the unit to reset itself.</li></ul>
No picture or sound	<ul style="list-style-type: none"><li>• Check if the power is on.</li><li>• Check the outlet connection.</li><li>• Check the antenna or cable connection to the main unit.</li><li>• When the outside antenna is used, check the wire condition and connection.</li><li>• Try to view other channels. It may be the problem on the broadcasting station.</li><li>• Turn off the power and wait for about 1 minute, then turn it on again.</li></ul>
No color	<ul style="list-style-type: none"><li>• Check the antenna or cable connection to the main unit.</li><li>• When the outside antenna is used, check the wire condition and connection.</li><li>• Try to view other channels. It may be the problem on the broadcasting station.</li><li>• Adjust the color in the MENU screen.</li></ul>
Sound OK, Picture Poor	<ul style="list-style-type: none"><li>• Check the antenna or cable connection to the main unit.</li><li>• When the outside antenna is used, check the wire condition and connection.</li><li>• Electric waves may be interfered due to the electric appliances, etc. nearby.</li><li>• Adjust CONTRAST and BRIGHT in the MENU screen.</li><li>• Try to view other channels. It may be the problem on the broadcasting station.</li></ul>
Picture Distorted	<ul style="list-style-type: none"><li>• When the outside antenna is used, check the wire condition and connection.</li><li>• Try to view other channels. It may be the problem on the broadcasting station.</li></ul>
Weak Picture	<ul style="list-style-type: none"><li>• Check the antenna or cable connection to the main unit.</li><li>• When the outside antenna is used, check the wire condition and connection.</li><li>• Adjust CONTRAST and BRIGHT in the MENU screen.</li><li>• Try to view other channels. It may be the problem on the broadcasting station.</li></ul>
Lines or Streaks in Picture	<ul style="list-style-type: none"><li>• When the outside antenna is used, check the wire condition and connection.</li><li>• Electric waves may be interfered due to the electric appliances, etc. nearby.</li><li>• Try to view other channels. It may be the problem on the broadcasting station.</li></ul>
Picture blurred	<ul style="list-style-type: none"><li>• When the outside antenna is used, check the wire condition and connection.</li><li>• Try to view other channels. It may be the problem on the broadcasting station.</li></ul>
Ghosts in picture	<ul style="list-style-type: none"><li>• Check the antenna or cable connection to the main unit.</li><li>• When the outside antenna is used, check the wire condition and connection.</li><li>• Electric waves may be interfered due to the electric appliances, etc. nearby.</li><li>• Try to view other channels. It may be the problem on the broadcasting station.</li></ul>

Symptom	Remedy
Bars on screen	<ul style="list-style-type: none"> <li>• When the outside antenna is used, check the wire condition and connection.</li> <li>• Electric waves may be interfered due to the electric appliances, etc. nearby.</li> </ul>
Picture rolls vertically	<ul style="list-style-type: none"> <li>• When the outside antenna is used, check the wire condition and connection.</li> <li>• Electric waves may be interfered due to the electric appliances, etc. nearby.</li> <li>• Try to view other channels. It may be the problem on the broadcasting station.</li> </ul>
Different color marks on screen	<ul style="list-style-type: none"> <li>• Move the TV apart from electric appliances nearby. Turn off the power and wait for about 30 minutes, then turn it on again.</li> <li>• Try to view other channels. It may be the problem on the broadcasting station.</li> </ul>
Poor reception on some channels	<ul style="list-style-type: none"> <li>• Check the antenna or cable connection to the main unit.</li> <li>• When the outside antenna is used, check the wire condition and connection.</li> <li>• Electric waves may be interfered due to the electric appliances, etc. nearby.</li> <li>• Try to view other channels. It may be the problem on the broadcasting station.</li> </ul>
Picture OK, sound poor	<ul style="list-style-type: none"> <li>• Electric waves may be interfered due to the electric appliances, etc. nearby.</li> <li>• Try to view other channels. It may be the problem on the broadcasting station.</li> </ul>
Remote control doesn't work	<ul style="list-style-type: none"> <li>• Check the antenna or cable connection to the main unit.</li> <li>• Check the battery life of the remote control.</li> <li>• Check if there is an obstacle between the sensor and the remote control.</li> <li>• Test the signal output. If OK, then possible remote sensor trouble. (Refer to "IR SIGNAL CHECK" on page 36.)</li> </ul>
<b>Problems on Closed Caption</b>	
Misspelled captions are displayed.	<ul style="list-style-type: none"> <li>• Closed captioning production companies may broadcast programs without correcting the misspelling in a live broadcast.</li> </ul>
Captions are not entirely displayed, or captions are delayed behind the dialogue.	<ul style="list-style-type: none"> <li>• Captions that are delayed a few seconds behind the actual dialogue are common for live broadcasts. Most captioning production companies can display a dialogue to a maximum of 220 words per minute. If a dialogue exceeds that rate, selective editing is used to insure that the captions remain up-to-date with the current TV screen dialogue.</li> </ul>
Captions are displayed as a white box. No caption is displayed in the Closed Caption-supported program.	<ul style="list-style-type: none"> <li>• When electric waves are interfered due to buildings, weather conditions etc., incomplete captions may be displayed.</li> <li>• Broadcasting station may shorten the program to insert the advertisement. The closed caption decoder cannot read the information of the shortened program.</li> </ul>
No caption is displayed when playing the videotape containing captions.	<ul style="list-style-type: none"> <li>• The videotape may be illegally copied, or the caption signal may fail to be read while coping.</li> </ul>
Black box is displayed in the screen.	<ul style="list-style-type: none"> <li>• [TEXT] mode is selected for caption. Select [C1], [C2] or [OFF].</li> </ul>

MISCELLANEOUS

## GLOSSARY

### ATSC

Acronym that stands for Advanced Television Systems Committee and the name of the digital broadcasting standard in the United States.

### High Definition TV (HDTV)

Ultimate digital format that produces high resolution and high picture quality.

### Letterbox

Letterbox refers to the format displaying a wide-screen picture on a standard 4:3 aspect ratio television screen with black bars above and below. It is used to maintain the aspect ratio of the original source such as a motion picture (16:9 or wider).

### NTSC

Acronym that stands for National Television Systems Committee and the name of the current analog broadcasting standard used in the United States.

### SAP

#### (Secondary Audio Program)

Second-audio channel delivered separately from main-audio channel. This audio channel is used as an alternate in bilingual broadcasting.

### Standard Definition TV (SDTV)

Standard digital format that is similar to the NTSC picture quality.

### S-Video output

It delivers independently each signal of color(C) and luminance (Y) to TV as video signals, so that higher-quality picture will be gained.

## MAINTENANCE

### CABINET CLEANING

- Wipe the front panel and other exterior surfaces of the TV with a soft cloth immersed in lukewarm water and wrung dry.
- Never use a solvent or alcohol. Do not spray insecticide liquid near the TV. Such chemicals may cause damage and discoloration to the exposed surfaces.

### PICTURE TUBE CLEANING

- Wipe the picture tube of the TV with a soft cloth. Before cleaning the picture tube, disconnect the power cord.

### SERVICING

- Should your unit become inoperative, do not try to correct the problem by yourself. There are no userserviceable parts inside. Turn off, unplug the power cord and please call our help line mentioned on the front page, to locate an Authorized Service Center.

### IR SIGNAL CHECK

If the remote control doesn't work properly, You can test if the remote control sends out the infrared signal with AM radio or a digital camera (including built-in camera of cellular phone). It will help to define the cause of malfunction.

#### • With an AM radio:

Tune a AM radio to a band with no broadcasting. Press a button on remote control toward the radio. Sound will be fluttering when you press any key and the radio receives the signal. This means the remote control unit is working.

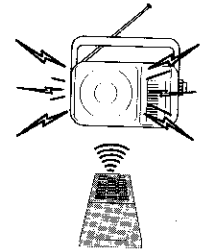

#### • With a digital camera (including built-in camera of cellular phone):

Direct a digital camera to remote control, press and hold a button on remote control. If infrared light appears through digital camera, the remote is working.



# SPECIFICATIONS

## GENERAL SPECIFICATIONS

Television system:	NTSC-M TV Standard
Closed Caption System:	§15.119/FCC
Channel coverage	
VHF:	2 ~ 13
UHF:	14 ~ 69
DTV:	2 ~ 69
CATV:	2 ~ 13, A ~ W, W+1 ~ W+84, A-5 ~ A-1, 5A
Tuning System	Channel frequency synthesized tuning system
Channel access:	Direct access keyboard, programmable scan and up/down
Terminals	
Antenna input:	VHF/UHF/DTV/CATV 75 ohm unbalanced (F-type)
S-Video input:	Mini DIN 4-pin jack
Video input:	RCA connector x 2 (1 x Front / 1 x Rear)
Audio input:	RCA connector x 4 (2 (L/R) x Front / 2 (L/R) x Rear)
Coaxial digital audio output:	One pin jack, 500mVpp (75 ohm)
Component Video/Audio input	
One pin jack (Y) / 1Vpp (75 ohm)	
Two pin jacks (Cb/Cr) / 700mVpp (75 ohm)	
RCA connector x 2 (L/R)	
Stereo Sound System	
2 speakers	

## ELECTRICAL SPECIFICATIONS

Sound output: 2W, 8 ohm x 2

## OTHER SPECIFICATIONS

Remote control:	Digital encoded infrared light system
Operating temperature:	5°C to 40°C (41°F to 104°F)
Power requirements:	AC120V, 60Hz
Power consumption (Maximum):	140W
Picture tube:	32"
Dimensions:	H : 26-3/16" (665mm) W : 33-7/16" (849mm) D : 21-1/4" (540mm)
Weight:	112.4 lbs. (51kg)

SPECIFICATIONS

- Designs and specifications are subject to change without notice and without our legal obligation.
- If there is a discrepancy between languages, the default language will be English.

**ilo**  
**LIMITED WARRANTY**

FUNAI CORP. will repair this product, free of charge in the USA in the event of defect in materials or workmanship as follows:

**DURATION:**

**PARTS:** FUNAI CORP. will provide parts to replace defective parts without charge for one (1) year from the date of original retail purchase. Two (2) years for Picture Tube. Certain parts are excluded from this warranty.

**LABOR:** FUNAI CORP. will provide the labor without charge for a period of ninety (90) days from the date of original retail purchase.

**LIMITS AND EXCLUSIONS:**

THIS WARRANTY IS EXTENDED ONLY TO THE ORIGINAL RETAIL PURCHASER. A PURCHASE RECEIPT OR OTHER PROOF OF ORIGINAL RETAIL PURCHASE WILL BE REQUIRED TOGETHER WITH THE PRODUCT TO OBTAIN SERVICE UNDER THIS WARRANTY.

This warranty shall not be extended to any other person or transferee.

This warranty is void and of no effect if any serial numbers on the product are altered, replaced, defaced, missing or if service was attempted by an unauthorized service center. This limited warranty does not apply to any product not purchased and used in the United States.

This warranty only covers failures due to defects in material or workmanship which occurs during normal use. It does not cover damage which occurs in shipment, failures which are caused by repairs, alterations or product not supplied by FUNAI CORP., or damage which results from accident, misuse, abuse, mishandling, misapplication, alteration, faulty installation, improper maintenance, commercial use such as hotel, rental or office use of this product or damage which results from fire, flood, lightning or other acts of God.

THIS WARRANTY DOES NOT COVER PACKING MATERIALS, ANY ACCESSORIES (EXCEPT REMOTE CONTROL), ANY COSMETIC PARTS, COMPLETE ASSEMBLY PARTS, DEMO OR FLOOR MODELS.

FUNAI CORP. AND ITS REPRESENTATIVES OR AGENTS SHALL IN NO EVENT BE LIABLE FOR ANY GENERAL, INDIRECT OR CONSEQUENTIAL DAMAGES ARISING OUT OF OR OCCASIONED BY THE USE OF OR THE INABILITY TO USE THIS PRODUCT. THIS WARRANTY IS MADE IN LIEU OF ALL OTHER WARRANTIES, EXPRESS OR IMPLIED, AND OF ALL OTHER LIABILITIES ON THE PART OF FUNAI, ALL OTHER WARRANTIES INCLUDING THE WARRANTY OF MERCHANTABILITY AND FITNESS FOR A PARTICULAR PURPOSE, ARE HEREBY DISCLAIMED BY FUNAI AND ITS REPRESENTATIVES IN THE UNITED STATES.

ALL WARRANTY INSPECTIONS AND REPAIRS MUST BE PERFORMED BY AN AUTHORIZED SERVICE CENTER. THIS WARRANTY IS ONLY VALID WHEN THE UNIT IS CARRIED-IN TO AN AUTHORIZED SERVICE CENTER.

THE PRODUCT MUST BE ACCOMPANIED BY A COPY OF THE ORIGINAL RETAIL PURCHASE RECEIPT. IF NO PROOF OF PURCHASE IS ATTACHED, THE WARRANTY WILL NOT BE HONORED AND REPAIRS COSTS WILL BE CHARGED.

**IMPORTANT:**

THIS LIMITED WARRANTY GIVES YOU SPECIFIC LEGAL RIGHTS. YOU MAY HAVE OTHER RIGHTS THAT VARY FROM STATE TO STATE. IF, AT ANY TIME DURING THE WARRANTY PERIOD, YOU ARE UNABLE TO OBTAIN SATISFACTION WITH THE REPAIR OF THIS PRODUCT, PLEASE CONTACT FUNAI CORP.

**ATTENTION:**

FUNAI CORP. RESERVES THE RIGHT TO MODIFY ANY DESIGN OF THIS PRODUCT WITHOUT PRIOR NOTICE.

**WARRANTY STATEMENT REGARDING NON AUTHORIZED REPAIRS:**

To obtain warranty service, you must take the product, or deliver the product freight prepaid, in either its original packaging or packaging affording an equal degree of protection, to any AUTHORIZED SERVICE CENTER. FUNAI CORP. will not reimburse you for any service done by unauthorized service providers without prior written approval.

To locate your nearest AUTHORIZED SERVICE CENTER or for general service inquiries, please contact us at :

FUNAI CORPORATION  
Customer Service  
Tel :1-800-474-0045  
<http://www.funai-corp.com>  
19900 Van Ness Avenue, Torrance, CA 90501