

JVC

ENGLISH

HARD DISK CAMCORDER

GZ-MG70U

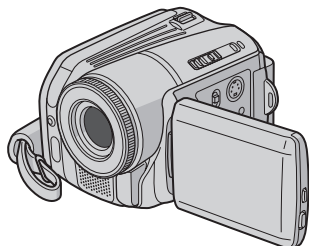

GETTING STARTED 7

VIDEO RECORDING & PLAYBACK 22

STILL IMAGE RECORDING & PLAYBACK 28

ADVANCED OPERATIONS 31

MENU SETTINGS 48

REFERENCES 52

To deactivate the demonstration, set "DEMO MODE" to "OFF".
(▶ pg. 48)

For Customer Use:
Enter below the Model No.
(located on the bottom of the camera) and Serial No. (located on the battery pack mount of the camera). Retain this information for future reference.

Model No. _____

Serial No. _____

INSTRUCTIONS

LYT1493-001B

EN

Major Features of this Camera

Built-in Hard Disk

This hard disk camera records images to a large, built-in hard disk drive (HDD) instead of a DV tape like conventional video cameras. This enables extended hours of high-resolution, MPEG2 video recording.

Various Recording Modes

You can select the most suitable recording mode for picture quality, image size, recording time, and computer environment. (☞ pg. 62)

Enjoying Various Playback Features

Unlike tape operation, playback is simple and easy in this camera since no time is needed for rewinding or fast forward operations.

Playlist, playback effects, and other functions are also available for enjoying many different types of playback.

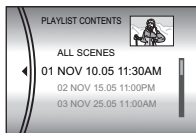

Editing Files on your PC

USB 2.0 enables the smooth transfer of video and still images to a computer. With the bundled image editing software, you can easily edit video and create your own DVDs. (Refer to "Read this first!" and the software installation and USB connection guide.)



Flash

You can record still images in dark places more easily. The flash fires automatically during still image recording. (☞ pg. 31)

Direct Printing

If your printer is compatible with PictBridge, still images can be printed easily by connecting the camera with USB cable directly to the printer. (☞ pg. 47)

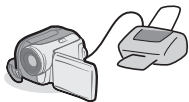

Contents

GETTING STARTED 7

| | |
|--|----|
| Provided Accessories | 7 |
| Index | 10 |
| Power | 14 |
| Operation Mode | 16 |
| Language Setting | 17 |
| Date/Time Settings | 18 |
| Brightness Adjustment of the Display | 18 |
| Grip Adjustment | 19 |
| Tripod Mounting | 19 |
| Inserting/Removing an SD Card | 19 |
| Formatting a Recording Medium | 20 |
| Selecting a Recording Medium | 21 |
| Remaining Space on the Recording Media | 21 |
| Drop Detection | 21 |

VIDEO RECORDING & PLAYBACK 22

| | |
|---|----|
| Video Recording | 22 |
| Zooming | 23 |
| Video Playback | 24 |
| How to Use the Scroll Bar | 25 |
| Date Index Screen | 25 |
| Various Playback Operations | 25 |
| Playback Zoom | 25 |
| Connecting to a TV, VCR or DVD Recorder | 26 |
| Playback on a TV | 26 |
| Dubbing to a VCR (or DVD Recorder) | 26 |
| Playback Using the Remote Control | 27 |

STILL IMAGE RECORDING & PLAYBACK 28

| | |
|---|----|
| Still Image Recording | 28 |
| Zooming | 28 |
| Continuous Shooting | 28 |
| Still Image Playback | 29 |
| Slide Show | 29 |
| Index Screen of Still Image Files | 29 |
| How to Use the Scroll Bar | 30 |
| Date Index Screen | 30 |
| Image Rotation | 30 |
| Playback Zoom | 30 |

ADVANCED OPERATIONS 31

RECORDING FEATURES 31

| | |
|------------------------------------|----|
| Backlight Compensation | 31 |
| Spot Exposure Control | 31 |
| Flash | 31 |
| Manual Settings in MSET Menu | 32 |
| How to Select a Menu Item | 32 |
| Manual Exposure | 32 |
| Manual Focus | 33 |
| White Balance | 34 |
| Shutter Speed | 35 |
| Program AE | 36 |
| Effect | 36 |

PLAYBACK FEATURES 37

| | |
|-----------------------------|----|
| Wipe or Fader Effects | 37 |
| Playback Effects | 37 |

MANAGING FILES 38

| | |
|---|----|
| Viewing File Information | 38 |
| Protecting Files | 38 |
| Deleting Files | 39 |
| Cleaning Up a Recording Medium | 40 |
| Copying/Moving Still Image Files | 41 |
| Resetting the File Number | 42 |
| Creating Play List | 42 |
| Playing Back Play List | 43 |
| DPOF Print Setting | 46 |
| Direct Printing with a PictBridge Printer | 47 |

MENU SETTINGS 48

| | |
|-----------------------------------|----|
| Changing the Menu Settings | 48 |
| Common Menus for All Modes | 48 |
| Video Recording Menus | 50 |
| Video Playback Menus | 50 |
| Still Image Recording Menus | 51 |
| Still Image Playback Menus | 51 |

REFERENCES 52

| | |
|---------------------------|----|
| Troubleshooting | 52 |
| Warning Indications | 54 |
| Cleaning the Camera | 56 |
| Cautions | 57 |
| Specifications | 60 |

TERMS Back cover

Dear Customer,

Thank you for purchasing this hard disk camera. Before use, please read the safety information and precautions contained in the pages 4 – 5 to ensure safe use of this product.

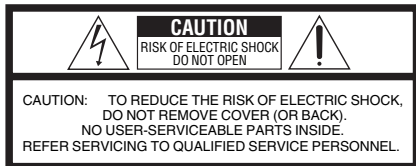
SAFETY PRECAUTIONS

The lightning flash with arrowhead symbol, within an equilateral triangle, is intended to alert the user to the presence of uninsulated "dangerous voltage" within the product's enclosure that may be of sufficient magnitude to constitute a risk of electric shock to persons.



The exclamation point within an equilateral triangle is intended to alert the user to the presence of important operating and maintenance (servicing) instructions in the literature accompanying the appliance.

WARNING: TO PREVENT FIRE OR SHOCK HAZARD, DO NOT EXPOSE THIS UNIT TO RAIN OR MOISTURE.

CAUTIONS:

- This camera is designed to be used with NTSC-type color television signals. It cannot be used for playback with a television of a different standard. However, live recording and LCD monitor playback are possible anywhere.
- Use the JVC BN-VF707U battery pack and, to recharge it or to supply power to the camera from an AC outlet, use the provided multi-voltage AC adapter. (An appropriate conversion adapter may be necessary to accommodate different designs of AC outlets in different countries.)

NOTES:

- The rating plate and safety caution are on the bottom and/or the back of the main unit.
- The serial number plate is on the battery pack mount.
- The rating information and safety caution of the AC adapter are on its upper and lower sides.

When the equipment is installed in a cabinet or on a shelf, make sure that it has sufficient space on all sides to allow for ventilation (10 cm (3-15/16") or more on both sides, on top and at the rear).

Do not block the ventilation holes. (If the ventilation holes are blocked by a newspaper, or cloth etc. the heat may not be able to get out.)

No naked flame sources, such as lighted candles, should be placed on the apparatus.

When discarding batteries, environmental problems must be considered and the local rules or laws governing the disposal of these batteries must be followed strictly.

The apparatus shall not be exposed to dripping or splashing.

Do not use this equipment in a bathroom or places with water.

Also do not place any containers filled with water or liquids (such as cosmetics or medicines, flower vases, potted plants, cups etc.) on top of this unit. (If water or liquid is allowed to enter this equipment, fire or electric shock may be caused.)

Do not point the lens directly into the sun. This can cause eye injuries, as well as lead to the malfunctioning of internal circuitry. There is also a risk of fire or electric shock.

CAUTION!

The following notes concern possible physical damage to the camera and to the user.

Carrying or holding the camera by the LCD monitor can result in dropping the unit, or in a malfunction.

Do not use a tripod on unsteady or unlevel surfaces. It could tip over, causing serious damage to the camera.

CAUTION!

Connecting cables (Audio/Video, S-Video, etc.) to the camera and leaving it on top of the TV is not recommended, as tripping on the cables will cause the camera to fall, resulting in damage.

IMPORTANT SAFETY INSTRUCTIONS

1. Read these instructions.
2. Keep these instructions.
3. Heed all warnings.
4. Follow all instructions.
5. Do not use this apparatus near water.
6. Clean only with dry cloth.
7. Do not block any ventilation openings. Install in accordance with the manufacturer's instructions.
8. Do not install near any heat sources such as radiators, heat registers, stoves, or other apparatus (including amplifiers) that produce heat.
9. Only use attachments/accessories specified by the manufacturer.
10. Use only with the cart, stand, tripod, bracket, or table specified by the manufacturer, or sold with the apparatus. When a cart is used, use caution when moving the cart/apparatus combination to avoid injury from tip-over.
11. Unplug this apparatus during lightning storms or when unused for long periods of time.
12. Refer all servicing to qualified service personnel. Servicing is required when the apparatus has been damaged in any way, such as power-supply cord or plug is damaged, liquid has been spilled or objects have fallen into the apparatus, the apparatus has been exposed to rain or moisture, does not operate normally, or has been dropped.



Before Using this Camera

This camera records video in MPEG2 format compliant with SD-VIDEO format.

Remember that this camera is not compatible with other digital video formats.

Remember that this camera is intended for private consumer use only.

Any commercial use without proper permission is prohibited. (Even if you record an event such as a show, performance or exhibition for personal enjoyment, it is strongly recommended that you obtain permission beforehand.)

Do not strike or shake the hard disk.

Before recording important video, be sure to make a trial recording.

Play back your trial recording to make sure the video and audio have been recorded properly.

Make a backup of important recorded data

Protect your important recorded data by copying the files to PC. It is recommended to copy it from your PC to a DVD or other recording media for storage. Refer to the software installation and USB connection guide.

Important notes when requesting repair or inspection

When the camera is repaired or inspected, data may be erased, and the hard disk may be formatted. Back up all data before requesting repair or inspection.

If a problem occurs with the SD Memory Card, bring the card together with the camera.

When requesting repairs for breakdowns by your dealer or JVC service center, be sure to bring your camera together with the SD Memory Card. If one of them is not included, the cause cannot be diagnosed, and the repair cannot be made properly.

Important notes for destroying and disposing of camera

When formatting or erasing data using the camera or PC functions, only the file administration information is changed. The data is not completely erased from the hard disk. If you want to completely erase all of the data, we recommend either using commercially available software that is specially designed for that purpose, or by physically destroying the camera with a hammer etc.

Also read "Cautions" on pages 57 to 59.

- Manufactured under license from Dolby Laboratories. "Dolby" and double-D symbol are trademarks of Dolby Laboratories.



MascotCapsule is registered trademark of HI CORPORATION in Japan.

Copyright © 2001 HI CORPORATION. All rights reserved.

- Other product and company names included in this instruction manual are trademarks and/or registered trademarks of their respective holders.

Provided Accessories

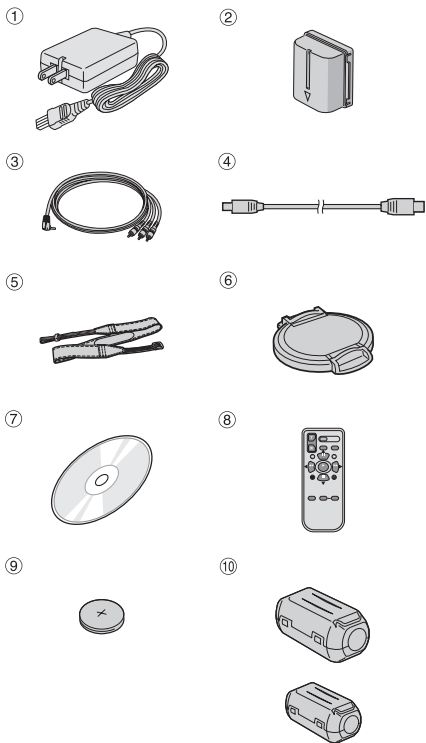

- ① AC Adapter AP-V14U
- ② Battery Pack BN-VF707U
- ③ Audio/Video Cable
- ④ USB Cable (Refer to the software installation and USB connection guide.)
- ⑤ Shoulder Strap (See page 8 for attachment)
- ⑥ Lens Cap (See page 8 for attachment)
- ⑦ CD-ROM
- ⑧ Remote Control Unit RM-V730U
- ⑨ Lithium Battery CR2025* (for remote control unit)
- ⑩ Core Filter for Cables (See page 9 for attachment)
 - Large (x 1): USB Cable
 - Small (x 1): DC Cord

* A lithium battery is pre-installed in the remote control unit at time of shipment (with insulation sheet). To use the remote control unit, remove the insulation sheet.

NOTES:

- In order to maintain optimum performance of the camera, provided cables may be equipped with one or more core filter. If a cable has only one core filter, the end that is closest to the filter should be connected to the camera.
- Make sure to use the provided cables for connections. Do not use any other cables.

Attaching the Shoulder Strap

Follow the illustration.

- 1** Open the velcro strip.
- 2** Thread the strap through the eyelet.
- 3** Fold it back and thread it through the strap guide and the buckle.
 - To adjust the length of the strap, loosen and then tighten the strap in the buckle.
- 4** Slide the strap guide fully towards the eyelet.
- 5** Close the velcro strip.

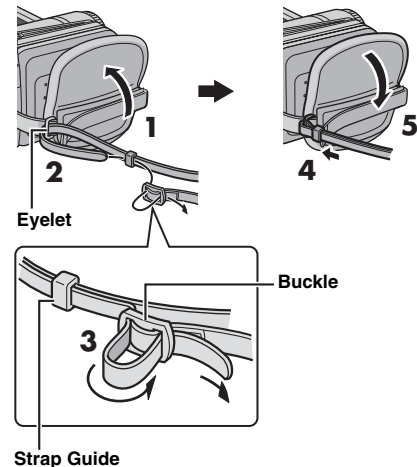
**Attaching the Lens Cap**

To protect the lens, attach the provided lens cap to the camera as shown in the illustration.

NOTE:

To confirm the lens cap is on correctly, make sure the cap is flush to the camera.

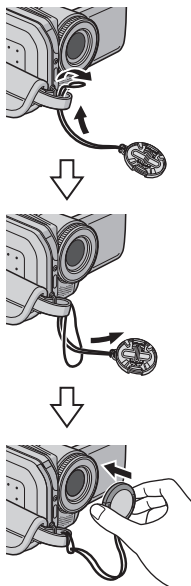
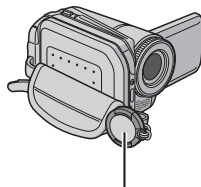

Attaching the Core Filter

Attach the core filters to the cables. The core filter reduces interference.

1 Release the stoppers on both ends of the core filter.



2 Run the cable through the core filter, leaving approx. 3 cm of cable between the cable plug and the core filter.

Wind the cable once around the outside of the core filter as shown in the illustration.

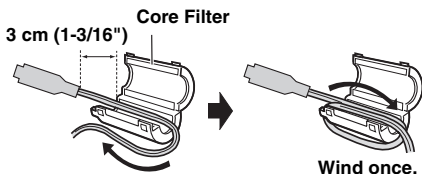

• Wind the cable so that it is not slack.

3 Close the core filter until it clicks shut.

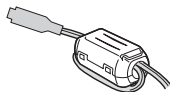

NOTES:

- Take care not to damage the cable.
- When connecting a cable, attach the end with the core filter to the camera.

LCD Monitor

Push the release button (A) and open the LCD monitor fully. It can rotate 270°.

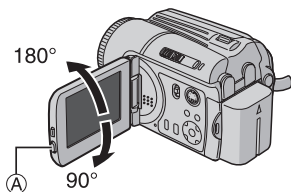

Index

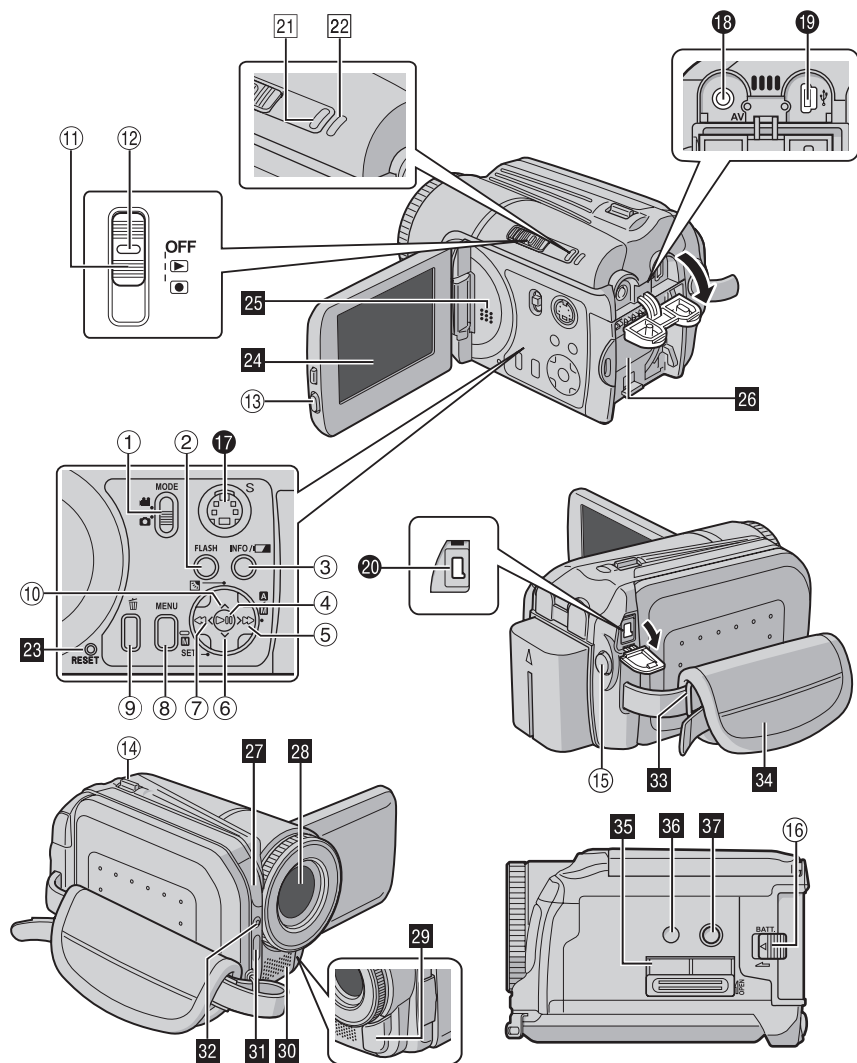
**ATTENTION:**

- Be careful not to cover **27**, **28**, **29**, **30**, **31** and **32** during shooting.
- Be careful not to cover **25** during playback.

Controls

- ① Mode Switch [MODE] (☞ pg. 16 – 17)
- ② Flash Button [FLASH] (☞ pg. 31)
- ③ Information Button [INFO/⏏] (☞ pg. 38)
- ④ Play/Pause Button [▶||] (☞ pg. 24, 29)
- ⑤ Forward Search Button [> ▶▶▶] (☞ pg. 25)/
Right Button [>]/Auto/Manual Mode Switch
[⏏/⏏] (☞ pg. 16 – 17)
- ⑥ Forward Skip Button [∨] (☞ pg. 25)/Down
Button [∨]/Manual Set Button [⏏SET]
(☞ pg. 32)
- ⑦ Reverse Search Button [< ◀◀◀] (☞ pg. 25)/
Left Button [<]
- ⑧ Menu Button [MENU] (☞ pg. 48)
- ⑨ Delete Button [⏏] (☞ pg. 39)
- ⑩ Reverse Skip Button [^] (☞ pg. 25)/Up
Button [^]/Backlight Compensation Button
[⏏] (☞ pg. 31)/Spot Exposure Control
Button (☞ pg. 31)
- ⑪ Power Switch [OFF, ▶, ●] (☞ pg. 16)
- ⑫ Lock Button (☞ pg. 16)
- ⑬ LCD Release Button
- ⑭ Zoom Lever [T ∞/W ⏏] (☞ pg. 23)
Speaker Volume Control (☞ pg. 24)
- ⑮ Recording Start/Stop Button (☞ pg. 22, 28)
- ⑯ Battery Release Button [BATT.] (☞ pg. 14)

Connectors

The connectors are located beneath the covers.

- ⑰ S-Video Output Connector [S] (☞ pg. 26)
- ⑱ Audio/Video Output Connector [AV]
- ⑲ USB (Universal Serial Bus) Connector (Refer
to the software installation and USB
connection guide.)
- ⑳ DC Input Connector [DC] (☞ pg. 14)

Indicators

- ㉑ Power/Charge Lamp [POWER/CHARGE]
(☞ pg. 14, 16)
- ㉒ Access Lamp [ACCESS] (Lights up or blinks
when you access to any files. Do not turn off
the power or remove the battery pack/AC
adaptor while accessing to files.)

Other Parts

- ㉓ Reset Hole [RESET] (☞ pg. 52)
- ㉔ LCD Monitor
- ㉕ Speaker (☞ pg. 24)
- ㉖ Battery Pack Mount (☞ pg. 14)
- ㉗ Camera Sensor
- ㉘ Lens
- ㉙ Remote Sensor (☞ pg. 27)
- ㉚ Stereo Microphone
- ㉛ Flash (☞ pg. 31)
- ㉜ Flash Sensor
- ㉝ Shoulder Strap Eyelet (☞ pg. 8)
- ㉞ Grip Strap (☞ pg. 19)
- ㉟ SD Card Cover [OPEN] (☞ pg. 19)
- ㊱ Stud Hole (☞ pg. 19)
- ㊲ Tripod Mounting Socket (☞ pg. 19)

Indications on LCD Monitor

During both Video and Still Image Recording

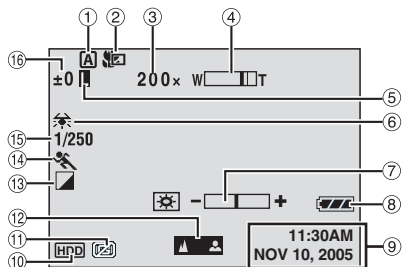

- ① Selected Operation Mode Indicator (☞ pg. 17)
A: Auto Mode
M: Manual Mode
- ② Tele Macro Mode Indicator (☞ pg. 50)
- ③ Approximate Zoom Ratio (☞ pg. 23, 50)
- ④ Zoom Indicator (☞ pg. 23, 50)
- ⑤ Iris Lock Indicator (☞ pg. 31, 32)
- ⑥ White Balance Indicator (☞ pg. 34)
- ⑦ Brightness Control Indicator (☞ pg. 18, 49)
- ⑧ Battery Indicator (☞ pg. 54)
- ⑨ Date/Time (☞ pg. 49)
- ⑩ Selected Medium Indicator (☞ pg. 21, 49)
- ⑪ Drop Detection Indicator (☞ pg. 21)
- ⑫ Manual Focus Adjustment Indicator (☞ pg. 33)
- ⑬ Effect Mode Indicator (☞ pg. 36)
- ⑭ Program AE Mode Indicator (☞ pg. 36)
- ⑮ Shutter Speed (☞ pg. 35)
: Nightlives Indicator
- ⑯ ±: Exposure Adjustment Indicator (☞ pg. 32)
: Backlight Compensation Indicator (☞ pg. 31)
: Spot Exposure Control Indicator (☞ pg. 31)

During Video Recording only

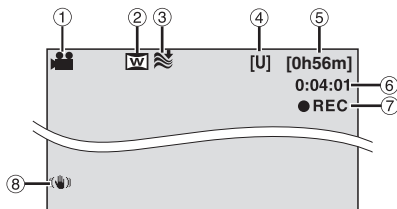

- ① Mode Indicator (☞ pg. 17)
- ② Wide Mode Indicator (☞ pg. 50)
- ③ Wind Cut Indicator (☞ pg. 50)
- ④ Picture Quality: [U] (ultra fine), [F] (fine), [N] (normal), [E] (economy) (☞ pg. 50)
- ⑤ Remaining Time (☞ pg. 22, 62)
- ⑥ Counter (☞ pg. 49)
- ⑦ ●REC: (Appears during recording.) (☞ pg. 22)
: (Appears during record-standby mode.) (☞ pg. 22)
- ⑧ Digital Image Stabilizer (DIS) Indicator (☞ pg. 50)

During Still Image Recording only

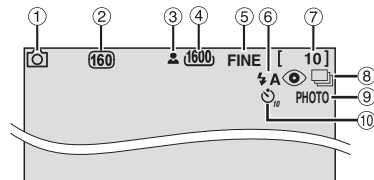

- ① Mode Indicator (☞ pg. 17)
- ② ISO sensitivity (GAIN) (☞ pg. 51)
 (When set to [AUTO], there is no indication.)
- ③ Focus Icon (☞ pg. 28)
- ④ Image Size: 1600 (1600 x 1200), 1280 (1280 x 960), 1024 (1024 x 768), 640 (640 x 480) (☞ pg. 51)
- ⑤ Picture Quality: FINE (fine) or STD (standard) (☞ pg. 51)
- ⑥ Flash Mode Indicator (☞ pg. 31)
- ⑦ Remaining Number of Shots (☞ pg. 63)
- ⑧ : Continuous Shooting Mode Indicator (☞ pg. 28)
- ⑨ Shooting Icon (☞ pg. 28)
- ⑩ Self-Timer Recording Indicator (☞ pg. 51)

During Video Playback

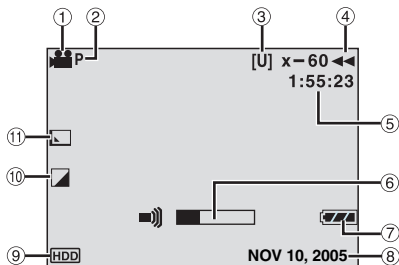

- ① Mode Indicator (☞ pg. 17)
- ② Play List Playback Indicator (Appears when play list is played back. ☞ pg. 43)
- ③ Picture Quality: [U] (ultra fine), [F] (fine), [N] (normal), [E] (economy) (☞ pg. 50)
- ④ Playback Mode (☞ pg. 24)
 - ▶ : Playback
 - ⏸ : Pause
 - ▶▶ : Forward High-Speed Search
 - ◀◀ : Reverse High-Speed Search
 - ▶▶▶ : Forward Slow-Motion
 - ◀◀◀ : Reverse Slow-Motion
 (The number on the left shows speed.)
- ⑤ Counter (☞ pg. 49)
- ⑥ Volume Level Indicator
- ⑦ Battery Indicator (☞ pg. 54)
- ⑧ Date (☞ pg. 49)
- ⑨ Selected Medium Indicator (☞ pg. 21, 49)
- ⑩ Effect Mode Indicator (☞ pg. 37)
- ⑪ Wipe/Fader Effect Indicator (☞ pg. 37, 50)

During Still Image Playback

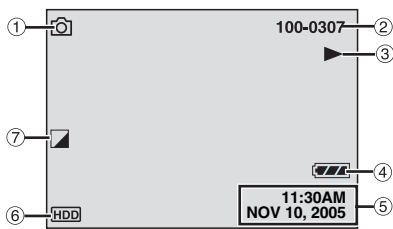

- ① Mode Indicator (☞ pg. 17)
- ② Folder/File Number
- ③ Slide Show Playback Indicator (☞ pg. 29)
- ④ Battery Indicator (☞ pg. 54)
- ⑤ Date/Time (☞ pg. 49)
- ⑥ Selected Medium Indicator (☞ pg. 21, 49)
- ⑦ Effect Mode Indicator (☞ pg. 37)

Power

This camera's 2-way power supply system lets you choose the most appropriate source of power. Do not use provided power supply units with other equipment.

Charging the Battery Pack

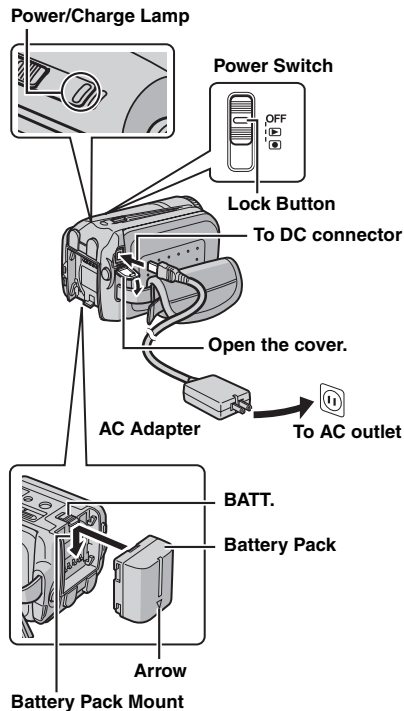

- 1** Set the power switch to **OFF**.
- 2** With the arrow on the battery pack pointing downward, push the battery pack slightly against the battery pack mount.
 - If the battery mount cover is attached, remove it by sliding **BATT.**
- 3** Slide down the battery pack until it locks in place.
- 4** Connect the AC adapter to the camera.
- 5** Plug the AC adapter into an AC outlet. The power/charge lamp on the camera blinks to indicate charging has started.
- 6** When the power/charge lamp goes out, charging is finished. Unplug the AC adapter from the AC outlet. Disconnect the AC adapter from the camera.

To detach the battery pack

While sliding **BATT.**, remove the battery pack.

Required charging time

| Battery pack | Charging time |
|--------------|-----------------------|
| BN-VF707U* | Approx. 1 hr. 30 min. |
| BN-VF714U | Approx. 2 hr. 40 min. |
| BN-VF733U | Approx. 5 hr. 40 min. |

* Provided

NOTES:

- This product includes patented and other proprietary technology and will operate only with JVC Data Battery. Use the JVC BN-VF707U/VF714U/VF733U battery packs. Using generic non-JVC batteries can cause damage to the internal charging circuitry.
- If the protective cap is attached to the battery pack, remove it first.
- During charging, the camera cannot be operated.
- Charging is not possible if the wrong type of battery is used.
- Make sure to use the battery pack with the arrow (Δ) mark. The camera does not turn on with the battery pack without the arrow (Δ) mark.
- When charging the battery pack for the first time or after a long storage period, the power/charge lamp may not light. In this case, remove the battery pack from the camera, then try charging again.
- If the battery operation time remains extremely short even after having been fully charged, the battery is worn out and needs to be replaced. Please purchase a new one.
- Since the AC adapter processes electricity internally, it becomes warm during use. Be sure to use it only in well-ventilated areas.
- Using the optional AA-VF7 battery charger, you can charge the BN-VF707U/VF714U/VF733U battery pack without the camera.
- After 5 minutes has elapsed in record-standby mode, the camera will automatically turn off its power supplied from the AC adapter. In this case, the battery charge starts if the battery is attached to the camera.

Using the Battery Pack

Perform steps **2 – 3** in "Charging the Battery Pack" (☞ pg. 14).

Maximum continuous recording time

| Battery pack | Recording time |
|--------------|-----------------------|
| BN-VF707U* | Approx. 50 min. |
| BN-VF714U | Approx. 1 hr. 50 min. |
| BN-VF733U | Approx. 4 hr. 20 min. |

* Provided

NOTES:



- Recording time is reduced significantly under the following conditions:
 - Zoom or record-standby mode is engaged repeatedly.
 - Playback mode is engaged repeatedly.
- Before extended use, it is recommended that you prepare enough battery packs to cover 3 times the planned recording time.

ATTENTION:

- Before detaching the power source, make sure that the camera's power is turned off. Failure to do so can result in a camera malfunction.
- If the camera is subjected to electrostatic discharge, turn the power off before using it again.

Data Battery System

You can check the remaining battery power and the recordable time.

- 1 Make sure the battery is attached.
- 2 Open the LCD monitor fully.
- 3 Press **INFO**/ repeatedly, and the battery status screen appears.
 - It is displayed for approx. 3 seconds if the button is pressed and released quickly, and for approx. 15 seconds if the button is pressed and held for several seconds.
 - If "COMMUNICATING ERROR" appears instead of the battery status even though you tried to press **INFO**/ several times, there may be a problem with your battery. In such a case, consult your nearest JVC dealer.
 - The recordable time display should only be used as a guide. It is displayed in 10 minute units.

Using AC Power

Perform step 4 in "Charging the Battery Pack" ( pg. 14).

NOTE:

The provided AC adapter features automatic voltage selection in the AC range from 110 V to 240 V.

About Batteries



DANGER! Do not attempt to take the batteries apart, or expose them to flame or excessive heat, as it may cause a fire or explosion.

WARNING! Do not allow the battery or its terminals to come in contact with metals, as this can result in a short circuit and possibly start a fire.

To resume the original function of the accurate battery power indication

If the battery power indication differs from the actual operating time, fully charge the battery, and then run it down. However this function may not work properly if the battery was used for a long period of time under extremely high/low temperature condition or charged too many times.



Operation Mode

To turn on the camera, set the power switch to  or  while pressing down the lock button located on the switch.

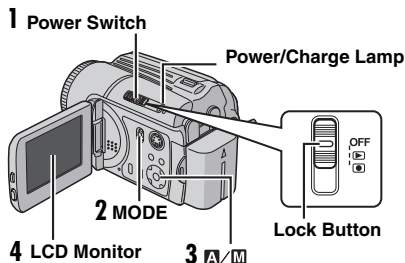

- The power/charge lamp turns on.

To turn off the camera, set the power switch to **OFF**.



Set the appropriate operation mode according to your preference using the power and **MODE** switches and  (/) button.

1 Power Switch Position

Set the power switch for recording () or playback () while pressing down the lock button.

Power Switch

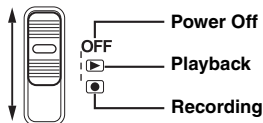

2 Recording/Playback Mode

Select the recording/playback mode using the **MODE** switch.

 : Video mode (☞ pg. 22, 24)

 : Still image mode (☞ pg. 28, 29)

3 Auto/Manual Mode

Press and hold \triangleright (**A/M**) to switch the auto/manual recording mode. When manual mode is selected, the indicator **M** appears on the LCD monitor.



Auto mode:
You can record without using special effects or manual adjustments.

Manual mode:
Manual recording is possible by setting various functions.
(☞ pg. 31 – 37)

To return to the auto recording mode



Press and hold \triangleright (**A/M**) again so that the **A** indicator appears.

4 Power-Linked Operation

When the power switch is set to , you can also turn on/off the camera by opening/closing the LCD monitor.

Language Setting

The language on the display can be changed.
(☞ pg. 48, 49)

- 1 Set the power switch to  or .
- 2 Press **MENU**. The menu screen appears.
- 3 Press \wedge/\vee to select [DISPLAY], then press \triangleright .



- 4 Press \wedge/\vee to select [LANGUAGE], then press \triangleright .

- 5 Press \wedge/\vee to select the desired language, then press \triangleright .





- 6 Press **MENU** to return to the normal screen.

Date/Time Settings

The recording start date/time is recorded on the video/still image file and it can be checked by pressing **INFO**/ during playback.

( pg. 24, 29)



In addition, you can find the desired file by the date index screen. ( pg. 30)

1 Set the power switch to  or .



2 Press **MENU**. The menu screen appears.

3 Press / to select **[DISPLAY]**, then press **▶||**.

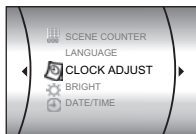

4 Press / to select **[CLOCK ADJUST]**, then press **▶||**. The month is highlighted.



5 Press / to input the month, then press **▶||**. Repeat to input the day, year, hour and minute.

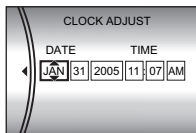

6 Press **MENU** to return to the normal screen.



Built-in Clock's Rechargeable Lithium Battery

If the camera is not used for approx. 3 months, the clock's lithium battery will become discharged and the date/time stored in memory will be lost. When this occurs, first connect the camera to an AC outlet using the AC adapter for over 24 hours to charge the clock's rechargeable lithium battery. Then perform the date/time setting before using the camera.

Note that the camera can be used without setting the date/time.



Brightness Adjustment of the Display



The brightness of the display can be adjusted.

1 Set the power switch to  or  while pressing down the lock button located on the switch.



2 Open the LCD monitor fully. ( pg. 9)

3 Press **MENU**. The menu screen appears.

4 Press / to select **[DISPLAY]**, then press **▶||**.

5 Press / to select **[BRIGHT]**, and press **▶||**. The brightness control indicator appears.



6 Press / until the appropriate brightness is reached.

7 Press **▶||** to clear the brightness control indicator from the display.

Grip Adjustment

- 1 Adjust the velcro strip.
- 2 Pass your right hand through the loop and grasp the grip.
- 3 Adjust your thumb and fingers to easily operate the recording start/stop button, power switch and zoom lever. Be sure to fasten the velcro strip to your preference.

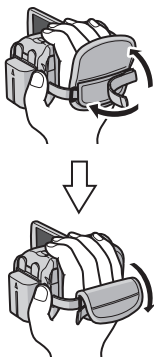

Tripod Mounting

To attach the camera to a tripod, align the direction stud and screw to the mounting socket and stud hole on the camera. Then tighten the screw clockwise.

- Some tripods are not equipped with studs.

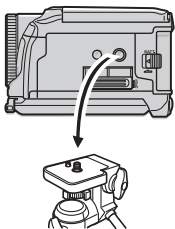

Inserting/Removing an SD Card

You can use an SD card as a recording medium in the SD slot. See page 62 for the guaranteed media to work with this camera.

Clipped Edge

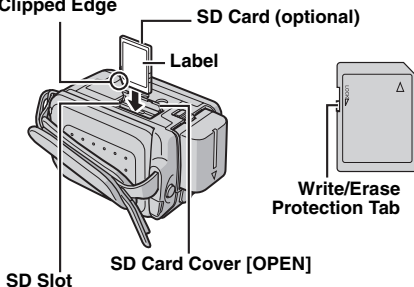

- 1 Make sure the camera's power is off.

- 2 Open the SD card cover.

- 3 To insert an SD card, firmly insert it with its clipped edge first.

To remove an SD card, push it once. After the SD card comes out of the camera, pull it out.

- Do not touch the terminal on the reverse side of the label.

- 4 Close the SD card cover.

To protect valuable files

Slide the write/erase protection tab on the side of the SD card in the direction of "LOCK". This prevents the SD card from being recorded over. To record on this SD card, slide the tab back to the position opposite to "LOCK" before inserting it.

NOTE:

Before using a new SD card, it is necessary to format the card. (▶ pg. 20)

ATTENTION:

Do not insert or remove the SD card while the camera is turned on, as this may cause the data on the SD card to be corrupted or cause the camera to become unable to recognize whether or not the SD card is installed.

Formatting a Recording Medium

You can format (initialize) the built-in hard disk (HDD) or SD cards. You have to format the newly-purchased SD cards with this camera before using them. This enables stable speeds and operation when accessing the recording medium. Be aware that all files and data including protected files will be erased.

(▶ pg. 38)

- 1 Set the power switch to or .
- 2 Press **MENU**. The menu screen appears.
- 3 Press \wedge / \vee to select [REC MEDIA SETTING], then press \blacktriangleright .



- 4 Press \wedge / \vee to select [FORMAT], then press \blacktriangleright .

- 5 Press \wedge / \vee to select [HDD] or [SD], then press \blacktriangleright .



- 6 Press \wedge / \vee to select [EXECUTE], then press \blacktriangleright .

- To cancel the formatting, select [CANCEL], then press \blacktriangleright .

To make it more difficult to recover the data on the hard disk

Even if you format the hard disk or erase the data on the hard disk, sometimes the erased data can be recovered by using data recovery software etc. that are commercially available. By pressing the $\blacktriangleright \parallel$ button while selecting [HDD] and holding down the button in step 5, you can erase the data on the hard disk in a format that is difficult to recover. Moreover, by repeating this procedure, you can make the data even more difficult to recover.

- When formatting in this way, a formatting progress bar is displayed.
- If the formatting progress bar does not appear, select [CANCEL] and try again from step 4.

CAUTION:

Do not remove the SD card or perform any other operation (such as turning off the power) during format. Also, be sure to use the provided AC adapter, as the data on the recording medium may be corrupted if the battery becomes exhausted during format. If the data on the recording medium becomes corrupted, format it again.

NOTE:

Do not format the recording medium on the PC. Make sure to format the recording medium on the camera.

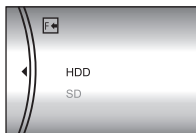

Selecting a Recording Medium

Select the recording medium before starting recording or playback. (☞ pg. 48, 49)

Example: When recording still images to an SD card

- 1 Set the power switch to or .
- 2 Press **MENU**. The menu screen appears.
- 3 Press \wedge / \vee to select [REC MEDIA SETTING], then press \blacktriangleright .



- 4 Press \wedge / \vee to select [IMAGE MODE], then press \blacktriangleright .



- 5 Press \wedge / \vee to select [SD], then press \blacktriangleright .
- 6 Press **MENU** to return to the normal screen.

Remaining Space on the Recording Media

This enables you to check the remaining space on the recording media and the available recording time for each picture quality mode. Before checking, set the recording media that you want to check in [REC MEDIA SETTING]. (☞ pg. 48, 49)

Example: When checking the HDD space

- 1 Set the power switch to .
- 2 Press **INFO**/. The MAX RECORDING TIME screen appears.

Displayed picture quality mode

- U**: ULTRA FINE
- F**: FINE
- N**: NORMAL
- E**: ECONOMY

For details on the picture quality, see page 50.

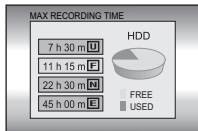

Drop Detection

This function turns off the power automatically to prevent HDD damage when the camera is accidentally dropped. This function is set to on at time of shipment.

If the power is turned off due to the drop detection function, set the power switch to **OFF**, and turn the power on again.

To turn off this function

Set [DROP DETECTION] to [OFF]. The indicator appears. (☞ pg. 49)

CAUTION:

Setting this function to off increases the chances of damaging the internal hard disk if the camera is accidentally dropped.

NOTES:

- This function cannot protect the hard disk every single time it is dropped.
- The indicator is only displayed when this function is set to [OFF]. For normal use, set this function to [ON].
- If the drop detection function operates when the camera has not been dropped, set the function to [OFF] to continue use.
- If a drop is detected during shooting, the file being shot when the camera was dropped may be saved in the [EXTMOV] folder. (☞ pg. 22)

To return to the normal screen

Press **INFO**/ repeatedly.

Video Recording

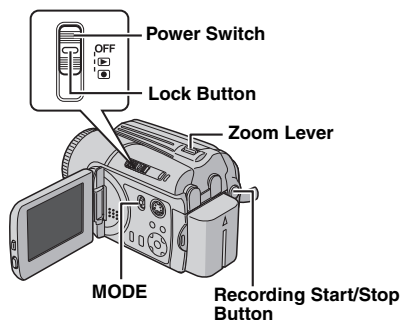

NOTES:

- If the camera is left without any operation during recording or playback (video or still image) for 5 minutes when using the battery pack, the camera is turned off automatically to conserve power. To turn the camera on again, set the power switch to **OFF**, then to or . When using the AC adapter, the camera enters the sleep mode (the access lamp lights and the LCD monitor turns off). To cancel the sleep mode, perform any operation such as zooming.
- When the camera heats up, the indicator flashes. If the camera continues to heat up, shooting may be stopped to protect the recording medium. In this case, turn off the power, and then wait until the camera cools down. (⇨ pg. 55)
- If data cannot be recorded or saved properly, the video files are not saved to the [SD_VIDEO] folder, which is for regular videos. Instead, the files are saved to the [EXTMOV] folder. To play back these files, see "To play back files in the [EXTMOV] folder" (⇨ pg. 24).
- There may be differences in the brightness between the recorded video and still image, even if the same subject is shot.
- Video file names are assigned as sequential hexadecimal numbers. For example, starts from 1 to 9 followed by A to F.
- To turn the operation sounds off, see page 48.
- For approximate recording time, see page 62.
- After recording video for 12 consecutive hours, the recording will be stopped automatically.
- When recording video, a new file will be created for every 4 GB of continuous shooting.

1 Set the power switch to .

2 Set the **MODE** switch to .

- The camera is programmed to record videos on the built-in hard disk by the factory-preset. To switch the recording medium, see pages 21, 48 and 49.
- To change the picture quality, see pages 48 and 50.

3 Press the recording start/stop button to start recording.

- Approximate remaining time for recording appears on the display.

[U] [0h56m]

REC

4 To stop recording, press the recording start/stop button again.

Zooming

Use the zoom function for close-up or wide-angle shooting. You can zoom in up to 10x by using the optical zoom.

To zoom in

Slide the zoom lever towards **T** (telephoto) (☰).

To zoom out

Slide the zoom lever towards **W** (wide-angle) (☲).

W: Wide angle

T: Telephoto

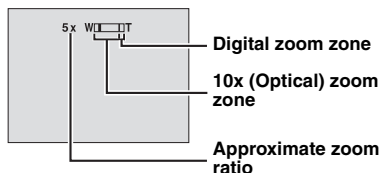
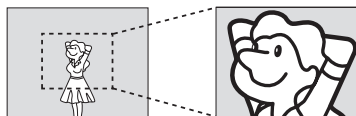

- The further you slide the zoom lever, the quicker the zoom action.
- Zoom magnification over 10x is done through digital image processing, and is therefore called digital zoom. Digital zooming is possible up to 200x. Set [ZOOM] to [40X] or [200X]. (☞ pg. 50)

NOTES:

- The S-Video cable is optional. Be sure to use the YTU94146A S-Video cable. Consult the JVC Service Center described on the sheet included in the package for details on its availability. Make sure to connect the end with a core filter to the camera. The core filter reduces interference.
- Focusing may become unstable during zooming. In this case, set the zoom before recording and lock the focus by using the manual focus (☞ pg. 33), then zoom in or out during recording.
- During digital zoom, the quality of image may suffer.
- Macro shooting is possible as close as approx. 5 cm (2") to the subject when the zoom lever is set all the way to **W**.
- When you zoom into a subject close to the lens, the camera may automatically zoom out depending on the distance to the subject. In this case, set [TELE MACRO] to [ON]. (☞ pg. 50)

Deleting Files

If you press  during recording mode, the file recorded most recently will be deleted. (☞ pg. 39)

- However, if the recording mode (video or still image) is switched or the power is turned off and on again after recording, you cannot delete the file.

Video Playback

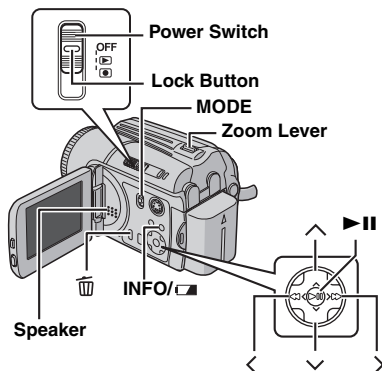

- 1** Set the power switch to .
- 2** Set the **MODE** switch to .
- The index screen for videos appears. The image on the index screen shows the first part of the shooting.
- If the power is turned off while video playback is paused, the camera memorizes the scene where the video was stopped. In this case, the stopped scene is displayed when the power is turned back on again.
- To switch the medium to be played back, see pages 21, 48 and 49.
- 3** Press / / / to select the video file you want to play back.
- 4** Press to start playback.
- 5** To pause playback, press again.

To return to the index screen

Slide the zoom lever to **W** when playback is paused.

To adjust the speaker volume

During playback slide the zoom lever towards **T** to turn up the volume, or towards **W** to turn down the volume.

To turn on/off the date display

Set [DATE/TIME] to [ON], [AUTO] or [OFF].
(pg. 48, 49)

To turn on/off the on-screen display

Press **INFO**/ repeatedly.

To check the file information

Press **INFO**/ when playback is paused.
(pg. 38)

To play back files in the [EXTMOV] folder

If the data cannot be recorded properly, the video files are saved to the [EXTMOV] folder.
(pg. 22)

To play back the files in the [EXTMOV] folder, press the recording start/stop button or START/STOP button on the remote control while the index screen is displayed in step **2**, and then proceed to step **3** after [MPG] is displayed. To return to the index screen, press the recording start/stop button or START/STOP button on the remote control again.

- The file information and playlist creation functions are not available for files in the [EXTMOV] folder.
- When deleting the files in the [EXTMOV] folder, perform it on the PC.

To play back files edited on the PC

To use the camera to play back the video files (MPEG2 files, with the extension “.mpg”) which have been edited on the PC, follow the following procedure. First, change the file name to “MOV_xxxx.mpg” (xxxx should be a 4-digit number). Connect the camera to the PC with the USB cable, and open the [EXTMOV] folder. Copy the video files (“MOV_xxxx.mpg”) to the [EXTMOV] folder. (Refer to the software installation and USB connection guide.) Then follow the steps in “To play back files in the [EXTMOV] folder”.

NOTES:

- The playback picture can be viewed in the LCD monitor or on a connected TV. (pg. 26)
- At the junctions between scenes, the image may stop momentarily or the sound may be interrupted. However, this is not a malfunction.
- The date and counter can be displayed during playback. (pg. 49)
- When the camera heats up, the indicator flashes. If the camera continues to heat up, playback may be stopped to protect the recording medium. In this case, turn off the camera power, and then wait until the camera cools down. (pg. 55)
- When a cable is connected to the AV connector, the sound is not heard from the speaker.

How to Use the Scroll Bar

You can use the vertical scroll bar on the index screen to find the desired files quickly. The scroll bar is useful when deleting files (☞ pg. 39), creating play list (☞ pg. 42), etc.

1 Slide the zoom lever towards **W** to select the scroll bar on the index screen.

2 Press \wedge/\vee to display the next or previous page.

- If you press and hold \wedge/\vee , the high speed search starts.
- If you find the desired file, slide the zoom lever towards **T**, then select the file.

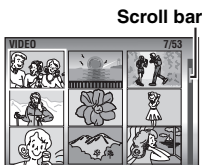

Date Index Screen

You can also find the desired file by the date index screen. The files are sorted according to their recorded date.

1 Slide the zoom lever twice towards **W**. The date index screen appears.

2 Press \wedge/\vee to select the desired date. The files recorded on the selected date are displayed on the right side of the screen.

- Dates can also be selected by using the scroll bar on the right side of the screen. To select the scroll bar, slide the zoom lever towards **W** while on the date index screen, and press \wedge/\vee .

3 Press $\blacktriangleright\parallel$. The files recorded on the selected date are displayed in the index screen.

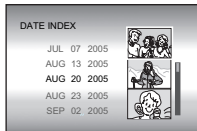

Various Playback Operations

Still playback (Pause)

Press $\blacktriangleright\parallel$ during normal playback.

- To resume normal playback, press $\blacktriangleright\parallel$ again.

Search playback

During normal playback, press \gt for forward search, or \lt for reverse search.

- Pressing \lt or \gt repeatedly increases the search speed for each direction. (-60x to +60x)
- To resume normal playback, press $\blacktriangleright\parallel$.

Locating the start point of the file or skipping the file

Press \vee to locate the start point of the next file. Pressing \vee repeatedly skips files in forward direction.

Press \wedge to locate the start point of the current file. Pressing \wedge repeatedly skips files in reverse direction.

- If you press \vee or \wedge during normal playback or search, playback resumes after locating the start point of a file.

Frame-by-frame playback

While playback is paused, press \lt or \gt .

- Pressing \lt or \gt repeatedly advances or reverses the still picture frame by frame.
- To resume normal playback, press $\blacktriangleright\parallel$.

Slow motion playback

While playback is paused, press and hold \lt or \gt for over 2 seconds.

- To stop slow motion playback, press $\blacktriangleright\parallel$.

Playback Zoom

You can magnify the playback image up to 5x.

1 During normal playback, at the point you want to zoom in, press $\blacktriangleright\parallel$ to pause playback.

2 Slide the zoom lever towards **T** to zoom in.

- The full view of the image is displayed in the small screen on the lower right side. The \boxtimes mark indicates the center point of the magnified area.

3 Press $\wedge/\vee/\lt/\gt$ to move to the magnified area you want to view.

4 To zoom out, slide the zoom lever towards **W**.

- When the zoom is set all the way to **W** (wide-angle) side, sliding the zoom lever to **W** switches the display to the index screen. (☞ pg. 25)

Deleting Video Files

Press \boxtimes , then press \wedge/\vee to select [EXECUTE] and press $\blacktriangleright\parallel$.

- You can select the desired file to be deleted by pressing \lt/\gt .
- To delete multiple files at once, see page 39.

Connecting to a TV, VCR or DVD Recorder

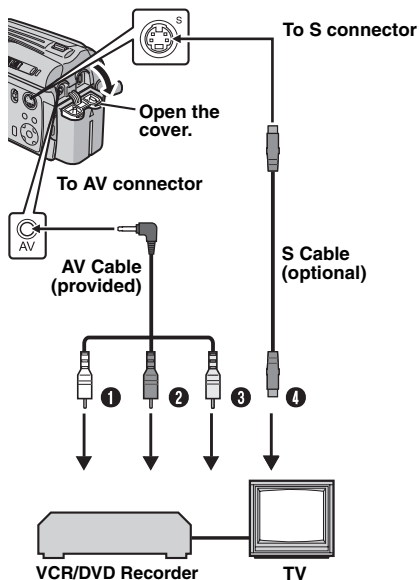

- ❶ White to AUDIO L IN*
 - ❷ Red to AUDIO R IN*
 - ❸ Yellow to VIDEO IN (Connect when your TV/VCR/DVD recorder has only A/V input connectors.)
 - ❹ Black to S-VIDEO IN (Connect when your TV/VCR/DVD recorder has S-VIDEO IN and A/V input connectors. In this case, it is not necessary to connect the yellow video cable.)
- * Not required for watching still images only.

NOTES:

- The S-Video cable is optional. Be sure to use the YTU94146A S-Video cable. Consult the JVC Service Center described on the sheet included in the package for details on its availability. Make sure to connect the end with a core filter to the camera. The core filter reduces interference.
- It is recommended to use the AC adapter as the power supply instead of the battery pack. (☞ pg. 16)
- Make sure you adjust the TV sound volume to its minimum level to avoid a sudden burst of sound when the camera is turned on.
- To connect the camera to a PC, refer to the software installation and USB connection guide.

Playback on a TV

- 1 Make sure all units are turned off.
 - 2 Connect the camera to a TV, VCR or DVD recorder as shown in the illustration.
- If using a VCR or DVD recorder, go to step 3. If not, go to step 4.
- 3 Connect the VCR/DVD recorder output to the TV input, referring to your VCR/DVD recorder's instruction manual.
 - 4 Turn on the camera, the VCR/DVD recorder and the TV.
 - 5 Set the VCR/DVD recorder to its AUX input mode, and set the TV to its VIDEO mode.
 - 6 Start playback on the camera. (☞ pg. 24)

To choose whether or not the following displays appear on the connected TV

- Date/Time
Set [DATE/TIME] to [AUTO], [ON] or [OFF].
(☞ pg. 48, 49)
 - Counter
Set [SCENE COUNTER] to [ON] or [OFF].
(☞ pg. 48, 49)
- (Pressing **INFO**/ button also turns on/off the displays.)

Dubbing to a VCR (or DVD Recorder)

The following explains how to dub to a VCR. When dubbing to a DVD recorder, refer to its instruction manual.

- 1 Perform steps 1 to 6 above.
- 2 At the point you want to start dubbing, start recording on the VCR. (Refer to the VCR's instruction manual.)
- 3 To stop dubbing, stop recording on the VCR, then stop playback on the camera.

Playback Using the Remote Control

The full-function remote control unit can operate this camera from a distance as well as the basic operations (playback, stop, pause, fast-forward and rewind) of your VCR.

Installing the Battery

The remote control uses one lithium battery (CR2025).

1 Pull out the battery holder by pushing the lock tab.

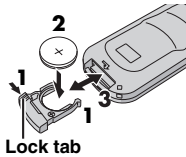

2 Insert the battery in the holder, and be sure to have the “+” mark visible.

3 Slide the holder back in until you hear a click.

Beam Effective Area

When using the remote control, be sure to point it at the remote sensor. The transmitted beam's approximate effective distance for indoor use is 5 m (16 ft). Use the remote control in front of the camera facing toward the lens.

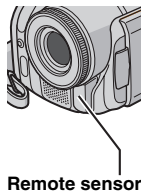

NOTE:

The transmitted beam may not be effective or may cause incorrect operation when the remote sensor is directly exposed to sunlight or powerful lighting.

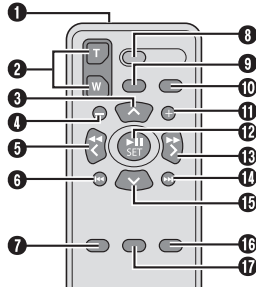

Buttons and Functions

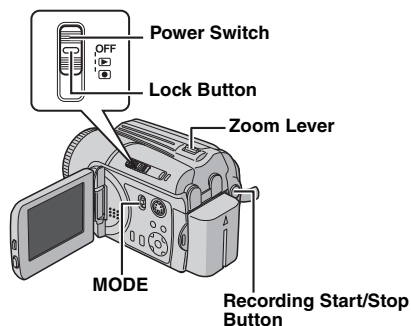

- 1** Infrared Beam Transmitting Window
 - Transmits the beam signal.
- 2** ZOOM (T/W) Buttons
Zoom In/Out (⇨ pg. 23)
- 3** Up Button
Rotate Button (clockwise) (⇨ pg. 30)
- 4** Skip Backward Button
- 5** Left Button
- 6** Back Button
- 7** PLAYLIST Button (⇨ pg. 42)
- 8** START/STOP Button
- 9** SNAPSHOT Button (⇨ pg. 28)
- 10** INFO Button (⇨ pg. 38)
- 11** Skip Forward Button
- 12** PLAY/PAUSE Button
- 13** Right Button
- 14** Next Button
- 15** Down Button
Rotate Button (counterclockwise) (⇨ pg. 30)
- 16** INDEX Button
- 17** DATE Button

Still Image Recording



- 1** Set the power switch to .
- 2** Set the **MODE** switch to .
 - The camera is programmed to record still images on the built-in hard disk by the factory-preset. To switch the recording medium, see pages 21, 48 and 49.
 - To change the picture quality, see pages 48 and 51.
 - To use the flash, see page 31.
- 3** Press the recording start/stop button. **PHOTO** indicator appears during shooting. The still image is recorded.
 - To check how the image looks before recording, press the recording start/stop button halfway and hold. The  indicator appears and stops blinking when the captured image is focused. To cancel the recording, release the recording start/stop button. To record it on the recording medium, press the recording start/stop button fully.

NOTES:



- There may be differences in the brightness between the recorded video and still image, even if the same subject is shot.
- To turn the shutter sound off, see page 48.
- For approximate number of storable images, see page 63.

Zooming

Use the zoom function for close-up or wide-angle shooting. For details, see page 23.

Continuous Shooting

If the continuous shooting mode is set to on, keeping the recording start/stop button pressed in step **3** in "Still Image Recording" ( pg. 28) provides an effect similar to serial photography. (Interval between still images: approx. 0.5 seconds)

To use this function, set the [CONTINUOUS SHOOTING] to [ON]. ( pg. 51) The  indicator appears on the display.

- To turn off this function, set [CONTINUOUS SHOOTING] to [OFF].
- Continuous shooting may not work well depending on the recording medium.
- The continuous shooting speed will drop when repeatedly making continuous shots.

Deleting Files

If you press  during recording mode, the file recorded most recently will be deleted.

( pg. 39)

- However, if the recording mode (video or still image) is switched or the power is turned off and on again after recording, you cannot delete the file.

Still Image Playback

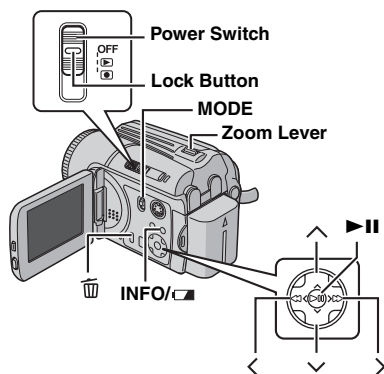

- 1 Set the power switch to .
- 2 Set the **MODE** switch to .
 - The most recently shot still image is displayed.
 - To switch the medium to be played back, see pages 21, 48 and 49.
- 3 Press to display the previous file. Press to display the next file.

To turn on/off the date/time display
Set [DATE/TIME] to [ON], [AUTO] or [OFF].
(pg. 48, 49)

To turn on/off the on-screen display / To check the file information (pg. 38)
Press **INFO/□** repeatedly.

NOTES:

- Images shot and stored on the recording media with another device may not be played back correctly.
- You can zoom in/out or rotate still images. (pg. 30)

Slide Show

You can playback all the images stored in recording media automatically.

- 1 Set the power switch to .
- 2 Set the **MODE** switch to .
 - A still image is displayed.
 - To switch the medium to be played back, see pages 21, 48 and 49.
- 3 Press to start the slide show.
 - If you press during the slide show, files are displayed in descending order.
 - If you press during the slide show, files are displayed in ascending order.
 - To end the slide show, press again.

To display the next image

To display the previous image

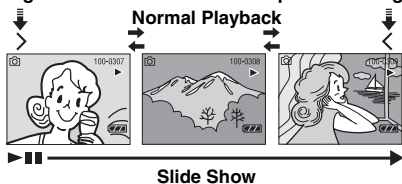

Index Screen of Still Image Files

You can view multiple files stored in a recording medium at a time. This browsing capability makes it easy to locate a particular file you want.

- 1 Slide the zoom lever to **W** when a recorded image is displayed.
 - The display switches to the index screen.
- 2 Press /// to move the frame to the desired file.
- 3 Press . The selected file is displayed.



How to Use the Scroll Bar

You can use the vertical scroll bar on the index screen to find the desired files quickly. The scroll bar is useful when deleting files (☞ pg. 39), setting DPOF (☞ pg. 46), etc.

1 Slide the zoom lever towards **W** to select the scroll bar on the index screen.

2 Press \wedge / \vee to display the next or previous page.

- If you press and hold \wedge / \vee , the high speed search starts.
- If you find the desired file, slide the zoom lever towards **T**, then select the file.

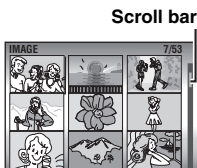

Date Index Screen

You can also find the desired file by the date index screen. The files are sorted according to their recorded date.

1 Perform step **1** in "Index Screen of Still Image Files" (☞ pg. 29) to display the index screen.

2 Slide the zoom lever twice towards **W**. The date index screen appears.

3 Press \wedge / \vee to select the desired date. The files recorded on the selected date are displayed on the right side of the screen.

- Dates can also be selected by using the scroll bar on the right side of the screen. To select the scroll bar, slide the zoom lever towards **W** while on the date index screen, and press \wedge / \vee .

4 Press $\blacktriangleright \parallel$. The files recorded on the selected date are displayed in the index screen.

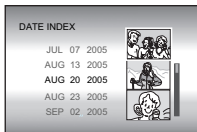

Image Rotation

You can rotate a still image clockwise or counterclockwise.

- 1** Set the power switch to \blacktriangleright .
- 2** Set the **MODE** switch to CAM .
 - A still image is displayed.
 - To switch the medium to be played back, see pages 21, 48 and 49.
- 3** Press \vee to rotate 90° clockwise.
 - Each time you press \vee , the image rotates clockwise. (90° → 180° → 270° → 0°)
- 4** Press \wedge to rotate 90° counterclockwise.
 - Each time you press \wedge , the image rotates counterclockwise. (270° → 180° → 90° → 0°)

Playback Zoom

You can magnify the playback image up to 5x.

- 1** Set the power switch to \blacktriangleright .
- 2** Set the **MODE** switch to CAM .
 - A still image is displayed.
 - To switch the medium to be played back, see pages 21, 48 and 49.
- 3** Slide the zoom lever towards **T** to zoom in.
 - The full view of the image is displayed in the small screen on the lower right side. The C mark indicates the center point of the magnified area.
- 4** Press $\wedge / \vee / \langle / \rangle$ to move to the magnified area you want to view.
- 5** To zoom out, slide the zoom lever towards **W**.
 - When the zoom is set all the way to **W** (wide-angle) side, sliding the zoom lever to **W** switches the display to the index screen. (☞ pg. 29)

Deleting Still Image Files

Press MENU , then press \wedge / \vee to select [EXECUTE] and press $\blacktriangleright \parallel$.

- You can select the desired file to be deleted by pressing \langle / \rangle .
- To delete multiple files at once, see page 39.

Backlight Compensation



Backlight compensation brightens the subject quickly. With simple operation, dark portions of the subject are brightened by increasing the exposure.

- 1 Set the power switch to
- 2 Press and hold \triangleright (A/M) so that M is displayed.
- 3 Press \wedge (Z) once so that the indicator appears.

To cancel backlight compensation

Press \wedge (Z) twice so that the indicator disappears.

Spot Exposure Control



Selection of a spot metering area enables more precise exposure compensation. You can select one of the three metering areas.

- 1 Set the power switch to
- 2 Press and hold \triangleright (A/M) so that M is displayed.
- 3 Press \wedge (Z) twice so that the indicator appears.
 - The spot metering area frame (C) appears at the center.
- 4 Press \langle / \rangle to select the desired spot metering area frame.
- 5 Press \blacktriangleright . The setting is completed.

To lock the exposure

After step 4, press and hold \blacktriangleright for over 2 seconds. The indicator appears.

To cancel spot exposure control

Press \wedge (Z) once so that the indicator disappears.

NOTES:

- Spot exposure control may not be possible when some other functions are activated.
- Depending on the shooting location and condition, optimum result may not be attained.

Flash



You can use the flash for still image recording. The flash mode can be changed as required.

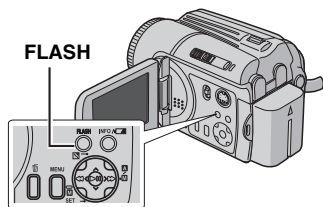

- 1 Set the power switch to
- 2 Set the MODE switch to
- 3 Press **FLASH** repeatedly to select the desired flash mode.

- The selected mode indicator will be displayed on the screen.

⚡ A [AUTO]: The flash fires automatically when the surroundings are dark.

⚡ A AUTO RED-EYE: The flash fires automatically but reduces the red-eye phenomenon of the subject's eyes.

⚡ ON: The flash fires regardless of the shooting condition.

⚡ S SLOW SYNCHRO: The flash fires regardless of the shooting condition. The shutter speed becomes slower in this mode, so the background can also be brightened.

[] = Factory-preset

When not using the flash

Press **FLASH** repeatedly until no flash mode indicator is displayed on the screen.

NOTES:





- The flash and the continuous shooting cannot be used at the same time. The unusable mode indicator blinks or goes out.
- The flash mode indicator also blinks while charging the flash.
- If the flash mode is selected before turning the LCD monitor, you can continue to use the flash after the LCD monitor is turned 180°, even though the flash mode indicator will disappear. The flash mode cannot be selected after the LCD monitor is turned 180°. (☞ pg. 9)
- If the flash is not bright enough, set [GAIN] to [AUTO] or [160]. (☞ pg. 51) Alternatively, set [S.SP] to [NIGHTLIVE] in the MSET menu. (☞ pg. 35)

Manual Settings in MSET Menu



You can use manual recording functions easily by selecting items in the MSET menus.

How to Select a Menu Item

- 1 Set the power switch to .
- 2 Press and hold \triangleright (/) so that  is displayed.
- 3 Press \sphericalangle (SET). The menu screen appears.
- 4 Press \sphericalangle / \triangleright to select a desired item from the MSET menu, then press \blacktriangleright .

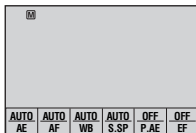

There are 6 items in the MSET menu.

- AE:** Manual Exposure (\sphericalangle pg. 32)
AF: Manual Focus (\sphericalangle pg. 33)
WB: White Balance (\sphericalangle pg. 34)
S.SP: Shutter Speed (\sphericalangle pg. 35)
P.AE: Program AE (\sphericalangle pg. 36)
EF: Effect (\sphericalangle pg. 36)

Step 5 and 6 below are example of the manual exposure setting.

- 5 Press \sphericalangle / \triangleright to select a setting, then press \blacktriangleright . The setting is completed.
- 6 Press \sphericalangle (SET) to close the MSET menu.

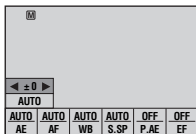

NOTE:

While recording is in progress, [S.SP], [P.AE] and [EF] cannot be set even if \sphericalangle (SET) is pressed.

Manual Exposure

Manual exposure is recommended in the following situations:

- When shooting using reverse lighting or when the background is too bright.
- When shooting on a reflective natural background such as at the beach or when skiing.
- When the background is overly dark or the subject is bright.

- 1 Select [AE] in the MSET menu. (\sphericalangle pg. 32)
- 2 If [AUTO] is selected, press \wedge . (video mode only)
- 3 To brighten the image, press \triangleright . To darken the image, press \sphericalangle .
 - Adjustment range
 - For video recording: -6 to +6 or AUTO (automatic exposure)
 - For still image recording: -2.0 to +2.0 (EV)
- 4 Press \blacktriangleright . The setting is completed.
- 5 Press \sphericalangle (SET) to close the MSET menu.

To lock the exposure

After step 5, press and hold \blacktriangleright for over 2 seconds. The  indicator appears.

NOTES:

- You cannot use the manual exposure at the same time when [P.AE] is set to [SPOTLIGHT] or [SNOW] (\sphericalangle pg. 36), or with backlight compensation (\sphericalangle pg. 31).
- If the adjustment does not make any visible change in brightness, set [GAIN UP] to [ON] when recording videos (\sphericalangle pg. 50), or set [GAIN] to [AUTO] when recording still images (\sphericalangle pg. 51).

Manual Focus

The camera's Full Range AF system offers continuous focusing ability from close-up to infinity. However, the correct focus may not be obtained depending on the shooting condition. In this case, use the manual focus mode.

1 Select [AF] in the MSET menu. (→ pg. 32)

2 If [AUTO] is selected, press \wedge , then press \blacktriangleright .

3 Press \blacktriangleright to focus on a nearer subject.

(\blacktriangle \blacktriangleright \blacktriangle)

Press \blacktriangleleft to focus on a further subject.

(\blacktriangle \blacktriangleleft \blacktriangle)

- When the focus level cannot be adjusted any further or nearer, \blacktriangle or \blacktriangle will blink.



Focusing on a further subject



Focusing on a nearer subject

To return to automatic focus

Select [AUTO] in step **2**.

Manual focus is recommended in situations listed below:

- When two subjects overlap in the same scene.
 - When illumination is low.*
 - When the subject has no contrast (difference in brightness and darkness), such as a flat, one-color wall, or a clear, blue sky.*
 - When a dark object is barely visible in the display.*
 - When the scene contains minute patterns or identical patterns that are regularly repeated.
 - When the scene is affected by sunbeams or light reflecting off the surface of a body of water.
 - When shooting a scene with a high-contrast background.
- * The following low-contrast warnings appear blinking: \blacktriangle , \blacktriangleleft , \blacktriangleright , and \blacktriangle .

White Balance

The white balance is usually adjusted automatically for correctness of the color reproduction under various lighting. However, you can also select the following modes according to the shooting situations.

1 Select [WB] in the MSET menu. (⇨ pg. 32)

2 Press \wedge/\vee to select the desired mode.

 **MWB**: For adjusting the white balance manually depending on the light source.

 "Manual White Balance Adjustment"
(⇨ pg. 34)

 **FINE**: When shooting outdoors on a sunny day.

 **CLOUD**: When shooting outdoors on a cloudy day.

 **HALOGEN**: When a video light or similar type of lighting is used.

3 Press \blacktriangleright until . The setting is completed.

4 Press \vee (MSET) to close the MSET menu.

To return to automatic white balance

Select [AUTO] in step **2**.

Manual White Balance Adjustment

1 Select [MWB] in WB menu. (⇨ pg. 34)

2 Hold a sheet of plain white paper in front of the subject. Adjust zoom or position yourself so that the white paper fills the screen.

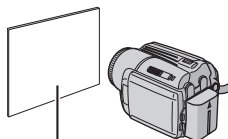

White paper

3 Press and hold \blacktriangleright until  indicator begins blinking then stops blinking.

NOTES:

- In step **2**, it may be difficult to focus on the white paper. In such a case, adjust with manual focusing. (⇨ pg. 33)
- A subject can be shot under various types of lighting conditions indoors (natural, fluorescent, candlelight, etc.). Because the color temperature is different depending on the light source, the subject tint will differ depending on the white balance settings. Use this function for a more natural result.
- Once you adjust white balance manually, the setting is retained even if the power is turned off or the battery is removed.

Shutter Speed



You can set the shutter speed manually. A fast shutter speed can freeze the motion of a fast-moving subject and a slow shutter speed can blur the subject to give the impression of motion.

1 Select [S.SP] in the MSET menu. (pg. 32)

2 If [AUTO] is selected, press \wedge .

3 Press \langle / \rangle to select the desired shutter speed. The shutter speed is displayed. You can select the shutter speed from the followings.

- If you cannot change the value, press \blacktriangleright II.

| | |
|---|---|
| NIGHTALIVE | The shutter speed is fixed at 1/2 second. This enables shooting with little light in dim locations. The  indicator appears. |
| 1/4 1/8 1/15 1/30 | Slow shutter speed can blur the subject to give the impression of flowing motion. |
| 1/60 | The shutter speed is fixed at 1/60 second. Black bands that usually appear when shooting a TV screen become narrower. |
| 1/100 | The shutter speed is fixed at 1/100 second. The flickering that occurs when shooting under a fluorescent light or mercury-vapor lamp is reduced. |
| 1/250 1/500 1/1000* 1/2000* 1/4000* | Fast shutter speed allows fast-moving subject to be captured one frame at a time vividly. Use these settings when an automatic adjustment does not work well by  (SPORTS) mode in Program AE. (pg. 36) |

* Not available for still image recording.

4 Press \blacktriangleright II. The setting is completed.

To change the shutter speed

Press \blacktriangleright II, then select the shutter speed by pressing \langle / \rangle and press \blacktriangleright II.

To return to automatic shutter speed

Select [AUTO] in step 3.

NOTES:

- It is recommended to use a tripod when recording with a slow shutter speed.
- The shutter speed can be set separately in video and still image.

Program AE

You can use the program AE settings for specific shooting situations.

1 Select [P.AE] in the MSET menu. (⇨ pg. 32)

2 Press \wedge/\vee to select the desired mode.

 **TWILIGHT**: Makes evening scenes look more natural.

 **SPOTLIGHT**: The subject in the front is accentuated by blurring the background.

 **SPORTS**: Fast shutter speed allows fast-moving subject to be captured one frame at a time vividly. The shutter speed is set at 1/250 to 1/4000 second automatically.

 **SNOW**: Compensates for subjects that may appear too dark when shooting in extremely bright surroundings such as in the snow.

3 Press \blacktriangleright II. The setting is completed.

To turn off the program AE function

Select [OFF] in step **2**.

Effect

You can record videos or still images with special effects.

1 Select [EF] in the MSET menu. (⇨ pg. 32)

2 Press \wedge/\vee to select the desired mode.

 **SEPIA**: The image has a brownish tint like old photos.

B/W **MONOTONE**: The image becomes black and white like old movies.

 **CLASSIC FILM***: The image has an old movie atmosphere by the effect of skipping frames.

 **STROBE***: The image looks like a series of consecutive snapshots.

* Not available for still image recording.

3 Press \blacktriangleright II. The setting is completed.

4 Press \vee (MSET) to close the MSET menu.











To turn off the effect

Select [OFF] in step **2**.

Wipe or Fader Effects



You can view videos with various effects of scene transition.







- 1 Set the power switch to .
- 2 Set the **MODE** switch to .
- 3 Press **MENU**. The menu screen appears.
- 4 Press \wedge/\vee to select [WIPE/FADER], then press **▶II**.
- 5 Press \wedge/\vee to select a desired effect.
 -  **FADER-WHITE**: Fade in or out with a white screen.
 -  **FADER-BLACK**: Fade in or out with a black screen.
 -  **FADER-B.W**: Fade in to a color screen from a black and white screen, or fade out from color to black and white.
 -  **WIPE-CORNER**: Wipe in on a black screen from the upper right to the lower left corner, or wipe out from lower left to upper right, leaving a black screen.
 -  **WIPE-WINDOW**: The scene starts in the center of a black screen and wipes in toward the corners, or comes in from the corners, gradually wiping out to the center.
 -  **WIPE-SLIDE**: Wipe in from right to left, or wipe out from left to right.
 -  **WIPE-DOOR**: Wipe in as the two halves of a black screen open to the left and right, revealing the scene, or wipe out and the black screen reappears from left and right to cover the scene.
 -  **WIPE-SCROLL**: The scene wipes in from the bottom to the top of a black screen, or wipes out from top to bottom, leaving a black screen.
 -  **WIPE-SHUTTER**: Wipe in from the center of a black screen toward the top and bottom, or wipe out from the top and bottom toward the center leaving a black screen.
- 6 Press **▶II**. The setting is completed.
- 7 Press **MENU** to close the menu screen.
 - The selected wipe or fader effect works when playback starts and ends.

To turn off the effect
Select [OFF] in step 5.

Playback Effects



You can view videos or still images with special image effects.

- 1 Set the power switch to .
- 2 Set the **MODE** switch to  or .
- 3 Press **MENU**. The menu screen appears.
- 4 Press \wedge/\vee to select [EFFECT], then press **▶II**.
- 5 Press \wedge/\vee to select a desired effect.
 -  **SEPIA**: The image has a brownish tint like old photos.
 - B/W **MONOTONE**: The image becomes black and white like old movies.
 -  **CLASSIC FILM***: The image has an old movie atmosphere by the effect of skipping frames.
 -  **STROBE***: The image looks like a series of consecutive snapshots.
- * Not available for still image recording.
- 6 Press **▶II**. The setting is completed.
- 7 Press **MENU** to close the menu screen.

To turn off the effect
Select [OFF] in step 5.

Viewing File Information



You can view the file information in playback mode.

Information on Video Files

Press **INFO**/ while video playback is paused. File information appears.

FILE: File name

FOLDER: Folder name

DATE/TIME: Date and time of the recording

PB TIME: Playback time (length of the file)

QUALITY: Image quality (⇄ pg. 50)

PROTECT: File protection status (⇄ pg. 38)

- If you press **INFO**/ on the index screen (⇄ pg. 25), information on the selected file is displayed.

To turn off the file information display

Press **INFO**/ repeatedly.

Information on Still Image Files

Press **INFO**/ while a still image is displayed. File information appears.

FILE: File name

FOLDER: Folder name

DATE/TIME: Date and time of the recording

SIZE: Image size (⇄ pg. 51)

QUALITY: Image quality (⇄ pg. 51)

PROTECT: File protection status (⇄ pg. 38)

- If you press **INFO**/ on the index screen (⇄ pg. 29), information on the selected file is displayed.

To turn off the file information display

Press **INFO**/ repeatedly.

Protecting Files



You can protect files from the accidental erasure.

- 1 Set the power switch to .
- 2 Select the file type (video or still image) using the **MODE** switch.
- 3 Press **MENU**. The menu screen appears.
- 4 Press \wedge / \vee to select [PROTECT], then press **▶II**.

To protect the currently displayed file

- 5 Press \wedge / \vee to select [CURRENT], then press **▶II**.
- 6 Press \wedge / \vee to select [EXECUTE], then press **▶II**.
 - You can select the previous or next file by pressing \langle / \rangle .
 - To release protection, select the protected file, then perform step 5 and 6.

To protect by selecting multiple files

- 5 Press \wedge / \vee to select [FILE SELECT], then press **▶II**.
 - The index screen appears.
- 6 Press $\wedge / \vee / \langle / \rangle$ to select the file you want to protect, then press **▶II**.
 - The mark appears on the file.
 - To protect other files, repeat step 6.
 - The scroll bar can also be used with the zoom lever and pressing \wedge / \vee . (⇄ pg. 25, 30)
 - If you slide the zoom lever towards **T**, the preview screen is displayed. Sliding the zoom lever towards **W** returns to the index screen.
- 7 Press **MENU**.
- 8 Press \wedge / \vee to select [QUIT], then press **▶II**.
 - The selected files are protected.
 - To release protection, select the protected file in step 6.

To protect all files

5 Press \wedge/\vee to select [PROTECT ALL], then press **▶II**.

6 Press \wedge/\vee to select [EXECUTE], then press **▶II**.

- All files are protected.

To release protection of all files

5 Select [CANCEL ALL], then press **▶II**.

6 Press \wedge/\vee to select [EXECUTE], then press **▶II**.

CAUTION:

Do not remove the recording medium or perform any other operation (such as turning off the power) during protection. Also, be sure to use the provided AC adapter, as the data on the recording medium may be corrupted if the battery becomes exhausted during protection. If the data on the recording medium becomes corrupted, format it. (➡ pg. 20)

Deleting Files

You can delete unnecessary files.

Deleting by the  Button

1 Set the power switch to .

2 Select the file type (video or still image) using the **MODE** switch.

3 Press $\wedge/\vee/ </>$ to display the desired file, then press .

- You can also select the file on the index screen. (➡ pg. 25, 29)

4 Press \wedge/\vee to select [EXECUTE], then press **▶II**.

NOTE:

If you press  during recording mode, the file recorded most recently will be deleted. However, if the recording mode (video or still image) is switched or the power is turned off and on again after recording, you cannot delete the file.

Deleting on the Menu Screen

1 Set the power switch to .

2 Select the file type (video or still image) using the **MODE** switch.

3 Press **MENU**. The menu screen appears.

4 Press \wedge/\vee to select [DELETE], then press **▶II**.

To delete the currently displayed file

5 Press \wedge/\vee to select [CURRENT], then press **▶II**.

6 Press \wedge/\vee to select [EXECUTE], then press **▶II**.

- You can select the previous or next file by pressing $</>$.

To delete by selecting multiple files

5 Press \wedge / \vee to select [FILE SELECT], then press **▶II**.

- The index screen appears.

6 Press \wedge / \vee / \langle / \rangle to select the file you want to delete, then press **▶II**.

- To select other files, repeat step **6**.
- The scroll bar can also be used with the zoom lever and pressing \wedge / \vee . (☞ pg. 25, 30)
- If you slide the zoom lever towards T, the preview screen is displayed. Sliding the zoom lever towards W returns to the index screen.

7 Press **MENU**.

8 Press \wedge / \vee to select [EXECUTE AND QUIT], then press **▶II**.

- The selected files are deleted.

To delete all files

5 Press \wedge / \vee to select [DELETE ALL], then press **▶II**.

6 Press \wedge / \vee to select [EXECUTE], then press **▶II**.

- To cancel deletion, select [CANCEL], then press **▶II**.

NOTES:

- Protected files cannot be deleted. To delete them, release protection first. (☞ pg. 39)
- Once files are deleted, they cannot be restored. Check files before deleting.

CAUTION:

Do not remove the recording medium or perform any other operation (such as turning off the power) during deletion. Also, be sure to use the provided AC adapter, as the recording medium may be corrupted if the battery becomes exhausted during deletion. If the recording medium becomes corrupted, format it. (☞ pg. 20)

Cleaning Up a Recording Medium



Writing speed of recording media tends to become slow after long period of repeated use. To regain the speed, execute cleanup periodically. The cleanup function is equivalent to "Defragmentation" of PC's function.

NOTES:

- Make sure to use the provided AC adapter for the power supply when cleaning up a recording medium. (☞ pg. 16)
- It is recommended to run check disk regularly on the PC, on condition that there is no data on the hard disk of the camera.

1 Set the power switch to or .

2 Press **MENU**. The menu screen appears.

3 Press \wedge / \vee to select [REC MEDIA SETTING], then press **▶II**.

4 Press \wedge / \vee to select [CLEAN UP], then press **▶II**.

5 Press \wedge / \vee to select [HDD] or [SD], then press **▶II**.

- If the AC adapter is not connected to the camera, a warning message appears. In this case, connect the AC adapter.

6 Press \wedge / \vee to select [EXECUTE], then press **▶II**.

- To cancel cleanup, select [CANCEL], then press **▶II**.

7 When cleanup is finished, [CLEANING UP COMPLETED] appears. Press **▶II** to complete the operation.

- Depending on the hard disk drive it may take several minutes for this process to be completed.

CAUTION:

Do not remove the recording medium or perform any other operation (such as turning off the power) during cleanup.

Copying/Moving Still Image Files



You can copy or move still image files between the built-in hard disk (HDD) and SD card using the on-screen display.

Before proceeding to following steps,

- Make sure that SD card is inserted in the SD slot.
- Make sure that enough free space is left in the copy/move destination medium.

- 1 Set the power switch to or .
- 2 Press **MENU**. The menu screen appears.
- 3 Press \wedge/\vee to select [REC MEDIA SETTING], then press \blacktriangleright .
- 4 Press \wedge/\vee to select [COPY/MOVE], then press \blacktriangleright .
- 5 Press \wedge/\vee to select [COPY] or [MOVE], then press \blacktriangleright .

COPY: Files are copied to the destination medium while leaving original files in the source medium.

MOVE: Files are moved to the destination medium while deleting original files (except read-only files) in the source medium.

- 6 Press \langle/\rangle to select the direction of copy/move, then press \vee . (HDD \rightarrow SD or SD \rightarrow HDD)

To copy or move by selecting files

- 7 Press \langle/\rangle to select [FILE], then press \blacktriangleright .
 - The index screen appears.
- 8 Press $\wedge/\vee/\langle/\rangle$ to select a desired file, then press \blacktriangleright .
 - The check mark () appears on the selected file.
 - To select other files, repeat this step.
 - The scroll bar can also be used with the zoom lever and \wedge/\vee . (pg. 30)

- 9 Press **MENU** to return to the previous screen.

- 10 Press \wedge/\vee to select [EXECUTE], then press \blacktriangleright .

- 11 File transfer starts.

- To stop the file transfer, press \blacktriangleright , then select [EXECUTE] and press \blacktriangleright .

- 12 When [COPYING (MOVING) COMPLETED] appears, press \blacktriangleright to finish the operation.

To copy or move all still image files in the recording medium

- 7 Press \langle/\rangle to select [ALL].

- 8 Press \wedge/\vee to select [EXECUTE], then press \blacktriangleright .

- If you want to cancel, select [CANCEL], then press \blacktriangleright .



- 9 File transfer starts.

- To stop the file transfer, press \blacktriangleright , then select [EXECUTE] and press \blacktriangleright .

- 10 When [COPYING (MOVING) COMPLETED] appears, press \blacktriangleright to finish the operation.



Resetting the File Number

By resetting the file number (name), a new folder will be made. The new files you are going to make will be stored in the new folder. It is convenient to separate the new files from previously recorded files.

- 1 Set the power switch to  or .
- 2 Press **MENU**. The menu screen appears.
- 3 Press \wedge/\vee to select [REC MEDIA SETTING], then press **▶II**.
- 4 Press \wedge/\vee to select [NO. RESET], then press **▶II**.
- 5 Press \wedge/\vee to select the file type (video or still image), then press **▶II**.
- 6 Press \wedge/\vee to select [EXECUTE], then press **▶II**.
- 7 Press **▶II**.
 - The new folder (such as [101JVCSO]) will be made and the file number will start again from the new number (such as "PIC_0001.JPG").

Creating Play List

You can create a play list by collecting the desired scenes from the previously recorded video files.

- 1 Set the power switch to .
- 2 Set the **MODE** switch to .
- 3 Press **MENU**. The menu screen appears.
- 4 Press \wedge/\vee to select [PLAYLIST], then press **▶II**.
- 5 Press \wedge/\vee to select [EDIT], then press **▶II**.
- 6 Press \wedge/\vee to select [NEW LIST], then press **▶II**.
- 7 Press \wedge/\vee to scroll upward or downward the thumbnail images of recorded files, and select a file to be added to a play list.
 - The scroll bar can also be used with the zoom lever and pressing \wedge/\vee . (☞ pg. 25)

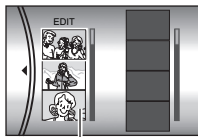

Thumbnail images of recorded files

- 8 Press **▶II**. The frame for selecting an inserting point appears.
- 9 Press \wedge/\vee to scroll upward or downward the thumbnail of images in a play list, and select a position where you want to insert the selected file.
 - The scroll bar can also be used with the zoom lever and pressing \wedge/\vee . (☞ pg. 25)
- 10 Press **▶II**. The selected file is added to a play list.
 - To add other files, repeat steps 7 to 10.
- 11 Press **MENU**. The confirmation screen appears.
- 12 Press \wedge/\vee to select [SAVE AND QUIT], then press **▶II**.
 - To return to the edit screen, select [CANCEL].
 - If you do not want to save the play list, select [DELETE AND QUIT].

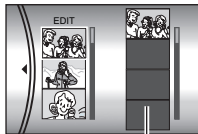

Play list

To check the play list by playing back the video

You can check the play list before saving it.

1 After step **10**, press **>** to select a thumbnail image of the play list.

2 Press **^/∨** to select a scene you want to check.

3 Press **▶II**. The playback of the play list starts from the selected scene.

- The playback stops at the end of the play list automatically.
- To stop playback midway, press **▶II**, then slide the zoom lever towards **W**.

To check only the scene transition

1 After step **10**, press **>** to select a scene transition.

- If a scene is selected, press **>** once more to select the scene transition bar.

2 Press **^/∨** to select a scene transition you want to check.

3 Press **▶II** to start playback of the selected scene transition.

To delete the added file from the play list

1 After step **10**, press **>** to select a thumbnail image of the play list.

2 Press **^/∨** to select the file you want to delete, then press **⏏**.

NOTES:

- You can display the play list menu simply by pressing the PLAYLIST button on the remote control.
- Maximum of 99 play lists can be created.
- Each play list can consist of maximum 99 scenes.
- If you delete the original files, the files are also deleted from the play list.
- Files in the [EXTMOV] folder cannot be used to create play lists.

Playing Back Play List



By playing back the play list, you can view your original video clips. (To create play list, [☞](#) pg. 42)

1 Set the power switch to **▶**.

2 Set the **MODE** switch to **⏏**.

3 Press **MENU**. The menu screen appears.

4 Press **^/∨** to select [PLAYLIST], then press **▶II**.

5 Press **^/∨** to select [PLAYLIST CONTENTS], then press **▶II**. The table of play lists appears.

6 Press **^/∨** to select a list you want to play back.

(The display format of date and time differs depending on the country where this camera is sold.)

- The scroll bar can also be used with the zoom lever and pressing **^/∨**. ([☞](#) pg. 25)

7 Press **▶II** to start playback.

- During playback of play list, "P" mark appears on the top left corner of the screen.

• If you slide the zoom lever towards **W** while playback is paused, the index screen for play list appears. You can see the contents of the play list and select the desired scene. To return to playback screen, slide the zoom lever to **T**.

- You can use various playback functions during playback. ([☞](#) pg. 25)

8 To stop playback, press **▶II**.

- To return to the normal playback mode, select [ALL SCENES] in step **6**.

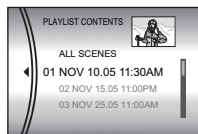

NOTE:

You can display the play list menu simply by pressing the PLAYLIST button on the remote control.





Add/Delete Files in Play List

You can edit existing play lists by adding or deleting files.

- 1** Set the power switch to .
 - 2** Set the **MODE** switch to .
 - 3** Press **MENU**. The menu screen appears.
 - 4** Press \wedge/\vee to select [PLAYLIST], then press **▶II**.
 - 5** Press \wedge/\vee to select [EDIT], then press **▶II**.
 - 6** Press \wedge/\vee to select the play list you want to edit, then press **▶II**.
- To add or delete files, follow the steps **7** to **12** in “Creating Play List” (➤ pg. 42), or **1** to **2** in “To delete the added file from the play list” (➤ pg. 43).



Changing Play List Name

The default name of play list is its creation date and time. You can change the name on the keyboard screen as you like.

- 1** Set the power switch to .
- 2** Set the **MODE** switch to .
- 3** Press **MENU**. The menu screen appears.
- 4** Press \wedge/\vee to select [PLAYLIST], then press **▶II**.
- 5** Press \wedge/\vee to select [RENAME], then press **▶II**. The table of play lists appears.
- 6** Press \wedge/\vee to select a play list whose name you want to change.
 - The scroll bar can also be used with the zoom lever and pressing \wedge/\vee . (➤ pg. 25)
 - The thumbnail appears on the upper right side.
- 7** Press **▶II**. The keyboard screen appears.
- 8** Press $\wedge/\vee/\langle/\rangle$ to select the desired letter, then press **▶II**.
 - Repeat this process to complete the name.
 - You can change the character types (capital letters, small letters or marks) by selecting [A/a/@].
- To correct a letter, select [\leftarrow] or [\rightarrow] and press **▶II** to move the cursor to the letter, then select [CLEAR] and press **▶II**.
- 9** Press $\wedge/\vee/\langle/\rangle$ to select [\leftarrow], then press **▶II**.
 - To cancel the setting, select [CANCEL], then press **▶II**.

Deleting Play List

You can delete unnecessary play lists.

- 1** Set the power switch to .
- 2** Set the **MODE** switch to .
- 3** Press **MENU**. The menu screen appears.
- 4** Press \wedge/\vee to select [PLAYLIST], then press **▶II**.
- 5** Press \wedge/\vee to select [DELETE], then press **▶II**. The table of play lists appears.
- 6** Press \wedge/\vee to select a play list you want to delete.
 - The thumbnail appears on the upper right side.
 - To delete all play lists at once, select [DELETE ALL].
- 7** Press **▶II**.
- 8** Press \wedge/\vee to select [EXECUTE], then press **▶II**. The selected play list is deleted.
 - To cancel the setting, select [CANCEL], then press **▶II**.
 - Original files are not deleted even if you delete the play list.

Dubbing Using Play List

Dubbing to an external device (VCR, DVD recorder etc.) using a play list is possible. The following explains how to dub to a VCR, but the same steps also apply for a DVD recorder, etc.

- 1** Connect the camera and your VCR with the S/AV cable. (☞ pg. 26)
- 2** Set the VCR to VIDEO/AUXILIARY input and engage the recording standby mode.
 - For details on how to set VIDEO/AUXILIARY input, refer to VCR instructions.
- 3** Set the power switch to .
- 4** Set the **MODE** switch to .
- 5** Press **MENU**. The menu screen appears.
- 6** Press \wedge/\vee to select [PLAYLIST], then press **▶II**.
- 7** Press \wedge/\vee to select [PLAYLIST CONTENTS], then press **▶II**. The table of play lists appears.
- 8** Press \wedge/\vee to select a list you want to dub.
 - The scroll bar can also be used with the zoom lever and pressing \wedge/\vee . (☞ pg. 25)
- 9** Press \gt . Screen for dubbing appears.
- 10** Press \wedge/\vee to select [START PLAYBACK], then press **▶II**. Playback on the camera starts.
 - The black screen is displayed for 5 seconds at the beginning and the end of the play list playback.
 - To cancel the setting, press \wedge/\vee to select [CANCEL], then press **▶II**.
- 11** While the black screen is displayed for 5 seconds, start recording on the VCR. (Refer to your VCR's instruction manual.)
- 12** To stop dubbing, stop recording on the VCR while the black screen is displayed for 5 seconds.

DPOF Print Setting



This camera is compatible with DPOF (Digital Print Order Format). You can set which images to be printed and the number of prints with this camera. This feature is useful to print with a DPOF-compatible printer or bring a recording medium to photo lab for print.

To print by selecting a still image

- 1 Set the power switch to .
- 2 Set the **MODE** switch to .
- 3 Press **MENU**. The menu screen appears.
- 4 Press \wedge/\vee to select [DPOF], then press **▶II**. The DPOF menu screen appears.
- 5 Press \wedge/\vee to select [SELECT IMAGES], then press **▶II**.

6 Press $\wedge/\vee/\langle/\rangle$ to select the desired file, then press **▶II**.

- The scroll bar can also be used with the zoom lever and pressing \wedge/\vee . (☞ pg. 30)
- If you slide and hold the zoom lever towards **T**, the preview screen of the still image is displayed.

7 Press \langle/\rangle to select the number of prints (max. 15 prints), then press **▶II**.

- To set print information for other images, repeat steps 6 and 7.

8 Press **MENU** to finish the setting.

- To cancel the selection, select the same image in step 6.

NOTES:

- The DPOF setting is available up to 999 images.
- DPOF printing can only be specified for still images stored on the SD card. To specify still images stored on the hard disk, you must first copy the image files onto the SD card before setting printing. (☞ pg. 41)
- The date index function cannot be used.

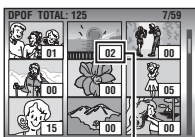
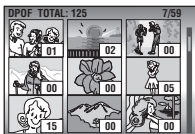

Number of prints

To print all still images (One print for each)

- 1 Display the DPOF menu screen. (☞ "To print by selecting a still image")
- 2 Press \wedge/\vee to select [ALL1], then press **▶II**.
- 3 Press \wedge/\vee to select [EXECUTE], then press **▶II**.
- 4 Press **MENU** to finish the setting.

To confirm the DPOF setting

- 1 Display the DPOF menu screen. (☞ "To print by selecting a still image")
- 2 Press \wedge/\vee to select [CHECK SETTINGS], then press **▶II**.
- 3 If necessary, change the number of prints for the desired file by following the steps 6 to 7 in "To print by selecting a still image".
- 4 Press **MENU** to return to the previous menu.

To reset the DPOF setting

- 1 Display the DPOF menu screen. (☞ "To print by selecting a still image")
- 2 Press \wedge/\vee to select [RESET], then press **▶II**.
- 3 Press \wedge/\vee to select [EXECUTE], then press **▶II**.
- 4 Press **▶II** to finish the reset.

Direct Printing with a PictBridge Printer

If your printer is compatible with PictBridge, still images can be printed easily by connecting the camera with the USB cable directly to the printer. DPOF setting can also be used.

(pg. 46)

NOTE:

After selecting [DIRECT PRINT] in the menu, connect the USB cable.

To print by selecting a still image

- 1 Set the power switch to .
- 2 Set the **MODE** switch to .
- 3 Press **MENU**. The menu screen appears.
- 4 Press \wedge/\vee to select [DIRECT PRINT], then press **▶II**. A message [PLEASE CONNECT PRINTER] appears.
- 5 Connect the camera to the printer with the USB cable.
 - After a while, the print menu appears.
- 6 Press \wedge/\vee to select [SELECTED PRINT], then press **▶II**.
- 7 Press \langle/\rangle to select the desired file, then press **▶II**.
- 8 Press \langle/\rangle to set the number of prints.
 - The number of prints can be set from 1 to 99.
- 9 Press \wedge/\vee to select [DATE], then press \langle/\rangle to select [ON] or [OFF].
 - Select [ON] to print the date or [OFF] not to print.
- 10 Press \wedge/\vee to select [PRINT], then press **▶II**. The image is printed.

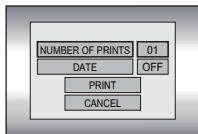

To cancel print setting

Press \wedge/\vee to select [CANCEL], then press **▶II**.

To stop printing after printing starts

- 1 Press **▶II**. The confirmation screen appears.
- 2 Press \wedge/\vee to select [EXECUTE], then press **▶II**.

To print using the DPOF setting

If the printer is compatible with DPOF, you can use the DPOF setting. (pg. 46)

- 1 Set the power switch to .
- 2 Set the **MODE** switch to .
- 3 Press **MENU**. The menu screen appears.
- 4 Press \wedge/\vee to select [DIRECT PRINT], then press **▶II**. A message [PLEASE CONNECT PRINTER] appears.
- 5 Connect the camera to the printer with the USB cable.
 - After a while, the print menu appears.
- 6 Press \wedge/\vee to select [DPOF PRINT], then press **▶II**.
- 7 Press \wedge/\vee to select [PRINT], then press **▶II**. The images are printed.
 - To confirm the DPOF setting, press \wedge/\vee to select [CHECK SETTINGS], then press **▶II**. After that, press **MENU** to return to the previous menu.

NOTE:

If the printer is not recognized, or to print again after direct printing with a PictBridge printer, remove the USB cable, select [DIRECT PRINT] in the menu again, and then reconnect the cable.

Changing the Menu Settings

You can change the menu settings to customize your camera. Access the desired menu screen by following the steps below, then change the various settings.

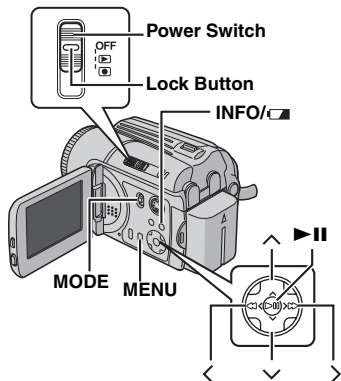

1 Select the operation mode.

For Recording Menus:



Set the power switch to .



For Playback Menus:

Set the power switch to .

2 Select  (video) or  (still image) using the **MODE** switch.

3 Press **MENU**. The menu screen appears.

4 Select the desired sub menu and menu item with ,  and .

- To return to the normal screen, press **MENU**.
- To display the operation guide, press **INFO/**  when the menu screen is displayed. (The operation guide is not displayed depending on the type of the menu.) To remove the operation guide, press **INFO/**  again.
- Even if the menu item is displayed, some item cannot be set depending on the selected mode (video/still image, recording/playback). In this case, sub menu cannot be accessed or setting cannot be changed.

Common Menus for All Modes

[] = Factory-preset

BASIC SETTING

PRESET

EXECUTE: Resets all settings to the factory-preset.

[CANCEL]: Returns to the menu screen without executing reset.

DEMO MODE

OFF: Disables the function.

[ON]: Activates demonstration mode and shows various features on the display.

Demonstration starts in the following cases:

- When the menu screen is closed after [DEMO MODE] is set to [ON].
- With [DEMO MODE] set to [ON], if there is no operation for about 3 minutes after the power switch is set to .
- Performing any operation during the demonstration stops the demonstration temporarily. If no operation is performed for more than 3 minutes after that, the demonstration will resume.

NOTES:

- Demonstration only works with DC cord connected, not with battery.
- If an SD card is in the camera, demonstration will not take place even if it is set to [ON].
- [DEMO MODE] remains [ON] even if the camera power is turned off.

OPERATION SOUND

OFF: Turns off operation sound.

BEEP: The beep sounds when the power is turned on or off, and at the beginning and end of recording.

[MELODY]: Instead of a beep, a melody sounds when any operation is performed.

REMOTE

OFF: Makes the camera not to receive the signal from the remote control.

[ON]: Enables the operation with the remote control.

DROP DETECTION

OFF: Disables the function.

[ON]: Turns off the power automatically to prevent HDD damage when the camera is accidentally dropped. (☞ pg. 21)

CAUTION:

Setting this function to off increases the chances of damaging the internal hard disk if the camera is accidentally dropped.

❁ REC MEDIA SETTING

VIDEO MODE**[HDD] / SD****IMAGE MODE****[HDD] / SD**

Media selection can be set for each recording and playback mode: video (📹) or still image (📷).

HDD: The built-in hard disk is selected as a recording medium.

SD: SD card is selected as a recording medium.

FORMAT**[HDD] / SD**

You can format (initialize) the built-in hard disk or SD cards. (☞ pg. 20)

CLEAN UP**[HDD] / SD**

Writing speed of recording media tends to become slow after long period of repeated use. To regain the speed, execute cleanup periodically. (☞ pg. 40)

COPY/MOVE**[COPY] / MOVE**

You can copy or move still image files between the built-in hard disk and SD card. (☞ pg. 41)

NO. RESET**[VIDEO] / IMAGE**

By resetting the file number (name), a new folder will be made. The new files you are going to make will be stored in the new folder. (☞ pg. 42)

⏪ DISPLAY

BRIGHT

When this item is selected, the brightness control indicator appears. Adjust the brightness of the display using </>, then press ►II.

(☞ pg. 18)

DATE/TIME

OFF: The date/time does not appear.

[AUTO]: Displays the date/time for approx. 5 seconds in the following cases.

- When the power switch is set from **OFF** to
- When playback starts
- When the date is changed during playback

ON: The date/time is always displayed.

NOTES:

- Only the date is displayed for the video playback.
- You can set to different setting for each mode (video recording/playback and still image recording/playback).

SCENE COUNTER

[OFF]: Disables the function.

ON: Displays the counter during video mode.

LANGUAGE

[ENGLISH] / FRANÇAIS / ESPAÑOL / PORTUGUÊS / 日本語 / 한국어 / 中文

The language setting can be changed.

(☞ pg. 17)

CLOCK ADJUST





☞ "Date/Time Settings" (☞ pg. 18)

Video Recording Menus

[] = Factory-preset

QUALITY

Select the desired picture quality.

| Mode (In order of the quality) | Size (pixels) | Bit rate |
|---|---------------|----------|
|  [ULTRA FINE] | 720 x 480 | 8.5 Mbps |
|  FINE | 720 x 480 | 5.5 Mbps |
|  NORMAL | 720 x 480 | 4.2 Mbps |
|  ECONOMY | 352 x 240 | 1.5 Mbps |

WIDE MODE

[OFF]: Disables the function.

16:9 WIDE: For playback on TVs with an aspect ratio of 16:9. Naturally expands the image to fit the screen without distortion. The  indicator appears. When using this mode, refer to your wide-screen TV's instruction manual. During playback/recording on 4:3 TVs, black bands may be inserted at the top and bottom of the screen, or the image may appear to be slightly vertically stretched, due to the ratio change.

NOTES:

- The 16:9 WIDE mode cannot be used when using ECONOMY mode.
- Use software that supports wide display when playing videos that were recorded in 16:9 WIDE mode on a PC.

WIND CUT

[OFF]: Disables the function.

ON: Helps cut down on noise created by wind. The  indicator appears.

GAIN UP

OFF: The image in the dark will be recorded with no picture brightness adjustment.

[ON]: The image in the dark will be brightened. But the overall appearance may become grainy.

DIS

OFF: Disables the function.

[ON]: Compensates for unstable images caused by camera-shake, particularly at high magnification. The  indicator appears.

NOTES:

- Accurate stabilization may not be possible if hand shake is excessive, or depending on the shooting condition. In this case, the  indicator blinks or goes out.
- Switch off this mode when recording with the camera on the tripod.

CAMERA SETTING

ZOOM

10X: Only optical zoom is available up to 10x.

[40X]: Digital zoom is available up to 40x.

200X: Digital zoom is available up to 200x.

TELE MACRO

[OFF]: Disables the function.

ON: You can shoot a subject as large as possible at a distance of approx. 50 cm (1.64 ft). The  indicator appears.

Video Playback Menus

[] = Factory-preset

PLAYLIST

[PLAYLIST CONTENTS] / EDIT / RENAME / DELETE

You can create a play list and view your original video clips. (⇨ pg. 42 – 45)

WIPE/FADER

⇨ "Wipe or Fader Effects" (⇨ pg. 37)

EFFECT

⇨ "Playback Effects" (⇨ pg. 37)

PROTECT

[CURRENT] / FILE SELECT / PROTECT ALL / CANCEL ALL

You can protect files from accidental erasure. (⇨ pg. 38)

DELETE

[CURRENT] / FILE SELECT / DELETE ALL

You can delete unnecessary files. (⇨ pg. 39)

Still Image Recording Menus

[] = Factory-preset

QUALITY

[FINE] / STANDARD

Select the desired image quality.



IMAGE SIZE

[1600 x 1200] / 1280 x 960 / 1024 x 768 /
640 x 480

Select the desired image size.

SELF-TIMER

[OFF] / 2SEC / 10SEC

By setting the self-timer, a still image is recorded 2 or 10 seconds after pressing recording start/stop button. The  or  indicator appears.

CONTINUOUS SHOOTING

[OFF]: Disables the function.

ON: You can record still images continuously.

The  indicator appears on the display.

( pg. 28)

GAIN

[AUTO] / 80 / 160

Select the ISO sensitivity to the desired setting. When set to [AUTO], the sensitivity automatically increases in dark conditions.

NOTE:

The amount of image noise increases as the setting level increases.

CAMERA SETTING

TELE MACRO

The menu item of TELE MACRO is the same as in the description on page 50.



Still Image Playback Menus

[] = Factory-preset

DPOF

 "DPOF Print Setting" ( pg. 46)

DIRECT PRINT

 "Direct Printing with a PictBridge Printer" ( pg. 47)

EFFECT

 "Playback Effects" ( pg. 37)

PROTECT

DELETE

The menu items of PROTECT and DELETE are the same as in the description on page 50.

Troubleshooting

The camera is a microcomputer-controlled device. External noise and interference (from a TV, a radio, etc.) might prevent it from functioning properly.

- To solve the problem, follow the Instructions below at first.
- If the problem is not solved, reset the camera. (Refer to "To reset the camera" below.)
- If the problem still exists, please consult your nearest JVC dealer.

■ To reset the camera

- ① Press **RESET** using a piece of wire or other such pointed instrument. The power is turned off once and turned on again automatically.

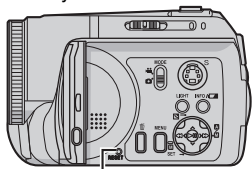

RESET

- ② If nothing happens, set the power switch to **OFF** and remove the power supply (battery pack or AC adapter) from the camera, then put it back again.
- ③ Execute [PRESET] from the menu. The camera returns to its factory-preset. (⇨ pg. 48)

Power

No power is supplied.

- The power is not connected properly.
- Connect the AC adapter securely. (⇨ pg. 14)
- The battery pack is not attached firmly.
- Detach the battery pack once again and re-attach it firmly. (⇨ pg. 14)
- The battery is dead.
- Replace the dead battery with a fully charged one. (⇨ pg. 14)

No display appears.

- When using the AC adapter, the camera enters the sleep mode, the access lamp lights, and the LCD monitor turns off.
- To cancel the sleep mode, perform any operation such as zooming.

The power was turned off accidentally.

- The drop detection function operated. (⇨ pg. 21)
- Set the power switch to **OFF**, and turn the power on again. To turn off the drop detection function, set [DROP DETECTION] to [OFF]. (⇨ pg. 49)

Recording

Recording cannot be performed.

- [MEMORY CARD IS FULL] appears.
- Replace with new recording medium or delete unnecessary files. (⇨ pg. 19, 39)
- Recording medium is not selected properly.
- Select the recording medium. (⇨ pg. 21, 48, 49)

When shooting a subject illuminated by bright light, vertical lines appear.

- This is not a malfunction.

When the screen is under direct sunlight during shooting, the screen becomes red or black for an instant.

- This is not a malfunction.

During recording, the date/time does not appear.

- [DATE/TIME] is set to [OFF].
- Set [DATE/TIME] to [ON]. (⇨ pg. 49)

The LCD monitor indications blink.

- Certain modes of program AE, effect, DIS and other functions that cannot be used together are selected at the same time.

Digital zoom does not work.

- [ZOOM] is set to [10X] (optical zoom).
- Set [ZOOM] to [40X] or [200X]. (⇨ pg. 50)
- Digital zoom is not available in the still image recording mode.

The recorded image is white

- Shutter speed is set to NIGHTALIVE or slow speed.
- NIGHTALIVE and slow speed are only for use in dark conditions. (⇨ pg. 35)

Playback**Playback cannot be performed.**

- Recording medium is not selected properly.
- Select the recording medium. (⇨ pg. 21, 48, 49)
- Playback starts, but there is no picture on the connected TV.
- Set the TV's input mode or channel appropriate for video playback.

The same image is displayed for a long time during video playback, or motion is choppy.

- If the surface of the SD card is damaged, it makes it difficult to read data and these phenomena will appear. This camera will make all possible efforts to read data, but when such a state continues for some time and further playback is impossible, it will stop automatically.
- It is recommended to run check disk regularly on the PC, on condition that there is no data on the hard disk of the camera.

Advanced features**The focus does not adjust automatically.**

- Focus is set to the manual mode.
- Set focus to the automatic mode. (⇨ pg. 33)
- The lens is dirty or covered with condensation.
- Clean the lens and check the focus again. (⇨ pg. 56)

The color of the image looks strange.

- The light source or the subject does not include white. Or there are various different light sources behind the subject.
- Try manual white balance adjustment. (⇨ pg. 34)

The recorded image is too dark.

- Shooting was performed under backlight conditions.
- Try backlight compensation (⇨ pg. 31) or manual exposure. (⇨ pg. 32)

The recorded image is too bright.

- The subject is too bright.
- Try manual exposure. (⇨ pg. 32)

White balance setting cannot be activated.

- The sepia (SEPIA) or monotone (MONOTONE) mode is activated.
- Turn off the sepia (SEPIA) or monotone (MONOTONE) mode before setting white balance. (⇨ pg. 36)

The black & white fader does not work.

- The sepia (SEPIA) or monotone (MONOTONE) mode is activated.
- Turn off the sepia (SEPIA) or monotone (MONOTONE) mode. (⇨ pg. 37)

The continuous shooting speed of still images is slow.

- The continuous shooting speed will drop when repeatedly making continuous shots, when using certain recording medium, or under certain recording conditions. (⇨ pg. 28)

Other problems**The power/charge lamp on the camera does not light during charging.**

- Charging is difficult in places subject to extremely high/low temperatures.
- To protect the battery, it is recommended to charge it in places with a temperature of 10°C to 35°C (50°F to 95°F). (⇨ pg. 57)

The data process is too slow after the power is switched on or the mode is changed.

- There is a large number of still images (approx. 1,000 or more) stored in the recording medium.
- Copy the stored files to a PC, and delete them from the recording medium.

[SET DATE/TIME!] appears.

- The built-in clock's rechargeable lithium battery is discharged.
- The previously set date/time is erased.
- Connect the camera to an AC outlet using the AC adapter for over 24 hours to charge the clock's lithium battery. Then set the date/time. (⇨ pg. 18)

Files cannot be deleted.

- Files are protected.
- Remove protection from the files and delete them. (⇨ pg. 38, 50)

When the image is printed from the printer, a black bar appears at the bottom of the screen.

- This is not a malfunction.
- By recording with DIS activated, this can be avoided. (⇨ pg. 50)

Images on the LCD monitor appear dark or whitish.

- In places subject to low temperature, images become dark due to the characteristics of the LCD monitor. This is not a malfunction.
- Adjust the brightness and angle of the LCD monitor. (☞ pg. 9, 18, 49)
- When the LCD monitor's fluorescent light reaches the end of its service life, images on the LCD monitor become dark.
- Consult your nearest JVC dealer.

Colored bright spots appear all over the LCD monitor.

- The LCD monitor is made with high precision technology. However, black spots or bright spots of light (red, green or blue) may appear constantly on the LCD monitor. These spots are not recorded on the picture. This is not due to any defect of the unit. (Effective dots: more than 99.99 %)

The SD card cannot be removed from the camera.

- Push in the SD card a few more times. (☞ pg. 19)

Picture does not appear on the LCD monitor.

- The LCD monitor's brightness setting is too dark.
- Adjust the brightness of the LCD monitor. (☞ pg. 18, 49)

Warning Indications

The following indications appear on the screen.

 (Battery indicator)

Displays the battery remaining power.

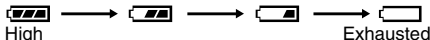
Remaining power level

- As the battery power comes close to nil, the battery indicator blinks. When the battery power is exhausted, power turns off automatically.

SET DATE/TIME!

- Appears when the date/time is not set. (☞ pg. 18)
- Appears when the built-in clock (lithium) battery is discharged and the previously set date/time is erased. (☞ pg. 18)

LENS CAP

Appears for 5 seconds after power is turned on with the power switch set to , if the lens cap is attached or when it is dark.

PLEASE INSERT MEMORY CARD!

Appears when no SD card is inserted in the SD slot. (☞ pg. 19)

HARD DISK DRIVE IS NOT FORMATTED

Appears when the built-in hard disk needs to be formatted.

THIS CARD IS NOT FORMATTED

Appears when an unformatted SD card is inserted.

HARD DISK DRIVE IS FULL

Appears when the built-in hard disk is full and recording is not possible.

MEMORY IS FULL

Appears when the SD card is full and recording is not possible.

HDD ERROR!**MEMORY CARD ERROR!**

Appears when some errors occurred with the recording media.

- Remove the card once and insert it again. If the error is not cancelled, replace the card with one that has been guaranteed for correct operation. (☞ pg. 19, 62)
- Perform clean up to restore the capacity of the recording media. (☞ pg. 40)
- It is recommended to run check disk regularly on the PC, on condition that there is no data on the hard disk of the camera.

CHECK CARD'S WRITE PROTECTION SWITCH

Appears when you attempt recording when the write protection tab on the SD card is set to the "LOCK" position. (⇨ pg. 19)

NO VIDEO FILES STORED!

Appears if there are no video files when you attempt video playback.

NO IMAGE FILES STORED!

Appears if there are no still image files when you attempt still image playback.

CLOSE COVER

Appears when the SD card cover is opened during file copy/move operation. (⇨ pg. 41)

NO MEMORY CARD

Appears when the SD card is not inserted to the SD slot for file copy/move operation. (⇨ pg. 41)

NO SUPPORTED FILES

Appears when there is no JPEG (still image) files to be copied or moved in recording media. (⇨ pg. 41)

NUMBER OF FOLDERS OVERFLOW

Appears when the number of folders exceeds the limit for file copy/move operation.

MEMORY CARD ERROR! REINSERT CARD OR CHANGE CARD.

Appears when the camera does not recognize the loaded SD card. Remove the card once and insert it again or replace with another card. (⇨ pg. 19)

FILE SYSTEM MAY HAVE PROBLEM. FORMAT IS RECOMMENDED AFTER COPYING WANTED DATA.

The file system of the recording medium may have a problem. It is recommended to copy the data for backup, then format the medium. (⇨ pg. 20)

VIDEO MANAGEMENT FILE IS BROKEN. TO RECORD/PLAYBACK VIDEO, RECOVERY IS REQUIRED. RECOVER?

The video management file is broken. Recovery is required to record or play back video files. Press \wedge/\vee to select [YES], then press \blacktriangleright \parallel to recover the video management file. If the desired video file is not displayed on the video index screen in spite of the file recovery, the file is moved to the [EXTMOV] folder. Press the recording start/stop button on the index screen to display [MPG], and then select the desired file.

NO VIDEO MANAGEMENT FILE VIDEO FILES HAVE BEEN MOVED TO MPEG FOLDER

The data cannot be recorded properly, or the video management file is deleted or not found. Video files have been moved to MPEG (EXTMOV) folder. (⇨ pg. 22)

PLAY LIST'S MANAGEMENT INFORMATION IS BROKEN. REMAKE PLAY LIST AGAIN.

The management information of play list is broken. Create the play list again. (⇨ pg. 42)

NO REGISTERED SCENES IN PLAY LIST. SOME OF SCENES MAY NOT BE PLAYED BACK.

The video files registered in the play list do not exist. Some of the scenes may not be played back.

REGISTERED SCENES IN PLAY LIST IS EMPTY. THIS PLAY LIST WILL BE DELETED.

There is no scenes registered in the play list. The play list will be deleted.

CAMERA TEMPERATURE IS GOING UP. TURN CAMERA OFF, PLEASE WAIT.

The temperature of the camera is too high. Turn off the power, then wait for a while.

CAMERA TEMPERATURE IS TOO LOW. KEEP CAMERA POWER ON, PLEASE WAIT.

The temperature of the camera is too low. Keep the power on and wait for a while.

RECORDING FAILURE

- Performance of recording medium is poor. Use the Cleanup function [CLEAN UP] in the menu. (⇨ pg. 40, 49)
- The writing speed of recording medium is slow, or the recording medium is corrupted. Use the recording medium to which the operation is guaranteed. See page 62 for the guaranteed media to work with this camera.
- The recording medium was subjected to vibrations or jolts. Be careful not to subject the recording medium to vibrations or jolts.

RECORDING MAY NOT BE CORRECT ON THE MEMORY CARD

The data may not be recorded on the recording medium correctly. Try recording again. Otherwise, clean up the recording medium. (⇨ pg. 40, 49)

MEMORY CARD CANNOT BE PLAYED BACK CORRECTLY

The recording medium cannot be played back correctly. Try playback again.

CANNOT USE IN VIDEO MODE

The operation is not available in the video mode.

DROP DETECTION WORKED AND THE POWER IS TURNED OFF

The drop detection function operated, and the power was turned off. The file that was being recorded may have been saved into the [EXTMOV] folder. (→ pg. 22)

Cleaning the Camera

Before cleaning, turn off the camera and remove the battery pack and AC adapter.

To clean the exterior

Wipe gently with a soft cloth. Put the cloth in diluted mild soap and wring it well to wipe off heavy dirt. Then wipe again with a dry cloth.

To clean the LCD monitor

Wipe gently with a soft cloth. Be careful not to damage the monitor.

To clean the lens

Wipe gently with lens cleaning paper.

NOTES:

- Avoid using strong cleaning agents such as benzene or alcohol.
- Cleaning should be done only after the battery pack has been removed or other power units have been disconnected.
- Mold may form if the lens is left dirty.
- When using a cleaner or chemically treated cloth refer to the cautions of each product.

Cautions

AC Adapter

When using the AC adapter in areas other than the USA

The provided AC adapter features automatic voltage selection in the AC range from 110 V to 240 V.

USING HOUSEHOLD AC PLUG ADAPTER

In case of connecting the unit's power cord to an AC wall outlet other than American National Standard C73 series type use an AC plug adapter, called a "Siemens Plug", as shown. For this AC plug adapter, consult your nearest JVC dealer.

Plug Adapter

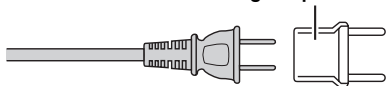

Battery Packs

The supplied battery pack is a lithium-ion battery. Before using the supplied battery pack or an optional battery pack, be sure to read the following cautions:

- **To avoid hazards**

- ... do not burn.
- ... do not short-circuit the terminals. When transporting, make sure the provided battery cap is attached to the battery. If the battery cap is misplaced, carry the battery in a plastic bag.
- ... do not modify or disassemble.
- ... do not expose the battery to temperatures exceeding 60°C (140°F), as this may cause the battery to overheat, explode or catch fire.
- ... use only specified chargers.

Terminals

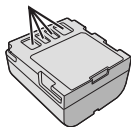

- **To prevent damage and prolong service life**
 - ... do not subject to unnecessary shock.
 - ... charge in an environment where temperatures are within the tolerances shown in the chart below. This is a chemical reaction type battery — cooler temperatures impede chemical reaction, while warmer temperatures can prevent complete charging.
 - ... store in a cool, dry place. Extended exposure to high temperatures will increase natural discharge and shorten service life.
 - ... fully charge and then fully discharge the battery every 6 months when storing the battery pack over a long period time.
 - ... remove from charger or powered unit when not in use, as some machines use current even when switched off.

NOTES:

- It is recommended that only genuine JVC batteries are used in this camera. Using generic non-JVC batteries can cause damage to the internal charging circuitry.
 - It is normal for the battery pack to be warm after charging, or after use.
- Temperature range specifications**
- Charging: 10°C to 35°C (50°F to 95°F)
 Operation: 0°C to 40°C (32°F to 104°F)
 Storage: -20°C to 50°C (-4°F to 122°F)
- The lower the temperature, the longer the recharging takes.

Recording Medium

- **Be sure to follow the guidelines below to prevent corruption or damage to your recorded data.**
 - Do not bend or drop the recording medium, or subject it to strong pressure, jolts or vibrations.
 - Do not splash the recording medium with water.
 - Do not use, replace, or store the recording medium in locations that are exposed to strong static electricity or electrical noise.
 - Do not turn off the camera power or remove the battery or AC adapter during shooting, playback, or when otherwise accessing the recording medium.
 - Do not bring the recording medium near objects that have a strong magnetic field or that emit strong electromagnetic waves.
 - Do not store the recording medium in locations with high temperature or high humidity.
 - Do not touch the metal parts.
- **Copy the recorded files to your PC. JVC shall not be responsible for any lost data. (It is recommended that you copy the data from your PC to DVD or other media for storage.)**
- **A malfunction may cause the recording medium to fail to operate properly. JVC shall not provide any compensation for any lost contents.**

LCD Monitor

- **To prevent damage to the LCD monitor, DO NOT**
 - ... push it strongly or apply any shocks.
 - ... place the camera with LCD monitor on the bottom.
- **To prolong service life**
 - ... avoid rubbing it with coarse cloth.
- **Be aware of the following phenomena for LCD monitor use. These are not malfunctions.**
 - ... While using the camera, the surface around the LCD monitor may heat up.
 - ... If you leave power on for a long time, the surface around the LCD monitor becomes hot.

Main Unit

- **For safety, DO NOT**
 - ... open the camera's chassis.
 - ... disassemble or modify the unit.
 - ... short-circuit the terminals of the battery pack.
 - Keep it away from metallic objects when not in use.
 - ... allow inflammables, water or metallic objects to enter the unit.
 - ... remove the battery pack or disconnect the power supply while the power is on.
 - ... leave the battery pack attached when the camera is not in use.
- **Avoid using the unit**
 - ... in places subject to excessive humidity or dust.
 - ... in places subject to soot or steam such as near a cooking stove.
 - ... in places subject to excessive shock or vibration.
 - ... near a television set.
 - ... near appliances generating strong magnetic or electric fields (speakers, broadcasting antennas, etc.).
 - ... in places subject to extremely high (over 40°C or 104°F) or extremely low (under 0°C or 32°F) temperatures.
- **DO NOT leave the unit**
 - ... in places of over 50°C (122°F).
 - ... in places where humidity is extremely low (below 35%) or extremely high (above 80%).
 - ... in direct sunlight.
 - ... in a closed car in summer.
 - ... near a heater.
- **To protect the unit, DO NOT**
 - ... allow it to become wet.
 - ... drop the unit or strike it against hard objects.
 - ... subject it to shock or excessive vibration during transportation.
 - ... keep the lens directed at extremely bright objects for long periods.
 - ... expose the lens to direct sunlight.
 - ... swing it excessively when using the hand strap.
 - ... swing the soft camera case excessively when the camera is inside it.

How to Handle a CD-ROM

- Take care not to soil or scratch the mirror surface (opposite to the printed surface). Do not write anything or put a sticker on either the front or back surface. If the CD-ROM gets dirty, gently wipe it with a soft cloth outward from the center hole.
- Do not use conventional disc cleaners or cleaning spray.
- Do not bend the CD-ROM or touch its mirror surface.
- Do not store your CD-ROM in a dusty, hot or humid environment. Keep it away from direct sunlight.

Serious malfunctioning

If malfunctioning occurs, stop using the unit immediately and consult your local JVC dealer.

When requesting repairs for malfunctioning by your dealer or JVC service center, be sure to bring your camera together with the recording medium. If one of them is not included, the cause cannot be diagnosed, and the repair cannot be made properly.

The camera is a microcomputer-controlled device. External noise and interference (from a TV, a radio, etc.) might prevent it from functioning properly. In such cases, first disconnect its power supply unit (battery pack, AC adapter, etc.) and wait a few minutes and then re-connect it and proceed as usual from the beginning.

Declaration of Conformity

Model Number : GZ-MG70U
 Trade Name : JVC
 Responsible party : JVC AMERICAS
 CORP.
 Address : 1700 Valley Road
 Wayne, N. J. 07470
 Telephone Number : 973-317-5000

This device complies with Part 15 of FCC Rules. Operation is subject to the following two conditions: (1) This device may not cause harmful interference, and (2) this device must accept any interference received, including interference that may cause undesired operation.

Changes or modifications not approved by JVC could void the user's authority to operate the equipment. This equipment has been tested and found to comply with the limits for a Class B digital device, pursuant to Part 15 of the FCC Rules. These limits are designed to provide reasonable protection against harmful interference in a residential installation. This equipment generates, uses, and can radiate radio frequency energy and, if not installed and used in accordance with the instructions, may cause harmful interference to radio communications. However, there is no guarantee that interference will not occur in a particular installation. If this equipment does cause harmful interference to radio or television reception, which can be determined by turning the equipment off and on, the user is encouraged to try to correct the interference by one or more of the following measures:

- Reorient or relocate the receiving antenna.
- Increase the separation between the equipment and receiver.
- Connect the equipment into an outlet on a circuit different from that to which the receiver is connected.
- Consult the dealer or an experienced radio/TV technician for help.

This Class B digital apparatus complies with Canadian ICES-003.

Cet appareil numérique de la classe B est conforme à la norme NMB-003 du Canada.

Specifications

Camera

For general

Power supply

DC 11 V (Using AC adapter)

DC 7.2 V (Using battery pack)

Power consumption

Approx. 5.2 W

Approx. 5.6 W (Maximum; when charging a battery)

Dimensions (W x H x D)

71 mm x 70 mm x 109 mm

(2-13/16" x 2-13/16" x 4-5/16")

Weight

Approx. 390 g (0.86 lbs)

(without battery, lens cap and strap)

Approx. 450 g (1 lbs)

(incl. battery, lens cap and strap)

Operating temperature

0°C to 40°C (32°F to 104°F)

Operating humidity

35% to 80%

Storage temperature

-20°C to 50°C (-4°F to 122°F)

Pickup

1/3.6" (2,120,000 pixels) CCD

Lens

F 1.8 to 2.2, f = 4.5 mm to 45 mm, 10:1 power zoom lens

Filter diameter

ø30.5 mm

LCD monitor

2.5" diagonally measured, LCD panel/TFT active matrix system

Speaker

Monaural

Flash

Within 2 m (6.5 ft)

(recommended shooting distance)

For video/audio

Format

SD-VIDEO

Recording/Playback format

Video: MPEG-2

Audio: Dolby Digital (2 ch)

Signal format

NTSC standard

Recording mode (video)

ULTRA FINE: 720 x 480 pixels, 8.5 Mbps (CBR)

FINE: 720 x 480 pixels, 5.5 Mbps (CBR)

NORMAL: 720 x 480 pixels, 4.2 Mbps (VBR)

ECONOMY: 352 x 240 pixels, 1.5 Mbps (VBR)

Recording mode (audio)

ULTRA FINE: 48 kHz, 384 kbps

FINE: 48 kHz, 384 kbps

NORMAL: 48 kHz, 256 kbps

ECONOMY: 48 kHz, 128 kbps

For still image**Format**

JPEG

Image size

4 modes (1600 x 1200 / 1280 x 960 / 1024 x 768 / 640 x 480)

Picture quality

2 modes (FINE/STANDARD)

For connectors**AV**

S-Video output:

Y: 1.0 V (p-p), 75 Ω, analog

C: 0.29 V (p-p), 75 Ω, analog

Video output: 1.0 V (p-p), 75 Ω, analog

Audio output: 300 mV (rms), 1 kΩ, analog, stereo

USB

Mini USB-B type, USB 1.1/2.0 compliant

AC Adapter**Power requirement**

AC 110 V to 240 V~, 50 Hz/60 Hz

Output

DC 11 V ---, 1 A

Remote Control**Power supply**

DC 3 V

Battery life

Approx. 1 year (depending on the frequency in use)

Operating distance

Within 5 m (16.4 ft)

Operating temperature

0°C to 40°C (32°F to 104°F)

Dimensions (W x H x D)45 mm x 11 mm x 105 mm
(1-13/16" x 7/16" x 4-3/16")**Weight**Approx. 40 g (0.09 lbs)
(incl. battery)

Design and specifications subject to change without notice.

Recording Time and Number of Images

The tables below show the approximate recording time and number of storable images. The number increases or decreases depending on the conditions such as image size and/or picture quality. The first column in the table indicates the conditions.

Compatible recording media

The following SD cards have been guaranteed to work with this camera. Others are not guaranteed to work, so buy such products with caution.

SD Memory Cards: By Panasonic, TOSHIBA, pqi (still image only) and SanDisk

- If other media are used, they may fail to record data correctly, or they may lose data that has already been recorded.
- MultiMediaCards are not supported.
- For video recording, use a high-speed SD Memory Card (at least 10 MB/s).

 : Approximate recording time (for video)

(The numbers indicate "minutes".)

- Built-in hard disk

| Quality | Recording time |
|------------|----------------|
| ULTRA FINE | 430 |
| FINE | 640 |
| NORMAL | 850 |
| ECONOMY | 2250 |

- SD card

| Quality | 128 MB | 256 MB | 512 MB | 1 GB |
|------------|--------|--------|--------|------|
| ULTRA FINE | 1 | 3 | 7 | 14 |
| FINE | 2 | 5 | 10 | 21 |
| NORMAL | 3 | 6 | 14 | 27 |
| ECONOMY | 8 | 18 | 37 | 73 |

 : Approximate number of storable images (for still image)

- Built-in hard disk

| Image size/ quality | Number of images |
|--------------------------|---------------------|
| 640 x 480/ FINE | 9999 |
| 640 x 480/ STANDARD | 9999 |
| 1024 x 768/ FINE | 9999 |
| 1024 x 768/ STANDARD | 9999 |
| 1280 x 960/ FINE | 9999 |
| 1280 x 960/ STANDARD | 9999 |
| 1600 x 1200/ FINE | 9999 |
| 1600 x 1200/ STANDARD | 9999 |

- SD card

| Image size/ quality | 128 MB | 256 MB | 512 MB | 1 GB |
|--------------------------|-----------|-----------|-----------|------|
| 640 x 480/ FINE | 770 | 1555 | 3140 | 6040 |
| 640 x 480/ STANDARD | 1105 | 2225 | 4490 | 8635 |
| 1024 x 768/ FINE | 320 | 645 | 1305 | 2515 |
| 1024 x 768/ STANDARD | 550 | 1110 | 2240 | 4315 |
| 1280 x 960/ FINE | 220 | 440 | 895 | 1725 |
| 1280 x 960/ STANDARD | 350 | 705 | 1425 | 2745 |
| 1600 x 1200/ FINE | 135 | 280 | 570 | 1095 |
| 1600 x 1200/ STANDARD | 230 | 470 | 950 | 1830 |

| | | | |
|---|-----------|---------------------------------|--------------------|
| A | | M | |
| AC Adapter | 16, 57 | Manual Exposure | 32 |
| B | | Manual Focus | 33 |
| Backlight Compensation | 31 | MSET Menu | 32 |
| Battery Pack | 14 | O | |
| Brightness Control | 18, 49 | Operation Sound | 48 |
| C | | P | |
| Changing The Menu Settings | 48 – 51 | Picture Quality | 50, 51 |
| Charging The Battery Pack | 14 | Play List | 42 – 45, 50 |
| Cleaning Up a Recording Medium | 40, 49 | Power-Linked Operation | 17 |
| Connection to a TV, VCR or DVD Recorder | 26 | Program AE | 36 |
| Continuous Shooting | 28 | Protecting Files | 38, 50 |
| Copying/Moving Still Image Files | 41, 49 | R | |
| D | | Remote Control | 27 |
| Data Battery | 16 | Resetting The File Number | 42, 49 |
| Date Index Screen | 25, 30 | S | |
| Date/Time Settings | 18 | Scroll Bar | 25, 30 |
| Deleting Files | 39 | SD Memory Card | 19 |
| Demonstration Mode | 48 | Self-Timer | 51 |
| Digital Image Stabilizer (DIS) | 50 | Shutter Speed | 35 |
| Direct Printing | 47 | Slide Show | 29 |
| DPOF Print Setting (Digital Print Order Format) | 46 | Slow Motion Playback | 25 |
| Drop Detection | 49 | Speaker Volume | 24 |
| Dubbing | 26, 45 | Spot Exposure Control | 31 |
| E | | T | |
| Effect | 36, 37 | Tele Macro | 50, 51 |
| F | | Tripod Mounting | 19 |
| File Information | 38 | Troubleshooting | 52 |
| Flash | 31 | W | |
| Formatting a Recording Medium | 20, 49 | Warning Indications | 54 |
| G | | White Balance | 34 |
| Gain | 51 | Wide Mode | 50 |
| Gain Up | 50 | Wind Cut | 50 |
| I | | Wipe or Fader Effects | 37 |
| Image Rotation | 30 | Z | |
| Image Size | 51 | Zooming | 23, 25, 28, 30, 50 |
| Index Screen | 24, 29 | | |
| L | | | |
| Language Setting | 17, 49 | | |
| LCD Monitor | 9, 12, 58 | | |

JVC