

JVC



LYT1829-003D

ENGLISH

EN

GUIDEBOOK

HARD DISK CAMCORDER

GZ-MG365 U

GZ-MG335 U

GZ-MG330 U

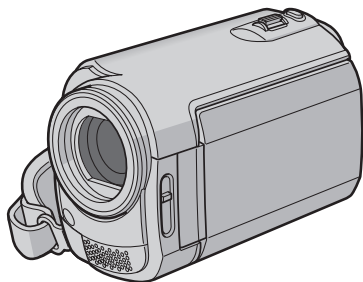

Dear Customer

Thank you for purchasing this hard disk camera. Before use, please read the safety information and precautions contained in pages 2 and 3 to ensure safe use of this product.

For Future Reference:

Enter the Model No. (located on the bottom of the camera) and Serial No. (located on the battery pack mount of the camera) below.

Model No. _____

Serial No. _____



Safety Precautions

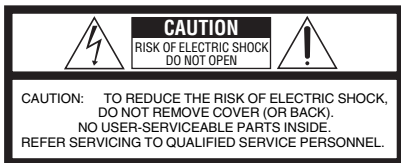

The lightning flash with arrowhead symbol, within an equilateral triangle, is intended to alert the user to the presence of uninsulated "dangerous voltage" within the product's enclosure that may be of sufficient magnitude to constitute a risk of electric shock to persons.



The exclamation point within an equilateral triangle is intended to alert the user to the presence of important operating and maintenance (servicing) instructions in the literature accompanying the appliance.

WARNING: TO PREVENT FIRE OR SHOCK HAZARD, DO NOT EXPOSE THIS UNIT TO RAIN OR MOISTURE.

NOTES:

- The rating plate and safety caution are on the bottom and/or the back of the main unit.
- The serial number plate is on the battery pack mount.
- The rating information and safety caution of the AC adapter are on its upper and lower sides.

Caution on Replaceable lithium battery

The battery used in this device may present a fire or chemical burn hazard if mistreated.

Do not recharge, disassemble, heat above 100°C or incinerate.

Replace battery with Panasonic (Matsushita Electric), Sanyo, Sony or Maxell CR2025.

Danger of explosion or Risk of fire if the battery is incorrectly replaced.

- Dispose of used battery promptly.
- Keep away from children.
- Do not disassemble and do not dispose of in fire.

For USA-California Only

This product contains a CR Coin Cell Lithium Battery which contains Perchlorate Material – special handling may apply.

See www.dtsc.ca.gov/hazardouswaste/perchlorate

When the equipment is installed in a cabinet or on a shelf, make sure that it has sufficient space on all sides to allow for ventilation (10 cm (3-15/16") or more on both sides, on top and at the rear).

Do not block the ventilation holes.

(If the ventilation holes are blocked by a newspaper, or cloth etc. the heat may not be able to get out.)

No naked flame sources, such as lighted candles, should be placed on the apparatus.

When discarding batteries, environmental problems must be considered and the local rules or laws governing the disposal of these batteries must be followed strictly.

The apparatus shall not be exposed to dripping or splashing.

Do not use this equipment in a bathroom or places with water.

Also do not place any containers filled with water or liquids (such as cosmetics or medicines, flower vases, potted plants, cups etc.) on top of this unit. (If water or liquid is allowed to enter this equipment, fire or electric shock may be caused.)

Do not point the lens directly into the sun. This can cause eye injuries, as well as lead to the malfunctioning of internal circuitry. There is also a risk of fire or electric shock.

CAUTION!

The following notes concern possible physical damage to the camera and to the user.

Carrying or holding the camera by the LCD monitor can result in dropping the unit, or in a malfunction. Do not use a tripod on unsteady or uneven surfaces. It could tip over, causing serious damage to the camera.

CAUTION!

Connecting cables (Audio/Video, S-Video, etc.) to the camera and leaving it on top of the TV is not recommended, as tripping on the cables will cause the camera to fall, resulting in damage.

CAUTION:

The mains plug shall remain readily operable.

WARNING:

The battery pack, the camera with battery installed, and the remote control with battery installed should not be exposed to excessive heat such as direct sunlight, fire or the like.

IMPORTANT SAFETY INSTRUCTIONS

1. Read these instructions.
2. Keep these instructions.
3. Heed all warnings.
4. Follow all instructions.
5. Do not use this apparatus near water.
6. Clean only with dry cloth.
7. Do not block any ventilation openings. Install in accordance with the manufacturer's instructions.
8. Do not install near any heat sources such as radiators, heat registers, stoves, or other apparatus (including amplifiers) that produce heat.
9. Only use attachments/accessories specified by the manufacturer.
10. Use only with the cart, stand, tripod, bracket, or table specified by the manufacturer, or sold with the apparatus. When a cart is used, use caution when moving the cart/apparatus combination to avoid injury from tip-over.
11. Unplug this apparatus during lightning storms or when unused for long periods of time.
12. Refer all servicing to qualified service personnel. Servicing is required when the apparatus has been damaged in any way, such as power-supply cord or plug is damaged, liquid has been spilled or objects have fallen into the apparatus, the apparatus has been exposed to rain or moisture, does not operate normally, or has been dropped.



Remember that this camera is intended for private consumer use only.

Any commercial use without proper permission is prohibited. (Even if you record an event such as a show, performance or exhibition for personal enjoyment, it is strongly recommended that you obtain permission beforehand.)

Trademarks

- Manufactured under license from Dolby Laboratories. Dolby and double-D symbol are trademarks of Dolby Laboratories.
- Windows® is either registered trademark or trademark of Microsoft Corporation in the United States and/or other countries.
- Macintosh is a registered trademark of Apple Inc.
- Other product and company names included in this instruction manual are trademarks and/or registered trademarks of their respective holders.



If this symbol is shown, it is only valid in the European Union.

JVC Software License Agreement

JVC SOFTWARE LICENSE AGREEMENT

IMPORTANT

TO CUSTOMERS: PLEASE MAKE SURE TO READ THIS CAREFULLY BEFORE INSTALLING OR USING THE SOFTWARE PROGRAM NAMED "DIGITAL PHOTO NAVIGATOR" ("Program") ON YOUR PC.

The right to use the Program is granted by Victor Company of Japan, Limited ("JVC") to You only on the condition that You agree to the following. Should You not agree to the terms hereof, You may not install or use the Program. HOWEVER, INSTALLING OR USING THE PROGRAM INDICATES YOUR ACCEPTANCE OF THESE TERMS AND CONDITIONS.

1 COPYRIGHT; OWNERSHIP

You acknowledge that all copyrights and other intellectual property rights in the Program are owned by JVC and its licensor, and remain vested in JVC and such licensor. The Program is protected under the copyright law of Japan and other countries, and related Conventions.

2 GRANT OF LICENSE

- (1) Subject to the conditions of this Agreement, JVC grants to You a non-exclusive right to use the Program. You may install and use the Program on a HDD or other storage devices incorporated in Your PC.
- (2) You may make one (1) copy of the Program solely for your personal backup or archival purposes.

3 RESTRICTION ON THE PROGRAM

- (1) You may not reverse engineer, decompile, disassemble, revise or modify the Program, except to the extent that expressly permitted by applicable law.
- (2) You may not copy or use the Program, in whole or in part, other than as expressly specified in this Agreement.
- (3) You have no right to grant a license to use the Program, and may not distribute, rent, lease or transfer the Program to any third party or otherwise let them use the Program.

4 LIMITED WARRANTY

JVC warrants that any media in which the Program is embodied are free from any defects in materials and workmanship for a period of thirty (30) days from the date of Your purchasing any our products accompanying the Program. JVC's entire liability and your exclusive remedy in connection with the Program shall be replacement of such defective media. EXCEPT FOR THE EXPRESS WARRANTIES STATED HEREIN AND TO THE EXTENT PERMITTED BY APPLICABLE LAW, JVC AND ITS LICENSORS DISCLAIM ANY OTHER WARRANTIES, EITHER EXPRESS OR IMPLIED, INCLUDING BUT NOT LIMITED TO IMPLIED WARRANTIES OF MERCHANTABILITY AND FITNESS FOR A PARTICULAR PURPOSE IN REGARD TO THE PROGRAM AND THE ACCOMPANYING PRINTED MATERIALS. SHOULD THERE BE ANY PROBLEM ARISING FROM OR CAUSED BY THE PROGRAM, YOU SHOULD SETTLE ALL SUCH PROBLEM AT YOUR OWN COST AND EXPENSE.

5 LIMITED LIABILITY

TO THE EXTENT PERMITTED BY APPLICABLE LAW, IN NO EVENT SHALL JVC AND ITS LICENSORS BE LIABLE FOR ANY INDIRECT, SPECIAL, INCIDENTAL OR CONSEQUENTIAL DAMAGES WHATSOEVER, REGARDLESS OF THE FORM OF ACTION WHETHER IN CONTRACT, TORT OR OTHERWISE ARISING OUT OF OR IN CONNECTION WITH THE USE OF OR INABILITY TO USE THE PROGRAM, EVEN IF JVC HAS BEEN ADVISED OF THE POSSIBILITY OF SUCH DAMAGES. YOU WILL INDEMNIFY AND HOLD HARMLESS JVC FROM ANY LOSS, LIABILITY OR COST ARISING OUT OF OR IN ANY WAY CONNECTED TO CLAIMS FROM ANY THIRD PARTY RELATING TO THE USE OF THE PROGRAM.

6 TERM

This Agreement will become effective on the date when You install and use the Program on Your machine, and continue to be in effect until the termination under the following provision.

Should You breach any provision of this Agreement, JVC may terminate this Agreement without giving any notice to You. In this event, JVC may claim against You for any damages caused by Your breach. Should this Agreement be terminated, You must immediately destroy the Program stored in Your machine (including the erasing from any memory in Your PC), and no longer own such Program.

7 EXPORT CONTROL

You agree that You will not ship, transfer or export the Program or underlying information and technology to any countries to which Japan and other relevant countries have initiated an embargo on such goods.

8 U.S. GOVERNMENT USER

If You are an agency of the United States of America (the "Government"), You acknowledge JVC's representation that the Program is a "Commercial Item" as defined in Federal Acquisition Regulation (FAR) part 2.101 (g) consisting unpublished "Commercial Computer Software" as those items are used at FAR part 12.212 and is only licensed to You with the same use rights JVC grants all commercial end users pursuant to the terms of this Agreement.

9 GENERAL

- (1) No modification, change, addition, deletion or other alternation of or to this Agreement will be valid unless reduced to writing and signed by an authorized representative of JVC.
- (2) If any part of this Agreement is held invalid by or in conflict with any law having jurisdiction over this Agreement, the remaining provisions will remain in full force and effect.
- (3) This Agreement shall be governed by and interpreted under the laws of Japan. The Tokyo District Court has jurisdiction over all disputes which may arise with respect to the execution, interpretation and performance of this Agreement.

Victor Company of Japan, Limited

NOTE

If You acquired the Program in Germany, the provisions of Sections 4 (Limited Warranty) and 5 (Limited Liability) provided above will be replaced with those of the German version of this Agreement.

CAUTIONS:

- Operate this equipment according to the operating procedures described in this manual.
- Use only the provided CD-ROM. Never use any other CD-ROM to run this software.
- Do not attempt to modify this software.
- Changes or modifications not approved by JVC could void user's authority to operate the equipment.

How to handle a CD-ROM

- Take care not to soil or scratch the mirror surface (opposite to the printed surface). Do not write anything or put a sticker on either the front or back surface. If the CD-ROM gets dirty, gently wipe it with a soft cloth outward from the center hole.
- Do not use conventional disc cleaners or cleaning spray.
- Do not bend the CD-ROM or touch its mirror surface.
- Do not store your CD-ROM in a dusty, hot or humid environment. Keep it away from direct sunlight.

You can find the latest information (in English) on the provided software program at our world wide web server at <http://www.jvc-victor.co.jp/english/global-e.html>

Read This First!

How to Select an Item Using the Touch Sensor

An example screen in English is used for the guidance below.

- **Selecting an item from the menu list**
(on the menu screen  pg. 62)

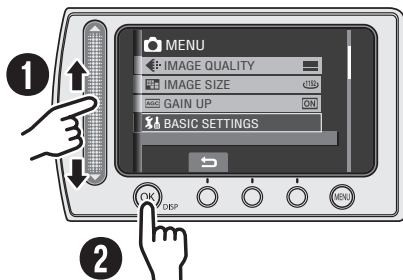

- 1 Slide your finger up and down on the sensor.
- 2 Touch the **OK** button.

NOTE

The cursor moves from 1 to 9 on the index screen when you slide your finger on the touch sensor.



- **Using on-screen buttons**
(e.g. during playback  pg. 27)

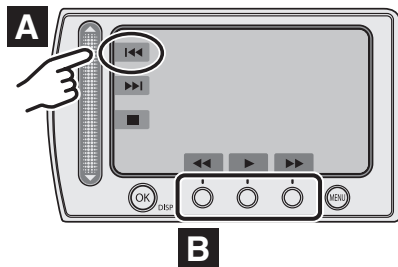

- A To select an on-screen button appearing on the left side, touch the portion of the sensor next to the on-screen button.
- B To select an on-screen button appearing at the bottom of the screen, touch the touch sensor under the on-screen button you want to select.

CAUTION

Touch the sensors with your finger. The sensors do not function if you touch them with your finger nail or with gloves on.

Make a backup of important recorded data

JVC will not be responsible for any lost data. It is recommended to copy your important recorded data to a DVD or other recording media for storage. (☞ pg. 42)

Make a trial recording

Before the actual recording of important data, make a trial recording and play back the recorded data to check that the video and sound have been recorded correctly.

Reset the camera if it does not operate correctly

This camera uses a microcomputer. Factors such as background noise and interference can prevent it from operating correctly. If the camera does not operate correctly, reset the camera. (☞ pg. 67)

Precautions on handling batteries

- Be sure to use the JVC BN-VF808U/VF815U/VF823U battery packs.
 - If the camera is subjected to electrostatic discharge, turn the power off before using it again.
-

If a malfunction occurs, stop using the camera immediately and consult your local JVC dealer

- If a problem occurs when using the microSD card, take the card together with the camera for repair. If one of them is not included, the cause of the malfunction cannot be diagnosed, and the camera cannot be repaired.
 - Recorded data may be erased while the camera is being repaired or inspected. Back up all data before requesting repairs or inspections.
-

Because the camera may be used for demonstration in a shop, the demonstration mode is set to [ON] by default

To deactivate the demonstration mode, set [DEMO MODE] to [OFF]. (☞ pg. 64)

When connecting the camera to other devices using an optional DV cable, make sure to follow the procedure below. Connecting the cable incorrectly may cause malfunctions to the camera and/or other devices.*

- Connect the DV cable first to the device, and then to the camera.
- Connect the DV cable (plugs) correctly according to the shape of the DV connector.

* This does not apply to the GZ-MG330 model.

Contents

GETTING STARTED

Accessories	10
How to Use the Everio Dock	10
Attaching the Shoulder Strap	11
Preparing the Remote Control	11
Attaching the Core Filter to the USB Cable	11
Index	12
Indications on LCD Monitor	14
Necessary Settings before Use	16
Charging the Battery Pack	16
Date/Time Setting	17
Language Setting	17
Other Settings	18
Grip Adjustment	18
Lens Cover	18
Checking the Remaining Battery Power	18
Tripod Mounting	18
When Using a microSD Card	19

RECORDING

Recording Files	20
Video Recording	20
Still Image Recording	21
Zooming	22
LED Light	22
Registering Files to Events	23
Checking the Remaining Space on the Recording Media	23
Manual Recording	24
To Change to Manual Recording Mode	24
Program AE	24
Backlight Compensation	24
Manual Setting in Function Menu	25
Playing Back Files	27
Video/Still Image Playback	27
File Search Function	28
To Play Back MPG Files	29
Playback with Special Effects	30
Watching Images on TV	31

EDITING/PRINTING

Managing Files	32
Deleting/Protecting Files	32
Viewing File Information	33
Changing the Event Registration of Video Files after Recording	34
Partial Delete (EDITED COPY)	35
Playlists	36
Creating Playlists	36
Playing Back Playlists	37
Other Operations of Playlists	38
Print Setting	39
DPOF Print Setting	39
Direct Printing with PictBridge Printer	40

COPYING

Copying Files	42
Using a DVD Burner to Copy Files from the Camera	42
Using a VCR/DVD Recorder to Dub Files from the Camera	46
Using the Camera to Dub Files from a VCR/DVD Player	47
Copying/Moving Files	48

PC OPERATION

File Backup on a Windows® PC	49
System Requirements	49
Software Installation	50
Connecting the Camera to the PC	51
File Backup on the PC	52
File Backup on the PC without Using Software	53
Other Windows® PC Operations	54
Playing Back Files on the PC	54
Creating a DVD-Video	55
Getting More Use of the Software	57
File Backup on a Macintosh®	58
System Requirements	58
Connecting the Camera to the Macintosh ...	58
File Backup on the Macintosh	59
Folder Structure and Extensions	60
Customer Support Information	61

MENU SETTINGS

Changing the Menu Settings	62
---	----

FURTHER INFORMATION

Troubleshooting	67
Warning Indications	70
Cleaning	71
Specifications	72
Cautions	74
Terms	76

Regarding the Icons in this Manual

Icon at the top of a page

Print Setting

DPOF Print Setting

This camera is compatible with DPOF (Digital Print Order Format). You can set which images to be printed and the number of prints with this camera. This feature is useful for print.

5 Select the number of prints, (min. 1 to 999 prints)

To set print information for other images, repeat steps 4 and 5. (You can set up to 999 files.)



When there is an icon at the top of a page, it shows whether the page is related to videos or still images.



Page related to videos



Page related to still images

Icon at the subtitle

Partial Delete (EDITED COPY)

You can divide the selected video file into parts and make a copy of the desired section as a new video file.



Event Screen

You can search the desired file by the event that you registered the file to when recording. (▶ pg. 23) After searching by the event, you



For video mode only



For still images mode only

On-screen function guide

The on-screen function guide is displayed at the bottom of the screen during menu display, etc.

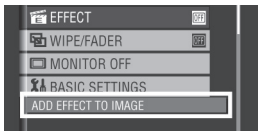

Accessories

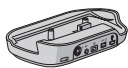

Everio Dock*
CU-VC4U (☞ below)

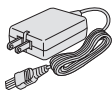

AC Adapter
AP-V18U/14U

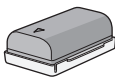

Battery Pack
BN-VF808U

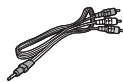

Audio/Video Cable



USB Cable
(☞ pg. 40, 42, 51 and 58)

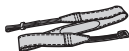

Shoulder Strap
(☞ pg. 11)



CD-ROM
(☞ pg. 50)



Remote Control Unit
RM-V751U (☞ pg. 11)



Lithium Battery
CR2025
Pre-installed in the remote control unit.



Core Filter
(☞ pg. 11)

NOTE

Make sure to use the provided cables for connections. Do not use any other cables.

How to Use the Everio Dock*

You can connect cables to the connectors of the Everio dock. The connection is completed when you place the camera on the dock.

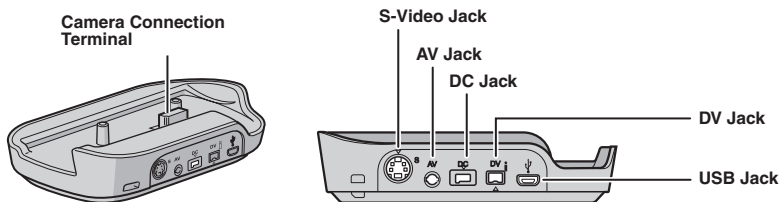

NOTE

For the connection using the S-Video jack and DV jack, an optional S-Video cable and DV cable are needed. Consult the JVC Service Center described on the sheet included in the package for details on its availability. Make sure to connect the end with a core filter to the camera. The core filter reduces interference.

- The S-Video cable (optional) enables even higher playback quality on TV. (☞ pg. 31) Be sure to use the YTU94146A S-Video cable.
- When dubbing files from the camera with a VCR/DVD recorder (☞ pg. 47), using the DV cable enables even higher dubbing quality. Be sure to use the VC-VDV204U DV cable. Operation using the DV cable is not guaranteed on all devices.

* GZ-MG330 model does not include the Everio dock.

Attaching the Shoulder Strap

Peel off the pad and thread the end of the strap through the eyelet.

Thread the strap through the buckle, adjust its length, and use the strap guide to fix it in place.

Position the buckle near the eyelet and reattach the pad.

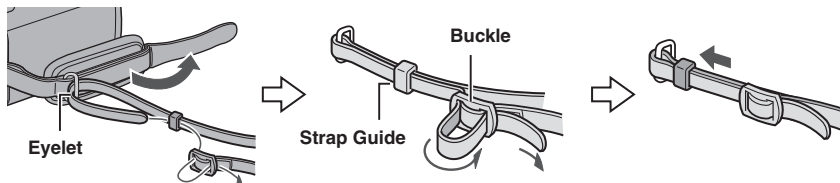

Preparing the Remote Control

A battery is included inside the remote control at the time of purchase. Remove the insulation sheet before use.

Effective Beam Distance

Remote Sensor

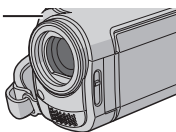

Effective distance:
5 m (16 ft)

NOTE

The transmitted beam may not be effective or may cause incorrect operation when the remote sensor is directly exposed to sunlight or powerful lighting.

To Reinsert the Battery

Pull out the battery holder by pressing the lock tab.

Lock Tab

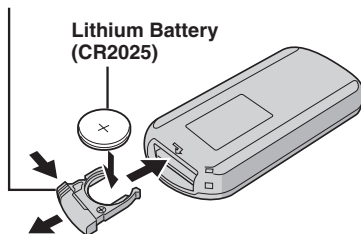

Attaching the Core Filter to the USB Cable

Attach the core filter to the USB cable. The core filter reduces interference. Connect the end of the cable with the core filter to the camera.

Release the stopper.

3 cm (1-3/16")

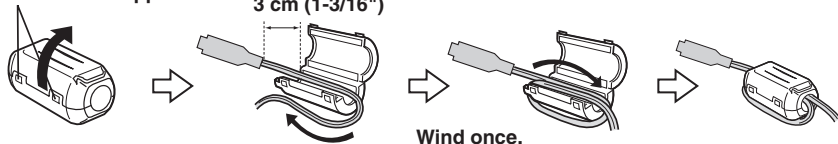

Wind once.

Index

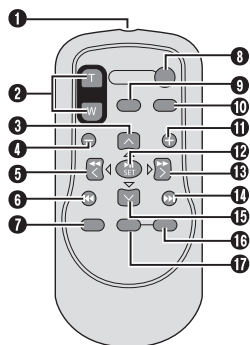
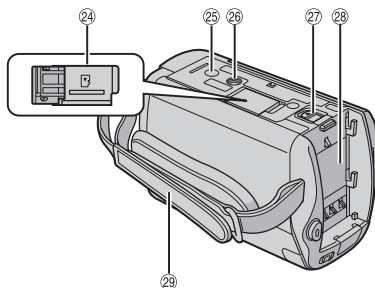
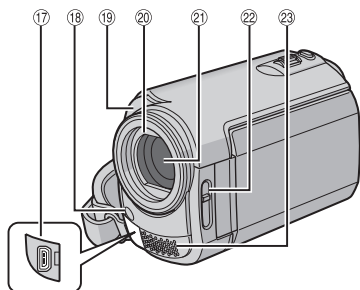
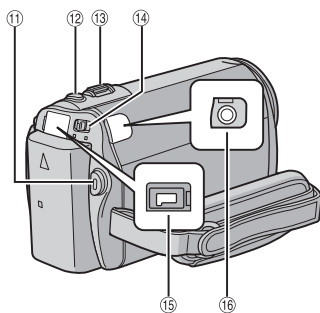
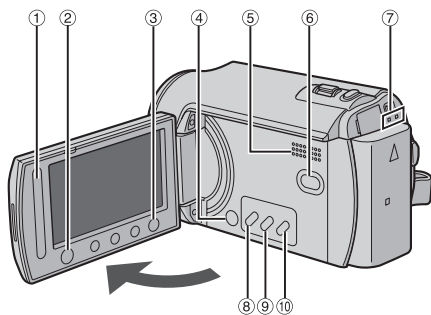

NOTES



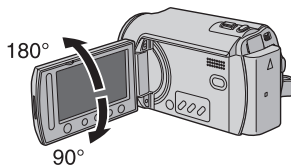



- The LCD monitor can rotate 270°.



• Power-linked operation

- You can also turn the camera on/off by opening/closing the LCD monitor during the recording mode.
- Be careful not to cover (18), (19), (21) and (23) during shooting.

Camera

- ① Touch Sensor (⇨ pg. 6)
- ② OK (DISP) Button [OK/DISP] (⇨ pg. 15)
- ③ Menu Button [MENU]
- ④ Power Switch [POWER]
(You can turn off the camera by pressing and holding this button.)
- ⑤ Speaker
- ⑥ Playback/Recording Mode Switching Button [SELECT PLAY/REC] (⇨ pg. 20)
- ⑦ Access/Charge Lamp [ACCESS/CHARGE]
(Blinks when you access files or charge the battery. Do not turn off the power or remove the battery pack/AC adapter while accessing files.)
- ⑧ Direct DVD Button [DIRECT DVD] (⇨ pg. 43)/Title Button [TITLE] (⇨ pg. 37)
- ⑨ Direct Backup Button [DIRECT BACK UP] (⇨ pg. 52)/Information Button [INFO] (⇨ pg. 33)
- ⑩ Auto/Manual Mode Button [AUTO/MANUAL] (⇨ pg. 24)
- ⑪ Video Recording Start/Stop Button [START/STOP] (⇨ pg. 20)
- ⑫ Still Image Shooting Button [SNAPSHOT] (⇨ pg. 21)
- ⑬ Zoom Lever [W  , T ] (⇨ pg. 22)
Speaker Volume Control [-VOL+] (⇨ pg. 27)
- ⑭ Mode Switch [ , ]
- ⑮ DC Jack [DC] (⇨ pg. 16)
- ⑯ Audio/Video Jack [AV]
- ⑰ USB (Universal Serial Bus) Jack []
(⇨ pg. 40, 42, 51 and 58)
- ⑱ LED Light (⇨ pg. 22)
- ⑲ Camera Sensor
Remote Sensor (⇨ pg. 11)
- ⑳ Lens Cover (⇨ pg. 18)
- ㉑ Lens
- ㉒ Lens Cover Switch [ , ] (⇨ pg. 18)
- ㉓ Stereo Microphone
- ㉔ microSD Card Slot (⇨ pg. 19)
- ㉕ Stud Hole (⇨ pg. 18)
- ㉖ Tripod Mounting Socket (⇨ pg. 18)
- ㉗ Battery Release Button [BATT.] (⇨ pg. 16)
- ㉘ Battery Pack Mount (⇨ pg. 16)
- ㉙ Grip Strap (⇨ pg. 18)

Remote Control

- ① Infrared Beam Transmitting Window
- ② ZOOM (T/W) Buttons
Zoom In/Out (⇨ pg. 22)
- ③ Up Button
Rotate Button (counterclockwise) (⇨ pg. 27)
- ④ Skip Backward Button
- ⑤ Left Button
- ⑥ Back Button
- ⑦ PLAYLIST Button (⇨ pg. 36)
- ⑧ START/STOP Button
- ⑨ SNAPSHOT Button (⇨ pg. 21)
- ⑩ INFO Button (⇨ pg. 33)
- ⑪ Skip Forward Button
- ⑫ PLAY/PAUSE Button
- ⑬ Right Button
- ⑭ Next Button
- ⑮ Down Button
Rotate Button (clockwise) (⇨ pg. 27)
- ⑯ INDEX Button
- ⑰ DISP Button

Indications on LCD Monitor

During both Video and Still Image Recording

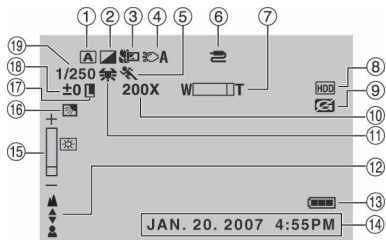

- ① Selected Operation Mode Indicator (↗ pg. 24)
A : Auto Mode
M : Manual Mode
- ② Effect Mode Indicator (↗ pg. 26)
- ③ Tele Macro Mode Indicator (↗ pg. 26)
- ④ LED Light Indicator (↗ pg. 22)
- ⑤ Program AE Mode Indicator (↗ pg. 24)
- ⑥ AV/S-Video Input Jack Indicator* (↗ pg. 63)
- ⑦ Zoom Indicator (↗ pg. 22)
- ⑧ Selected Medium Indicator (↗ pg. 64)
- ⑨ Drop Detection Indicator (Appears when [DROP DETECTION] is set to [OFF].) (↗ pg. 64)
- ⑩ Approximate Zoom Ratio (↗ pg. 22)
- ⑪ White Balance Indicator (↗ pg. 26)
- ⑫ Manual Focus Adjustment Indicator (↗ pg. 25)
- ⑬ Battery Indicator (↗ pg. 70)
- ⑭ Date/Time (↗ pg. 17)
- ⑮ Brightness Control Indicator (↗ pg. 64)
- ⑯ Backlight Compensation Indicator (↗ pg. 24)
- ⑰ Iris Lock Indicator (↗ pg. 25, 26)
- ⑱ ± : Exposure Adjustment Indicator (↗ pg. 25)
☉ : Photometry Area Control Indicator (↗ pg. 26)
- ⑲ Shutter Speed (↗ pg. 26)

* This does not apply to the GZ-MG330 model.

During Video Recording Only

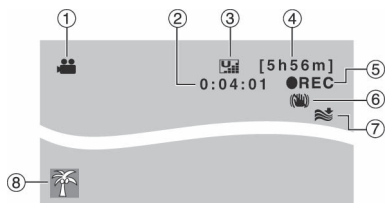

- ① Mode Indicator (↗ pg. 20)
- ② Counter
- ③ Picture Quality: U (ULTRA FINE), F (FINE), N (NORMAL), E (ECONOMY) (↗ pg. 62)
- ④ Remaining Time (↗ pg. 20, 73)
- ⑤ ● REC: (Appears during recording.) (↗ pg. 20)
● || : (Appears during record-standby mode.)
- ⑥ Digital Image Stabilizer (DIS) Indicator (Appears when [DIS] is set to [OFF].) (↗ pg. 63)
- ⑦ Wind Cut Indicator (↗ pg. 63)
- ⑧ Event Indicator (↗ pg. 23)

During Still Image Recording Only

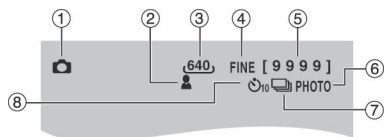

- ① Mode Indicator (↗ pg. 21)
- ② Focus Indicator (↗ pg. 25)
- ③ Image Size
- ④ Picture Quality: FINE (fine) or STD (standard) (↗ pg. 62)
- ⑤ Remaining Number of Shots (↗ pg. 73)
- ⑥ Shooting Indicator (↗ pg. 21)
- ⑦ Shutter Mode Indicator (↗ pg. 62)
- ⑧ Self-Timer Recording Indicator (↗ pg. 62)

During Video Playback

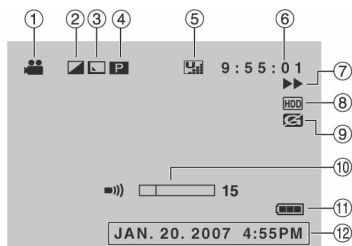

- ① Mode Indicator (☞ pg. 27)
- ② Effect Mode Indicator (☞ pg. 30)
- ③ Wipe/Fader Effect Indicator (☞ pg. 30)
- ④ **PL** : Playlist Playback Indicator (Appears when playing back a playlist.) (☞ pg. 37)
E : Event Search Playback Indicator (Appears when playing back a video file from the event search.) (☞ pg. 28)
D : Date Search Playback Indicator (Appears when playing back a video file from the date search.) (☞ pg. 28)
- ⑤ Picture Quality: **U** (ULTRA FINE), **F** (FINE), **N** (NORMAL), **E** (ECONOMY) (☞ pg. 23, 62)
- ⑥ Counter
- ⑦ Playback Mode (☞ pg. 27)
 - ▶ : Playback
 - ⏸ : Pause
 - ▶▶ : Forward Search
 - ◀◀ : Reverse Search
 - ▶▶▶ : Forward Slow-Motion
 - ◀◀◀ : Reverse Slow-Motion
(The number on the left shows speed.)
- ⑧ Selected Medium Indicator (☞ pg. 64)
- ⑨ Drop Detection Indicator (Appears when [DROP DETECTION] is set to [OFF].) (☞ pg. 64)
- ⑩ Volume Level Indicator
- ⑪ Battery Indicator (☞ pg. 70)
- ⑫ Date/Time (☞ pg. 17)

During Still Image Playback

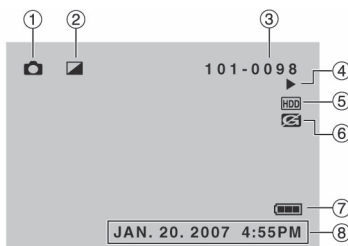

- ① Mode Indicator (☞ pg. 27)
- ② Effect Mode Indicator (☞ pg. 30)
- ③ Folder/File Number
- ④ Slide Show Playback Indicator (☞ pg. 27)
- ⑤ Selected Medium Indicator (☞ pg. 64)
- ⑥ Drop Detection Indicator (Appears when [DROP DETECTION] is set to [OFF].) (☞ pg. 64)
- ⑦ Battery Indicator (☞ pg. 70)
- ⑧ Date/Time (☞ pg. 17)

Switching indication modes on LCD monitor

Each time you touch the **DISP** button, indications on LCD monitor switch as shown below:

In recording mode:

All indications/Indications for selected functions

In playback mode:

All indications/Only date and time/

No indications

Necessary Settings before Use

Be sure to configure the following three settings before use.

Charging the Battery Pack

1 Close the LCD monitor to turn off the camera.

2 Attach the battery pack.
Slide the battery pack down until it locks in place.

Bottom of the Camera

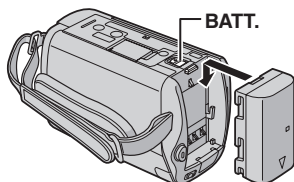

3 Connect the AC adapter.

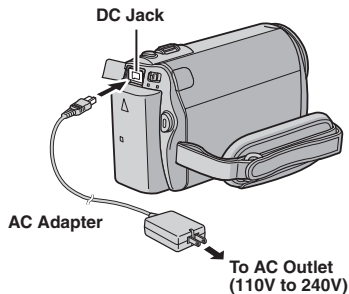

- You can also connect the AC adapter using the Everio dock connector.* (☞ pg. 10)
* GZ-MG330 model does not include the Everio dock.

- The charge lamp blinks to indicate charging has started.
- When the lamp goes out, charging is finished. Unplug the AC adapter from the AC outlet and disconnect the AC adapter from the camera.

■ To detach the battery pack

Slide and hold **BATT.** (☞ step 2), then remove the battery pack.

■ To check the remaining battery power

See page 18.

NOTES

- You can also use the camera with just the AC adapter.
- Please do not pull or bend the AC adapter plug and cable. This may damage the AC adapter.

Date/Time Setting

- 1 Open the LCD monitor to turn on the camera.
- 2 When [SET DATE/TIME!] appears, select [YES] within 10 seconds.



If you do not select within 10 seconds, the screen disappears. In such case, press and hold the **POWER** button and turn the camera on again.

- 3 Set the date and time.

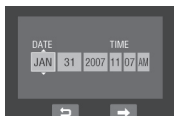

Repeat this step to input the month, day, year, hour and minute.

- 4 Touch the OK button to finish.

■ To change the date and time

- 1) Touch the **MENU** button.
- 2) Select [BASIC SETTINGS], and then [CLOCK ADJUST].
- 3) Set the date and time.

■ To return to the previous screen

Select

■ To quit the screen

Touch the **MENU** button.

Language Setting

The language on the display can be changed.

- 1 Open the LCD monitor to turn on the camera.
- 2 Touch the MENU button.
- 3 Select [BASIC SETTINGS].

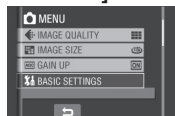

- 4 Select [LANGUAGE].



- 5 Select the desired language.



■ To return to the previous screen

Select .

■ To quit the screen

Touch the **MENU** button.

You have now finished configuring the necessary settings.

■ To use the camera right away

See page 20.

■ To configure other settings

See page 18.

Other Settings

Grip Adjustment

Open the pad and make grip adjustments.

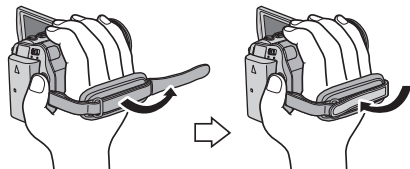

Lens Cover

When not using the camera, close the lens cover to protect the lens.



Open the lens cover

Close the lens cover

NOTE

Do not push the lens cover strongly. Doing so may cause damage to the lens.

Checking the Remaining Battery Power

Preparation:

- Attach the battery pack.
- Press the **SELECT PLAY/REC** button to select recording mode.

For  mode:

Press the **INFO** button twice or the **INFO** button and then select .

For  mode:

Press the **INFO** button.

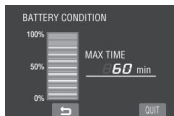

- **To return to the normal screen**
Press the **INFO** button again.

NOTES

- If "COMMUNICATING ERROR" appears, there may be a problem with your battery. In such a case, consult your nearest JVC dealer.
- The recordable time display should only be used as a guide. It is displayed in 10 minute units.

Tripod Mounting

Align the camera stud hole with the tripod stud, and the mounting socket with the screw, and then rotate the camera clockwise to mount it to the tripod.

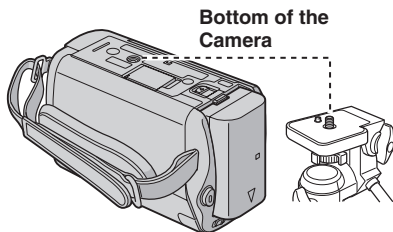

NOTE

- Do not use a tripod on unsteady or unlevel surfaces. It could tip over, causing serious damage to the camera.

When Using a microSD Card

If you want to record to a microSD card, the following three operations need to be performed.

- Operations are certified on the following microSD cards.
Video recording: Class 4 or higher compatible microSDHC card (4 GB)
Still image recording: Panasonic, TOSHIBA, SanDisk, ATP microSD card (256 MB to 2 GB) or microSDHC card (4 GB)
- If other media are used, they may fail to record data correctly, or they may lose data that had already been recorded.
- MultiMediaCards are not supported.
- Cards used to record video on this camera cannot be played back on other devices.

1 Insert a microSD card

Preparation:

Close the LCD monitor to turn off the camera.

1 Open the microSD card cover.

Bottom of the
Camera

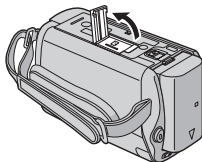

2 Firmly insert the card with its clipped edge first.

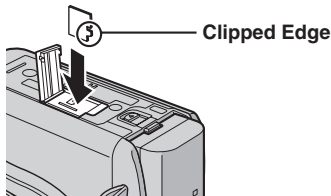

3 Close the microSD card cover.

■ To remove a microSD card

Push the microSD card once.
After the card comes out a little, pull it out.

NOTES

- Insert and remove the microSD card only while the power is turned off. Otherwise, data on the card may be corrupted.
- Do not touch the terminal on the reverse side of the label.

2 Change the recording medium

The camera is programmed to record on the built-in hard disk when it is shipped from the factory. You can change the recording medium to microSD card.

Set **[REC MEDIA FOR VIDEO]** and **[REC MEDIA FOR IMAGE]** to **[SD]**. (▶ pg. 64)

3 Format a microSD card when using it for the first time





This will also ensure stable speeds and operation when accessing the microSD card.

Select **[FORMAT SD CARD]** to format the card. (▶ pg. 65)

Recording Files

Video Recording

Preparation: Open the LCD monitor to turn on the camera.

- 1** Slide the mode switch to select  (video) mode.

- 2** Press the **SELECT PLAY/REC** button to select recording mode.

- 3** Press the **START/STOP** button to start recording.



Approximate remaining time for recording appears.

■ To stop recording

Press the **START/STOP** button again.

■ To view the video you just recorded

Select  during pause.

During the preview, you can delete the video by selecting .

■ To change the picture quality

Change the settings in [VIDEO QUALITY].
( pg. 62)

■ To register a file to an event

See page 23.

■ To change the aspect ratio of the image (16:9/4:3)

Change the settings in [SELECT ASPECT RATIO]. ( pg. 63)





NOTES

- The video recording mode is automatically selected when you turn the camera's power off and then on again.
- If the camera is not operated for 5 minutes while the power is on, it turns itself off automatically to conserve power. To turn the camera on again when using the battery pack, close the LCD monitor and open it again. When using the AC adapter, perform any operation such as zooming.
- Video files are given the names MOV001.MOD to MOV009.MOD, MOV00A.MOD to MOV00F.MOD, and MOV010.MOD in order of recording.
- After recording video for 12 consecutive hours, recording stops automatically.
- A new file will be created for every 4 GB of continuous shooting.
- This camera records video in MPEG2 format compliant with SD-VIDEO format. This camera is not compatible with other digital video formats.
- Do not move or shake the camera suddenly during recording. If you do so, the driving sound (hum) of the hard disk may be recorded.

Still Image Recording

Preparation: Open the LCD monitor to turn on the camera.



- 1** Slide the mode switch to select  (still image) mode.

- 2** Press the **SELECT PLAY/REC** button to select recording mode.



- 3** Press and hold the **SNAPSHOT** button halfway.



The  indicator becomes green when the captured image is focused.

- **To view the image you just recorded**
Select  after shooting.
During the preview, you can delete the image by selecting .
- **To change the picture quality**
Change the settings in [IMAGE QUALITY]. (➡ pg. 62)
- **To record still images continuously**
Set to [CONTINUOUS SHOOTING] in [SHUTTER MODE]. (➡ pg. 62)

- 4** Press the **SNAPSHOT** button fully to take the photo/picture.





NOTES

- DIS (Digital Image Stabilizer) does not function during still image recording.
- If the camera is not operated for 5 minutes while the power is on, it turns itself off automatically to conserve power. To turn the camera on again when using the battery pack, close the LCD monitor and open the LCD monitor again. When using the AC adapter, perform any operation such as zooming.

Recording Files (Continued)

Zooming

Preparation:

- Slide the mode switch to select  or  mode.
- Press the **SELECT PLAY/REC** button to select recording mode.

Zoom out

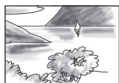

W: Wide angle

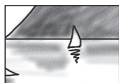

Zoom in



T: Telephoto



Zoom Ratio (Factory-preset)

 mode	 mode
70X	35X

■ To change the maximum zoom ratio (for mode only)



Change the settings in [ZOOM]. (☞ pg. 63)

NOTE

Macro shooting is possible as close as approx. 5 cm (2") to the subject when the zoom lever is set all the way to **W**.

LED Light

Preparation:

- Slide the mode switch to select  or  mode.
- Press the **SELECT PLAY/REC** button to select recording mode.

1 Touch the **MENU** button.

2 Select [**LIGHT**].

3 Select the desired setting.



The light remains on regardless of the surrounding conditions.



The light turns on automatically when shooting in insufficient light conditions.

No display

Disables this function.

Registering Files to Events



If you select an event to register the file to before starting recording, the file will be registered to the selected event, thus making the file easy to find at playback. There are up to three different destinations within each event (for example: BABY1, BABY2, BABY3).

Preparation:

- Slide the mode switch to select mode.
- Press the **SELECT PLAY/REC** button to select recording mode.

1 Touch the **MENU** button.

2 Select **[REGISTER EVENT]**.

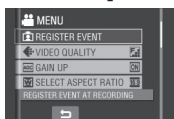

3 Select the event that you want to register the file to.

- To select a different destination, select **[SORT]**.
- To cancel the event registration, select **[CANCEL]**.

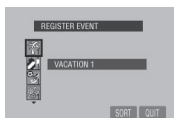

The selected event is displayed on the screen. Press the **START/STOP** button to start recording.

■ To quit the screen

Select **[QUIT]**.

■ To search a file by the event

See page 28.

Checking the Remaining Space on the Recording Media



Preparation:

- Slide the mode switch to select mode.
- Press the **SELECT PLAY/REC** button to select recording mode.

Press the **INFO** button.



The maximum recording time is displayed for each picture quality mode (U: ULTRA FINE, F: FINE, N: NORMAL, E: ECONOMY).

■ To change the picture quality

- 1) Select the desired picture quality.
- 2) Touch the **OK** button.

■ To return to the normal screen

Select .

NOTE

Once you register a file to a certain event, the setting will remain even if you turn the power off. Unless you change the setting, you will register a file to the same event that you had previously selected.

Manual Recording

Manual recording mode enables you to set the focus and screen brightness etc. manually.

To Change to Manual Recording Mode

Preparation:

- Slide the mode switch to select or mode.
- Press the **SELECT PLAY/REC** button to select recording mode.

Press twice.



To return to the auto recording mode

Press the **AUTO/MANUAL** button so that the indicator appears.

Program AE

You can record videos or still images with optimum brightness by adjusting the exposure and shutter speed to suit your surroundings or the subject.

After performing "To Change to Manual Recording Mode" (⇨ above)

- 1 Touch the **MENU** button.
- 2 Select **[PROGRAM AE]**.
- 3 Select the desired setting.



For details on each setting, see the right column.

To cancel program AE

Select **[OFF]** in step **2**.

Items for program AE setting

- NIGHT:**
Records with more sensitivity in dim locations by adjusting the shutter speed automatically.
- TWILIGHT:**
Makes evening scenes look more natural.
- PORTRAIT:**
The subject in the foreground is accentuated by blurring the background.
- SPORTS:**
Records fast moving subjects clearly.
- SNOW:**
Compensates for subjects that may appear too dark when shooting in extremely bright surroundings, such as in snow.
- SPOTLIGHT:**
Select this when a spotlight makes a subject appear too bright.

Backlight Compensation

Backlight compensation brightens the subject by increasing the exposure.

After performing "To Change to Manual Recording Mode" (⇨ left column)

- 1 Touch the **MENU** button.
- 2 Select **[BACKLIGHT COMP.]**.
- 3 Set to **[ON]**.



To cancel backlight compensation

Select **[OFF]** in step **3**.

Manual Setting in Function Menu

You can use manual recording functions easily by selecting items in the function menus.

After performing “To Change to Manual Recording Mode” (▶ pg. 24)

- 1 Touch the **MENU** button.
- 2 Select **[MANUAL SETTING]**.
- 3 Select the desired menu.

For details on each menu, see below.



- 4 Select the desired setting.













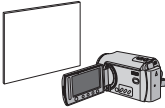

Depending on the kind of settings you select, you can set the value by using the touch sensor.

The menu disappears and the indicator for the set function appears.

- **To return to the previous screen**
Select .
- **To quit the screen**
Touch the **MENU** button.



Menus	Settings: [] = Factory-preset
ADJUST BRIGHTNESS Adjusts the brightness.	For mode [AUTO] : The brightness is adjusted automatically. -6 to +6 : Corrects the brightness within this range in increments of 1. For mode [AUTO] : The brightness is adjusted automatically. -2.0 to +2.0 (EV) : Corrects the brightness within this range in increments of 1/3EV. ■ To lock the exposure When the menu disappears after you finish configuring the setting, select [LOCK] . The indicator appears.
FOCUS Adjusts the focus.	[AUTO] : The focus is adjusted automatically. : Adjusts the focus manually. (When zooming, the subject will not go out of focus if you adjust the focus at the telephoto (T) side before zooming to the wide-angle (W) side.)

Manual Recording (Continued)

Menus	Settings: [] = Factory-preset
<p>WB Adjusts the white balance to achieve the optimum colors for the amount of light in your surroundings during recording.</p>	<p>[A] [AUTO]: White balance is adjusted automatically. <input checked="" type="checkbox"/> MWB: Adjusts the white balance manually depending on the light source.</p> <ol style="list-style-type: none"> 1) Hold a sheet of plain white paper in front of the subject so that the white paper fills the screen. 2) Keep touching the OK button until the <input checked="" type="checkbox"/> indicator starts blinking then stops blinking.  <p> FINE: When shooting outdoors on a sunny day.  CLOUD: When shooting outdoors on a cloudy day.  HALOGEN: When a video light or similar type of lighting is used.</p>
<p>SHUTTER SPEED A fast shutter speed can freeze the motion of a fast-moving subject, and a slow shutter speed can blur the subject to give the impression of motion.</p>	<p>[AUTO]: The shutter speed is adjusted automatically. 1/2 to 1/4000 (For  mode)/ 1/2 to 1/500 (For  mode): The smaller the value, the faster the shutter speed.</p> <p>NOTE It is recommended to use the tripod ( pg. 18) when recording with a slow shutter speed.</p>
<p>PHOTOMETRY AREA Enables you to adjust the brightness in the desired spot when backlight compensation does not work well.</p>	<p><input type="checkbox"/> [WHOLE SCREEN]: Brightness is adjusted automatically for whole screen. <input type="checkbox"/> SPOT: Brightness for the specified spot is adjusted automatically. Furthermore, brightness in the specified spot can be locked by selecting [LOCK]. The  indicator appears.</p> <p>■ To cancel spot exposure control Select [WHOLE SCREEN] again so that the  indicator disappears.</p>
<p>EFFECT Enables you to record videos or still images with special effects.</p>	<p><input type="checkbox"/> [OFF]: No effect is used. <input checked="" type="checkbox"/> SEPIA: The image has a brownish tint like old photos. B/W MONOTONE: The image becomes black and white like old movies.  CLASSIC FILM*: This effect skips frames to give images of an old movie atmosphere.  STROBE*: The image looks like a series of consecutive snapshots. * Not available in  mode.</p>
<p>TELE MACRO Enables you to shoot a subject as large as possible at a distance of approx. 50 cm (1.64 ft).</p>	<p><input type="checkbox"/> [OFF]: Disables the function. <input checked="" type="checkbox"/> ON: Activates the function.</p>

Playing Back Files

Video/Still Image Playback

- 1 Slide the mode switch to select  (video) or  (still image) mode.



- 2 Press the **SELECT PLAY/REC** button to select playback mode.



SELECT
PLAY/REC

The index screen for videos appears.

- 3 Select the desired file.



- To watch on TV

See page 31.

- To check the file information







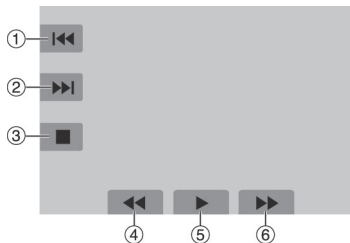

Press the **INFO** button when playback is paused. (→ pg. 33)



- To adjust the sound volume of videos

Turn down the volume  Turn up the volume

Operations during Video Playback









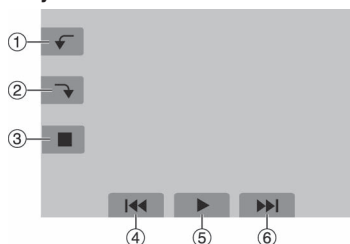

- 1  : Return to the first scene of the file
- 2  : Go to the first scene of the next file
- 3  : Return to the index screen
- 4  : Reverse search (during playback)
 : Frame-by-frame playback in reverse direction (during pause)*
- 5  : Playback
 : Pause
- 6  : Forward search (during playback)
 : Frame-by-frame playback in forward direction (during pause)*

* Slow playback starts when you keep touching the sensor button under  /  for a while.

Operations during Still Image Playback



- 1  : Rotate 90 degrees counterclockwise
 : Change playback order of slide show in reverse direction
- 2  : Rotate 90 degrees clockwise
 : Change playback order of slide show in forward direction
- 3  : Return to the index screen
- 4  : Display the previous file
- 5  : Start/end the slide show
- 6  : Display the next file

Playing Back Files (Continued)

File Search Function

You can switch the index screen to the date index screen or event screen and search a file by the recording date or the event.

Date Index Screen

You can search the desired file by the recording date.

Preparation:

- Slide the mode switch to select or mode.
- Press the **SELECT PLAY/REC** button to select playback mode.

1 Select .

2 Select the recording date.



3 Select the file you want to play back.



■ To return to the index screen

Select .

■ To quit the screen

Select [QUIT].

Event Screen



You can search the desired file by the event that you registered the file to when recording. (pg. 23) After searching by the event, you can search by the recording date to narrow down the search.

Preparation:

- Slide the mode switch to select mode.
- Press the **SELECT PLAY/REC** button to select playback mode.

1 Select .

2 Select the event.

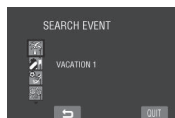

3 Select the recording date.

To display all the files, select [ALL SCENES].

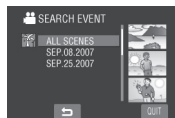

4 Select the file you want to play back.



■ To return to the index screen

Select .

■ To change the event registration of a file

See page 34.

To Play Back MPG Files



MPG files (demonstration files, etc.) are stored in the EXTMOV folder. Follow the procedure below to play back the MPG files in the EXTMOV folder.

Preparation:

- Slide the mode switch to select  mode.
- Press the **SELECT PLAY/REC** button to select playback mode.

1 Touch the **MENU** button.

2 Select **[PLAYBACK MPG FILE]**.



3 Select the file you want to play back.

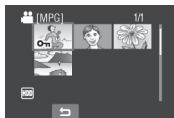

■ To return to the normal file playback mode

Select .

■ To quit the screen

Select [QUIT].

NOTE

An MOD file is created in the EXTMOV folder when management information is corrupted.

Playing Back Files (Continued)

Playback with Special Effects



Wipe or fader effects

Add effects at the beginning and end of videos. These effects cannot be set for still images.

Playback effects

Add effects that, for example, alter the color tones of images.

Preparation:

- Slide the mode switch to select  or  mode.
- Press the **SELECT PLAY/REC** button to select playback mode.

The following screen illustrations are examples when setting [EFFECT] to [SEPIA].

- 1 Touch the MENU button.
- 2 Select [WIPE/FADER] ( mode only) or [EFFECT].











- 3 Select a desired effect.
For details on each effect, see the right column.



- 4 Select the file you want to play back.

- **To turn off the effect**
Select [OFF] in step 3.





■ Items for WIPE/FADER setting

-  **FADER-WHITE:**
Fades in or out with a white screen.
-  **FADER-BLACK:**
Fades in or out with a black screen.
-  **FADER-B.W:**
Fades in to a color screen from a black and white screen, or fades out in the opposite way.
-  **WIPE-CORNER:**
Wipes in on a black screen from the upper right to the lower left corner, or wipes out in the opposite way.
-  **WIPE-WINDOW:**
Starts in the center of a black screen and wipes in toward the corners, or wipes out in the opposite way.
-  **WIPE-SLIDE:**
Wipes in from right to left, or wipes out in the opposite way.
-  **WIPE-DOOR:**
Wipes in as the two halves of a black screen which open to the left and right revealing the scene, or wipes out in the opposite way.
-  **WIPE-SCROLL:**
Wipes in from the bottom to the top of a black screen, or wipes out in the opposite way.
-  **WIPE-SHUTTER:**
Wipes in from the center of a black screen toward the top and bottom, or wipes out in the opposite way.

NOTE

When the screen fades in or out, the sound also fades in or out.

■ Items for EFFECT setting

-  **SEPIA:**
The image is given a brownish tint like an old photo.
-  **MONOTONE:**
The image becomes black and white like an old movie.
-  **CLASSIC FILM*:**
The image is given an old movie atmosphere by the effect of skipping frames.
-  **STROBE*:**
The image looks like a series of consecutive snapshots.
* Not available in  mode.

Watching Images on TV

Preparation:

● Set [SWITCH TO ANALOG I/O] to [OUTPUT]. (Factory-preset = [OUTPUT])* (☞ pg. 63)

● Turn off all units.

* This does not apply to the GZ-MG330 model.

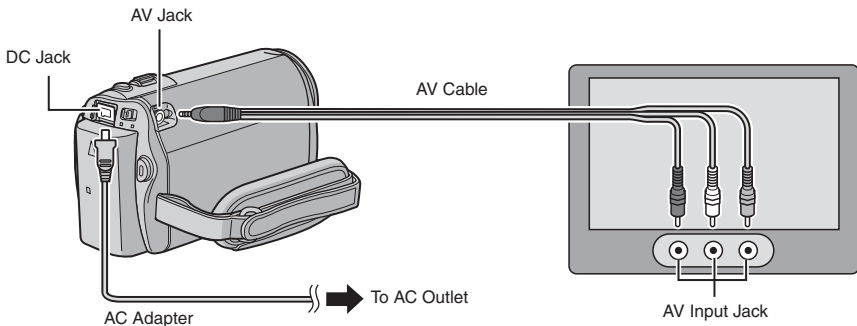

NOTES

● You can also connect the cables using the Everio dock connectors. The S-Video cable (optional) enables even higher playback quality. (☞ pg. 10) When other devices such as a DVD burner are connected to the Everio dock, turn the power of these devices off.*

● This camera is designed to be used with NTSC-type color television signals. It cannot be used with a television of a different standard.

*GZ-MG330 model does not include the Everio dock.

- 1 Turn on the camera and the TV.
- 2 Set the TV to its VIDEO mode.
- 3 (Only when connecting the camera to the VCR/DVD recorder)
Turn on the VCR/DVD recorder, and set it to its AUX input mode.
- 4 Start playback on the camera. (☞ pg. 27)

■ If the aspect ratio of the image is not correct as shown on the right

Change the settings in [SELECT TV TYPE].
(☞ pg. 65)

■ To display the camera's on-screen display on TV

Set [DISPLAY ON TV] to [ON]. (☞ pg. 65)

16:9 TV



4:3 TV



Managing Files



CAUTION

Do not remove the recording medium or perform any other operation (such as turning off the power) while accessing files. Also, be sure to use the provided AC adapter, as the data on the recording medium may be corrupted if the battery becomes exhausted during operation. If the data on the recording medium becomes corrupted, format the recording medium. (▶ pg. 65)

Deleting/Protecting Files

- Protected files cannot be deleted. To delete them, release the protection first.
- Once files are deleted, they cannot be restored. Check files before deleting.

Preparation:

- Slide the mode switch to select  or  mode.
- Press the **SELECT PLAY/REC** button to select playback mode.

The following screen illustrations are examples when performing [DELETE].

1 Touch the MENU button.

You can skip directly to the delete menu by selecting .

2 Select [DELETE] or [PROTECT/CANCEL].

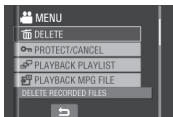

Deleting/Protecting the Currently Displayed File

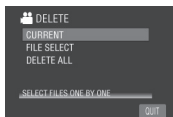

After performing steps 1-2

3 Select [CURRENT].

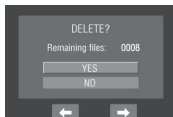

4 When [DELETE?] or [PROTECT?] appears, select [YES].



You can select the previous or next file by selecting  or .



Deleting/Protecting Files

After performing steps 1-2

3 Select [FILE SELECT].

4 Select the desired file.



- The  (deletion) or  (protection) mark appears on the file. To select other files, repeat this step.
- If you slide the zoom lever towards **T**, the preview screen is displayed. Sliding the zoom lever towards **W** returns to the index screen.

5 Select [QUIT].

- 6** Select [EXECUTE AND QUIT] (when performing [DELETE]) or [YES] (when performing [PROTECT]).



Deleting/Protecting All Files

After performing steps 1-2 (☞ pg. 32)

- 3** Select [DELETE ALL] or [PROTECT ALL].
- 4** When [DELETE ALL?] or [PROTECT ALL?] appears, select [YES].

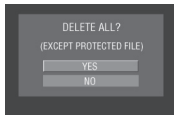

- **To quit the screen**
Select [QUIT].

- **To release protection**
Select the protected file in step 4 ("Deleting/Protecting Files" ☞ pg. 32).
- **To release protection of all files**
1) In step 3, select [CANCEL ALL].
2) Select [YES].

Viewing File Information

Preparation:

- For mode: Pause the playback. Alternatively, select the file on the index screen.
- For mode: Play back the still image. Alternatively, select the file on the index screen.

Press the INFO button.



- **FILE:**
File name
 - **FOLDER:**
Folder name
 - **DATE/TIME:**
Date and time of the recording
 - **PB TIME (for video files):**
Playback time (length of the file)
 - **SIZE (for still images):**
Image size
 - **QUALITY:**
Image quality (☞ pg. 62)
 - **PROTECT:**
File protection status (☞ pg. 32)
- **To turn off the file information display**
Press the **INFO** button again.

Managing Files (Continued)

Changing the Event Registration of Video Files after Recording

Preparation:

- Slide the mode switch to select  mode.
- Press the **SELECT PLAY/REC** button to select playback mode.

1 Touch the **MENU** button.

2 Select [**CHANGE EVENT REG.**].

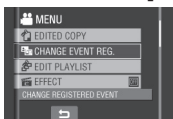

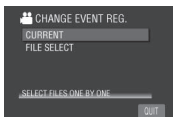

Changing the Event of the Currently Displayed File

3 Select [**CURRENT**].



4 Select the file you want to register.



You can select the previous or next file by selecting  or .

Changing the Event of the Selected Files

After performing steps 1-2

3 Select [**FILE SELECT**].

4 Select the file you want to register.

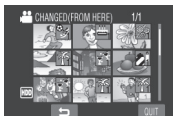

- When you select a file, the color of the cursor changes. To select other files, move the cursor forward. You can only select the files in order.
- If you slide the zoom lever towards **T**, the preview screen is displayed. Sliding the zoom lever towards **W** returns to the index screen.

5 Select a new event you want to register the file to.

- To select a different destination, select [**SORT**].
- To cancel the event registration, select [**CANCEL**].



■ To quit the screen
Select [**QUIT**].

Partial Delete (EDITED COPY)



You can divide the selected video file into two, and make a copy of the desired section as a new video file.

Preparation:

- Slide the mode switch to select  mode.
- Press the **SELECT PLAY/REC** button to select playback mode.

1 Touch the MENU button.

2 Select [EDITED COPY].



3 Select the desired file.



Playback starts.

4 Set the point at which you want to divide the file.



5 Select the file you want to copy.



- **[COPY 1st SECTION]:**
Copy the section before the division point.
- **[COPY 2nd SECTION]:**
Copy the section after the division point.

When copying is finished, the copied file is added to the index screen.

- **To quit the screen**
Select [QUIT].

NOTE

When playing back the copied file, the recording date of the original file is displayed. Meanwhile, the date when you copied is displayed on the file information display. (pg. 33)

Playlists



It is a list that enables you to organize recorded videos in order of preference.

Preparation:

- Slide the mode switch to select mode.
- Press the **SELECT PLAY/REC** button to select playback mode.

Creating Playlists

1 Touch the **MENU** button.

2 Select **[EDIT PLAYLIST]**.

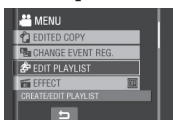

3 Select **[NEW LIST]**.

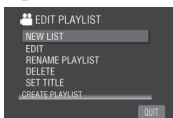

4 Select an item and display files.

- **[CREATE BY DATE]:**
Display all the files in the medium listed by recording date.
- **[CREATE BY EVENT]:**
Search for an event and display the corresponding files listed by recording date.
- **[SELECT FROM SCENES]:**
Display all files individually.

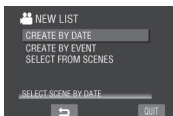

5 Select the file to add to playlist.



To preview scenes, select the file and select **[CHECK]**. When the index screen of individual scenes appears, select the file, then touch the **OK** button.

To return to the previous screen, select .

6 Select the insertion point.

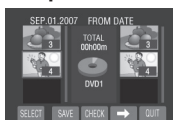

- To add other files, repeat steps **5** and **6**.
- To delete a registered scene, select the registered file, then select **[CANCEL]**.

7 Select and then **[SAVE]**.

8 Select **[SAVE AND QUIT]**.

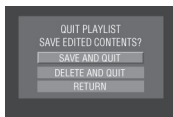

■ To quit the screen

Select **[QUIT]**.

NOTES

- A maximum of 99 playlists can be created.
- Each playlist can consist of a maximum of 99 scenes.
- If you delete the original files, the corresponding files are also deleted from the playlist.

Creating Playlists including Titles

You can easily create a playlist including a title.

1 Press the TITLE button.



2 Select [NEXT].



3 Select the desired file.



You can check the scene by selecting [CHECK].

4 Select the desired title.



- **To return to the previous screen**
Select [↶].
- **To quit the screen**
Select [QUIT].

Playing Back Playlists

- 1 Touch the MENU button.
- 2 Select [PLAYBACK PLAYLIST].

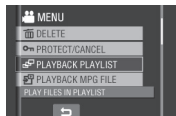

- 3 Select the playlist you want to play back.

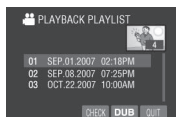

- **To stop playback**
Select [■].
- **To quit the screen**
Select [QUIT].
- **To play back from the desired scene**
 - 1) In step 3, select [CHECK]. (The index screen for playlist appears.)
 - 2) Select the desired scene.

NOTE

When playing back a playlist with a picture title, playback starts after the title is displayed for 5 seconds.

- **To dub playlists using a VCR/DVD recorder** (pg. 46)

Play back playlists by performing the following operations.

- 1) After performing steps 1-2 shown above, select [DUB].
- 2) Select [YES].

NOTES

- For playlist without a picture title: A black screen is displayed at the first and the last scene for 5 seconds.
- For playlist with a picture title: The title is displayed at the first scene for 10 seconds.



Other Operations of Playlists

You can perform additional editing and delete files in a created playlist.

Preparation:

Perform steps **1-2**. (☞ pg. 36)

Adding/Deleting Files in Playlist

- 3** Select [EDIT].
- 4** Select the playlist you want to edit.
To add or delete files, follow the steps **5** to **8** in "Creating Playlists". (☞ pg. 36)

Changing Playlist Names

- 3** Select [RENAME PLAYLIST].
- 4** Select the desired playlist.
- 5** Select the desired letter.
 - Repeat this process to complete the name.
 - You can change the character types (capital letters, small letters or marks) by selecting [A/a/@].
 - To correct a letter, move the cursor to the letter by sliding your finger up and down, then select [CLEAR].
- 6** When [QUIT?] appears, select [SAVE AND QUIT].

Deleting Playlist

- 3** Select [DELETE].
- 4** Select a playlist you want to delete.
To delete all playlists at once, select [DELETE ALL].
- 5** When [DELETE PLAYLIST?] appears, select [YES].

Adding a Picture Title to Playlist

- 3** Select [SET TITLE].
- 4** Select the desired playlist.
- 5** Select the desired picture title.



DPOF Print Setting

This camera is compatible with DPOF (Digital Print Order Format). You can set which images to be printed and the number of prints with this camera. This feature is useful to print with a DPOF-compatible printer or take the recording medium to a photo lab for printing.

Preparation:

- Slide the mode switch to mode.
- Press the **SELECT PLAY/REC** button to select playback mode.

1 Touch the MENU button.

2 Select [DPOF].



Setting Files Individually

After performing steps 1-2

3 Select [SET PRINT QUANTITY].

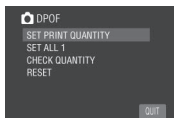

4 Select the desired file.

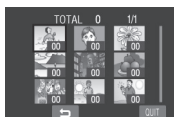

If you slide and hold the zoom lever towards **T**, the preview screen of the still image is displayed.

5 Select the number of prints. (max. 15 prints)

To set print information for other images, repeat steps **4** and **5**. (You can set up to 999 files.)

■ To quit the screen

Select [QUIT].

■ To cancel the selection

Set the number of prints to "00" in step **5**.

Setting All Files Together (One Print for Each File)

After performing steps 1-2 (left column)

3 Select [SET ALL 1].

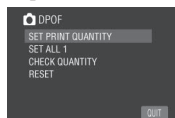

4 When [SET ALL TO 1?] appears, select [YES].

■ To quit the screen

Select [QUIT].

■ To confirm DPOF settings

In step **3**, select [CHECK QUANTITY].

- If necessary, change the number of prints for the desired file by following steps **4** and **5**.

■ To reset DPOF settings

- 1) In step **3**, select [RESET].
- 2) When [RESET?] appears, select [YES].



Direct Printing with PictBridge Printer

If your printer is compatible with PictBridge, still images can be printed easily by connecting the camera directly to the printer with the USB cable. DPOF setting can also be used. (▶ pg. 39)

Preparation:

Close the LCD monitor to turn off the camera.

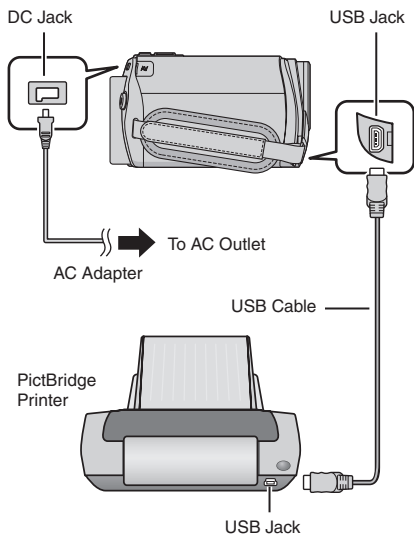

You can also connect the cables using the jacks on the Everio dock. (▶ pg. 10)*

* GZ-MG330 model does not include the Everio dock.

1 Open the LCD monitor to turn on the camera.

2 Select [DIRECT PRINT].

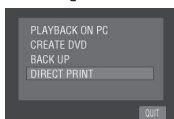

To Print by Selecting a Still Image

After performing steps 1-2 (▶ left column)

3 Select [SELECTED PRINT].



4 Select the desired image.



5 Select the desired setting.



- **[NUMBER OF PRINTS]:**
The number of prints can be set from 1 to 99.
- **[DATE]:**
Set whether to print the date and time.

6 Select [PRINT].

■ To stop printing after printing starts

- 1) Select [STOP].
- 2) When [QUIT PRINTING?] appears, select [YES].

To Print Using the DPOF Settings

If the printer is compatible with DPOF, you can use the DPOF settings. (pg. 39)

After performing steps 1-2 (pg. 40)

3 Select [DPOF PRINT].

4 Select [PRINT].



■ To stop printing after printing has already started

- 1) Select [STOP].
- 2) When [QUIT PRINTING?] appears, select [YES].

■ To confirm the DPOF setting

In step **4**, select [CHECK SETTINGS]. To return to the previous screen, select ↩.

NOTES

- If the printer is not recognized, disconnect the USB cable, then reconnect it.
- You cannot return to the previous screen while operating Direct print. If you want to redo the operation, remove the USB cable, turn the camera off, and start the operation again from the beginning.

Copying Files

Types of Copying and Connectable Device

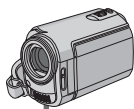

The Camera

You can copy video/still images from HDD onto microSD card or from microSD card to HDD with this camera alone. (➡ pg. 48)

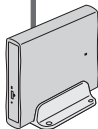

DVD Burner (CU-VD3)

You can copy video files recorded on this camera onto DVD discs. (➡ right column)



VCR/DVD Recorder

You can dub video files recorded on this camera onto DVD discs. (➡ pg. 46)



PC

You can copy video/still image files on this camera onto your PC. (➡ pg. 49 to 60)

Using a DVD Burner to Copy Files from the Camera

Supported discs: 12cm DVD-R, DVD-RW

- Regarding DVD-R discs, only unused DVD-R discs can be used. Regarding DVD-RW discs, used DVD-RW discs can also be used, but they need to be formatted before recording. Formatting a disc deletes all content recorded on the disc up until that time.
- Dual-layer discs cannot be used.

Regarding finalization after copying

The disc is automatically finalized so that it can be played on other devices. After finalizing, the disc is a play-only disc, so no more files can be added.

NOTE

When using the optional DVD Burner, read its instructions.

Connection with a DVD Burner

Preparation:

Close the LCD monitor to turn off the camera.

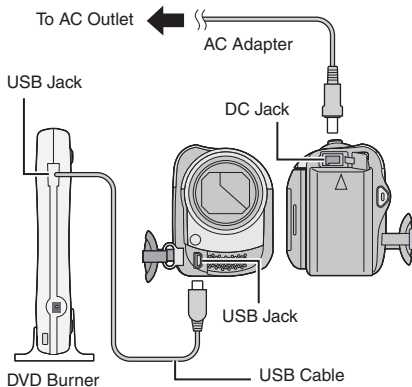



NOTE

Use the USB cable that came with the DVD burner.

Making a Backup of All Files

Preparation:

- Connect the camera to the DVD burner.
( pg. 42)
- Slide the mode switch to select  mode.

The following screen illustrations are examples when backing up video files.

1 Select [CREATE TOGETHER].



2 Select the desired menu.

- **[ALL SCENES]:**
All files in the recording medium are copied.
- **[UNSAVED SCENES]:**
Files that have never been copied to a DVD disc are automatically selected and copied.

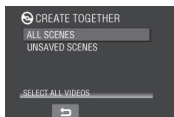

3 Select the desired menu.

- The files are copied on the disc. When [COMPLETED] appears, touch the **OK** button.
- When [COMPLETED. CHANGE DISC] appears, change the disc. Remaining files are copied on the second disc.
- To cancel copying, select [STOP].

Copying Video Files that Have Never Been Copied

Files that have never been copied to the DVD discs are automatically selected and copied.

1 Open the LCD monitor to turn on the camera.

2 Press the DIRECT DVD button.



3 Select [EXECUTE].

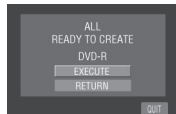

- The DVD disc begins to be created. When [COMPLETED] appears, touch the **OK** button.
- When [COMPLETED. CHANGE DISC] appears, change the disc. The second DVD disc begins to be created.
- To cancel the DVD creation, select [CANCEL].

■ To quit the screen

- 1) Select [QUIT].
- 2) When [QUIT?] appears, select [YES].

Copying Files (Continued)

Selecting Files for Backup

Preparation:

- Connect the camera to the DVD burner.
(☞ pg. 42)
- Slide the mode switch to select  mode.

The following screen illustrations are examples when backing up video files.

1 Select [SELECT AND CREATE].



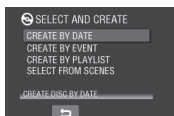

2 Select the desired menu.



- **[CREATE BY DATE]:**
Files are sorted according to the date on which they were recorded. Relevant files are displayed in a list. Select the recording date, and touch the **OK** button.
- **[CREATE BY EVENT]:**
Files are sorted according to event. Relevant files are displayed in a list. Select the event, and touch the **OK** button.
- **[CREATE BY PLAYLIST]:**
Files are sorted according to playlist. The selected playlists are displayed in a list.
 - 1) Select the desired list, and touch the **OK** button.
 - 2) Select the insertion point and select . To select other lists, repeat this process.
- **[SELECT FROM SCENES]:**
Select files individually.
 - 1) Select the desired file, and touch the **OK** button.
 - 2) Select the insertion point and select . To select other files, repeat this process.

3 Select the desired disc number.

- If you select [ALL], all discs in the list are created.
- To preview scenes, select [CHECK]. When the index screen of individual scenes appears, select the file, and touch the **OK** button.
To return to previous screen, select .
-  mark shows that the disc is created already.

4 Select [EXECUTE].

- A disc begins to be created. When [COMPLETED] appears, touch the **OK** button.
- When [COMPLETED. CHANGE DISC] appears, change the disc. The second disc begins to be created.
- To cancel the disc creation, select [STOP].

■ To quit the screen

- 1) Select [EXIT].
- 2) When [QUIT?] appears, select [YES].

NOTE

When executing [CREATE BY PLAYLIST], date/time on the file information display shows the date of copying the file, instead of the actual recording date.

■ To duplicate a disc

The last creation date is displayed. (Up to 20 files)

- 1) In step **1** (☞ left column), select [CREATE DUPLICATE].
- 2) Select the date and touch the **OK** button, then go to step **4**.

■ To check whether the DVD disc was created properly

In step **1** (☞ left column), select [PLAYBACK], and touch the **OK** button.

■ To play back the created disc using the camera

- 1) Connect the camera to the DVD burner.
(☞ pg. 42)
- 2) To view the disc on TV, connect the camera to TV. (☞ pg. 31)
- 3) Turn on the camera.
- 4) Select [PLAYBACK].
- 5) Select the desired folder.
- 6) Select the creation date of the disc.
- 7) Select the desired file. To return to the previous screen, select ⏪.

■ Disc number

Disc number shows the number of DVD discs you can create. The dubbing range of each disc is automatically allocated, presuming that all the files are to be dubbed from the first one on the list. This dubbing range cannot be changed. E.g.) "DVD1" can contain two files, "JAN.01.2007" and "JAN.15.2007".

ALL
DVD1 JAN.01.2007 12:04
JAN.15.2007 12:15
DVD2 FEB.01.2007 12:04
FEB.08.2007 12:15

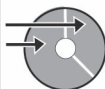

■ Title and chapter of created DVD

Each recording date becomes one title in a created DVD and each file recorded in a same day becomes one chapter in the title.

Jan. 10. 2007: file 1 and 2 were recorded.

File 1	File 2
--------	--------

Jan. 11. 2007: file 3 and 4 were recorded.

File 3	File 4
--------	--------



Title

JAN.10.2007	JAN.11.2007
-------------	-------------

File 1	File 2	File 3	File 4
--------	--------	--------	--------

1	2	3	4
---	---	---	---

Chapter

■ Menu for disc playback

When you play back the created DVD disc on a DVD player or other devices, the following top menu will be displayed.



- ① Disc title: Creating date of the disc
- ② Disc number (☞ left column)
- ③ Title thumbnail: First scene of the title
- ④ Title name: Recording date/Playlist name

Copying Files (Continued)

Using a VCR/DVD Recorder to Dub Files from the Camera

Preparation:

- Set [SWITCH TO ANALOG I/O] to [OUTPUT]. (Factory-preset = [OUTPUT])* (☞ pg. 63)
- Turn off all units.

* This does not apply to the GZ-MG330 model.

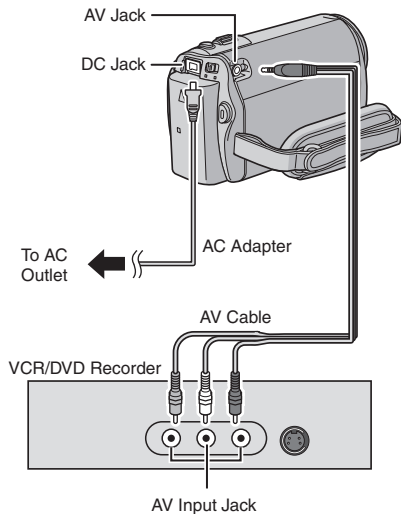

You can also connect the cables using the jacks on the Everio dock connectors. The S-Video or DV cable (optional) enables even higher dubbing quality. (☞ pg. 10) When other devices such as a DVD burner are connected to the Everio dock, turn the power of these devices off.*

* GZ-MG330 model does not include the Everio dock.

1 Set the VCR/DVD recorder to its **AUX** input mode.

2 Start playback on the camera.

- To play back videos (☞ pg. 27)
- To play back playlists ("To dub playlists using a VCR/DVD recorder" ☞ pg. 37)

3 At the point you want to start dubbing, start recording on the VCR/DVD recorder.

Refer to the VCR/DVD recorder's instruction manual.

■ To stop dubbing

Stop recording on the VCR/DVD recorder, then press the **START/STOP** button again.

NOTE

To record only the date information among the display indications, set [DISPLAY ON TV] to [ON], and touch the **OK** button until date/time indication appears. (☞ pg. 65)

Using the Camera to Dub Files from a VCR/DVD Player

Preparation:

- Set [SWITCH TO ANALOG I/O] to [I/O]*. (☞ pg. 63)
- Turn off all units.

* This does not apply to the GZ-MG330 model.

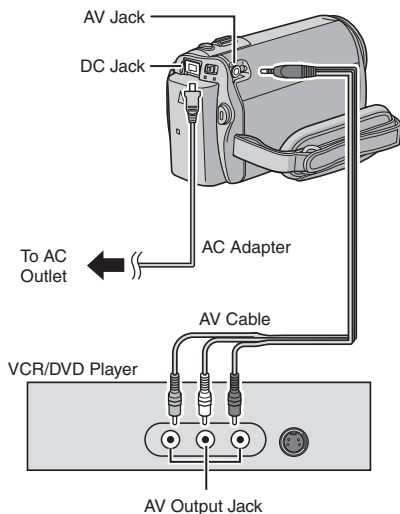

You can also connect the cables using the jacks on the Everio dock connectors. The S-Video cable (optional) enables even higher quality dubbing. (☞ pg. 10) When other devices such as a DVD burner are connected to the Everio dock, turn the power of these devices off.*

* GZ-MG330 model does not include the Everio dock.

1 Start playback on the VCR/DVD player.

2 Press the START/STOP button on the camera at the scene where you want to start recording.

■ To stop recording

Press the **START/STOP** button again.

NOTES



- If "COPY PROTECTED CONTENT" appears, the file is protected and cannot be recorded.
- If the videos you want to record contain both 16:9 and 4:3 screen size, recording stops where the aspect ratio switches. To record such videos, you need to perform recording operation at every switching point.

Copying Files (Continued)

Copying/Moving Files

You can copy or move files in the HDD and microSD card using the on-screen display.

Preparation:

- Slide the mode switch to select  or  mode.
- Press the **SELECT PLAY/REC** button to select playback mode.
- Make sure that microSD card is inserted in the microSD slot.
- Make sure that enough free space is left in the copy/move destination medium.

1 Touch the MENU button.

2 Select [COPY] or [MOVE].

- **[COPY]:**
Files are copied to the destination medium while leaving original files in the source medium.
- **[MOVE]:**
Files are moved to the destination medium while deleting original files (except read-only files) in the source medium.

3 Set the direction of copy/move by selecting [SELECT]. (HDD → SD or SD → HDD)



4 Set the file unit ([ALL] or [FILE]) to copy/move by selecting [SELECT].

- **[FILE]:**
Select when you want to transfer the selected files.
 - 1) Select the desired file, and touch the **OK** button.
 - The **✓** mark appears on the file. To select other files, repeat this step.
 - 2) Select .
- **[ALL]:**
Select when you want to transfer all files in the recording medium.

5 Select [EXECUTE].

File transfer starts. When [COPYING/MOVING COMPLETED] appears, touch the **OK** button.

■ **To quit the screen**

Select [QUIT].

■ **To stop the file transfer**

- 1) Select [STOP].
- 2) When [QUIT?] appears, select [YES].

File Backup on a Windows® PC

Install the software that came with the camera to your PC.

You can back up your files on your PC with a simple one-touch operation, edit your files on your PC, and also create discs.

Even if you do not install the software, you can still back up your files on your PC.

(☞ pg. 53)

For the compatible DVD burners, refer to CyberLink web site:

http://www.cyberlink.com/english/products/powerproducer/3/comp_dvd_drives.jsp

NOTE

The system requirements information is not a guarantee that the provided software will work on all personal computers meeting those requirements.

System Requirements

OS:

Either one of the following OS should be pre-installed (32-bit):

Windows® XP Home Edition (SP2), Windows® XP Professional (SP2), Windows Vista™ Home Basic, Windows Vista™ Home Premium

CPU:

Intel® Pentium® 4, at least 1.6 GHz

(at least 2.2 GHz recommended)

Intel® Pentium® M, at least 1.4 GHz

Intel® Core™ Duo, at least 1.5 GHz

RAM:

[XP] At least 256 MB (For creating DVD Video by PowerCinema (☞ pg. 55), 1 GB or more)

[Vista] At least 1 GB (2 GB or more recommended)

Free hard disk space:

At least 550 MB for installation

For creating DVD Video, at least 10 GB recommended

For creating VCD, at least 1 GB recommended

USB port:

USB 2.0 port

Display:

Must be capable of displaying at least 1024 x 768 (XGA) in high color 16 bit or higher (1280 x 1024 (SXGA) or higher is recommended)

Miscellaneous:

Internet Explorer 5.5 or later

DirectX 9.0 or later

Supported media:

DVD-Video: DVD-R/-RW, DVD+R/+RW

DVD-VR: DVD-RW, DVD-RAM

DVD+VR: DVD+RW

VideoCD: CD-R/RW

File Backup on a Windows® PC (Continued)

Software Installation

The following software is included in the CD-ROM that came with your camera.

• CyberLink DVD Solution

Comprehensive application software that consists of the following three kinds of software.

PowerCinema NE for Everio

The main file managing software. You can perform various operations such as file backup, playback, and DVD authoring.

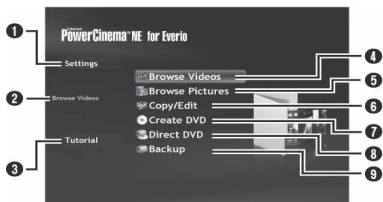

- 1 You can perform detailed settings for each item.
- 2 Select a function on the right, and the explanation of function is displayed.
- 3 Displays operating procedure for each function. (internet connection is required)
- 4 Plays back video files on the PC (☞ pg. 54)
- 5 Plays back still image files on the PC (☞ pg. 54)
- 6 Copies/edits files on the PC
- 7 Burns file that are backed up on the PC onto a DVD
- 8 Creates a DVD-Video (☞ pg. 55)
- 9 Backs up camera files onto the PC (☞ pg. 52)

PowerProducer 3 NE

Allows you to create discs. Automatically starts from an operation in PowerCinema NE for Everio.

PowerDirector 5 NE Express

Allows you to edit files on your PC. Automatically starts from an operation in PowerCinema NE for Everio.

• Digital Photo Navigator 1.5

Allows you to change the format of still image files backed up on your PC.

You can find the latest information on the provided software program at CyberLink's world wide web server at <http://www2.cli.co.jp/products/ne/>

Preparation:

Quit any other software you are using. (Check that there are no other application icons on the status bar.)

1 Load the provided CD-ROM into the PC.

After a moment, the [SETUP] screen appears. If the [SETUP] screen does not appear, double-click the CD-ROM icon in [My Computer].

2 Click [Easy Installation].

If you want to specify the type of software to install or the installation destination folder etc., select [Custom Installation]. Follow the instructions on the screen to install the software.

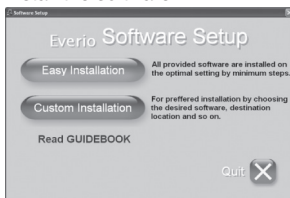

3 Click [Yes].

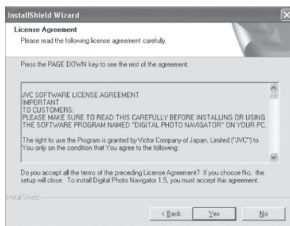

4 Select the desired language and click [OK].

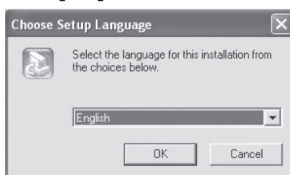

5 Click [Yes].

The software installation starts.

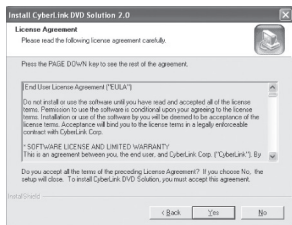

6 Click [Finish].

■ When installation is completed

The installed software is displayed in [All Programs].



The backup destination folder [MyWorks] for files is created on the hard disk drive that has the most free space.

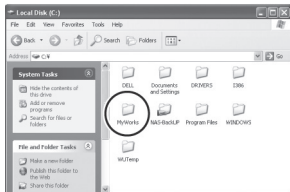

Connecting the Camera to the PC

Preparation:

Close the LCD monitor to turn off the camera.

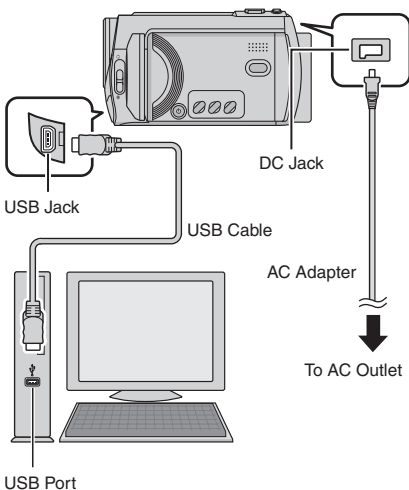

NOTES

- Never disconnect the USB cable while the access/charge lamp on the camera lights or blinks.
- Do not turn off the camera when the USB cable is connected, to prevent malfunctions of the PC.
- Connect the camera directly to the USB jack on the PC, not through a hub.
- Do not use an extension USB cable.
- Saving the wrong kinds of files in a recording medium or deleting files or folders from a recording medium can cause problems with the operation of the camera. When it is necessary to delete a file from a recording medium, delete it through the camera. Also, do not move or rename folders and files in the medium on PC.

File Backup on a Windows® PC (Continued)

■ When you have finished operation

Always follow the procedures below when disconnecting the camera, or turning off the power of the camera/PC.

Failing to do so may cause damage to the camera and PC.

- 1) Confirm that the access/charge lamp on the camera does not light or blink. (If the access/charge lamp lights or blinks, wait until it is turned off before proceeding.)
- 2) Double-click the [Safely Remove Hardware] or [Unplug or Eject Hardware] icon in the status bar.
- 3) Select [USB Mass Storage Device] or [USB Disk], and then click [Stop].
- 4) Click [OK].
- 5) Disconnect the USB cable.
- 6) Turn off the camera and PC.

File Backup on the PC

This method uses the software on the provided CD-ROM to back up files onto your PC.

Video files that have never been backed up onto the connected PC are automatically selected from the back up history and backed up.

If you could not install the software, turn to page 53 for details of how to back up your files without using this software.

Preparation:

- Install the software from the provided CD-ROM. (☞ pg. 50)
- Connect the camera to the PC with the USB cable. (☞ pg. 51)

1 Open the LCD monitor to turn on the camera.

2 On the camera, press the **DIRECT BACK UP** button.

Although a dialog box appears on the PC, you do not need to use it. File copy starts automatically.



When the progress bar disappears, the process is complete.

NOTE

When backup is performed, folders for each medium (HDD or microSD) are created in the [MyWorks] folder (☞ pg. 51), and the files are backed up inside those folders. (If backup is performed from more than one camera HDD, individual HDD folders are created.)

File Backup from a Specified Media

Preparation:

- Install the software from the provided CD-ROM. (☞ pg. 50)
- Connect the camera to the PC with the USB cable. (☞ pg. 51)

1 Open the LCD monitor to turn on the camera.

2 On the camera, select [**BACK UP**].

3 Click [EVERIO_HDD] or [EVERIO_SD].

When the progress bar disappears, the process is complete.

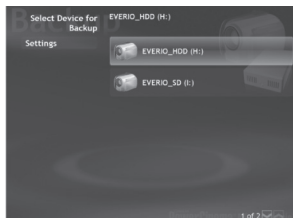

File Backup on the PC without Using Software

Preparation:

Connect the camera to the PC with the USB cable. (➡ pg. 51)

1 On the PC, create a folder to back up files into.

2 Open the LCD monitor to turn on the camera.

3 On the camera, select [PLAYBACK ON PC].

4 Double-click [EVERIO_HDD] or [EVERIO_SD] icon.

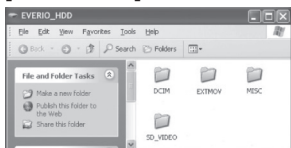

5 Select the folder you want to back up, and drag & drop it into the folder you created in step 1.

• SD_VIDEO:

Folder that contains video files. If you want to back up files individually, open this folder, and drag & drop files such as [PRG001] one by one.

• DCIM:

Folder that contains still image files. If you want to back up files individually, open this folder, and drag & drop files such as [PIC_0001.JPG] one by one.

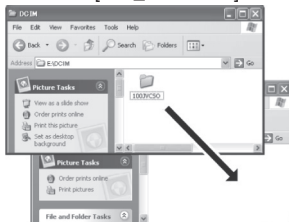

NOTE

For further details on the use of folders, see page 60.

Other Windows® PC Operations

Playing Back Files on the PC

Preparation:

- Install the software from the provided CD-ROM. (☞ pg. 50)
- Connect the camera to the PC with the USB cable. (☞ pg. 51)

1 Open the LCD monitor to turn on the camera.

2 On the camera, select **[PLAYBACK ON PC]**.

Although a dialog box appears on the PC, you do not need to use it. PowerCinema starts automatically.

3 Click **[Browse Videos]** (for video playback) or **[Browse Pictures]** (for still image playback).

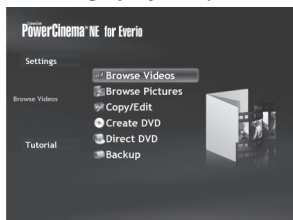

4 Click the media that contains the desired files.



5 Click the desired file.



If you click Sort by/Filter by/View by, searching options are displayed. Use them to search a file quickly.

● Sort by:

The order of files is rearranged according to item that you selected.

● Filter by:

Files are filtered according to the item that you selected.

● View by:

You can change the number of thumbnails on a screen.

For more information on detailed operations of the software, see the Tutorials (☞ pg. 57) or CyberLink web site (☞ pg. 50).

Creating a DVD-Video

Preparation:

- Install the software from the included CD-ROM. (▶ pg. 50)
- Connect the camera to the PC with the USB cable. (▶ pg. 51)
- Open the LCD monitor to turn on the camera.

Copying Video Files that Have Never Been Copied

- 1 On the camera, press the **DIRECT DVD** button.

Although a dialog box appears on the PC, you do not need to use it. PowerCinema starts automatically.

- 2 On the PC, authoring and burning starts.

Click [Stop] to cancel the procedure.

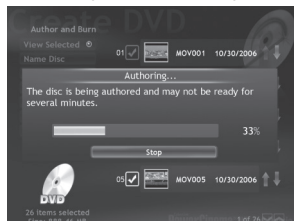

- 3 Click [OK].

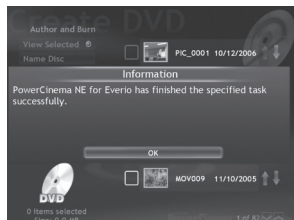

Selecting Files for Backup

- 1 On the camera, select [**CREATE DVD**].

Although a dialog box appears on the PC, you do not need to use it. PowerCinema starts automatically.

- 2 On the PC, click the check box of the desired file.

The mark appears on the left of the selected file.

To select other files, repeat this step.



- 3 Click [**Author and Burn**].

- 4 Click [**Burn to Disc**].

Authoring and burning starts.

Click [Stop] to cancel the procedure.



Continued on Next page

Other Windows® PC Operations (Continued)

5 Click [OK].

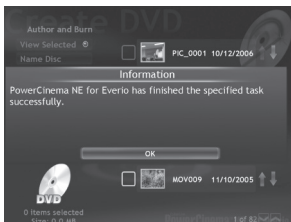

For more information on detailed operations of the software, see the Tutorials (pg. 57) or CyberLink web site (pg. 50).

NOTES

- You can use following discs:
 - DVD-R/DVD+R (Unused discs)
 - DVD-RW/DVD+RW (They need to be formatted before recording. Formatting deletes all content recorded on the disc.)
- DVD-RAM discs cannot be used.
- You may not be able to play back the created disc depending on the performance of the device. Also, the image may stop momentarily at junctions between scenes.
- The PC must be equipped with a compatible drive and player software to play back the created disc.

Getting More Use of the Software

For more information on operations of the software, see the Tutorials for each software program or the User's Guides.

PowerCinema NE for Everio

- 1 Double-click the PowerCinema NE for Everio icon.
Start PowerCinema NE for Everio.
- 2 Click [Tutorial].

PowerProducer 3 NE

- 1 Click [Start], go to [All Programs], select [CyberLink PowerProducer].
- 2 Click [PowerProducer User's Guide] or [Readme].

PowerDirector 5 NE Express

- 1 Click [Start], go to [All Programs], select [Cyber Link PowerDirector Express].
- 2 Click [PowerDirector Express User's Guide] or [Readme].

Digital Photo Navigator 1.5

The User's Guide is included on the CD-ROM in PDF format.

- 1 Load the provided CD-ROM into the PC.
- 2 Right-click the CD-ROM icon in [MY Computer], then click [Open].
- 3 Double-click the [DOCS] folder.
- 4 Open the "Start.pdf" file and click the button of the desired language.

NOTES

- You need to connect to the Internet to see the Tutorial.
- Adobe® Acrobat® Reader™ or Adobe® Reader® must be installed to read PDF files. Adobe® Reader® can be loaded from Adobe's web site: <http://www.adobe.com/>

File Backup on a Macintosh®

You can back up camera files onto your computer.

System Requirements

Hardware:

Macintosh must be standard equipped with USB 2.0 port

OS:

Mac OS X (v10.3.9, v10.4.2 to v10.4.10)

Connecting the Camera to the Macintosh

Preparation:

Close the LCD monitor to turn off the camera.

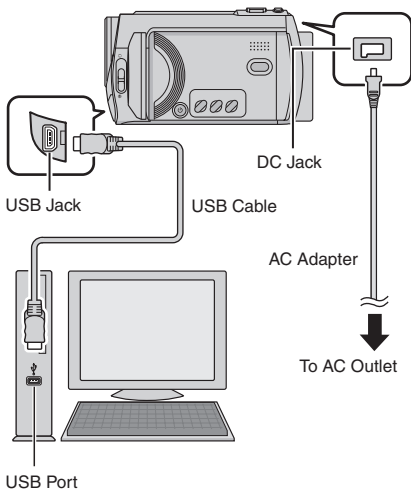

NOTES

- Never disconnect the USB cable while the access/charge lamp on the camera lights or blinks.
- Do not turn off the camera when the USB cable is connected, to prevent malfunctions of the PC.
- Connect the camera directly to the computer, not through a hub.
- Do not use an extension USB cable.

- When you copy files from the computer to the recording medium on the camera, do not include any other files than those recorded with the camera.
- Do not delete, move, or rename the files and folders in the camera from the computer.

■ When you have finished operation

Always follow the procedures below when disconnecting the camera, or turning the power of the camera/computer off. Failing to do so may cause damage to the camera and computer.

- 1) Drag & drop the recording medium icon on the desktop into the [Trash] icon. If the confirmation message appears, click [OK].
- 2) Confirm that the access/charge lamp on the camera does not light or blink. If the access/charge lamp lights or blinks, wait until it is turned off before proceeding.
- 3) Disconnect the USB cable.
- 4) Turn off the camera and computer.

File Backup on the Macintosh

Preparation:

Connect the camera to the computer with the USB cable. (☞ pg. 58)

- 1 On the computer, create a folder to back up files into.
- 2 Open the LCD monitor to turn on the camera.
- 3 On the camera, select [PLAYBACK ON PC].
- 4 Double-click [EVERIO_HDD] or [EVERIO_SD] icon.



- 5 Select the folder you want to back up, and drag & drop it into the folder you created in step 1.

• SD_VIDEO:

Folder that contains video files. If you want to back up files individually, open this folder, and drag & drop files such as [PRG001] one by one.

• DCIM:

Folder that contains still image files. If you want to back up files individually, open this folder, and drag & drop files such as [PIC_0001.JPG] one by one.

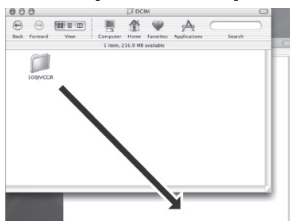

NOTE

For further details on the use of folders, see page 60.

Folder Structure and Extensions

Recording medium

X = number

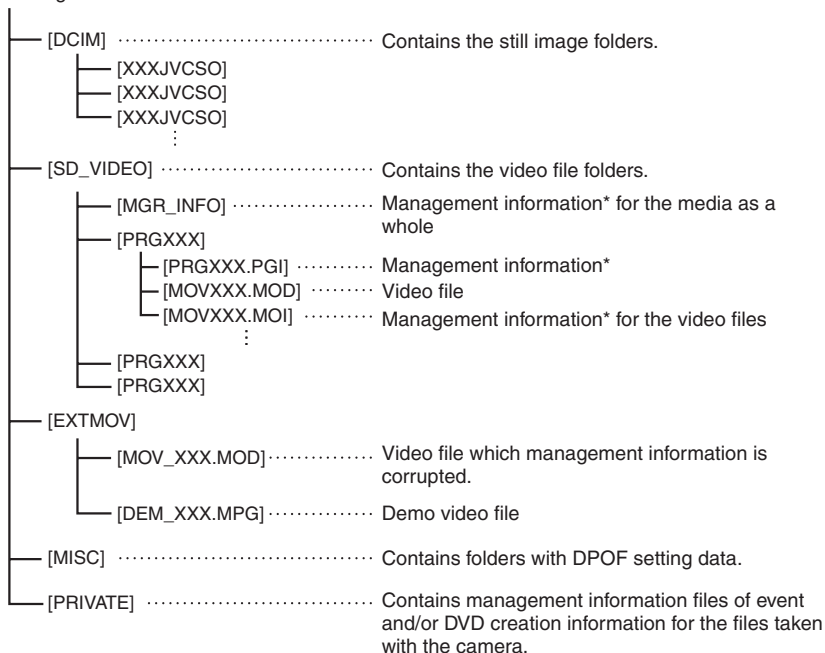

* Information such as the date and time of recording, recorded with the video file.

Extensions

Video files : “.MOD”

Still image files : “.jpg”

For Windows®, the file extension may not appear depending on the [FOLDER] option setting.

Customer Support Information

Contact us for Information on the Provided Software

Use of this software is authorized according to the terms of the software license.

JVC

When contacting the nearest JVC office or agency in your country (refer to the JVC Worldwide Service Network at <http://www.jvc-victor.co.jp/english/worldmap/index-e.html>) about this software, please have the following information ready.

- Product Name
- Model
- Problem
- Error Message
- PC Manufacturer
- Model (Desktop/Laptop)
- CPU
- OS
- Memory (MB)
- Available Hard Disk Space (GB)

Please note that it may take some time to respond to your questions, depending on their subject matter.

JVC cannot answer questions regarding basic operation of your PC, or questions regarding specifications or performance of the OS, other applications or drivers.

CyberLink

Telephone/fax support

Location	Language	Office hours (Mon. to Fri.)	Phone #	Fax #
Germany	English / German / French / Spanish / Italian	9:00 am to 5:00 pm	+49-700-462-92375	+49-241-70525-25
Taiwan	Mandarin	9:00 am to 6:00 pm	+886-2-8667-1298 ext. 333	+886-2-8667-1300
Japan	Japanese	10:00 am to 5:00 pm	+81-3-3516-9555	—

Paid voice support

Location	Language	Lines are open (Mon. to Fri.)	URL
U.S.A.	English	1:00 pm to 10:00 pm CST	http://www.cyberlink.com/english/cs/support/new_site/voice_support.jsp

Support web/e-mail

Language	URL/e-mail address
English	http://www.cyberlink.com/english/cs/support/new_site/support_index.html
German / French / Spanish / Italian	goCyberlink@aixtema.de
Japanese	http://jp.cyberlink.com/support/

Changing the Menu Settings

E.g.) Set [DROP DETECTION] to [OFF].

1 Touch the MENU button.

2 Select the desired menu.

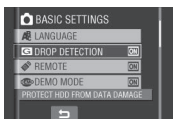





3 Select the desired setting.







For details on each menu, see below.















■ To return to the previous screen
Select .











■ To quit the screen
Touch the MENU button.

Menu	Settings: [] = Factory-preset
 SELF-TIMER Starts recording when the set time elapses after the SNAPSHOT button is pressed.	[OFF] / 2SEC / 10SEC NOTES <ul style="list-style-type: none"> • You can confirm the countdown on the camera screen. • You can also use this to prevent vibration by the hand.
 SHUTTER MODE	[RECORD ONE SHOT]: Records one still image at a time. CONTINUOUS SHOOTING: Records still images continuously while the SNAPSHOT button is pressed. NOTES <ul style="list-style-type: none"> • The interval between recording still images is approx. 0.3 seconds. • Continuous shooting may not work well depending on the recording medium. • The continuous shooting speed will drop if this function is used repeatedly.
 VIDEO QUALITY Enables you to set the picture quality for videos.	ULTRA FINE / [FINE] / NORMAL / ECONOMY
 IMAGE QUALITY Enables you to set the picture quality for still images.	[FINE] / STANDARD
 GAIN UP Makes the subject appear bright automatically when you record in dark places. However, the overall color tones appear grayish.	OFF: Disables the function. [ON]: Activates the function.



Menus	Settings: [] = Factory-preset
<p> SELECT ASPECT RATIO Enable you to select the aspect ratio for videos.</p>	<p>4:3: Records videos in 4:3 size. [16:9]: Records videos in 16:9 size. The 16:9 indicator lights up on the LCD monitor.</p> <p>NOTES</p> <ul style="list-style-type: none"> • If the [VIDEO QUALITY] is set to [ECONOMY], you cannot record in 16:9 size. • If you want to copy the recorded videos onto DVD discs, it is recommended not to mix 16:9 size videos and 4:3 size videos. • If you record videos in 16:9 size, the aspect ratio of the video may be incorrect when watching the videos on TV. If this occurs, change the settings in [SELECT TV TYPE]. (pg. 65)
<p> ZOOM Enables you to set the maximum zoom ratio.</p>	<p>35X / [70X] / 800X</p> <p>NOTE Optical zoom is used up to 35X. Digital zoom is used from more than 35X up to the selected zoom ratio.</p>
<p> DIS Compensates for hand shake.</p>	<p>OFF: Disables the function. [ON]: Activates the function.</p> <p>NOTES</p> <ul style="list-style-type: none"> • Accurate stabilization may not be possible if hand shake is excessive, or depending on the shooting conditions. • Set this mode to [OFF] when recording with the camera on a tripod.
<p> WIND CUT Reduces noise caused by wind.</p>	<p>[OFF]: Disables the function. ON: Activates the function.</p>
<p> SWITCH TO ANALOG I/O* Switches input and output for the AV/S-Video jack of the camera. * This does not apply to the GZ-MG330 model.</p>	<p>[OUTPUT]: Switches to output. I/O: Switches to input. The  indicator lights up on the LCD monitor.</p>
<p> MONITOR OFF*1 *2 Enables you to turn off the backlight on the monitor temporarily. *1 Playback mode only. *2 When [MONITOR OFF] in the playback menu is activated, use the remote control to play back files.</p>	<p>YES: Turn off the backlight. (no display) NO: Turn on the backlight.</p> <p>NOTE To turn on the backlight again, perform any operation such as zooming.</p>

Changing the Menu Settings (Continued)

Menus	Settings: [] = Factory-preset
BASIC SETTINGS	Select [BASIC SETTINGS], then select sub-menus.
 QUICK RESTART Enables the camera to start up quickly when you turn the power off and then on again within five minutes by closing and opening the LCD monitor. ("Power-linked operation"  pg. 12)	OFF: Disables the function. [ON]: Activates the function. NOTES <ul style="list-style-type: none"> • This function is not available during charging. • You can reset the setting by pressing and holding the power button. • Access/charge lamp blinks when this function is activated and the camera is turned off.
 MONITOR BRIGHT Enables you to set the brightness of the LCD monitor.	Adjust the brightness of the display by using the touch sensor.
 MONITOR BACKLIGHT Enables you to adjust the brightness of backlight on the monitor.	BRIGHTER / STANDARD / [AUTO] NOTE When you select [AUTO], the brightness will automatically be set to [BRIGHTER] when you use the camera outdoors and to [STANDARD] when you use the camera indoors.
 REC MEDIA FOR VIDEO Enables you to set the recording medium for videos.	[HDD] / SD
 REC MEDIA FOR IMAGE Enables you to set the recording medium for still images.	[HDD] / SD
 DATE DISPLAY STYLE Enables you to set the date and time display format.	DATE STYLE: year.month.day / [month.day.year] / day.month.year TIME: 24h / [12h]
 LANGUAGE Enables you to set the display language. ( pg. 17)	You have a choice of 7 languages. ( pg. 72) The default language is [ENGLISH].
 DROP DETECTION Prevents damage to the HDD by turning off the power automatically when the camera detects that it has been dropped.	OFF: Disables the function. [ON]: Activates the function. To turn the unit on when the drop detection worked, close the LCD monitor and open it again. NOTE Setting this function to off increases the risk of damaging the built-in hard disk if the camera is accidentally dropped.
 REMOTE Turns reception of the operation signal from the remote control on/off.	OFF: Disables operation with the remote control. [ON]: Enables operation with the remote control.
 DEMO MODE Introduces special features of the camera at the following cases. <ul style="list-style-type: none"> • When the menu screen is closed. • When there is no operation for about 3 minutes during recording mode. 	OFF: Disables the function. [ON]: Activates the function. NOTES <ul style="list-style-type: none"> • The demonstration only works when the DC cord is connected, not with the battery. • If a microSD card is in the camera, demonstration will not take place even if the power is on.

Menus	Settings: [] = Factory-preset
BASIC SETTINGS	Select [BASIC SETTINGS], then select sub-menus.
 OPERATION SOUND Turns the operation sound on/off.	OFF: Turns off the operation sound. [ON]: The melody sounds when any operation is performed.
 SELECT TV TYPE Enables you to select the TV type when watching files recorded on the camera on TV.	4:3 TV / [16:9 TV]
 AUTO POWER OFF If the camera is not operated for 5 minutes while the power is on, it turns itself off automatically to conserve power.	OFF: Disables the function. [ON]: Activates the function. To turn the camera on again, close the LCD monitor and open it again when using the battery pack. When using the AC adapter, perform any operation such as zooming.
 DISPLAY ON TV Displays the camera's on-screen display on TV.	[OFF]: Does not display on TV. ON: Displays on TV. NOTE This setting is available only if the TV is connected with the AV/S-Video cables. If connected with a DV cable, camera's on-screen display can not be displayed on TV.
 FACTORY PRESET Returns all the camera settings to their default values.	YES: Performs the function. NO: Cancels the function.
 CLOCK ADJUST Enables you to set the time. ( pg. 17)	DATE / TIME
 VIDEO NO. RESET  IMAGE NO. RESET By resetting the file number (name), a new folder will be made. The new files will be stored in the new folder. It is convenient to separate the new files from previously recorded files.	YES: Performs reset. NO: Cancels reset.
 FORMAT SD CARD You have to format newly purchased microSD cards with this camera before using them. This will also ensure stable speeds and operation when accessing the microSD card.	[FILE]: Initializes all files in the microSD card. FILE + MANAGEMNET NO: Initializes all files and management numbers in the microSD card.
 FORMAT HDD This will ensure stable speeds and operation when accessing the hard disk drive.	[FILE]: Initializes all files in the hard disk drive. FILE + MANAGEMNET NO: Initializes all files and management numbers in the hard disk drive.

Changing the Menu Settings (Continued)

Menus	Settings: [] = Factory-preset
BASIC SETTINGS	Select [BASIC SETTINGS], then select sub-menus.
 CLEAN-UP HDD Writing speed to HDD tends to become slow after long periods of repeated use. Execute cleanup periodically to regain the writing speed.	YES: Performs cleanup. NO: Cancels the function. NOTE Even if you select [YES], you can stop the process by selecting [STOP].
 DELETE DATA ON HDD This will make it more difficult to recover data on the HDD which has already been erased. It is recommended that you activate this function when disposing of the camera to prevent illegal data recovery (using commercially available software).	YES: Deletes data on HDD. NO: Cancels the function. NOTE Even if you select [YES], you can stop the process by selecting [STOP].

Troubleshooting

The camera is a microcomputer-controlled device. External noise and interference (from a TV, a radio, etc.) might prevent it from functioning properly.

The following phenomena are not malfunctions.

- The camera heats up when it is used for a long time.
- The battery heats up during charging.
- When playing back a video file, the image stops momentarily or the sound is interrupted at junctions between scenes.

- To solve the problem, first follow the instructions below.
- If the problem is not solved, reset the camera. (➤ below)
- If the problem persists, please consult your nearest JVC dealer.

■ To reset the camera

- 1) Close the LCD monitor to turn off the camera and remove the power supply (battery pack or AC adapter) from the camera, then reattach it.
- 2) Select [FACTORY PRESET] from the MENU. (➤ pg. 65)



Trouble		Action	➤
Power	No power is supplied.	<ul style="list-style-type: none"> ● Connect the AC adapter securely. ● Detach the battery pack once again and reattach it firmly. ● Replace the dead battery with a fully charged one. 	16 16 –
	No display appears.	<ul style="list-style-type: none"> ● If the camera is not operated for 5 minutes while the power is on, it turns itself off automatically to conserve power. To turn the camera on again when using the battery pack, close the LCD monitor and open it again. When using the AC adapter, perform any operation such as zooming. ● Adjust the brightness of the LCD monitor. 	– 64
	The power was turned off accidentally.	<ul style="list-style-type: none"> ● Move to a place where not affected by vibration or excessive sound. ● The drop detection function operated. Close the LCD monitor and open it again. To turn off this function, set [DROP DETECTION] to [OFF]. 	– 64
	The displayed amount of remaining battery power differs from the actual operating time.	<ul style="list-style-type: none"> ● Fully charge the battery, and then run it down. If the problem persists, the battery is worn out and needs to be replaced. Please purchase a new one. 	16
	The power does not turn on, or the battery operation time is extremely short even after the battery is fully charged.	<ul style="list-style-type: none"> ● Make sure to use the camera under appropriate operating temperatures. ● The battery is worn out and needs to be replaced. Please purchase a new one. 	72 –
	The access/charge lamp on the camera does not light during charging.	<ul style="list-style-type: none"> ● Charging may stop in places subject to extremely high/low temperatures to protect the battery. It is recommended to charge it in places with a temperature of 10°C to 35°C (50°F to 95°F). ● When the battery is already fully charged, the lamp does not light. Check the remaining battery power. 	– 18

Troubleshooting (Continued)

	Trouble	Action	
Displays	Images on the LCD monitor appear dark or whitish.	<ul style="list-style-type: none"> Adjust the brightness and angle of the LCD monitor. When the LED light reaches the end of its service life, images on the LCD monitor become dark. Consult your nearest JVC dealer. 	64 -
	Colored bright spots appear on the LCD monitor.	<ul style="list-style-type: none"> The LCD monitor is made with high precision technology. However, black spots or bright spots of light (red, green or blue) may appear constantly on the LCD monitor. These spots are not recorded on the picture. This is not due to any defect of the unit. (Effective dots: more than 99.99%) 	-
	Aspect ratio of the image is strange when watching images on TV. 	<ul style="list-style-type: none"> Change the settings in [SELECT TV TYPE] to match the aspect ratio of the image with the screen size of the connected TV. 	65
Recording	Recording cannot be performed.	<ul style="list-style-type: none"> Recording medium is full. Delete unnecessary files or replace the microSD card. Select the recording medium properly. 	32 64
	Vertical lines appear on recorded images.	<ul style="list-style-type: none"> Such a phenomenon occurs when shooting a subject illuminated by bright light. This is not a malfunction. 	-
	The LCD monitor becomes red or black for an instant.	<ul style="list-style-type: none"> Such a phenomenon occurs when shooting under direct sunlight. This is not a malfunction. 	-
	During recording, the date/time does not appear.	<ul style="list-style-type: none"> Touch the DISP button once. 	15
	During video recording, the ●REC indicator flashes.	<ul style="list-style-type: none"> The temperature of the camera is increasing. If the camera continues to heat up, recording may be stopped to protect the recording medium. In this case, turn off the power, and then wait until the camera cools down. 	-
	The LCD monitor indications blink.	<ul style="list-style-type: none"> Certain modes of program AE, effect, DIS and other functions that cannot be used together are selected at the same time. 	-
	Digital zoom does not work.	<ul style="list-style-type: none"> Change the settings in [ZOOM]. Digital zoom is not available in the still image recording mode. 	63 -
	The focus is not adjusted automatically.	<ul style="list-style-type: none"> Set [FOCUS] to [AUTO]. Clean the lens and check the focus again. 	25 71
	The color of the image looks strange.	<ul style="list-style-type: none"> Wait to become natural color. The camera adjusts the white balance automatically but it takes a time. Try manual white balance adjustment. In bright places, setting [PROGRAM AE] to [NIGHT] or a slow speed is not recommended. When the recorded image is too dark, try backlight compensation or adjust brightness. When the recorded image is too bright, try adjust brightness. 	- 26 - 24, 25 25

	Trouble	Action	
Recording	White balance setting cannot be activated.	<ul style="list-style-type: none"> Do not select the sepia (SEPIA) or monotone (MONOTONE) mode before setting white balance. 	26
	The continuous shooting speed is slow.	<ul style="list-style-type: none"> The continuous shooting speed will drop after repeated continuous shots, depending on the recording media, or under certain recording conditions. 	—
Playback	Playback cannot be performed.	<ul style="list-style-type: none"> Select the recording medium properly. To watch images on a TV, set the TV's input mode or channel that is appropriate for video playback. 	64 31
	The same image is displayed for a long time during video playback, or motion is choppy.	<ul style="list-style-type: none"> Replace the microSD card. (When the surface of the card is damaged, difficulty in reading the data occurs.) Perform clean up or format the microSD card. 	— 65
	The black & white fader does not work.	<ul style="list-style-type: none"> Do not select the sepia (SEPIA) or monotone (MONOTONE) mode before setting white balance. 	30
	There is a noise during playback.	<ul style="list-style-type: none"> The driving sound (hum) of the hard disk may have been recorded if the camera was moved suddenly during recording. Do not move or shake the camera suddenly during recording. 	—
	During video playback, the ► indicator flashes.	<ul style="list-style-type: none"> The temperature of the camera is increasing. If the camera continues to heat up, playback may be stopped to protect the recording medium. In this case, turn off the power, and then wait until the camera cools down. 	—
Other problems	Files cannot be deleted.	<ul style="list-style-type: none"> Remove protection from the files and delete them. 	32
	The data process is too slow after the power is switched on or the mode is changed.	<ul style="list-style-type: none"> There is a large number of still images (approx. 1,000 or more) stored in the recording medium. Copy the stored files to other devices, and delete them from the recording medium. 	32, 42
	The microSD card cannot be removed from the camera.	<ul style="list-style-type: none"> Push the microSD card in a few more times. 	19
	The [CREATE DVD] screen is displayed in the LCD monitor, and no other operations can be performed.	<ul style="list-style-type: none"> Another operation is being attempted while a DVD burner that is turned on is connected. Turn off the camera connected to the DVD burner, or disconnect the USB cable. 	—
	The touch sensor or sensor button does not function.	<ul style="list-style-type: none"> Touch the sensors with your finger. The sensors do not function if you touch them with your finger nail or with gloves on. 	6

Warning Indications

Indication	Meaning/Action	Page
 (Battery indicator)	<ul style="list-style-type: none"> Displays the remaining battery power.  <ul style="list-style-type: none"> As the battery power comes close to nil, the battery indicator blinks. When the battery power is exhausted, power turns off automatically. 	<p>–</p> <p>–</p>
SET DATE/TIME!	<ul style="list-style-type: none"> Appears when the date/time is not set. The built-in clock's rechargeable lithium battery is discharged, so the previously set date/time is erased. Connect the camera to an AC outlet using the AC adapter for over 24 hours to charge the clock's lithium battery. Then set the date/time. 	<p>17</p> <p>16</p>
CHECK LENS COVER	<ul style="list-style-type: none"> Appears for 5 seconds after power is turned on in recording mode if the lens cover is closed or when it is dark. 	<p>–</p>
HDD ERROR! MEMORY CARD ERROR!	<ul style="list-style-type: none"> Perform clean up to restore the capacity of the recording media. Turn off the camera. Remove the microSD card and insert it again. Turn on the camera after inserting the microSD card. If the error message appears again, replace the card with one that is certified to operate correctly. It is also recommended to run check disc regularly on the PC, providing that there is no data on the hard disk of the camera. 	<p>65</p> <p>65, 66</p> <p>–</p>
VIDEO MANAGEMENT FILE IS BROKEN. TO RECORD/PLAYBACK VIDEO, RECOVERY IS REQUIRED. RECOVER?	<ul style="list-style-type: none"> The video management file is broken. Recovery is required to record or play back video files. Select [YES], then touch the OK button to recover the video management file. 	<p>–</p>
RECORDING FAILURE	<ul style="list-style-type: none"> The writing speed of recording medium is slow, or the recording medium is corrupted. Use a microSD card that is guaranteed to operate correctly. The hard disk was subjected to vibrations or jolts. Be careful not to subject the hard disk to vibrations or jolts. Appears when the recording medium is full and recording is not possible. Delete unnecessary files, or replace the microSD card. 	<p>19</p> <p>–</p> <p>32</p>
POWER IS OFF, OR USB DEVICE IS UNSUPPORTED	<ul style="list-style-type: none"> Appears when an incompatible USB device is connected to the camera. Appears when a DVD burner that is switched off is connected. If you want to use the DVD burner, switch the power on. 	<p>–</p> <p>–</p>

Indication	Meaning/Action	
RECORDING MAY NOT BE CORRECT ON THE MEMORY CARD	<ul style="list-style-type: none"> ● Confirm the operation procedure and try recording again. ● Replace the microSD card. 	<p>—</p> <p>—</p>
DROP DETECTION WORKED AND THE POWER IS TURNED OFF	<ul style="list-style-type: none"> ● To turn on the camera again, close the LCD monitor and open it again. 	—

Cleaning

Before cleaning, turn off the camera and remove the battery pack and AC adapter.

■ To clean the exterior

Wipe gently with a soft cloth. If the camera is particularly dirty, dip the cloth into diluted mild soap and wring it out well before wiping. Then wipe again with a dry cloth.

■ To clean the LCD monitor

Wipe gently with a soft cloth. Be careful not to damage the monitor.

■ To clean the lens

Wipe gently with lens cleaning paper.

NOTES

- Avoid using strong cleaning agents such as benzine or alcohol.
- Mold may form if the lens is left dirty.
- When using a cleaner or chemically treated cloth, refer to the cautions for each product.

Specifications

Camera

■ For general

Power supply

DC 11 V (Using AC adapter)

DC 7.2 V (Using battery pack)

Power consumption

Approx. 2.7 W*

*When the LED light is off and the monitor backlight is set to [STANDARD] mode.

Dimensions (W x H x D)

113 mm x 68 mm x 54 mm
(4-1/2" x 2-11/16" x 2-3/16")

Weight

Approx. 315 g (0.69 lbs)
(incl. grip belt)

Approx. 360 g (0.79 lbs)
(incl. battery and grip belt)

Operating temperature

0°C to 40°C (32°F to 104°F)

Operating humidity

35% to 80%

Storage temperature

-20°C to 50°C (-4°F to 122°F)

Pickup

1/6" (680,000 pixels) CCD

Lens

F 1.8 to 4.0, f = 2.2 mm to 77 mm, 35:1 power zoom lens

Filter diameter

ø30.5 mm

LCD monitor

2.7" diagonally measured, LCD panel/TFT active matrix system

Speaker

Monaural

LED Light

Within 1.5 m (4.9 ft)
(recommended shooting distance)

Language

English/French/Spanish/Portuguese/
Japanese/Korean/Traditional Chinese

■ For video/Audio

Format

SD-VIDEO

Recording/Playback format

Video: MPEG-2

Audio: Dolby Digital (2 ch)

Signal format

NTSC standard

Recording mode (video)

ULTRA FINE: 720 x 480 pixels, 8.5 Mbps (VBR)

FINE: 720 x 480 pixels, 5.5 Mbps (VBR)

NORMAL: 720 x 480 pixels, 4.2 Mbps (VBR)

ECONOMY: 352 x 240 pixels, 1.5 Mbps (VBR)

Recording mode (audio)

ULTRA FINE: 48 kHz, 384 kbps

FINE: 48 kHz, 384 kbps

NORMAL: 48 kHz, 256 kbps

ECONOMY: 48 kHz, 128 kbps

■ For still image

Format

JPEG

Image size

1 mode (640 x 480)

Picture quality

2 modes (FINE/STANDARD)

■ For connectors

AV input/output*

Video input: 0.8 V (p-p) ~ 1.2 V (p-p), 75 Ω

Video output: 1.0 V (p-p), 75 Ω

Audio input: 300 mV (rms), 50 kΩ

Audio output: 300 mV (rms), 1 kΩ

* Only GZ-MG365/335

USB

Mini USB type A and type B, USB 2.0 compliant

AC Adapter

Power requirement

AC 110 V to 240 V~, 50 Hz/60 Hz

Output

DC 11 V  , 1 A

Remote Control

Power supply

DC 3 V

Battery life

Approx. 1 year (depending on the frequency of use)

Operating distance

Within 5 m (16.4 ft)

Operating temperature

0°C to 40°C (32°F to 104°F)

Dimensions (W x H x D)

42 mm x 14.5 mm x 91 mm

(1-11/16" x 5/8" x 3-5/8")

Weight

Approx. 30 g (0.07 lbs)

(incl. battery)

Design and specifications subject to change without notice.

Approximate recording time (minutes) (for video)

Quality \ Recording medium	HDD		microSD Card
	30 GB* ¹	60 GB* ²	4 GB
ULTRA FINE	430	860	57
FINE	640	1280	85
NORMAL	850	1700	113
ECONOMY	2250	4500	298

*¹ GZ-MG335/330

*² GZ-MG365

Approximate number of storable images (for still image)

Image size/Quality \ Recording medium	HDD		microSD Card				
	30 GB* ¹	60 GB* ²	256 MB	512 MB	1 GB	2 GB	4 GB
640 x 480 / FINE	9999	9999	1035	2060	4135	7680	9999
640 x 480 / STANDARD	9999	9999	2225	4440	8865	9999	9999

*¹ GZ-MG335/330

*² GZ-MG365

Required charging/recording time (approx.)

*When the LED light is off and the monitor backlight is set to [STANDARD] mode.

Battery pack	Charging time	Recording time
BN-VF808U (Provided)	1 hr. 30 min.	1 hr. 50 min.*
BN-VF815U	2 hr. 40 min.	3 hr. 40 min.*
BN-VF823U	3 hr. 50 min.	5 hr. 30 min.*

Cautions

AC Adapter

When using the AC adapter in areas other than the USA

The provided AC adapter features automatic voltage selection in the AC range from 110 V to 240 V.

USING HOUSEHOLD AC PLUG ADAPTER

In case of connecting the unit's power cord to an AC wall outlet other than American National Standard C73 series type use an AC plug adapter, called a "Siemens Plug", as shown.

For this AC plug adapter, consult your nearest JVC dealer.

Plug Adapter

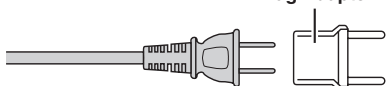

Battery Packs

The supplied battery pack is a lithium-ion battery. Before using the supplied battery pack or an optional battery pack, be sure to read the following cautions:

Terminals

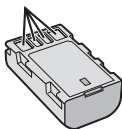

● To avoid hazards

- ... do not burn.
- ... do not short-circuit the terminals. Keep it away from metallic objects when not in use. When transporting, make sure the provided battery cap is attached to the battery. If the battery cap is misplaced, carry the battery in a plastic bag.
- ... do not modify or disassemble.
- ... do not expose the battery to temperatures exceeding 60°C (140°F), as this may cause the battery to overheat, explode or catch fire.
- ... use only specified chargers.

● To prevent damage and prolong service life

- ... do not subject to unnecessary shock.
- ... charge within the temperature range of 10°C to 35°C (50°F to 95°F). This is a chemical reaction type battery — cooler temperatures impede chemical reaction, while warmer temperatures can prevent complete charging.
- ... store in a cool, dry place. Extended exposure to high temperatures will increase natural discharge and shorten service life.
- ... fully charge and then fully discharge the battery every 6 months when storing the battery pack over a long period time.
- ... remove from charger or powered unit when not in use, as some machines use current even when switched off.

ATTENTION:



The product you have purchased is powered by a rechargeable battery that is recyclable. Please call 1-800-8-BATTERY for information on how to recycle this battery.

Recording Medium

- **Be sure to follow the guidelines below to prevent corruption or damage to your recorded data.**
 - Do not bend or drop the recording medium, or subject it to strong pressure, jolts or vibrations.
 - Do not splash the recording medium with water.
 - Do not use, replace, or store the recording medium in locations that are exposed to strong static electricity or electrical noise.
 - Do not turn off the camera power or remove the battery or AC adapter during shooting, playback, or when otherwise accessing the recording medium.
 - Do not bring the recording medium near objects that have a strong magnetic field or that emit strong electromagnetic waves.
 - Do not store the recording medium in locations with high temperature or high humidity.
 - Do not touch the metal parts.
- When formatting or erasing data using the camera, only the file administration information is changed. The data is not completely erased from the hard disk. If you want to completely erase all of the data, we recommend either using commercially available software that is specially designed for that purpose, or by physically destroying the camera with a hammer etc.

LCD Monitor

- **To prevent damage to the LCD monitor, DO NOT**
 - ... push it strongly or apply any shocks.
 - ... place the camera with LCD monitor on the bottom.
- **To prolong service life**
 - ... avoid rubbing it with coarse cloth.

Main Unit

● For safety, DO NOT

- ... open the camera's chassis.
- ... disassemble or modify the unit.
- ... allow inflammables, water or metal objects to enter the unit.
- ... remove the battery pack or disconnect the power supply while the power is on.
- ... leave the battery pack attached when the camera is not in use.
- ... place naked flame sources, such as lighted candles, on the apparatus.
- ... expose the apparatus to dripping or splashing.
- ... leave dust or metal objects adhered to the power plug or an AC wall outlet.
- ... insert any objects in the camera.

● Avoid using the unit

- ... in places subject to excessive humidity or dust.
- ... in places subject to soot or steam such as near a cooking stove.
- ... in places subject to excessive shock or vibration.
- ... near a television set.
- ... near appliances generating strong magnetic or electric fields (speakers, broadcasting antennas, etc.).
- ... in places subject to extremely high (over 40°C or 104°F) or extremely low (under 0°C or 32°F) temperatures.
- ... in places where the air pressure is low (more than 3000 m (9870 ft) above the sea level).

● DO NOT leave the unit

- ... in places of over 50°C (122°F).
- ... in places where humidity is extremely low (below 35%) or extremely high (above 80%).
- ... in direct sunlight.
- ... in a closed car in summer.
- ... near a heater.
- ... in high places such as on a TV. Leaving the unit in high places while a cable is connected may result in a malfunction if the cable is caught and the unit falls onto the floor.

● To protect the unit, DO NOT

- ... allow it to become wet.
- ... drop the unit or strike it against hard objects.
- ... subject it to shock or excessive vibration during transportation.
- ... keep the lens directed at extremely bright objects for long periods.
- ... expose the lens to direct sunlight.
- ... swing it excessively when using the hand strap.
- ... swing the soft camera case excessively when the camera is inside it.

● To prevent the unit from dropping,

- Attach the shoulder strap securely and fasten the grip belt securely.
- When using the camera with a tripod, attach the camera to the tripod securely.

If the camera drops, you may be injured and the camera may be damaged.

When a child uses the unit, there must be parental guidance.

Declaration of Conformity

Model Number: GZ-MG365U/GZ-MG335U/
GZ-MG330U

Trade Name: JVC

Responsible party: JVC AMERICAS CORP.

Address: 1700 Valley Road Wayne, N. J. 07470

Telephone Number: 973-317-5000

This device complies with Part 15 of FCC Rules. Operation is subject to the following two conditions: (1) This device may not cause harmful interference, and (2) this device must accept any interference received, including interference that may cause undesired operation.

Changes or modifications not approved by JVC could void the user's authority to operate the equipment. This equipment has been tested and found to comply with the limits for a Class B digital device, pursuant to Part 15 of the FCC Rules. These limits are designed to provide reasonable protection against harmful interference in a residential installation. This equipment generates, uses, and can radiate radio frequency energy and, if not installed and used in accordance with the instructions, may cause harmful interference to radio communications. However, there is no guarantee that interference will not occur in a particular installation. If this equipment does cause harmful interference to radio or television reception, which can be determined by turning the equipment off and on, the user is encouraged to try to correct the interference by one or more of the following measures: Reorient or relocate the receiving antenna. Increase the separation between the equipment and receiver.

Connect the equipment into an outlet on a circuit different from that to which the receiver is connected.

Consult the dealer or an experienced radio/TV technician for help.

This Class B digital apparatus complies with Canadian ICES-003.

Cet appareil numérique de la classe B est conforme à la norme NMB-003 du Canada.

Terms

A AC Adapter	16, 74	M Macintosh	58
Adjust Brightness	25	Manual Recording	24
Analog Input	63	Menu Settings	62
Auto Power Off	65	microSD Card	19
B Backlight Compensation	24	Monitor Backlight	64
Battery Pack	16, 18, 74	Monitor Off	63
C Clean-up HDD	66	O Operation Sound	65
Clock Adjust	17, 65	P Partial Delete	35
Copying (Moving) Still Images	48, 49, 58	Photometry Area	26
Copying Video Files	46, 49, 58	PictBridge	40
D Date Display Style	64	Picture Quality	62
Date Index Screen	28	Playlist	36
Deleting Files	32, 66	Power-Linked Operation	12
Deleting Playlist	38	Preset	65
Demonstration Mode	64	Printer	40
Digital Image Stabilizer (DIS)	63	Program AE	24
Direct Printing	40	Protecting Files	32
Display on TV	65	Q Quick Restart	64
DPOF	39	R Recordable Time/Number of Images	73
Drop Detection	64	Recording Medium	23, 64, 74
DVD Burner	42, 43	Remote Control	11, 12, 64
DVD Player	47	Resetting the Camera	67
DVD Recorder	46	Resetting the File Number	65
E Effect	26, 30	S Screen Size (16:9/4:3)	63
Event Registration	23, 34	Select TV Type	65
Event Screen	28	Self-Timer	62
Everio Dock	10	Shutter Speed	26, 62
F File Information	33	Slide Show	27
Focus	25	Speaker Volume	27
Formatting a Recording Medium	65	Still Image	21
G Gain Up	62	T Tele Macro	26
H Hard Disk	74	Tripod Mounting	18
I Image Rotation	27	TV	31
L Language Setting	17, 64	V VCR	46
LCD Monitor	12, 14, 74	Video	20
LED Light	22	W White Balance	26
Lens Cover	18	Wind Cut	63
		Windows PC	49
		Wipe or Fader Effects	30
		Z Zooming	22, 63

JVC