

# ***V400DA***

## ***USER'S MANUAL***

***M/B For Socket-A Athlon XP/Duron Processor***

***NO. G03-V400DA1A***

**Release date: December 2002**

**Trademark:**

- \* Specifications and Information contained in this documentation are furnished for information use only, and are subject to change at any time without notice, and should not be construed as a commitment by manufacturer.

# TABLE OF CONTENT

---

---

USER'S NOTICE .....	ii
MANUAL REVISION INFORMATION .....	1
COOLING SOLUTIONS .....	1
<b>CHAPTER 1 INTRODUCTION OF V400DA MOTHERBOARD</b>	
1-1 FEATURE OF MOTHERBOARD .....	2
1-2 SPECIFICATION .....	3
1-3 PERFORMANCE LIST.....	4
1-4 LAYOUT DIAGRAM & JUMPER SETTING .....	5
<b>CHAPTER 2 HARDWARE INSTALLATION</b>	
2-1 HARDWARE INSTALLATION STEPS.....	7
2-2 CHECKING MOTHERBOARD'S JUMPER SETTING.....	7
2-3 INSTALL CPU .....	9
2-3-1 GLOSSARY .....	9
2-3-2 ABOUT AMD ATHLON XP & DURON 462-PIN CPU .....	10
2-4 INSTALL MEMORY.....	11
2-5 EXPANSION CARD .....	12
2-5-1 PROCEDURE FOR EXPANSION CARD INSTALLATION .....	12
2-5-2 ASSIGNING IRQ FOR EXPANSION CARD.....	12
2-5-3 INTERRUPT REQUEST TABLE FOR THIS MOTHERBOARD.....	13
2-5-4 AGP SLOT .....	13
2-6 CONNECTORS, HEADERS.....	13
2-6-1 CONNECTORS .....	13
2-6-2 HEADERS.....	16
2-7 STARTING UP YOUR COMPUTER .....	19
<b>CHAPTER 3 INTRODUCING BIOS</b>	
3-1 ENTERING SETUP.....	20
3-2 GETTING HELP .....	20
3-3 THE MAIN MENU.....	21
3-4 STANDARD CMOS FEATURES.....	22
3-5 ADVANCED BIOS FEATURES .....	23
3-6 ADVANCED CHIPSET FEATURES .....	25
3-6-1 DRAM TIMING SETTINGS.....	26
3-6-2 AGP TIMING SETTINGS.....	27
3-6-3 PCI TIMING SETTINGS.....	27
3-7 INTEGRATED PERIPHERALS.....	28
3-7-1 ONCHIP IDE FUNCTION .....	28
3-7-2 ONCHIP DEVICE FUNCTION .....	29
3-7-3 ONCHIP SUPER IO FUNCTION .....	30

---



---

3-8	POWER MANAGEMENT SETUP.....	31
3-8-1	WAKE UP EVENTS.....	32
3-8-1.1	IRQS ACTIVITIES.....	33
3-9	PNP/PCI CONFIGURATION SETUP .....	33
3-9-1	IRQ RESOURCES .....	34
3-10	PC HEALTH STATUS.....	34
3-11	MISCELLANEOUS CONTROL.....	35
3-12	LOAD STANDARD/OPTIMIZED DEFAULTS .....	36
3-13	SET SUPERVISOR/USER PASSWORD .....	36

## CHAPTER 4 DRIVER & FREE PROGRAM INSTALLATION

MAGIC INSTALL SUPPORTS WINDOWS 9X/NT/2K/XP .....	37
4-1 VIA 4 IN 1     INSTALL VIA SERVICE PACK 4 IN 1 DRIVER.....	38
4-2 SOUND         INSTALL CMI AUDIO CODEC DRIVER .....	39
4-3 PC-HEALTH     WINBOND HARDWARE DOCTOR MONITORING SOFTWARE .....	41
4-3-1   HOW TO UTILIZE PC-HEALTH.....	41
4-4 MAGIC BIOS   INSTALL BIOS LIVE UPDATE UTILITY .....	42
4-5 PC-CILLIN     INSTALL PC-CILLIN2002 ANTI-VIRUS PROGRAM .....	43
4-6 USB 2.0       INSTALL VIA USB 2.0 DEVICE DRIVER .....	44
4-7 HOW TO DISABLE ON-BOARD SOUND .....	45
4-8 HOW TO UPDATE BIOS.....	45

## USER'S NOTICE

COPYRIGHT OF THIS MANUAL BELONGS TO **THE MANUFACTURER**. NO PART OF THIS MANUAL, INCLUDING THE PRODUCTS AND SOFTWARE DESCRIBED IN IT MAY BE REPRODUCED, TRANSMITTED OR TRANSLATED INTO ANY LANGUAGE IN ANY FORM OR BY ANY MEANS WITHOUT WRITTEN PERMISSION OF **THE MANUFACTURER**.

THIS MANUAL CONTAINS ALL INFORMATION REQUIRED TO USE V400DA MOTHER-BOARD AND WE DO ASSURE THIS MANUAL MEETS USER'S REQUIREMENT BUT WILL CHANGE, CORRECT ANY TIME WITHOUT NOTICE. **MANUFACTURER** PROVIDES THIS MANUAL "AS IS" WITHOUT WARRANTY OF ANY KIND, AND WILL NOT BE LIABLE FOR ANY INDIRECT, SPECIAL, INCIDENTAL OR CONSEQUENTIAL DAMAGES (INCLUDING DAMAGES FOR LOSS OF PROFIT, LOSS OF BUSINESS, LOSS OF USE OF DATA, INTERRUPTION OF BUSINESS AND THE LIKE).

PRODUCTS AND CORPORATE NAMES APPEARING IN THIS MANUAL MAY OR MAY NOT BE REGISTERED TRADEMARKS OR COPYRIGHTS OF THEIR RESPECTIVE COMPANIES, AND THEY ARE USED ONLY FOR IDENTIFICATION OR EXPLANATION AND TO THE OWNER'S BENEFIT, WITHOUT INTENT TO INFRINGE.

---

---

## Manual Revision Information

Reversion	Revision History	Date
1.0	First Release	December 2002

### Item Checklist

- V400DA Motherboard
- Cable for IDE/Floppy
- CD for motherboard utilities
- Cable for USB Port 3/4 (Option)
- V400DA User's Manual

## AMD Athlon™ XP / Duron™ Processor Family

### Cooling Solutions

As processor technology pushes to faster speeds and higher performance, thermal management becomes increasingly crucial when building computer systems. Maintaining the proper thermal environment is key to reliable, long-term system operation. The overall goal in providing the proper thermal environment is keeping the processor below its specified maximum case temperature. Heatsinks induce improved processor heat dissipation through increased surface area and concentrated airflow from attached fans. In addition, interface materials allow effective transfers of heat from the processor to the heatsink. For optimum heat transfer, AMD recommends the use of thermal grease and mounting clips to attach the heatsink to the processor.

When selecting a thermal solution for your system, please refer to the website below for collection of heatsinks evaluated and recommended by AMD for use with AMD processors. Note, those heatsinks are recommended for maintaining the specified Maximum T case requirement. In addition, this collection is not intended to be a comprehensive listing of all heatsinks that support AMD processors.

For vendor list of heatsink and fan, please visit :

<http://www1.amd.com/products/duron/thermals>

<http://www1.amd.com/products/athlon/thermals>

---

---

# Chapter 1

## Introduction of V400DA Motherboard

### 1-1 Feature of motherboard

The V400DA motherboard is design for use AMD Athlon/Duron/Athlon XP 200MHz/266MHz/333MHz (Double Data Rate) Front Side Bus Frequency CPU, which utilize the Socket-A design and the memory size expandable to 3.0GB.

V400DA motherboard use the newest VIA KT400 chipset, whose 333/266MHz (Double Data Rate) Front Side Bus frequency delivers a clear upgrade path to the future generation of 200/266/333MHz processors. The V400DA provided 266/333/400MHz memory frequency supported DDR266/DDR333 DDR SDRAM. The V400DA motherboard offers ULTRA ATA 133 to provide speedier HDD throughout that boosts overall system performance.

These motherboards also has an integrated AC'97 2.1 CODEC on board which is fully compatible with Sound Blaster Pro® that gives you the best sound quality and compatibility. It Supports 4 channel Speaker for 3D Surround Effect.

For those wanting even greater graphic performance, an AGP 8X slot is included on the board.

With USB control as well as capability of expanding to 6 USB function ports support USB2.0/USB1.1 Devices, the V400DA meet future USB demand also this motherboard has built-in hardware monitor function. This will monitor and protect your computer.

A special design in hardware for protecting Athlon XP CPU from burned, the system will auto shutdown power supply when CPU is overheat or the CPU FAN is stop.

***In V400DA we design in DDR memory 2.5V Voltage, AGP 1.5V Voltage those can minor adjustable in BIOS setup. This design can let users approach over clock demand and also can make system more stable.*** The V400DA motherboard provides special function in BIOS Setup to setting CPU Host clock step by step increasing let users to approach over clocking.

V400DA provides high performance & meets future specification demand. It is really wise choice for your computer.

---

---

## 1-2 Specification

<b>Spec</b>	<b>Description</b>
<b>Design</b>	* ATX form factor 4 layers PCB size: 30.5x21.0cm
<b>Chipset</b>	* VIA KT400 North Bridge Chipset for V400DA * VIA VT8235 South Bridge
<b>CPU Socket</b>	* Support AMD Athlon 700MHz~1.4GHz processor * Support AMD Duron 600MHz~1.3GHz processor * Support AMD Athlon XP1500+ ~ XP2700+ processor * Support 200MHz/266MHz/333MHz (Double Data Rate) Front Side Bus frequency processors * Reserves support for future AMD Athlon/Duron /Athlon XP processors
<b>Memory Socket</b>	* 184-pin DDR module socket x3 * Support DDR266/DDR333 DDR SDRAM * Expandable to 3.0GB
<b>Expansion Slot &amp; Headers</b>	* AGP slot x1 support AGP 3.0 & 4X mode * 32-bit PCI slot x5 * CNR slot x1
<b>Integrate IDE</b>	* Two PCI IDE controllers support PCI Bus Mastering, ATA PIO/DMA and the ULTRA DMA 33/66/100/133 functions that deliver the data transfer rate up to 133 MB/s
<b>Audio</b>	* AC'97 Digital Audio controller integrated * AC'97 Audio CODEC on board * Audio driver and utility included * Support 4 channel Speaker for 3D surround effect
<b>BIOS</b>	* Award 2MBit Flash ROM
<b>Multi I/O</b>	* PS/2 keyboard and PS/2 mouse connectors * Floppy disk drive connector x1 * Parallel port x1 * Serial port x2 * USB2.0 connector x2 * USB2.0 headers x2 (connecting cable option) * Audio connector (Line-in, Line-out , MIC & Game Port)

---

---

## 1-3 Performance List

The following performance data list is the testing result of some popular benchmark testing programs. These data are just referred by users, and there is no responsibility for different testing data values gotten by users (the different Hardware & Software configuration will result in different benchmark testing results.)

### Performance Test Report

**CPU:** AMD Athlon XP 2000+  
**DRAM:** 256MB DDR266 X1 (SAMSUNG DDR K4H280838B-TCB0)  
256MB DDR333 X1 (MICRON DDR MT46V16M8-6)  
**VGA Expansion Card:** NVIDIA Geforce 2 MX400 (1024x768 Hi-color)  
**Hard Disk Driver:** IBM DTLA-305040 (ATA-100)  
**BIOS:** Award Optimal default  
**OS:** Win 98SE

	<b>DDR266</b>	<b>DDR333</b>
<b>3D Mark 2000</b>	5678	5687
<b>3D Mark 2001</b>	2554	2550
<b>3D Winbench 2000</b>	105	105
<b>Final Reality</b>	10.34	10.39
<b>Content Creation Winstone 2000</b>	50	50.3
<b>Content Creation Winstone 2001</b>	63.6	64.5
<b>Content Creation Winstone 2002</b>	23.6	23.9
<b>Business Winstone2001</b>	53.9	53.7
<b>Winbench 99:</b>		
CPU Mark 99	152	151
FPU Winmark 99	9140	9140
Business Disk Winmark99	7440	7690
Hi-end Disk Winmark99	19600	19400
Business Graphic Winmark	794	790
Hi-end Graphic Winmark	2390	2400
<b>SYS Mark 2000/2001 : SISMark 2000/2001 Rating (Internet Content Creation / Office Productivity)</b>		
SISMark 2000	282 (298/270)	285 (302/272)
SISMark 2001	166 (178/154)	171 (180/163)
<b>SISOFT Sandra 2001 :</b>		
Dhrystone ALU MIPS	4640	4657
Whetstone FPU MFLOPS	2280	2303
Int ALU/RAM MB/S	761	827
Float FPU/RAM MB/S	804	892
Integer SSE2 IT/S	9320	9302
Floating- Point SSE2 MB/S	10706	10780
QUAKE3 DEMO1 FPS	178.9	185.2
DEMO2 FPS	186.5	191.9
WCPUID System/CPU Clock	133.79/1672.32	133.79/1672.32

## 1-4 Layout Diagram & Jumper Setting

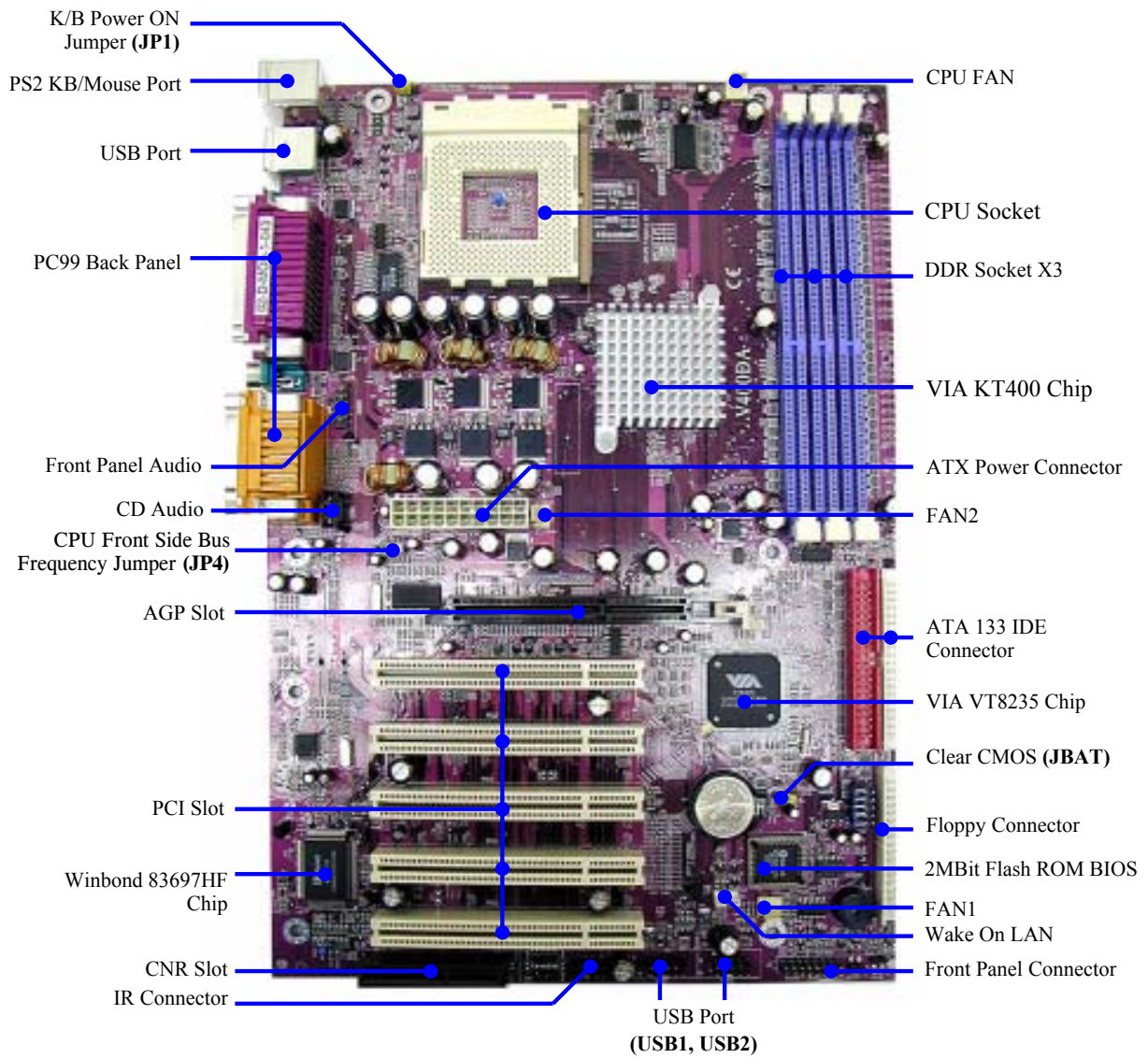
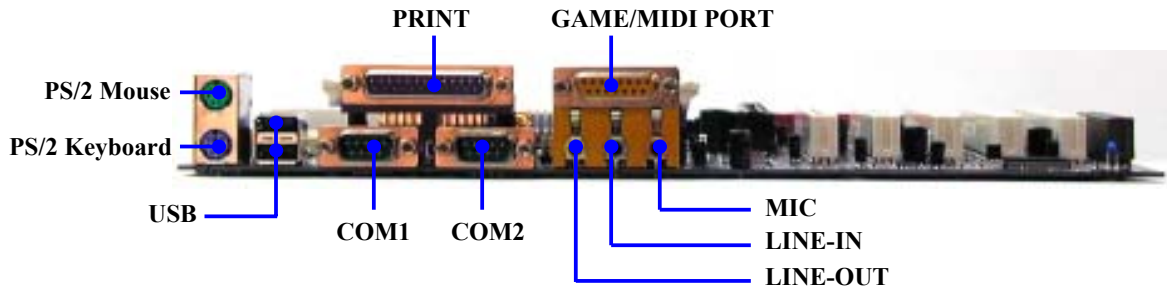



---

---

## *Jumpers*

<b>Jumper</b>	<b>Name</b>	<b>Description</b>	<b>Page</b>
JP4	CPU Front Side Bus Frequency	4-pin Block	P.7
JBAT	CMOS RAM Clear	3-pin Block	P.7
JP1	Keyboard Power On Enable/Disabled	3-pin Block	P.8

## *Connectors*

<b>Connector</b>	<b>Name</b>	<b>Description</b>	<b>Page</b>
ATXPOW	ATX Power Connector	20-pin Block	P.13
J2	PS/2 Mouse & PS/2 Keyboard Connector	6-pin Female	P.14
J3	USB Port Connector	4-pin Connector	P.14
PARALLEL	Parallel Port Connector	25-pin Female	P.14
AUD_GAME	Audio/Game Connector	3 phone jack + 15-pin Connector	P.14
COM1/COM2	Serial Port COM1/2 Connector	9-pin Connector	P.14
FDD	Floppy Driver Connector	34-pin Block	P.14
IDE1	Primary IDE Connector	40-pin Block	P.15
IDE2	Secondary IDE Connector	40-pin Block	P.15

## *Headers*

<b>Header</b>	<b>Name</b>	<b>Description</b>	<b>Page</b>
AUDIO	Line-In/Out, MIC header	10-pin Block	P.16
USB1/USB2	USB Port Headers	9-pin Block	P.16
IDE LED	IDE activity LED	2-pin Block	P.16
TB LED	Turbo LED switch	2-pin Block	P.16
RESET	Reset switch lead	2-pin Block	P.17
SPEAKER	Speaker connector	4-pin Block	P.17
PWR LED	Power LED	2-pin Block	P.17
PW BN	Power switch	2-pin Block	P.17
WOL	Wake On-LAN Headers	3-pin Block	P.17
FAN1,FAN2,CPUFAN	FAN Headers	3-pin Block	P.18
IR	IR infrared module Headers	5-pin Block	P.18
CDIN1	CD Audio-In Headers	4-pin Block	P.18

## *Expansion Sockets*

<b>Socket/Slot</b>	<b>Name</b>	<b>Description</b>	<b>Page</b>
ZIF Socket 462	CPU Socket	462-pin PPGA CPU Socket	P.10
DDR1, DDR2, DDR3	DDR SDRAM Module Socket	184-pin DDR SDRAM Module Expansion Socket	P.11
PCI1, PCI2, PCI3, PCI4, PCI5	PCI Slot	32-bit PCI Local Bus Expansion slots	P.12
AGP	AGP 8X Mode Slot	AGP Expansion Slot	P.13

---

---

## Chapter 2

### Hardware installation

#### 2-1 Hardware installation Steps

Before using your computer, you had better complete the following steps:

1. Check motherboard setting
2. Install CPU
3. Install Memory
4. Install Expansion cards
5. Connect Ribbon cables, Panel wires, and power supply
6. Setup BIOS
7. Install software driver & utility

#### 2-2 Checking Motherboard's Jumper Setting

##### (1) CPU Front Side Bus Frequency Setting (4-pin) : JP4

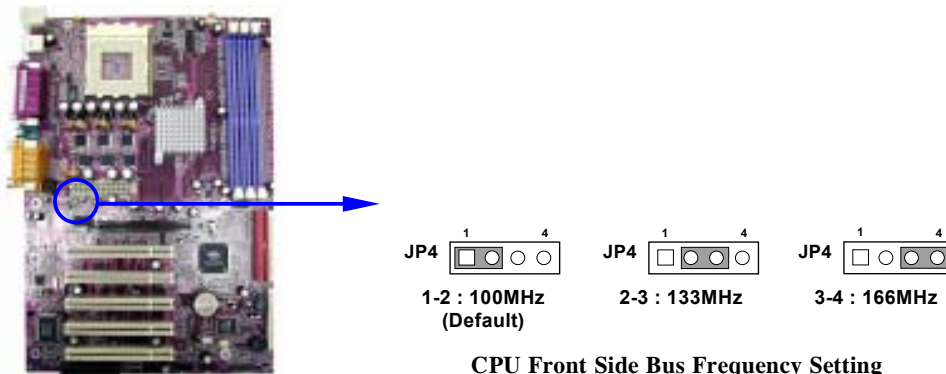

*Note: CPU Front Side Bus Frequency also can setting step by step in BIOS SETUP, please refer page 35 Miscellaneous Control in Host Clock at Next.*

##### (2) CMOS RAM Clear (3-pin) : JBAT

A battery must be used to retain the motherboard configuration in CMOS RAM short 1-2 pins of JBAT to store the CMOS data.

To clear the CMOS, follow the procedure below:

1. Turn off the system and unplug the AC power
2. Remove ATX power cable from ATX power connector
3. Locate JBAT and short pins 2-3 for a few seconds
4. Return JBAT to its normal setting by shorting pins 1-2
5. Connect ATX power cable back to ATX power connector

---

---

**Note: When should clear CMOS**

1. **Troubleshooting**
2. **Forget password**
3. **After over clocking system boot fail**

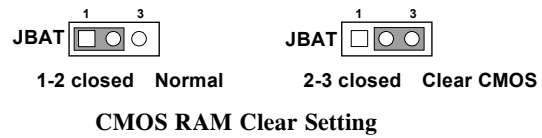

**(3) Keyboard Power On function Enabled/Disabled: JP1**

When setting Enabled you can using keyboard by key in password to power on system.

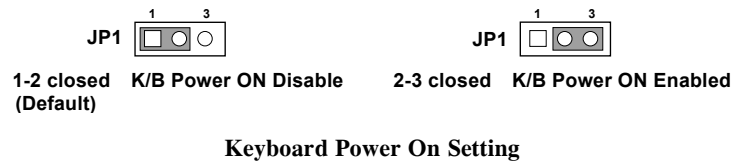

---

---

## 2-3 Install CPU

### 2-3-1 Glossary

**Chipset (or core logic)** - two or more integrated circuits which control the interfaces between the system processor, RAM, I/O devices, and adapter cards.

**Processor socket** - the socket used to mount the system processor on the motherboard.

**Slot** (AGP, PCI, ISA, RAM) - the slots used to mount adapter cards and system RAM.

**AGP** - **Accelerated Graphics Port** - a high speed interface for video cards; runs at 1X (66MHz), 2X (133MHz), 4X (266MHz), 8X (533MHz).

**PCI** - **Peripheral Component Interconnect** - a high speed interface for video cards, sound cards, network interface cards, and modems; runs at 33MHz.

**ISA** - **Industry Standard Architecture** - a relatively low speed interface primarily used for sound cards and modems; runs at approx. 8MHz.

**Serial Port** - a low speed interface typically used for mouse and external modems.

**Parallel Port** - a low speed interface typically used for printers.

**PS/2** - a low speed interface used for mouse and keyboards.

**USB** - **Universal Serial Bus** - a medium speed interface typically used for mouse, keyboards, scanners, and some digital cameras.

**Sound** (interface) - the interface between the sound card or integrated sound connectors and speakers, MIC, game controllers, and MIDI sound devices.

**LAN** (interface) - **Local Area Network** - the interface to your local area network.

**BIOS** (**Basic Input/Output System**) - the program logic used to boot up a computer and establish the relationship between the various components.

**Driver** - software, which defines the characteristics of a device for use by another device or other software.

**Processor** - the "central processing unit" (CPU); the principal integrated circuit used for doing the "computing" in "personal computer"

**Front Side Bus Frequency** - the working frequency of the motherboard, which is generated by the clock generator for CPU, DRAM and PCI BUS.

**CPU L2 Cache** - the flash memory inside the CPU, normally Athlon serial CPU has 256K or above, while Duron will have 64K.

---

---

## 2-3-2 About AMD Athlon XP & Duron 462-pin CPU

This motherboard supports Socket-A (Socket-462) AMD Athlon XP /Duron processors.

This motherboard Provides a ZIF Socket-A. The CPU that comes with the motherboard should have a cooling FAN attached to prevent overheating. If this is not the case, then purchase a correct cooling FAN before you turn on your system.

**WARNING!** Be sure that there is sufficient air circulation across the processor's heatsink and CPU cooling FAN is working correctly, otherwise it may cause the processor and motherboard overheat and damage, you may install an auxiliary cooling FAN, if necessary.

**WARNING!** Due to this motherboard provides new function of protecting CPU ; you must connect the CPU FAN connector on FAN1 location in order to obtain this feature. Without connection on FAN1 (or you have connect CPU FAN on FAN2), the system will shut down immediately to protect both your CPU and motherboard.

**Over heat Protect:** Only for Athlon XP serial CPU, when the CPU overheat, system will auto shut down power supply. You can hear a continue beep sound, the power button will be locked up. Users must turn off and turn on the AC power to reset the system otherwise the power button will no function, the other way is keeping press the push button few seconds till the beep sound stop, then release the power button and press the power button again to turn on the power supply.

To install a CPU, first turn off your system and remove its cover. Locate the ZIF socket and open it by first pulling the level sideways away from the socket then upward to a 90-degree angle. Insert the CPU with the correct orientation as shown below. The notched corner should point toward the end of the level. Because the CPU has a corner pin for two of the four corners, the CPU will only fit in the orientation as shown.

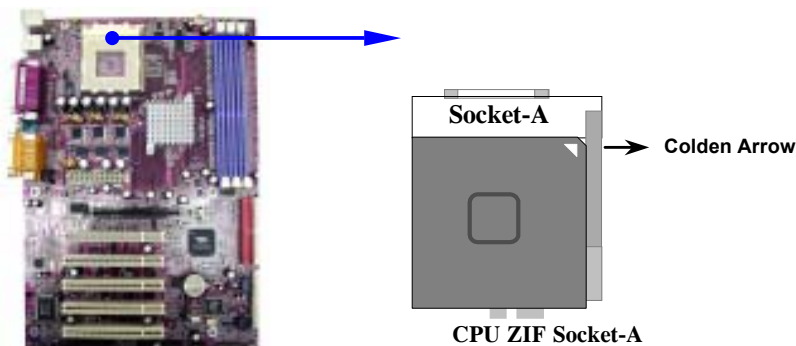

When you put the CPU into the ZIF socket. No force require to insert of the CPU, then press the level to Locate position slightly without any extra force.

---

---

## 2-4 Install Memory

This motherboard provides three 184-pin DUAL INLINE MEMORY MODULES (DIMM) sites for memory expansion available from minimum memory size of 64MB to maximum memory size of 3.0GB DDR SDRAM.

### Valid Memory Configurations

Bank	184-Pin DIMM	PCS	Total Memory
Bank 0, 1 (DDR1)	PC2100/PC2700 DDR SDRAM	X1	64MB~1.0GB
Bank 2, 3 (DDR2)	PC2100/PC2700 DDR SDRAM	X1	64MB~1.0GB
Bank 4, 5 (DDR3)	PC2100/PC2700 DDR SDRAM	X1	64MB~1.0GB
Total	System Memory (Max. 3.0GB)	3	64MB~3.0GB

**NOTE!** Make sure the total installed memory does not exceeds 3.0GB, otherwise the system may hang during startup.

Generally, installing DDR SDRAM modules to your motherboard is very easy, you can refer to figure 2-4 to see what a 184-Pin PC2100/PC2700 DDR SDRAM module looks like.

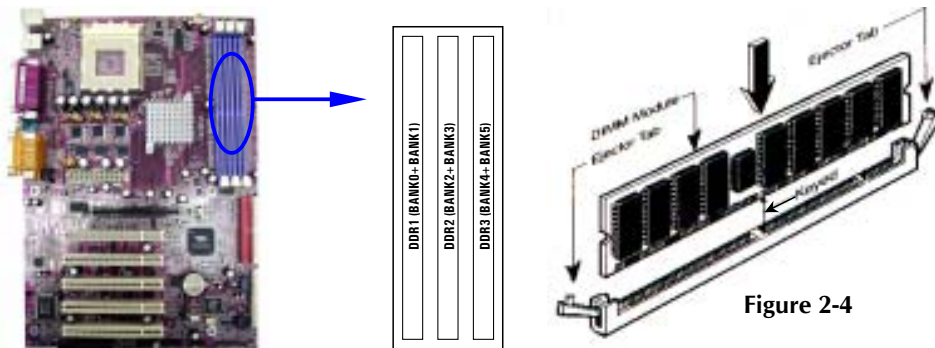

**NOTE!** When you install DIMM module fully into the DIMM socket the eject tab should be locked into the DIMM module very firmly and fit into its indentation on both sides.

**WARNING!** For the DDR SDRAM CLOCK is set at 166MHz, use only PC2700-compliant DDR Modules. When this motherboard operate at 133Mhz, most system will not even boot if non-compliant modules are used because of the strict timing issues, if your DDR Modules are not PC2100-compliant, set the DDR SDRAM clock to 100MHz to ensure system stability.

---

---

## 2-5 Expansion Cards

**WARNING!** Turn off your power when adding or removing expansion cards or other system components. Failure to do so may cause severe damage to both your motherboard and expansion cards.

### 2-5-1 Procedure For Expansion Card Installation

1. Read the documentation for your expansion card and make any necessary hardware or software setting for your expansion card such as jumpers.
2. Remove your computer's cover and the bracket plate on the slot you intend to use.
3. Align the card's connectors and press firmly.
4. Secure the card on the slot with the screen you remove above.
5. Replace the computer system's cover.
6. Set up the BIOS if necessary.
7. Install the necessary software driver for your expansion card.

### 2-5-2 Assigning IRQs For Expansion Card

Some expansion cards need an IRQ to operate. Generally, an IRQ must exclusively assign to one use. In a standard design, there are 16 IRQs available but most of them are already in use.

#### Standard Interrupt Assignments

IRQ	Priority	Standard function
0	N/A	System Timer
1	N/A	Keyboard Controller
2	N/A	Programmable Interrupt
3 *	8	Communications Port (COM2)
4 *	9	Communications Port (COM1)
5 *	6	Sound Card (sometimes LPT2)
6 *	11	Floppy Disk Controller
7 *	7	Printer Port (LPT1)
8	N/A	System CMOS/Real Time Clock
9 *	10	ACPI Mode when enabled
10 *	3	IRQ Holder for PCI Steering
11 *	2	IRQ Holder for PCI Steering
12 *	4	PS/2 Compatible Mouse Port
13	N/A	Numeric Data Processor
14 *	5	Primary IDE Channel
15 *	1	Secondary IDE Channel

\* These IRQs are usually available for ISA or PCI devices.

---

---

### 2-5-3 Interrupt Request Table For This Motherboard

Interrupt request are shared as shown the table below:

	INT A	INT B	INT C	INT D
PCI slot 1	Shared	—	—	—
PCI slot 2	—	Shared	—	—
PCI slot 3	—	—	Shared	—
PCI slot 4	—	—	—	Shared
PCI slot 5	Shared	—	—	—
AGP slot	Shared	—	—	—
AC97/MC97	—	—	Shared	—
Onboard USB	—	—	—	Shared
Onboard USB 1	—	—	—	Shared
Onboard USB 2	—	—	—	Shared

**IMPORTANT!** If using PCI cards on shared slots, make sure that the drivers support “Shared IRQ” or that the cards don’t need IRQ assignments. Conflicts will arise between the two PCI groups that will make the system unstable or cards inoperable.

### 2-5-4 AGP Slot

This motherboard provides an AGP Slot, support the 1X/2X/4X/8X AGP VGA card.

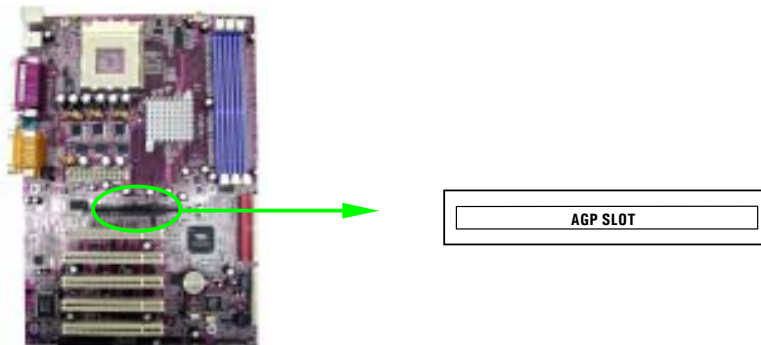

## 2-6 Connectors, Headers

### 2-6-1 Connectors

(1) **Power Connector (20-pin block) : ATXPOW**

ATX Power Supply connector. This is a new defined 20-pins connector that usually comes with ATX case. The ATX Power Supply allows to use soft power on momentary switch that connect from the front panel switch to 2-pins Power On jumper pole on the motherboard. When the power switch on the back of the ATX power supply turned on, the full power will not come into the system board until the front panel switch is momentarily pressed. Press this switch again will turn off the power to the system board.



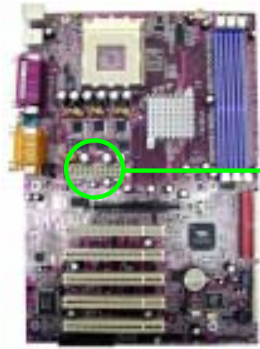

PIN	ROW2	ROW1
1	3.3V	3.3V
2	-12V	3.3V
3	GND	GND
4	Soft Power On	5V
5	GND	GND
6	GND	5V
7	GND	GND
8	-5V	Power OK
9	+5V	+5V (for Soft Logic)
10	+5V	+12V

↑  
Pin 1

(2) **PS/2 Mouse & PS/2 Keyboard Connector: J2**

The connectors for PS/2 keyboard and PS/2 Mouse.

(3) **USB Port connector: J3**

The connectors are 4-pin connector that connect USB devices to the system board.

(4) **Parallel Port Connector (25-pin female): PARALLEL**

Parallel Port connector is a 25-pin D-Subminiature Receptacle connector. The On-board Parallel Port can be disabled through the BIOS SETUP. Please refer to Chapter 3 “INTEGRATED PERIPHERALS SETUP” section for more detail information.

(5) **Audio and Game Connector : AUD\_GAME**

This Connector are 3 phone Jack for LINE-OUT, LINE-IN, MIC and a 15-pin D-Subminiature Receptacle Connector for joystick/MIDI Device.

**Line-out :** Audio output to speaker

**Line-in :** Audio input to sound chip

**MIC :** Microphone Connector

**Game/MIDI :** For joystick or MIDI Device

(6) **Serial Port COM1, COM2 : COM1, COM2**

COM1, COM2 are the 9-pin D-Subminiature mail connector. The On-board serial port can be disabled through BIOS SETUP. Please refer to Chapter 3 “INTEGRATED PERIPHERALS SETUP” section for more detail information.

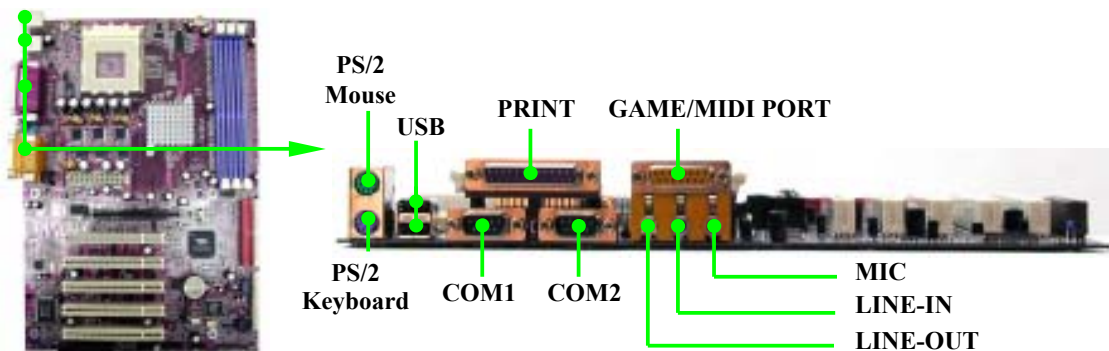

(7) **Floppy drive Connector (34-pin block): FDD**

This connector supports the provided floppy drive ribbon cable. After connecting the single plug end to motherboard, connect the two plugs at other end to the floppy drives.

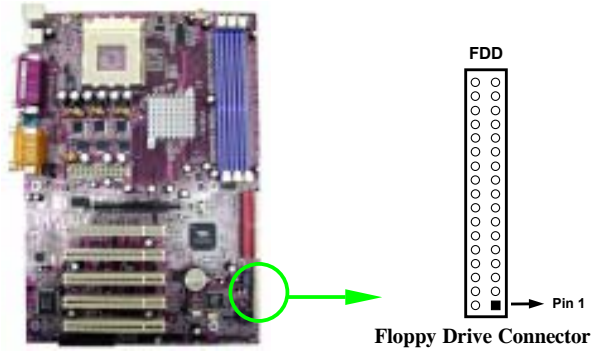

**(8) Primary IDE Connector (40-pin block): IDE1**

This connector supports the provided IDE hard disk ribbon cable. After connecting the single plug end to motherboard, connect the two plugs at other end to your hard disk(s). If you install two hard disks, you must configure the second drive to Slave mode by setting its jumpers accordingly. Please refer to the documentation of your hard disk for the jumper settings.

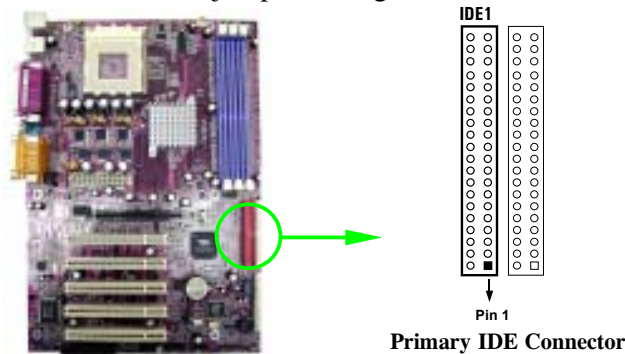

**(9) Secondary IDE Connector (40-pin block): IDE2**

This connector connects to the next set of Master and Slave hard disks. Follow the same procedure described for the primary IDE connector. You may also configure two hard disks to be both Masters using one ribbon cable on the primary IDE connector and another ribbon cable on the secondary IDE connector.

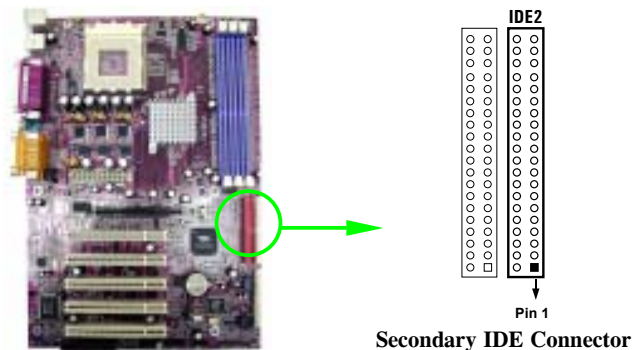

- Two hard disks can be connected to each connector. The first HDD is referred to as the “Master” and the second HDD is referred to as the “Slave”.
- For performance issues, we strongly suggest you don’t install a CD-ROM or DVD-ROM drive on the same IDE channel as a hard disk. Otherwise, the system performance on this channel may drop.

---

---

## 2-6-2 Headers

### (1) Line-In/Out, MIC Header (10-pin): AUDIO

This header connect to Front Panel Line-In, Line-out, MIC connector with cable.

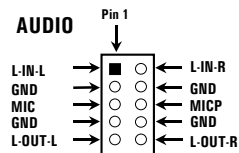

Line-In/Out, MIC Headers

### (2) USB Port Headers (9-pin) : USB1, USB2

These headers are used for connecting the additional USB port plug. By attaching an option USB cable, your can be provided with two additional USB plugs affixed to the back panel.

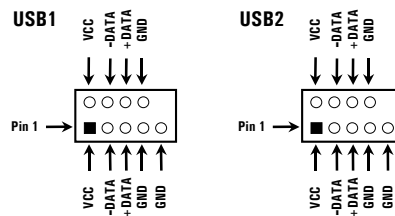

USB Port Connector

### (3) IDE Activity LED: IDE LED

This connector connects to the hard disk activity indicator light on the case.

### (4) Turbo LED switch: TB LED

Since the motherboard's turbo function is always on. The turbo LED will remain constantly on while the system power is on. You may wish to connect the Power LED from the system case to this lead. See the figure below.

### (5) Reset switch lead: RESET

This 2-pin connector connects to the case-mounted reset switch for rebooting your computer without having to turn off your power switch. This is a preferred method of rebooting in order to prolong the life of the system's power supply. See the figure below.

### (6) Speaker connector: SPEAKER

This 4-pin connector connects to the case-mounted speaker. See the figure below.

### (7) Power LED: PWR LED

The Power LED is light on while the system power is on. Connect the Power LED from the system case to this pin.

**(8) Power switch: PW BN**

This 2-pin connector connects to the case-mounted power switch to power ON/OFF the system.

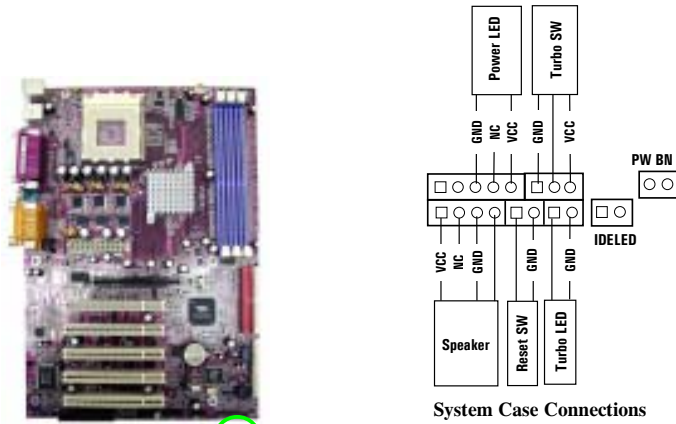

**(9) Wake On-LAN Headers (3-pin) : WOL**

This connector connects to a LAN card with a WAKE ON-LAN output. This connector power up the system when a wake up signal is received through the LAN card.

**NOTE:** This feature requires that Wake On LAN or Ring In Wake up is enabled.

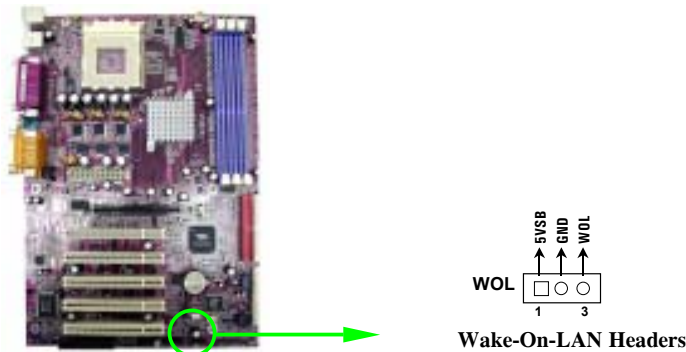

**(10) FAN Speed Headers (3-pin) : FAN1, FAN2, CPUFAN**

These connectors support cooling fans of 350mA (4.2 Watts) or less, depending on the fan manufacturer, the wire and plug may be different. The red wire should be positive, while the black should be ground. Connect the fan's plug to the board taking into consideration the polarity of connector.

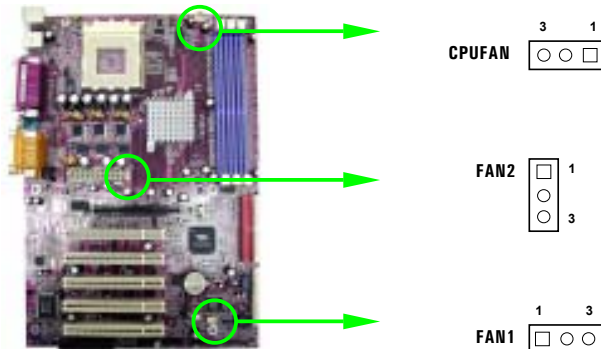

---

---

**(11) IR infrared module Headers (9-pin) : IR**

This connector supports the optional wireless transmitting and receiving infrared module. You must configure the setting through the BIOS setup to use the IR function.

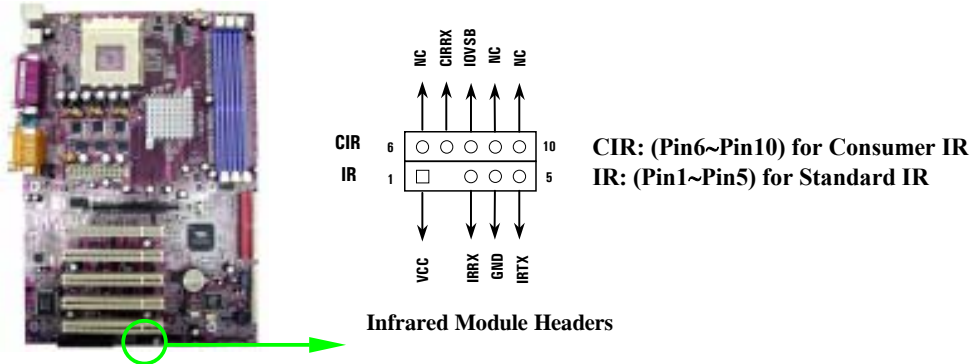

**(12) CD Audio-In Headers (4-pin) : CDIN1**

CDIN1 is the connector for CD-Audio Input signal. Please connect it to CD-ROM CD-Audio output connector.

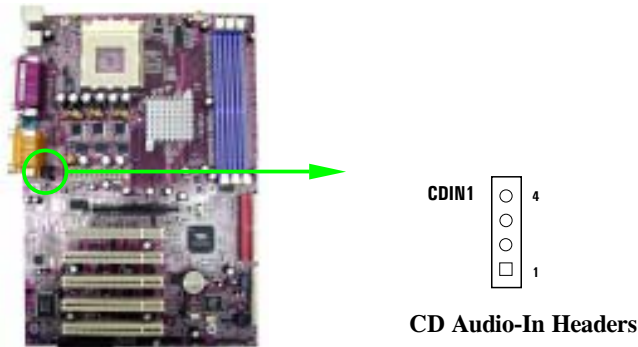

---

---

## 2-7 Starting Up Your Computer

1. After all connection are made, close your computer case cover.
2. Be sure all the switch are off, and check that the power supply input voltage is set to proper position, usually in-put voltage is 220V~240V or 110V~120V depending on your country's voltage used.
3. Connect the power supply cord into the power supply located on the back of your system case according to your system user's manual.
4. Turn on your peripheral as following order:
  - a. Your monitor.
  - b. Other external peripheral (Printer, Scanner, External Modem etc...)
  - c. Your system power. For ATX power supplies, you need to turn on the power supply and press the ATX power switch on the front side of the case.
5. The power LED on the front panel of the system case will light. The LED on the monitor may light up or switch between orange and green after the system is on. If it complies with green standards or if it is has a power standby feature. The system will then run power-on test. While the test are running, the BIOS will alarm beeps or additional message will appear on the screen.

If you do not see any thing within 30 seconds from the time you turn on the power. The system may have failed on power-on test. Recheck your jumper settings and connections or call your retailer for assistance.

Beep	Meaning
One short beep when displaying logo	No error during POST
Long beeps in an endless loop	No DRAM install or detected
One long beep followed by three short beeps	Video card not found or video card memory bad
High frequency beeps when system is working	CPU overheated System running at a lower frequency

6. During power-on, press <Delete> key to enter BIOS setup. Follow the instructions in BIOS SETUP.
7. **Power off your computer:** You must first exit or shut down your operating system before switch off the power switch. For ATX power supply, you can press ATX power switching after exiting or shutting down your operating system. If you use Windows 9X, click "Start" button, click "Shut down" and then click "Shut down the computer?" The power supply should turn off after windows shut down.

---

---

## Chapter 3

### Introducing BIOS

The BIOS is a program located on a Flash Memory on the motherboard. This program is a bridge between motherboard and operating system. When you start the computer, the BIOS program gain control. The BIOS first operates an auto-diagnostic test called POST (power on self test) for all the necessary hardware, it detects the entire hardware device and configures the parameters of the hardware synchronization. Only when these tasks are completed done it gives up control of the computer to operating system (OS). Since the BIOS is the only channel for hardware and software to communicate, it is the key factor for system stability, and in ensuring that your system performance as its best.

In the BIOS Setup main menu of Figure 3-1, you can see several options. We will explain these options step by step in the following pages of this chapter, but let us first see a short description of the function keys you may use here:

- Press <Esc> to quit the BIOS Setup.
- Press ↑↓←→ (up, down, left, right) to choose, in the main menu, the option you want to confirm or to modify.
- Press <F10> when you have completed the setup of BIOS parameters to save these parameters and to exit the BIOS Setup menu.
- Press Page Up/Page Down or +/- keys when you want to modify the BIOS parameters for the active option.

#### 3-1 Entering Setup

Power on the computer and by pressing <Del> immediately allows you to enter Setup. If the message disappears before your respond and you still wish to enter Setup, restart the system to try again by turning it OFF then ON or pressing the “RESET” button on the system case. You may also restart by simultaneously pressing <Ctrl>, <Alt> and <Delete> keys. If you do not press the keys at the correct time and the system does not boot, an error message will be displayed and you will again be asked to

**Press <F1> to continue, <Ctrl-Alt-Esc> or <Del> to enter Setup**

#### 3-2 Getting Help

##### Main Menu

The on-line description of the highlighted setup function is displayed at the bottom of the screen.

##### Status Page Setup Menu/Option Page Setup Menu

Press F1 to pop up a small help window that describes the appropriate keys to use and the possible selections for the highlighted item. To exit the Help Window, press <Esc> .





---

---

### Load Optimized Defaults

Use this menu to load the BIOS default values that are factory settings for optimal performances system operations.

### Load Standard Defaults

Use this menu to load the BIOS default values for the minimal/stable performance system operation.

### Set Supervisor/User Password

Use this menu to set User and Supervisor Passwords.

### Save & Exit Setup

Save CMOS value changes to CMOS and exit setup.

### Exit Without Saving

Abandon all CMOS value changes and exit setup.

## 3-4 Standard CMOS Features

The items in Standard CMOS Setup Menu are divided into several categories. Each category includes no, one or more than one setup items. Use the arrow keys to highlight the item and then use the <PgUp> or <PgDn> keys to select the value you want in each item.

CMOS Setup Utility - Copyright(C) 1984-2002 Award Software  
Standard CMOS Features

Date (mm:dd:yy)	Wed, Jul, 03 2002	Item Help
Time (hh:mm:ss)	16 : 45 : 35	
> IDE Primary Master	Press Enter None	Menu Level >
> IDE Primary Slave	Press Enter None	
> IDE Secondary Master	Press Enter None	
> IDE Secondary Slave	Press Enter None	Change the day, month, year and century
Drive A	1.44M, 3.25 in.	
Drive B	None	
Video	EGA/VGA	
Halt On	All,But Keyboard	
Base Memory	640K	
Extended Memory	56320K	
Total Memory	57344K	
↑↓→← Move Enter:Select +/-/PU/PD:Value F10:Save ESC:Exit F1:General Help F5:Previous Values F6:Optimized Defaults F7:Standard Defaults		

### Date

The date format is <day> <month> <date> <year> .

- Day** Day of the week, from Sun to Sat, determined by BIOS. Read-only.
- Month** The month from Jan. through Dec.
- Date** The date from 1 to 31 can be keyed by numeric function keys.
- Year** The year depends on the year of the BIOS.

---

---

## Time

The time format is <hour> <minute> <second> .

## Primary Master/Primary Slave

## Secondary Master/Secondary Slave

Press PgUp/<+> or PgDn/<-> to select Manual, None, Auto type. Note that the specifications of your drive must match with the drive table. The hard disk will not work properly if you enter improper information for this category. If your hard disk drive type is not matched or listed, you can use Manual to define your own drive type manually.

If you select Manual, related information is asked to be entered to the following items. Enter the information directly from the keyboard. This information should be provided in the documentation from your hard disk vendor or the system manufacturer.

If the controller of HDD interface is SCSI, the selection shall be "None".

If the controller of HDD interface is CD-ROM, the selection shall be "None"

**Access Mode** The settings are Auto Normal, Large, and LBA.

**Cylinder** number of cylinders

**Head** number of heads

**Precomp** write precomp

**Landing Zone** landing zone

**Sector** number of sectors

## 3-5 Advanced BIOS Features

CMOS Setup Utility - Copyright(C) 1984-2002 Award Software

### Advanced BIOS Features

Anti-Virus Protection	Disabled	Item Help
CPU L1 Cache	Enabled	
CPU L2 Cache	Enabled	
Processor SSE Feature	Enabled	
Quick Power On Self Test	Enabled	
ATA & SCSI Boot Order	ATA, SCSI	
First Boot Device	Floppy	
Second Boot Device	HDD-0	
Third Boot Device	CDROM	
Boot other Device	Enabled	
Swap Floppy Drive	Disabled	
Boot Up Floppy Seek	Enabled	
Boot Up NumLock Status	On	
Gate A20 Option	Normal	
Typematic Rate Setting	Disabled	
Typematic Rate (Chars/Sec)	6	
Typematic Delay (Msec)	250	
Security Option	Setup	
OS Select For DRAM > 64MB	Non-OS2	
HDD S.M.A.R.T. Capability	Disabled	
Video BIOS Shadow	Enabled	
Menu Level >		
↑↓←→ Move Enter:Select +/-/PU/PD:Value F10:Save ESC:Exit F1:General Help F5:Previous Values F6:Optimized Defaults F7:Standard Defaults		

---

---

### Anti-Virus Protection

Allows you to choose the VIRUS Warning feature for IDE Hard Disk boot sector protection. If this function is enabled and someone attempt to write data into this area, BIOS will show a warning message on screen and alarm beep.

- Disabled** (default) No warning message to appear when anything attempts to access the boot sector or hard disk partition table.
- Enabled** Activates automatically when the system boots up causing a warning message to appear when anything attempts to access the boot sector of hard disk partition table.

### CPU L1 Cache

The default value is Enabled.

- Enabled** (default) Enable cache
- Disabled** Disable cache

*Note: The internal cache is built in the processor.*

### CPU L2 Cache

Choose Enabled or Disabled. This option enables the Level 2 cache memory.

### Processor SSE Feature

Choose Enabled or Disabled. This option enables the AMD Athlon XP SSE Feature.

### Quick Power On Self-Test

This category speeds up Power On Self Test (POST) after you power on the computer. If this is set to Enabled. BIOS will shorten or skip some check items during POST.

- Enabled** (default) Enable quick POST
- Disabled** Normal POST

### First/Second/Third/Fourth Boot Device

The BIOS attempts to load the operating system from the devices in the sequence selected in these items. The settings are Floppy, LS/ZIP, HDD-0/HDD-1/HDD-3, SCSI, CDROM, LAD and Disabled.

### Swap Floppy Drive

Switches the floppy disk drives between being designated as A and B. Default is Disabled.

### Boot Up Floppy Seek

During POST, BIOS will determine if the floppy disk drive installed is 40 or 80 tracks. 360K type is 40 tracks while 760K, 1.2M and 1.44M are all 80 tracks.

### Boot Up NumLock Status

The default value is On.

- On** (default) Keypad is numeric keys.
- Off** Keypad is arrow keys.

### Gate A20 Option

- Normal** The A20 signal is controlled by keyboard controller or chipset hardware.
- Fast** (default) The A20 signal is controlled by port 92 or chipset specific method.

---

---

### Typematic Rate Setting

Keystrokes repeat at a rate determined by the keyboard controller. When enabled, the typematic rate and typematic delay can be selected. The settings are: Enabled/Disabled.

### Typematic Rate (Chars/Sec)

Sets the number of times a second to repeat a keystroke when you hold the key down. The settings are: 6, 8, 10, 12, 15, 20, 24, and 30.

### Typematic Delay (Msec)

Sets the delay time after the key is held down before it begins to repeat the keystroke. The settings are 250, 500, 750, and 1000.

### Security Option

This category allows you to limit access to the system and Setup, or just to Setup.

- System**            The system will not boot and access to Setup will be denied if the correct password is not entered at the prompt.
- Setup (default)**   The system will boot, but access to Setup will be denied if the correct password is not entered prompt.

### OS Select For DRAM > 64MB

Allows OS2® to be used with >64MB or DRAM. Settings are Non-OS/2 (default) and OS2. Set to OS/2 if using more than 64MB and running OS/2®.

## 3-6 Advanced Chipset Features

The Advanced Chipset Features Setup option is used to change the values of the chipset registers. These registers control most of the system options in the computer.

CMOS Setup Utility - Copyright(C) 1984-2002 Award Software  
Advanced Chipset Features

> DRAM Timing Settings	Press Enter	Item Help
> AGP Timing Settings	Press Enter	
> PCI Timing Settings	Press Enter	
System BIOS Cacheable	Disabled	Menu Level >
Video RAM Cacheable	Disabled	
Memory Hole	Disabled	
↑↓←→ Move Enter:Select +/-/PU/PD:Value F10:Save ESC:Exit F1:General Help F5:Previous Values F6:Optimized Defaults F7:Standard Defaults		

---

---

### DRAM Timing Settings

Please refer to section 3-6-1

### AGP Timing Settings

Please refer to section 3-6-2

### PCI Timing Settings

Please refer to section 3-6-3

### System BIOS Cacheable

Selecting Enabled allows caching of the system BIOS ROM at F0000h-FFFFFh, resulting in better system performance. However, if any program writes to this memory area, a system error may result. The settings are: Enabled and Disabled.

### Video RAM Cacheable

Select Enabled allows caching of the video BIOS, resulting in better system performance. However, if any program writes to this memory area, a system error may result. The settings are: Enabled and Disabled.

### Memory Hole

You can reserve this area of system memory for ISA adapter ROM. When this area is reserved, it cannot be cached. The user information of peripherals that need to use this area of system memory usually discusses their memory requirements. The settings are: Enabled and Disabled.

## 3-6-1 DRAM Timing Settings

CMOS Setup Utility - Copyright(C) 1984-2002 Award Software

### DRAM Timing Settings

Auto Configuration	Optimized	Item Help
RAS Active Time	6T	Menu Level >>
RAS Precharge Time	3T	
RAS to CAS Delay	3T	
CAS Latency	2.5T	
Bank Interleave	4 Bank	
DRAM Command Rate	2T Command	
↑↓→← Move Enter:Select +/-/PU/PD:Value F10:Save ESC:Exit F1:General Help F5:Previous Values F6:Optimized Defaults F7:Standard Defaults		

### RAS Active Time

This field let's you insert a timing delay between the CAS and RAS strobe signals, used when DRAM is written to, read from, or refreshed. *Fast* gives faster performance; and *Slow* gives more stable performance. This field applies only when synchronous DRAM is installed in the system. The settings are: 2T and 3T.

---

---

### RAS Precharge Time

If an insufficient number of cycles is allowed for the RAS to accumulate its charge before DRAM refresh, the refresh may be incomplete and the DRAM may fail to retain data. *Fast* gives faster performance; and *Slow* gives more stable performance. This field applies only when synchronous DRAM is installed in the system. The settings are: 2T and 3T.

### CAS Latency

When synchronous DRAM is installed, the number of clock cycles of CAS latency depends on the DRAM timing. The settings are: 2T and 2.5T.

## 3-6-2 AGP Timing Settings

CMOS Setup Utility - Copyright(C) 1984-2002 Award Software

### AGP Timing Settings

AGP Transfer Aperture Size	64M	Item Help
AGP Mode	Auto	
AGP Driving Control	Auto	
AGP Driving Value	DA	Menu Level >>
AGP Fast Write	Disabled	
AGP Master 1 WS Write	Enabled	
AGP Master 1 WS Read	Enabled	
CPU to AGP Post Write	Disabled	
AGP Delay Transaction	Disabled	
↑↓←→ Move Enter:Select +/-/PU/PD:Value F10:Save ESC:Exit F1:General Help F5:Previous Values F6:Optimized Defaults F7:Standard Defaults		

*Note: Change these settings only if you are familiar with the chipset.*

## 3-6-3 PCI Timing Settings

CMOS Setup Utility - Copyright(C) 1984-2002 Award Software

### PCI Timing Settings

PCI Master 1 WS Write	Disabled	Item Help
PCI Master 1 WS Read	Disabled	
CPU to AGP Post Write	Disabled	
PCI Delay Transaction	Disabled	Menu Level >>
↑↓←→ Move Enter:Select +/-/PU/PD:Value F10:Save ESC:Exit F1:General Help F5:Previous Values F6:Optimized Defaults F7:Standard Defaults		

### PCI Delay Transaction

The chipset has an embedded 32-bit posted write buffer to support delay transactions cycles. Select Enabled to support compliance with PCI specification version 2.1. The settings are: Enabled and Disabled.

## 3-7 Integrated Peripherals

CMOS Setup Utility - Copyright(C) 1984-2002 Award Software

### Integrated Peripherals

> OnChip IDE Function	Press Enter	Item Help
> OnChip Device Function	Press Enter	
> Onboard Super IO Function	Press Enter	
Init Display First	PCI Slot	Menu Level >
↑↓→← Move Enter:Select +/-/PU/PD:Value F10:Save ESC:Exit F1:General Help F5:Previous Values F6:Optimized Defaults F7:Standard Defaults		

### OnChip IDE Function

Please refer to section 3-7-1

### OnChip Device Function

Please refer to section 3-7-2

### Onboard Super IO Function

Please refer to section 3-7-3

### Init Display First

This item allows you to decide to activate whether PCI Slot or AGP VGA first. The settings are: PCI Slot, AGP Slot.

### 3-7-1 OnChip IDE Function

CMOS Setup Utility - Copyright(C) 1984-2002 Award Software

#### OnChip IDE Function

OnChip IDE Channel0	Enabled	Item Help
OnChip IDE Channell	Enabled	
Primary Master PIO	Auto	
Primary Slave PIO	Auto	Menu Level >>
Secondary Master PIO	Auto	
Secondary Slave PIO	Auto	
Primary Master UDMA	Auto	
Primary Slave UDMA	Auto	
Secondary Master UDMA	Auto	
Secondary Slave UDMA	Auto	
IDE 32-bit Transfer Mode	Enabled	
IDE HDD Block Mode	Enabled	
IDE Prefetch Mode	Enabled	
Delay For HDD (Secs)	0	
↑↓→← Move Enter:Select +/-/PU/PD:Value F10:Save ESC:Exit F1:General Help F5:Previous Values F6:Optimized Defaults F7:Standard Defaults		

---

---

### OnChip IDE Channal0/Channel1

The integrated peripheral controller contains an IDE interface with support for two IDE channels. Select *Enabled* to activate each channel separately. The settings are: Enabled and Disabled.

### Primary/Secondary Master/Slave PIO

The four IDE PIO (Programmed Input/Output) fields let you set a PIO mode (0-4) for each of the four IDE devices that the onboard IDE interface supports. Modes 0 through 4 provide successively increased performance. In Auto mode, the system automatically determines the best mode for each device. The settings are: Auto, Mode 0, Mode 1, Mode 2, Mode 3, Mode 4.

### Primary/Secondary Master/Slave UDMA

Ultra DMA/33 implementation is possible only if your IDE hard drive supports it and the operating environment includes a DMA driver (Windows 95 OSR2 or a third-party IDE bus master driver). If your hard drive and your system software both support Ultra DMA/33 and Ultra DMA/66, select Auto to enable BIOS support. The settings are: Auto, Disabled.

### IDE HDD Block Mode

Block mode is also called block transfer, multiple commands, or multiple sector read/write. If your IDE hard drive supports block mode (most new drives do), select Enabled for automatic detection of the optimal number of block read/writes per sector the drive can support. The settings are: Enabled, Disabled.

## 3-7-2 OnChip Device Function

CMOS Setup Utility - Copyright(C) 1984-2002 Award Software

### OnChip Device Function

AC97 Sound Device	Auto	Item Help
Game Port Address	201	
Midi Port Address	Disabled	Menu Level >>
Midi Port IRQ	10	
AC97 Modem Device	Auto	
USB Host Controller	Enabled	
USB Keyboard Legacy Support	Disabled	
↑↓→← Move Enter:Select +/-/PU/PD:Value F10:Save ESC:Exit F1:General Help F5:Previous Values F6:Optimized Defaults F7:Standard Defaults		

### AC97 Sound Device

This item allows you to decide to enable/disable the KT333 chipset family to support AC97 Audio. The settings are: Enabled, Disabled.

### Game Port Address/Midi Port Address

This will determine which Address the Game Port/Midi Port will use.



---

---

### AC97 Modem Device

This item allows you to decide to enable/disable the KT333 chipset family to support AC97 Modem. The settings are: Auto, Disabled.

### USB Host Controller

Select *Enabled* if your system contains a Universal Serial Bus (USB) controller and you have a USB peripherals. The settings are: Enabled, Disabled.

### USB Keyboard Support

Select *Enabled* if your system contains a Universal Serial Bus (USB) controller and you have a USB keyboard. The settings are: Enabled, Disabled.

## 3-7-3 Onboard Super IO Function

CMOS Setup Utility - Copyright(C) 1984-2002 Award Software

### Onboard Super IO Function

Onboard FDD Controller	Enabled	Item Help
Onboard Serial Port 1	3F8/IRQ4	
Onboard Serial Port 2	2F8/IRQ3	
UART2 Mode	Normal	Menu Level >>
RxD, TxD Active	Hi, Lo	
IR Duplex Mode	Half	
Use IR Pins	IRRX/IRTX	
Onboard Parallel Port	378/IRQ7	
Parallel Mode	SPP	
EPP Mode Select	EPP1.9	
ECP Mode Use DMA	3	

↑↓←→ Move Enter:Select +/-/PU/PD:Value F10:Save ESC:Exit F1:General Help  
F5:Previous Values F6:Optimized Defaults F7:Standard Defaults

### Onboard FDD Controller

Select Enabled if your system has a floppy disk controller (FDD) installed on the system board and you wish to use it. If you install add-on FDC or the system has no floppy drive, select Disabled in this field. The settings are: Enabled and Disabled.

### Onboard Serial Port 1/Port 2

Select an address and corresponding interrupt for the first and the second serial ports. The settings are: 3F8/IRQ4, 2E8/IRQ3, 3E8/IRQ4, 2F8/IRQ3, Disabled, Auto.

### UART2 Mode

This item allows you to determine which InfraRed(IR) function of the onboard I/O chip, this functions uses.

### Onboard Parallel Port

There is a built-in parallel port on the on-board Super I/O chipset that Provides Standard, ECP, and EPP features. It has the following option:

#### Disabled

(3BCH/IRQ7)/ Line Printer port 0

(278H/IRQ5)/ Line Printer port 2

(378H/IRQ7) Line Printer port 1

---

---

## Parallel Port Mode

SPP : Standard Parallel Port  
EPP : Enhanced Parallel Port  
ECP : Extended Capability Port

### SPP/EPP/ECP/ECP+EPP

To operate the onboard parallel port as Standard Parallel Port only, choose "SPP." To operate the onboard parallel port in the EPP modes simultaneously, choose "EPP." By choosing "ECP", the onboard parallel port will operate in ECP mode only. Choosing "ECP+EPP" will allow the onboard parallel port to support both the ECP and EPP modes simultaneously. The ECP mode has to use the DMA channel, so choose the onboard parallel port with the ECP feature. After selecting it, the following message will appear: "ECP Mode Use DMA" at this time, the user can choose between DMA channels 3 to 1. The onboard parallel port is EPP Spec. compliant, so after the user chooses the onboard parallel port with the EPP function, the following message will be displayed on the screen: "EPP Mode Select." At this time either EPP 1.7 spec. or EPP 1.9 spec. can be chosen.

## 3-8 Power Management Setup

The Power Management Setup allows you to configure your system to most effectively save energy saving while operating in a manner consistent with your own style of computer use.

CMOS Setup Utility - Copyright(C) 1984-2002 Award Software

### Power Management Setup

ACPI Function	Enabled	Item Help
Video Off Option	Suspend -> off	
Video off Method	V/H SYNC+Blank	
MODEM Use IRQ	3	Menu Level >
Power Button Function	Instant-Off	
State After Power Failure	Auto	
> Wake Up Events	Press Enter	

↑↓→← Move Enter:Select +/-/PU/PD:Value F10:Save ESC:Exit F1:General Help  
F5:Previous Values F6:Optimized Defaults F7:Standard Defaults

### ACPI Function

This item allows you to Enabled/Disabled the Advanced Configuration and Power Management (ACPI). The settings are Enabled and Disabled.

### Video Off Option

This determines the manner in which the monitor is blanked. The choice are Suspend → off, All Modes → Off, and Always On.

### Video Off Method

This determines the manner in which the monitor is blanked.

- DPMS (default)** Initial display power management signaling.
- Blank Screen** This option only writes blanks to the video buffer.
- V/H SYNC+Blank** This selection will cause the system to turn off the vertical and horizontal synchronization ports and write blanks to the video buffer.

---

---

### Modem Use IRQ

This determines the IRQ in which the MODEM can use.

The settings are: 3, 4, 5, 7, 9, 10, 11, NA.

### Power Button Function

Pressing the power button for more than 4 seconds forces the system to enter the Soft-Off state.

The settings are: Delay 4 Sec, Instant-Off.

### State After Power Failure

This item allows the system power ON/OFF automatic when power loss and recovery again, you can choose Auto for recovery pre-state, or always ON/OFF after power recovery.

### Wake Up Events

Please refer to section 3-8-1

## 3-8-1 Wake up Events

CMOS Setup Utility - Copyright(C) 1984-2002 Award Software

### Wake Up Events

VGA	OFF	Item Help
LPT & COM	LPT/COM	
HDD & FDD	ON	Menu Level >>
PCI Master	OFF	
Wake-Up on Ring	Disabled	
Wake-Up on PCI PME	Disabled	
PS2 KB Wakeup Selection	Hot Key	
Wake-Up On Hot Key (PS2 KB)	Disabled	
Wake-Up on RTC Alarm	Disabled	
x Date of Month Alarm	0	
x Time (hh:mm:ss) Alarm	0 : 0 : 0	
> IRQs Activities	Press Enter	
↑↓←→ Move Enter:Select +/-/PU/PD:Value F10:Save ESC:Exit F1:General Help F5:Previous Values F6:Optimized Defaults F7:Standard Defaults		

### Wake Up On Ring/PME

During Disabled, the system will ignore any incoming call from the modem. During Enabled, the system will boot up if there's an incoming call from the modem.

### Wake-Up on RTC Alarm

This function is for setting date and time for your computer to boot up. During Disabled, you cannot use this function. During Enabled, choose the Date and Time Alarm:

#### Date(of month) Alarm

You can choose which month the system will boot up. Set to 0, to boot every day.

#### Time(hh:mm:ss) Alarm

You can choose what hour, minute and second the system will boot up.

**Note:** If you have change the setting, you must let the system boot up until it goes to the operating system, before this function will work.

### IRQs Activities

Please refer to section 3-8-1.1

### 3-8-1.1 IRQs Activities

CMOS Setup Utility - Copyright(C) 1984-2002 Award Software

#### IRQs Activities

Primary INTR	ON	Item Help	
IRQ3 (COM 2)	Enabled	Menu Level >>>	
IRQ4 (COM 1)	Enabled		
IRQ5 (LPT 2)	Enabled		
IRQ6 (Floppy Disk)	Enabled		
IRQ7 (LPT 1)	Enabled		
IRQ8 (RTC Alarm)	Disabled		
IRQ9 (IRQ2 Redir)	Disabled		
IRQ10 (Reserved)	Disabled		
IRQ11 (Reserved)	Disabled		
IRQ12 (PS/2 Mouse)	Enabled		
IRQ13 (Coprocessor)	Disabled		
IRQ14 (Hard Disk)	Enabled		
IRQ15 (Reserved)	Disabled		
↑↓→← Move Enter:Select +/-/PU/PD:Value F10:Save ESC:Exit F1:General Help F5:Previous Values F6:Optimized Defaults F7:Standard Defaults			

### 3-9 PnP/PCI Configuration Setup

This section describes configuring the PCI bus system. PCI, or Personal Computer Interconnect, is a system which allows I/O devices to operate at speeds nearing the speed the CPU itself uses when communicating with its own special components. This section covers some very technical items and it is strongly recommended that only experienced users should make any changes to the default settings.

CMOS Setup Utility - Copyright(C) 1984-2002 Award Software

#### PnP/PCI Configurations

PnP OS Installed	No	Item Help
Reset Configuration Data	Disabled	Menu Level >
Resources Controlled By	Manual	
x IRQ Resources	Press Enter	
PCI/VGA Palette Snoop	Disabled	
Assign IRQ For VGA	Enabled	
Assign IRQ For USB	Enabled	
↑↓→← Move Enter:Select +/-/PU/PD:Value F10:Save ESC:Exit F1:General Help F5:Previous Values F6:Optimized Defaults F7:Standard Defaults		

#### Reset Configuration Data

Normally, you leave this field Disabled. Select Enabled to reset Extended System Configuration Data (ESCD) when you exit Setup if you have installed a new add-on and the system reconfiguration has caused such a serious conflict that the operating system can not boot. The settings are: Enabled and Disabled.

#### Resource Controlled By

The Award Plug and Play BIOS has the capacity to automatically configure all of the boot and Plug and Play compatible devices. However, this capability means absolutely nothing unless you are

using a Plug and Play operating system such as Windows®95/98. If you set this field to “manual” choose specific resources by going into each of the sub menu that follows this field (a sub menu is preceded by a “>”).

The settings are: Auto(ESCD), Manual.

### IRQ Resources

When resources are controlled manually, assign each system interrupt a type, depending on the type of device using the interrupt.

Please refer to section 3-9-1

### PCI/VGA Palette Snoop

Leave this field at *Disabled*. The settings are Enabled, Disabled.

## 3-9-1 IRQ Resources

CMOS Setup Utility - Copyright(C) 1984-2002 Award Software

### IRQ Resources

IRQ3	assigned to	PCI Device	Item Help
IRQ4	assigned to	PCI Device	
IRQ5	assigned to	PCI Device	Menu Level >>
IRQ7	assigned to	PCI Device	
IRQ9	assigned to	PCI Device	
IRQ10	assigned to	PCI Device	
IRQ11	assigned to	PCI Device	
IRQ12	assigned to	PCI Device	
IRQ14	assigned to	PCI Device	
IRQ15	assigned to	PCI Device	
↑↓←→ Move Enter:Select +/-/PU/PD:Value F10:Save ESC:Exit F1:General Help F5:Previous Values F6:Optimized Defaults F7:Standard Defaults			

## 3-10 PC Health Status

This section shows the Status of you CPU, Fan, Warning for overall system status. This is only available if there is Hardware Monitor onboard.

CMOS Setup Utility - Copyright(C) 1984-2002 Award Software

### PC Health Status

Shutdown Temperature	Disabled	Item Help
Show PC Health in Post	Enabled	
Detect CPUFAN in Post	Enabled	Menu Level >
Current System Temperature	25°C	
Current CPU Temperature	38°C	
Current CPUFAN Speed	5000 rpm	
Current SYSFAN Speed	5000 rpm	
Vcore	1.78V	
Vcc3.3	3.31V	
+ 5V	4.98V	
+12V	12.22V	
-12V	-12.36V	
VBAT (V)	3.21V	
5VSB (V)	5.02V	
↑↓←→ Move Enter:Select +/-/PU/PD:Value F10:Save ESC:Exit F1:General Help F5:Previous Values F6:Optimized Defaults F7:Standard Defaults		

---

---

### Shutdown Temperature

This item can let users setting the Shutdown temperature, when CPU temperature over this setting the system will auto shutdown to protect CPU.

### Show PC Health in Post

During Enabled, it displays information list below. The choice is either Enabled or Disabled

### Current CPU Temperature/Current System Temp/Current FAN1, FAN2 Speed/Vcore/Vdd/3.3V/+5V/+12V/-12V/VBAT(V)/5VSB(V)

This will show the CPU/FAN/System voltage chart and FAN Speed.

### Detect CPUFAN in Post

During Enabled, system will warn the user if CPU Fan is not functioning.

## 3-11 Miscellaneous Control

This section is for setting CPU Frequency/Voltage Control.

CMOS Setup Utility - Copyright(C) 1984-2002 Award Software  
Miscellaneous Control

Auto Detect DIMM/PCI Clk	Enabled	Item Help
Spread Spectrum	Disabled	
** Current Host Clock is		
Host Clock at Next Boot is	100MHz	Menu Level >
** Current DRAM Clock is		
DRAM Clock at next Boot is		
AGP VddQ Select	1.5V (Default)	
VDIMM Select	2.5V (Default)	
VCC2.5 Select	2.5V (Default)	
↑↓→← Move Enter:Select +/-/PU/PD:Value F10:Save ESC:Exit F1:General Help F5:Previous Values F6:Optimized Defaults F7:Standard Defaults		

### Auto Detect DIMM/PCI Clk

This item allows you to enable/disable auto detect DIMM/PCI Clock.

### Spread Spectrum

This item allows you to set the CPU Host/PCI clock and Spread Spectrum.

The settings are: Enabled, Disabled.

### Host Clock at next Boot is

This item allows you to select CPU frequency step by step increasing

The choice are: 100MHz~132MHz, 133MHz~165MHz, 166MHz~255MHz.

### DRAM Clock at next Boot is

This field displays the capability of the memory modules that you can use

The choice is either 100MHz or 133MHz or 166MHz or 200MHz.

### AGP VddQ Select

This item allows you to select 1.5V of the AGP 4X/8X VGA card. The choice are: 1.5V, 1.6V.

### VDIMM Select

This item allows you to select 2.5V of the DDR Module. The choice are: 2.5V, 2.6V, 2.7V, 2.8V.

---

---

## 3-12 Load Standard/Optimized Defaults

### Load Standard Defaults

When you press <Enter> on this item, you get confirmation dialog box with a message similar to:

Load Standard Defaults (Y/N)? N

Pressing <Y> loads the BIOS default values for the most stable, minimal-performance system operations.

### Load Optimized Defaults

When you press <Enter> on this item, you get a confirmation dialog box with a message similar to:

Load Optimized Defaults (Y/N)? N

Pressing <Y> loads the default values that are factory settings for optimal performance system operations.

## 3-13 Set Supervisor/User Password

You can set either supervisor or user password, or both of them. The differences are:

**Supervisor password:** Can enter and change the options of the setup menus.

**User password:** Can only enter but do not have the right to change the options of the setup menus. When you select this function, the following message will appear at the center of the screen to assist you in creating a password.

### ENTER PASSWORD:

Type the password, up to eight characters in length, and press <Enter>. The password typed now will clear any previously entered password from CMOS memory. You will be asked to confirm the password. Type the password again and press <Enter>. You may also press <Esc> to abort the selection and not enter a password.

To disable a password, just press <Enter> when you are prompted to enter the password. A message will confirm that the password will be disabled. Once the password is disabled, the system will boot and you can enter Setup freely.

### PASSWORD DISABLED.

When a password has been enabled, you will be prompted to enter it every time you try to enter Setup. This prevents an unauthorized person from changing any part of your system configuration.

Additionally, when a password is enabled, you can also require the BIOS to request a password every time your system is rebooted. This would prevent unauthorized use of your computer.

You determine when the password is required within the BIOS Features Setup Menu and its Security option. If the Security option is set to "System", the password will be required both at boot and at entry to Setup. If set to "Setup", prompting only occurs when trying to enter Setup.

---

---

## Chapter 4

### DRIVER & FREE PROGRAM INSTALLATION

Check your package and there is A MAGIC INSTALL CD included. This CD consists of all DRIVERS you need and some free application programs and utility programs. In addition, this CD also include an auto detect software which can tell you which hardware is installed, and which DRIVERS needed so that your system can function properly. We call this auto detect software MAGIC INSTALL.

#### MAGIC INSTALL supports WINDOWS 9X/NT/2K/XP

Insert CD into your CD-ROM drive and the MAGIC INSTALL Menu should appear as below. If the menu does not appear, double-click MY COMPUTER / double-click CD-ROM drive or click START / click RUN / type X:\SETUP.EXE (assuming X is your CD-ROM drive).



**From MAGIC INSTALL MENU you may make 9 selections:**

1. VIA 4 IN 1      install VIA Service Pack 4 IN 1 driver
2. SOUND          install AC97 Audio Codec Installing driver
3. PC-HEALTH      install Winbond PC-HEALTH hardware monitor Software
4. MAGIC BIOS     install BIOS Live Update Utility
5. PC-CILLIN       install PC-CILLIN2002 anti-virus program
6. DIRECTX8        install Microsoft DirectX 8.1 driver
7. USB2.0          install USB 2.0 driver
8. BROWSE CD      to browse the contents of the CD
9. EXIT             to exit from MAGIC INSTALL menu



---

---

## 4-1 IDE Install VIA Service Pack 4 IN 1 Driver

\* The path of the file is X:\VIA\DRIVER\SETUP.EXE

**IDE :** VIA ATAPI VENDOR SUPPORT DRIVER IS USED TO FIXED COMPATIBILITY ISSUE FOR IDE DEVICES

**AGPVXD :** VIA AGPVXD DRIVER IS TO BE INSTALLED, IF YOU ARE USING AN AGP VGA CARD, VIAGART.VXD WILL PROVIDE SERVICE ROUTINES TO YOUR VGA DRIVER AND INTERFACE DIRECTLY TO HARDWARE, PROVIDING FAST GRAPHIC ACCESS

**IRQ ROUTING :** VIA PCI IRQ MINIPOINT DRIVER IS TO BE INSTALLED UNDER WIN98 ONLY, IT WILL FIX PCI IRQ ROUTING SEQUENCE

**INF :** VIA REGISTRY DRIVER IS TO BE INSTALLED UNDER WINDOWS THE DRIVER WILL ENABLE VIA POWER MANAGERMENT CONTROLLER



1. Click IDE when MAGIC INSTALL MENU appears



2. Click NEXT when VIA Service Pack Wizard appears

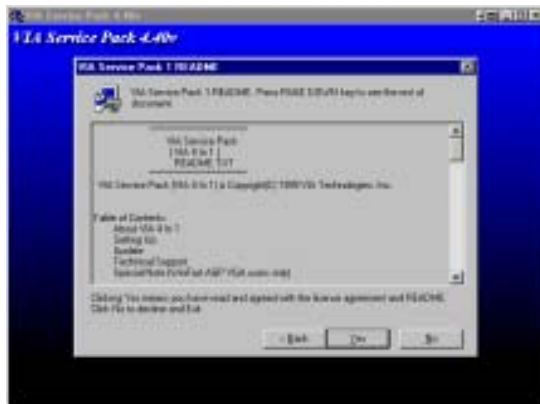

3. This is to announce the Copy Write, click Yes



4. Click NEXT to choose all driver



5. Click NEXT to Install ATAPI Vendor Support Driver



6. Click NEXT to choose enabled DMA Mode



7. Click NEXT to Install VIA AGP VXD Driver



8. Click NEXT to Install VIA IRQ Routing Mini port Driver



9. Click Finish to restart computer

## 4-2 SOUND Install CMI Audio Codec Driver



1. Click SOUND when MAGIC INSTALL MENU appears



2. Choose Install component in Installation Package



3. Click Next when copyright Issue appears, click Next or choose BROWSE to change the path for the file to be store



4. Enter Program folders name or click Next



5. C-Media Media Rack can Auto Play following Format file choose need component and Click Next



6. Click Next when Start copying files windows appears, OS can Auto Find C-Media AC97 Audio Device Click Next



7. C-Media Media Rack Play table



8. C-Media Audio Configuration setting



9. C-Media Multi-Channel Audio Demo Program, you can Test speaker position



10. When Enabled XeaR, you can plug earphone in Speak-Out connector as a Rear speaker, and 2-channel speaker plug in Line-In as Front Speaker to get 4-channel effect

---

---

## 4-3 PC-HEALTH Winbond Hardware Doctor Monitoring Software

The path of the file is X:\VIA\HEALTH-W\SETUP.EXE

(Only support WINDOWS 95/98/98SE/ME)

In Windows 95/98 Winbond Hardware Doctor Monitoring Software needs some system files to copy in Utility that's why it needs install PC-HEALTH twice to complete setup.



1. Click PC-Health when Magic Install Menu appears



2. Click OK when Winbond Hardware Doctor Setup Window appears



3. Click the Button to start installation



4. Select Program Group name or enter a new group name, click continue to setup and click OK after setup complete

### 4-3-1 How To Utilize PC-HEALTH



1. Click Program → Winbond Hardware Doctor → Hardware Doctor the Winbond Hardware Doctor will appears  
You can remove the Utility in Control Panel → Add/Remove Program icon

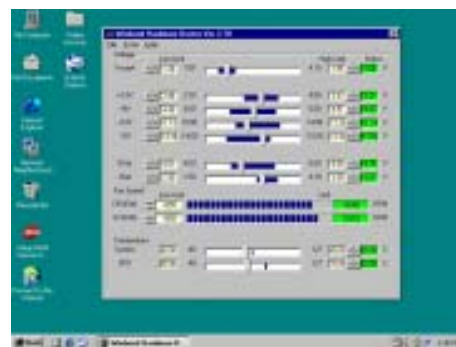

2. After executing Winbond Hardware Doctor it supports system voltage, Fan speed and CPU/SYSTEM Temperature. Because this is a On-time Monitoring program therefore the value will change after it detected, if the value is over default setting the system will have warning picture and beeps

## 4-4 MAGIC BIOS Install BIOS Live Update Utility



1. Click Magic BIOS when Magic Install MENU appears



2. Click Next to install the Magic BIOS in Destination Folder



3. After finish Setup you will have a Magic BIOS icon in your screen



4. Double click the Magic BIOS icon you will have this picture, choose from internet you can upgrade BIOS On-line



5. When On-line update BIOS the program will auto-check your BIOS version



6. Click Next if you need update BIOS, after upgrade BIOS, the system will clear CMOS and automatically restart

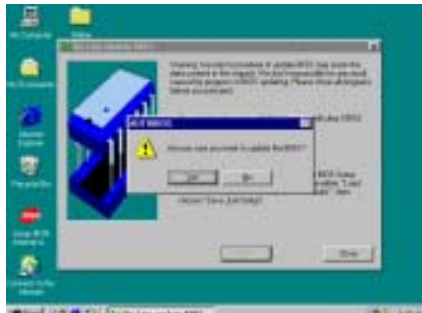

7. Click Yes if you want to update the BIOS otherwise choose No to exit



8. When System programming BIOS don't turn off power, after finish update BIOS, the system will clear CMOS and automatically Restart



9. When choose From Local Driver to update BIOS, you must have the correct BIOS file in your Local Driver
10. Choose the correct BIOS file to update BIOS

#### 4-5 PC-CILLIN Install PC-CILLIN 2002 Anti-virus program

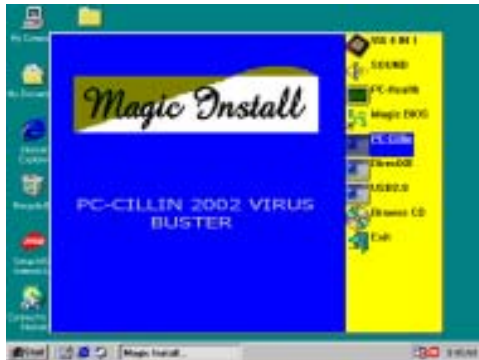

1. Click PC-CILLIN when MAGIC INSTALL MENU appear
2. (1) Click "Install PC-CILLIN" when PC-CILLIN 2002 main menu appears, and Click NEXT when "Install Shield Wizard For PC-CILLIN 2002"  
(2) Click Open Manual. you can learn PC-CILLIN 2002 how to use

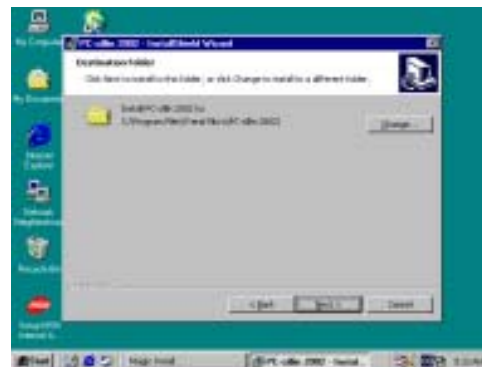
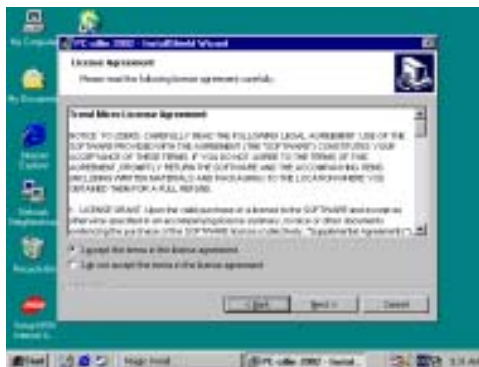

3. This is license agreement, select "I Accept the terms" and Click NEXT
4. Click NEXT and Enter your Customer Information, Click NEXT or choose Change to change the path for the file to be stored



5. Click INSTALL, Start to install the software

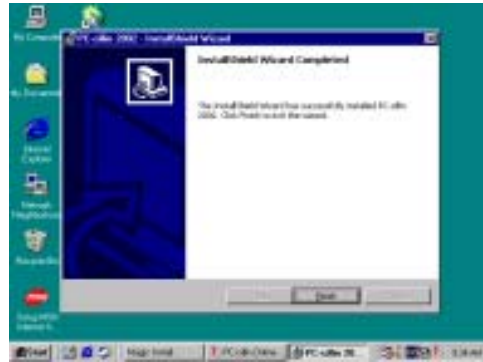

6. Setup Complete and click FINISH



7. After PC-CILLIN 2002 complete, Please register your information and get LICENSE KEY from TREND MICRO web site, enter your license key and click FINISH



8. finish register process, we recommend select update item to download newest engine code and virus code

**Note :** Please install ACROBAT READER, Before you read PC-CILLIN 2002 User Manual, the path at X:\acrobat\ar500eng.exe

## 4-6 USB2.0 Install VIA USB2.0 DEVICE DRIVER



1. Click USB2.0 when MAGIC INSTALL MENU Appear



2. When USB2.0 Setup Program Appear, Click NEXT

**Note:** Please Install Microsoft Service Pack 1 in Windows XP OS Before you Install VIA USB2.0 Device Driver.



3. Select Install USB Driver and Click NEXT



4. Select FINISH and Restart your Computer



5. Check device working properly in Device Manager

**The Path of the file is X:\VIA\VIAUSB20\SETUP.EXE**

## 4-7 HOW TO DISABLE ON-BOARD SOUND

Enter BIOS SETUP choose INTEGRATE PERIPHERALS choose ON-CHIP DEVICE FUNCTION choose AC97 SOUND DEVICE

Disable on-board sound function by press PAGE DOWN KEY to Disable

## 4-8 HOW TO UPDATE BIOS

**Method 1.** Use “Magic BIOS” update BIOS in Windows 98 (refer [page 42](#))

**Method 2.** In DOS Mode

**STEP 1.** Prepare a boot disc. (you may make one by click START click RUN type SYS A: click OK)

**STEP 2.** Copy utility program to your boot disc. You may copy from DRIVER CD X:\FLASH\AWDFLASH.EXE or download from our web site.

**STEP 3.** Copy latest BIOS for V400DA from our web site to your boot disc.

**STEP 4.** Insert your boot disc into A:;

start the computer, type “Awdflash A:\ V400DAAxxx.BIN /SN/PY/CC/R”  
V400DAAxxx.BIN is the file name of latest BIOS it can be V400DAA3.BIN or V400DAB2.BIN

SN means don't save existing BIOS data

PY means renew existing BIOS data

CC means clear existing CMOS data

R means restart computer

**STEP 5.** Push ENTER and the BIOS will be updated, computer will be restarted automatically.