

KitchenAid

TECHNICAL EDUCATION



MODELS:
KSBP25FKSS00
KSBS25FKBL00
KSBS25FKBT00
KSBS25FKWH00
KSCS25FKSS00
KSFS25FKBL00
KSFS25FKBT00
KSFS25FKWH00

**2001 K MODEL
COUNTER DEPTH
SIDE-BY-SIDE REFRIGERATOR
WITH VARIABLE
CAPACITY COMPRESSOR**

JOB AID 4317290A

FORWARD

This Job Aid, "KitchenAid 2001 K Model Counter Depth Side-By-Side Refrigerator With Variable Capacity Compressor" (Part No. 4317290A), provides the technician with information on the installation and service of the Side-By-Side Refrigerator. It is to be used as a training Job Aid and Service Manual. For specific information on the model being serviced, refer to the "Use and Care Guide," or "Tech Sheet" provided with the refrigerator.

The Wiring Diagrams and Strip Circuits used in this Job Aid are typical and should be used for training purposes only. Always use the Wiring Diagram supplied with the product when servicing the unit.

GOALS AND OBJECTIVES

The goal of this Job Aid is to provide detailed information that will enable the service technician to properly diagnose malfunctions and repair the Side-By-Side Refrigerator.

The objectives of this Job Aid are to:

- Understand and follow proper safety precautions.
- Successfully troubleshoot and diagnose malfunctions.
- Successfully perform necessary repairs.
- Successfully return the Side-By-Side Refrigerator to its proper operational status.

WHIRLPOOL CORPORATION assumes no responsibility for any repairs made on our products by anyone other than Authorized Service Technicians.

Copyright © 2002, Whirlpool Corporation, Benton Harbor, MI 49022

TABLE OF CONTENTS

	Page
GENERAL	1-1
Safety First.....	1-1
Electrical Power Supply & Grounding Requirements.....	1-1
Electrostatic Discharge (ESD) Sensitive Electronics.....	1-2
Model & Serial Number Designations.....	1-3
Model & Serial Number Label And Tech Sheet Locations.....	1-4
Specifications.....	1-5
Refrigerator Warranty.....	1-7
INSTALLATION INFORMATION	2-1
THEORY OF OPERATION	3-1
COMPONENT ACCESS	4-1
Component Locations.....	4-1
Removing The Touch/Display Board, The Insert And Overlay, & The Motorized Air Door.....	4-2
Removing A Thermistor.....	4-4
Removing A Door Switch.....	4-5
Removing A Light Socket.....	4-6
Removing The Water Reservoir.....	4-7
Removing The Ice Maker And The Auger Motor & Crush/Cube Solenoid.....	4-9
Removing The Evaporator Fan Motor, The Bimetal, The Defrost Heater, & The Evaporator.....	4-11
Removing The Condenser Fan Motor.....	4-15
Removing The Compressor.....	4-16
Removing The Inverter Assembly.....	4-17
Removing The Main Control Board Assembly.....	4-18
Removing The Water Dispenser Fill Tube.....	4-20
Removing The Water Valve.....	4-22
Removing The Freezer Door Handles & Freezer Door.....	4-23
Removing A Roller.....	4-25
COMPONENT TESTING	5-1
Thermistor.....	5-1
Evaporator Fan Motor.....	5-2
Condenser Fan Motor.....	5-2
Compressor & Inverter.....	5-3
Motorized Air Door.....	5-4
Defrost Heater & Bimetal.....	5-4
Main Control Board.....	5-5
Crush/Cube Solenoid.....	5-6
Ice Maker Auger Motor.....	5-6
Water Valve Solenoid.....	5-7
Door Switch.....	5-7

	Page
DIAGNOSIS & TROUBLESHOOTING	6-1
Diagnosis	6-1
Pre-Diagnostics Checks	6-1
Diagnostics Mode	6-1
Water Filter Input (WFI) Test	6-2
Troubleshooting Chart	6-3
WIRING DIAGRAMS & STRIP CIRCUITS	7-1
Wiring Diagram	7-1
Strip Circuits	7-2

GENERAL SAFETY FIRST

Your safety and the safety of others is very important.

We have provided many important safety messages in this Job Aid and on the appliance. Always read and obey all safety messages.



This is the safety alert symbol.

This symbol alerts you to hazards that can kill or hurt you and others.

All safety messages will follow the safety alert symbol and either the word "DANGER" or "WARNING." These words mean:

! DANGER

You can be killed or seriously injured if you don't immediately follow instructions.

! WARNING

You can be killed or seriously injured if you don't follow instructions.

All safety messages will tell you what the potential hazard is, tell you how to reduce the chance of injury, and tell you what can happen if the instructions are not followed.

ELECTRICAL POWER SUPPLY & GROUNDING REQUIREMENTS

! WARNING



Electrical Shock Hazard

Disconnect power before servicing.
Replace all panels before operating.
Failure to do so can result in death or electrical shock.

! WARNING



Electrical Shock Hazard

Plug into a grounded 3-prong outlet.
Do not remove ground prong.
Do not use an adapter.
Do not use an extension cord.
Failure to follow these instructions can result in death, fire, or electrical shock.

! WARNING



Electrical Shock Hazard

Connect green ground wire to ground screw.

Failure to do so can result in death or electrical shock.

ELECTROSTATIC DISCHARGE (ESD) SENSITIVE ELECTRONICS

ESD problems are present everywhere. ESD may damage or weaken the electronic control assembly. The new control assembly may appear to work well after repair is finished, but failure may occur at a later date due to ESD stress.

- Use an antistatic wrist strap. Connect the wrist strap to a green ground connection point or unpainted metal in the appliance; or touch your finger repeatedly to a green ground connection point or unpainted metal in the appliance.
- Before removing the part from its package, touch the antistatic bag to a green ground connection point or unpainted metal in the appliance.
- Avoid touching electronic parts or terminal contacts. Handle the electronic control assembly by the edges only.
- When repackaging the failed electronic control assembly in an antistatic bag, observe the above instructions.

MODEL & SERIAL NUMBER DESIGNATIONS

MODEL NUMBER

MODEL NUMBER	K	SB	S	25	F	K	WH	0	0
PRODUCT GROUP K = KitchenAid Brand									
PRODUCT IDENTIFICATION BR = Bottom Freezer Reversible Door SB = Counter Depth Factory Installed Trim SC = Counter Depth Architect Style SF = Counter Depth Side By Side SR = Side By Side Regular TR = Top Freezer Reversible Door									
MERCHANDISING SCHEME/SERIES									
CAPACITY/CUBIC FOOT SIZE									
MODEL FEATURES									
YEAR OF INTRODUCTION K = 2001									
COLOR CODE WH = White									
ENERGY/POWER DESIGNATOR (NUMERIC) 0 = Original, 1 = 1st Change, 2 = 2nd Change, Etc.									
ENGINEERING CHANGE (NUMERIC) 0 = Original, 1 = 1st Change, 2 = 2nd Change, Etc.									

SERIAL NUMBER

SERIAL NUMBER	S	L	30	10001
MANUFACTURING SITE S = Fort Smith, AR				
YEAR OF PRODUCTION L = 2001				
WEEK OF PRODUCTION 30th WEEK				
PRODUCT SEQUENCE NUMBER				

MODEL & SERIAL NUMBER LABEL AND TECH SHEET LOCATIONS

The Model/Serial Number Label and Tech Sheet locations are shown below.

**Model & Serial Number Location
(Refrigerator Compartment)**

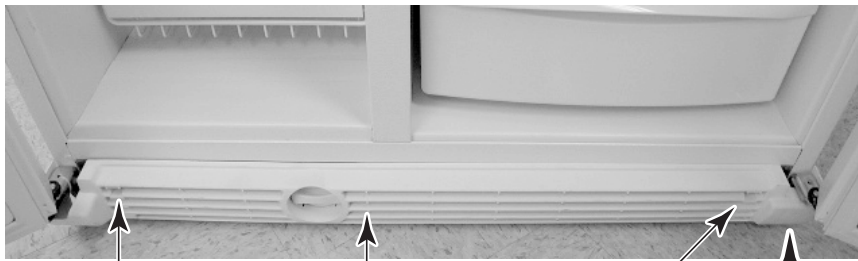

Screw

Base Grille

Screw



**Tech Sheet
Location
(Behind Base
Grille)**

SPECIFICATIONS

Model Number	KSBP25FKSS	KSBS25FKBL	KSBS25FKBT
Model Description	KitchenAid Counter Depth Factory Installed SS Panel Black Dispenser	KitchenAid Counter Depth Black Dispensing Trim Model	KitchenAid Counter Depth Biscuit Dispensing Trim Model
Size-Configuration	25" Counter Depth	25" Counter Depth	25" Counter Depth
Cabinet Height (Floor To Top Of Cabinet) (in)	71 1/2	71 1/2	71 1/2
Overall Height (Floor To Top Of Hinge Covers) (in)	71 7/8	71 7/8	71 7/8
Cabinet Width (in)	35 1/2	35 1/2	35 1/2
Overall Depth (Including Hardware & Handles) (in)	29 3/8	29 3/8	29 3/8
Depth - Less Doors/Base Grille (Minimum Opening) (in)	23 5/8	24	24
Crated Weight (lbs)	360	360	360
Cabinet Color	Black	Black	Biscuit
Cabinet Hinge Cover Color	Black	Black	Biscuit
Cabinet Center Rail Color	Black	Black	Biscuit
Cabinet Deck Rail Color	Black	Black	Biscuit
Cabinet Base Grille/Color	Black	Black	Biscuit
Cabinet Rollers	Front/Rear Adjust	Front/Rear Adjust	Front/Rear Adjust
Refrigerant	R134a	R134a	R134a
Energy Star	Energy Star	Energy Star	Energy Star
Control Type	Electronic ITC	Electronic ITC	Electronic ITC
Standard Warranty (Months)	12	12	12
Full Liner And Sealed System Warranty (Months)	60	60	60

Model Number	KSBS25FKWH	KSCS25FKSS	KSFS25FKBL
Model Description	KitchenAid Counter Depth White Dispensing Trim Model	KitchenAid Counter Depth Architect Series Stainless Wrap Dispenser	KitchenAid Counter Depth Black Freestanding Dispensing
Size-Configuration	25" Counter Depth	25" Counter Depth	25" Counter Depth
Cabinet Height (Floor To Top Of Cabinet) (in)	71 1/2	71 1/2	71 1/2
Overall Height (Floor To Top Of Hinge Covers) (in)	71 7/8	71 3/4	71 3/4
Cabinet Width (in)	35 1/2	35 1/2	35 1/2
Overall Depth (Including Hardware & Handles) (in)	29 3/8	29 1/2	29 3/8
Depth - Less Doors/Base Grille (Minimum Opening) (in)	24	24	23 5/8
Crated Weight (lbs)	360	360	360
Cabinet Color	White	Black	Black
Cabinet Hinge Cover Color	White	Black	Black
Cabinet Center Rail Color	White	Black	Black
Cabinet Deck Rail Color	White	Black	Black
Cabinet Base Grille/Color	White	Black	Black
Cabinet Rollers	Front/Rear Adjust	Front/Rear Adjust	Front/Rear Adjust
Refrigerant	R134a	R134a	R134a
Energy Star	Energy Star	Energy Star	Energy Star
Control Type	Electronic ITC		Electronic ITC
Standard Warranty (Months)	12	12	12
Full Liner And Sealed System Warranty (Months)	60	60	60

Model Number	KSFS25FKBT	KSFS25FKWH
Model Description	KitchenAid Counter Depth Biscuit Freestanding Dispensing	KitchenAid Counter Depth White Freestanding Dispensing
Size-Configuration	25' Counter Depth	25' Counter Depth
Cabinet Height (Floor To Top Of Cabinet) (in)	71 1/2	71 1/2
Overall Height (Floor To Top Of Hinge Covers) (in)	71 3/4	71 3/4
Cabinet Width (in)	35 1/2	35 1/2
Overall Depth (Including Hardware & Handles) (in)	29 3/8	29 3/8
Depth - Less Doors/Base Grille (Minimum Opening) (in)	23 5/8	23 5/8
Crated Weight (lbs)	360	360
Cabinet Color	Biscuit	White
Cabinet Hinge Cover Color	Biscuit	White
Cabinet Center Rail Color	Biscuit	White
Cabinet Deck Rail Color	Biscuit	White
Cabinet Base Grille/Color	Biscuit	White
Cabinet Rollers	Front/Rear Adjust	Front/Rear Adjust
Refrigerant	R134a	R134a
Energy Star	Energy Star	Energy Star
Control Type	Electronic ITC	Electronic ITC
Standard Warranty (Months)	12	12
Full Liner And Sealed System Warranty (Months)	60	60

REFRIGERATOR WARRANTY

ONE-YEAR FULL WARRANTY ON REFRIGERATOR

For one year from the date of purchase, when this refrigerator (excluding the water filter) is operated and maintained according to instructions attached to or furnished with the product, KitchenAid will pay for factory specified replacement parts and repair labor costs to correct defects in materials or workmanship. Service must be provided by a KitchenAid designated service company. On models with a water filter: 30 day limited warranty on water filter. For 30 days from the date of purchase, when this filter is operated and maintained according to instructions attached to or furnished with the product, KitchenAid will pay for replacement parts to correct defects in materials and workmanship.

SECOND THROUGH FIFTH YEAR LIMITED WARRANTY

In second through fifth years from the date of purchase, KitchenAid will pay for replacement or repair of the refrigerator/freezer cavity liner (including labor costs) if the part cracks due to defective materials or workmanship. Service must be provided by a KitchenAid designated service company. Also, KitchenAid will pay for factory specified replacement parts and repair labor costs to correct defects in materials or workmanship in the sealed refrigeration system. These parts are: compressor, evaporator, condenser, dryer, and connecting tubing. Service must be performed by a KitchenAid designated service company.

SIXTH THROUGH TENTH YEAR LIMITED WARRANTY

In sixth through tenth years from date of purchase, KitchenAid will pay for factory specified replacement parts to correct defects in materials or workmanship in the sealed refrigeration system. These parts are: compressor, evaporator, condenser, dryer, and connecting tubing.

LIMITED LIFETIME WARRANTY

In second year through life of product from date of purchase, KitchenAid will pay for replacement of all SLIDE N LOCK™ Door Bins and SLIDE N LOCK™ Can Racks due to defective materials or workmanship.

KitchenAid will not pay for:

1. Service calls to correct the installation of the refrigerator, to instruct you how to use the refrigerator, to replace house fuses or correct house wiring or plumbing, to replace light bulbs, or replacement water filters other than as noted above.
2. Repairs when the refrigerator is used in other than normal, single-family household use.
3. Pickup and delivery. The refrigerator is designed to be repaired in the home.
4. Damage resulting from accident, alteration, misuse, abuse, fire, flood, improper installation, acts of God, or use of products not approved by KitchenAid or KitchenAid Canada.
5. Any food loss due to product failure.
6. Repairs to parts or systems resulting from unauthorized modifications made to the appliance.
7. Replacement parts or repair labor costs for units operated outside the United States or Canada.
8. In Canada, travel or transportation expenses for customers who reside in remote areas.
9. Any labor costs during the limited warranty period.

KITCHENAID AND KITCHENAID CANADA SHALL NOT BE LIABLE FOR INCIDENTAL OR CONSEQUENTIAL DAMAGES.

Some states or provinces do not allow the exclusion or limitation of incidental or consequential damages, so this exclusion or limitation may not apply to you. This warranty gives you specific legal rights, and you may also have other rights which vary from state to state or province to province.

Outside the 50 United States and Canada, this warranty does not apply. Contact the authorized KitchenAid dealer to determine if another warranty applies.

If you need service, first see the "Troubleshooting" section of the Use and Care Guide. After checking "Troubleshooting," additional help can be found by checking the "Assistance or Service" section, or by calling the KitchenAid Customer Interaction Center, **1-800-422-1230** (toll-free), from anywhere in the U.S.A. In Canada, contact the designated KitchenAid Canada Appliance service company, or call **1-800-807-6777**.

— NOTES —

INSTALLATION INFORMATION

LEVELING THE REFRIGERATOR

IMPORTANT: All four leveling legs must contact the floor to support and stabilize the full weight of the refrigerator.

Base Grille Removal

1. Open the refrigerator doors.

NOTE: Do not remove the Tech Sheets fastened behind the grille.

2. Remove the screws from the base grille and remove the grille.

Adjusting The Rollers

The roller adjusting bolts are located behind the base grille. The refrigerator has four adjustable rollers: two in front, and two in the rear.

There are two sets of roller adjusting bolts found at the base of the refrigerator on each side. The rear leveling bolt (1) is yellow, and the front leveling bolt (2) is silver.

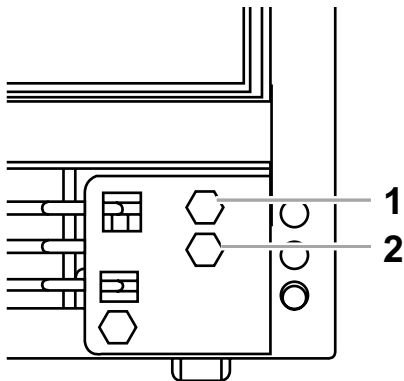

NOTE: Be careful not to unscrew the leveling bolts too much when lowering the refrigerator. The bolt head will start to come away from the refrigerator when it is in the lowest position. If the bolt comes out of the rear roller bracket, the compartment access cover on the back of the refrigerator will have to be removed to reinstall the bolt.

1. Use a 1/2" (12.70 mm) socket wrench to adjust the leveling bolts. Turn the leveling bolt to the right to raise that side of the refrigerator, or turn the leveling bolt to the left to lower that side. It may take several turns of the leveling bolts to adjust the tilt of the refrigerator.
2. Adjust the front leveling bolt so that the top of the refrigerator is parallel with the cabinet above the refrigerator.

For standard cabinets, leave approximately 1/8" (3.18 mm) gap between the top hinges and the cabinet.

For full-overlay cabinets, leave a 1/4" (6.35 mm) gap for leveling.

If you do not have a cabinet above the refrigerator, adjust the refrigerator to make it level.

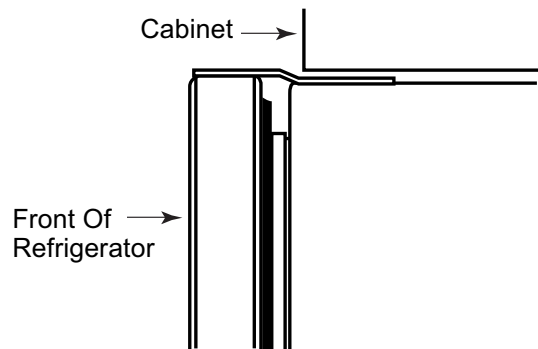

3. Adjust the rear leveling bolt and level the refrigerator with the side cabinets, or with the cabinet end panels.
4. If needed, use the four leveling bolts to raise the refrigerator to close the gap between the refrigerator top hinge, and the cabinet opening. Check to make sure that all four rollers still touch the floor, and that the cabinet doors above the refrigerator open all the way.

— NOTES —

THEORY OF OPERATION

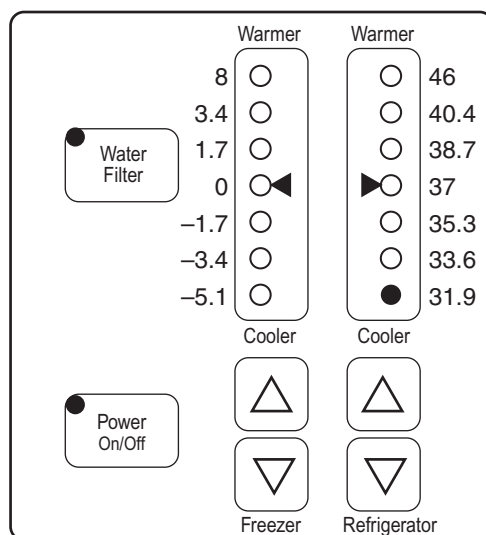

THE ELECTRONIC CONTROL PANEL

OVERVIEW

The KitchenAid Counter Depth Refrigerator Constant Flow Temperature Management System uses two thermistors to monitor temperature changes inside the refrigerator and freezer compartments. The electronic control manages the operation of the variable capacity compressor (VCC), a variable speed evaporator fan motor, and a variable position air door. The air door allows independent temperature control of the refrigerator and freezer compartments.

The electronic control seeks the most efficient means possible to maintain temperatures as it controls the operation and speed of the compressor and the evaporator fan motor. Higher fan speed is used before increasing the compressor speed to minimize power consumption. A nearly constant run time is sought at the lowest possible fan and compressor speed.

NOTE: The illustration above shows the actual temperature that is associated with each corresponding LED.

Freezer temperatures can be set from 8°F to -5°F (-13°C to -21°C). Refrigerator temperatures can be set from 46°F to 32°F, (8°C to 0°C).

The Adaptive Defrost Control (ADC) portion of the electronic control utilizes “pulsed defrost” technology to perform the defrost function (see page 3-4).

The electronic control monitors the water valve for total elapsed time and gallons of water used. The Water Filter Indicator (WFI) LED changes color to indicate that the filter needs to be replaced.

Pressing the Temperature Up or Down adjustment keys will change the refrigerator and freezer settings. One of seven (7) LEDs light to display the refrigerator and the freezer settings.

TEMPERATURE CONTROL

The electronic control checks the resistance of the thermistors, and compares it to both the customer temperature settings and the last thermistor reading taken. This information is used to determine when to begin a cooling operation, and if a change is necessary in the damper setting, or the evaporator fan or compressor speed.

When a warm refrigerator is first put into a cooling mode, the air door partially opens, and the compressor and evaporator fan motors start to run at maximum rpm. The air door will gradually move to its fully open position.

As the actual temperature in the refrigerator nears the selected temperature setting, the electronic control compares the temperatures in both compartments. The compartment that has the greatest need for cooling, will control the speed of the evaporator fan motor.

Freezer Temperature Control — Temperature Increasing

When the freezer calls for cooling, the compressor begins to run at minimum rpm, (see the chart on page 3-3), and the evaporator fan begins to run at 2000 rpm. The compressor and evaporator speeds are continuously updated. Speed changes are made based on:

- The difference between the actual temperature and the selected temperature settings.
- The rate of temperature change.

If the temperature increases 4°F above the selected temperature setting, the evaporator fan speed begins to gradually increase. The evaporator fan motor reaches the maximum speed of 3000 rpm at 5°F above the selected temperature setting, and the compressor speed begins to gradually increase. A maximum compressor speed of 4500 rpm will be reached at 9°F above the selected temperature setting.

Freezer Temperature Control — Temperature Decreasing

When the freezer temperature begins to decrease, the process will reverse. The compressor speed decreases, followed by the evaporator fan speed.

Refrigerator Temperature Control — Temperature Increasing

When the refrigerator calls for cooling while the freezer is satisfied, the air door begins to open, and the evaporator fan starts to run at minimum speed. If the temperature continues to rise, the air door will continue to open. If the temperature continues to rise after the air door is fully open, the evaporator fan speed will gradually increase to a maximum of 3000 rpm. If the temperature continues to rise, the compressor starts to run, or if it has already been running, begins to increase in speed.

Refrigerator Temperature Control — Temperature Decreasing

As the refrigerator temperature approaches the selected setting, the control compares the temperatures in both compartments to determine which compartment will control the fan speed. If the freezer is further from the selected temperature setting, it controls the fan speed, and the air door begins to close, thus reducing the airflow to the refrigerator.

If the freezer is satisfied, the air door remains open, and the fan speed begins to decrease. When the selected temperature setting is reached, the air door closes.

COMPRESSOR

The main control board supplies a 5 vdc, peak-to-peak square wave, at 54 to 150 Hz, to the inverter board. A standard VOM will read approximately 2.5 vdc. The inverter board supplies the variable capacity compressor with three-phase 230 vac. Varying the frequency to the inverter board, and not the voltage, changes the speed of the compressor. The compressor can run at speeds of 1620 to 4500 rpm.

NOTE: It is not necessary, nor is it recommended, to test the output of the inverter board.

While the compressor is running, its speed is continuously updated. Speed is determined after analyzing two factors:

- The difference between the actual temperature and the selected temperature settings.
- The rate of temperature change.

Minimum compressor speed is based on the freezer's selected temperature setting, as shown in the following chart.

Freezer Temperature Setting	Compressor Minimum Speed
#1 - #5	1620 rpm
# 6	1800 rpm
# 7	2200 rpm

The compressor generally cycles on and off according to the cut-in and cut-out temperatures of the freezer, however, the refrigerator can turn on the compressor if the evaporator fan is at maximum speed and the refrigerator temperatures are not dropping.

COMPRESSOR PROTECTION

To protect the compressor and maintain efficiency, minimum compressor off time is programmed into the control. When the compressor turns off, a minimum of 7 minutes must elapse before allowing a restart.

The inverter board utilizes a current limiting device and thermal protection that eliminates the need for a compressor mounted thermal protector.

EVAPORATOR FAN MOTOR

The evaporator fan motor is a 12 vdc, variable speed motor. The motor has four wires:

- A blue wire provides feedback to monitor the speed of the motor.
- A red wire provides a constant 12 vdc.
- A yellow wire provides a variable voltage of between 5 vdc and 17 vdc to control the motor speed from 2000 to 3000 rpm.
- A white wire provides a common return.

EVAPORATOR FAN & AIR DOOR DELAY

After defrost, an evaporator fan delay prevents unnecessary movement of warm, moist air through the refrigerator, by chilling the evaporator prior to starting the fan. Immediately after defrost drip time, the compressor starts at 4500 rpm, but the evaporator fan is delayed for 8 minutes. The air door remains closed for 8 minutes following defrost.

AIR DOOR

The air door is driven by a reversible DC stepper motor. The motor operates on a 12 vdc, peak-to-peak square wave. Voltage is delivered to the air door in a series of short pulses. It is not possible to obtain a reliable voltage reading with a VOM.

Separate windings are used to move the air door open or closed. The door can be in any one of 1800 positions from 0 to 90 degrees. The air door is used to fine-tune the airflow to the refrigerator.

The refrigerator temperature determines the opening of the air door. When the refrigerator requires cooling, if the evaporator fan motor is already running for the freezer, the air door partially opens, and then adjusts, if necessary. While the refrigerator is cooling, the door will be adjusting continuously to maintain or recover refrigerator temperature.

ADAPTIVE DEFROST

The adaptive defrost control allows the unit to enter a defrost mode only when it is needed. When powered up for the first time, the control initiates a defrost cycle after 8 hours of compressor run time. By monitoring the duration of defrost heating time and compressor run time, the control will continuously adapt the time between defrosts to optimize efficiency. Time between defrost periods will vary between 8 and 100+ hours.

Defrost will occur immediately when the compressor has run at 4000 rpm or greater for 1 hour, and 8 hours have elapsed since the last defrost.

PULSED DEFROST

For the first 7 minutes of defrost, the heater is on continuously. It will then cycle off for 1 minute, and back on for 2 minutes. The heater will continue to cycle at this ratio until the bimetal opens, or until 33 minutes has elapsed. At this point, heat is discontinued, and a 4-minute "drip time" begins. This allows the water to drain before the unit returns to a cooling mode. Maximum defrost time, (pulsed heat on/off time + drip time) is 37 minutes.

When entering a defrost cycle, if the bimetal is open, the time to defrost is reset to 8 hours, and the control will time through the entire 37 minute defrost period. During diagnostics this will allow a technician time to look for heater operation, and if necessary, bypass the bimetal.

POWER INTERRUPTION

After a power interruption, the following events will occur:

- The unit returns to the same operating mode and settings in use prior to the power interruption. If the unit was off, it remains off.
- Initially, the compressor, evaporator fan, and condenser fan motors will be off.
- The air door will close, and then adjust to the proper opening. The evaporator fan starts when the air door opens.
- The adaptive defrost control resets the compressor run time counter to 0, and if the freezer is above 20°F, the time to defrost is set to 8 hours.
- If the freezer temperature is below 12°F, the compressor starts after a delay of 7 minutes. If the freezer temperature is above 12°F, the compressor starts immediately.

FAILURE DEFAULTS

In the event of a thermistor, or keypad failure, the control uses one of the following default modes, which will continue until the failure is corrected.

Refrigerator Thermistor

If the control senses an open or a shorted thermistor, the air door and the evaporator fan motor will begin to operate on a timed on and off cycle, based on current selected temperature settings. The evaporator fan motor will run when the air door is open.

At mid-settings of 37°F / 0°F, the air door will open for 16 minutes, and close for 30 minutes. Setting the freezer colder, or the refrigerator warmer, will reduce the door-open time. Setting the freezer warmer, or the refrigerator colder, will increase the door-open time.

Freezer Thermistor

If the control senses an open or a shorted thermistor, the compressor and the evaporator fan motor will begin to operate on a timed on and off cycle. The cycle time is based on current selected temperature settings.

At mid-settings of 37°F / 0°F, the compressor and the evaporator fan motors will run for 35 minutes, and be off for 25 minutes. Setting the freezer colder will increase the run time. Setting the freezer warmer will decrease the run time.

The compressor will run at minimum speed. The evaporator fan will also run at minimum speed, unless the refrigerator compartment requests a higher speed.

Keypad

If the control detects that the keypad is not working, it reverts to the default temperature settings of 37°F in the refrigerator, and 0°F in the freezer.

Evaporator Fan Motor

If the evaporator fan motor malfunctions, the compressor will run at 4500 rpm for an indefinite period, except during the defrost periods.

ELECTRONIC CONTROL THERMAL SHUTOFF

The electronic control utilizes an on-board thermistor to shut the compressor off if the temperature rises above 160°F (71°C). When the temperature drops to 130°F (55°C), the compressor returns to normal operation. This cycle continues indefinitely until the cause of the high temperature has been corrected.

AIR CIRCULATION

In order to ensure the proper refrigerator and freezer compartment temperatures, air must be able to flow between the two sections.

Air enters the bottom of the freezer compartment and moves up through the evaporator. Some of the cooled air from the evaporator is directed back into the freezer, and the rest goes into the refrigerator through the motorized air door. The refrigerator air then returns to the freezer through the bottom air return (see the illustration below).

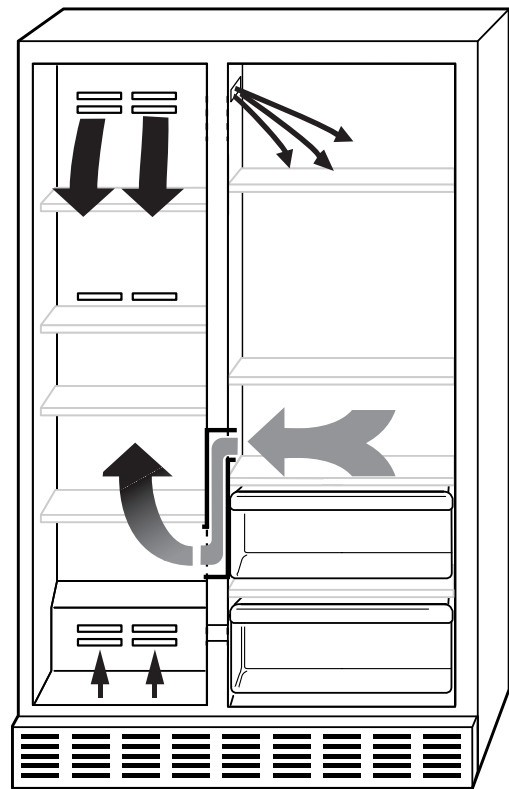

It is important not to block any of the vents with food items. If the vents are blocked, airflow will be restricted, and the temperature management system will not function properly.

IMPORTANT: Because air circulates between both sections, any odors formed in one section will transfer to the other. Keep both sections clean, and wrap or cover foods tightly to prevent odors from occurring.

— NOTES —

COMPONENT ACCESS

This section instructs you on how to service each component inside the refrigerator/freezer. The components and their locations are shown below.

COMPONENT LOCATIONS

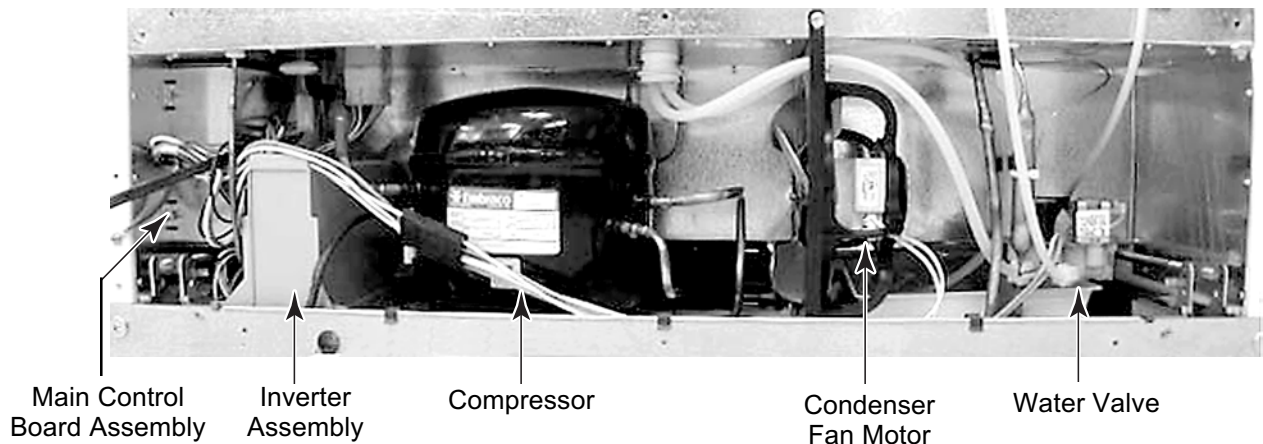
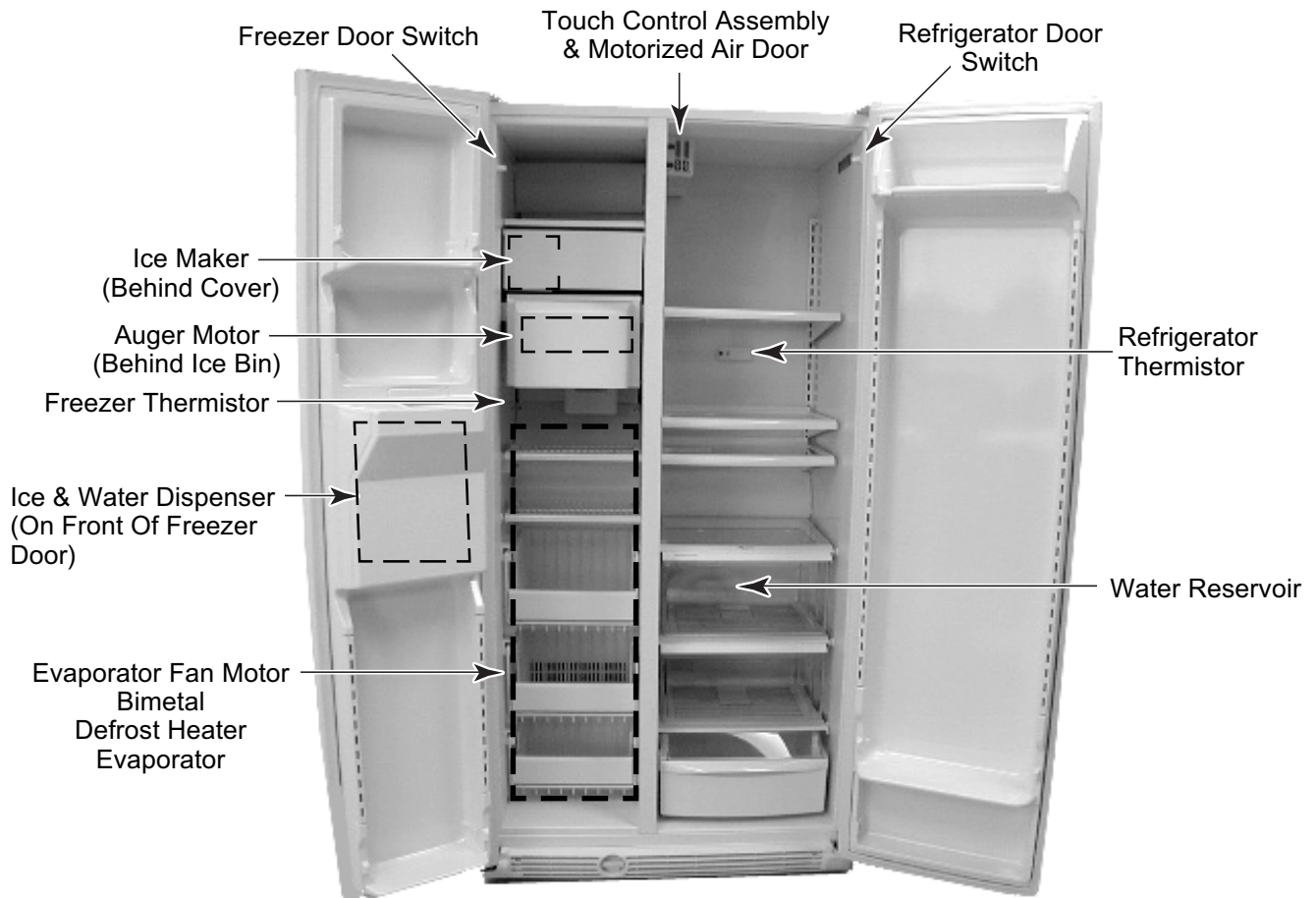

REMOVING THE TOUCH/DISPLAY BOARD, THE INSERT AND OVERLAY, & THE MOTORIZED AIR DOOR

!WARNING



Electrical Shock Hazard
Disconnect power before servicing.
Replace all panels before operating.
Failure to do so can result in death or electrical shock.

NOTE: Sharp edges may be present.

1. Unplug the refrigerator or disconnect the power.
2. Open the refrigerator door and remove the items from the top shelf. If necessary, remove the top shelf so you can easily access the touch control assembly. The touch control assembly location is shown below.

Touch Control Assembly



3. Remove the light shield. To do this, place your finger into the half-moon slot at the bottom of the shield and pull out, then pull down to disengage the corners from the control box.

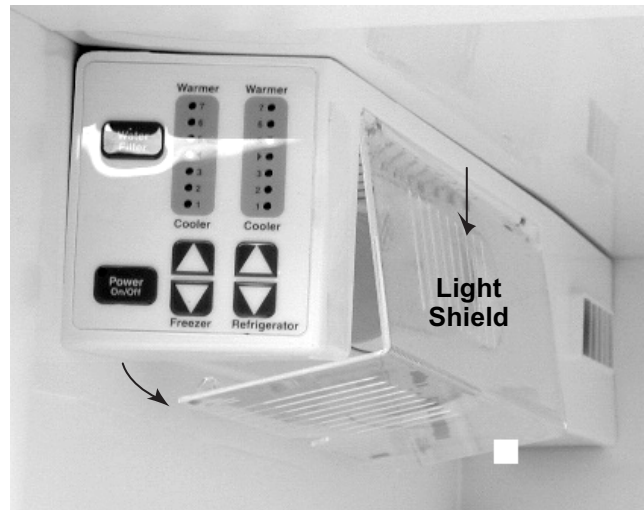

4. Remove the bulb from the socket.
5. Remove the hex-head screw from the touch control assembly, then pull the assembly forward to unhook it from the refrigerator liner, and down to remove it.

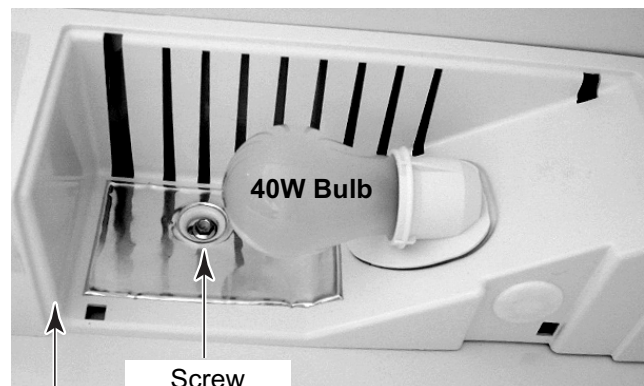

Touch Control Assembly

6. Disconnect the two wires from the light socket and the 3-wire connector from the touch/display board, and remove the touch control assembly.

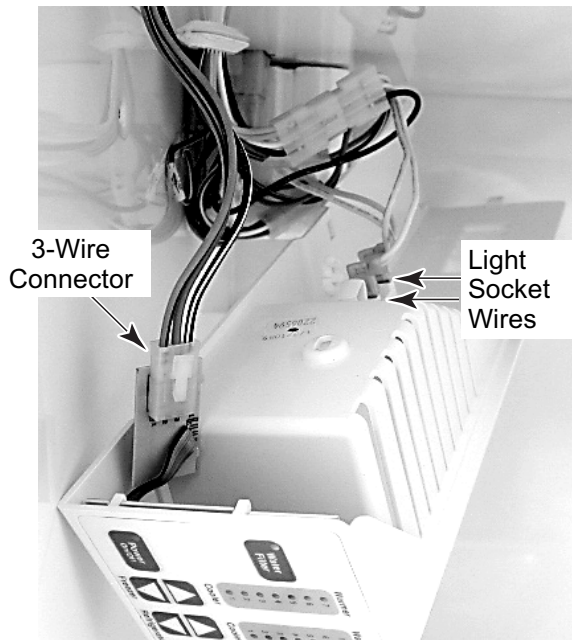

7. To remove the touch/display board, unclip it from the touch control housing and remove the board.

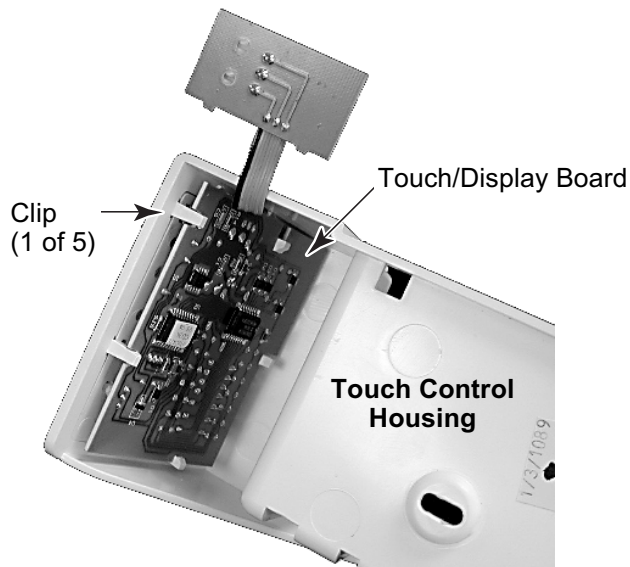

8. To remove the insert and overlay, press the locking clips, and push the insert and overlay out of the touch control housing opening.

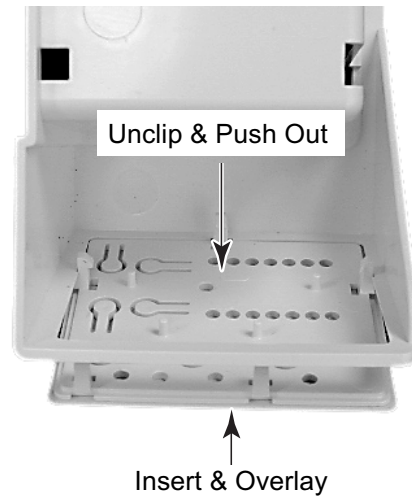

9. To remove the motorized air door:
 - a) Pull the cover and motorized air door away from the refrigerator liner.

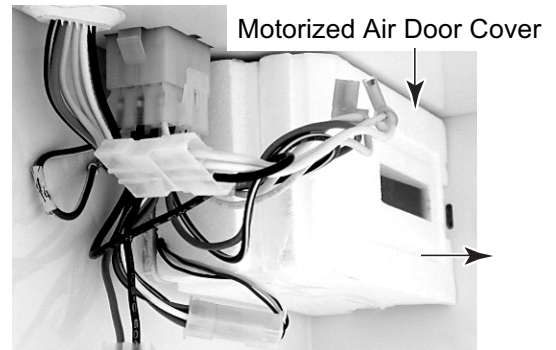

- b) Disconnect the wire connector from the motorized air door.



REMOVING A THERMISTOR

! WARNING



Electrical Shock Hazard
Disconnect power before servicing.
Replace all panels before operating.
Failure to do so can result in death or electrical shock.

NOTE: Sharp edges may be present.

1. Unplug the refrigerator or disconnect the power.

NOTE: The refrigerator and freezer thermistors are identical and are removed in the same manner.

2. Depending on the thermistor, open the freezer or refrigerator door, and remove any items from the shelf that are in front of the thermistor. It may be necessary to remove the shelf as well. The thermistor locations are shown below.



Freezer Thermistor

Refrigerator Thermistor

3. Remove the hex-head screw from the thermistor cover. Pull the cover forward at the screw end, and unhook the tab from the slot at the other end of the thermistor cover.

Screw

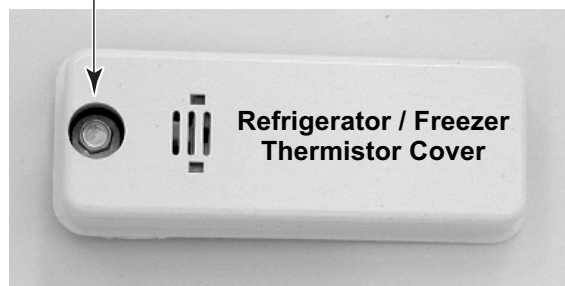

4. Disconnect the 2-wire connector and remove the thermistor.

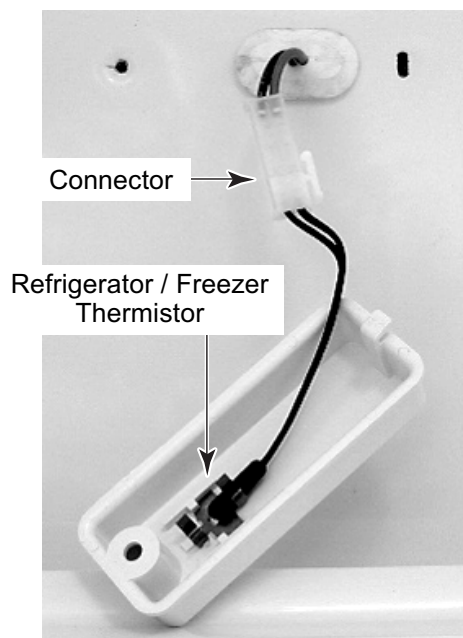

REMOVING A DOOR SWITCH

⚠ WARNING



Electrical Shock Hazard
Disconnect power before servicing.
Replace all panels before operating.
Failure to do so can result in death or electrical shock.

NOTE: Sharp edges may be present.

1. Unplug the refrigerator or disconnect the power.

NOTE: The refrigerator and freezer door switches are identical and are removed in the same manner.

2. Depending on the door switch, open the freezer or refrigerator door. The door switch locations are shown below.

Freezer Door Switch

Refrigerator Door Switch



3. Use a small-bladed screwdriver and pry the door switch out of the freezer/refrigerator liner opening.

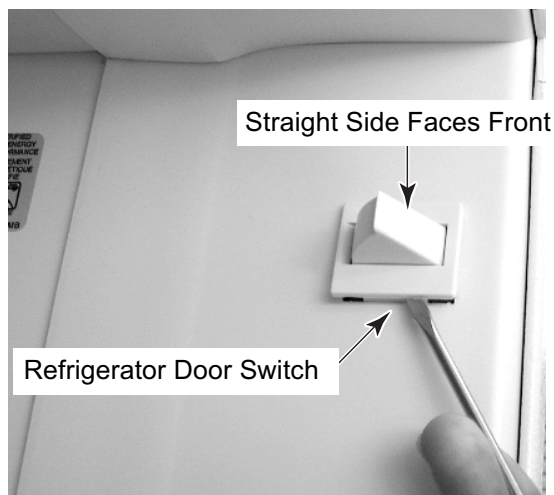

4. Disconnect the wires from the door switch terminals.



REASSEMBLY NOTE: Be sure to position either door switch with the straight side facing the front (see the top photo) before you press it into the opening.

REMOVING A LIGHT SOCKET

!WARNING



Electrical Shock Hazard

**Disconnect power before servicing.
Replace all panels before operating.
Failure to do so can result in death or electrical shock.**

NOTE: Sharp edges may be present.

1. Unplug the refrigerator or disconnect the power.

NOTE: The refrigerator and freezer light sockets are identical and are removed in the same manner.

2. Depending on the light, open the freezer or refrigerator door, and remove any items from the shelf that are in front of the light. It may be necessary to remove the shelf as well. The light locations are shown below.



3. Remove the light shield.
4. Remove the bulb from the socket.
5. Grasp the light socket by the rounded portion and pull out on the narrow end, while pressing the locking arm (see the photo below) with a screwdriver blade. Pull out on the socket until it disengages from the opening.

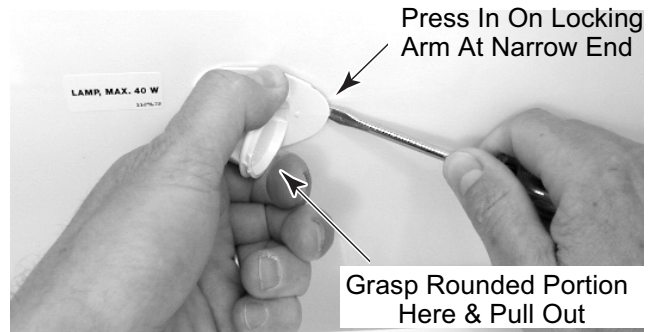

6. Disconnect the two wires from the light socket terminals.

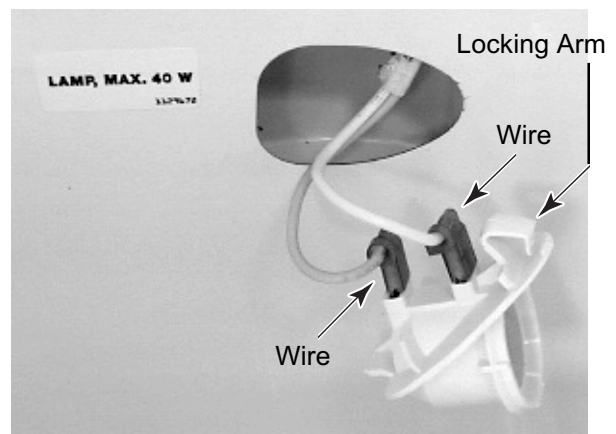

REMOVING THE WATER RESERVOIR

! WARNING



Electrical Shock Hazard
Disconnect power before servicing.
Replace all panels before operating.
Failure to do so can result in death or electrical shock.

NOTE: Sharp edges may be present.

1. Unplug the refrigerator or disconnect the power.

NOTE: The water reservoir location is shown below.



Water Reservoir On Rear Liner

NOTE: If the water reservoir tubing located inside the refrigerator compartment becomes damaged, you can cut and splice a new reservoir in its place using two 5/16" unions (#4388201). If the tubing located under the refrigerator is defective, it will be necessary to remove the unit from its mounting location to repair it. If that is the case, use the following procedure.

2. Open the refrigerator and freezer doors and remove the two screws from the base grille and remove the grille from the front of the unit.



Screw Base Grille Screw

3. Place a container near the base grille to catch the water in the next step.
4. Disconnect the water dispenser fill tube from the union, slide the nut off the end of the tube, and allow the water to drain into the container.

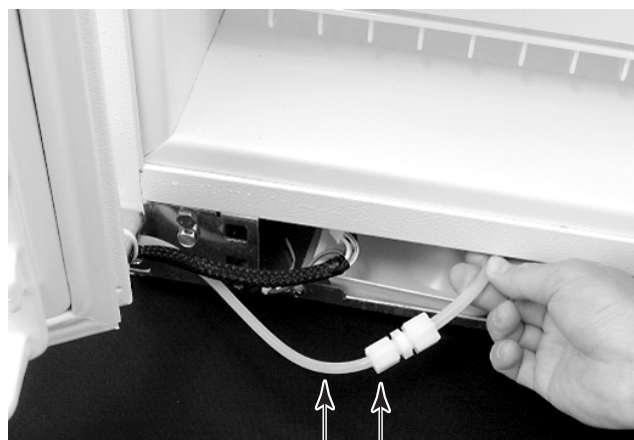

Water Dispenser Tubing & Union Nut

Continued on the next page.

5. Pull the unit out of its mounting location so you can access the unit compartment cover.
6. At the rear of the unit, remove the hex-head screws from the unit compartment cover and remove the cover.

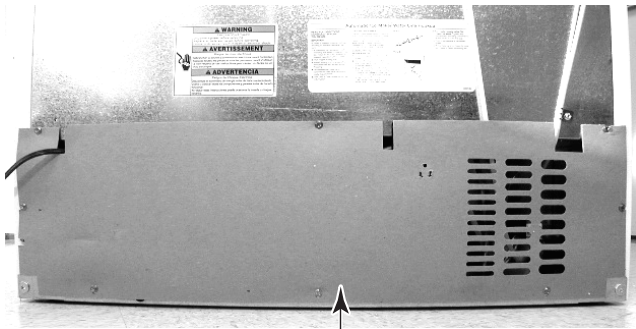

Unit Compartment Cover

7. Disconnect the nut on the reservoir inlet tubing coming from the water valve, and slide the nut off the end of the tubing.

Condenser Fan Motor Bracket

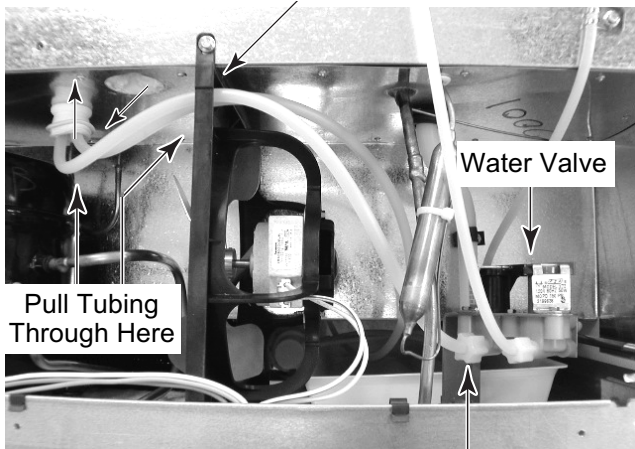

Water Reservoir Inlet Tubing Nut

8. Pull the ends of the water reservoir tubing through the condenser fan motor bracket.
9. Remove the crisper and bottom shelves from the refrigerator compartment.
10. Remove the hex-head screw from the water reservoir tubing strap.
11. Pull the ends of the water reservoir tubing through the grommet.

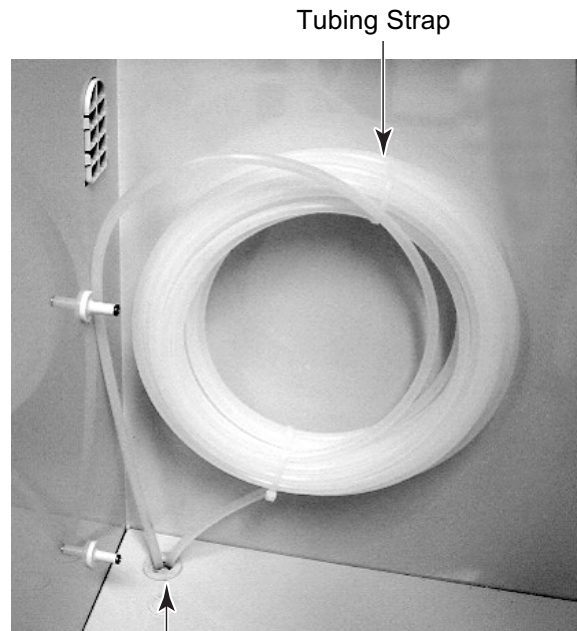

Pull Tubing Up Through Grommet

REASSEMBLY NOTE: Make sure that you route the water reservoir tubing through the condenser fan motor bracket to the water valve and the water dispenser union (see the bottom left photo). Do not allow the tubing to contact the hot discharge lines coming from the compressor.

REMOVING THE ICE MAKER AND THE AUGER MOTOR & CRUSH/CUBE SOLENOID

⚠ WARNING



Electrical Shock Hazard
Disconnect power before servicing.
Replace all panels before operating.
Failure to do so can result in death or electrical shock.

NOTE: Sharp edges may be present.

1. Unplug the refrigerator or disconnect the power.
2. Open the freezer door and remove the ice maker shelf and the ice bin.

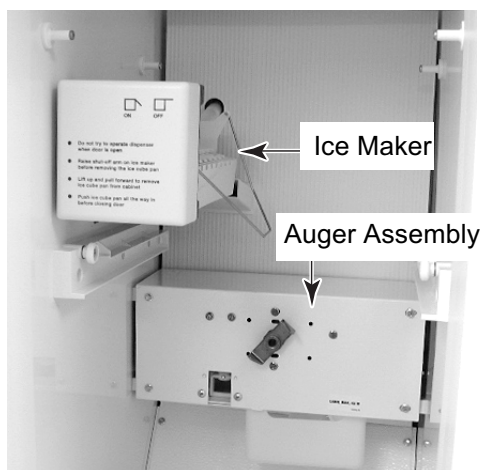

3. To remove the ice maker:

- a) Remove the bottom screw from the ice maker bracket.

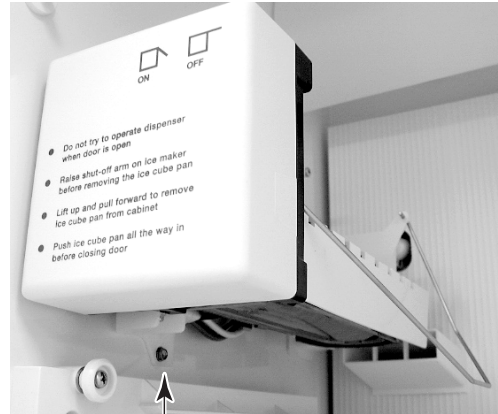

Bottom Bracket Screw

- b) Loosen the two top ice maker bracket screws.
- c) Lift the brackets at the top of the ice maker off the screws, disconnect the electrical harness connector, and remove the ice maker.

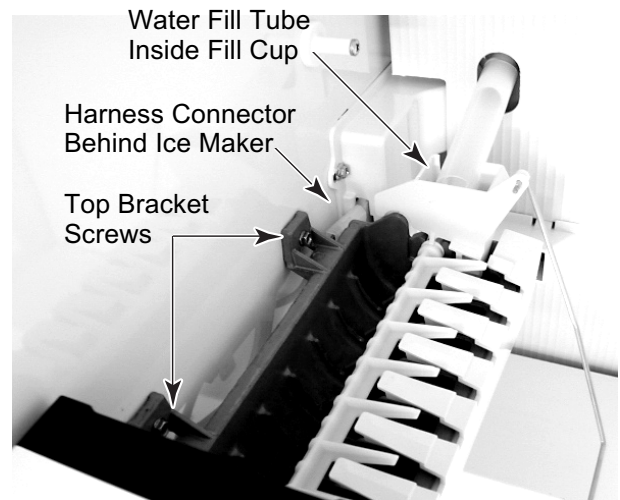

NOTE: When you reinstall the ice maker, make sure that the end of the water fill tube is positioned inside the fill cup (see the photo above).

Continued on the next page.

4. **To remove the auger motor or crush/cube solenoid:**

- a) Remove the light shield and the bulb from the socket.
- b) Remove the four hex-head screws from the auger assembly and pull the assembly forward.

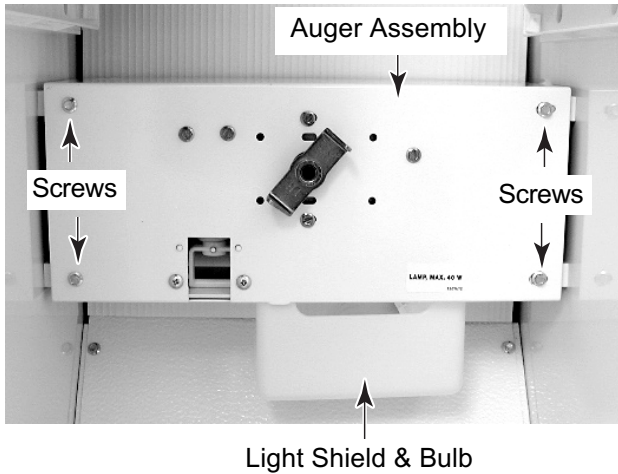

- c) Remove the green ground wire screw, disconnect the electrical harness connector, and remove the auger assembly.

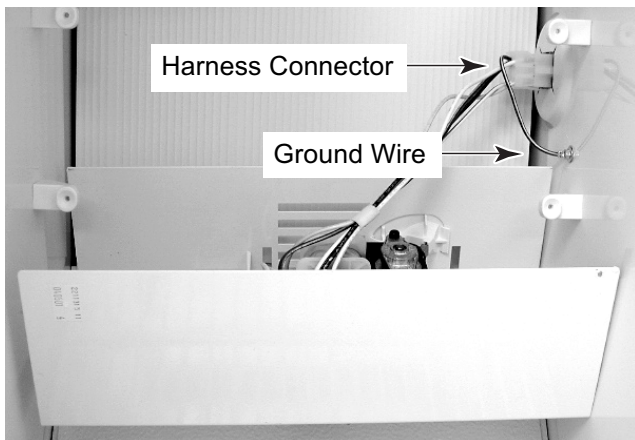

- d) To remove the auger, unscrew the drive coupler (left-hand threads) and remove it from the motor shaft.
- e) Remove the three auger motor hex-head screws from the housing.

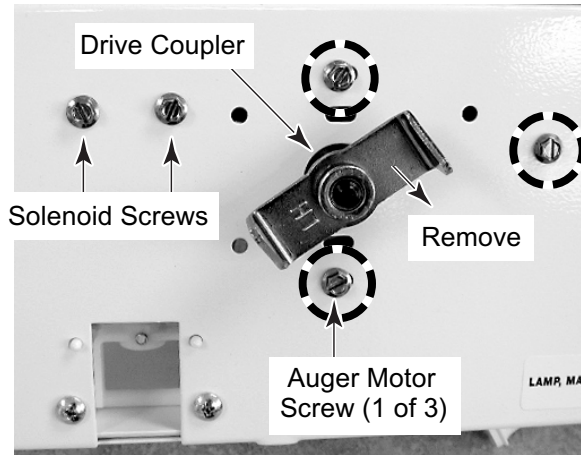

- f) Disconnect the wires from the auger motor terminals.
- g) To remove the crush/cube solenoid, remove the two hex-head mounting screws from the housing (see above).
- h) Disconnect the wires from the solenoid terminals.

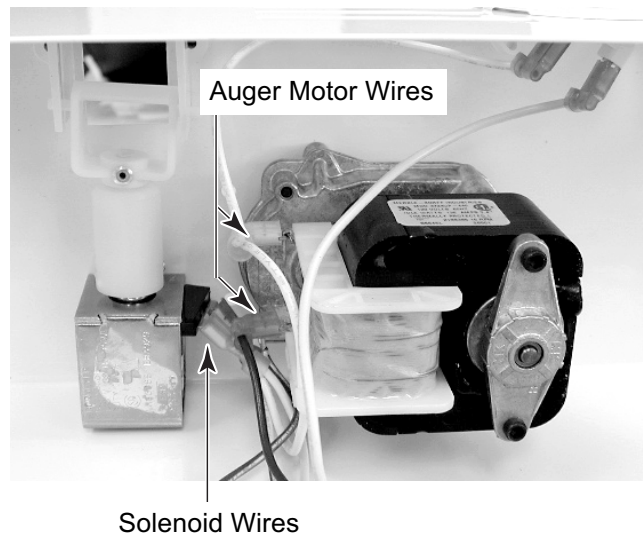

Electrical Shock Hazard
Connect green ground wire to ground screw.
Failure to do so can result in death or electrical shock.

REMOVING THE EVAPORATOR FAN MOTOR, THE BIMETAL, THE DEFROST HEATER, & THE EVAPORATOR

!WARNING



Electrical Shock Hazard
Disconnect power before servicing.
Replace all panels before operating.
Failure to do so can result in death or electrical shock.

NOTE: Sharp edges may be present.

1. Unplug the refrigerator or disconnect the power.
2. Open the freezer door and remove the ice bin, shelves, and freezer baskets.



3. Remove the light shield and bulb from the freezer light.
4. Remove the phillips screw from each of the two top rear shelf support studs and remove the studs.
5. Remove the eight hex-head screws from the evaporator cover.

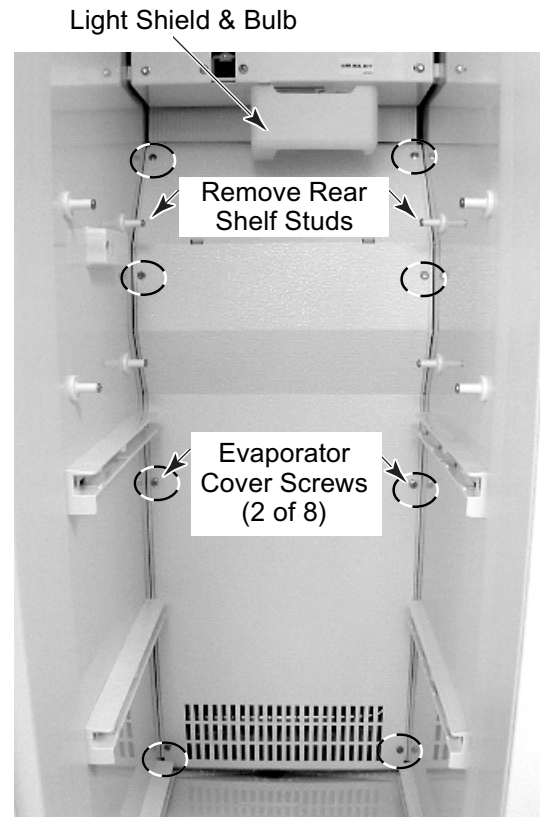

Continued on the next page.

6. Lift and unhook the two evaporator cover tabs, then lower the cover until the top edge clears the air duct, and slide the cover up and out of the freezer.

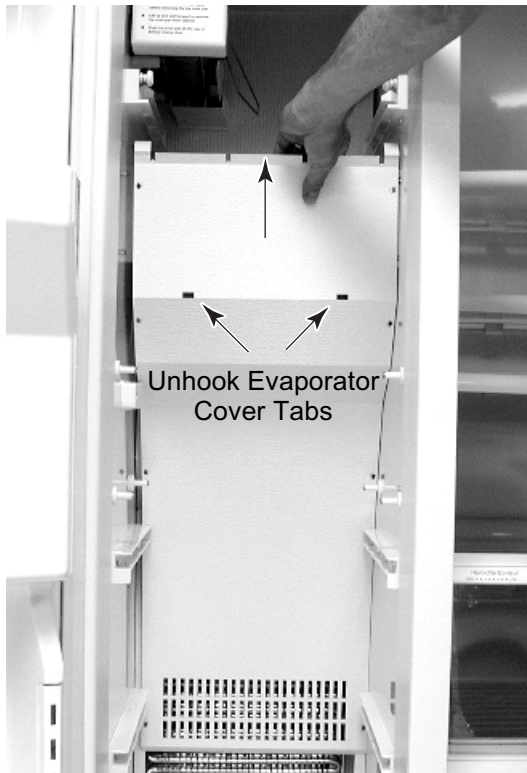

7. **To remove the evaporator fan motor:**
- a) Pull the fan blade off the motor shaft.
 - b) Unclip the motor.
 - c) Disconnect the wire connector from the terminals.

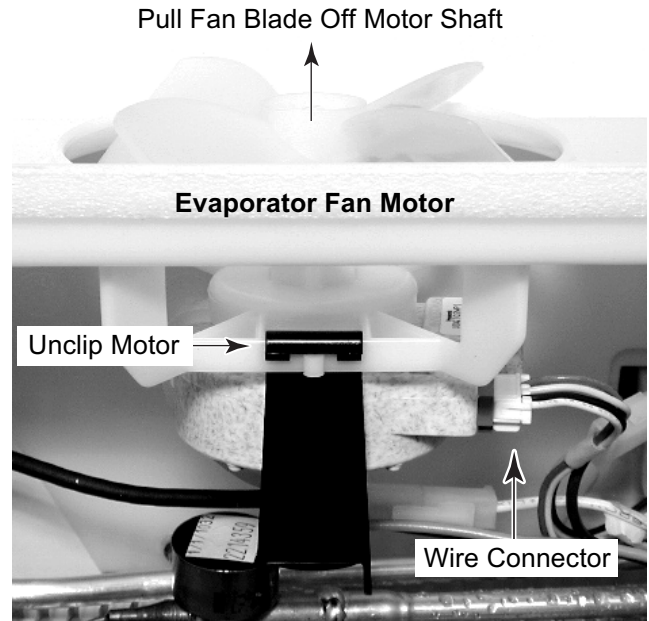

- d) Remove the isolator from the motor.

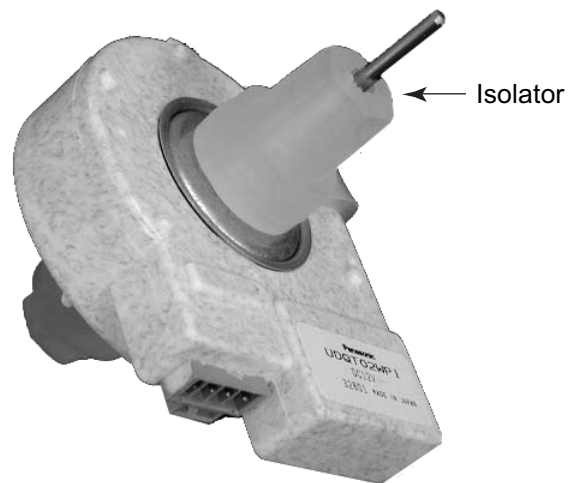
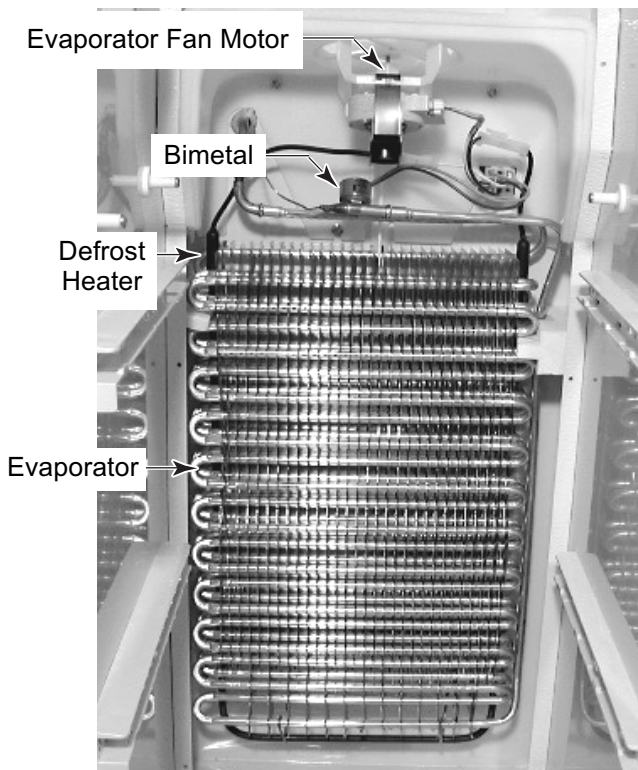

8. **To remove the bimetal:**

- a) Unclip the bimetal from the evaporator inlet tubing.
- b) Follow the instructions that were supplied with the replacement bimetal to connect the wires.

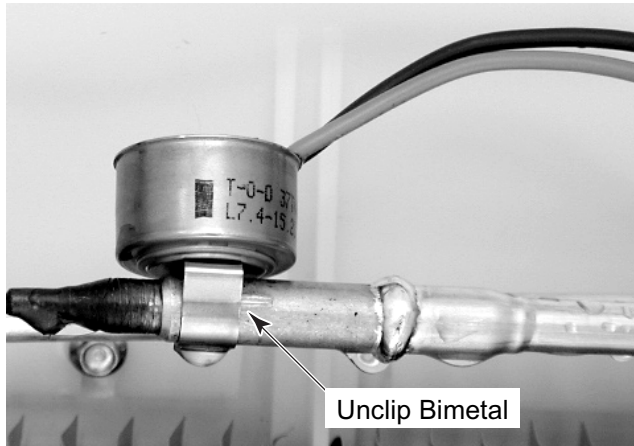

9. **To remove the defrost heater:**

- a) Remove the four hex-head screws from the right evaporator cover mounting bracket and remove the bracket.



- b) Disconnect the two defrost heater wires and the main terminal connector.
- c) Unclip the bimetal from the evaporator inlet tubing.
- d) Remove the two top hex-head screws and loosen the bottom screw on the evaporator fan motor shroud, and remove the shroud and the two foam inserts.

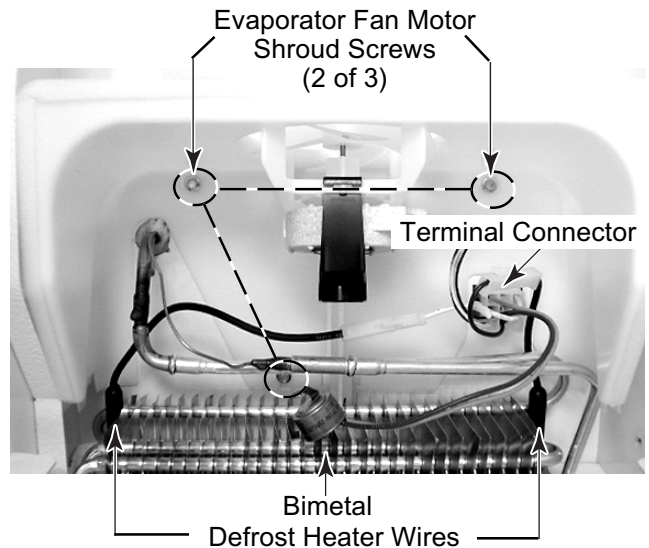

- e) Remove the foam block from the right side of the evaporator.

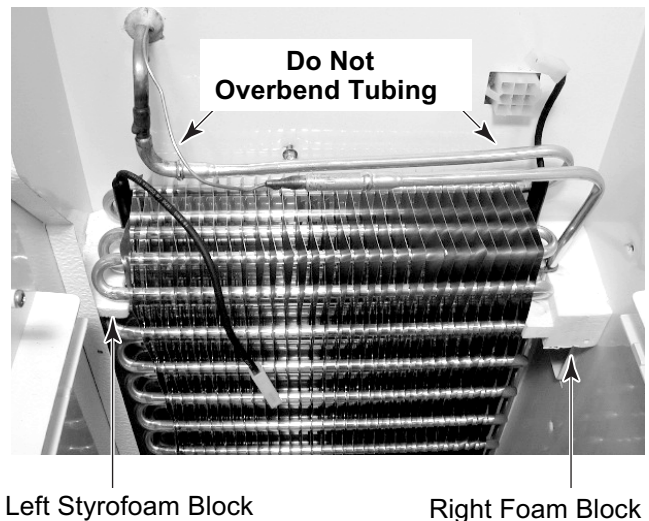

NOTE: Be very careful not to over-bend the refrigerant tubing.

- f) Lift the evaporator off the two bottom hangers and remove the styrofoam air block from the left side.

Continued on the next page.

- g) Pull the bottom of the evaporator toward the front of the unit and remove the two hangers from the defrost heater.

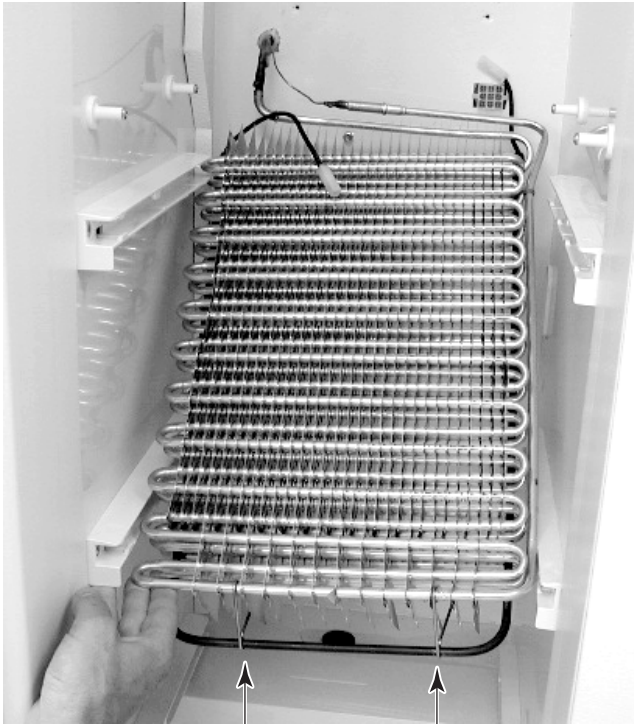

Defrost Heater Hangers

- h) Slide the defrost heater off the evaporator.



Defrost Heater

10. **To remove the evaporator:**

- a) Remove the defrost heater from the evaporator (see page 4-13).
- b) Access the sealed system and discharge the refrigerant into an approved recovery system.
- c) Remove and replace the evaporator.

REASSEMBLY NOTES:

1. The evaporator fan motor shroud has a foam insert on each side. Note the position of these inserts in the photo and reinstall them correctly, as shown.

Evaporator Fan Motor Shroud

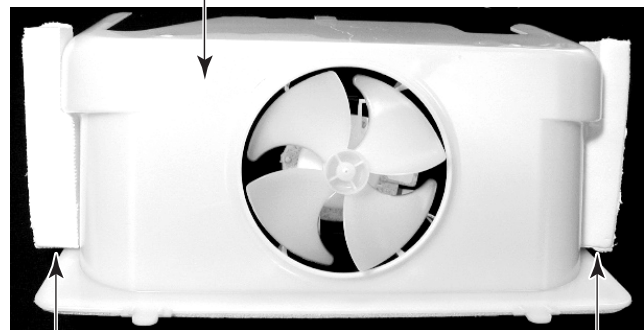

Foam Inserts

2. Be sure to reinstall the left styrofoam block and the right foam block at the locations shown below.

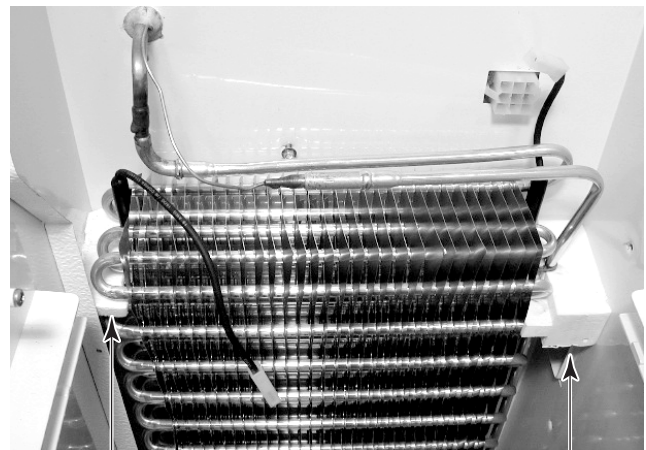

Left Styrofoam Block

Right Foam Block

REMOVING THE CONDENSER FAN MOTOR

!WARNING



Electrical Shock Hazard
Disconnect power before servicing.
Replace all panels before operating.
Failure to do so can result in death or electrical shock.

NOTE: Sharp edges may be present.

1. Unplug the refrigerator or disconnect the power.
2. Pull the refrigerator out of its mounting location.
3. At the rear of the unit, remove the hex-head screws from the unit compartment cover and remove the cover.

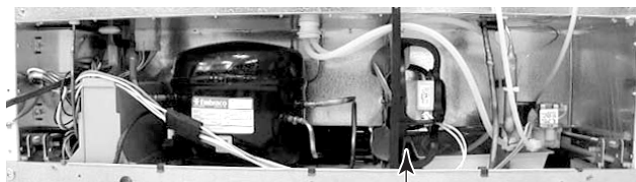

Condenser Fan Motor

4. Remove the speed nut from the condenser fan blade and remove the blade.

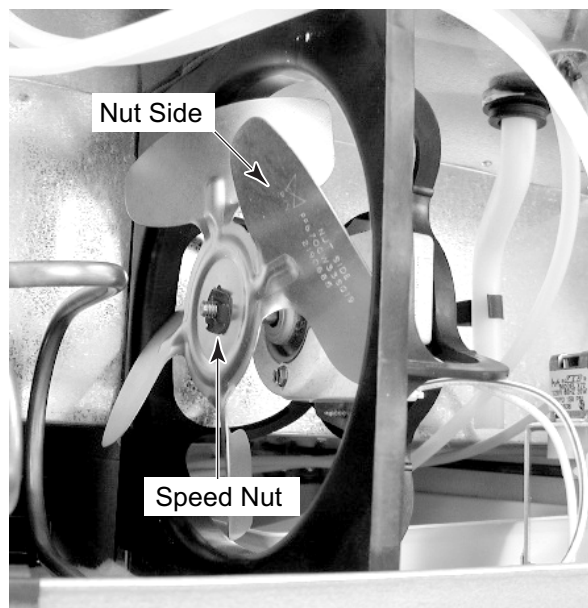

5. Remove the two hex-head screws from the condenser fan motor and remove the motor.

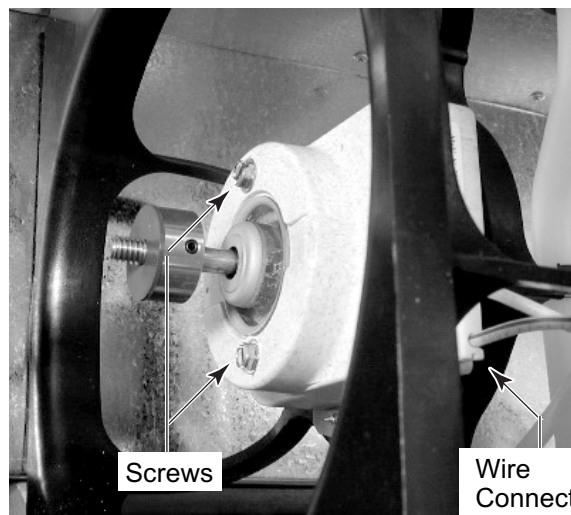

6. Disconnect the wire connector from the condenser fan motor.

NOTE: When you reinstall the condenser fan blade, make sure you position it with the "Nut Side" (stamped on the blade) facing the speed nut (see the top photo).

REMOVING THE COMPRESSOR

! WARNING



Electrical Shock Hazard
Disconnect power before servicing.
Replace all panels before operating.
Failure to do so can result in death or electrical shock.

NOTE: Sharp edges may be present.

1. Unplug the refrigerator or disconnect the power.
2. Pull the refrigerator out of its mounting location.
3. At the rear of the unit, remove the hex-head screws from the unit compartment cover and remove the cover.

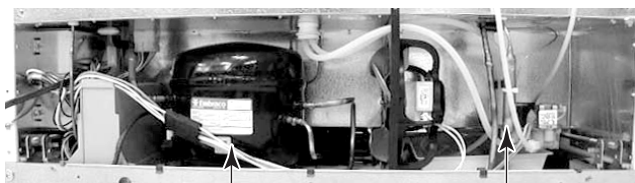

Compressor

Filter/Drier

4. Remove the inverter assembly (see page 4-17 for the procedure).
5. Remove the compressor terminal cover. To remove the cover, insert a flat-bladed screwdriver into the top slot, push down on the screwdriver to release the catch, and then rotate the cover away from the compressor at the top, and lift the cover off the bottom catch (see the top right photo).

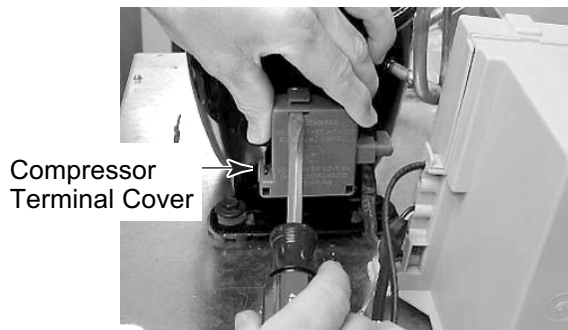

6. Remove the power connector and green ground wire from the compressor terminals.
7. Loosen the strain relief screw and remove the wire.

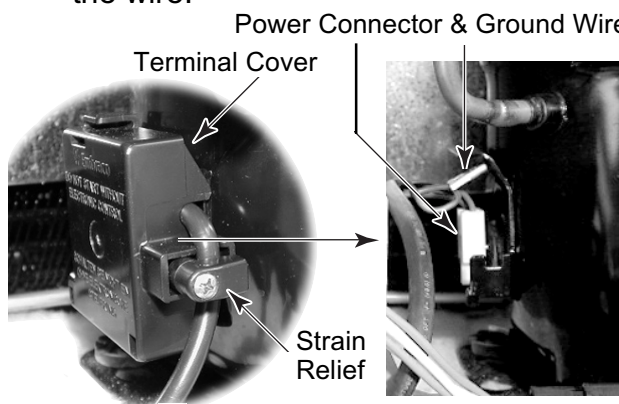

8. Access the sealed system and discharge the refrigerant into an approved recovery system.
9. Cut the suction and discharge lines.
10. Cut the filter/drier from the system (do not use a torch to remove the filter/drier).
11. Pull the four clips from the compressor mounting studs and remove the compressor.

REMOVING THE INVERTER ASSEMBLY

!WARNING



Electrical Shock Hazard
Disconnect power before servicing.
Replace all panels before operating.
Failure to do so can result in death or electrical shock.

NOTE: Sharp edges may be present.

1. Unplug the refrigerator or disconnect the power.
2. Pull the refrigerator out of its mounting location.
3. At the rear of the unit, remove the hex-head screws from the unit compartment cover and remove the cover.



Inverter Assembly

4. Remove the hex-head mounting screw from the inverter assembly and lift the assembly out of the unit.

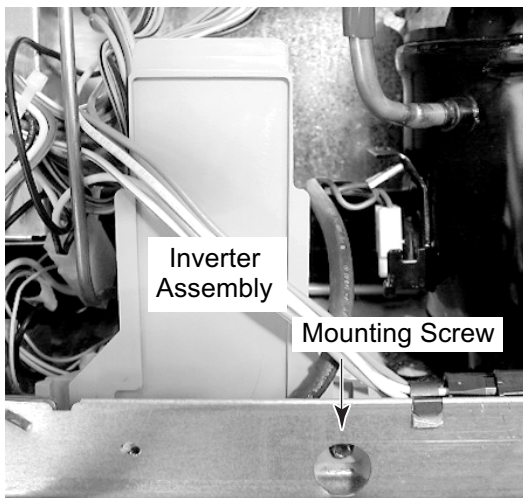

5. Remove the compressor terminal cover (see step 5 on page 4-16 for the procedure).
6. Disconnect the inverter output 3-wire connector and ground wire from the compressor.

Green Ground Wire

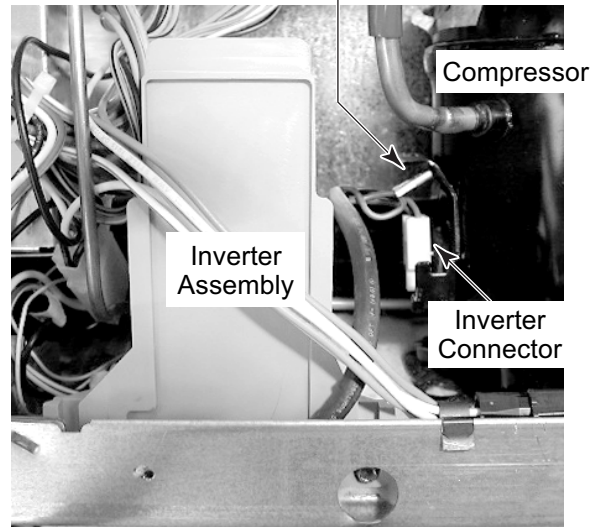

7. Disconnect the 3-wire and 2-wire connectors from the inverter.

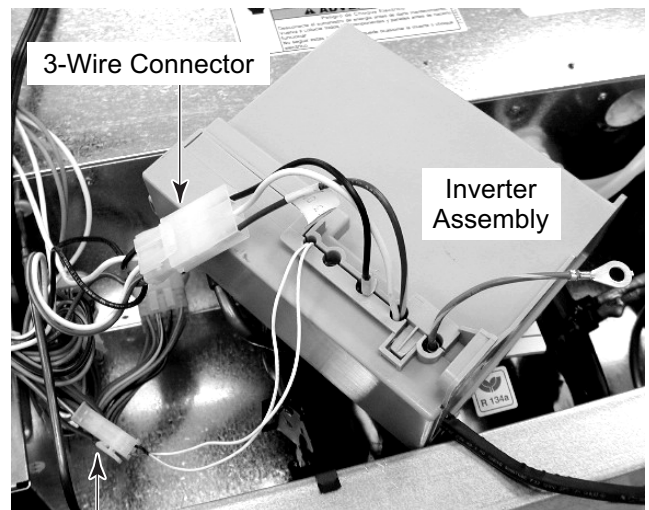

2-Wire Connector

REMOVING THE MAIN CONTROL BOARD ASSEMBLY

! WARNING



Electrical Shock Hazard
Disconnect power before servicing.
Replace all panels before operating.
Failure to do so can result in death or electrical shock.

NOTE: Sharp edges may be present.

1. Unplug the refrigerator or disconnect the power.
2. Pull the refrigerator out of its mounting location.
3. At the rear of the unit, remove the hex-head screws from the unit compartment cover and remove the cover.

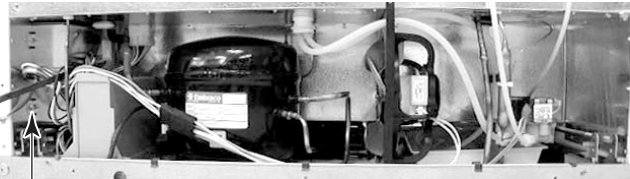

Main Control Board Assembly

4. Remove the inverter assembly (see page 4-17 for the procedure).

5. Disconnect the 3-, 9-, and 12-pin connectors, as shown below.
6. Remove the hex-head screw from the green ground wire.

3-, 9-, & 12 Pin Connectors

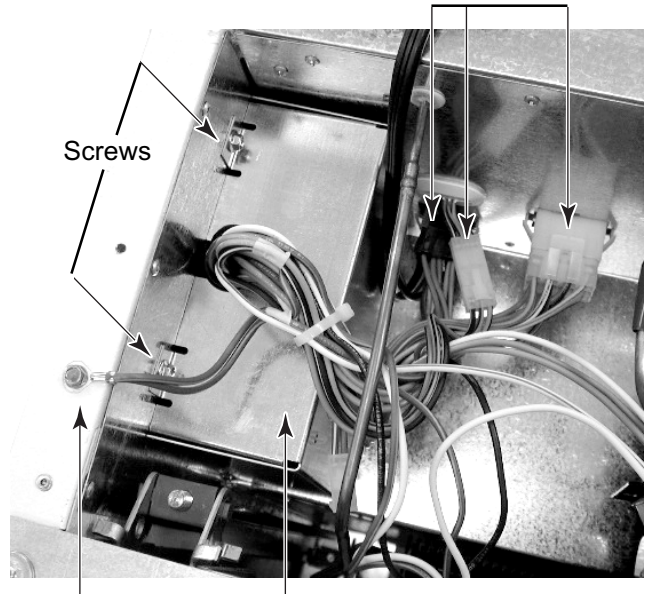

Ground Wire Main Control Board Assembly

7. Remove the two hex-head mounting screws from the main control board enclosure and remove it from the unit.
8. Disconnect the six connectors from the main control board.

Four Connectors

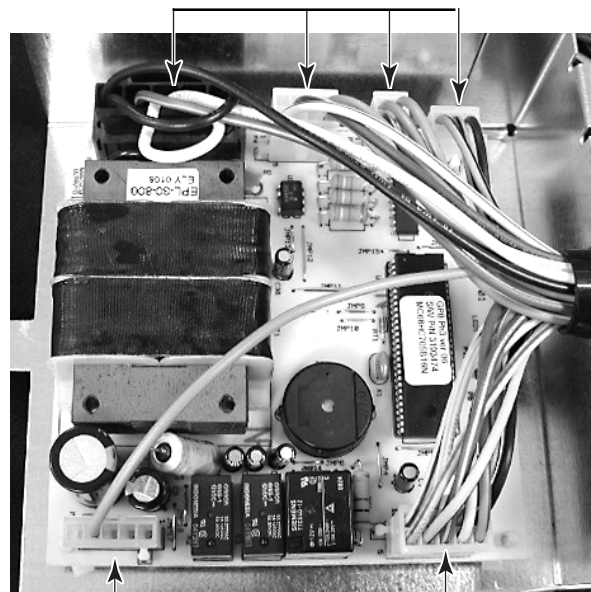

Two Connectors

9. Remove the main control board from the five standoffs. Press in on the locking tab on each standoff to release the board.

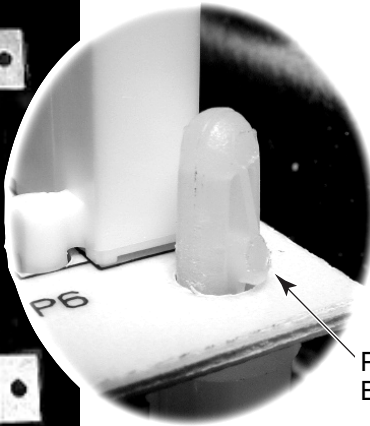
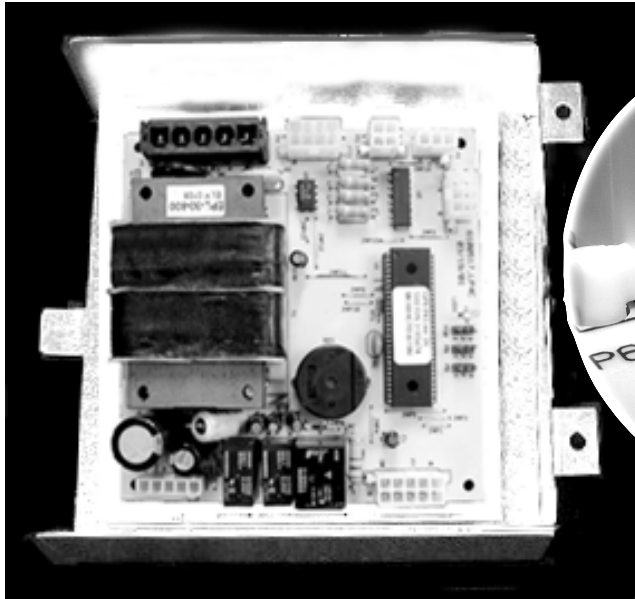

Press In On Tab To Remove Board From Standoffs

⚠ WARNING



Electrical Shock Hazard

Connect green ground wire to ground screw.
Failure to do so can result in death or electrical shock.

NOTE: When you reinstall the main control board assembly, be sure to install the green ground wire at the location shown in the photo.

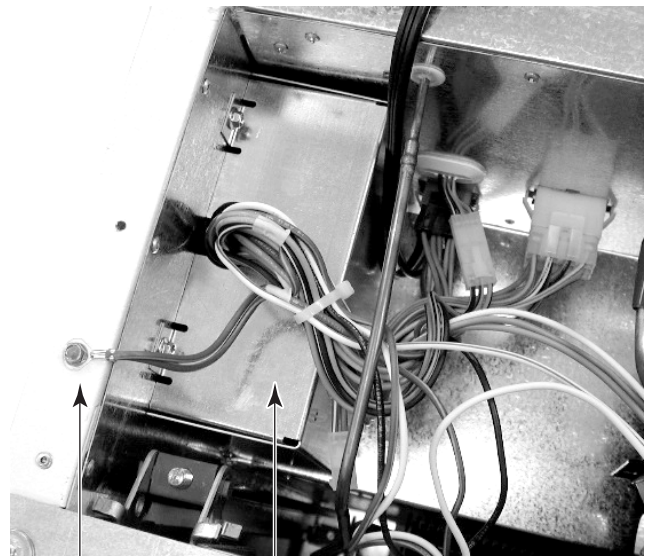

Ground Wire

Main Control Board Assembly

REMOVING THE WATER DISPENSER FILL TUBE

! WARNING



Electrical Shock Hazard
Disconnect power before servicing.
Replace all panels before operating.
Failure to do so can result in death or electrical shock.

NOTE: Sharp edges may be present.

1. Unplug the refrigerator or disconnect the power.
2. Pull out the ice & water dispenser drip tray.



3. Position the drip tray upside down under the ice & water dispenser control panel, and pry the bottom edge of the panel out at the two small slots with a large-bladed screwdriver.

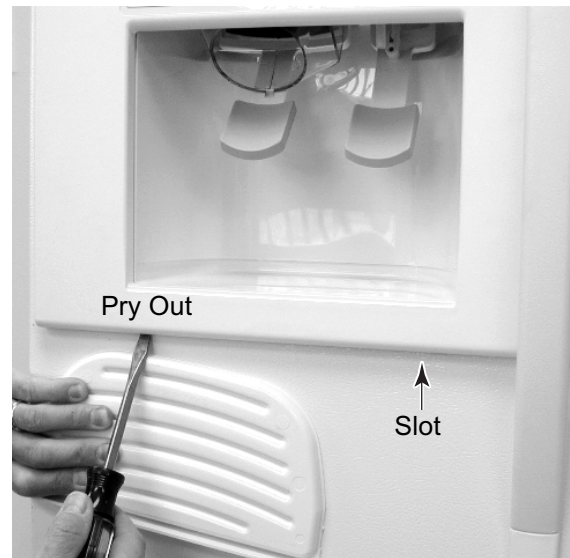

4. Disconnect the control panel switch connector from the wiring harness and remove the panel.



- Disconnect the three wire connectors and the green ground wire from the switch subpanel.
- Remove the two hex-head screws from the switch subpanel and remove the panel.

3 Wire Connectors & Ground Wire

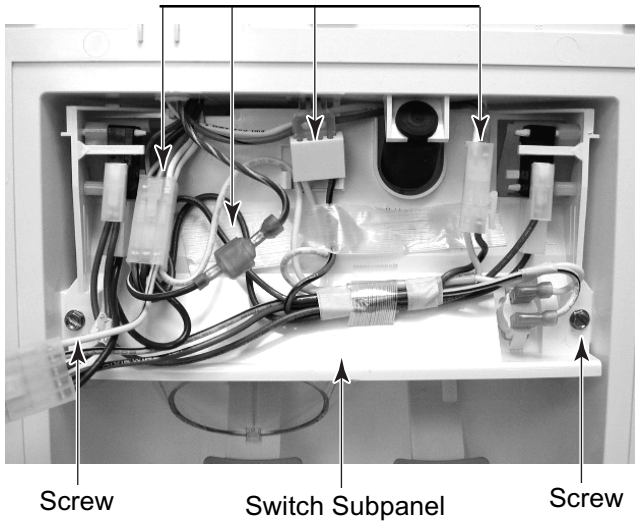

- Open the refrigerator and freezer doors and remove the two screws from the base grille and remove the grille from the front of the unit.

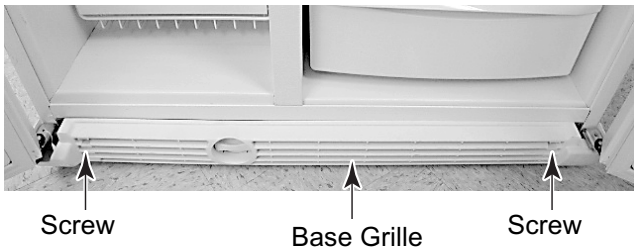

- Place a container near the base grille to catch the water in the next step.

- Disconnect the water dispenser fill tube from the union, slide the nut off the end of the tube, and allow the water to drain into the container.
- If possible, pull the water dispenser fill tube through the wire tie, or cut the tie.

Wire Tie



Water Dispenser Fill Tube Nut

- At the dispenser, pull the water dispenser fill tube out of the dispenser hole.
- Remove the water dispenser fill tube bracket from the end of the old fill tube and install it on the end of the new tube. Leave approximately 1" of tubing for the spout.

Fill Tube Bracket

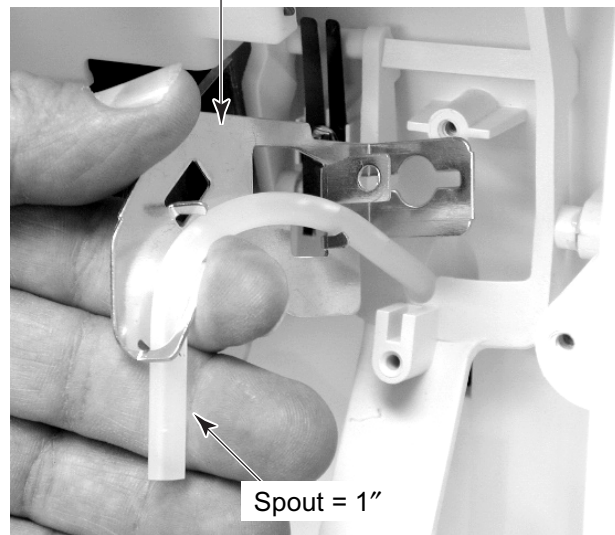

REMOVING THE WATER VALVE

! WARNING



Electrical Shock Hazard
Disconnect power before servicing.
Replace all panels before operating.
Failure to do so can result in death or electrical shock.

NOTE: Sharp edges may be present.

1. Unplug the refrigerator or disconnect the power.
2. Pull the refrigerator out of its mounting location.
3. Turn off the water supply to the refrigerator.
4. At the rear of the unit, remove the hex-head screws from the unit compartment cover and remove the cover.

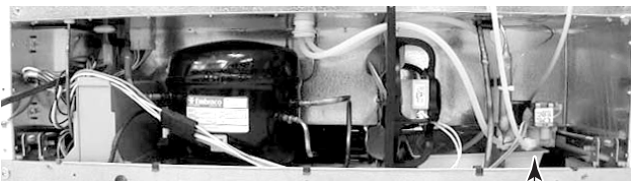

Water Valve

5. Remove the hex-head screws from the water valve bracket.

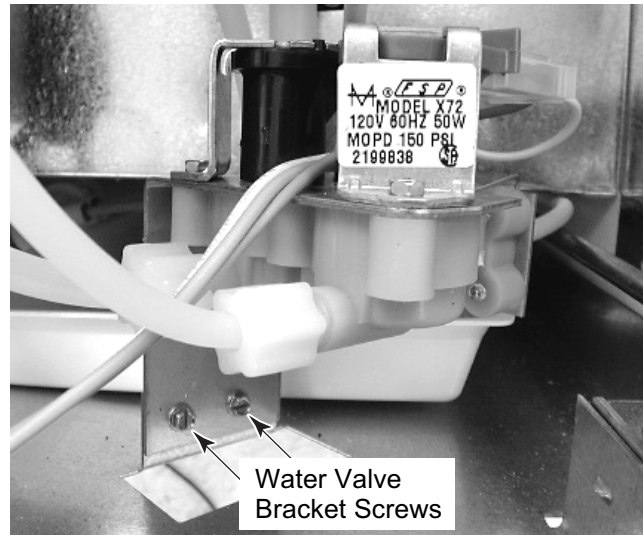

6. Position a container under the water valve to catch the water in the next step.
7. Disconnect the 1/2" nut from the water valve inlet tubing.
8. Remove the water outlet tubing nuts from the water valve.
9. Remove the wire connectors from the two solenoids.

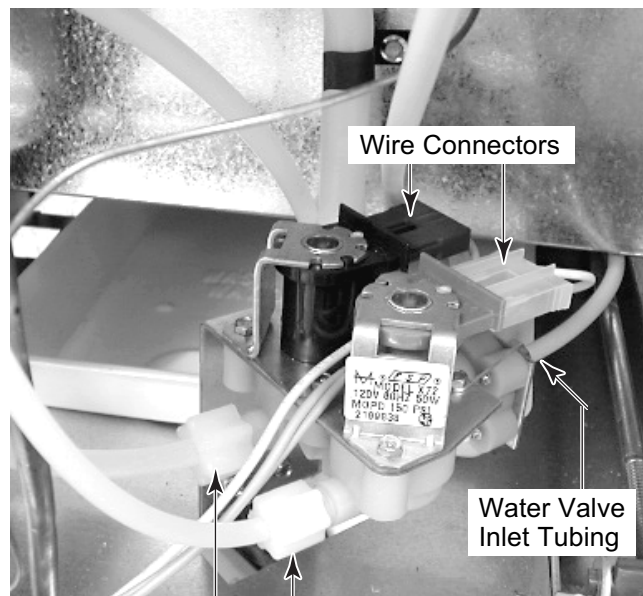

Water Outlet Tubing Nuts

REMOVING THE FREEZER DOOR HANDLES & FREEZER DOOR

! WARNING



Electrical Shock Hazard
Disconnect power before servicing.
Replace all panels before operating.
Failure to do so can result in death or electrical shock.

NOTE: Sharp edges may be present.

1. Unplug the refrigerator or disconnect the power.

NOTE: The refrigerator door and handles are removed in the same manner as the freezer door, except that the ice & water dispenser lines are not present.

2. To remove a door handle:

- a) Slide the top handle trim up to release the shoulder screw from the trim bracket and remove the trim.

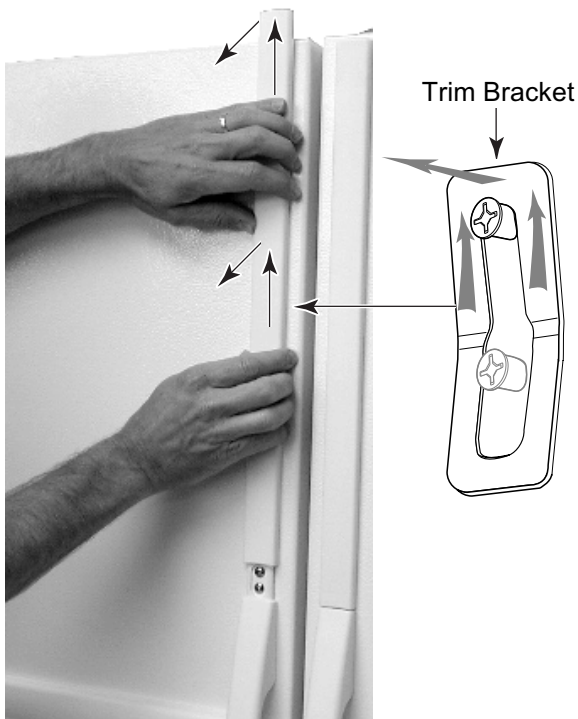

- b) Similarly, slide down and remove the bottom handle trim.
- c) Remove the four hex-head screws and remove the handle from the door.



3. To remove the freezer door:

- a) Open the refrigerator and freezer doors and remove the two screws from the base grille and remove the grille from the front of the unit.

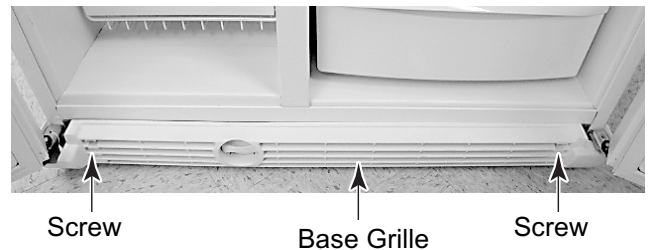

Continued on the next page.

- b) Place a container near the base grille to catch the water in the next step.
- c) Disconnect the water dispenser fill tube from the union, slide the nut off the end of the tube, and allow the water to drain into the container.
- d) Cut the wire tie around the bottom door hinge.

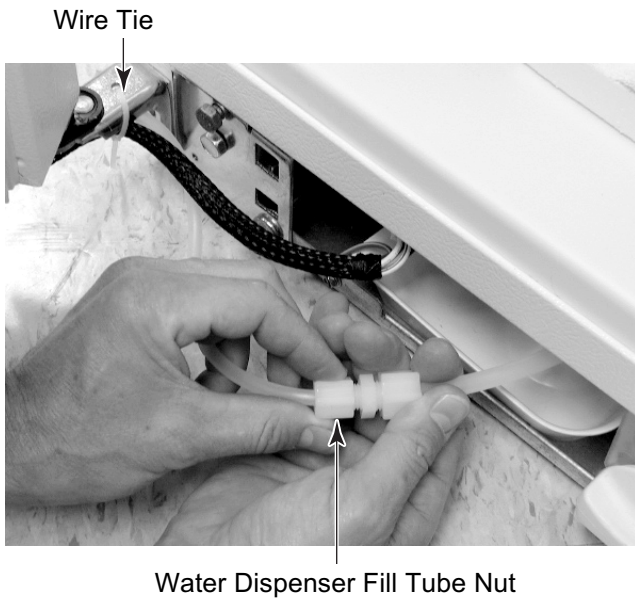

- e) Disconnect the dispenser power connector.

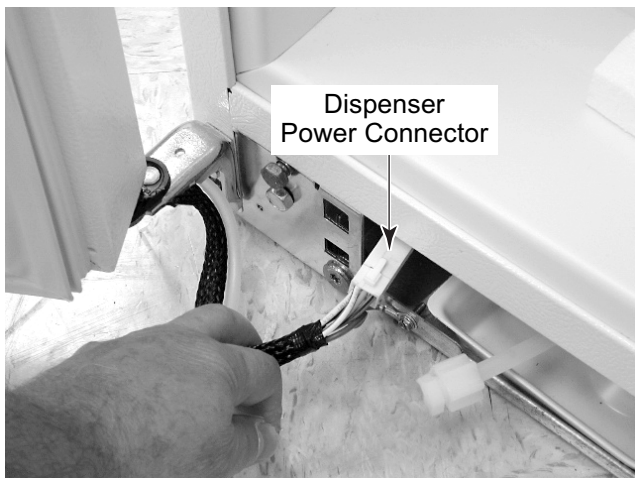

- f) Close the freezer door to hold it in place.
- g) Remove the three Torx screws from the top hinge and remove the hinge.

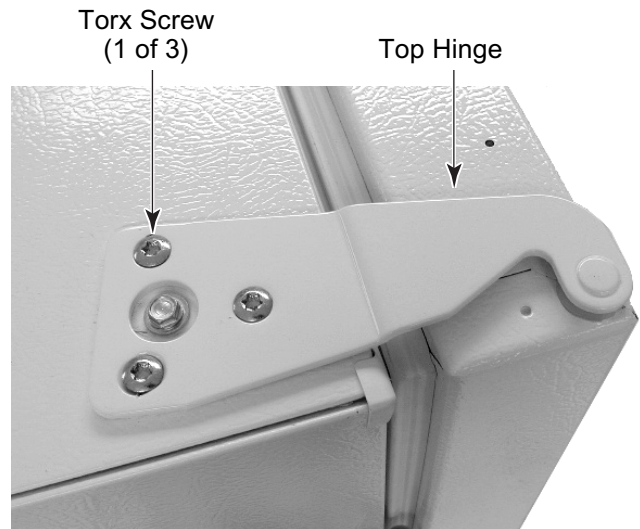

- h) Open the freezer door and lift it off the bottom hinge.

REMOVING A ROLLER

⚠️ WARNING



Electrical Shock Hazard
Disconnect power before servicing.
Replace all panels before operating.
Failure to do so can result in death or electrical shock.

NOTE: Sharp edges may be present.

1. Unplug the refrigerator or disconnect the power.
2. Remove any food or beverage that can spill or be damaged from the refrigerator and freezer compartments.
3. Pull the refrigerator out of its mounting location.
4. If possible, tip the unit to access the front or back rollers. If tipping is not possible, use a piece of wood, (2" x 4"), and prop up the cabinet side at the front or rear of the unit (depending on the roller you are replacing). Only prop up the outside edge of the cabinet and not the bottom frame. The frame must be free to move in order to access the roller pin.
5. Turn the adjustment rod to remove it from the roller.

Roller Adjustment Rod

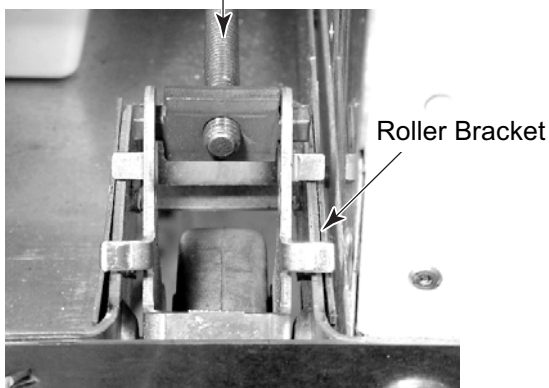

6. Remove the T-40 Torx bolt from the bottom frame.

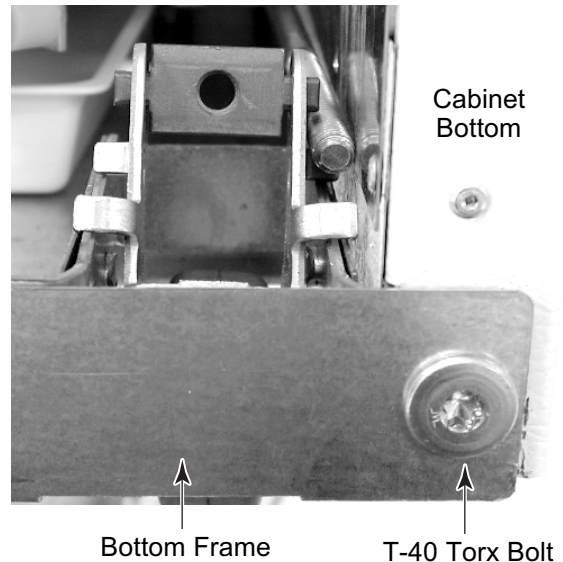

7. Pull the bottom frame down to expose the roller pin. Pull the pin out of the roller and remove it.

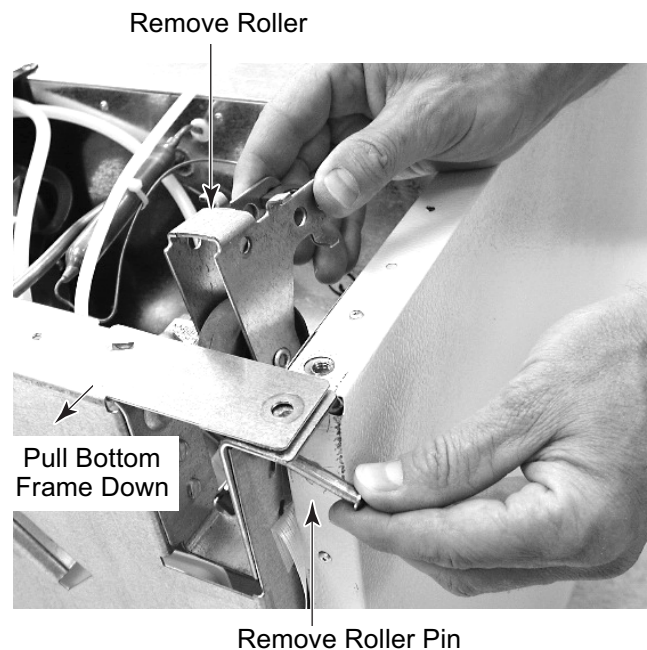

— NOTES —

COMPONENT TESTING

Before testing any of the components, perform the following checks:

- The most common cause for control failure is corrosion on connectors. Therefore, disconnecting and reconnecting wires will be necessary throughout test procedures.
- Check all connections before replacing components, looking for broken or loose wires, failed terminals, or wires not pressed into connectors far enough.
- Resistance checks must be made with power cord unplugged from outlet, and with wiring harness or connectors disconnected.



⚠ WARNING

Electrical Shock Hazard

Disconnect power before servicing.

Replace all panels before operating.

Failure to do so can result in death or electrical shock.

THERMISTOR

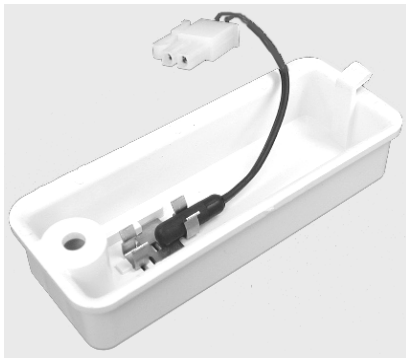

Refer to page 4-4 for the procedure for servicing a thermistor.

1. Run the diagnostics tests (see page 6-1) and test the thermistors in steps 01 and 02.

NOTE: For accurate temperature/resistance readings, continue with the remaining steps to check the resistance of the thermistor(s).

2. Unplug the refrigerator or disconnect the power.
3. Disconnect the thermistor wire connector from the main harness.
4. Set the ohmmeter to the R x 1K scale.
5. Insert the test probes into the two connector pins of the thermistor connector.

6. Depending on the temperature, the meter should indicate within the approximate range, as shown in the chart below.

TEMPERATURE (° F)	RESISTANCE OHMS (APPROX.)	TEMPERATURE (° F)	RESISTANCE OHMS (APPROX.)
-5	25900-27500	45	5930-6300
0	22100-23500	50	5190-5510
5	18900-20000	55	4550-4830
10	16200-17200	60	4000-4240
15	13900-14800	65	3520-3730
20	12000-12800	70	3100-3300
25	10400-11000	75	2740-2910
30	8990-9550	80	2430-2580
32	8750	85	2160-2290
35	7800-8290	90	1920-2030
40	6800-7220		

NOTE: If the resistance of the thermistor(s) was normal, perform the following voltage test.

1. Set the voltmeter to read a maximum voltage of 10 volts DC.
2. Connect power to the refrigerator and allow it to enter the “cooling” mode.
3. With the thermistor disconnected and the refrigerator in the cooling mode, touch the voltmeter test probes to the thermistor main harness connector pins. The meter should indicate approximately 5 volts DC. If the voltage was not present, check for a thermistor output at the main control board (see page 5-5).



⚠ WARNING

Electrical Shock Hazard

**Disconnect power before servicing.
Replace all panels before operating.
Failure to do so can result in death or electrical shock.**

EVAPORATOR FAN MOTOR

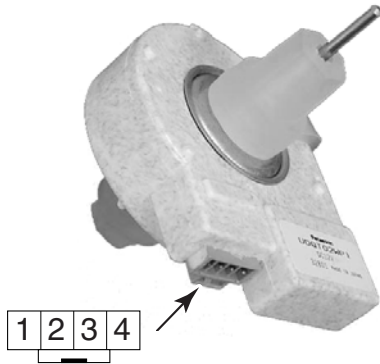

Refer to page 4-11 for the procedure for servicing the evaporator fan motor.

1. Run the diagnostics tests (see page 6-1) and check for the proper operation of the evaporator fan motor in step 03.

NOTE: During the evaporator fan motor operation, 5 to 17 volts DC will be present at the yellow and white wires. A constant 12 volts at the red and white wires will be present anytime the fan motor is operating. The remaining steps will allow you to check the resistance of the evaporator fan motor.

2. Unplug the refrigerator or disconnect the power.
3. Disconnect the wire connector going to the evaporator fan motor.
4. Set the ohmmeter to the R x 10K scale.
5. Touch the ohmmeter test probes to pins 1 and 4 of the evaporator fan motor connector. The meter should indicate approximately 1400 to 1700 Ω .

CONDENSER FAN MOTOR

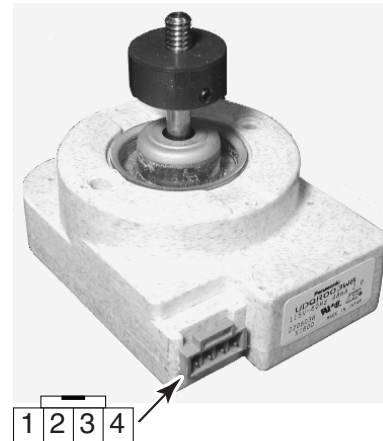

Refer to page 4-15 for the procedure for servicing the condenser fan motor.

1. Run the diagnostics tests (see page 6-1) and check for the proper operation of the condenser fan motor in step 04.

NOTE: During the condenser fan motor operation, 120 volts AC will be present at pins 1 and 4.



⚠ WARNING

Electrical Shock Hazard

Disconnect power before servicing.
 Replace all panels before operating.
 Failure to do so can result in death or electrical shock.

COMPRESSOR & INVERTER

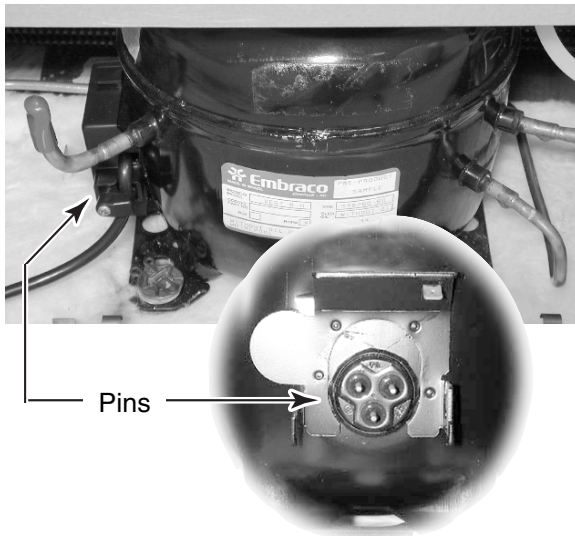

Refer to page 4-16 & 4-17 for the procedure for servicing the compressor and inverter.

1. Run the diagnostics tests (see page 6-1) and check for the proper operation of the compressor in step 05.

NOTE: If the compressor does not operate perform the following steps.

2. Connect power to the refrigerator and allow it to enter the "cooling" mode.
3. While the refrigerator is in the cooling mode, the inverter and main control board voltages should be as shown in the chart below.
4. Set the voltmeter to read the voltages shown in the chart.
 - If the 3 to 6 volts DC is **not** present at the inverter red/white and red wires,

check P7-3 and P7-8 on the main control board for 3 to 6 volts DC. If the voltage is not present, replace the main control board.

- If the 3 to 6 volts DC is present at the main control board, continue with step 5.
5. Unplug the refrigerator or disconnect the power.
 6. Disconnect the wire connector going to the compressor.
 7. Set the ohmmeter to the R x 1 scale.
 8. Touch the meter leads to any two pins. The meter should indicate approximately 9 to 10 Ω . Check between each set of pins to test all three windings.
 9. Set the ohmmeter to the highest scale.
 10. Touch one meter lead to the cabinet ground and the other lead to each of the three compressor terminals. The meter should indicate an open circuit (infinite).

COMPONENT	INPUT/ OUTPUT LOCATIONS	VOLTAGES
Inverter	Red/White & Red Wires	3 To 6 Volts DC
	Black & White Wires	120 Volts AC
Main Control Board	P7-3 (Red) & P7-8 (Red/White)	3 To 6 Volts DC



⚠ WARNING

Electrical Shock Hazard

**Disconnect power before servicing.
Replace all panels before operating.
Failure to do so can result in death or electrical shock.**

MOTORIZED AIR DOOR



Refer to page 4-2 for the procedure for servicing the motorized air door.

1. Run the diagnostics tests (see page 6-1) and check for the proper operation of the air door in step 06.

NOTE: A 12 volts DC square wave is supplied to the air door in a series of short pulses. It is not possible to obtain a reliable voltage reading with a VOM. The remaining steps will allow you to check the resistance of the air door motor.

2. Unplug the refrigerator or disconnect the power.
3. Disconnect the motorized air door wire connector from the main harness.
4. Set the ohmmeter to the R x 10 scale.
5. Touch one of the test probes to the motorized air door connector with the yellow wire and the other test probe to the white wire. The meter should indicate approximately 400 to 450 Ω .
6. Touch one of the test probes to the motorized air door connector with the red wire and the other test probe to the blue wire. The meter should indicate approximately 400 to 450 Ω .

DEFROST HEATER & BIMETAL



Refer to page 4-11 for the procedure for servicing the defrost heater and bimetal.

1. Run the diagnostics tests (see page 6-1) and check for the proper operation of the defrost heater and bimetal in step 07.

NOTE: If the bimetal is closed, the voltage at the defrost heater terminals will be 120 volts AC. The remaining steps will allow you to check the resistance of the defrost heater and bimetal.

2. Unplug the refrigerator or disconnect the power.
3. Disconnect one of the wires going to the defrost heater.
4. Set the ohmmeter to the R x 1 scale.
5. Touch the ohmmeter test probes to the defrost heater terminals.
6. The meter should indicate approximately 19 to 27 Ω .
7. Touch the ohmmeter test probes to the defrost bimetal wire connectors. The meter should indicate as follows:
 - With the bimetal below 20° F, the meter should indicate continuity (0 Ω).
 - With the bimetal above 50° F, the meter should indicate an open circuit (infinite).



⚠ WARNING

Electrical Shock Hazard

**Disconnect power before servicing.
Replace all panels before operating.
Failure to do so can result in death or electrical shock.**

MAIN CONTROL BOARD

Refer to page 4-18 for the procedure for servicing the main control board.

NOTE: See the chart for the main control board test specifications.

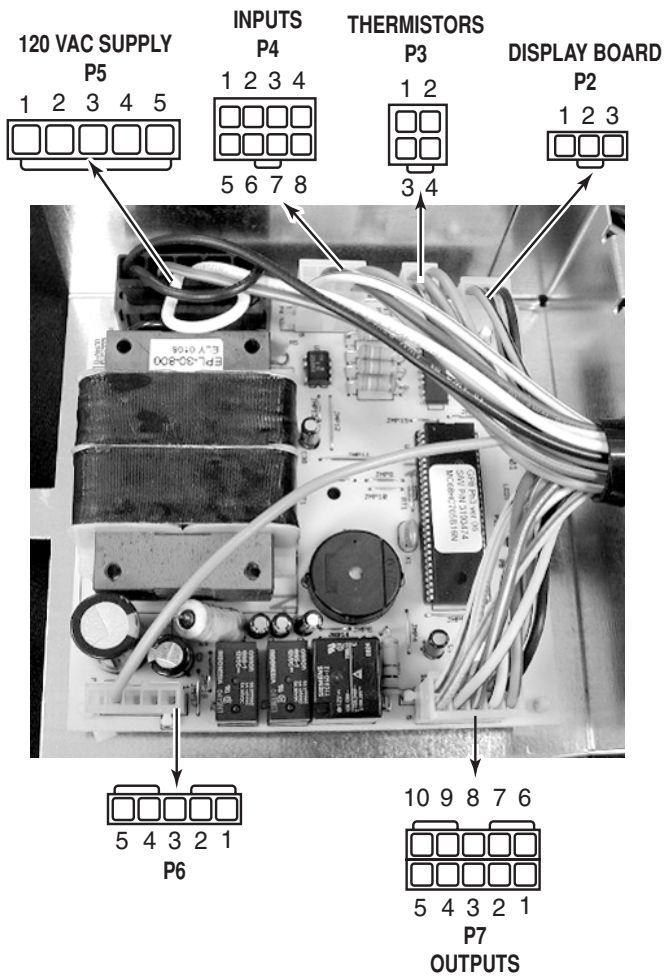

PLUG	PIN #	DESCRIPTION	OUTPUT	CONDITION
P2	1	Communication Line	N/A	
	2	Display Voltage	12 VDC	Measured at pins 2 & 3
	3	GND	GND	
P3	1	Ref. Thermistor	GND	
	2	Frz. Thermistor	GND	
	3	Ref. Thermistor Output	5 VDC	Measured at pins 1 & 3
	4	Frz. Thermistor Output	5 VDC	Measured at pins 2 & 4
P4	1		N/A	
	2		N/A	
	3		N/A	
	4	Ref. Door Input	120 VAC	Voltage present when door is open
	5	Ice Maker Valve Input	120 VAC	Voltage present when ice maker is energized
	6	Dispenser Valve Input	120 VAC	Voltage present when dispenser valve is energized
	7	Bimetal Input	120 VAC	Voltage present when bimetal is closed
	8		N/A	
P5	1	AC GND	AC GND	
	2	AC L1	120 VAC	
	3	AC Neutral	AC Neutral	
	4	AC Neutral	AC Neutral	
	5	AC L1	120 VAC	
P6	1	Condenser Fan	120 VAC	Voltage present when condenser fan is on
	2		N/A	
	3		N/A	
	4	Defrost Heater	120 VAC	Voltage present when defrost heater is on
	5		N/A	
P7	1	Air Door		
	2	Air Door		
	3	Compressor Drive	3 - 6 VDC	Measured at pins 3 & 8
	4	Evap. Fan Feedback	N/A	
	5	Evap. Fan Constant	12 VDC	Measured at pins 5 & 9
	6	Air Door		
	7	Air Door		
	8	Compressor Drive	3 - 6 VDC	Measured at pins 3 & 8
	9	Evap. Fan Ground	Evap. GND	
	10	Evap. Fan Run Voltage	5 - 12 VDC	Measured at pins 9 & 10



⚠ WARNING

Electrical Shock Hazard

**Disconnect power before servicing.
Replace all panels before operating.
Failure to do so can result in death or electrical shock.**

CRUSH/CUBE SOLENOID

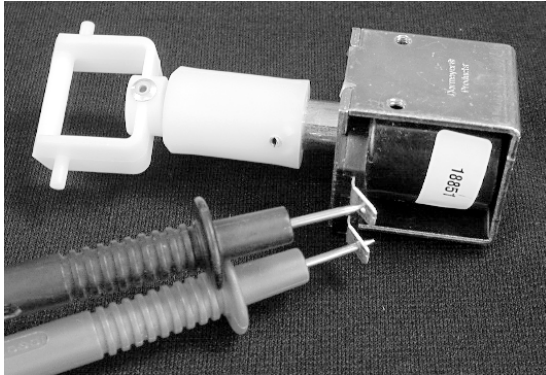

Refer to page 4-9 for the procedure for servicing the crush/cube solenoid.

1. Unplug the refrigerator or disconnect the power.
2. Disconnect one of the wires going to the solenoid.
3. Set the ohmmeter to the R x 1 scale.
4. Touch the ohmmeter test probes to the solenoid terminals.
5. The meter should indicate approximately 35 to 45 ohms.

ICE MAKER AUGER MOTOR

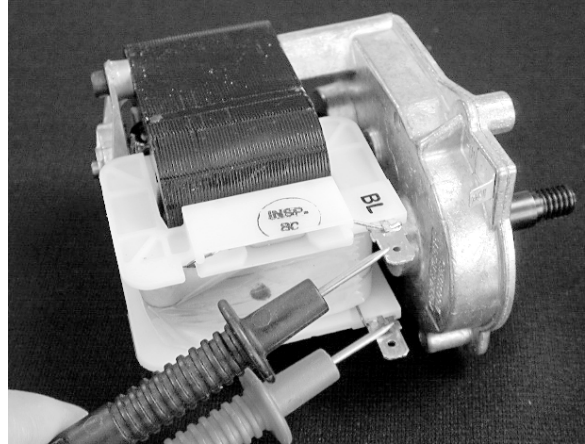

Refer to page 4-9 for the procedure for servicing the ice maker auger motor.

1. Unplug the refrigerator or disconnect the power.
2. Disconnect one of the wires going to the auger motor.
3. Set the ohmmeter to the R x 1 scale.
4. Touch the ohmmeter test probes to the auger motor terminals.
5. The meter should indicate approximately 2 to 4 ohms.



⚠️ WARNING

Electrical Shock Hazard

**Disconnect power before servicing.
Replace all panels before operating.
Failure to do so can result in death or electrical shock.**

WATER VALVE SOLENOID

Refer to page 4-22 for the procedure for servicing the water valve.

1. Unplug the refrigerator or disconnect the power.
2. Disconnect the wire connectors from the water valve solenoid terminals.
3. Set the ohmmeter to the R x 1 scale.
4. Touch the ohmmeter test probes to the terminals of the ice maker solenoid. The ohmmeter should indicate approximately 160 to 170 Ω .
5. Touch the ohmmeter test probes to the terminals of the water dispenser solenoid. The ohmmeter should indicate approximately 330 to 355 Ω .

Water Dispenser Solenoid (5/16" Outlet)

Ice Maker Solenoid (1/4" Outlet)

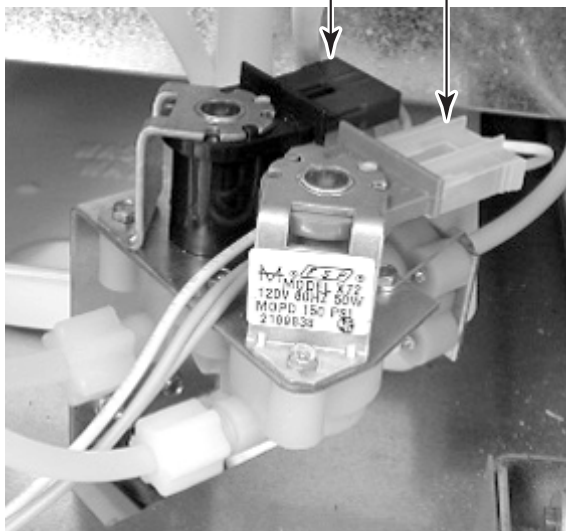

DOOR SWITCH



Refer to page 4-5 for the procedure for servicing a door switch.

1. Unplug the refrigerator or disconnect the power.
2. Disconnect one of the wires going to the door switch.
3. Set the ohmmeter to the R x 1 scale.
4. Touch the ohmmeter test probes to the door switch terminals.
5. The meter should indicate continuity (0 Ω). NOTE: The door switches are normally-closed.
6. Press the door switch actuator button and the meter should indicate an open circuit (infinite).

DIAGNOSIS & TROUBLESHOOTING

DIAGNOSIS

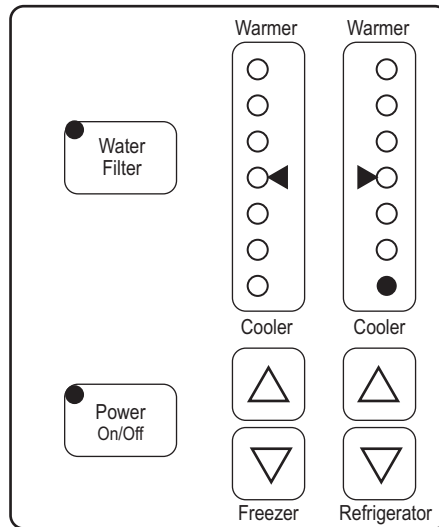

PRE-DIAGNOSTICS CHECKS

- Confirm the refrigerator and freezer temperatures before beginning other checks.
- See if the compressor, evaporator, and condenser fans are running.
- Check the position of the air door.

DIAGNOSTICS MODE

The Diagnostics Mode is used to:

- Check the refrigerator & freezer thermostats.
- Operate the evaporator fan motor at 3000 rpm.
- Operate the condenser fan motor and compressor.
- Check the defrost bimetal and heater.

To enter the Diagnostics Mode, the control must be turned on, and be in a normal cooling mode.

Both the Power On/Off and the Water Filter Reset keys must be functional. The refrigerator LEDs will show the step number, with the bottom LED being #1. The results of the checks are shown on the water filter status indicator. Green indicates good and red indicates bad. After 20 minutes, the control will default from the Diagnostics Mode to a normal cooling mode.

To enter the diagnostics mode:

- Press and hold the Water Filter Reset keypad, and then immediately press and hold the Power keypad. Continue to press both keypads for 3 seconds, or until you hear a beep.

To advance the diagnostics sequence:

- To advance to the next step in the sequence, press and hold the Water Filter Reset key for 2 seconds, or until you hear a beep. The Diagnostics Chart on the following page shows the step number and the component being tested in each step.

DIAGNOSTICS CHART

Step	Component Tested	Result*	Comment
01	Freezer Thermistor.	Green	Thermistor is within normal range.
		Red	Thermistor is open or less than -20°F.
		Red	Thermistor is shorted or greater than 115°F.
02	Refrigerator Thermistor.	Green	Thermistor is within normal range.
		Red	Thermistor is open or less than 10°F.
		Red	Thermistor is shorted or greater than 115°F.
03	Evaporator Fan Motor.	Green	Evaporator Fan Motor is On at correct speed.
		Red	Evaporator Fan Motor is On at incorrect speed.
04	Condenser Fan Motor.	Green	Condenser Fan Motor is On.
05	Compressor.	Green	Compressor is On at 4500 rpm.
		Red	Compressor is Off waiting for minimum (7 minute) Off delay.
06	Air Door.	Green	Air Door fully opens.**
07	Bimetal/Defrost Heater.	Green	Defrost Heater is energized, bimetal closed.
		Red	Bimetal open. †
Press the "Water Filter Reset" to exit diagnostics.			
* Displayed on the Water Filter Indicator LED.			
** The air door will close at step 01, and reset to the correct opening after exiting diagnostics.			
† The bimetal may be bypassed with an insulated jumper.			

WATER FILTER INPUT (WFI) TEST

To confirm that the water valves are being monitored by the WFI control, follow the procedures listed:

Testing The Dispenser Valve Input

1. Open the refrigerator door.
2. Depress the refrigerator light switch.
3. Place a container under the water spout.
4. Activate the water dispenser.
5. Read the WFI display. Yellow indicates a normal input.

Testing The Ice Maker Valve Input

1. Open the refrigerator door.
2. Depress the refrigerator light switch.
3. Activate the ice maker and wait for a water fill.
4. Read the WFI display during the fill. Red indicates a normal input.

TROUBLESHOOTING CHART

PROBLEM	POSSIBLE CAUSE	TEST PROCEDURE-ACTION
Condenser fan runs but the compressor will not start.	No DC control voltage from main PCB to the inverter board.	See "Component Testing" section for main PCB test procedure.
	Control voltage wires loose or reversed.	Check connections and repair as needed.
	Compressor.	See "Component Testing" section for compressor/inverter test procedure.
	Inverter board.	See "Component Testing" section for compressor/inverter test procedure.
Refrigerator compartment too warm.	Refrigerator control set too warm.	Set to a lower temperature.
	Refrigerator thermistor.	Check wires and connectors. Run diagnostics and if a defective thermistor is indicated, confirm with ohms test. See "Component Testing".
	Air door stuck closed or inoperative.	Look for ice or other blockage in air door. Run diagnostics test to operate air door.
	Evaporator fan motor not running.	Run diagnostics test to operate the evaporator fan motor. Check for a blocked fan blade and repair as necessary. Check for 5-17vdc from pin P7-9 to P7-10. If voltage is correct, replace the motor.
	Blocked air flow.	Check air door outlet and air returns for blockage.
	Warm freezer compartment.	See "Freezer compartment too warm."
Refrigerator compartment too cold.	Refrigerator control set too cold.	Set to a higher temperature.
	Refrigerator thermistor.	Check wires and connectors. Run diagnostics and if a defective thermistor is indicated, confirm with ohms test. See "Component Testing".
	Air door stuck open or inoperative.	Look for ice or other blockage in air door. Run diagnostics test to operate air door. Check for proper DC input voltage. If voltage is normal and door will still not operate, replace air door.
	Air door seal missing or damaged.	Repair or replace seal.
	Main PC board.	Run diagnostics test to operate air door.
Freezer compartment too warm.	Freezer control set too warm.	Set to a lower temperature.
	Freezer thermistor.	Check wires and connectors. Run diagnostics and if a defective thermistor is indicated, confirm with ohms test. See "Component Testing".
	Evaporator fan motor not running.	Run diagnostics test to operate the evaporator fan motor. Check for a blocked fan blade and repair as necessary. Check for 5-17vdc from pin P7-9 to P7-10. If voltage is correct, replace the motor.
	Condenser fan motor not running.	Check for a blocked fan blade and repair as necessary. See "Component Testing" section for condenser fan motor test procedure.
	Frost blocking evaporator.	Run diagnostics test to operate defrost system. Test defrost heater and bi-metal.
Freezer compartment too cold.	Freezer control set too cold.	Set to a higher temperature.
	Freezer thermistor.	Check wires and connectors. Run diagnostics and if a defective thermistor is indicated, confirm with ohms test. See "Component Testing".
	No evaporator fan motor feedback.	The fan motor will run at 3000 rpm.
Refrigerator runs too long.	Normal.	It is designed for this refrigerator to run almost constantly at the lowest possible compressor speed. Starting and stopping the compressor uses more power than continuous low rpm operation. Instruct customer.

— NOTES —

WIRING DIAGRAMS & STRIP CIRCUITS

WIRING DIAGRAM

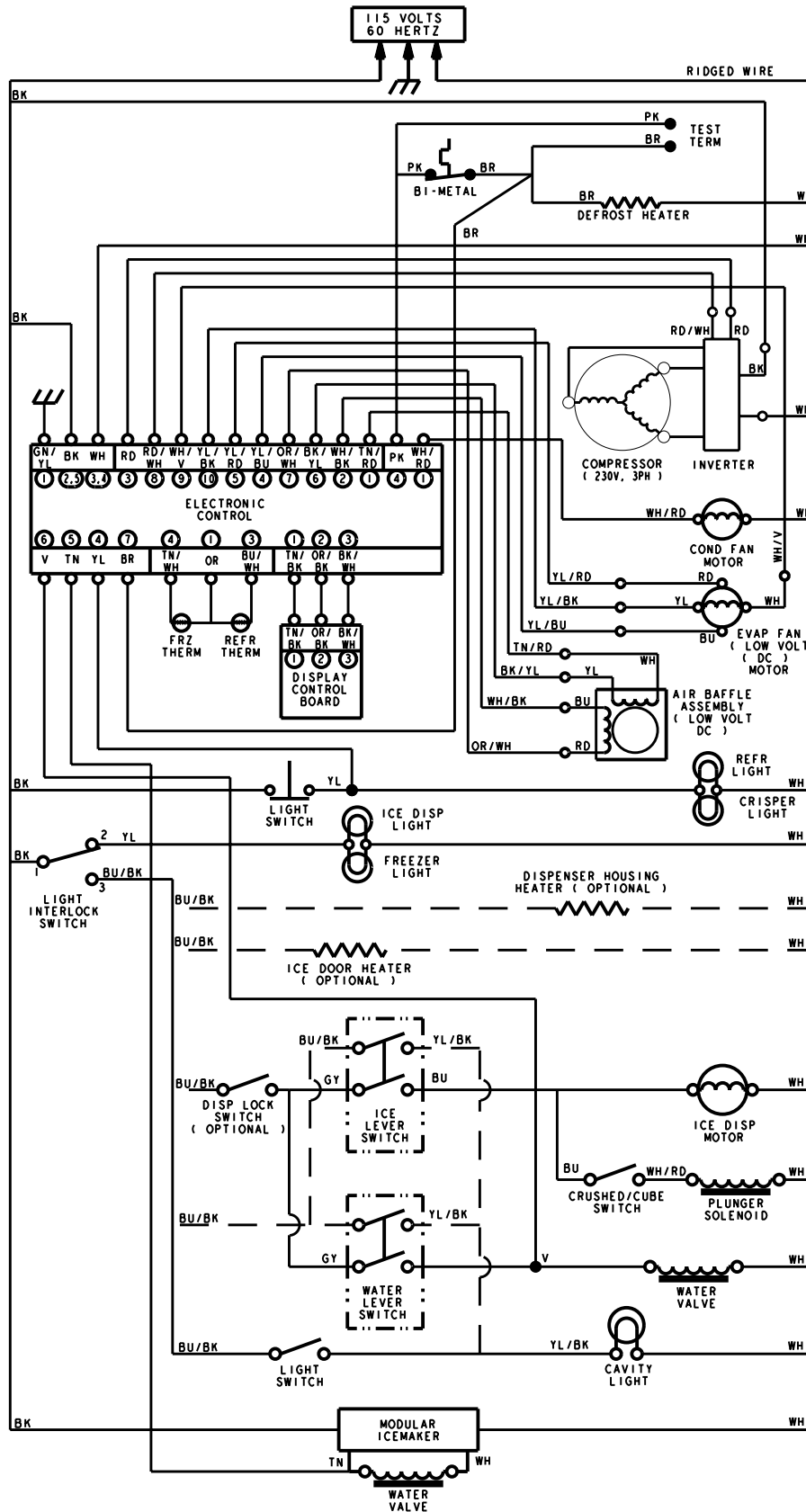

STRIP CIRCUITS

THE COOLING CIRCUITS

The Compressor

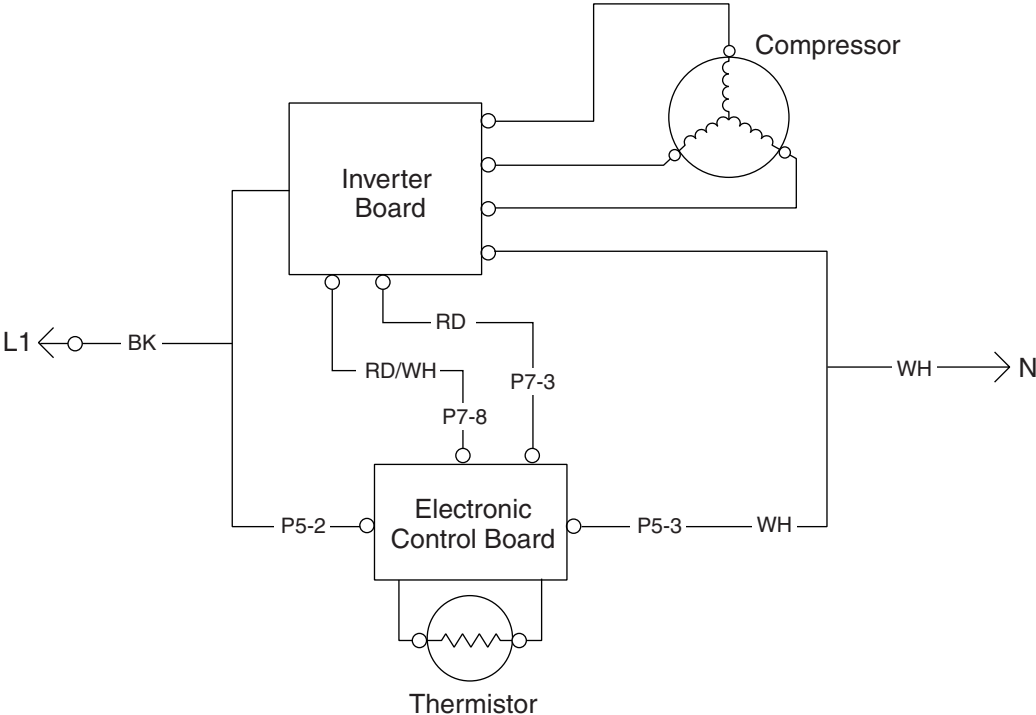

The Condenser Fan Motor

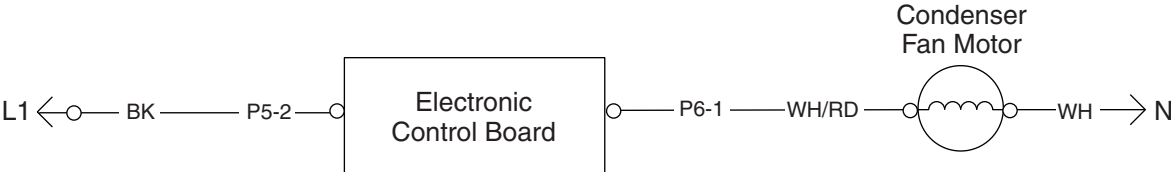

The Evaporator Fan Motor

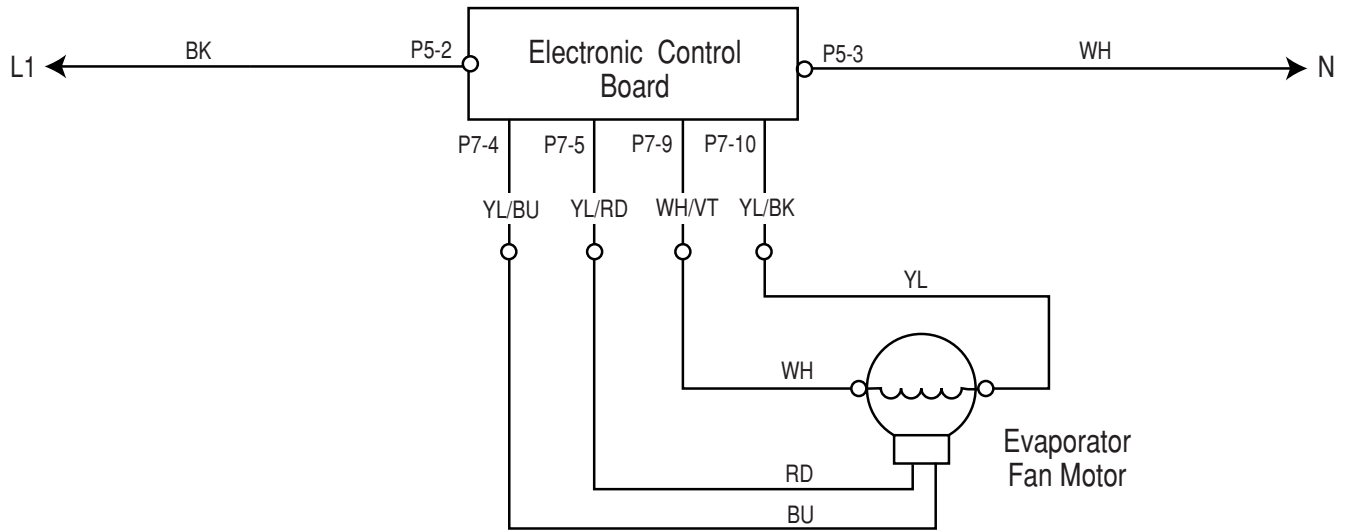

THE DEFROST CYCLE

The Defrost Heater

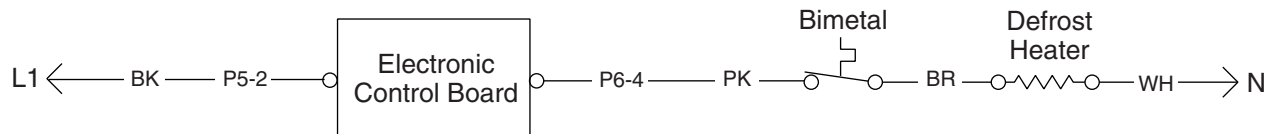

— NOTES —

PRODUCT SPECIFICATIONS AND WARRANTY INFORMATION SOURCES

IN THE UNITED STATES:

FOR PRODUCT SPECIFICATIONS AND WARRANTY INFORMATION CALL:

FOR WHIRLPOOL PRODUCTS: 1-800-253-1301
FOR KITCHENAID PRODUCTS: 1-800-422-1230
FOR ROPER PRODUCTS: 1-800-447-6737

FOR TECHNICAL ASSISTANCE WHILE AT THE CUSTOMER'S HOME CALL:

THE TECHNICAL ASSISTANCE LINE: 1-800-253-2870

**HAVE YOUR STORE NUMBER READY TO IDENTIFY YOU AS AN
AUTHORIZED SERVICER**

FOR LITERATURE ORDERS:

PHONE: 1-800-851-4605

IN CANADA:

FOR PRODUCT SPECIFICATIONS AND WARRANTY INFORMATION CALL:

1-800-461-5681

FOR TECHNICAL ASSISTANCE WHILE AT THE CUSTOMER'S HOME CALL:

THE TECHNICAL ASSISTANCE LINE: 1-800-488-4791

**HAVE YOUR STORE NUMBER READY TO IDENTIFY YOU AS AN
AUTHORIZED SERVICER**

KitchenAid[®]
FOR THE WAY IT'S MADE.[®]