

Kodak EasyShare C330 zoom digital camera

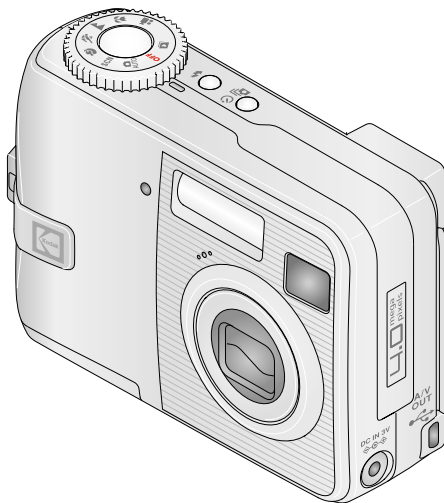

User's guide

www.kodak.com

For interactive tutorials, www.kodak.com/go/howto

For help with your camera, www.kodak.com/go/c330support



Eastman Kodak Company
Rochester, New York 14650
© Eastman Kodak Company, 2005



All screen images are simulated.

Kodak, EasyShare, and Retinar are trademarks of Eastman Kodak Company.

P/N 4J4294_en

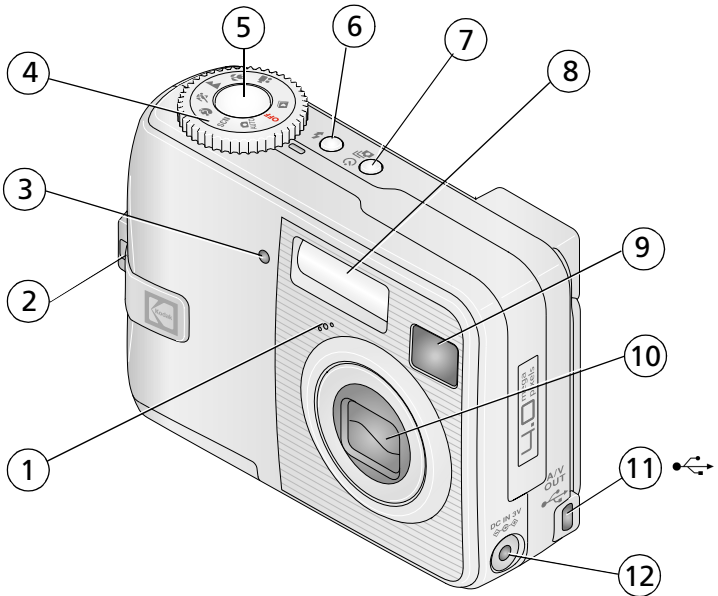
Front View



- | | | | |
|---|--|----|---|
| 1 | Microphone | 7 | Self-timer/Burst button |
| 2 | Wrist strap | 8 | Flash |
| 3 | Self Timer /Video light | 9 | Viewfinder |
| 4 | Mode dial: camera modes/power settings | 10 | Lens |
| 5 | Shutter button | 11 | USB, A/V Out  |
| 6 | Flash button | 12 | DC-In (3V)  , for optional AC adapter |

Side View

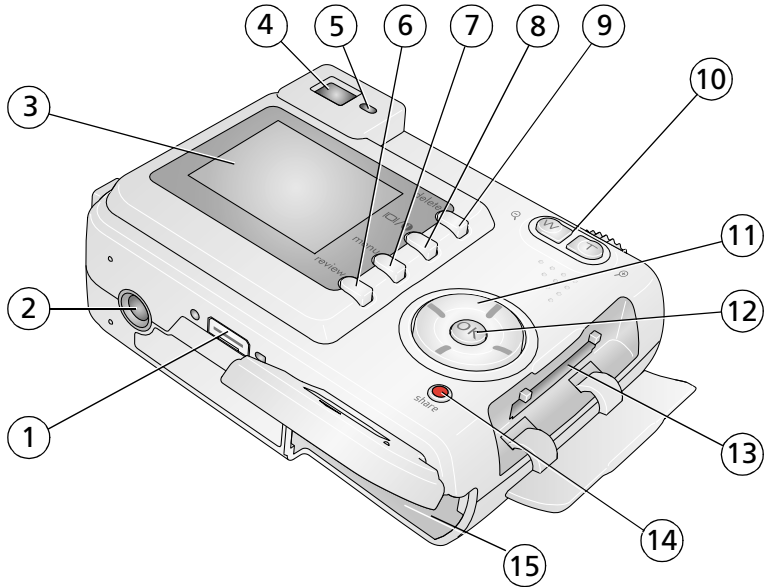

- | | | | |
|---|--------------------------|----|----------------------------------|
| 1 | Dock connector | 9 | Delete button |
| 2 | Tripod socket | 10 | Zoom (Wide Angle/Telephoto) |
| 3 | LCD screen | 11 | 4-way controller |
| 4 | Viewfinder | 12 | OK button |
| 5 | Ready light | 13 | Slot for optional SD or MMC card |
| 6 | Review button | 14 | Share button |
| 7 | Menu button | 15 | Battery compartment |
| 8 | LCD On/Off/Status button | | |

Table of contents

1	Setting up your camera	1
	Attaching the wrist strap	1
	Loading the batteries	1
	Turning on the camera	2
	Setting the date/time, first time	2
	Setting the language and date/time, other times	3
	Storing pictures on an SD or MMC card	3
2	Taking pictures and videos	4
	Taking a picture	4
	Using optical zoom	8
	Using the flash	9
	Reviewing pictures and videos	9
	Protecting pictures and videos from deletion	12
3	Transferring and printing pictures	14
	Minimum system requirements	14
	Installing the software	15
	Transferring pictures with the USB cable	16
	Printing pictures	17
	Dock compatibility for your camera	20
4	Doing more with your camera	21
	Using the self-timer	21
	Using burst	22
	Running a slide show	23
	Copying pictures and videos	25
	Changing the flash settings	26
	Picture-taking modes	27
	Changing picture-taking settings	29

Customizing your camera	32
Viewing picture/video information	34
Pre-tagging for album names	35
Sharing your pictures.....	37
5 Troubleshooting	42
Camera problems.....	42
Computer/connectivity problems.....	44
Picture quality problems	44
Camera ready light status.....	45
Direct printing (PictBridge) problems.....	46
6 Getting help	47
Helpful links.....	47
Telephone customer support	48
7 Appendix	50
Camera specifications	50
Storage capacities	54
Power-saving features.....	55
Important safety instructions	55
Battery information	57
Upgrading your software and firmware.....	58
Additional care and maintenance	59
Warranty.....	59
Regulatory compliance	62

1

Setting up your camera

Attaching the wrist strap

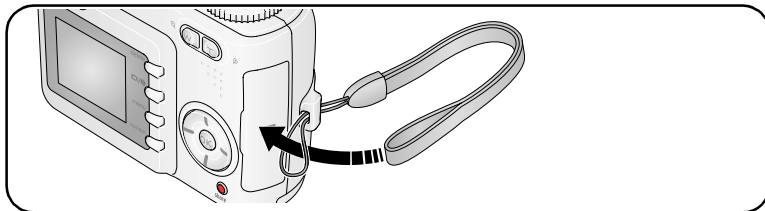

Loading the batteries

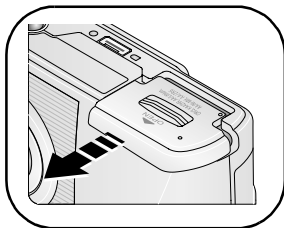

- 1 Open the battery door.
- 2 Load the batteries, then close the battery door.

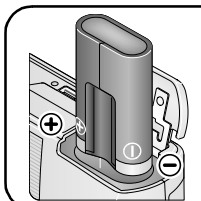

CRV3 lithium
(non-rechargeable)

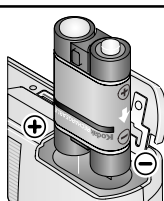

Ni-MH rechargeable
battery pack

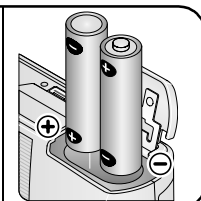

2-AA lithium, Ni-MH,
or oxy-alkaline

For information on replacing batteries and extending battery life, see [page 57](#).

Turning on the camera

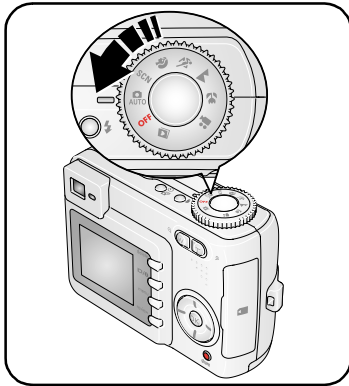

Setting the date/time, first time

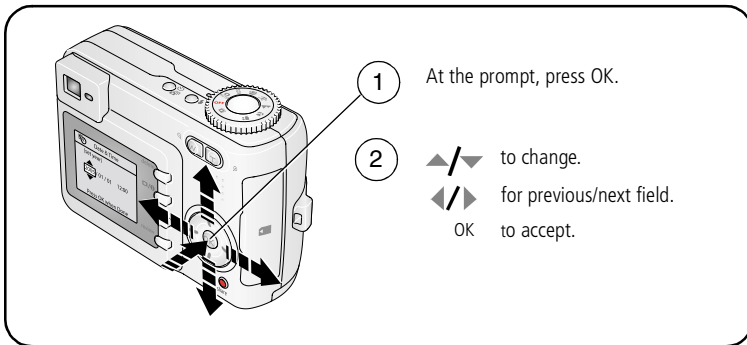

Setting the language and date/time, other times

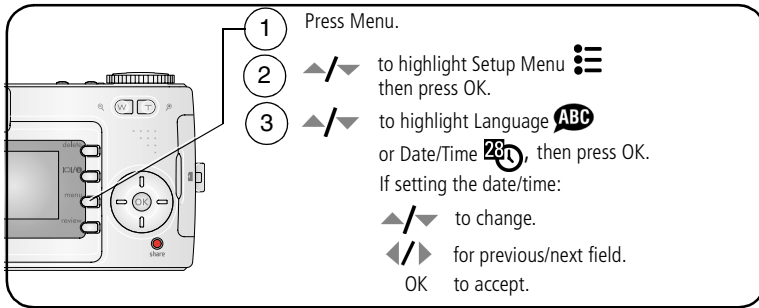

Storing pictures on an SD or MMC card

Your camera has 16 MB of internal memory. You can purchase an SD or MMC card to conveniently store more pictures and videos.

NOTE: We recommend Kodak SD and MMC cards. When using the card for the first time, format it in this camera before taking pictures (see [page 33](#)).

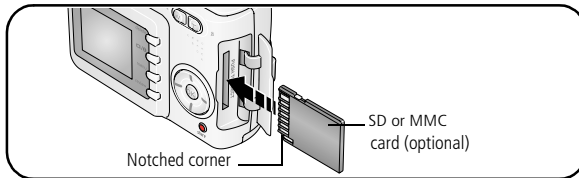

CAUTION:

A card can only be inserted one way; forcing it may cause damage. Inserting or removing a card when the Ready light is blinking may damage pictures, card, or camera.

See [page 54](#) for storage capacities. Purchase SD or MMC cards at a dealer of Kodak products or www.kodak.com/go/c330accessories.

2

Taking pictures and videos

Taking a picture

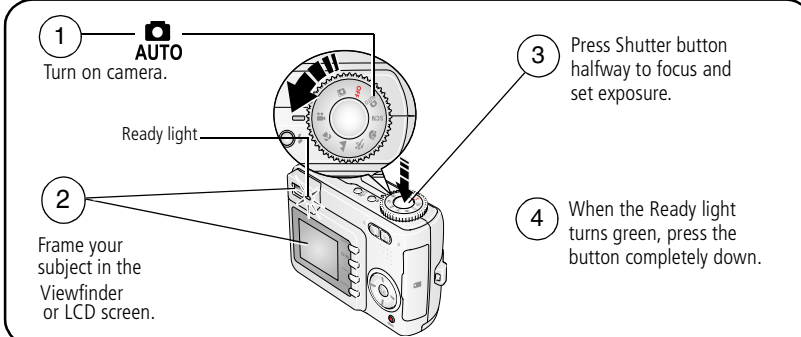

1  **AUTO**
Turn on camera.

Ready light

2
Frame your subject in the Viewfinder or LCD screen.

3 Press Shutter button halfway to focus and set exposure.

4 When the Ready light turns green, press the button completely down.

The diagram shows a camera with a callout for the mode dial. An arrow points to the 'AUTO' position. A 'Ready light' is indicated on the front of the camera. The shutter button is shown being pressed halfway (step 3) and then fully (step 4).

Taking a video

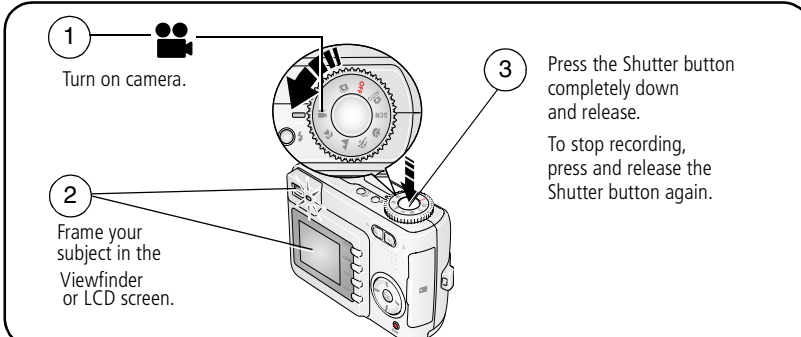

1 
Turn on camera.

2
Frame your subject in the Viewfinder or LCD screen.

3 Press the Shutter button completely down and release.
To stop recording, press and release the Shutter button again.

The diagram shows a camera with a callout for the mode dial. An arrow points to the video mode icon. The shutter button is shown being pressed completely down and released (step 3).

Reviewing the picture or video just taken

After you take a picture or video, the LCD screen displays a Quickview for approximately 5 seconds.

While the picture or video and  are displayed:

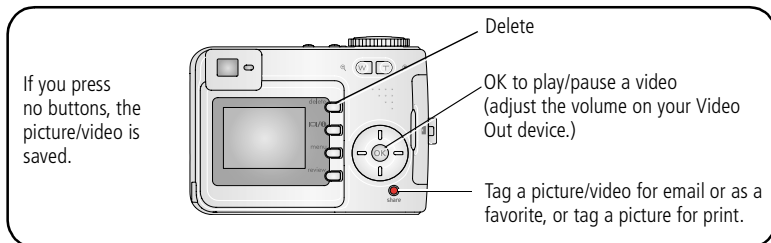

To view pictures and videos anytime, see [page 9](#).

Checking camera and picture status

Press the LCD On/Off/Status  button to see the active camera and picture settings.

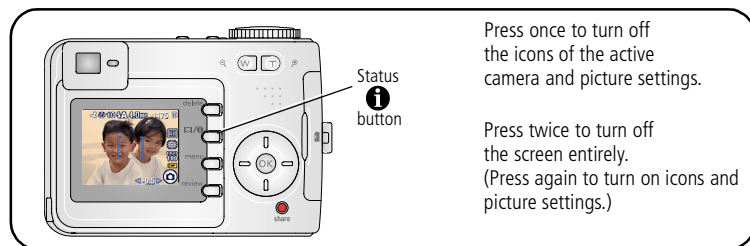





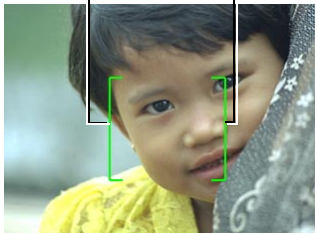

Using the auto-focus framing marks (pictures)

When using the LCD screen as a viewfinder, framing marks indicate where the camera is focusing. For the best pictures, the camera attempts to focus on foreground subjects, even if the subjects are not centered in the scene.

- 1 Press the Shutter button **halfway**.

When the framing marks turn green, focus is accomplished.

While the shutter button is pressed halfway:	
	 Center focus
	 Center wide focus
	 Side focus
	 Center and side focus
	 Left and right focus

- 2 If the camera is not focusing on the desired subject (or if the framing marks disappear), release the Shutter button and recompose the scene.
- 3 Press the Shutter button **completely down** to take the picture.

NOTE: Framing marks do not appear in Landscape, Fireworks, or Video mode. When you use Focus Zone (page 30) and set Center Zone, the framing marks are fixed at Center Wide.

Capture mode

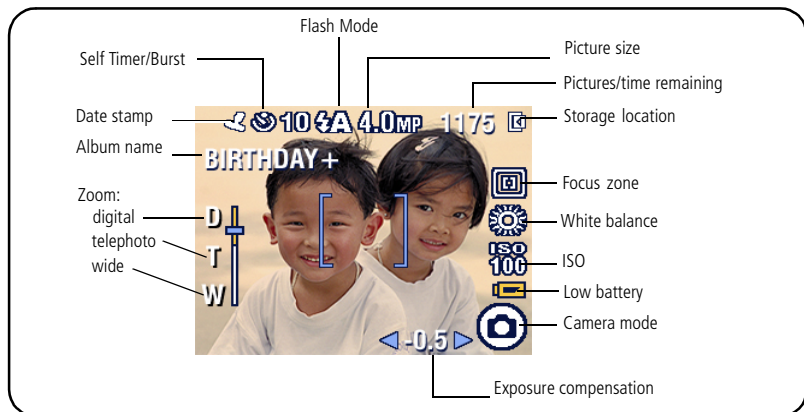

Using optical zoom

Use optical zoom to get up to 3X closer to your subject. Optical zoom is effective when the lens is no closer than 2 ft (0.6 m) to the subject or 5 in. (13 cm) in Close-up mode. You can change optical zoom before (but not during) video recording.

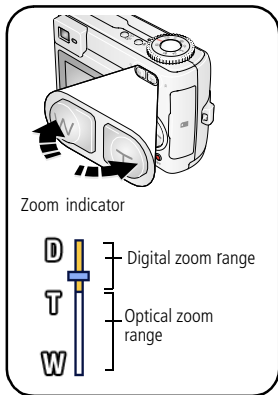

- 1 Use the Viewfinder or LCD screen to frame your subject.
- 2 Press Telephoto (T) to zoom in. Press Wide Angle (W) to zoom out.
The Zoom indicator shows zoom status.
- 3 Press the Shutter button **halfway** to set the exposure and focus, then press **completely down** to take the picture. (When taking videos, press and release the Shutter button.)

Using digital zoom

Use digital zoom in any Still mode to get an additional 5X magnification beyond optical zoom. Combined zoom settings are from 3X to 15X.

- 1 Press the Telephoto (T) button to the optical zoom limit (3X). Release the button, then press it again.
The Zoom indicator shows zoom status.
- 2 Take the picture.

NOTE: You cannot use digital zoom for video recording. You may notice decreased image quality when using digital zoom. The blue slider on the zoom indicator pauses and turns red when the picture quality reaches the limit for an acceptable 4 x 6-in. (10 x 15 cm) print.

Using the flash

Use the flash when you take pictures at night, indoors, or outdoors in heavy shadows.

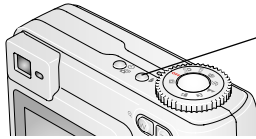

Press the  button repeatedly to scroll through flash modes (see Flash modes table).

The active flash icon is displayed in the LCD screen.

To change the flash settings, see [page 26](#).



Flash-to-subject distance	
Zoom position	Flash distance
Wide angle	2–12 ft (0.6–3.6 m) @ ISO 140
Telephoto	2–7 ft (0.6–2.1 m) @ ISO 140

Reviewing pictures and videos

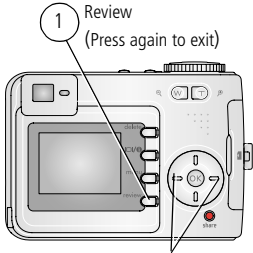



Press the Review button to view and work with your pictures and videos.



1 Review
(Press again to exit)

2   (previous/next)

Videos:

- OK to play/pause
-   Adjust the volume
-  Rewind to beginning (during playback)
-  Next picture/video (during playback)

To save battery power, use the optional Kodak EasyShare camera or printer dock, or Kodak 3-volt AC adapter. (See www.kodak.com/go/c330accessories.)

NOTE: Pictures taken at the 3.5 MP (3:2) quality setting are displayed at a 3:2 aspect ratio with a black bar at the top of the screen.

What the review icons mean

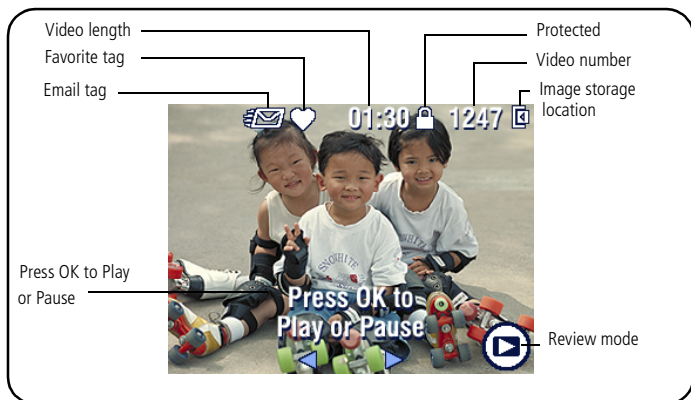

Magnifying a picture during review

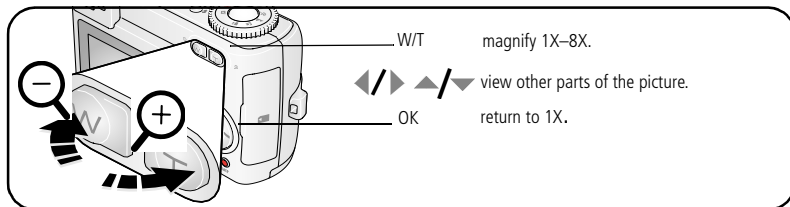

Viewing multi-up (thumbnails) during review

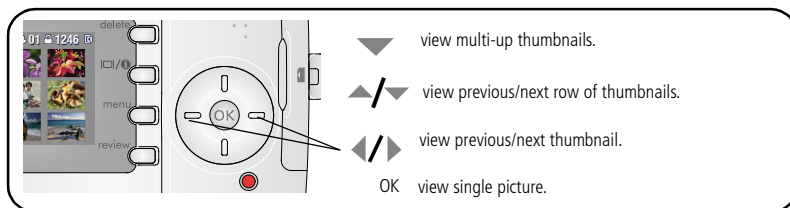

Cropping a picture during review

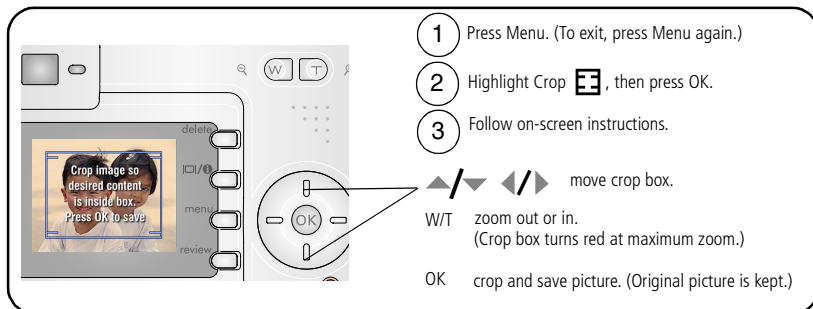

NOTE: Cropping may not be supported for images captured on other digital cameras.

Pictures under 2.1 MP cannot be cropped.

Protecting pictures and videos from deletion

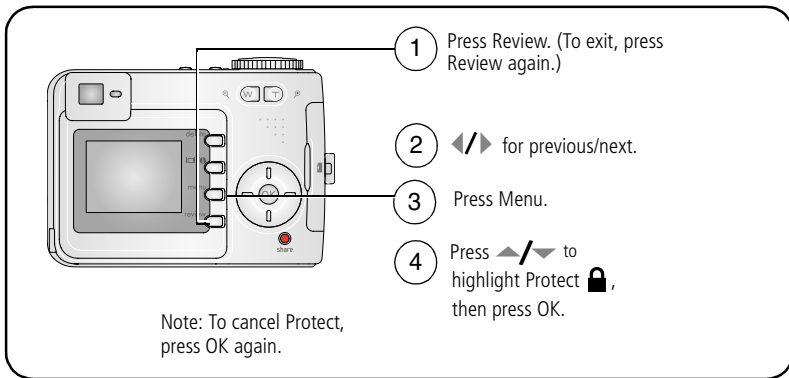

The picture or video is protected and cannot be deleted. The Protect icon  appears with the protected picture or video.

Press the Menu button to exit the menu.



CAUTION:

Formatting internal memory or an SD or MMC card deletes all (including protected) pictures, videos. (Formatting internal memory also deletes email addresses, album names, and favorites. To restore them, see EasyShare software Help.)

Deleting pictures and videos

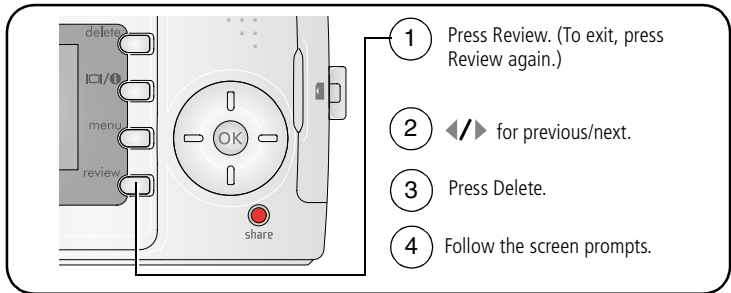

PICTURE or VIDEO—deletes the displayed picture or video.

EXIT—exits the Delete screen.

ALL—deletes all pictures and videos from your current storage location.

NOTE: To delete protected pictures and videos, remove protection before deleting.

3

Transferring and printing pictures



CAUTION:

Install Kodak EasyShare software *before* connecting the camera or optional dock to the computer. Failure to do so may cause the software to load incorrectly.

Minimum system requirements

Windows OS-based computers

- Windows 98, 98SE, ME, 2000 SP1, or XP OS
- Internet Explorer 5.01 or higher
- 233 MHz processor or greater
- 64 MB RAM (128 MB RAM for Windows XP OS)
- 200 MB hard disk space available
- CD-ROM drive
- Available USB port
- Color monitor, 800 x 600 pixels (16-bit or 24-bit recommended)

Macintosh computers

- Power Mac G3, G4, G5, G4 Cube, iMac; PowerBook G3, G4; or iBook computers
- Mac OS X version 10.2.3, 10.3
- Safari 1.0 or higher
- 128 MB RAM
- 200 MB hard disk space available
- CD-ROM drive
- Available USB port
- Color monitor, 1024 x 768 pixels (thousands or millions of colors recommended)

NOTE: To download EasyShare software, visit www.kodak.com/go/c330downloads.

Installing the software



CAUTION:

Install Kodak EasyShare software *before* connecting the camera or optional dock to the computer. Failure to do so may cause the software to load incorrectly.

- 1 Close all software applications that are open on your computer (including anti-virus software).
- 2 Place the Kodak EasyShare software CD into the CD-ROM drive.
- 3 Load the software:

Windows OS-based computer—if the install window does not appear, choose Run from the Start menu and type **d:\setup.exe** where **d** is the drive letter that contains the CD.

Mac OS X—double-click the CD icon on the desktop, then click the Install icon.

- 4 Follow the on-screen instructions to install the software.

Windows OS-based computer—select Typical to automatically install the most commonly used applications. Select Custom to choose the applications you wish to install.

Mac OS X—follow the on-screen instructions.

NOTE: When prompted, take a few minutes to electronically register your camera and software. This lets you receive information regarding software updates and registers some of the products included with the camera. You must be connected to your Internet service provider to register electronically. To register later, see www.kodak.com/go/register.

- 5 If prompted, restart the computer. If you turned off anti-virus software, turn it back on. See the anti-virus software manual for details.

For information on the software applications included on the Kodak EasyShare software CD, click the Help button in the Kodak EasyShare software.

Transferring pictures with the USB cable

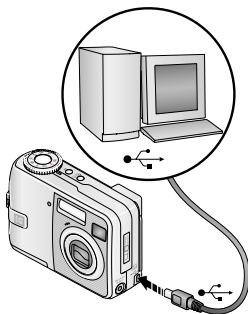

- 1 Turn off the camera.
- 2 Plug the labeled end of the USB cable into the labeled USB port on your computer. See your computer user's guide for details.
- 3 Plug the other end of the USB cable into the labeled USB port on the camera.
- 4 Turn on the camera.

Kodak EasyShare software opens on your computer. The software prompts you through the transfer process.

NOTE: Visit www.kodak.com/go/howto for an online tutorial on connecting.

Also available for transferring

You can also use these Kodak products to transfer your pictures and videos.

- Kodak EasyShare camera dock, Kodak EasyShare printer dock (see [page 20](#))
- Kodak multi-card reader, Kodak SD multimedia card reader-writer

Purchase these and other accessories at a dealer of Kodak products or www.kodak.com/go/c330accessories.

Printing pictures

Printing with a Kodak EasyShare printer dock

Dock your camera to the Kodak EasyShare printer dock and print directly—with or without a computer. The printer dock may require a D-22 Adapter (see [page 20](#)). Purchase this and other accessories at a dealer of Kodak products or www.kodak.com/go/c330accessories.

Direct printing with a PictBridge enabled printer

Your camera is compatible with PictBridge technology, so you can print directly to PictBridge enabled printers. You need:

- Camera with fully-charged batteries, or with optional Kodak 3-volt AC adapter
- PictBridge enabled printer
- USB cable (may be sold separately)

Connecting the camera to a PictBridge enabled printer

- 1 Turn off the camera and printer.
- 2 Optional: If you have a Kodak 3-volt AC adapter (optional accessory), plug it into the camera and into an electrical outlet.
- 3 Connect the appropriate USB cable from the camera to the printer. (See your printer user guide or www.kodak.com/go/c330accessories for details.)

Printing from a PictBridge enabled printer

- 1 Turn on the printer. Turn on the camera.

The PictBridge logo is displayed, followed by the current picture and menu. (If no pictures are found, a message is displayed.) If the menu interface turns off, press any button to redisplay it.

- 2 Press ▲/▼ to choose a printing option, then press the OK button.

Current Picture	Press ◀/▶ to choose a picture. Choose the number of copies.
Tagged Pictures	If your printer is capable, print pictures that you tagged for printing and choose a print size.
Index Print	Print thumbnails of all pictures. This requires one or more sheets of paper. If the printer is capable, choose a print size.
All Pictures	Print all pictures in internal memory, on a card, or in Favorites. Choose the number of copies.
Image Storage	Access internal memory, a card, or Favorites.

NOTE: During direct printing, pictures are not permanently transferred or saved to the computer or printer. To transfer pictures to your computer, see [page 14](#). In Favorites mode, the current favorite picture is displayed.

Disconnecting the camera from a PictBridge enabled printer

- 1 Turn off the camera and printer.
- 2 Disconnect the USB cable from the camera and the printer.

Ordering prints online

Kodak EasyShare Gallery (www.kodakgallery.com) is one of the many online print services offered in the Kodak EasyShare software. You can easily:

- Upload your pictures.
- Edit, enhance, and add borders to your pictures.
- Store pictures, and share them with family and friends.
- Order high-quality prints, photo greeting cards, frames, and albums—and have them delivered to your door.

Printing pictures from your computer

For details on printing pictures from your computer, click the Help button in the Kodak EasyShare software.

Printing from an optional SD or MMC card

- Automatically print tagged pictures when you insert your card into a printer with an SD or MMC card slot. See your printer user's guide for details.
- Make prints at an SD or MMC card-capable Kodak picture maker. (Contact a location prior to visiting. See www.kodak.com/go/picturemaker.)
- Take the card to your local photo retailer for professional printing.

Dock compatibility for your camera

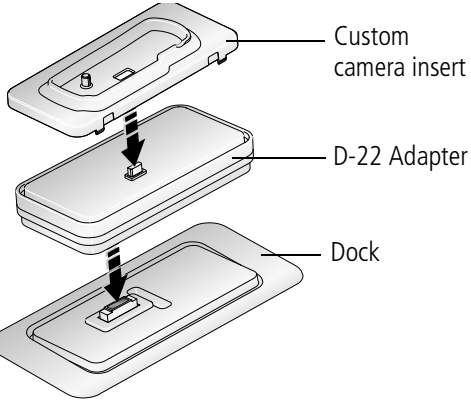
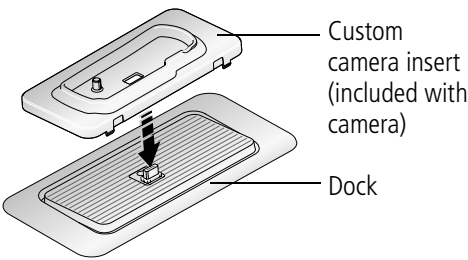
Kodak EasyShare dock	Docking configuration
<ul style="list-style-type: none"> ■ printer dock 4000 ■ camera dock II ■ LS420, LS443 camera dock 	<p>Not compatible</p>
<ul style="list-style-type: none"> ■ printer dock ■ printer dock plus ■ printer dock 6000 ■ camera dock 6000 	 <p>Custom camera insert</p> <p>D-22 Adapter</p> <p>Dock</p>
<ul style="list-style-type: none"> ■ others, including series 3 printer docks and camera docks 	 <p>Custom camera insert (included with camera)</p> <p>Dock</p>

Purchase camera docks, printer docks, and other accessories at a dealer of Kodak products or www.kodak.com/go/c330accessories.

4

Doing more with your camera

Using the self-timer

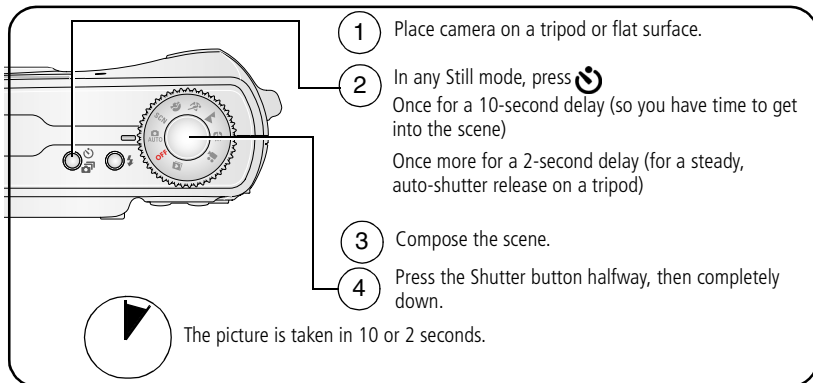

To cancel the self-timer before the picture is taken, press the Self-timer button.

The self-timer cancels after you take the picture.



Using the self-timer for video

Use the same procedure as above, but:

- Turn the Mode dial to video .
- Press the Shutter button completely down.

NOTE: The video stops when you press the Shutter button or when no storage space remains.

Using burst

Option	Description	Purpose
 Burst	Camera takes up to 3 pictures (2 per second) while the Shutter button is pressed.  First 3 pictures are saved.	Capture an expected event. Example: A person swinging a golf club.

- 1 In most Still modes, press the Self Timer/Burst button repeatedly to choose the Burst option.
- 2 Press the Shutter button **halfway** to set the auto focus and exposure.
- 3 Press the Shutter button **completely down and hold it** to take the pictures.
The camera stops taking pictures when you release the Shutter button, when the pictures are taken, or when there is no more storage space.

NOTE: During Quickview, you can delete all pictures in the burst series. To delete selectively, do so in Review (see [page 13](#)).

Running a slide show

Use the Slide Show to display your pictures and videos on the LCD screen. To run a slide show on a television or on any external device, see [page 24](#). To save battery power, use an optional Kodak 3-volt AC adapter. (Visit www.kodak.com/go/c330accessories.)

Starting the slide show

- 1 Press the Review button, then press the Menu button.
- 2 Press $\blacktriangle/\blacktriangledown$ to highlight Slide Show , then press the OK button.
- 3 Press $\blacktriangle/\blacktriangledown$ to highlight Begin Show, then press the OK button.

Each picture and video is displayed once.

To interrupt the Slide Show, press the OK button.

Changing the slide show display interval

The default interval setting displays each picture for 5 seconds. You can set the display interval from 3 to 60 seconds.

- 1 On the Slide Show menu, press $\blacktriangle/\blacktriangledown$ to highlight Interval, then press the OK button.
- 2 Select a display interval.
To scroll through the seconds quickly, press and hold $\blacktriangle/\blacktriangledown$.
- 3 Press the OK button.

The interval setting remains until you change it.

Running a continuous slide show loop

When you turn on Loop, the slide show is continuously repeated.

- 1 On the Slide Show menu, press ▲/▼ to highlight Loop, then press the OK button.
- 2 Press ▲/▼ to highlight On, then press the OK button.

The slide show repeats until you press the OK button or until battery power is exhausted. The Loop feature remains until you change it.

Displaying pictures and videos on a television

You can display pictures and videos on a television, computer monitor, or any device equipped with a video input. (Image quality on a television screen may not be as good as on a computer monitor or when printed.)

NOTE: Ensure that the Video Out setting (NTSC or PAL) is correct (see [page 32](#)). The slide show stops if you connect or disconnect the cable while the slide show is running.

- 1 Connect an audio/video cable (sold separately) from the camera USB, A/V Out port to the television video-in port (yellow) and audio-in port (white). See your television user's guide for details.
- 2 Review pictures and videos on the television.

Copying pictures and videos

You can copy pictures and videos from a card to internal memory or from internal memory to a card.

Before you copy, make sure that:

- A card is inserted in the camera.
- The camera's picture storage location is set to the location **from** which you are copying. See [Image Storage, page 31](#).

NOTE: If Auto is selected as your camera's image storage location, you can only copy pictures and videos from the memory card.

Copy pictures or videos:

- 1 Press the Review button, then press the Menu button.
- 2 Press $\blacktriangle/\blacktriangledown$ to highlight Copy \blacktriangleright , then press the OK button.
- 3 Press $\blacktriangle/\blacktriangledown$ to highlight an option:

PICTURE or VIDEO—copies the current picture or video.

EXIT—returns to the Review menu.

ALL—copies all pictures and videos from your selected storage location to the other location.

- 4 Press the OK button.

NOTE: Pictures and videos are copied, not moved. To remove pictures and videos from the original location after copying, delete them (see [page 13](#)).

Tags that you applied for print, email, and favorites are not copied. Protection settings are not copied. To apply protection to a picture or video, see [page 12](#).



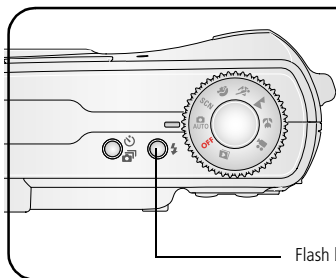

Changing the flash settings



Press the Flash button repeatedly to scroll through flash modes (see Flash modes table).





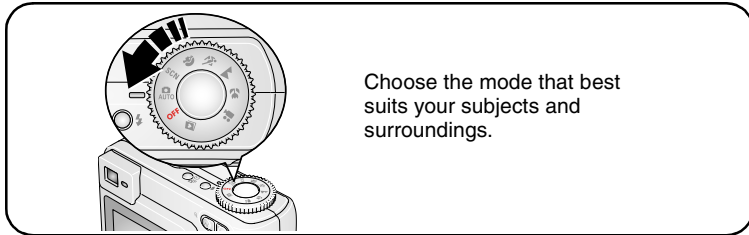

The active flash icon is displayed in the LCD screen.

NOTE: Flash settings are pre-set for each picture-taking mode. Some of the flash settings may not be available in all Capture or Scene modes. When you change to Auto or Red-eye in some of these modes, it becomes the default until you change it.

Flash modes	Flash fires
 Auto Flash	When the lighting conditions require it.
 Fill	Every time you take a picture, regardless of the lighting conditions. Use when the subject is in shadow or is “backlit” (when light is behind the subject). In low light, hold the camera steady or use a tripod.
 Red-eye	Once, so the subject’s eyes become accustomed to the flash, then fires again when the picture is taken. (If the lighting conditions require flash but do not require Red-eye reduction, the flash may fire only once.)
 Off	Never

Picture-taking modes











Use this mode	For
 Auto AUTO	General picture-taking—offers an excellent balance of image quality and ease of use.
SCN Scene	Point-and-shoot simplicity when taking pictures under 11 special conditions including Color, Black & White, and Sepia. (For SCN modes, see page 28 .)
 Portrait	Full-frame portraits of people. Use Telephoto to exaggerate background blur.
 Sport	Subjects that are in motion. Shutter speed is fast.
 Landscape	Distant subjects. Flash does not fire unless you turn it on. Auto-focus framing marks (page 6) are not available in Landscape.
 Close-up	Close subjects 5–27.6 in. (13–70 cm) from the lens in Wide Angle; 8.7–27.6 in. (22–70 cm) in Telephoto. Use available light instead of flash if possible. Use the LCD screen to frame the subject.
 Video	Capturing video with sound (see page 4).

Scene modes

- 1 Turn the Mode dial to Scene **SCN**.
- 2 Press ◀/▶ to display Scene mode descriptions.

NOTE: If the Scene mode description turns off, press the OK button.



- 3 Press the OK button to choose a Scene mode.



Use this SCN mode	For
 Children	Action pictures of children in bright light.
 Party	People indoors. Minimizes red eye.
 Night Portrait	Reduces red eye of people in night scenes or low-light conditions. Place the camera on a flat, steady surface or use a tripod.
 Beach	Bright beach scenes.
 Snow	Bright snow scenes.
 Fireworks	Flash does not fire. Place the camera on a flat, steady surface or use a tripod.
 Self-Portrait	Close-ups of yourself. Assures proper focus and minimizes red eye.
 Backlight	Subjects that are in shadow or “backlit” (when light is behind the subject).







Changing picture-taking settings

You can change settings to get the best results from your camera:

- 1 Press the Menu button. (Some settings are unavailable in some modes.)
- 2 Press ▲/▼ to highlight the setting you wish to change, then press the OK button.
- 3 Choose an option, then press the OK button.
- 4 Press the Menu button to exit.

Setting	Icon	Options
<p>Exposure Compensation (Still mode)</p> <p>Choose how much light enters the camera.</p> <p><i>This setting remains until you turn the Mode dial.</i></p>		<p>If pictures are too light, decrease the value. If pictures are too dark, increase the value.</p> <p>NOTE: When the camera screen is on in any Still capture mode, press ◀/▶ to adjust exposure compensation.</p> <p>Exposure Compensation returns to zero if Long Time Exposure is set.</p> <p>Unavailable in Video mode.</p>
<p>Picture Size</p> <p>Choose a picture resolution.</p> <p><i>This setting remains until you change it.</i></p>		<p>4.0 MP (default)—for printing up to 20 x 30 in. (51 x 76 cm); pictures are highest resolution and largest file size.</p> <p>3.5 MP (3:2 Best)—ideal for printing 4 x 6 in. (10 x 15 cm) prints without cropping. Also for printing up to 20 x 30 in. (51 x 76 cm); some cropping may result due to the 3:2 aspect ratio.</p> <p>3.1 MP—for printing up to 11 x 14 in. (28 x 36 cm); pictures are medium resolution with smaller file size.</p> <p>2.1 MP—for printing up to 8 x 10 in. (20 x 25 cm); pictures are medium resolution with smaller file size.</p> <p>1.1 MP—for printing up to 5 x 7 in. (13 x 18 cm); for emailing, Internet, or screen display; pictures are lowest resolution and smallest file size.</p>







Setting	Icon	Options
<p>Video Size Choose a video resolution. <i>This setting remains until you change it.</i></p>		<p>320 x 240—lower resolution and file size. Video plays in a 320 x 240 pixel window (QVGA).</p>
<p>White Balance Choose your lighting condition. <i>This setting remains until you turn the Mode dial.</i></p>		<p>Auto (default)—automatically corrects white balance. Ideal for general picture taking.</p> <p>Daylight—for pictures in natural lighting.</p> <p>Tungsten—corrects the orange cast of household light bulbs. Ideal for indoor pictures under tungsten or halogen lighting without flash.</p> <p>Fluorescent—corrects the green cast of fluorescent lighting. Ideal for indoor pictures under fluorescent lighting without flash.</p> <p>Unavailable in Video mode.</p>
<p>ISO Speed Control the camera's sensitivity to light <i>This setting remains until you turn the Mode dial.</i></p>	ISO	<p>Choose a lower ISO setting in brightly lit scenes; use a higher ISO for low-light scenes. Choose Auto (default), 80, 100, 200, 400.</p> <p>NOTE: ISO speed changes depending on whether the flash is on or off.</p> <p>ISO returns to Auto when the camera is set to Sport, Portrait, or Scene mode, or during Long Time Exposure.</p> <p>Unavailable in Video mode.</p>
<p>Focus Zone Select a large or concentrated area of focus. <i>This setting remains until you turn the Mode dial.</i></p>		<p>Multi-zone (default)—evaluates 2 zones to give an even picture focus. Ideal for general picture taking.</p> <p>Center-zone—evaluates the small area centered in the viewfinder. Ideal when precise focus of a specific area in the picture is needed.</p> <p>NOTE: For the best pictures, the camera is set to Multi-zone when in Landscape mode.</p> <p>Unavailable in video mode.</p>





Setting	Icon	Options
<p>Color Mode</p> <p>Choose color tones.</p> <p><i>This setting remains until you turn the Mode dial or turn off the camera.</i></p>		<p>Color (default)</p> <p>Black & White</p> <p>Sepia—for pictures with a reddish-brown, antique look.</p> <p>NOTE: EasyShare software also lets you change a color picture to black-and-white or sepia.</p> <p>Unavailable in Video mode.</p>
<p>Long Time Exposure</p> <p>Choose how long the shutter stays open.</p> <p><i>This setting remains until you turn the Mode dial.</i></p>		<p>Up to 4 seconds.</p> <p>NOTE: When Long Time Exposure is set, Exposure Compensation is set to zero and ISO is set to Auto.</p>
<p>Image Storage</p> <p>Choose a storage location for pictures and videos.</p> <p><i>This setting remains until you change it.</i></p>		<p>Auto (default)—the camera uses the card if one is in the camera. If not, the camera uses internal memory.</p> <p>Internal Memory—the camera always uses internal memory, even if a card is installed.</p>
<p>Set Album (Still)</p> <p>Choose Album names.</p> <p><i>This setting remains until you change it. You can apply different Set Album choices.</i></p>		<p>On or Off.</p> <p>Pre-select album names before you take pictures or videos. Then, all the pictures or videos you take are tagged with those album names. See page 35.</p>
<p>Video Length</p> <p>Choose video duration.</p>		<p>Continuous (default)— as long as there is room on the card or internal memory, or until the Shutter button is pressed.</p> <p>5, 15, or 30—seconds</p>
<p>Setup Menu</p> <p>Choose additional settings.</p>		<p>See Customizing your camera.</p>

Customizing your camera

Use Setup to customize your camera settings.

- 1 In any mode, press the Menu button.
- 2 Press ▲/▼ to highlight Setup , then press the OK button.
- 3 Press ▲/▼ to highlight the setting you wish to change, then press the OK button.
- 4 Choose an option, then press the OK button.
- 5 Press the Menu button to exit.

Setting	Icon	Options
Return to previous menu.		
Liveview Change Liveview default to on or off.		On Off (default) Available only in Auto and Landscape.
Auto Power Off Select when you would like the camera to go to sleep.		3 minutes (default) 1, 3, 5, or 10 minutes
Date & Time		See page 2 .
Video Out Choose the regional setting that lets you connect the camera to a television or other external device.		NTSC (default) —used in North America and Japan; most common format. PAL —used in Europe and China.
Orientation Sensor Orient pictures so that they are displayed with the correct side up.		On (default) Off
Date Stamp Imprint the date on pictures.		Choose a date option, or turn off the feature. (Default is off.)







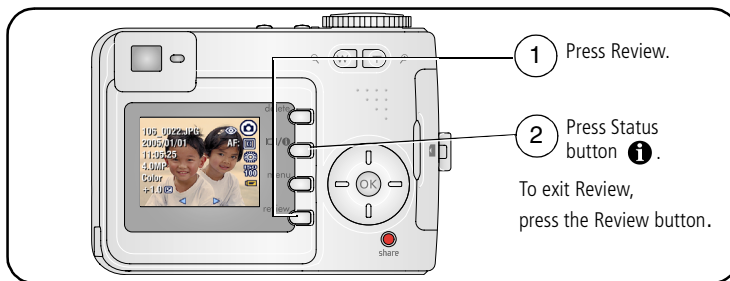

Setting	Icon	Options
Video Date Display Display Date/Time at the start of video playback.		On (default) —choose from 3 date formats. Off
Language Choose a language.		See page 3 .
Format  CAUTION: Formatting deletes all pictures and videos, including those that are protected. Removing a card during formatting may damage the card.		Memory Card —deletes everything on the card; formats the card. Cancel —exits without making a change. Internal Memory —deletes everything in internal memory including email addresses, album names, and favorites; formats the internal memory.
About View camera information.		Camera model and firmware version.

Viewing picture/video information

In Review mode, press the Menu button to access optional review settings.



Changing other settings

	Album (page 35)		Copy (page 25)
	Crop (page 11)		Protect (page 12)
	Slide Show (page 23)		Image Storage (page 31)
	Multi-up (page 11)		Setup Menu (page 31)

Pre-tagging for album names

Use the Set Album (Still or Video) feature to pre-select album names before you take pictures or videos. Then, all the pictures or videos you take are tagged with those album names.

First—on your computer

Use Kodak EasyShare software that came with your camera to create album names on your computer. Then copy up to 32 album names to the album name list on your camera the next time you connect the camera to the computer. See Kodak EasyShare software Help for details.

Second—on your camera

- 1 In any mode, press the Menu button.
- 2 Press $\blacktriangle/\blacktriangledown$ to highlight Set Album , then press the OK button.
- 3 Press $\blacktriangle/\blacktriangledown$ to highlight an album name, then press the OK button. Repeat to mark pictures or videos for albums.

Selected albums are noted with a check mark.

- 4 Highlight Exit, then press the OK button.

Your selections are saved. If you turn on the LCD screen, your album selection is displayed on the screen. A plus (+) after the album name means more than one album is selected.

- 5 Press the Menu button to exit the menu.

To remove a selection, highlight an album name and press the OK button. To remove all album selections, select Clear All.

Third—transfer to your computer

When you transfer the tagged pictures and videos to your computer, Kodak EasyShare software opens and categorizes your pictures and videos in the appropriate album. See Kodak EasyShare software Help for details.

Tagging pictures/videos for albums

Use the Album feature in Review mode to tag the pictures and videos in your camera with album names.

First—on your computer

Use Kodak EasyShare software that came with your camera to create album names on your computer, then copy up to 32 album names to the camera's internal memory. See Kodak EasyShare software Help for details.

Second—on your camera

- 1 Press the Review button, then locate the picture or video.
- 2 Press the Menu button.
- 3 Press $\blacktriangle/\blacktriangledown$ to highlight Album , then press the OK button.
- 4 Press $\blacktriangle/\blacktriangledown$ to highlight an album folder, then press the OK button.

To add other pictures to the same album, press $\blacktriangleleft/\blacktriangleright$ to scroll through the pictures. When the picture you want is displayed, press the OK button.

To add the pictures to more than one album, repeat step 4 for each album.

The album name appears with the picture. A plus (+) after the album name means the picture was added to more than one album.

To remove a selection, highlight an album name and press the OK button. To remove all album selections, select Clear All.

Third—transfer to your computer

When you transfer the tagged pictures and videos to your computer, Kodak EasyShare software opens and categorizes your pictures and videos in the appropriate album. See Kodak EasyShare software Help for details.

Sharing your pictures

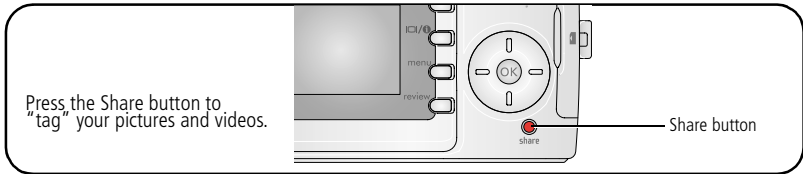

When they are transferred to your computer, you can share them by:

- Print ([page 37](#)).
- Email ([page 38](#)).
- Favorites ([page 39](#)).

When can I tag my pictures and videos?

Press the Share button to tag pictures/videos:

- Any time. (The most recent picture/video taken is then displayed.)
- Just after you take a picture/video, during Quickview (see [page 5](#)).
- After pressing the Review button (see [page 9](#)).

Tagging pictures for printing

- 1 Press the Share button. Press **◀/▶** to locate a picture.
- 2 Press **▲/▼** to highlight Print , then press the OK button.
- 3 Press **▲/▼** to select the number of copies (0-99). Zero removes the tag for that picture.

The Print icon  appears in the status area. The default quantity is one.

- 4 **Optional:** You can apply a print quantity to other pictures. Press **◀/▶** to locate a picture. Keep the print quantity as is, or press **▲/▼** to change it. Repeat this step until the desired print quantity is applied to the pictures.

- 5 Press the OK button. Then press the Share button to exit the menu.

NOTE: To tag all pictures in the storage location, highlight Print All, press the OK button, then indicate the number of copies. To remove print tagging for all pictures in the storage location, highlight Cancel Prints, then press the OK button. Print All and Cancel Prints are not available in Quickview.

Printing tagged pictures

When you transfer the tagged pictures to your computer, the Kodak EasyShare software print screen opens. For details on printing, click the Help button in the Kodak EasyShare software.

For more information on printing from your computer, printer dock, PictBridge enabled printer, or card, see [page 17](#).

NOTE: For the best 4 x 6 in. (10 x 15 cm) prints, set the camera to the 3.5 MP (3:2) print quality setting. See [page 29](#).

Tagging pictures and videos for emailing

First—on your computer

Use Kodak EasyShare software to create an email address book on your computer. Then, copy up to 32 email addresses to the camera's internal memory. For details, click the Help button in the Kodak EasyShare software.

Second—tag pictures/videos on your camera

- 1 Press the Share button. Press   to locate a picture/video.
- 2 Press   to highlight Email , then press the OK button.
The Email icon  appears in the status area.
- 3 Press   to highlight an email address, then press the OK button.

To tag other pictures/videos with the same address, press   to scroll through them. When the picture you want is displayed, press OK.

To send the pictures/videos to more than one address, repeat step 3 for each address.

Selected addresses are checked.

4 Press ▲/▼ to highlight Exit, then press the OK button.

5 Press the Share button to exit the menu.

To remove a selection, highlight a checked address and press the OK button. To remove all email selections, highlight Clear All.

Third—transfer and email





When you transfer the tagged pictures/videos to your computer, the Email screen opens and lets you send them to the addresses you specified. For details, click the Help button in the Kodak EasyShare software.

Tagging pictures as favorites

You can preserve your favorite pictures in the Favorites  section of your camera's internal memory, then share them with friends and family.

NOTE: When you transfer pictures from your camera to your computer, all pictures (including favorites) are stored on your computer at full size. Favorite pictures—smaller copies of your originals—are loaded back to your camera, so you can share and enjoy more.

Share your favorite pictures in 4 easy steps:

<p>1. Take pictures</p> 	
<p>2. Tag pictures as favorites</p> 	<p>1 Press the Share button. Press ◀/▶ to locate a picture.</p> <p>2 Press ▲/▼ to highlight Favorite , then press the OK button.</p> <p><i>The Favorite icon  appears in the status area. To remove the tag, press the OK button again.</i></p> <p>Press the Share button to exit the menu.</p>

3. Transfer pictures to your computer

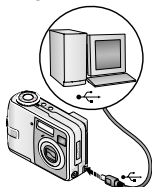



- 1 To enjoy full functionality, install and use the EasyShare software that was packaged with this camera. (See [page 15](#).)
- 2 Connect the camera to the computer using the USB cable (see [page 16](#)) or an EasyShare dock.

The first time you transfer pictures, the software helps you make choices about your favorite pictures. Then, your pictures are transferred to the computer. Favorite pictures (smaller versions of the originals) are loaded to the Favorites section of your camera's internal memory.

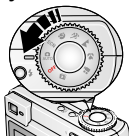
4. View favorites on your camera







- 1 Turn the Mode dial to Favorites .
- 2 Press  /  to scroll through favorites.

To exit Favorites mode, turn the Mode dial to any other position.

NOTE: The camera holds a limited number of favorites. Use Camera Favorites in the EasyShare software to customize the size of your camera Favorites  section. Videos tagged as favorites remain in the Favorites folder in the EasyShare software. For more information, click the Help button in the Kodak EasyShare software.



Optional settings

In Favorites mode, press the Menu button to access optional settings.

	Slide Show (page 23)		Picture Information (page 34)
	Multi-up (page 11)		Remove all favorites (page 41)
			Setup Menu (page 31)

NOTE: Pictures taken at the 3.5 MP (3:2) quality setting are displayed at a 3:2 aspect ratio with a black bar at the top of the screen. (See [Picture Size, page 29](#).)

Removing all favorites from your camera

- 1 Turn the Mode dial to Favorites .
- 2 Press the Menu button.
- 3 Highlight , then press the OK button.

All pictures stored in the Favorites section of internal memory are removed. Favorites are restored the next time you transfer pictures to the computer.





- 4 Press the Menu button to exit the menu.

Preventing favorites from transferring to the camera

- 1 Open the Kodak EasyShare software. Click the My Collection tab.
- 2 Go to the Albums view.
- 3 Click the Camera Favorites Album for your camera.
- 4 Click Remove Album.

The next time you transfer pictures from your camera to the computer, use the Camera Favorites Wizard/Assistant in the Kodak EasyShare software to either recreate your Camera Favorites Album or to turn off the Camera Favorites feature.

Printing and emailing favorites

- 1 Turn the Mode dial to Favorites . Press /  to locate a picture.
- 2 Press the Share button.
- 3 Highlight Print  or Email , then press the OK button.

NOTE: Favorites that were taken on this camera (not imported from another source) are good for prints up to 4 x 6 in. (10 x 15 cm).

5

Troubleshooting

For step-by-step product support, visit www.kodak.com/go/c330support and select Interactive Troubleshooting & Repairs.

Camera problems

If...	Try one or more of the following
Camera does not turn on	<ul style="list-style-type: none"> ■ Remove battery and verify that it's the correct type, then reinsert it. ■ Insert a new or charged battery.
Camera does not turn off and the lens does not retract	<ul style="list-style-type: none"> ■ Connect the camera to a Kodak 3-volt AC adapter (sold separately), then try again. See page 57 for more battery information.
Camera buttons and controls do not function	
Lens does not extend when camera turns on or does not retract	<ul style="list-style-type: none"> ■ Confirm that the battery in camera is charged. ■ Turn camera off, then on again. (Lens does not extend in Favorites mode.) ■ If problem still exists, get help (page 47).
In Review, a blue or black screen is displayed instead of a picture	<ul style="list-style-type: none"> ■ Transfer the picture to the computer. ■ Transfer <i>all</i> pictures to the computer (page 16). ■ Take another picture. If problem still continues try internal memory and/or another memory card.
Pictures remaining number does not decrease after taking a picture	<ul style="list-style-type: none"> ■ Continue taking pictures. The camera is operating normally. (The camera estimates the number of pictures remaining after each picture is taken, based on picture size and content.)

If...	Try one or more of the following
Flash does not fire	<ul style="list-style-type: none"> ■ Check the flash setting and change as needed (page 26). <p>NOTE: The flash does not fire in all modes.</p>
Storage location is almost or entirely full	<ul style="list-style-type: none"> ■ Transfer pictures to the computer (page 16). ■ Delete pictures from the card or insert a new one (page 13). ■ Change image storage location to internal memory (page 31).
Battery life is short	<ul style="list-style-type: none"> ■ Make sure the correct battery type is loaded (page 1). ■ Wipe the contacts with a clean, dry cloth (page 57) before inserting a battery in the camera. ■ Insert a new or charged battery (page 1).
You cannot take a picture	<ul style="list-style-type: none"> ■ Turn the camera off, then on again. Make sure the camera is not in Favorites mode. ■ Depress shutter button completely down (page 4). ■ Insert a new or charged battery (page 1). ■ Wait until the Ready light glows green before attempting to take another picture. ■ Memory full. Transfer pictures to the computer (page 16), delete pictures from the camera (page 13), change image storage location, or insert a new card.
Error message appears on LCD screen	<ul style="list-style-type: none"> ■ Turn the camera off. ■ Remove memory card from the camera. ■ Remove the battery and wipe the contacts with a clean, dry cloth (page 57). ■ Insert a new or charged battery (page 1). ■ Turn on the camera. ■ If all else fails, get customer support help (page 48).
Memory card not recognized or camera freezes with card.	<ul style="list-style-type: none"> ■ Card may be corrupted. Format card in camera (page 33). ■ Use another memory card.

Computer/connectivity problems

If...	Try one or more of the following
Computer does not communicate with the camera	<ul style="list-style-type: none"> ■ Insert a charged battery (page 1). ■ Turn on the camera. ■ Make sure proper USB cable is securely connected on camera and computer port (page 16). (If using an EasyShare dock, check all cable connections. Make sure the camera is seated on the dock.) ■ Make sure the EasyShare software is installed (page 15).
Pictures do not transfer to computer	<ul style="list-style-type: none"> ■ Click the Help button in the EasyShare software.
Slide Show does not run on an external video device	<ul style="list-style-type: none"> ■ Adjust the camera Video Out setting (NTSC or PAL, page 32). ■ Make sure the external device settings are correct (see the device's user's guide).

Picture quality problems

If...	Try one or more of the following
Picture is too dark or underexposed	<ul style="list-style-type: none"> ■ Reposition camera for more available light. ■ Use Fill flash (page 26) or change your position so light is not behind the subject. ■ Move so that the distance between you and the subject is within the effective flash range (page 9). ■ To automatically set exposure and focus, press the Shutter button halfway. When the Ready light glows green, press the Shutter button completely down to take the picture. ■ Adjust the exposure compensation (page 29).

If...	Try one or more of the following
Picture is too light	<ul style="list-style-type: none"> ■ Reposition camera to reduce the amount of available light. ■ Turn flash off (page 26). ■ Move so that the distance between you and the subject is within the effective flash range (page 9). ■ To automatically set exposure and focus, press the Shutter button halfway. When the Ready light glows green, press the Shutter button completely down to take the picture. ■ Use Auto, Landscape, or Close-up to adjust the exposure compensation.
Picture is not clear	<ul style="list-style-type: none"> ■ To automatically set exposure and focus, press the Shutter button halfway. When the Ready light glows green, press the Shutter button completely down to take the picture. ■ Clean the lens (page 59). ■ Make sure camera is not in Close-up mode if you are more than 27.6 in. (70 cm) from your subject. ■ Place the camera on a flat, steady surface or use a tripod, especially in high-zoom settings or in low light.

Camera ready light status

If...	Try one or more of the following
Ready light does not turn on and the camera does not work	<ul style="list-style-type: none"> ■ Turn on the camera (page 2). ■ Recharge the battery or install a new one (page 1). ■ Mode dial was on when battery was reloaded. Turn Mode dial off, then back on.
Ready light blinks green	<ul style="list-style-type: none"> ■ Picture is being processed and saved to the camera. Camera is operating normally. ■ Camera is connected. Camera is operating normally.
Ready light blinks red and camera turns off	<ul style="list-style-type: none"> ■ Recharge the battery or install a new one (page 1).

Ready light glows steady green	<ul style="list-style-type: none"> Shutter button is pressed halfway down. Focus and exposure are set. Camera is operating normally.
Ready light glows steady orange	<ul style="list-style-type: none"> The Mode dial is set to Favorites. Camera is operating normally.
Ready light blinks orange	<ul style="list-style-type: none"> Flash is not charged. Wait. Resume picture-taking when the light stops blinking and turns off. Auto exposure or auto-focus are not set. Release the Shutter button and recompose the picture.
Ready light glows steady red	<ul style="list-style-type: none"> Camera's internal memory or card is full. Transfer pictures to the computer (page 16), delete pictures from camera (page 13), switch image storage locations (page 31), or insert card with available memory (page 3). Camera processing memory is full. Wait. Resume picture-taking when the light turns off. Card is read-only. Change image storage location to internal memory (page 31), or use a different card.

Direct printing (PictBridge) problems

Status	Solution
Cannot locate desired picture.	<ul style="list-style-type: none"> Turn the Mode dial to Auto. Make sure the camera is not in Favorites mode. Use the Direct print menu to change the image storage location.
The Direct print menu interface turns off.	<ul style="list-style-type: none"> Press any button to redisplay the menu.
Cannot print pictures.	<ul style="list-style-type: none"> Ensure that there is a connection between camera and printer (page 17). Ensure the printer and camera have power (page 18).
Camera or printer display an error message.	<ul style="list-style-type: none"> Follow the prompts to resolve the issue.

6

Getting help

Helpful links

Camera	Get support for your product (FAQs, troubleshooting information, etc.)	www.kodak.com/go/c330support
	Purchase camera accessories (camera docks, printer docks, lenses, cards, etc.)	www.kodak.com/go/c330accessories
	Download the latest camera firmware and software	www.kodak.com/go/c330downloads
	See online demonstrations of your camera	www.kodak.com/go/howto
Software	Get information on EasyShare software	www.kodak.com/go/easysharesw (or click the Help button in the EasyShare software)
	Get help with the Windows operating system and working with digital pictures	www.kodak.com/go/pcbasics
Other	Get support for other cameras, software, accessories	www.kodak.com/go/support
	Get information on Kodak EasyShare printer docks	www.kodak.com/go/printerdocks
	Get information on Kodak inkjet products	www.kodak.com/go/inkjet
	Optimize your printer for truer, more vibrant colors	www.kodak.com/go/onetouch
	Register your camera	www.kodak.com/go/register

Telephone customer support

If you have questions concerning the operation of the software or camera, you may speak with a customer support representative. Before you call, have the camera or dock connected to your computer. Be at your computer, and have the following information available:

- Computer model, Operating system
- Processor type and speed (MHz)
- Amount of memory (MB) & free hard disk space
- Camera serial number
- Version of Kodak EasyShare software
- Exact error message you received

Australia	1800 147 701	Greece	00800 441 40775	Singapore	800 6363 036
Austria	0179 567 357	Hong Kong	800 901 514	Spain	91 749 76 53
Belgium	02 713 14 45	India	91 22 617 5823	Sweden	08 587 704 21
Brazil	0800 150000	Italy	02 696 33452	Switzerland	01 838 53 51
Canada	1 800 465 6325	Japan	03 5540 9002	Taiwan	0800 096 868
China	800 820 6027	Korea	00798 631 0024	Thailand	001 800 631 0017
Denmark	3 848 71 30	Netherlands	020 346 9372	Turkey	00800 448827073
Indonesia	001 803 631 0010	New Zealand	0800 440 786	UK	0870 243 0270
Ireland	01 407 3054	Norway	23 16 21 33	US	1 800 235 6325
Finland	0800 1 17056	Philippines / Metro Manila	1 800 1 888 9600 / 632 6369600	Outside US	585 726 7260
France	01 55 1740 77	Poland	00800 4411625	International Toll Line	+44 131 458 6714
Germany	069 5007 0035	Portugal	021 415 4125	International Toll Fax	+44 131 458 6962

For the most up-to-date listings, visit: <http://www.kodak.com/go/dfswwwcontacts>

Camera specifications

For more specifications, visit www.kodak.com/go/c330support.

Kodak EasyShare C330 zoom digital camera	
CCD (charge-coupled device)	
CCD	1/2.5 in. CCD, 4:3 aspect ratio
Output image size	4.0 MP (Best): 2304 x 1728 pixels 3.5 MP (Best 3:2): 2304 x 1536 pixels 3.1 MP (Better): 2048 x 1536 pixels 2.1 MP (Good): 1664 x 1248 pixels 1.1 MP (E-mail): 1216 x 912 pixels
Displays	
Viewfinder	Optical real image Field-of-view: 86% @wide/tele Magnification: 0.34 (wide)–0.93 X (tele) Diopter: -1.0 +/- 1.0 [m^{-1}]
Color display	1.5 in. (4 cm) color hybrid LCD, 280 x 220 (61 K) pixels
Preview	Frame rate: 30 fps; Field-of-view: 100%.
Lens	
Taking lens	3X optical zoom, aspheric all-glass Kodak Retinar lens, f/2.7–4.6 (35 mm equivalent: 34–102 mm)

Kodak EasyShare C330 zoom digital camera	
Focus system*	TTL-AF; auto, Multi-zone AF, Center-zone AF; Normal mode, Landscape mode, and Macro mode (selectable) Working range: (0.6 m)–(Infinity) @ normal (10 m)–(Infinity) @ Landscape (0.13 m)–(0.7 m) @ macro, wide (0.22 m)–(0.7 m) @ macro, tele
Digital zoom	1.2X–5X Not supported for movie capture
Lens barrier	Integrated in lens barrel
Exposure	
Exposure metering	TTL-AE, Center-weighted
Exposure compensation*	+/-2.0 EV with 0.5 EV step
Shutter speed	Mechanical with CCD electrical Auto: 4 - 1/1400 sec.
Long time exposure*	0.7, 1.0, 1.5, 2.0, 3.0, 4.0 sec.
ISO speed*	Auto: 80 to 160 Selectable: 80, 100, 200, 400
Flash	
Electronic flash	Working range: @ ISO 140: 2–12 ft (0.6–3.6 m) @ Wide; @ ISO 140: 2–7 ft (0.6–2.1 m) @ Tele
Flash modes	Auto, Fill, Red-eye, Off

Kodak EasyShare C330 zoom digital camera	
Capture	
Capture modes	Auto, SCN (Children, Party, Night Portrait, Beach, Snow, Fireworks, Self-Portrait, and Backlight), Portrait, Sport, Landscape, Close-up, Video
Burst mode	Maximum 3 pictures, 1.8 fps
Video capture	QVGA (320 x 240 pixels) @ 20 fps
Image file format	Still: EXIF 2.2 (JPEG compression); file organization DCF Video: QuickTime (CODEC Motion JPEG)
Image storage	Optional MMC or SD Card  . (The SD logo is a trademark of the SD Card Association.)
Internal storage capacity	16 MB internal memory/13 MB available for image storage (1 MB equals one million bytes).
Review	
Quickview	Yes
Video output	NTSC or PAL
Power	
2 Kodak oxy-alkaline digital camera batteries AA; 2-AA lithium batteries; 2 Kodak Ni-MH rechargeable digital camera batteries AA; 1 Kodak Lithium digital camera battery CRV3; 1 Kodak Ni-MH rechargeable digital camera battery KAA2HR; 3V AC adapter	
Communication with computer	
USB 2.0 (PIMA 15740 protocol), via USB cable, EasyShare camera dock or printer dock	
Languages	
Chinese/Czech/Danish/English/Finnish/French/German/Greek/Hebrew/Italian/Japanese/Korean/Polish/Portuguese/Russian/Serbian/Spanish/Swedish/Turkish	

Kodak EasyShare C330 zoom digital camera	
Other features	
PictBridge printer support	Yes
Self-timer	10 seconds, 2 seconds selectable
White balance*	Auto, Daylight, Tungsten, Fluorescent
Auto power off	Selectable 1, 3, 5, or 10 minutes.
Color modes	Color, Black & White, Sepia
Date stamp	None, YYYY/MM/DD, MM/DD/YYYY, DD/MM/YYYY
Tripod mount	1/4 inch
Size	3.6 in. (91.5 mm) x 2.6 in. (65 mm) x 1.4 in. (35 mm) @ power off
Weight	5.6 oz (160 g) without battery or card

* Available only in Auto, Landscape, and Close-up modes.

Storage capacities

File sizes can vary. You may be able to store more or fewer pictures and videos. Favorites take up additional space in internal memory.

Picture storage capacity

	Number of pictures				
	4.0 MP	3.5 MP	3.1 MP	2.1 MP	1.1 MP
16 MB internal memory	16	18	20	29	48
16 MB SD or MMC	19	21	24	34	56
32 MB SD or MMC	38	43	47	68	112
64 MB SD or MMC	77	85	95	136	223
128 MB SD or MMC	153	171	190	272	447
256 MB SD or MMC	307	341	379	543	893

Video storage capacity

	Minutes/seconds of video
	QVGA (320 x 240)
16 MB internal memory	35 sec.
16 MB SD or MMC	40 sec.
32 MB SD or MMC	1 min. 21 sec.
64 MB SD or MMC	2 min. 42 sec.
128 MB SD or MMC	5 min. 25 sec.
256 MB SD or MMC	10 min. 50 sec.

Power-saving features

If no action for	The camera	To turn it back on
1 minute	Screen turns off.	Press any button.
3 minutes or select 1, 5, or 10 minutes	Enters auto power off.	Turn the Mode dial off and on again.

Important safety instructions

Using this product

- Read and follow these instructions before using Kodak products. Always follow basic safety procedures.
- The use of an accessory attachment that is not recommended by Kodak, such as an AC adapter, may cause fire, electric shock, or injury.
- If using this product in an airplane, observe all instructions of the airline.



CAUTION:

Do not disassemble this product; there are no user-serviceable parts inside. Refer servicing to qualified service personnel. Do not expose this product to liquid, moisture, or extreme temperatures. Kodak AC adapters and battery chargers are intended for indoor use only. The use of controls, adjustments, or procedures other than those specified herein may result in exposure to shock and/or electrical or mechanical hazards.

Battery safety and handling



CAUTION:

When removing batteries, allow them to cool first; batteries may be hot.

- Read and follow all warnings and instructions supplied by the battery manufacturer.
- Use only batteries that are approved for this product.
- Keep batteries out of the reach of children.
- Do not allow batteries to touch metal objects, including coins. Otherwise, a battery may short circuit, discharge energy, become hot, or leak.
- Do not disassemble, install backward, or expose batteries to liquid, moisture, fire, or extreme temperature.
- Replace all batteries of a set at the same time. Do not mix new batteries with used ones. Do not mix rechargeable and non-rechargeable batteries. Do not mix lithium, Ni-MH, and Ni-Cd batteries together. Do not mix batteries of different chemistry types, grades, or brands. Failure to observe this precaution may cause leakage.
- Remove batteries when the product is stored for an extended period of time. In the unlikely event that battery fluid leaks inside the product, contact your local Kodak Customer Service representative.
- In the unlikely event that battery fluid leaks onto your skin, wash immediately with water and contact your local health provider. For additional health-related information, contact your local Kodak Customer Service representative.
- Dispose of batteries according to local and national regulations.
- Do not charge non-rechargeable batteries.

For more information on batteries, see

www.kodak.com/global/en/service/batteries/batteryUsage.jhtml

Battery information

Battery life for Kodak C-series digital cameras

Use the following batteries. Actual battery life may vary based on usage.

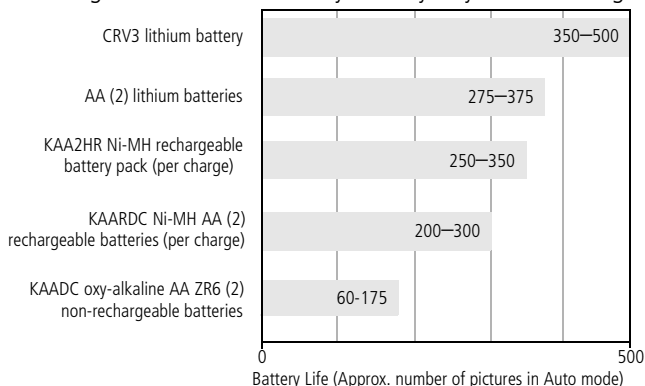

Battery life test method: CIPA (Camera & Imaging Products Association)
Memory card used in test: Kodak SD 128 MB memory card

We do not recommend or support alkaline batteries. For acceptable battery life, and to make sure your camera operates dependably, use the replacement batteries listed above.

Extending battery life

- Limit the following activities that quickly deplete battery power:
 - Reviewing your pictures on the camera screen (see [page 9](#))
 - Using the camera LCD screen as a viewfinder (see [page 8](#))
 - Excessive use of the flash (see [page 26](#))

- Dirt on the battery contacts can affect battery life. Wipe the contacts with a clean, dry cloth before loading batteries in the camera.
- Battery performance is reduced at temperatures below 41°F (5°C). When using your camera in cold weather, carry spare batteries and keep them warm. Do not discard cold batteries that do not work; when they return to room temperature, they may be usable.
- Visit www.kodak.com/go/c330accessories for:

Kodak EasyShare camera dock—powers your camera, transfers pictures to your computer, and charges the available Kodak Ni-MH rechargeable digital camera battery KAA2HR.

Kodak EasyShare printer dock—powers your camera, makes 4 x 6 in. (10 x 15 cm) prints with or without a computer, transfers pictures, and charges the available Kodak Ni-MH rechargeable digital camera battery KAA2HR.

Kodak 3-volt AC adapter—powers your camera.

IMPORTANT: *Do not use the AC adapter included with the Kodak EasyShare camera dock or printer dock to power your camera.*

Upgrading your software and firmware

Download the latest versions of the software included on the Kodak EasyShare software CD and the camera firmware (the software that runs on the camera). See www.kodak.com/go/c330downloads.

Additional care and maintenance

- If the camera has been subjected to inclement weather or you suspect water has gotten inside the camera, turn off the camera and remove the batteries and card. Allow all components to air-dry for at least 24 hours before using the camera again.
- Blow gently on the lens or camera screen to remove dust and dirt. Wipe gently with a soft, lint-free cloth or an untreated lens-cleaning tissue. Do not use cleaning solutions unless designed specifically for camera lenses. Do not allow chemicals, such as suntan lotion, to contact painted surfaces.
- Service agreements are available in some countries. Contact a dealer of Kodak products for more information.
- For digital camera disposal or recycling information, contact your local authorities. In the US, visit the Electronics Industry Alliance Web site at www.eiae.org or the Kodak Web site at www.kodak.com/go/c330support.

Warranty

Limited warranty

Kodak warrants Kodak EasyShare digital cameras and accessories (excluding batteries) to be free from malfunctions and defects in both materials and workmanship for one year from the date of purchase.

Retain the original dated sales receipt. Proof of the date of purchase will be required with any request for warranty repair.

Limited warranty coverage

This limited warranty will be honored only in the geographical location that Kodak digital cameras and accessories were purchased.

Kodak will REPAIR or REPLACE Kodak EasyShare digital cameras and accessories if they fail to function properly during the warranty period, subject to any conditions and/or limitations stated herein. Such repair service will include all labor as well as any necessary adjustments and/or replacement parts. Such repair or replacement is the sole remedy under this warranty.

If replacement parts are used in making repairs, these parts may be remanufactured, or may contain remanufactured materials. If it is necessary to replace the entire product, it may be replaced with a remanufactured product.

Limitations

Request for Warranty service will not be accepted without proof of date of purchase, such as a copy of the original dated Kodak EasyShare digital camera or accessory sales receipt. (Always keep the original for your records.)

This warranty does not apply to the battery(s) used in digital cameras or accessories. This warranty does not cover circumstances beyond Kodak's control, nor problems caused by failure to follow the operating instructions in the Kodak EasyShare digital cameras and accessories User's Guides.

This warranty does not apply when failure is due to shipping damage, accident, alteration, modification, unauthorized service, misuse, abuse, use with incompatible accessories or attachments, failure to follow Kodak's operation, maintenance or repacking instructions, failure to use items supplied by Kodak (such as adapters and cables), or claims made after the duration of this warranty.

Kodak makes no other express or implied warranty for this product. In the event that the exclusion of any implied warranty is ineffective under the law, the duration of the implied warranty will be one year from the purchase date.

The option of replacement is Kodak's only obligation. Kodak will not be responsible for any special, consequential or incidental damages resulting from the sale, purchase, or use of this product, regardless of the cause. Liability for any special, consequential or incidental damages (including but not limited to loss of revenue or profit, downtime costs, loss of the use of the equipment, cost of substitute equipment, facilities or services, or claims of your customers for such damages resulting from the purchase, use or failure of the product), regardless of cause or for breach of any written or implied warranty is expressly disclaimed and excluded here from.

Your rights

Some states or jurisdictions do not allow exclusion or limitation of incidental or consequential damages, so the above limitation or exclusion may not apply to you. Some states or jurisdictions do not allow limitations on how long an implied warranty lasts, so the above limitation may not apply to you.

This warranty gives you specific rights, and you may have other rights which vary from state to state or by jurisdiction.

Outside the United States and Canada

In countries other than the United States and Canada, the terms and conditions of this warranty may be different. Unless specific Kodak warranty is communicated to the purchaser in writing by a Kodak company, no warranty or liability exists beyond any minimum requirements imposed by law, even though defect, damage, or loss may be by negligence or other act.

Regulatory compliance

FCC compliance and advisory

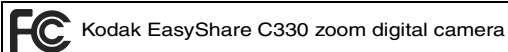

This equipment has been tested and found to comply with the limits for a Class B digital device, pursuant to Part 15 of the FCC Rules. These limits are designed to provide reasonable protection against harmful interference in a residential installation.

This equipment generates, uses, and can radiate radio frequency energy and, if not installed or used in accordance with the instructions, may cause harmful interference to radio communications. However, there is no guarantee that interference will not occur in a particular installation.

If this equipment does cause harmful interference to radio or television reception, which can be determined by turning the equipment off and on, the user is encouraged to try to correct the interference by one or more of the following measures: 1) reorient or relocate the receiving antenna; 2) increase the separation between the equipment and the receiver; 3) connect the equipment to an outlet on a circuit different from that to which the receiver is connected; 4) consult the dealer or an experienced radio/TV technician for additional suggestions.

Any changes or modifications not expressly approved by the party responsible for compliance could void the user's authority to operate the equipment. Where shielded interface cables have been provided with the product or specified additional components or accessories elsewhere defined to be used with the installation of the product, they must be used in order to ensure compliance with FCC regulation.

Canadian DOC statement

DOC Class B Compliance—This Class B digital apparatus complies with Canadian ICES-003.

Observation des normes-Class B—Cet appareil numérique de la classe B est conforme à la norme NMB-003 du Canada.

Waste Electrical and Electronic Equipment labeling



In the European Union, do not discard this product as unsorted municipal waste. Contact your local authorities or go to www.kodak.com/go/recycle for recycling program information.

VCCI Class B ITE

この装置は、情報処理装置等電波障害自主規制協議会（VCCI）の基準に基づくクラスB情報技術装置です。この装置は、家庭環境で使用することを目的としていますが、この装置がラジオやテレビジョン受信機に近接して使用されると、受信障害を引き起こすことがあります。
取扱説明書に従って正しい取り扱いをして下さい。

English translation:

This is a Class B product based on the standard of the Voluntary Control Council for Interference from Information Technology Equipment (VCCI). If this is used near a radio or television receiver in a domestic environment, it may cause radio interference. Install and use the equipment according to the instruction manual.

Index

A

- A/V out, 24
- AA battery, installing, 1
- about picture, video, 33
- about this camera, 33
- AC adapter, 58
- accessories, 16
 - AC adapter, 58
 - battery, 57
 - buying, 47
 - camera dock, 58
 - printer dock, 17, 58
 - SD/MMC card, 3
- album, 31
- albums, tagging pictures for, 35, 36
- alkaline batteries, warning, 1
- auto
 - flash, 9
 - focus framing marks, 6
 - power-down, 55

B

- backlight, 28
- batteries
 - expected life, 57
 - extending life, 57
 - loading, 1
 - types, 57
- battery
 - safety, 56
- beach, 28
- burst, using, 22

button

- burst, 22
- delete, 5
- flash/status, 9
- review, 9
- zoom, 8

C

- cable
 - audio/video, 24
 - USB, 16
- camera dock, 58
- camera dock connector, ii
- camera screen
 - reviewing pictures, 9
 - reviewing videos, 9
- Canadian compliance, 63
- caring for your camera, 59
- children, 28
- clock, setting, 2, 3
- color mode, 31
- computer
 - connecting camera, 14
 - transfer to, 14
- connector for camera dock, ii
- copy pictures
 - card to memory, 25
 - memory to card, 25
 - to computer via USB cable, 14
- CRV3 battery
 - loading, 2
- customer support, 48

customizing camera settings, 32

D

date & time, 32

date setting, 2, 3

date stamp, 32

DC-in, i

deleting

during quickview, 5

from internal memory, 13

from SD/MMC card, 13

protecting pictures, videos, 12

digital zoom, using, 8

displaying slide show, 23

disposal, recycling, 59

dock

camera, 58

printer, 17, 58

downloading pictures, 14

E

EasyShare software, 14

emailing pictures, videos, 38

expected life, 57

exposure compensation, 29

external video device

viewing pictures, videos, 24

F

favorites

removing, 41

settings, 40

tagging, 39

FCC compliance, 62

fireworks, 28

firmware, upgrading, 58

flash

settings, 9

focus framing marks, 6

focus zone, 30

format, 33

G

guidelines, battery, 57

H

help

web links, 47

I

icons, mode dial, 27

image storage, 31

information

about pictures, videos, 33

installing

batteries, 1

SD/MMC card, 3

software, 15

internal memory

storage capacity, 54

K

Kodak digital camera batteries, 1

Kodak EasyShare software

installing, 15

upgrading, 58

Kodak web sites, 47

L

language, 33

lens, i

cleaning lens, 59

liveview, 32

loading

batteries, 1

SD/MMC card, 3

software, 15

M

Macintosh, installing software on, 15

maintenance, camera, 59

memory

inserting card, 3

storage capacities, 54

mode dial, 27

modes

backlight, 28

beach, 28

children, 28

fireworks, 28

night portrait, 28

party, 28

SCN, 27

self-portrait, 28

snow, 28

N

night portrait, 28

O

online prints, ordering, 19

optical zoom, 8

P

party, 28

PictBridge printer, 17

picture quality, 29

pictures

checking settings, 10

copying, 25

deleting, 13

emailing tagged, 38

printing, 19

printing tagged, 37

protecting, 12

reviewing, 9

storage capacity, 54

tagging, 35, 36

taking, modes, 27

transfer via USB cable, 14

power

auto off, 55

camera, 2

printer dock, 17, 58

printing

from a card, 19

from computer, 19

optimizing printer, 47

order online, 19

PictBridge, 17

tagged pictures, 19

with EasyShare printer dock, 17

protecting pictures, videos, 12

Q

quickview

using, 5

R

- recycling, disposal, 59
- red-eye, flash, 9
- regulatory information, 62
- removing favorites, 41
- review button, 9
- reviewing pictures
 - as you take them, 5
 - camera screen, 9
 - deleting, 13
 - protecting, 12
 - slide show, 23
- reviewing videos
 - camera screen, 9
 - deleting, 13
 - protecting, 12
 - slide show, 23
- running slide show, 23

S

- safety
 - battery, 56
- SCN, 27
- SD/MMC card
 - inserting, 3
 - printing from, 19
 - storage capacities, 54
- self timer
 - with pictures, 21
 - with videos, 21
- self-portrait, 28
- service and support
 - telephone numbers, 48
- set album, 31

setting

- album, 31
 - color mode, 31
 - date & time, 32
 - date and time, 2, 3
 - date stamp, 32
 - flash, 9
 - focus zone, 30
 - image storage, 31
 - language, 33
 - liveview, 32
 - picture quality, 29
 - picture taking mode, 27
 - self timer, 21
 - video date display, 33
 - video out, 32
 - video quality, 30
 - white balance, 30
- Setup Menu, 31
- setup mode, using, 32
 - shutoff, auto, 55
 - shutter
 - self timer delay, 21
 - shutter, problems, 43
 - sleep mode, 55
 - slide show
 - continuous loop, 24
 - problems, 44
 - running, 23
 - snow, 28
 - software
 - installing, 15
 - upgrading, 58
 - speaker, i

specifications, camera, 50
storage capacity, 54
support, technical, 48

T

tagging

- favorites, 39
- for email, 38
- for print, 38

tagging pictures

- for albums, 35, 36

telephone support, 48

television, slide show, 24

time, setting, 2, 3

timer, shutter delay, 21

tips

- battery guidelines, 57
- care & maintenance, 59

transfer, via USB cable, 14

trash can, deleting, 5

turning camera on and off, 2

U

upgrading software, firmware, 58

URLs, Kodak web sites, 47

USB (universal serial bus)

- transferring pictures, 14

V

VCCI compliance, 63

video date display, 33

video length, 31

video out, 32

video quality, 30

videos

checking settings, 10

copying, 25

deleting, 13

emailing tagged, 38

protecting, 12

reviewing, 9

storage capacities, 54

transfer to computer, 14

viewing, 9

viewing picture

- after taking, 5, 9

viewing picture, video information, 33

W

warranty, 59

white balance, 30

Windows OS-based computers

- installing software, 15

Z

zoom

- digital, 8

- optical, 8