

# 1 Installing the software

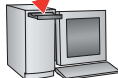

Before connecting any cables, install the software that was included with your camera. Follow the on-screen instructions.

After installing the software, return to this user guide.



# 2 Loading the batteries

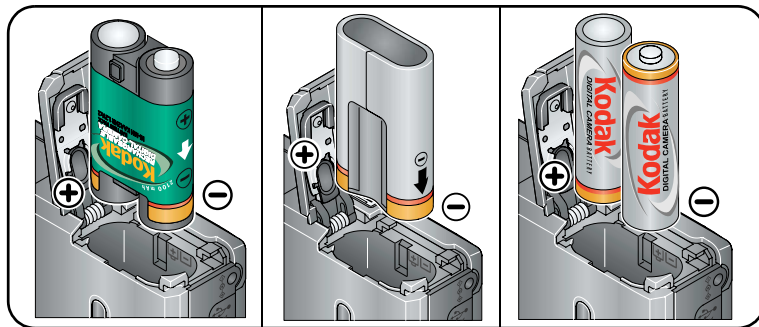

Ni-MH  
(rechargeable)

CRV3 lithium  
(non-rechargeable)

2 AA (rechargeable or  
non-rechargeable)

### 3 Turning on the camera

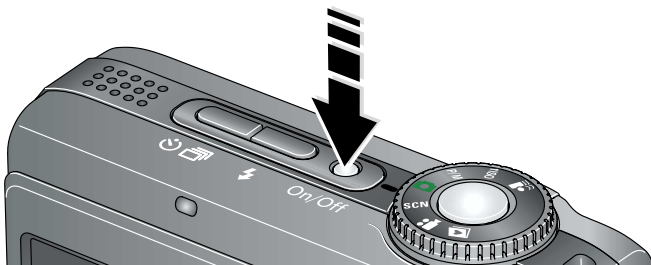

### 4 Setting the language, date/time

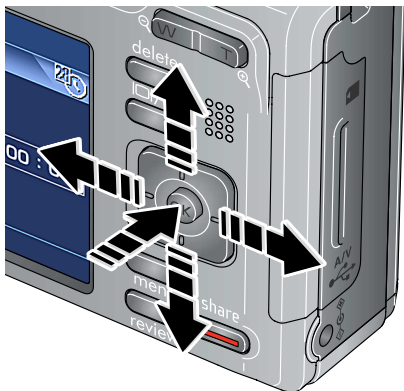

#### Language:

▲/▼ to change.

OK to accept.

#### Date/Time:

▲/▼ to change.

◀/▶ for previous/next field.

OK to accept.

## 5 Taking a picture/video

### Pictures

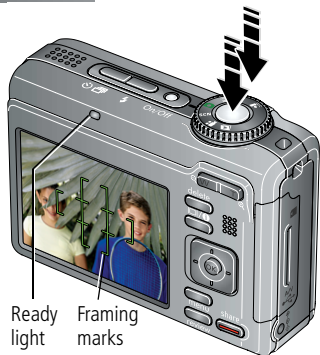
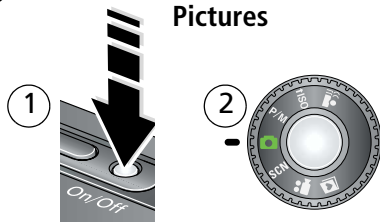

- 3 Press the Shutter button halfway to focus and set exposure.  
When the Ready light turns green, press the Shutter button completely down.

### Videos

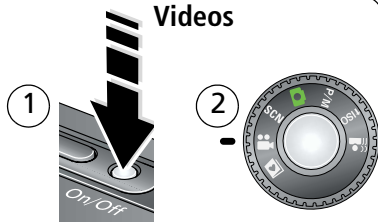

- 3 Press the Shutter button completely down and release.  
To stop recording, press and release the Shutter button again.

## 6 Reviewing pictures/videos

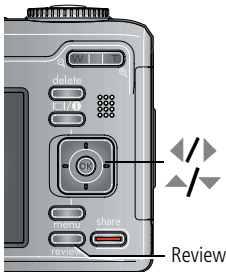

- ① Press Review. (Press again to exit.)
- ② ◀/▶ for previous/next picture/video.

**Videos:**

- ▼ Play
- OK Pause/unpause
- ▲/▼ Adjust the volume
- ▶ 2X, 4X forward
- ◀ 2X, 4X reverse

## 7 Playing HD on your television

For a true HDTV experience on your television, dock your camera on the optional Kodak EasyShare HDTV dock. Visit [www.kodak.com/go/hdtvdock](http://www.kodak.com/go/hdtvdock)

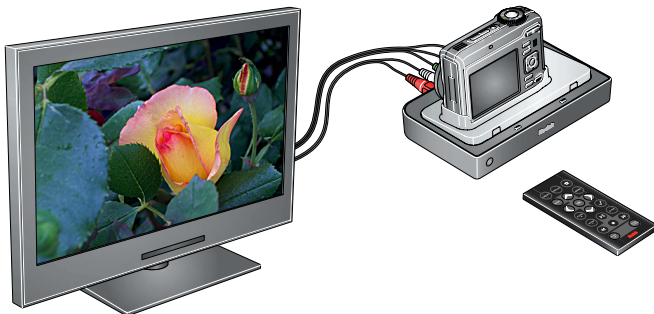

## 8 Transferring pictures/videos

### USB cable

- 1 Turn off camera.
- 2 Connect USB cable.
- 3 Turn on camera.

Kodak EasyShare software opens on your computer and prompts you through the transfer process.

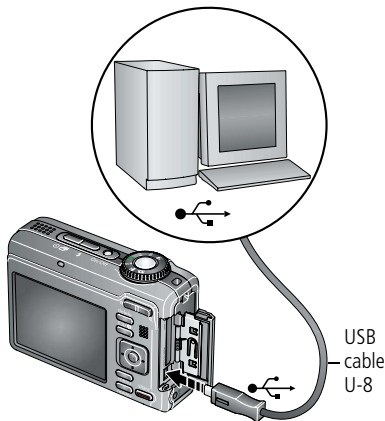

### Kodak EasyShare printer dock or camera dock (May be sold separately.)

For dock compatibility, visit [www.kodak.com/go/dockcompatibility](http://www.kodak.com/go/dockcompatibility).

To purchase accessories, visit [www.kodak.com/go/z1275accessories](http://www.kodak.com/go/z1275accessories) or z1285accessories.

To use an EasyShare dock, see its user documentation.

---

## 9 Keep learning about your camera!

---

### **Congratulations!**

You have:

- set up your camera
- taken pictures
- transferred pictures to your computer

### **Keep learning!**

Finish reading this book, so you can take and share your best pictures!

**Visit [www.kodak.com/go/z1275support](http://www.kodak.com/go/z1275support) or [Z1285support](http://www.kodak.com/go/Z1285support) and [www.kodak.com/go/easysharecenter](http://www.kodak.com/go/easysharecenter) for:**

- the extended user guide
- interactive troubleshooting and repairs
- interactive tutorials
- FAQs
- downloads
- accessories
- printing information
- product registration



---

# Front view

---

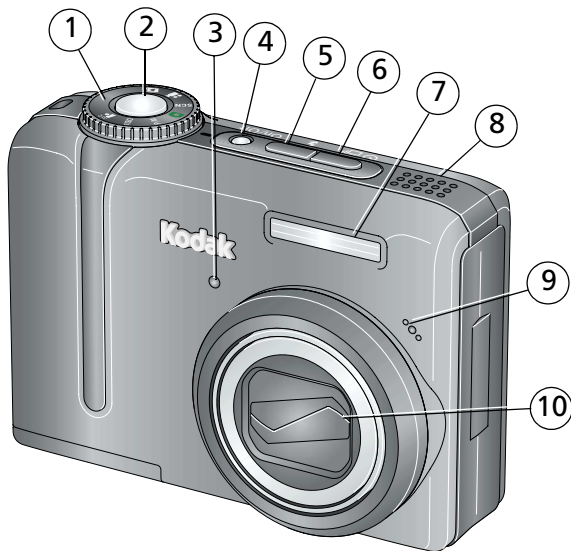

- |   |                        |    |                         |
|---|------------------------|----|-------------------------|
| 1 | Mode dial              | 6  | Self-timer/Burst button |
| 2 | Shutter button         | 7  | Flash                   |
| 3 | Self-timer/Video light | 8  | Speaker                 |
| 4 | On/Off button          | 9  | Microphone              |
| 5 | Flash button           | 10 | Lens                    |

# Back view

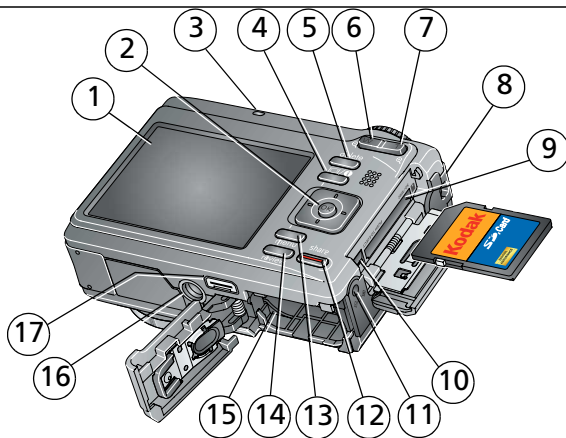

- |  |   |
|--|---|
| 1 LCD  | 10 USB, A/V Out                             |
| 2 OK/  | 11 DC-In, for <b>optional</b> 3V AC adapter |
| 3 Ready light                                  | 12 Share button                             |
| 4 LCD/Info button                              | 13 Menu button                              |
| 5 Delete button                                | 14 Review button                            |
| 6 Wide angle (W) button                        | 15 Battery compartment                      |
| 7 Telephoto (T) button                         | 16 Tripod socket                            |
| 8 Strap post                                   | 17 Dock connector                           |
| 9 Slot for <b>optional</b> SD/SDHC or MMC card |   |







## 1

# Taking better pictures/videos

## Capture modes



Choose the mode that best suits your subjects and surroundings.

Capture mode	For
 <b>Smart Scene</b>	General picture taking. When the Shutter button is pressed halfway, faces are detected, the scene is analyzed, and the best settings are applied.
<b>P/M</b> P, M	Program, Manual modes for more creative control. (See <a href="#">page 19</a> ).
 <b>ISO</b> High ISO	People in low-light scenes indoors using a higher ISO.
 <b>Digital Image Stabilization</b>	Minimizing the effects of camera shake and subject movement.
<b>SCN</b> Scene	Point-and-shoot simplicity when taking pictures under special conditions.
 <b>Video</b>	Capturing video with sound. (See <a href="#">page 3</a> .)
 <b>Favorites</b>	Viewing favorite pictures.

## Using optical zoom

Use optical zoom to get up to 5X closer to your subject while taking pictures/videos. Optical zoom is effective when the lens is no closer than 24 in. (60 cm) to the subject or 7.9 in. (20 cm) in Close-up mode.

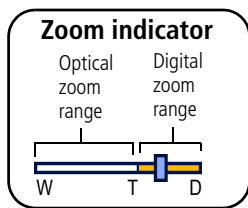

- 1 Press Telephoto (T) to zoom in. Press Wide Angle (W) to zoom out.

*The zoom indicator shows zoom status.*

- 2 Take the picture or video.

## Using digital zoom

Use digital zoom to get up to 5X beyond optical zoom while taking pictures. Press Telephoto (T) to the maximum optical zoom. Release the button, then press it again.

NOTE: You may notice decreased image quality when using digital zoom. The slider on the zoom indicator turns red when the picture quality reaches the limit for an acceptable 4 x 6-in. (10 x 15 cm) print.

## Using the flash

Use the flash when you take pictures at night, indoors, or outdoors in heavy shadows.

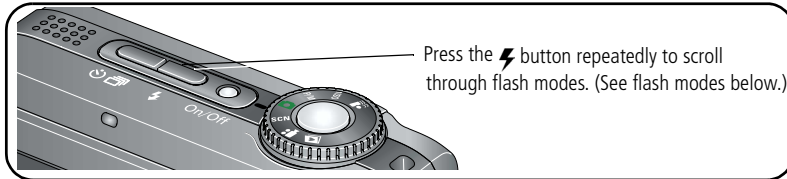

Flash modes	Flash fires		
<b>Auto</b>	When the lighting conditions require it.		
<b>Fill</b>	Every time you take a picture, regardless of the lighting conditions. Use when the subject is in shadow or is “backlit” (when the light is behind the subject). In low light, hold the camera steady or use a tripod.		
<b>Red-eye</b>	<table border="1"> <tr> <td>If Red-eye Pre-flash is turned off: The flash fires once and the camera automatically corrects red-eye in the picture.</td> <td>If Red-eye Pre-flash is turned on: The flash fires once so the eyes become accustomed to the flash, then fires again when the picture is taken.</td> </tr> </table>	If Red-eye Pre-flash is turned off: The flash fires once and the camera automatically corrects red-eye in the picture.	If Red-eye Pre-flash is turned on: The flash fires once so the eyes become accustomed to the flash, then fires again when the picture is taken.
If Red-eye Pre-flash is turned off: The flash fires once and the camera automatically corrects red-eye in the picture.	If Red-eye Pre-flash is turned on: The flash fires once so the eyes become accustomed to the flash, then fires again when the picture is taken.		
<b>Off</b>	Never.		

### Flash-to-subject distance

Wide angle: 2–19.3 ft (0.6–5.9 m) @ ISO 400

Telephoto: 2–10.5 ft (0.6–3.2 m) @ ISO 400

[www.kodak.com/gol/z1275support](http://www.kodak.com/gol/z1275support) or [z1285support](http://z1285support)

## Using the self-timer

Use the self-timer when you want to be included in a picture, or to ensure a steady Shutter button press.

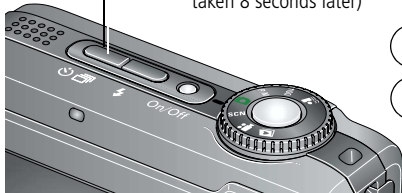

- 1 Place camera on a tripod or flat surface.
- 2 In most Still modes, press the Self-Timer/Burst button :
  - Once for a 10-second delay (so you have time to get into the scene)
  - Again for a 2-second delay (for a steady, auto-shutter release on a tripod)
  - Again for 2-shot (one picture taken after 10 seconds and another picture taken 8 seconds later)
- 3 Compose the scene.
- 4 Press the Shutter button halfway, then completely down.  
The picture is taken after the delay.

To cancel the Self-timer before the picture is taken, press the Self-timer/Burst button , or press the Shutter button completely down.

**Use the same procedure to use the self-timer in Video mode, but:**

- Turn the Mode dial to Video .
- Press the Shutter button completely down.

NOTE: The video stops when no storage space remains. Only the 2- and 10-second options are available in video mode.

## Understanding the picture-taking icons

Status icons indicate mode, feature, and camera status.

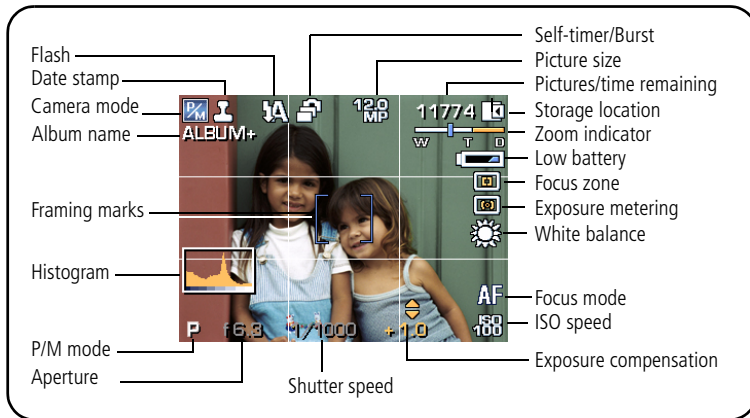

## Deleting pictures/videos







- 1 Press the Review button.
- 2 Press ◀/▶ to find a picture/video.
- 3 Press the Delete button.
- 4 Follow the screen prompts.

## Using the undo delete feature

If you accidentally delete a picture/video, use Undo Delete to retrieve it. This feature is available only immediately after you delete a picture/video in Review mode (when the Undo Delete option appears).

- 1 Press ▲/▼ to highlight Undo Delete.
- 2 Press OK.  
*The deleted picture/video appears.*
- 3 Select Exit to exit the Delete menu.

## Using the menu button in Review

- 1 Press the Review button, then the Menu button.
- 2 Press  to choose a tab:
  -  **Review** to view pictures/videos
  -  **Edit** to edit pictures/videos
  -  **Setup** for other camera settings
- 3 Press / to highlight a setting, then press the OK button.
- 4 Choose an option, then press the OK button.

 Options
View By
Album
Slide Show
Multi-up
Copy To
Protect/Unprotect
Select/Deselect All

 Options	
Pictures	Perfect Touch tech.
	Crop
	Sound Tags
Videos	Make Picture
	Trim
	Action Print
	Bookmark

## Adding sound tags

You can record a voice or sound (up to 1 minute long) to a picture.

NOTE: Only one sound tag can be added to each picture (not to videos).

### Recording a sound tag

- 1 Press the Review button, then ◀/▶ to find a picture.
- 2 Press the Menu button, then ◀/▶ to highlight the Edit tab.
- 3 Press ▲/▼ to highlight Sound Tag. Press the OK button.
- 4 Choose Record, then press OK.
- 5 Follow the screen prompts.

*The sound tag is applied to your picture.*

- Press the Menu button to exit the menu.

### Playing a sound tag

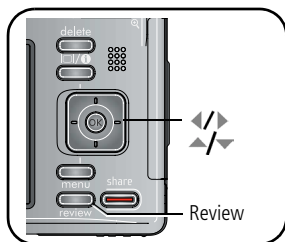

- 1 Press the Review button, then ◀/▶ to find a  tagged picture.
- 2 Press ▼ to play the sound tag.
- 3 Press ▲/▼ to adjust the volume.
- 4 Press OK to stop playback.



## Understanding the review icons

### Pictures

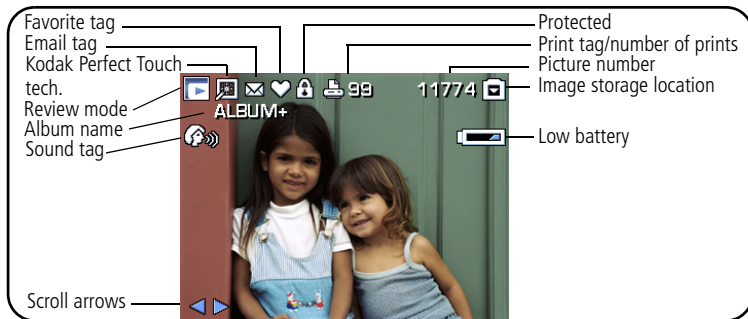

### Videos











# 3

## Doing more with your camera

### Using the Menu button to change settings

NOTE: Some settings remain until you change them; others remain until you turn off the camera.

- 1 Press the Menu button.
- 2 Press   to highlight a menu tab:
  -  **Capture** for the most common picture-taking settings.
  -  **Capture Plus** for other picture-taking settings.
  -  **Setup** for other camera settings.
- 3 Press   to highlight a setting, then press the OK button.
- 4 Choose an option, then press the OK button.

NOTE: Press the LCD/Info button   for information about camera settings and options. Some capture modes ([page 9](#)) offer limited settings.

## P and M modes

Use Program and Manual modes when you want more control over your camera and pictures.



Mode	For	Press     to control
<b>P</b> Program	Ease of auto shooting with full access to most menu options. The camera automatically sets the shutter speed and aperture (f-stop) based on the scene lighting.	Exposure compensation (how much light enters the camera), Focus mode, and ISO speed
<b>M</b> Manual	The highest level of creative control. (To prevent blur, use a tripod for slow shutter speeds.)	Aperture, shutter speed, focus mode, and ISO speed

NOTE: Settings you change in P or M mode apply only to pictures taken in that mode. For example, if you change the Color Mode to Sepia while in P or M mode, you retain the default setting of Color for Smart scene and Scene modes.

The settings, including Flash, are maintained for P and M modes—even when you change modes or turn off the camera.

## Changing P or M mode settings

P/M modes control ISO, Focus, exposure compensation, shutter speed, and aperture (f-number, also known as f-stop). Use the Menu button to control all other settings.

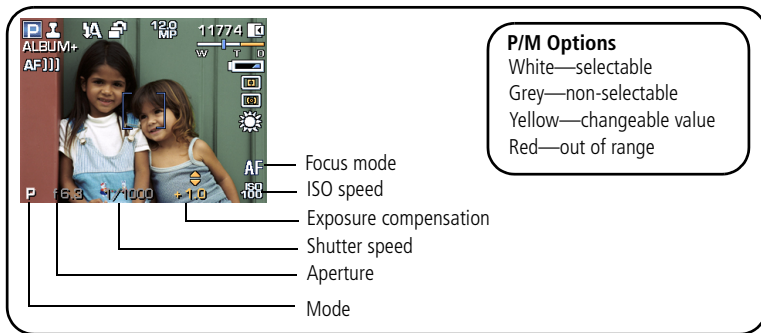

- 1 Turn the Mode dial to P/M.

*The mode options are displayed.*

- 2 Use  to move between settings and  to change the value.

NOTE: Some settings may be unavailable (see P/M color options above). The arrows disappear when you cannot make further value changes.

- 3 Take a picture.

**P/M mode**—see [page 19](#).

**ISO speed**—adjust the sensitivity to light. Higher ISO indicates greater sensitivity.

NOTE: A higher ISO may produce unwanted “noise” in a picture.







**Exposure Compensation**—adjust the exposure. If the picture is too light, decrease the setting; if it’s too dark, increase the setting.

**Shutter speed**—control how long the shutter stays open.

**Aperture**—(also known as f-stop) control the size of the lens opening, which determines the depth of field.

- Smaller f-stop numbers indicate a larger lens opening; good for portraits and low-light conditions.
- Larger f-stop numbers indicate a smaller lens opening; keeps the main subject sharp; good for landscapes and well-lit conditions.

**Focus mode**—select a large or concentrated area of focus.

Focus mode	Description
 <b>Normal AF</b>	Focus setting for general picture-taking.
 <b>Macro</b>	Sharpness and detail in pictures at close range. The camera automatically sets the focus distance depending on the zoom position.
 <b>Infinity</b>	Distant subjects. Auto-focus framing marks are unavailable.
 <b>Manual</b>	Focus is at center position. When MF icon appears, press OK to display focus indicator. Press  /  to adjust the setting.

## 4

# Solving camera problems

For step-by-step product support, visit [www.kodak.com/go/z1275support](http://www.kodak.com/go/z1275support) or [z1285support](http://z1285support) and select Interactive Troubleshooting & Repairs.

## Camera problems

If	Try one or more of the following
Camera does not turn on.	<ul style="list-style-type: none"> <li>■ Install new batteries (see page 1).</li> <li>■ Charge rechargeable batteries.</li> </ul>
Camera does not turn off.	<ul style="list-style-type: none"> <li>■ Remove the battery, then reinsert or replace it. If the camera still does not function, visit <a href="http://www.kodak.com/go/z1275support">www.kodak.com/go/z1275support</a> or <a href="http://z1285support">z1285support</a> and select Interactive Troubleshooting &amp; Repairs.</li> </ul>
Short battery life with Kodak Ni-MH rechargeable digital camera batteries.	<ul style="list-style-type: none"> <li>■ Wipe the contacts with a clean, dry cloth before loading batteries in the camera.</li> <li>■ Limit activities that deplete battery power: reviewing pictures/videos and excessive use of the flash.</li> <li>■ Use the Battery Refresh feature on your camera dock, printer dock, or battery charger (if equipped).</li> </ul>
Shutter button does not work.	<ul style="list-style-type: none"> <li>■ Turn on the camera (see page 2).</li> <li>■ Wait until the Ready light stops blinking red before attempting to take another picture.</li> <li>■ Transfer pictures to the computer (see page 5), delete pictures from the camera (page 14), switch image storage locations, or insert a card with available memory (page 8).</li> </ul>

# 5 Appendix

## CAUTION:

**Do not disassemble this product; there are no user-serviceable parts inside. Refer servicing to qualified service personnel. Kodak AC adapters and battery chargers are intended for indoor use only. The use of controls, adjustments, or procedures other than those specified herein may result in exposure to shock and/or electrical or mechanical hazards. If the LCD breaks, do not touch the glass or liquid. Contact Kodak customer support.**

- The use of an accessory that is not recommended by Kodak may cause fire, electric shock, or injury. For approved accessories, visit [www.kodak.com/go/accessories](http://www.kodak.com/go/accessories).
- Use only a USB-certified computer equipped with a current-limiting motherboard. Contact your computer manufacturer if you have questions.
- If using this product in an airplane, observe all instructions of the airline.
- When removing the battery, allow it to cool; it may be hot.
- Follow all warnings and instructions supplied by the battery manufacturer.
- Use only batteries approved for this product to avoid risk of explosion. Do not charge non-rechargeable batteries.
- Keep batteries out of the reach of children.
- Do not allow batteries to touch metal objects, including coins. Otherwise, a battery may short circuit, discharge energy, become hot, or leak.
- Do not disassemble, install backward, or expose batteries to liquid, moisture, fire, or extreme temperature.
- Remove the battery when the product is stored for an extended period of time. In the unlikely event that battery fluid leaks inside the product, contact Kodak customer support.
- In the unlikely event that battery fluid leaks onto your skin, wash immediately with water and contact your local health provider. For additional health-related information, contact your local Kodak customer support.
- Dispose of batteries according to local and national regulations. Visit [www.kodak.com/go/kes](http://www.kodak.com/go/kes).

For more information on batteries, see [www.kodak.com/go/batterytypes](http://www.kodak.com/go/batterytypes).

### Limited Warranty

Kodak warrants Kodak consumer electronic products and accessories (“Products”), excluding batteries, to be free from malfunctions and defects in both materials and workmanship for one year from the date of purchase. Retain original dated sales receipt. Proof of date of purchase is required with any request for warranty repair.

### Limited warranty coverage

Warranty service is only available from within the country where the Products were originally purchased. You may be required to ship Products, at your expense, to the authorized service facility for the country where the Products were purchased. Kodak will repair or replace Products if they fail to function properly during the warranty period, subject to any conditions and/or limitations stated herein. Warranty service will include all labor as well as any necessary adjustments and/or replacement parts. If Kodak is unable to repair or replace a Product, Kodak will, at its option, refund the purchase price paid for the Product provided the Product has been returned to Kodak along with proof of the purchase price paid. Repair, replacement, or refund of the purchase price are the sole remedies under the warranty. If replacement parts are used in making repairs, those parts may be remanufactured, or may contain remanufactured materials. If it is necessary to replace the entire Product, it may be replaced with a remanufactured Product. Remanufactured Products, parts and materials are warranted for the remaining warranty term of the original Product, or 90 days after the date of repair or replacement, whichever is longer.

### Limitations

This warranty does not cover circumstances beyond Kodak’s control. This warranty does not apply when failure is due to shipping damage, accident, alteration, modification, unauthorized service, misuse, abuse, use with incompatible accessories or attachments (such as third party ink or ink tanks), failure to follow Kodak’s operation, maintenance or repacking instructions, failure to use items supplied by Kodak (such as adapters and cables), or claims made after the duration of this warranty. **Kodak makes no other express or implied warranty for this product, and disclaims the implied warranties of merchantability and fitness for a particular purpose.** In the event that the exclusion of any implied warranty is ineffective under the law, the duration of the implied warranty will be one year from the purchase date or such longer period as required by law. The option of repair, replacement, or refund is Kodak’s only obligation. Kodak will not be responsible for any special, consequential or incidental damages resulting from the sale, purchase, or use of this product regardless of the cause. Liability for any special, consequential or incidental damages (including but not limited to loss of revenue or profit, downtime costs, loss of the use of the equipment, cost of substitute equipment, facilities or services, or claims of your customers for such damages resulting from the purchase, use, or failure of the Product), regardless of cause or for breach of any written or implied warranty is expressly disclaimed.



## Your rights

Some states or jurisdictions do not allow exclusion or limitation of incidental or consequential damages, so the above limitation or exclusion may not apply to you. Some states or jurisdictions do not allow limitations on how long an implied warranty lasts, so the above limitation may not apply to you. This warranty gives you specific rights, and you may have other rights which vary from state to state or by jurisdiction.

## Outside the United States and Canada

In countries other than the United States and Canada, the terms and conditions of this warranty may be different. Unless a specific Kodak warranty is communicated to the purchaser in writing by a Kodak company, no warranty or liability exists beyond any minimum requirements imposed by law, even though defect, damage, or loss may be by negligence or other act.

# Regulatory compliance

## FCC compliance and advisory

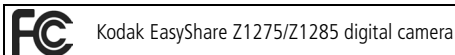

This equipment has been tested and found to comply with the limits for a Class B digital device, pursuant to Part 15 of the FCC Rules. These limits are designed to provide reasonable protection against harmful interference in a residential installation. This equipment generates, uses, and can radiate radio frequency energy and, if not installed or used in accordance with the instructions, may cause harmful interference to radio communications. However, there is no guarantee that interference will not occur in a particular installation. If this equipment does cause harmful interference to radio or television reception, which can be determined by turning the equipment off and on, the user is encouraged to try to correct the interference by one or more of the following measures: 1) reorient or relocate the receiving antenna; 2) increase the separation between the equipment and the receiver; 3) connect the equipment to an outlet on a circuit different from that to which the receiver is connected; 4) consult the dealer or an experienced radio/TV technician for additional suggestions. Any changes or modifications not expressly approved by the party responsible for compliance could void the user's authority to operate the equipment. Where shielded interface cables have been provided with the product or specified additional components or accessories elsewhere defined to be used with the installation of the product, they must be used in order to ensure compliance with FCC regulation.

## Australian C-Tick



## Waste Electrical and Electronic Equipment labeling



In the European Union, do not discard this product as unsorted municipal waste. Contact your local authorities or go to [www.kodak.com/go/recycle](http://www.kodak.com/go/recycle) for recycling program information.

## Canadian DOC statement

**DOC Class B Compliance**—This Class B digital apparatus complies with Canadian ICES-003.

**Observation des normes-Classe B**—Cet appareil numérique de la classe B est conforme à la norme NMB-003 du Canada.

### FCC and Industry Canada

This device complies with Industry Canada RSS-210 and FCC Rules. Operation is subject to the following two conditions: (1) this device may not cause harmful interference, and (2) this device must accept any interference received, including interference that may cause undesired operation.

#### FCC et Industrie Canada

Cet appareil est conforme à la norme RSS-210 d'Industrie Canada et aux réglementations de la FCC. Son utilisation est soumise aux deux conditions suivantes : (1) cet appareil ne doit pas provoquer d'interférences nuisibles, et (2) cet appareil doit supporter les interférences reçues, y compris celles susceptibles de nuire à son bon fonctionnement.

## Korean Class B ITE

이 기기는 가정용으로 전자파적합등록을 한 기기로서 주거지역에서는 물론 모든 지역에서 사용할 수 있습니다.

## VCCI Class B ITE

この装置は、情報処理装置等電波障害自主規制協議会（VCCI）の基準に基づくクラスB情報技術装置です。この装置は、家庭環境で使用することを目的としていますが、この装置がラジオやテレビジョン受信機に近接して使用されると、受信障害を引き起こすことがあります。取扱説明書に従って正しい取り扱いをして下さい。

## China RoHS

### 环保使用期限 (EPUP)

在中国大陆, 该值表示产品中存在的任何危险物质不得释放, 以免危及人身健康、财产或环境的时间期限(以年计)。该值根据操作说明中所规定的产品正常使用而定。

有毒有害物质或元素名称及含量标识表

部件名称	有毒有害物质或元素					
	铅	汞	镉	六价铬	多溴联苯	多溴二苯醚
数码相机电路板元件	×	○	○	○	○	○

○：表示该有毒有害物质在该部件所有均质材料中的含量均在SJ/T 11363-2006规定的限量要求以下。  
 ×：表示该有毒有害物质至少在该部件的某一均质材料中的含量超出SJ/T 11363-2006规定的限量要求。



USB 数据线

## MPEG-4

Use of this product in any manner that complies with the MPEG-4 visual standard is prohibited, except for use by a consumer engaging in personal and non-commercial activities.

## Russian GOST-R



Eastman Kodak Company  
Rochester, NY 14650

A10-40

Фотокамера изготовлена в Китае; остальные элементы -  
в соответствии с маркировкой.

## Kodak

Eastman Kodak Company  
Rochester, New York 14650

© Eastman Kodak Company, 2007

Kodak and EasyShare are trademarks of Eastman Kodak Company.

416186\_en