



LCD TV

MODELS: 32LC2D
32LC2DC
37LC2D
42LC2D

PLASMA TV

MODELS: 42PC3D 42PC1DVH
42PC3DC 42PC3DH
42PC3DV 42PC3DVA
50PC3D 50PC3DH
50PC3DX

OWNER'S MANUAL



Internet Home Page : <http://www.lge.com>
<http://www.lg.ca>
<http://www.lgcommercial.com>

ENERGYSTAR is a set of power-saving guidelines issued by the U.S. Environmental Protection Agency(EPA).







As an ENERGY STAR Partner LGE U. S. A.,Inc. has determined that this product meets the ENERGY STAR guidelines for energy efficiency.

Please read this manual carefully before operating your set. Retain it for future reference. Record model number and serial number of the set. See the label attached on the back cover and quote this information to your dealer when you require service.

P/NO : 38289U0527B (0607-REV07)
Printed in Korea

Warning

	<div style="border: 1px solid black; padding: 5px; display: inline-block;">CAUTION RISK OF ELECTRIC SHOCK DO NOT OPEN</div>	
<p>WARNING: TO REDUCE THE RISK OF ELECTRIC SHOCK DO NOT REMOVE COVER (OR BACK). NO USER SERVICEABLE PARTS INSIDE. REFER TO QUALIFIED SERVICE PERSONNEL.</p>		
	<p>The lightning flash with arrowhead symbol, within an equilateral triangle, is intended to alert the user to the presence of uninsulated "dangerous voltage" within the product's enclosure that may be of sufficient magnitude to constitute a risk of electric shock to persons.</p>	
	<p>The exclamation point within an equilateral triangle is intended to alert the user to the presence of important operating and maintenance (servicing) instructions in the literature accompanying the appliance.</p>	

NOTE TO CABLE/TV INSTALLER:

This reminder is provided to call the CATV system installer's attention to Article 820-40 of the National Electric Code (U.S.A.). The code provides guidelines for proper grounding and, in particular, specifies that the cable ground shall be connected to the grounding system of the building, as close to the point of the cable entry as practical.

REGULATORY INFORMATION

This equipment has been tested and found to comply with the limits for a Class B digital device, pursuant to Part 15 of the FCC Rules. These limits are designed to provide reasonable protection against harmful interference in a residential installation. This equipment generates, uses and can radiate radio frequency energy and, if not installed and used in accordance with the instructions, may cause harmful interference to radio communications. However, there is no guarantee that interference will not occur in a particular installation. If this equipment does cause harmful interference to radio or television reception, which can be determined by turning the equipment off and on, the user is encouraged to try to correct the interference by one or more of the following measures:

- Reorient or relocate the receiving antenna.
- Increase the separation between the equipment and receiver.
- Connect the equipment into an outlet on a circuit different from that to which the receiver is connected.
- Consult the dealer or an experienced radio/TV technician for help.

Any changes or modifications not expressly approved by the party responsible for compliance could void the user's authority to operate the equipment.

CAUTION:

Do not attempt to modify this product in any way without written authorization from LG Electronics Corporation. Unauthorized modification could void the user's authority to operate this product.

U.S.A. only -----

COMPLIANCE:

The responsible party for this product's compliance is:
LG Electronics U.S.A., Inc.
1000 Sylvan Avenue, Englewood Cliffs, NJ 07632
Phone: 1-800-243-0000
<http://www.lgusa.com>

Safety Instructions

WARNING :

To reduce the risk of fire or electric shock, do not expose this apparatus to rain or moisture.

Apparatus shall not be exposed to dripping or splashing and no objects filled with liquids, such as vases, shall be placed on the apparatus.

IMPORTANT SAFETY INSTRUCTIONS

1. Read these instructions.

2. Keep these instructions.

3. Heed all warnings.

4. Follow all instructions.



5. Do not use this apparatus near water.



6. Clean only with a dry cloth.

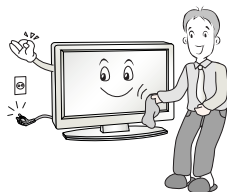

7. Do not block any of the ventilation openings. Install in accordance with the manufacturer's instructions.



8. Do not install near any heat sources such as radiators, heat registers, stoves, or other apparatus (including amplifiers) that produce heat.



9. Do not defeat the safety purpose of the polarized or grounding type plug. A polarized plug has two blades with one wider than the other. A grounding type plug has two blades and a third grounding prong. The wide blade or the third prong is provided for your safety. When the provided plug does not fit into your outlet, consult an electrician for replacement of the obsolete outlet.

10. Protect the power cord from being walked on or pinched particularly at plugs, convenience receptacles, and the point where they exit from the apparatus.



11. Only use the attachments / accessories specified by the manufacturer.

12. Use only with a cart, stand, tripod, bracket, or table specified by the manufacturer, or sold with the apparatus. When a cart is used, use caution when moving the cart / apparatus combination to avoid injury from tip-over.



14. Refer all servicing to qualified service personnel. Servicing is required when the apparatus has been damaged in any way, such as power supply cord or plug is damaged, liquid has been spilled or objects have fallen into the apparatus, the apparatus has been exposed to rain or moisture, does not operate normally, or has been dropped.

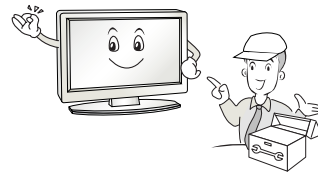

13. Unplug this apparatus during lightning storms or when unused for long periods of time.



15. DISCONNECTING DEVICE FROM MAINS

- Mains plug is the disconnecting device. The plug must remain readily operable.

CAUTION concerning the Power Cord

Most appliances recommend they be placed upon a dedicated circuit; that is, a single outlet circuit which powers only that appliance and has no additional outlets or branch circuits. Check the specification page of this owner's manual to be certain.

Do not overload wall outlets. Overloaded wall outlets, loose or damaged wall outlets, extension cords, frayed power cords, or damaged or cracked wire insulation are dangerous. Any of these conditions could result in electric shock or fire. Periodically examine the cord of your appliance, and if its appearance indicates damage or deterioration, unplug it, discontinue use of the appliance, and have the cord replaced with an exact replacement part by an authorized servicer.

Protect the power cord from physical or mechanical abuse, such as being twisted, kinked, pinched, closed in a door, or walked upon. Pay particular attention to plugs, wall outlets, and the point where the cord exits the appliance.

For LCD TV

Note

- If the TV feels cold to the touch, there may be a small "flicker" when when it is turned on. This is normal, there is nothing wrong with TV.
- Some minute dot defects may be visible on the screen, appearing as tiny red, green, or blue spots. However, they have no adverse effect on the monitor's performance.
- Avoid touching the LCD screen or holding your finger(s) against it for long periods of time. Doing so may produce some temporary distortion effects on the screen.

On Disposal

- a. The fluorescent lamp used in this product contains a small amount of mercury.
- b. Do not dispose of this product with general household waste.
Disposal of this product must be carried out in accordance to the regulations of your local authority.

Contents

Introduction		2	Warnings
		3~4	Safety Instructions
		7	Accessories
		8	Controls (Model Name: 32/37/42LC2D**)
		8	Swivel Stand (42LC2D** only)
		9	Connection Options (Model Name: 32/37/42LC2D**)
		10	Controls (Model Name: 42PC1D**/42PC3D**/50PC3D**)
		11	Connection Options (Model Name: 42PC1D**/42PC3D**/50PC3D**)
		12~16	Remote Control Key Functions
		<hr/>	
		Installation	External Equipment Connections
18~20	Basic Connection		
<hr/>			
21	Antenna or Cable Connection		
22~23	VCR Setup		
23	External AV Source Setup		
24~25	DVD Setup		
26~27	HDSTB Setup		
28	Monitor Out Setup		
28	Digital Audio Output		
29~31	PC Setup		
<hr/>			
Operation	Basic operation	32	Turning on the TV
		32	Volume Adjustment
		32	Channel Selection
		32	On Screen Menus Language Selection
		33	On Screen Menus Selection and Adjustment
	<hr/>		
	Setup Menu Options	34	EZ Scan (Channel Search)
		34	Manual Scan
		35	Channel Edit
		36	DTV Signal Strength
		36	Input Source
	Video Menu Options	37	Input Label
		<hr/>	
		38	EZ Picture
		38	APM (Adaptive Picture Mode)
		39	Manual Picture Control (EZ Picture-Custom option)
	Audio Menu Options	39	Color Temperature Control
		39	Video Reset
		<hr/>	
40		Audio Language	
40		EZ SoundRite	
41	EZ Sound		
41	Manual Sound Control (EZ Sound-Custom option)		
42	Stereo/SAP Broadcasts Setup		
42	Front Surround		
43	TV Speakers On/Off Setup		
43	BBE		

Operation	Time Menu Options	44 Auto Clock Setup
		44 Manual Clock Setup
		45 On/Off Timer Setup
		45 Sleep Timer
	Option Menu Features	46 Auto Off
		47 Aspect Ratio Control
		48 Cinema 3:2 Mode Setup
		48 Caption
		49 Caption/Text
		50 Caption Option
		50 Low Power (42PC1D**/42PC3D**/50PC3D** only)
		51 ISM (Image Sticking Minimization) Method (42PC1D**/42PC3D**/50PC3D** only)
	Lock Menu Options	52~53 Parental Lock Setup
Reference		54~59 External Control Device Setup
		60~61 IR Codes
		62 Programming the Remote
		63~64 Programming Codes
		65~66 Troubleshooting Checklist
		66 Maintenance
		67~68 Product Specifications

Introduction

Accessories

Ensure that the following accessories are included with your TV. If any accessory is missing, please contact the dealer where you purchased the product.

User must use the shield signal interface cable (D-sub 15 pin cable) with ferrite cores to maintain the standard compliance for the product.



Power Cord



75Ω Round Cable

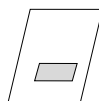

Owner's Manual

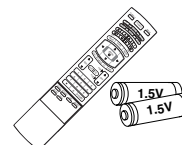
Remote Control /
Batteries

For 42PC1D**, 42PC3D**, 50PC3D**



2-Wall brackets



2-eye-bolts

42PC1D, 42PC3D** only**

2-bolts
(Refer p.19)2-TV brackets
2-Wall brackets

2-TV Bracket Bolts

Twister Holder
Arrange the wires
with the twister holder.Cable
Management
(Refer p.18)

For 32/37/42LC2D**

42LC2D only**

Polishing Cloth
Polish the TV with
the cloth.

32LC2D only**

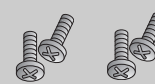
4-bolts for stand
assembly
See below for detail
information.

Polishing Cloth

- Slightly wipe stained spot on the exterior only with the cleansing cloths for the product exterior if there is stain or fingerprint on surface of the exterior.

- Do not wipe roughly when removing stain. Please be cautious of that excessive power may cause scratch or discoloration.

Option Extras

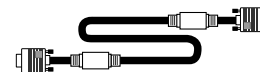

D-sub 15 pin Cable

Stand Installation for 32LC2D**

- 1 Carefully place the product screen side down on a cushioned surface that will protect product and screen from damage.

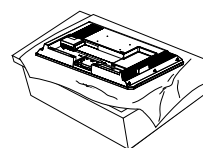

- 2 Place the hook of the stand in the back of the product as shown.

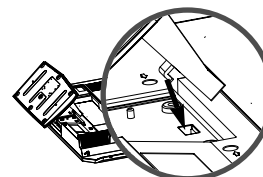

- 3 Install the 4 bolts provided securely, in the back of the product.

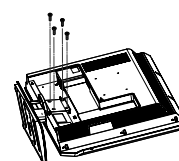

Controls (Model Name: 32/37/42LC2D**)

- This is a simplified representation of front panel.
- This picture shown below may be somewhat different from your TV.

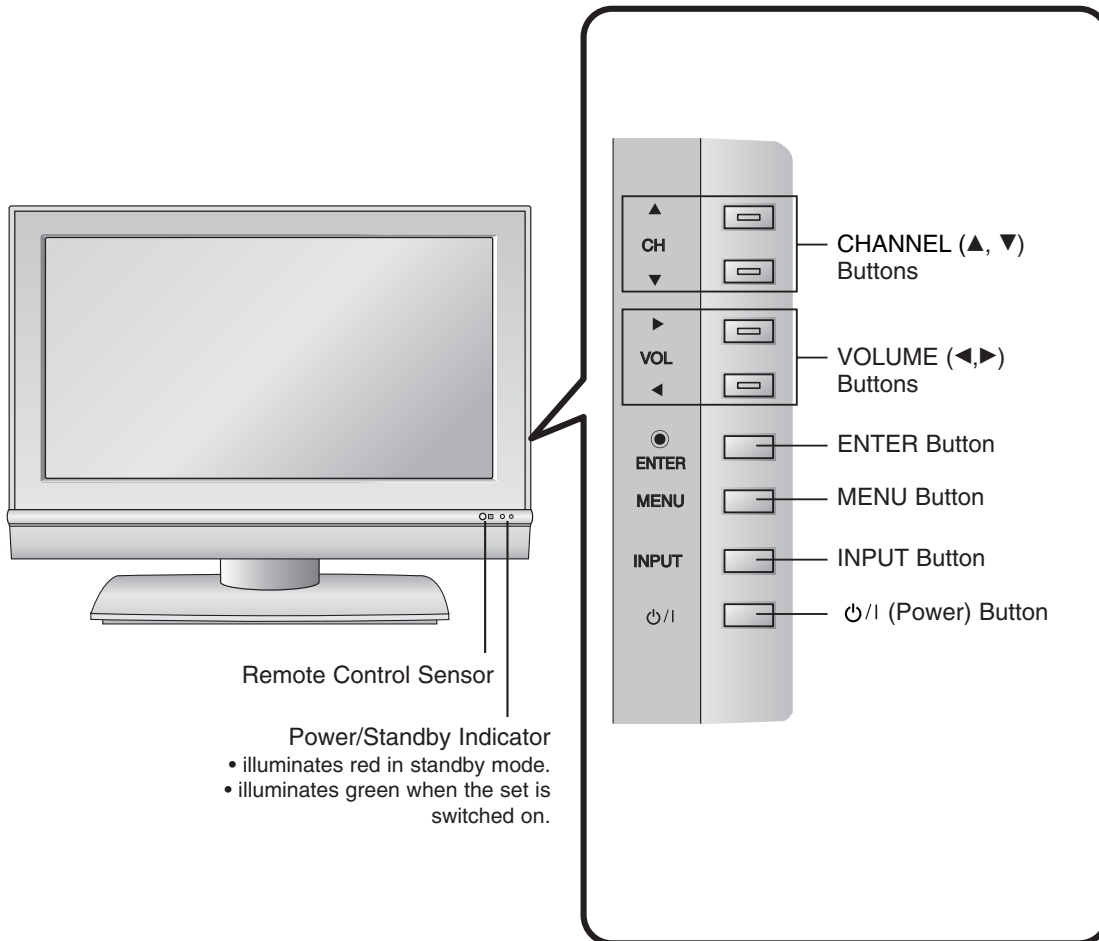

Swivel Stand (42LC2D** only)

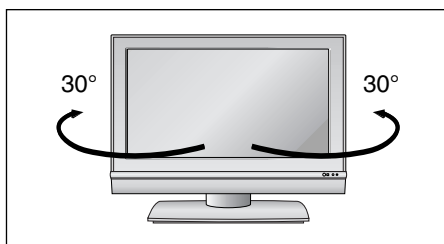

- The TV can be conveniently swivelled on its stand 30° to the left or right to provide the optimum viewing angle.

Connection Options (Model Name: 32/37/42LC2D**)

- Here shown may be somewhat different from your TV.

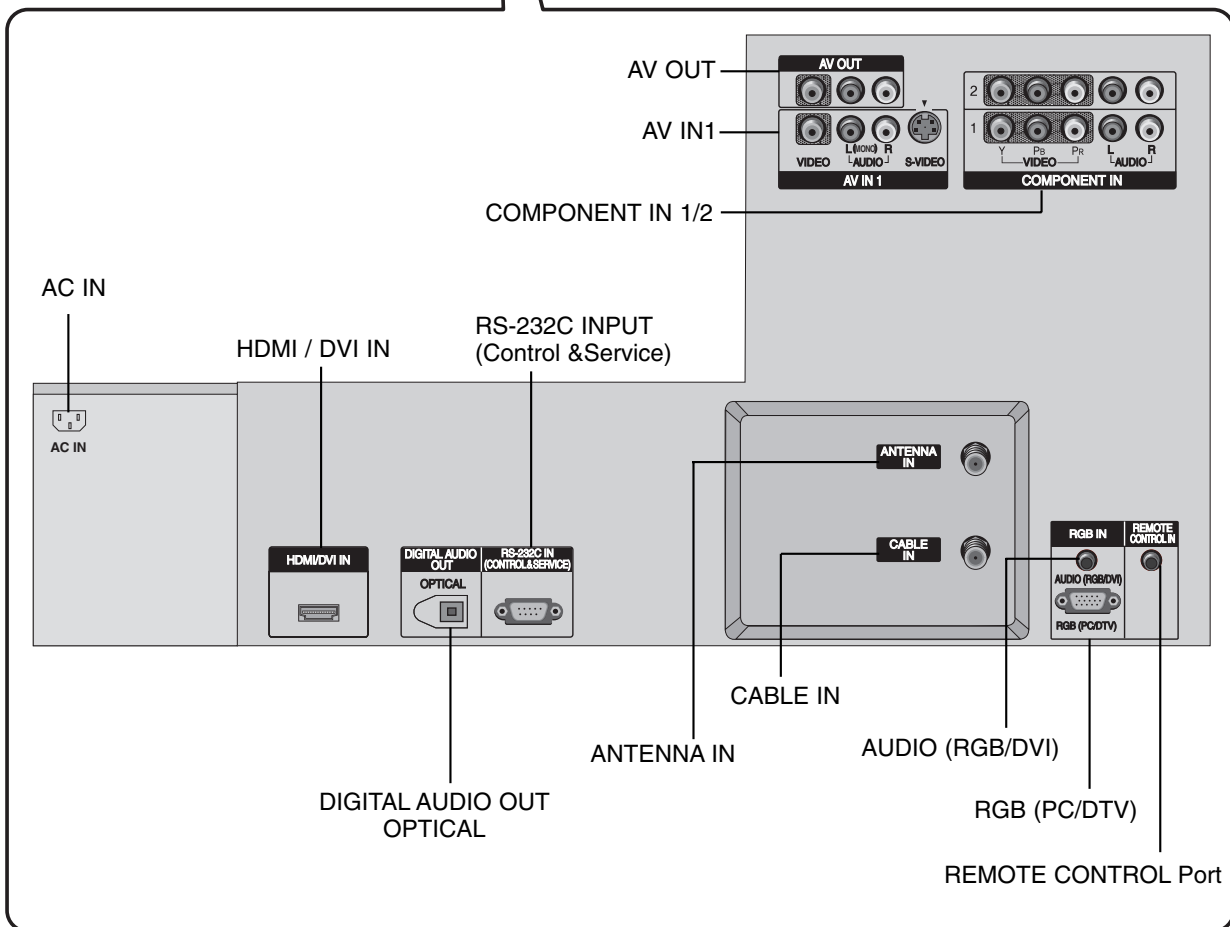
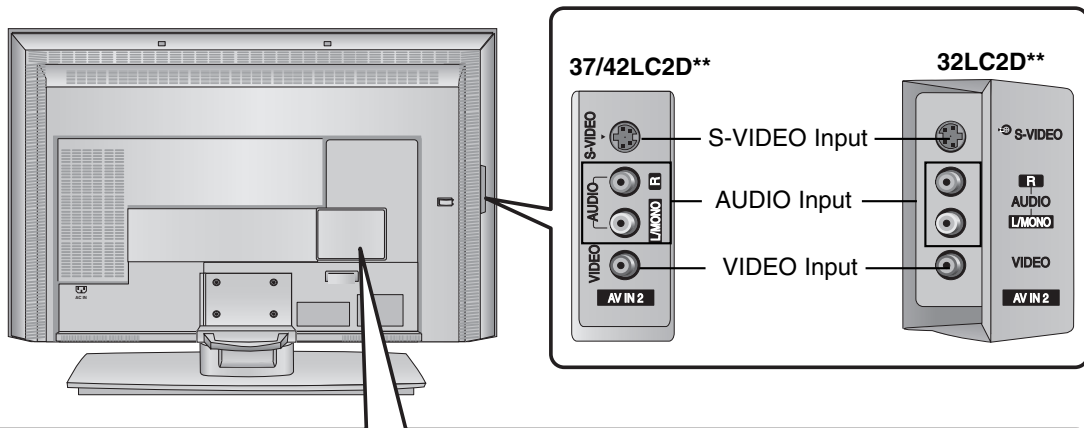

Controls (Model Name: 42PC1D**/42PC3D**/50PC3D**)

- This is a simplified representation of front panel.
- This picture shown below may be somewhat different from your TV.

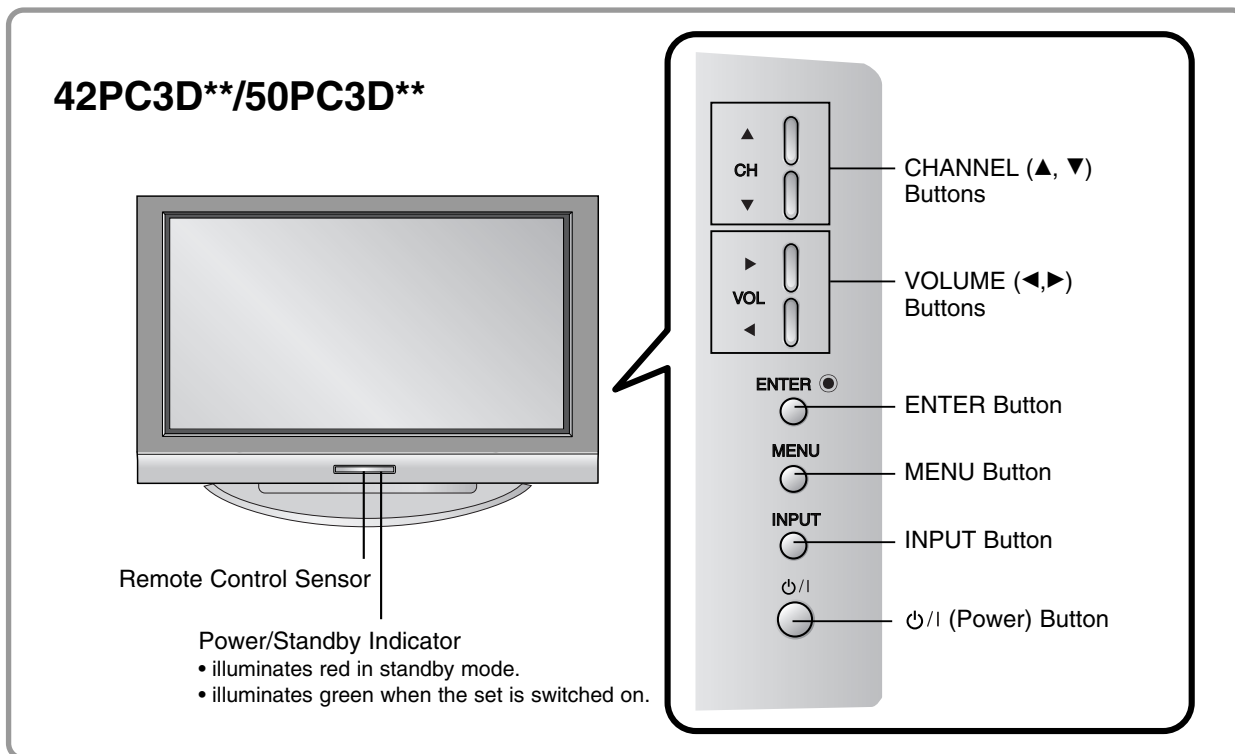
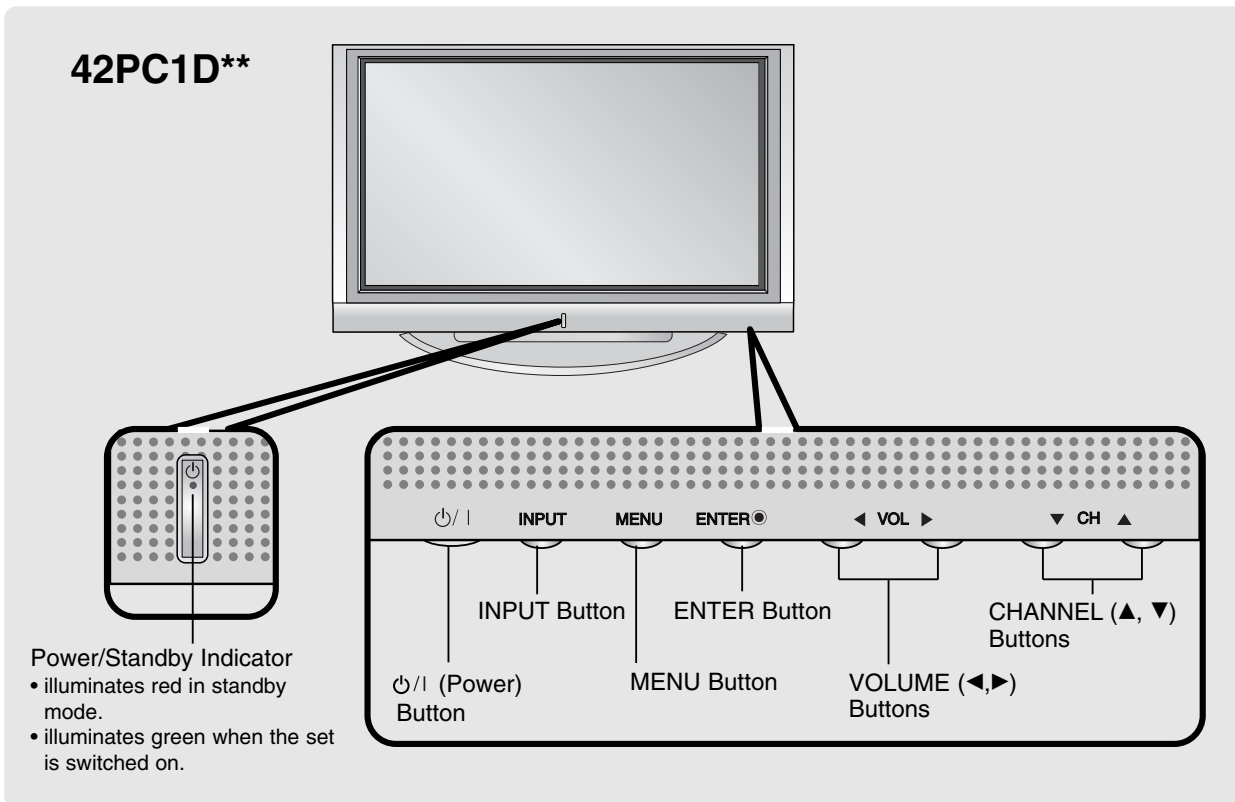

Connection Options (Model Name: 42PC1D**/42PC3D**/50PC3D**)

- Here shown may be somewhat different from your TV.

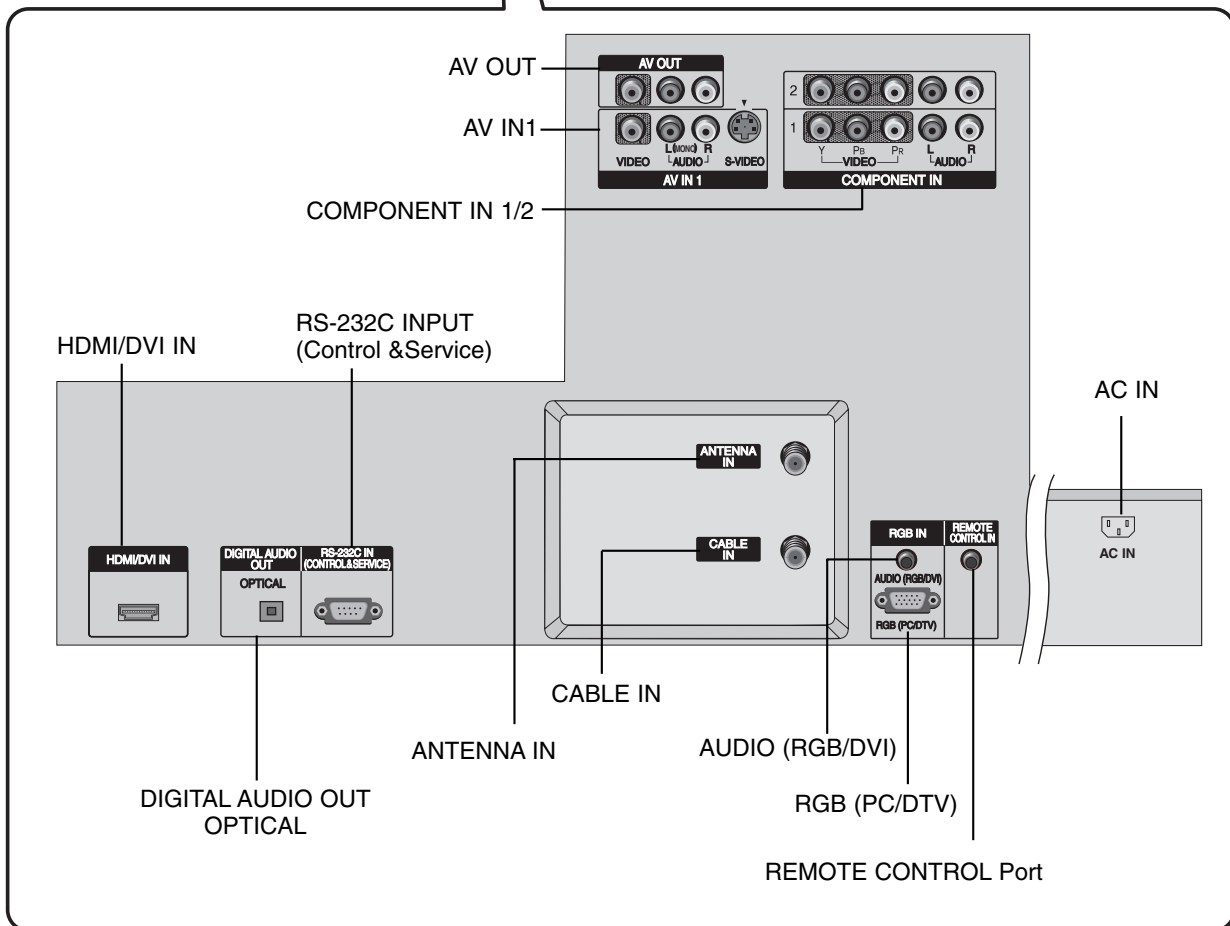
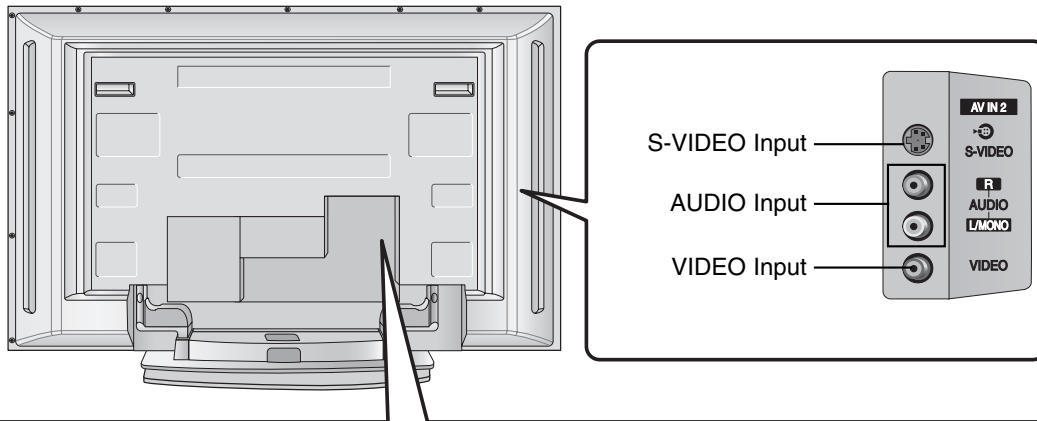

Remote Control Key Functions

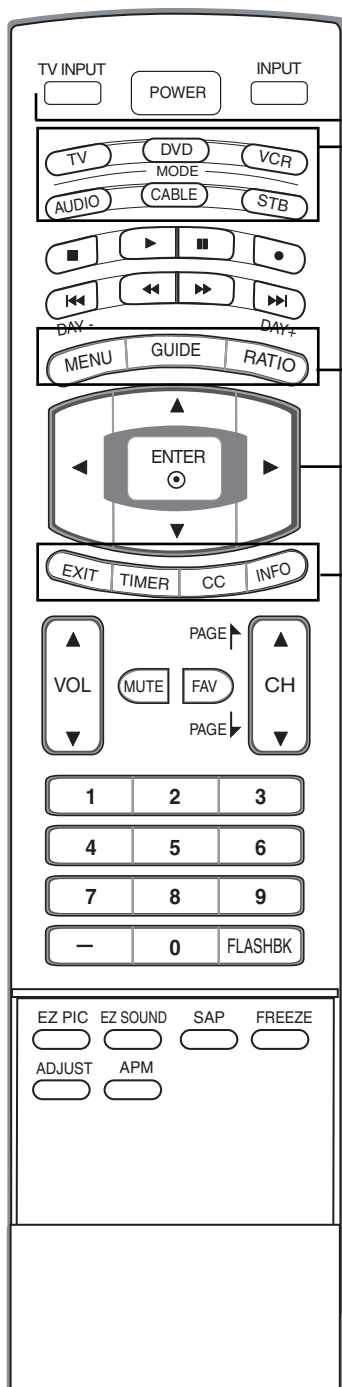

POWER

Turns your TV or any other programmed equipment on or off, depending on mode.

TV INPUT

Rotates the input mode between Antenna and Cable. In AV1-2, Component 1-2, RGB-DTV (or RGB-PC), and HDMI/DVI input sources, screen returns to the last TV channel.

INPUT (Refer to p.14)

External input modes rotate in regular sequence: Antenna, Cable, AV1-2, Component 1-2, RGB-DTV (or RGB-PC), HDMI/DVI). (AV1, AV2, Component 1-2 input sources are linked automatically, Only if these are connected)

MODE

Selects the remote operating mode: TV, DVD, VCR, AUDIO, CABLE, or STB. Select a mode other than TV, for the remote to operate an external device.

MENU

Brings up the main menu to the screen.

GUIDE (Refer to p.16)

Shows program schedule.

RATIO (Refer to p.47)

Changes the aspect ratio.

THUMBSTICK (Up/Down/Left/Right/ENTER)

Allows you to navigate the on-screen menus and adjust the system settings to your preference.

EXIT

Clears all on-screen displays and returns to TV viewing from any menu.

TIMER (Refer to p.45)

Lets you select the amount of time before your TV turns itself off automatically.

CC (Refer to p.49)

Select a closed caption: Off, CC1~4, Text1~4.

INFO (Refer to p.15)

When you watch the TV, information displays on top of the screen. Not available in Component 1-2, RGB and HDMI/DVI mode.

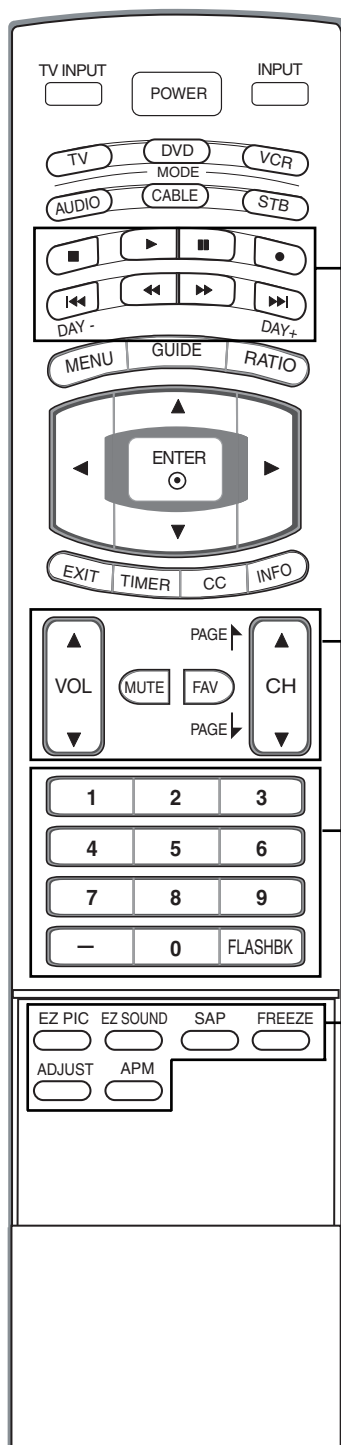
**VCR/DVD/DVHS/Camcorder BUTTONS**

Control some video cassette recorders or DVD players ("RECORD" button is not available for DVD player).

DAY + / DAY-

Moves forward or backward in 24 hour increments.

VOLUME UP/DOWN

Increases/decreases the sound level.

CHANNEL UP/DOWN

Selects available channels found with EZ scan and Manual scan.

PAGE UP/DOWN

Moves from one full set of screen information to the next one.

MUTE

Switches the sound on or off.

FAV

Use to scroll the Favorite channels.

NUMBER BUTTONS**— (DASH)**

Used to enter a program number for multiple program channels such as 2-1, 2-2, etc.

FLASHBK

Returns to the last channel viewed.

EZ PIC (Refer to p.38)

Selects a factory preset picture mode depending on the viewing environment.

EZ SOUND (Refer to p.41)

Selects the sound appropriate for the program's character.

SAP (Refer to p.42)

Selects MTS sound: Mono, Stereo, and SAP in analog mode. Change the audio language in DTV mode.

FREEZE

Freezes the currently-viewed picture.

ADJUST (Refer to p.31)

Adjusts screen position, size, and phase in PC mode.

APM (Refer to p.38)

Concurrently, compare with the Daylight, Normal, Night Time and Custom on the screen.

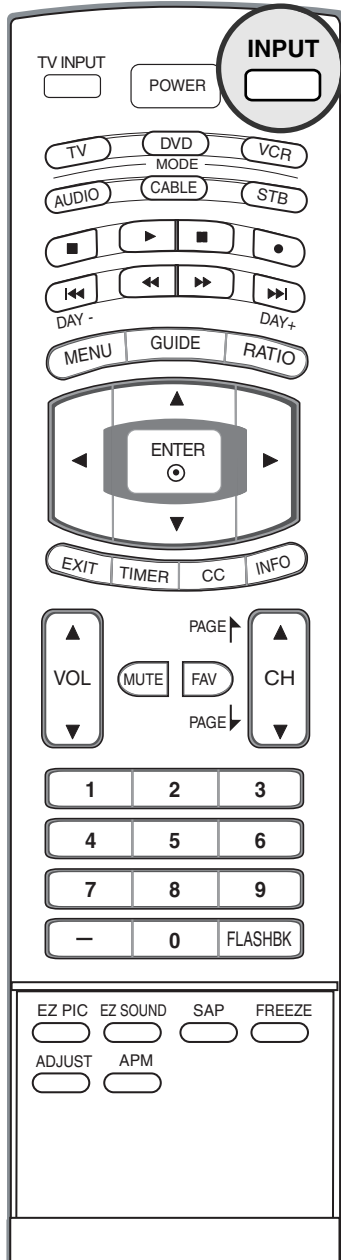

Auto Link

1. When every external equipment is connected:

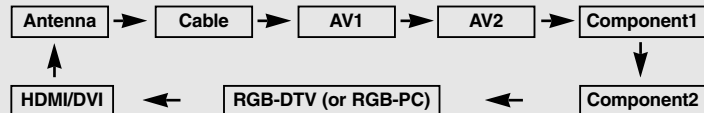

2. When no external equipment is connected:

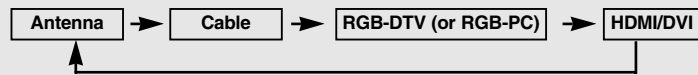

3. When some External Equipment is connected:
(ex: When connected to AV IN1)

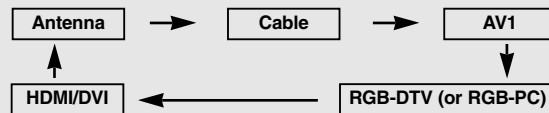

• You can also select **Input Source** in the **SETUP** menu.

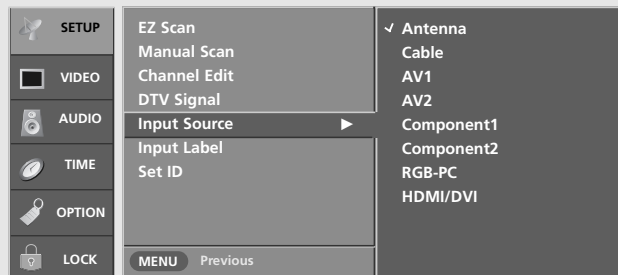

- **Antenna**: Select it when watching the TV/DTV.
- **Cable**: Select it when watching the CATV/CADTV.
- **AV1, AV2**: Select it when watching the VCR or external equipment.
- **Component 1-2**: Select it when using a DVD or Digital set-top box depend on connector.
- **RGB-PC / RGB-DTV**: Select it when using PC or Digital set-top box depend on connector.
- **HDMI / DVI**: Select it when using DVD, PC or Digital set-top box depend on connector.

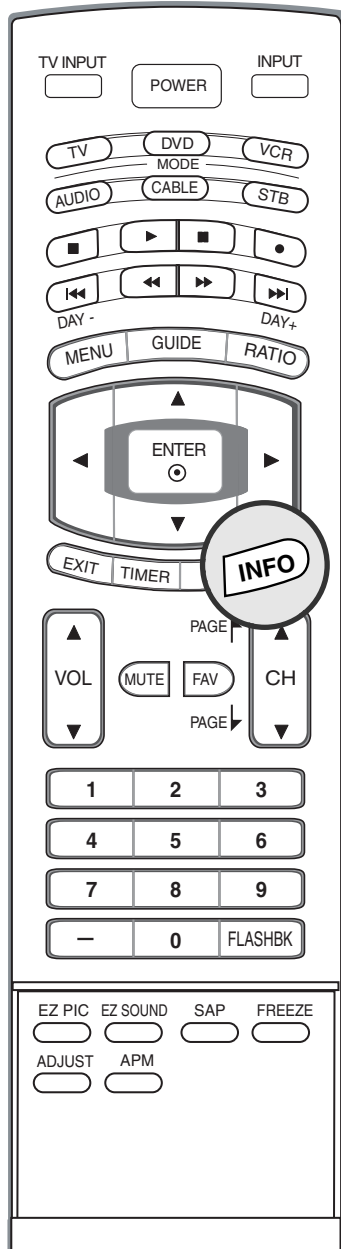

Brief Info.

What is Brief Info?

: Brief Info shows the present screen information.

How to use?

1. Press the **INFO** button to show the Brief Info on the screen.
2. Press the **INFO** button or **EXIT** button to exit.
 - The **INFO** button does not work in Component1, Component2, RGB, and HDMI/DVI modes.

This function works in the following mode:

- Watching TV/DTV/CATV/CADTV
- Watching AV1, AV2

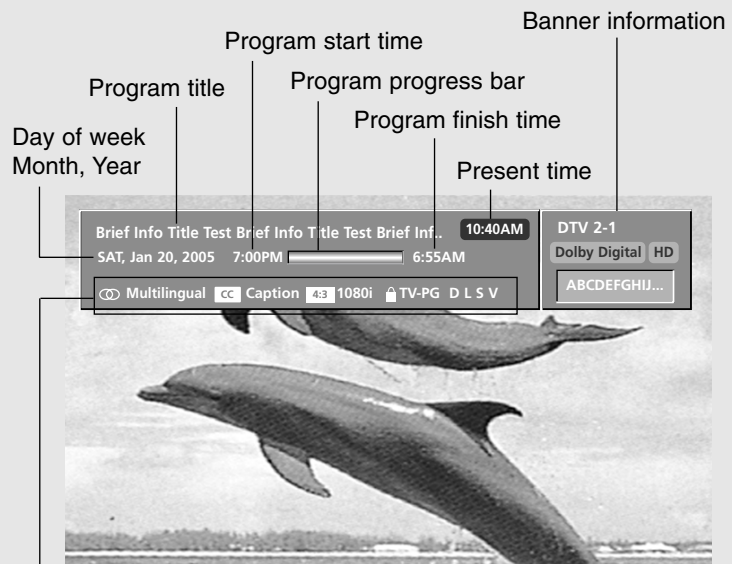

- 4 : 3** The original aspect ratio of the video is 4:3
- 16 : 9** The original aspect ratio of the video is 16:9 (wide)
- 480i** The video resolution is 720x480i
- 480p** The video resolution is 720x480p
- 720p** The video resolution is 1280x720p
- 1080i** The video resolution is 1920x1080i
- Multilingual**: The program contains two or more audio services. Press the **SAP** button to select wanted Audio.
- CC**: **Caption**: The program contains one or more caption services. Press the **CC** button to select wanted Closed caption.
- V-Chip**: The program contains V-Chip information. Refer to the **LOCK** menu: A (Age), D (Dialogue), L (Language), S (Sex), V (Violence), FV (Fantasy Violence)

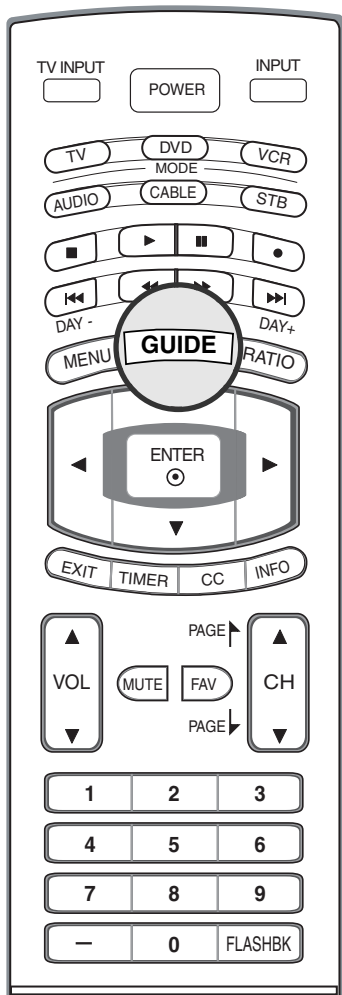

EPG (Electronic Program Guide) (In DTV mode)

- This system has an Electronic Program Guide (EPG) to help you navigate through all the possible viewing options.
- The EPG supplies information such as program listings, start and end times for all available services.
- This function can be used only when the EPG information is broadcasted by broadcasting companies.
- The EPG displays the program description for next 3 days.
- This function is only supported in DTV mode.



- 1 Press the **GUIDE** button to switch on EPG.
- 2 Press the **▲ / ▼ / ◀ / ▶** button to select desired program, then press the **ENTER** button to display the selected program.
- 3 Press the **GUIDE** or **EXIT** button again to switch off EPG and return to TV viewing.

Remote Control Buttons	Function
▲ / ▼ / ◀ / ▶	Select the desired program
●	Change to the selected channel
◀◀ / ▶▶	Jump Page
◀◀◀ / ▶▶▶	Change the date
GUIDE/EXIT	Switch off EPG

Installing Batteries

- 1 Open the battery compartment cover on the back side.

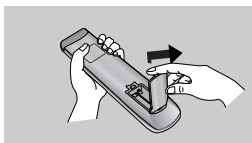

- 2 Insert two batteries in correct polarity (+ with +, - with -). Don't mix old or used batteries with new ones.

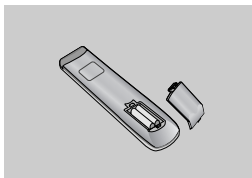

- 3 Close the cover.

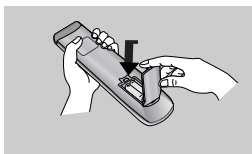

32/37/42LC2D**

42/50PC3D**

42PC1D**

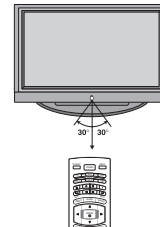
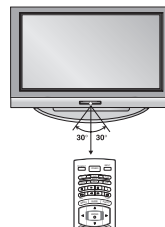
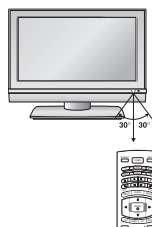

* Use a remote control 7 meter distance and 30 degree (left/right) within the receiving unit scope.

* Dispose of used batteries in a recycle bin to prevent environmental hazards.

Installation

- The TV can be installed in various ways such as on a wall, or on a desktop etc.
- The TV is designed to be mounted horizontally.

GROUNDING

Ensure that you connect the earth ground wire to prevent possible electric shock. If grounding methods are not possible, have a qualified electrician install a separate circuit breaker. Do not try to ground the unit by connecting it to telephone wires, lightening rods, or gas pipes.

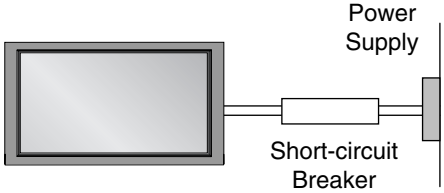

Various Installation

Desktop Pedestal Installation

For proper ventilation, allow a clearance of 4" on each side and from the wall.

32/37/42LC2D**

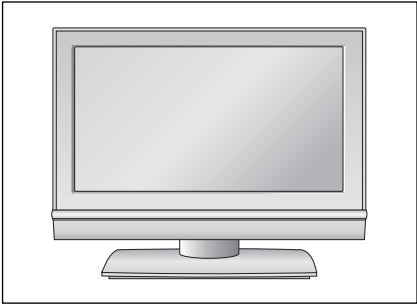

42PC1D**, 42PC3D**, 50PC3D**

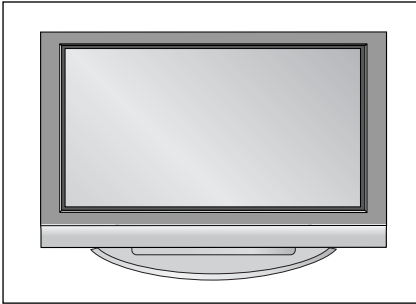

Installation

Basic Connection (For 32/37/42LC2D**)

- 1** Connect the cables as necessary. After connecting the cables neatly, arrange the cables to the Cable Holder.

To connect an additional equipment, see the **External equipment Connections** section.

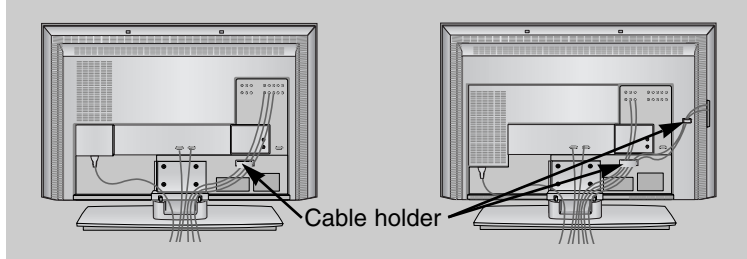

32LC2D**

37/42LC2D**

- 2** Reinstall the **CABLE MANAGEMENT** as shown.

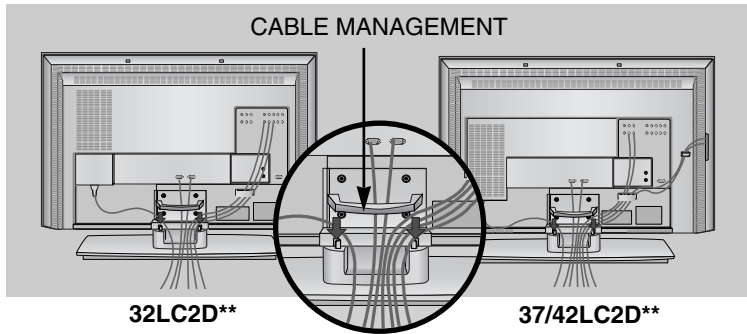

32LC2D**

37/42LC2D**

- 3** Bundle the cables using the supplied twister holder.

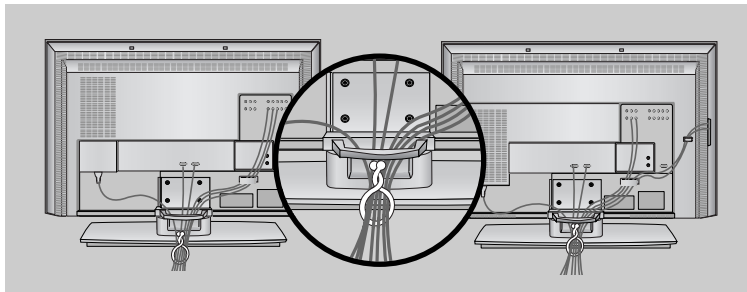

32LC2D**

37/42LC2D**

How to remove the CABLE MANAGEMENT

- Hold the **CABLE MANAGEMENT** with both hands and pull it upward.

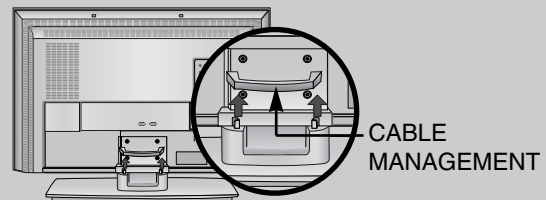

- Do not hold the **CABLE MANAGEMENT** when moving the product.
- If the product is dropped, you may be injured or the product may be broken.

Basic Connection

How to use stand (For 42PC1D**, 42PC3D**)

- 1** Place the set with the screen facing down on a cushion or soft cloth as shown. Before unfolding the stand, please make sure two locks (A) on the bottom of the stand push outward.

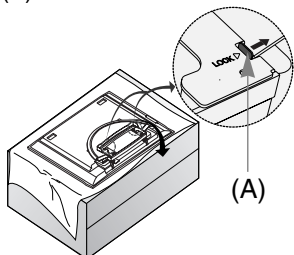

- 2** Pull the stand out as shown. After unfolding the stand, please insert and tighten the screws (provided as parts of the product) in the holes (B) on the bottom of the stand.

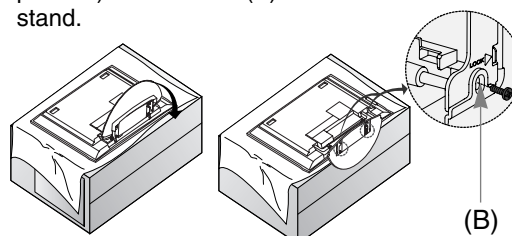

- 3** When connecting cables to the set, Do not disengage the lock (C). This may cause the set to fall, causing serious bodily injury and serious damage to the set.

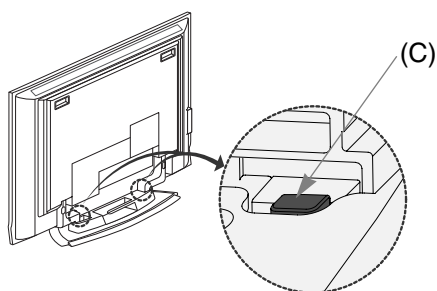

* Image shown here may be slightly different from your set.

When closing the stand for storage

- First remove the screws in the holes (B) on the bottom of the stand. And then pull two Hooks (D) of the stand bottom and fold the stand into the back of the set.
- After folding, push the two Locks (A) of the stand bottom outward.

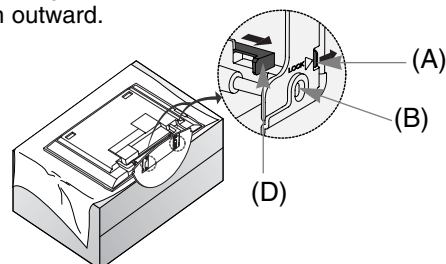

How to arrange the cable (For 50PC3D**)

- 1** Hold the **CABLE MANAGEMENT** with both hands and push it as shown.

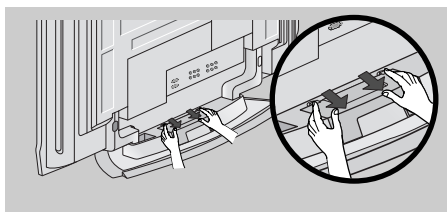

- 2** Connect the cables as necessary. To connect an additional equipment, see the **External equipment Connections** section.

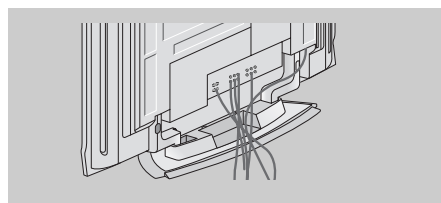

- 3** Reinstall the **CABLE MANAGEMENT** as shown.

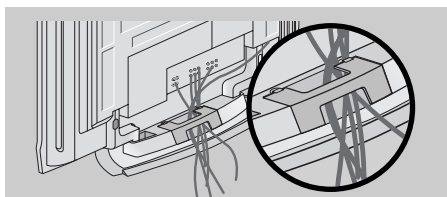

For 42PC1D**, 42PC3D**

Arrange the cable as shown.

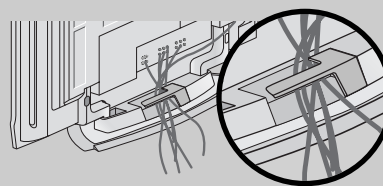

How to join the product assembly to the wall to protect the set tumbling

- Set it up close to the wall so the product doesn't fall over when it is pushed backwards.
- The instructions shown below is a safer way to set up the product, which is to fix it on the wall so the product doesn't fall over when it is pulled in the forward direction. It will prevent the product from falling forward and causing injury. It will also prevent the product from damage caused by fall. Please make sure that children don't climb on or hang from the product.

42PC1D**/42PC3D**/50PC3D**

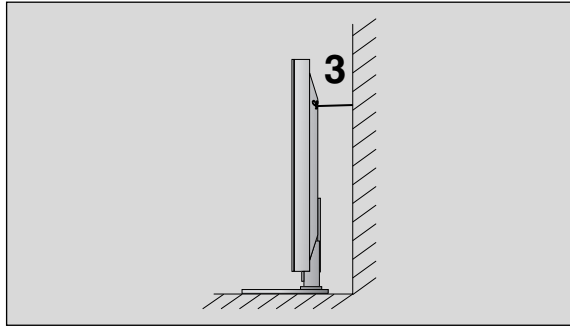
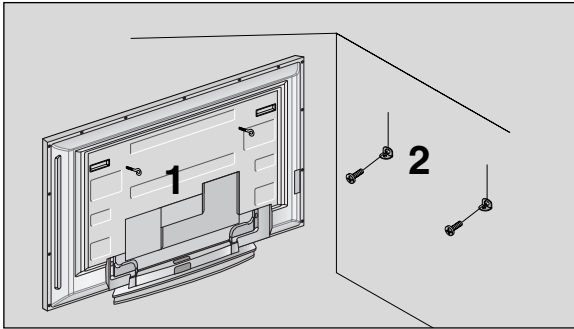

32/37/42LC2D**

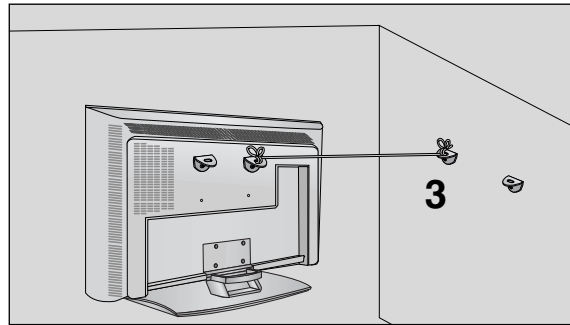
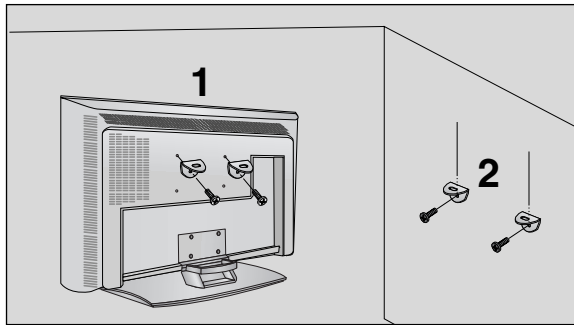

- 1** Use the eye-bolts or TV brackets/bolts to fix the product to the wall as shown in the picture.
(If your product has the bolts in the eye-bolts position , loosen the bolts.)
* Insert the eye-bolts or TV brackets/bolts and tighten them securely in the upper holes.
- 2** Secure the wall brackets with the bolts (not provided as parts of the product, must purchase separately) on the wall. Match the height of the bracket that is mounted on the wall.
- 3** Use a sturdy rope (not provided as parts of the product, must purchase separately) to tie the product. It is safer to tie the rope so it becomes horizontal between the wall and the product.

Notes

- When moving the product to another place undo the ropes first.
- Use a product holder or a cabinet that is big and strong enough for the size and weight of the product.
- To use the product safely make sure that the height of the bracket that is mounted on the wall is same as that of the product.

External Equipment Connections

NOTE: All cables shown are not included with the TV

Antenna or Cable Connection

Analog and Digital TV signals provided on antenna

- Antenna or Cable Service without a Cable Box Connection.
- For optimum picture quality, adjust antenna direction if needed.

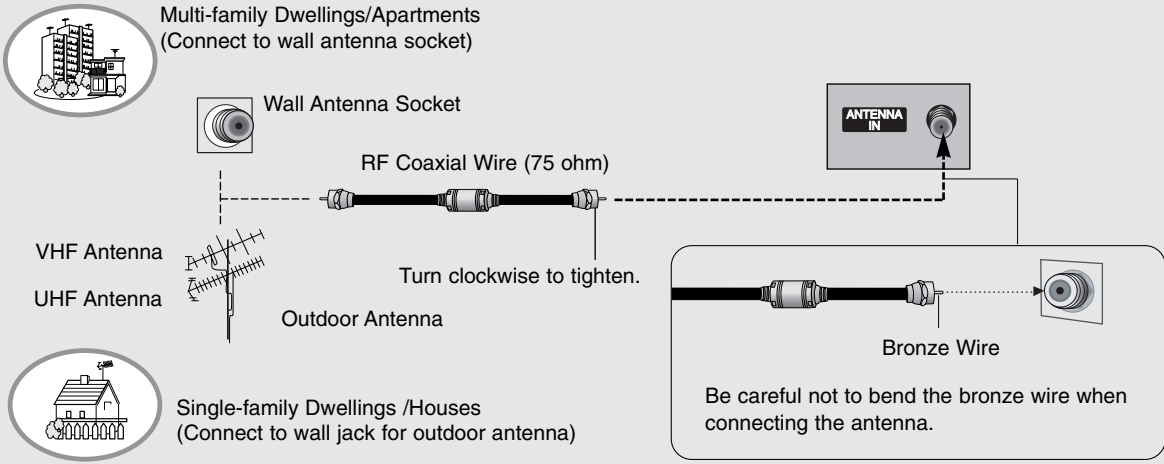

Analog and Digital TV signals provided on cable

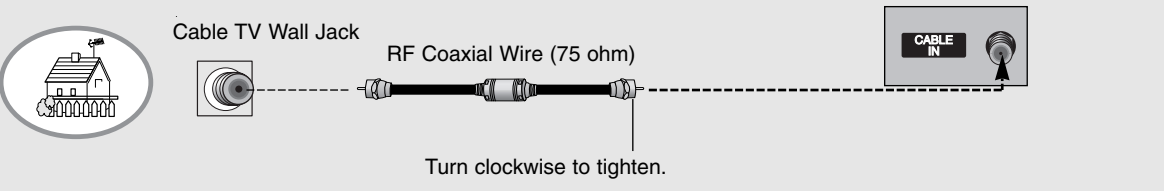

Analog and Digital TV signals provided on cable and antenna

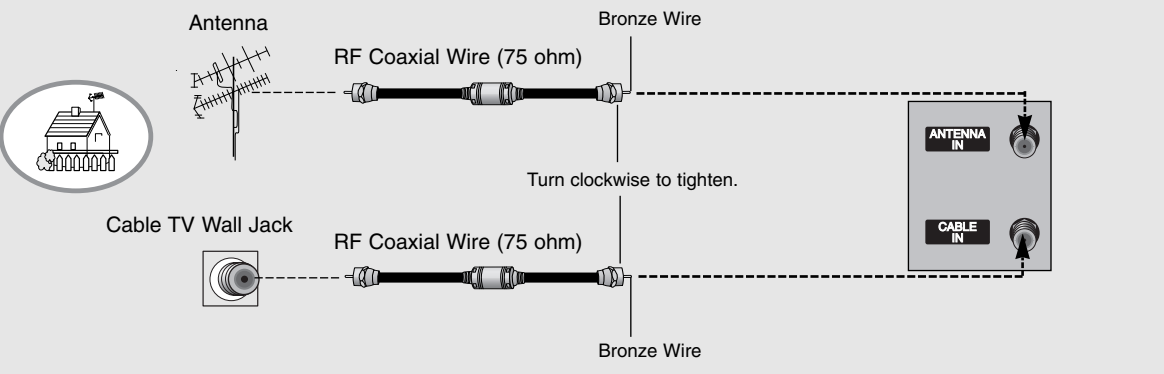

ANTENNA IN

VHF UHF

signal amplifier

CABLE IN

- In a poor signal area to improve picture quality, purchase and install a signal amplifier.
- If the antenna needs to be split for two TV's, install a "2-Way Signal Splitter" in the connections.
- If the antenna is not installed properly, contact your dealer for assistance.

VCR Setup

- To avoid picture noise (interference), leave an adequate distance between the VCR and TV.
- Typically a frozen still picture from a VCR. If the 4:3 picture format is used; the fixed images on the sides of the screen may remain visible on the screen.

When connecting with an antenna

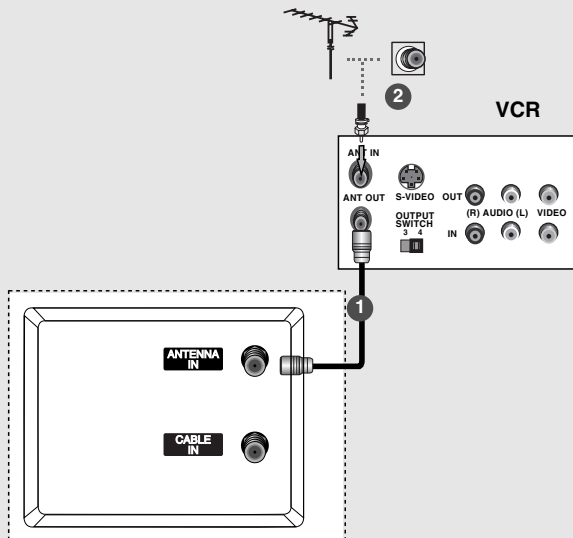

- 1 Connect the RF antenna out socket of the VCR to the **Antenna** socket on the set.
- 2 Connect the antenna cable to the RF antenna in socket of the VCR.
- 3 Set VCR output switch to 3 or 4 and then tune TV to the same channel number.
- 4 Insert a video tape into the VCR and press PLAY on the VCR. (Refer to the VCR owner's manual.)

When connecting with a RCA cable

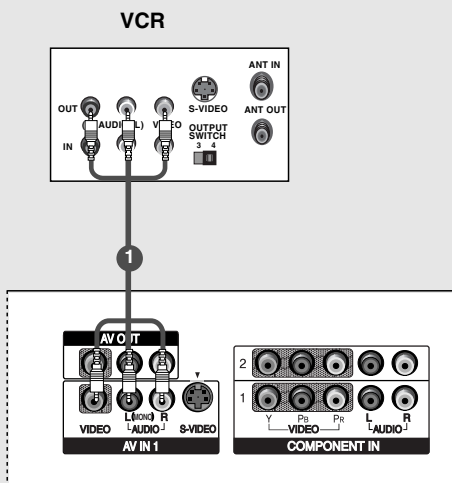

- 1 Connect the **AUDIO/VIDEO** jacks between TV and VCR. Match the jack colors (Video = yellow, Audio Left = white, and Audio Right = red)
- 2 Insert a video tape into the VCR and press PLAY on the VCR. (Refer to the VCR owner's manual.)
- 3 Select **AV1** input source using the **INPUT** button on the remote control.
 - If connected to **AV IN2**, select **AV2** input source.



- If you have a mono VCR, connect the audio cable from the VCR to the **AUDIO L/MONO** jack of the set.
- This TV finds the connected input sources automatically for AV1, AV2 and Component 1-2. It is presumed that RGB and HDMI/DVI sources are connected.

When connecting with an S-Video cable

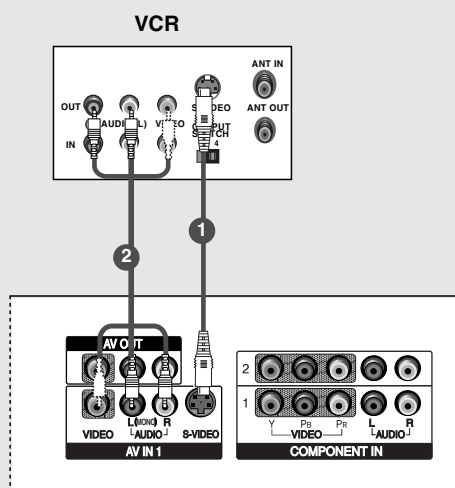

- 1 Connect the S-VIDEO output of the VCR to the **S-VIDEO** input on the set. The picture quality is improved; compared to normal composite (RCA cable) input.
- 2 Connect the audio outputs of the VCR to the **AUDIO** input jacks on the set.
- 3 Insert a video tape into the VCR and press PLAY on the VCR. (Refer to the VCR owner's manual.)
- 4 Select **AV1** input source with using the **INPUT** button on the remote control.
- If connected to **AV IN2**, select **AV2** input source.



Do not connect to both Video and S-Video at the same time. In the event that you connect both Video and the S-Video cables, only the S-Video will work.

External AV Source Setup

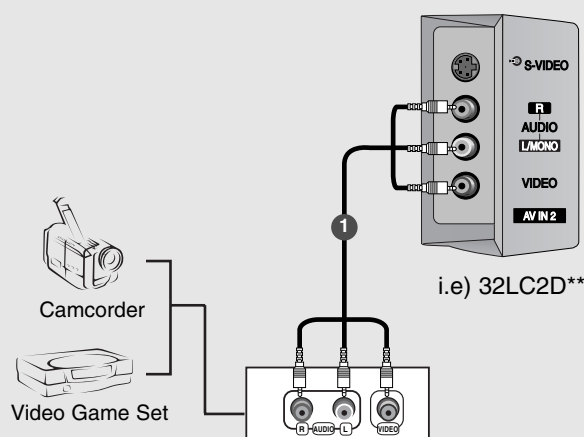

- 1 Connect the **AUDIO/VIDEO** jacks between TV and external equipment. Match the jack colors (Video = yellow, Audio Left = white, and Audio Right = red).
- 2 Select **AV2** input source with using the **INPUT** button on the remote control.
- If connected to **AV IN1** input, select **AV1** input source.
- 3 Operate the corresponding external equipment. Refer to external equipment operating guide.



• This TV finds the connected input sources automatically for AV1, AV2 and Component 1-2. It is presumed that RGB and HDMI/DVI sources are connected.

DVD Setup

When connecting with a S-Video cable

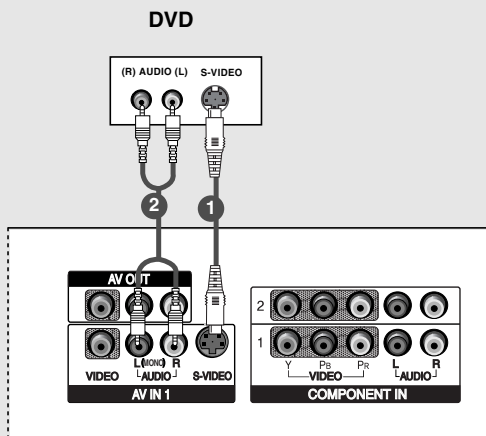

- 1 Connect the S-VIDEO output of the DVD to the **S-VIDEO** input on the set.
- 2 Connect the audio outputs of the DVD to the **AUDIO** input jacks on the set.
- 3 Turn on the DVD player, insert a DVD.
- 4 Select **AV1** input source with using the **INPUT** button on the remote control.
- If connected to **AV IN2**, select **AV 2** input source.
- 5 Refer to the DVD player's manual for operating instructions.

When connecting with a HDMI cable

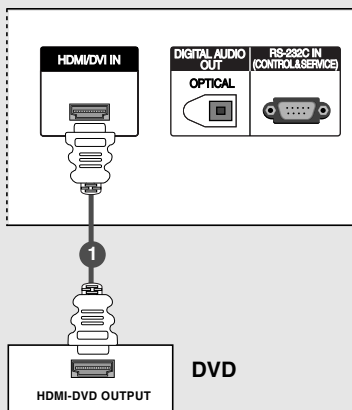

- 1 Connect the HDMI output of the DVD to the **HDMI/DVI IN** jack on the set.
- 2 Select **HDMI/DVI** input source with using the **INPUT** button on the remote control.
- 3 Refer to the DVD player's manual for operating instructions.

TV can receive the video and audio signal simultaneously by using a HDMI cable.

- If the DVD supports Auto HDMI function, the DVD output resolution will be automatically set to 1280x720p.
- If the DVD does not support Auto HDMI, you need to set the output resolution appropriately. To get the best picture quality, adjust the output resolution of the DVD to 1280x720p.

When connecting with a component cable

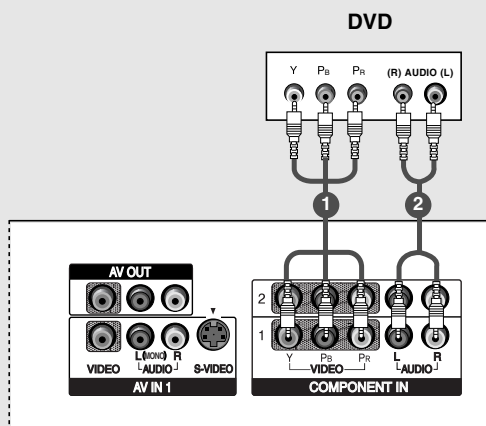

- 1 Connect the video outputs (Y, Pb, Pr) of the DVD to the **COMPONENT IN VIDEO** jacks on the set.
- 2 Connect the audio outputs of the DVD to the **COMPONENT IN AUDIO** jacks on the set.
- 3 Turn on the DVD player, insert a DVD.
- 4 Select **Component 1** input source with using the **INPUT** button on the remote control.
- If connected to **COMPONENT 2**, select **Component 2** input source.
- 5 Refer to the DVD player's manual for operating instructions.



• **Component Input ports**

To get better picture quality, connect a DVD player to the component input ports as shown below.

Component ports on the TV	Y	Pb	Pr
Video output ports on DVD player	Y	Pb	Pr
	Y	B-Y	R-Y
	Y	Cb	Cr
	Y	Pb	Pr

HDSTB Setup

- This TV can receive Digital Over-the-air/Cable signals without an external digital set-top box. However, if you do receive Digital signals from a digital set-top box or other digital external device, refer to the figure as shown below.

When connecting with a D-sub 15 pin cable

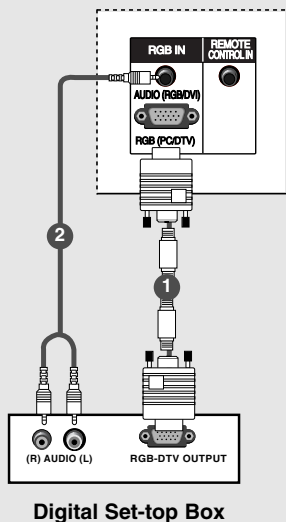

- 1 Connect the RGB output of the digital set-top box to the **RGB (PC/DTV)** jack on the set.
- 2 Connect the audio outputs of the set-top box to the **AUDIO (RGB/DVI)** jack on the set.
- 3 Turn on the digital set-top box. (Refer to the owner's manual for the digital set-top box.)
- 4 Select **RGB-DTV** input source with using the **INPUT** button on the remote control.

When connecting with a HDMI cable

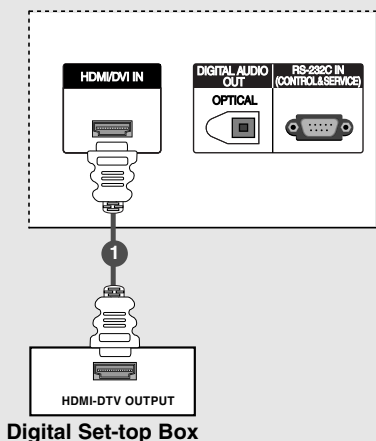

- 1 Connect the HDMI output of the digital set-top box to the **HDMI/DVI IN** jack on the set.
- 2 Select **HDMI/DVI** input source with using the **INPUT** button on the remote control.
- 3 Turn on the digital set-top box. (Refer to the owner's manual for the digital set-top box.)



- TV can receive the video and audio signal simultaneously with using a HDMI cable.
- If the digital set-top box supports Auto HDMI function, output resolution of the digital set-top box will be automatically set to 1280x720p.
- If the digital set-top box does not support Auto HDMI, you need to set the output resolution appropriately. To get the best picture quality, adjust the output resolution of the digital set-top box to 1280x720p.

When connecting with a Component cable

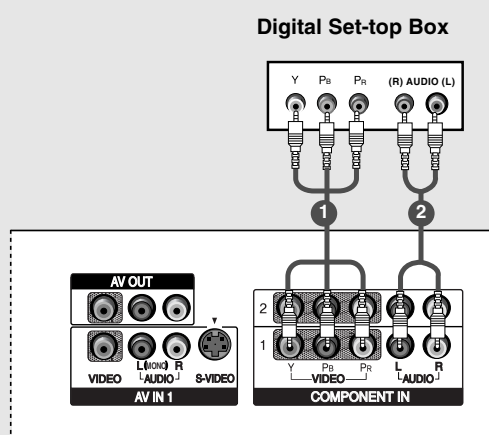

- 1 Connect the video outputs (Y, Pb, Pr) of the digital set-top box to the **COMPONENT IN VIDEO** jacks on the set.
- 2 Connect the audio output of the digital set-top box to the **COMPONENT IN AUDIO** jacks on the set.
- 3 Turn on the digital set-top box. (Refer to the owner's manual for the digital set-top box.)
- 4 Select **Component 1** input source with using the **INPUT** button on the remote control.
- If connected to **COMPONENT 2**, select **Component 2** input source.



Signal	Component1/2	RGB-DTV, HDMI/DVI
480i	Yes	No
480p/720p/1080i	Yes	Yes

When connecting with a HDMI to DVI cable

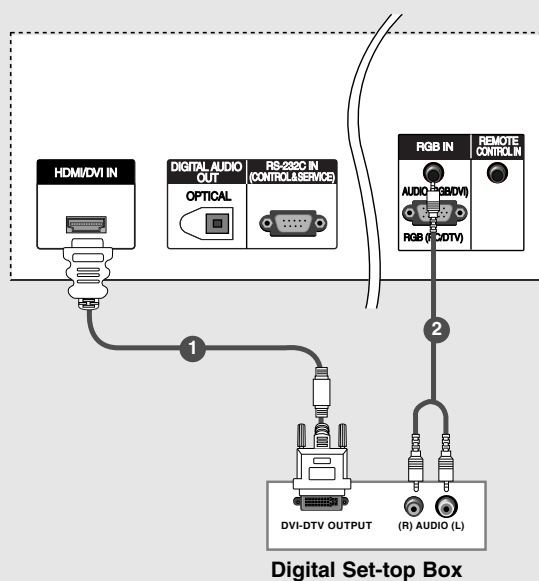

- 1 Connect the DVI output of the digital set-top box to the **HDMI/DVI IN** jack on the set.
- 2 Connect the audio outputs of the set-top box to the **AUDIO (RGB/DVI)** jack on the set.
- 3 Turn on the digital set-top box. (Refer to the owner's manual for the digital set-top box.)
- 4 Select **HDMI/DVI** input source with using the **INPUT** button on the remote control.



- If the digital set-top box has a DVI output and no HDMI output, a separated audio connection is necessary.
- If the digital set-top box supports Auto DVI function, the output resolution of the digital set-top box will be automatically set to 1280x720p.
- If the digital set-top box does not support Auto DVI, you need to set the output resolution appropriately. To get the best picture quality, adjust the output resolution of the digital set-top box to 1280x720p.

Monitor Out Setup

- The TV has a special signal output capability which allows you to hook up a second TV or monitor.

- 1 Connect the second TV or monitor to the TV's **AV OUTPUT** jacks.
- 2 See the Operating Manual of the second TV or monitor for further details regarding that device's input settings.

- Component 1-2, RGB-PC/RGB-DTV, HDMI/DVI, DTV input sources cannot be used for Monitor out.
- We recommend to use the video and audio output jacks for VCR recording.

Digital Audio Output

- Send the TV's audio to external audio equipment (stereo system) via the Digital Audio Output Optical port.

- 1 Connect one end of an optical cable to the TV Digital Audio Optical Output port.
- 2 Connect the other end of the optical cable to the digital audio optical input on the audio equipment.
- 3 See the external audio equipment instruction manual for operation.
When connecting with external audio equipments, such as amplifiers or speakers, please turn the TV speakers off. (Refer to p.43)

CAUTION
Do not look into the optical output port. Looking at the laser beam may damage your vision.

PC Setup

- This TV provides Plug and Play capability, meaning that the PC adjusts automatically to the TV's settings.

When connecting with a D-sub 15 pin cable

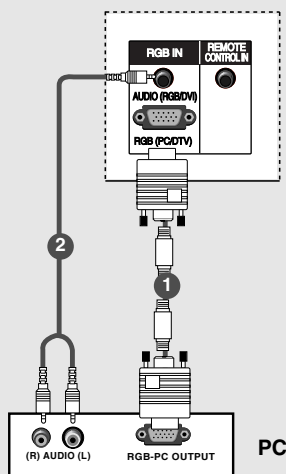

- 1 Connect the RGB output of the PC to the **RGB (PC/DTV)** jack on the set.
- 2 Connect the PC audio outputs to the **AUDIO (RGB/DVI)** jack on the set.
- 3 Turn on the PC and the set.
- 4 Select **RGB-PC** input source with using the **INPUT** button on the remote control.

When connecting with a HDMI to DVI cable

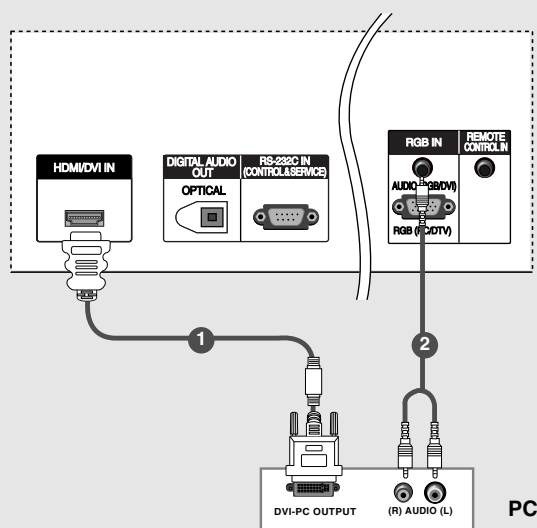

- 1 Connect the DVI output of the PC to the **HDMI/DVI IN** jack on the set.
- 2 Connect the audio outputs of the PC to the **AUDIO (RGB/DVI)** jack on the set.
- 3 Turn on the PC and the set.
- 4 Select **HDMI/DVI** input source with using the **INPUT** button on the remote control.



- If the PC has a DVI output and no HDMI output, a separated audio connection is necessary.
- If the PC does not support Auto DVI, you need to set the output resolution appropriately. To get the best picture quality, adjust the output resolution of PC graphics card's output resolution to 1024x768, 60Hz.



1. To get the best picture quality, adjust the PC graphics card to 1024x768, 60Hz.
2. Depending on the graphics card, DOS mode may not work if a HDMI to DVI Cable is in use.
3. When Source Devices connected with HDMI/DVI Input, output PC Resolution (VGA, SVGA, XGA), Position and Size may not fit to Screen. Press the ADJUST button to adjust the screen Position of TV SET and contact an PC graphics card service center.
4. When Source Devices connected with HDMI/DVI Input, output TV SET Resolution (480p, 720p, 1080i) and TV SET Display fit EIA/CEA-861-B Specification to Screen. If not, refer to the Manual of HDMI/DVI Source Devices or contact your service center.
5. In case HDMI/DVI Source Devices is not connected Cable or poor cable connection, "NO SIGNAL" OSD display in HDMI/DVI Input. In case that Video Resolution is not supported TV SET output in HDMI/DVI Source Devices, "INVALID FORMAT" OSD display. Refer to the Manual of HDMI/DVI Source Devices or contact your service center.
6. Check the image on your TV. There may be noise associated with the resolution, vertical pattern, contrast or brightness in PC, HDMI/DVI mode. If noise is present, change the PC or HDMI/DVI mode to another resolution, change the refresh rate to another rate or adjust the brightness and contrast on the menu until the picture is clear. If the refresh rate of the PC graphic card can not be changed, change the PC graphic card or consult the manufacturer of the PC graphic card.
7. Avoid keeping a fixed image on the TV's screen for a long period of time. The fixed image may become permanently imprinted on the screen.
8. The synchronization input form for Horizontal and Vertical frequencies is separate.

**Supported Display Resolution
(RGB-PC, HDMI/DVI Mode)**

Resolution	Horizontal Frequency (kHz)	Vertical Frequency (Hz)	Resolution	Horizontal Frequency (kHz)	Vertical Frequency (Hz)
* 640x350	31.468	70.08	800x600	35.156	56.25
* 720x400	31.469	70.08		37.879	60.31
640x480	31.469	59.94		48.077	72.18
	37.861	72.80		46.875	75.00
* RGB-PC only	37.500	75.00	1024x768	48.363	60.00
				56.476	70.06
				60.023	75.02

Screen Setup for PC mode

- When RGB is connected to PC input and select the RGB-PC, this function is used.
- When HDMI/DVI is connected to PC input and select HDMI/DVI input, this function is used.
- In RGB-DTV mode, SIZE and PHASE is not available.
- After connecting RGB-PC or HDMI/DVI to PC input and checking the screen quality.

* Adjustment for screen Position, Size, and Phase

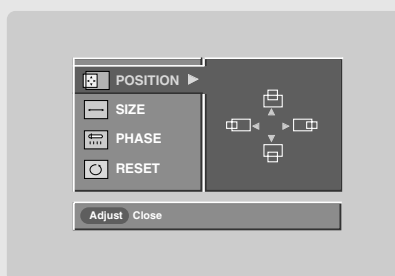
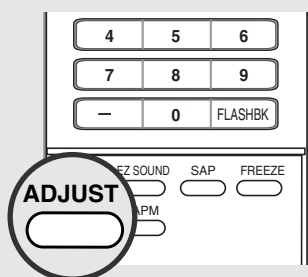

Mini Glossary

Position This function is to adjust picture to left/right and up/down as you prefer.

Size This function is to minimize any vertical bars or stripes visible on the screen background. And the horizontal screen size will also change.

Phase This function allows you to remove any horizontal noise and clear or sharpen the image of characters.

- 1 Press the **ADJUST** button and then use **▲ / ▼** button to select **POSITION**, **SIZE**, or **PHASE**.
- 2 Press **ENTER** button and then use **▲ / ▼ / ◀ / ▶** buttons to make appropriate adjustments.
 - The **PHASE** adjustment range is -16 ~ +16.
(In HDMI/DVI-PC mode, **PHASE** is not available.)
 - The **SIZE** adjustment range is -30 ~ +30.
- 3 Press **ENTER** button.

* Initializing (Reset to original factory values)

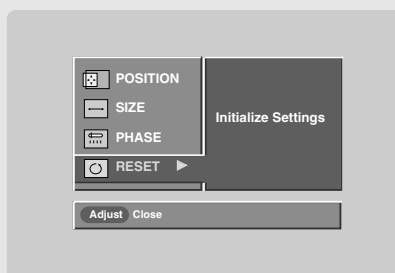
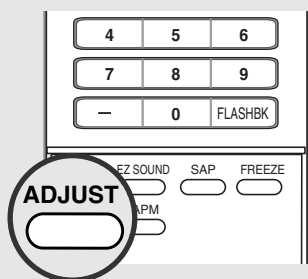

- To initialize the adjusted values

- 1 Press the **ADJUST** button and then use **▲ / ▼** button to select the **RESET** option.
- 2 Press **ENTER** button and then use **◀ / ▶** button to select **Yes**.
- 3 Press **ENTER** button.

Operation

Basic operation

Turning on the TV

1. First, connect power cord correctly. At this moment, the TV switches to standby mode.
In standby mode to turn TV on, press the $\phi/|$, **INPUT, CH ▲ / ▼** button on the TV or press the **POWER, TV INPUT, INPUT, CH ▲ / ▼**, Number (0 ~ 9) button on the remote control .
2. Select the viewing source by using **TV INPUT, INPUT** button on the remote control.
This TV is programmed to remember which power state it was last set to, even if the power cord is out.
3. When finished using the TV, press the **POWER** button on the remote control. The TV reverts to standby mode.

Volume Adjustment

1. Press the **VOL ▲ / ▼** button to adjust the volume.
2. If you want to switch the sound off, press the **MUTE** button.
3. You can cancel this function by pressing the **MUTE** or **VOL ▲ / ▼** button.

Channel Selection

Press the **CH ▲ / ▼** or **NUMBER** buttons to select a channel number.



- If you intend to be away on vacation, disconnect the power plug from the wall power outlet.

On Screen Menu Language Selection

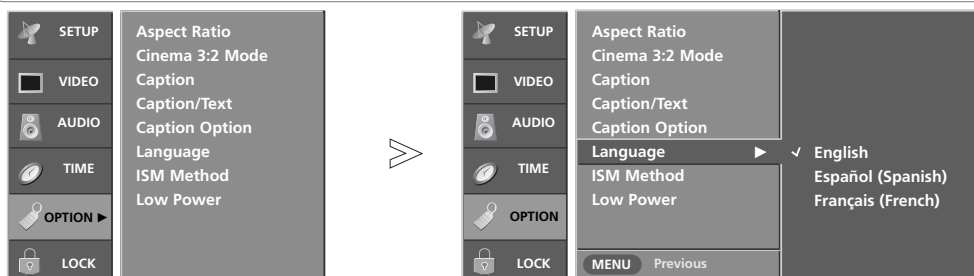

- The menus can be shown on the screen in the selected language. First select your language.

- 1 Press the **MENU** button and then use **▲ / ▼** button to select the **OPTION** menu.
- 2 Press the **▶** button and then use **▲ / ▼** button to select **Language**.
- 3 Press the **▶** button and then use **▲ / ▼** button to select your desired language. From this point on, the on-screen menus will be shown in the selected language.
- 4 Press **EXIT** button to return to TV viewing or press **MENU** button to return to the previous menu.

On Screen Menus Selection and Adjustment

How to adjust the OSD screen

1. Press the **MENU** button and then **▲ / ▼** button to select each menu.
2. Press the **▶** button and then use **▲ / ▼ / ◀ / ▶** button to display the available menus.

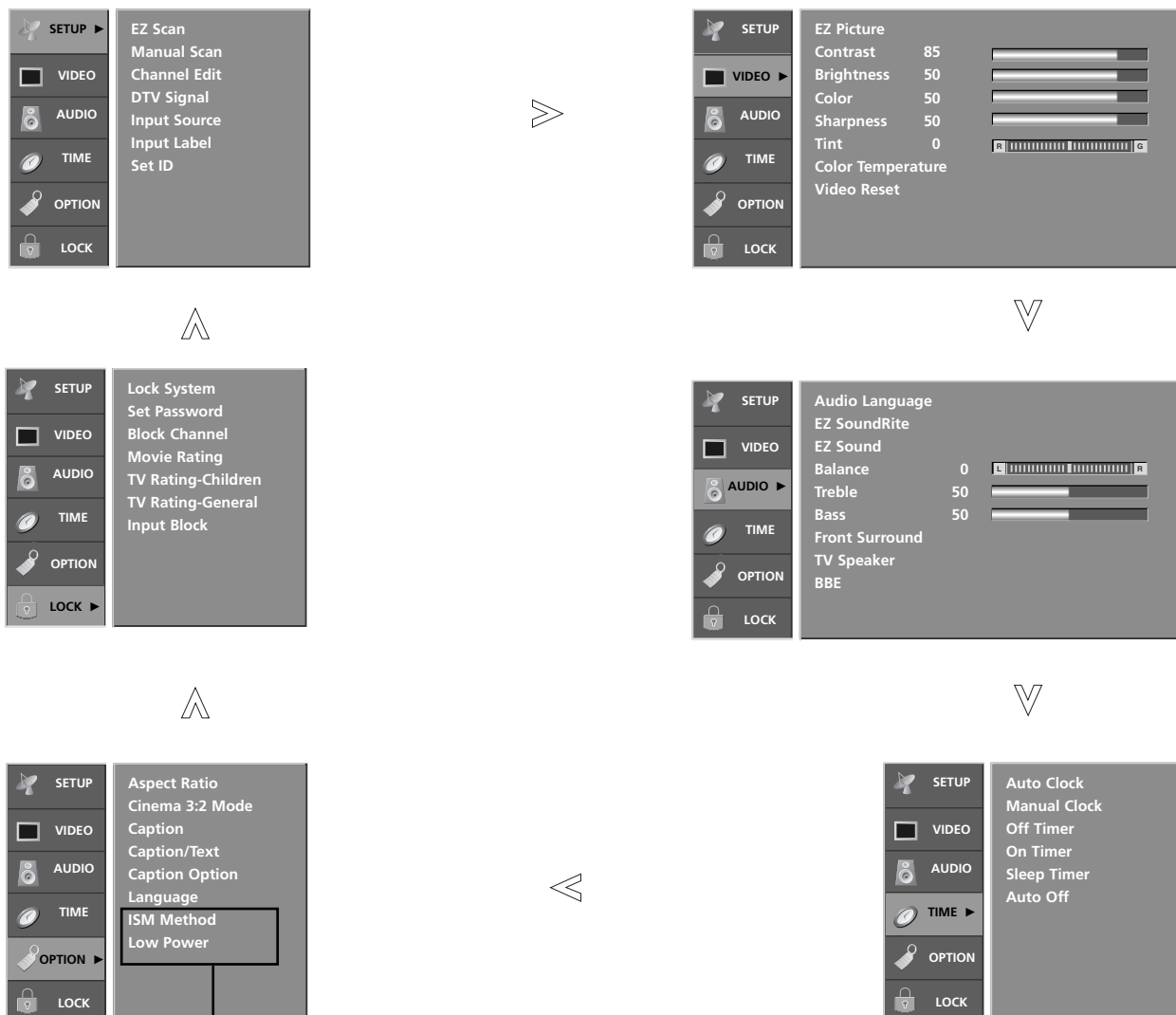

*** Note: These functions are available in 42PC1D**, 42PC3D**, 50PC3D** models only.**



• Your TV's OSD (On Screen Display) may differ slightly from what is shown in this manual.

Setup Menu Options

EZ Scan (Channel Search)

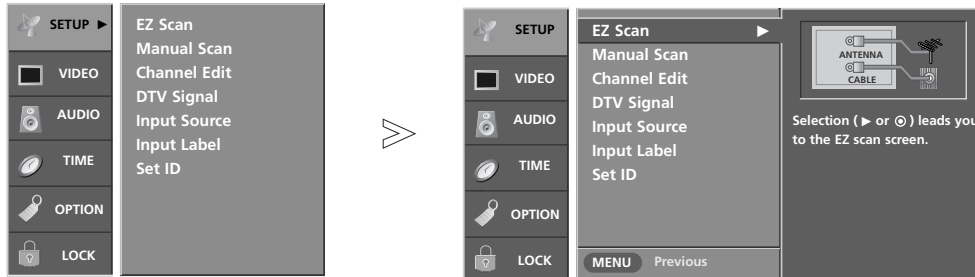

- Automatically finds all channels available through antenna or cable inputs, and stores them in memory on the channel list.
- Run EZ Scan again after any Antenna/Cable connection changes.
- A password is required to gain access to EZ Scan menu if the Lock System is turned on.

- 1 Press the **MENU** button and then use **▲ / ▼** button to select the **SETUP** menu.
- 2 Press the **▶** button and then use **▲ / ▼** button to select **EZ Scan**.
- 3 Press the **ENTER** button to begin the channel search. Allow EZ Scan to complete the channel search cycle for ANTENNA, and CABLE.

Manual Scan

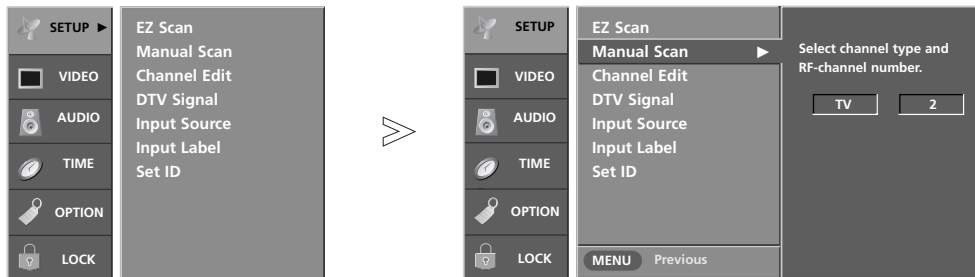

- A password is required to gain access to Manual Scan menu if the Lock System is turned on.

- 1 Press the **MENU** button and then use **▲ / ▼** button to select the **SETUP** menu.
- 2 Press the **▶** button and then use **▲ / ▼** button to select **Manual Scan**.
- 3 Press the **▶** button and then use **▲ / ▼** button to select TV, DTV, CATV, and CADTV.
- 4 Press the **▶** button and then use **▲ / ▼** button to select channel number you want to add or delete.
- 5 Press the **ENTER** button to add or delete for the channel number.
- 6 Press **EXIT** button to return to TV viewing or press **MENU** button to return to the previous menu.

Mini Glossary

TV	Analog antenna (over-the-air) TV signal	CATV	Analog cable TV signal
DTV	Digital antenna (over-the-air) TV signal	CADTV	Digital cable TV signal

Channel Edit

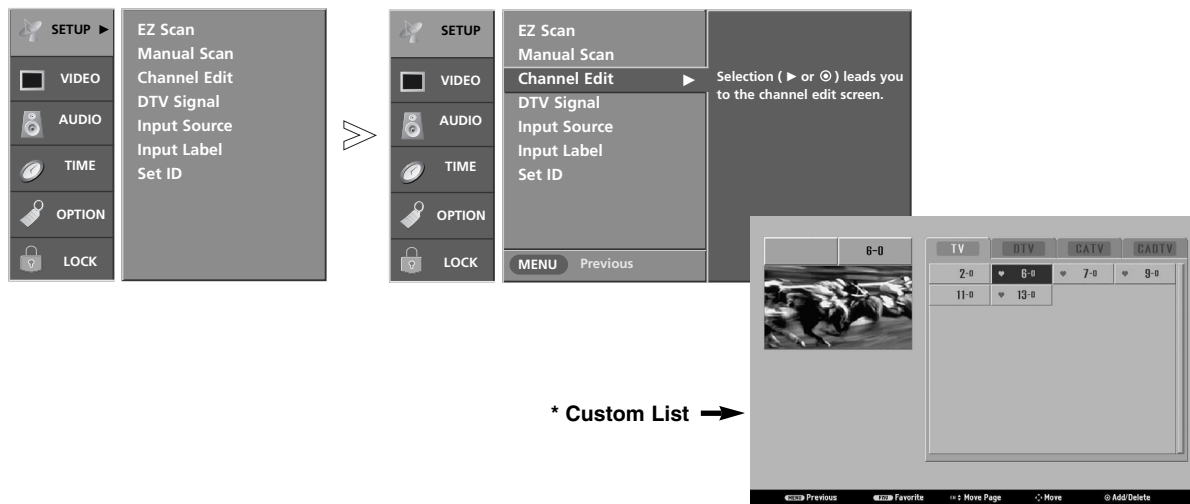

- There are two different ways in order to add or delete scanned channels. One is "Custom List" and the other is "Favorite List" in the channel list. Both of them are available after **EZ Scan** on the **SETUP** menu.

- A Custom List can be created by toggling each channel on or off with the **ENTER** button. The channels in the Custom List are displayed in black color, and the channels deleted from the Custom List are displayed in gray color. Once a channel is highlighted you can add or delete the channel by referring to the small window at the top-left corner of the screen. You can create your own Favorite List. Using the **FAV** button on the remote control when a channel is highlighted and then you can add or delete the channel to/from the Favorite List.

- 1** Press the **MENU** button and then use **▲/▼** button to select the **SETUP** menu.
- 2** Press the **▶** button and then use **▲/▼** button to select **Channel Edit**.
- 3** Press the **▶** button. You will now see a screen filled with channel numbers and a preview picture.
- 4** Use **▲/▼/◀/▶** button to select a channel and then use the **ENTER** button to add or delete it. Press **FAV** button to add the channel to the Favorite List. The heart-mark will appear in front of that channel number.
- 5** Press **EXIT** button to return to TV viewing or press **MENU** button to return to the previous menu.



Setup Menu Options continued

DTV Signal Strength

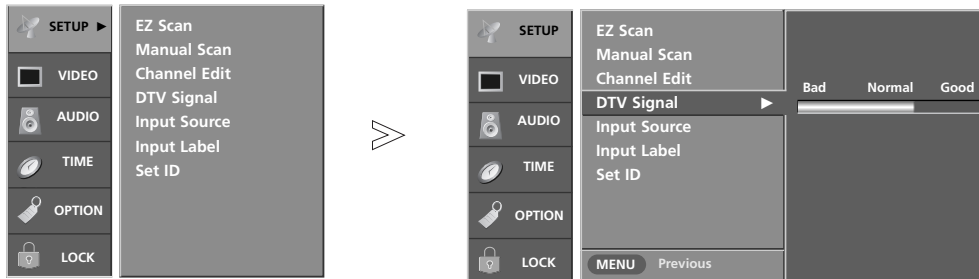

- Shows how strong your DTV signal is and whether you need to adjust your antenna or digital cable input. The higher the signal strength, the less likely you are to experience picture degradation.
- DTV Signals: Only when the input signal is DTV or CADTV, this function is available.

- 1 Press the **MENU** button and then use **▲ / ▼** button to select the **SETUP** menu.
- 2 Press the **▶** button and then use **▲ / ▼** button to select **DTV Signal**.
- 3 View the on-screen signal strength monitor to see the quality of the signal being received.
- 4 Press **EXIT** button to return to TV viewing or press **MENU** button to return to the previous menu.

Input Source

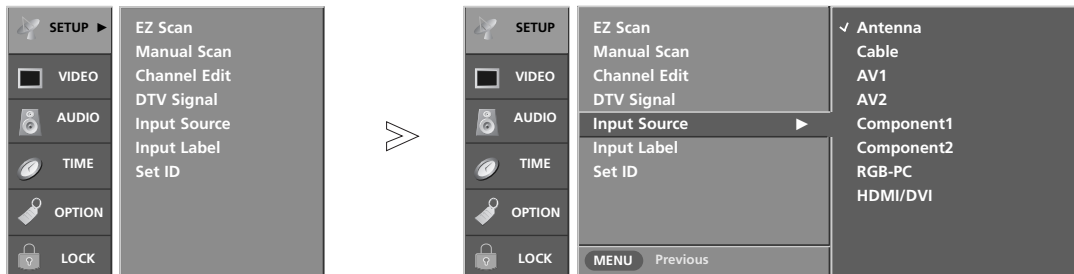

- Changes the picture source so you can watch your TV, cable TV, VCR, DVD, or any other devices that are connected to your TV.

- 1 Press the **MENU** button and then use **▲ / ▼** button to select the **SETUP** menu.
- 2 Press the **▶** button and then use **▲ / ▼** button to select **Input Source**.
- 3 Press the **▶** button and then use **▲ / ▼** button to select the source: Antenna, Cable, AV1, AV2, Component1, Component2, RGB-DTV (or RGB-PC), or HDMI/DVI.
 - To toggle RGB-DTV and RGB-PC, select RGB-DTV(or RGB-PC) and press **▶** button.
- 4 Press **EXIT** button to return to TV viewing or press **MENU** button to return to the previous menu.

Input Label

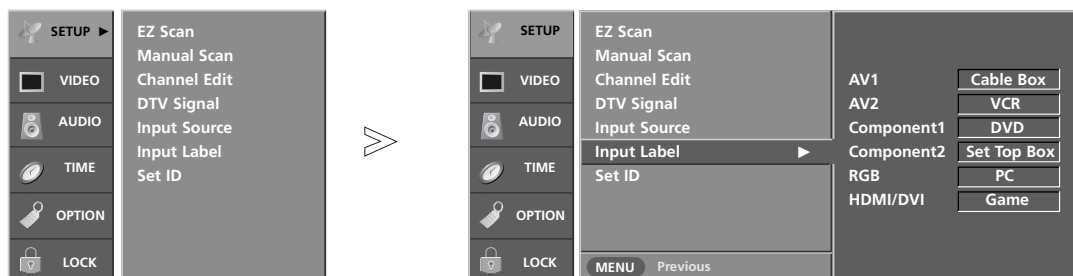

- Sets a label to each input source or lets you skip the input source which is not in use when you press **INPUT** button.

- 1** Press the **MENU** button and then use ▲ / ▼ button to select the **SETUP** menu.
- 2** Press the ► button and then use ▲ / ▼ button to select **Input Label**.
- 3** Press the ► button and then use ▲ / ▼ button to select the source: AV1-2, Component1-2, RGB or HDMI/DVI.
- 4** Press the ◀ / ▶ button to select the label.
- 5** Press **EXIT** button to return to TV viewing or press **MENU** button to return to the previous menu.

Video Menu Options

EZ Picture

- EZ Picture adjusts the TV for the best picture appearance. Select the preset value in the EZ Picture menu based on the program category.
- When adjusting Video menu options (contrast, brightness, color, sharpness, tint, and color temperature) manually, EZ Picture automatically changes to **Custom**.
- **Daylight, Normal, Night Time, Movie, Video Game, and Sports** settings are preset for optimum picture quality at the factory and are not adjustable.

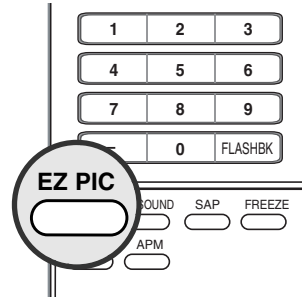

- 1 Press the **EZ PIC** button repeatedly to select the picture appearance setup option as shown below: **Custom** (your own settings), **Daylight, Normal, Night Time, Movie, Video Game, and Sports**.
 - You can also adjust **EZ Picture** in the **VIDEO** menu.
- 2 Press the **EXIT** button to save and return to TV viewing.

APM (Adaptive Picture Mode)

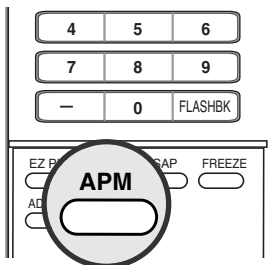

- It allows a viewer to select their preferred mode after comparing picture (Daylight, Normal, Night Time and Custom) settings.
- Note: While operating the 4-split, any button except **APM, ENTER, EXIT, ▲ / ▼ / ◀ / ▶, VOLUME ▲ / ▼, MUTE** button on the remote control are not available.

- 1 Press the **APM** button. The screen is divided to 4-split.
- 2 Press the **▲ / ▼ / ◀ / ▶** button to navigate 4 EZ Pictures. By pressing the **ENTER** button, you can select the desired mode.
Press the **EXIT** button to save and return to TV viewing.

Manual Picture Control (EZ Picture-Custom option)

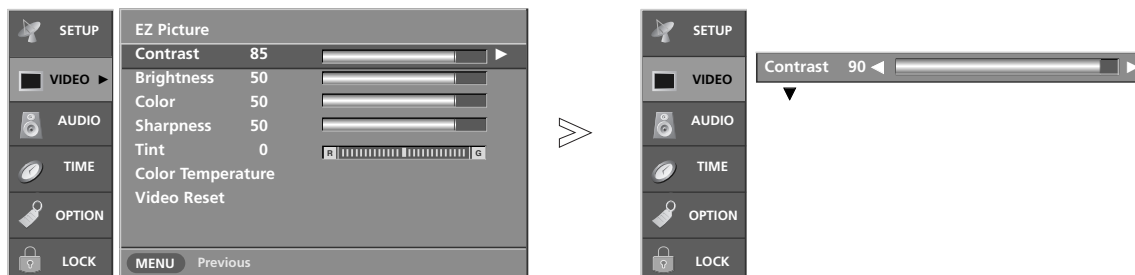

- Adjust the picture appearance to suit your preference and viewing situations.

- 1 Press the **MENU** button and then use **▲/▼** button to select the **VIDEO** menu.
- 2 Press the **▶** button and then use **▲/▼** button to select the desired picture option (**Contrast**, **Brightness**, **Color**, **Sharpness**, or **Tint**).
- 3 Press the **▶** button and then use **◀/▶** button to make appropriate adjustments.
- 4 Press **EXIT** button to return to TV viewing or press **MENU** button to return to the previous menu.

Color Temperature Control

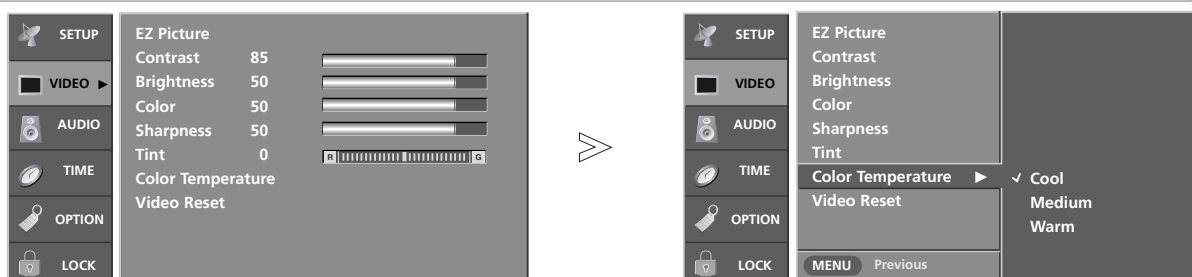

- Choose one of three automatic color adjustments. Set to warm to enhance hotter colors such as red, or set to cool to see less intense colors with more blue.

- 1 Press the **MENU** button and then use **▲/▼** button to select the **VIDEO** menu.
- 2 Press the **▶** button and then use **▲/▼** button to select **Color Temperature**.
- 3 Press the **▶** button and then use **▲/▼** button to select either **Cool**, **Medium**, or **Warm**.
- 4 Press **EXIT** button to return to TV viewing or press **MENU** button to return to the previous menu.

Video Reset

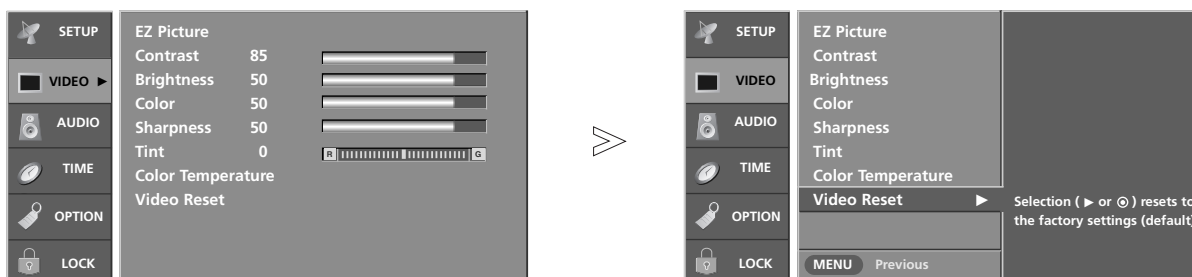

- Use to quickly reset all the Video menu options to their original factory preset values.

- 1 Press the **MENU** button and then use **▲/▼** button to select the **VIDEO** menu.
- 2 Press the **▶** button and then use **▲/▼** button to select **Video Reset**.
- 3 Press the **▶** button to reset the Video menu options to original values.



Audio Menu Options

Audio Language

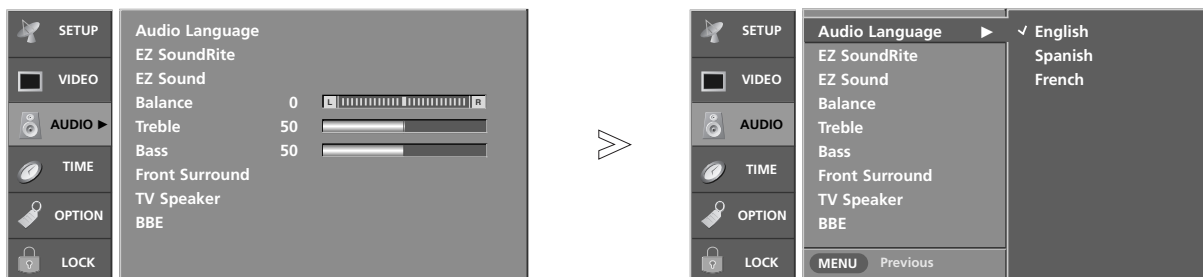

- Other languages may be available if a digital signal is provided by the broadcasting station.

- 1 Press the **MENU** button and then use **▲ / ▼** button to select the **AUDIO** menu.
- 2 Press the **▶** button and then use **▲ / ▼** button to select **Audio Language**.
- 3 Press the **▶** button and then use **▲ / ▼** button to select: English, Spanish, or French.
- 4 Press **EXIT** button to return to TV viewing or press **MENU** button to return to the previous menu.

EZ SoundRite

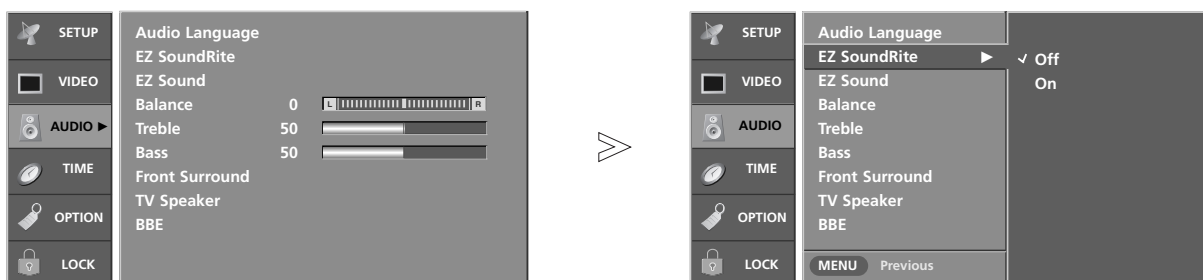

- Scans for changes in sound level during commercials, then adjusts the sound to match the specified audio level. EZ SoundRite makes sure that the volume level remains consistent whether you are watching a commercial or a regular TV program.

- 1 Press the **MENU** button and then use **▲ / ▼** button to select the **AUDIO** menu.
- 2 Press the **▶** button and then use **▲ / ▼** button to select **EZ SoundRite**.
- 3 Press the **▶** button and then use **▲ / ▼** button to select **Off** or **On**.
- 4 Press **EXIT** button to return to TV viewing or press **MENU** button to return to the previous menu.

EZ Sound

- EZ Sound lets you enjoy the best sound without any special adjustment because the TV sets the appropriate sound options based on the program content.
- When adjusting sound options (treble, bass, and front surround) manually, EZ Sound automatically switches **Custom**.
- **Normal, Stadium, News, Music, and Theater** are preset for good sound quality at the factory and are not adjustable.

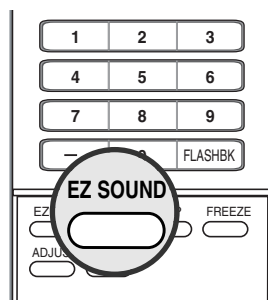

- 1** Press the **EZ SOUND** button repeatedly to select the appropriate sound setup as shown below: **Custom** (your own settings), **Normal, Stadium, News, Music, and Theater**.
 - You can also adjust **EZ Sound** in the **AUDIO** menu.
- 2** Press **EXIT** button to save and return to TV viewing.

Manual Sound Control (EZ Sound-Custom option)

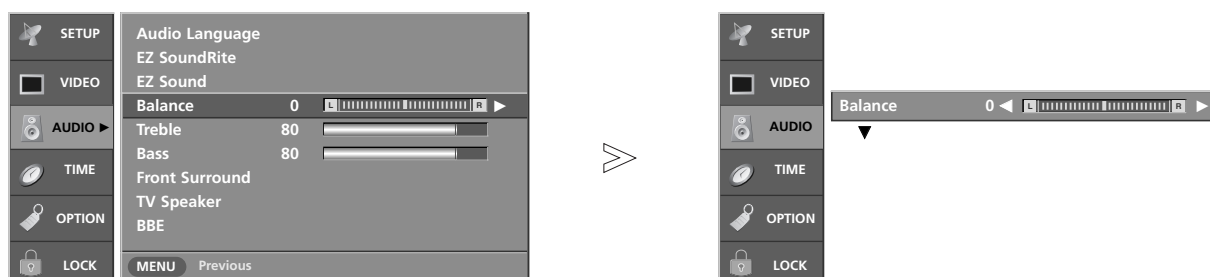

- Adjust the sound in your preference and surrounded environment.

- 1** Press the **MENU** button and then use **▲ / ▼** button to select the **AUDIO** menu.
- 2** Press the **▶** button and then use **▲ / ▼** button to select the desired sound option (**Balance, Treble, or Bass**).
- 3** Press the **▶** button and then use **◀ / ▶** button to make appropriate adjustments.
- 4** Press **EXIT** button to return to TV viewing or press **MENU** button to return to the previous menu.



Audio Menu Options continued

Stereo/SAP Broadcasts Setup

- This TV can receive MTS stereo programs and any SAP (Secondary Audio Program) that accompanies the stereo program; if the station transmits an additional sound signal as well as the original one.
- When having selected Stereo or SAP button on the remote control, this TV can only receive the signal when that the TV station transmits the proper signals.
- Mono sound is automatically received if the broadcast is only in Mono; even though Stereo or SAP has been selected.
- Select Mono if you want to listen to the mono sound in remote fringe areas during stereo/SAP broadcasting.
- Stereo or SAP can be received in Analog channel.

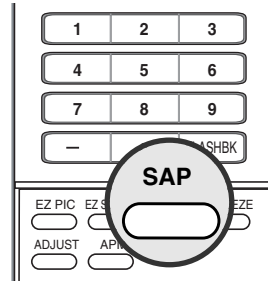

- 1 Use the **SAP** button to select your desired MTS mode in analog signal. Each time you press the **SAP** button, **Mono**, **Stereo**, or **SAP** appear in turn.
 - If other languages available on the digital signal, select them with the **SAP** button.
- 2 Press **EXIT** button to save and return to TV viewing.

Front Surround

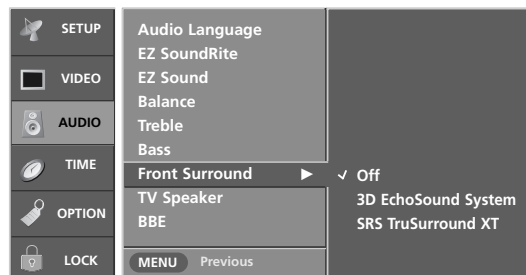
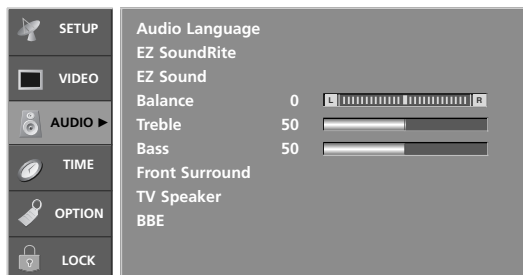

- is a trademark of SRS Labs, Inc.
- TruSurround XT technology is incorporated under license from SRS Labs, Inc.
- Manufactured under license from Dolby Laboratories. "Dolby" and the double-D symbol are trademarks of Dolby Laboratories.

- 1 Press the **MENU** button and then use **▲** / **▼** button to select the **AUDIO** menu.
- 2 Press the **▶** button and then use **▲** / **▼** button to select **Front Surround**.
- 3 Press the **▶** button and then use **▲** / **▼** button to select **Off**, **3D EchoSound System** or **SRS (Sound Retrieval System) TruSurround XT**.
- 4 Press **EXIT** button to return to TV viewing or press **MENU** button to return to the previous menu.

Mini Glossary

SRS TruSurround XT

Takes advantage of any multi-channel format without needing to add extra speakers or equipment. Dialog clarity, bass enrichment, and the addition of stereo audio enhancement that produces an immersive sound experience from standard stereo material.

3D EchoSound System

Creates a stunning simulated stereo effects from any mono sound and a realistic three-dimensional sound with a very wide and deep sound stage from stereo sound.

TV Speakers On/Off Setup

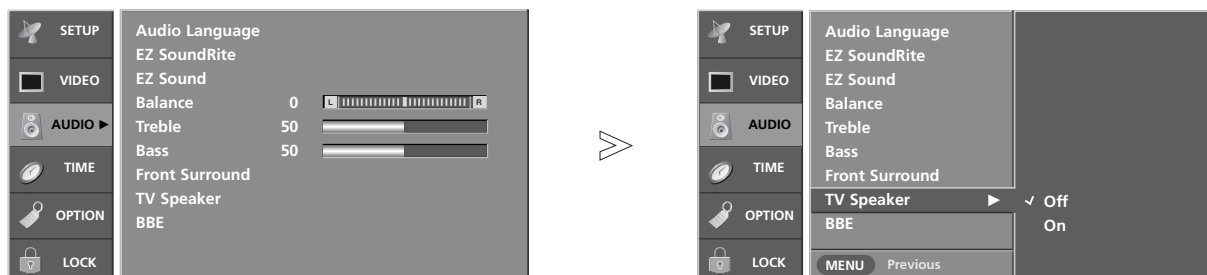

- Turn TV speakers off if using external audio equipment. Feature turns the TV Speakers option On or Off.

- 1 Press the **MENU** button and then use ▲ / ▼ button to select the **AUDIO** menu.
- 2 Press the ► button and then use ▲ / ▼ button to select **TV Speaker**.
- 3 Press the ► button and then use ▲ / ▼ button to select **Off** or **On**.
- 4 Press **EXIT** button to return to TV viewing or press **MENU** button to return to the previous menu.

BBE

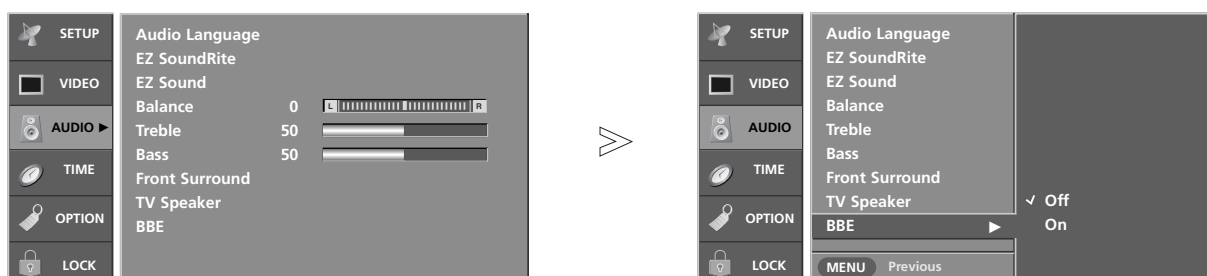

- *BBE High Definition Sound restores clarity and presence for better speech intelligibility and music realism.*

- 1 Press the **MENU** button and then use ▲ / ▼ button to select the **AUDIO** menu.
- 2 Press the ► button and then use ▲ / ▼ button to select **BBE**.
- 3 Press the ► button and then use ▲ / ▼ button to select **Off** or **On**.
- 4 Press **EXIT** button to return to TV viewing or press **MENU** button to return to the previous menu.

• **BBE**®. Manufactured under license from BBE Sound, Inc.

Time Menu Options

Auto Clock Setup

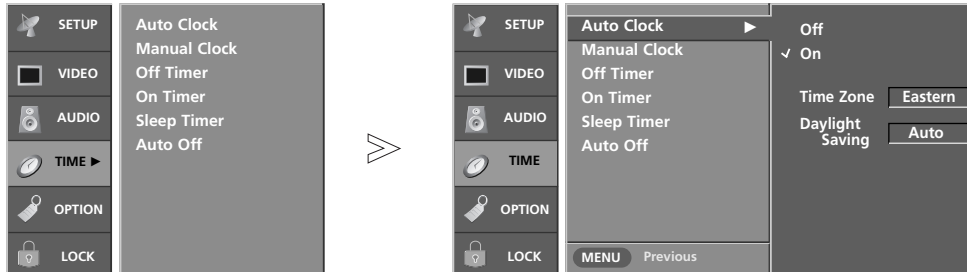

- The time is set automatically from a digital channel signal.
- The current time will be set automatically from a digital channel signal provided by the broadcasting station.
- Set the clock manually, if the current time is set incorrectly by the auto clock function.

- 1 Press the **MENU** button and then use **▲ / ▼** button to select the **TIME** menu.
- 2 Press the **▶** button and then use **▲ / ▼** button to select **Auto Clock**.
- 3 Press the **▶** button and then use **▲ / ▼** button to select **On**.
- 4 Press the **▶** button and then use **▲ / ▼** button to select your viewing area time zone.
 - U.S.A: **Eastern, Central, Mountain, Pacific, Alaska, or Hawaii.**
 - Canada: **Eastern, Central, Mountain, Pacific, Nfld, or Atlantic.**
- 5 Press the **▶** button and then use **▲ / ▼** button to select **Auto, Off, On**, depending on whether or not your viewing area observes Daylight Saving time.
- 6 Press **EXIT** button to return to TV viewing or press **MENU** button to return to the previous menu.

Manual Clock Setup



- If current time setting is wrong, reset the clock manually.

- 1 Press the **MENU** button and then use **▲ / ▼** button to select the **TIME** menu.
- 2 Press the **▶** button and then use **▲ / ▼** button to select **Manual Clock**.
- 3 Press the **▶** button and then use **◀ / ▶** button to select either the year, date, or time option. Once selected, use the **▲ / ▼** button to set the year, date, and time options.
- 4 Press **EXIT** button to return to TV viewing or press **MENU** button to return to the previous menu.

On/Off Timer Setup

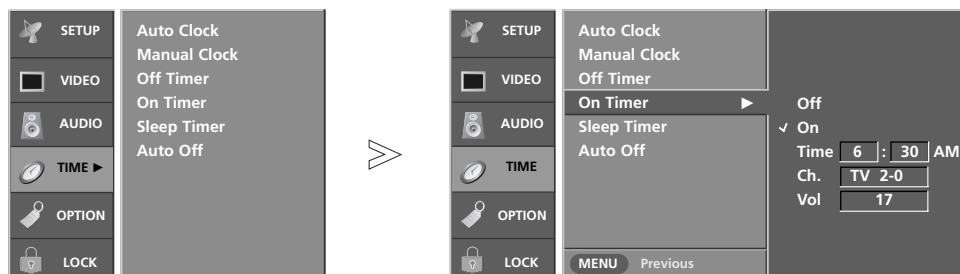

- Timer function operates only if current time has been set.
- Off-Timer function overrides On-Timer function if they are set both set to the same time.
- The TV must be in standby mode for the On-Timer to work.
- If you do not press any button within 2 hours after the TV turns on with the On Timer function, the TV will automatically revert to standby mode.

- 1 Press the **MENU** button and then use **▲ / ▼** button to select the **TIME** menu.
- 2 Press the **▶** button and then use **▲ / ▼** button to select **Off Timer** or **On Timer**.
- 3 Press the **▶** button and then use **▲ / ▼** button to select **On**.
 - To cancel **On/Off Timer** function, select **Off**.
- 4 Press the **▶** button and then use **▲ / ▼** button to set the hour.
- 5 Press the **▶** button and then use **▲ / ▼** button to set the minutes.
- 6 **For only On Timer function**
 Press the **▶** button and then use **▲ / ▼** button to select the channel at turn-on.
 Press the **▶** button and then use **▲ / ▼** button to set the sound level at turn-on.
- 7 Press **EXIT** button to return to TV viewing or press **MENU** button to return to the previous menu.

Sleep Timer

- The Sleep Timer turns the TV off at the preset time. Note that this setting is cleared when the TV is turned off.
- You can also set up the **Sleep Timer** in the **TIME** menu.

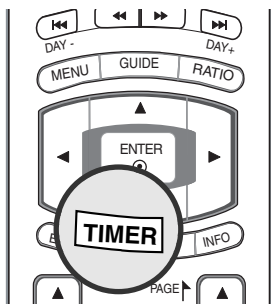

- 1 Press the **TIMER** button repeatedly to select the number of minutes. First the **Off** option appears on the screen, followed by the following sleep timer options: 10, 20, 30, 60, 90, 120, 180, and 240 minutes.
- 2 When the number of minutes you want is displayed on the screen, press the **TIMER** button. The timer begins to count down from the number of minutes selected.
- 3 To check the remaining minutes before the TV turns off, press the **TIMER** button once.
- 4 To cancel the Sleep Timer, press the **TIMER** button repeatedly to select **Off**.

Time Menu Options continued

Auto Off

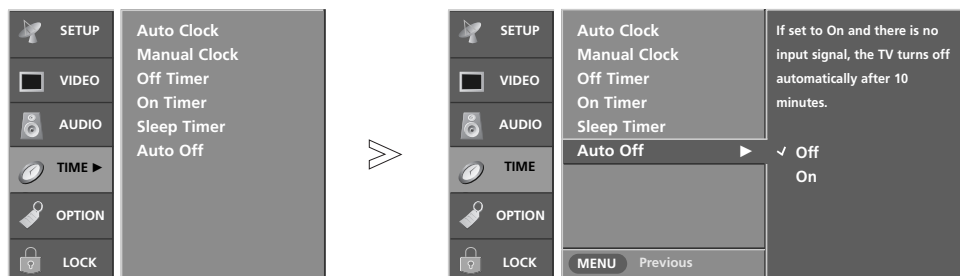

- If the TV is on and there is no input signal, the TV turns off automatically after 10 minutes.

- 1** Press the **MENU** button and then use **▲ / ▼** button to select the **TIME** menu.
- 2** Press the **▶** button and then use **▲ / ▼** button to select **Auto Off**.
- 3** Press the **▶** button and then use **▲ / ▼** button to select **Off** or **On**.
- 4** Press **EXIT** button to return to TV viewing or press **MENU** button to return to the previous menu.

Option Menu Features

Aspect Ratio Control

- Lets you choose the way an analog picture with a 4:3 aspect ratio is displayed on your TV with a 16:9 ratio picture format. When you receive an analog picture with a 4:3 aspect ratio on your 16:9 TV, you need to specify how the picture is to be displayed.
- If you are viewing a picture with a 16:9 aspect ratio, you can't use the Horizon aspect ratio option.
- Horizon aspect ratio is not available for Component 1-2 (720p/1080i) / RGB-DTV (720p/1080i)/HDMI/DVI-DTV (720p/1080i)/DTV(720p/1080i) input source.
- In RGB-PC/DVI-PC input source, only either 4:3 or 16:9 aspect ratio is available.
- If a fixed image is displayed on the screen for a long time, the image may become imprinted on the screen and remain visible.

- 1 Press the **RATIO** button repeatedly to select the desired picture format.
 - You can also adjust **Aspect Ratio** in the **OPTION** menu.

- **Set By Program**

Selects the proper picture proportion to match the source's image. (4:3 → 4:3, 16:9 → 16:9)

- **4:3**

Choose **4:3** when you want to view a picture with an original 4:3 aspect ratio, with gray bars appearing at both the left and right sides.

- **16:9**

Choose **16:9** when you want to adjust the picture horizontally, in a linear proportion to fill the entire screen.

- **Horizon**

Choose **Horizon** when you want to adjust the picture in a non-linear proportion, that is, more enlarged at both sides, to create a panorama view.

- **Zoom 1**

Choose **Zoom 1** when you want to view the picture without any alteration. However, the top and bottom portions of the picture will be cropped.

- **Zoom 2**

Choose **Zoom 2** when you want the picture to be altered, both horizontally extended and vertically cropped. The picture taking a halfway trade off between alteration and screen coverage.

- **Cinema Zoom**

Choose **Cinema Zoom** when you want to enlarge the picture in correct proportion. Note: When enlarging or reducing the picture, the image may become distorted.

You can adjust the enlarge proportion of Cinema Zoom using **▲ / ▼** button. The adjustment range is 1~16.

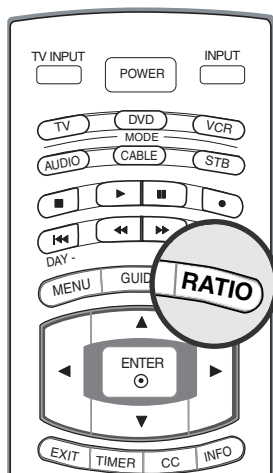



Option Menu Features continued

Cinema 3:2 Mode Setup

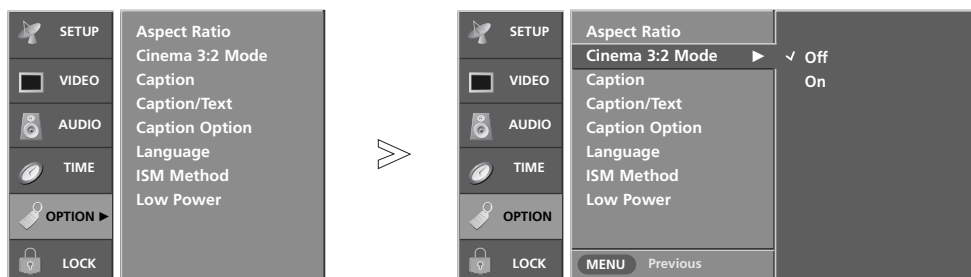

- Most movies are 24 frames/sec, but TV signal is 30 frames/sec.
- This option lets the TV do 3:2 pull-down operation for you to watch movies at the best motion appearance.
- This feature operates only in AV1, AV2, Component 480i mode.

- 1** Press the **MENU** button and then use ▲ / ▼ button to select the **OPTION** menu.
- 2** Press the ► button and then use ▲ / ▼ button to select **Cinema 3:2 Mode**.
- 3** Press the ► button and then use ▲ / ▼ button to select **Off** or **On**.
- 4** Press **EXIT** button to return to TV viewing or press **MENU** button to return to the previous menu.

Caption

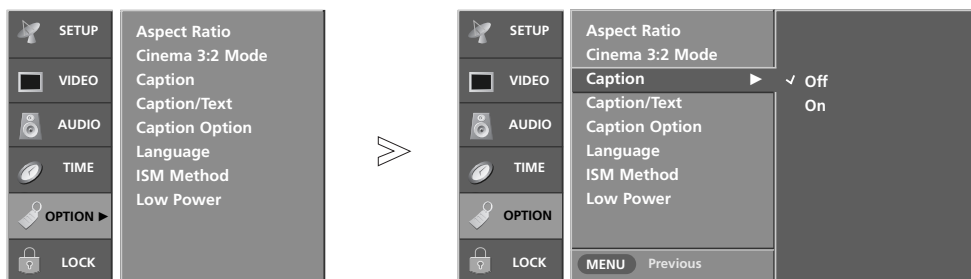

- 1** Press the **MENU** button and then use ▲ / ▼ button to select the **OPTION** menu.
- 2** Press the ► button and then use ▲ / ▼ button to select **Caption**.
- 3** Press the ► button and then use ▲ / ▼ button to select **Off** or **On**.
- 4** Press **EXIT** button to return to TV viewing or press **MENU** button to return to the previous menu.

Caption/Text

* Analog Broadcasting System Captions

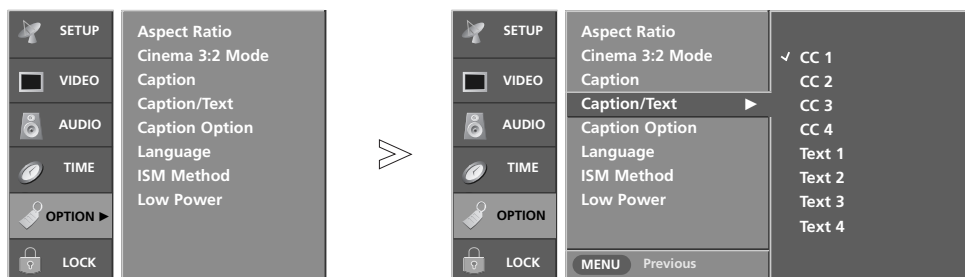

- Select a caption mode for displaying captioning information if provided on a program.
- Analog caption displays information at any position on the screen.
- Text displays information, usually at the bottom position and is used for a data service.
- Caption/Text, if provided by the broadcaster, would be available for both digital and analog channels on the Antenna/Cable.
- This TV is programmed to remember the caption/text mode it was last set to, when you turn the power off.

- 1** Use the **CC** button repeatedly to select Caption **Off**, **CC1**, **CC2**, **CC3**, **CC4**, **Text1**, **Text2**, **Text3**, or **Text4**.
- 2** Press **EXIT** button to save and return to TV viewing.

-
- 1** Press the **MENU** button and then use **▲ / ▼** button to select the **OPTION** menu.
 - 2** Press the **▶** button and then use **▲ / ▼** button to select **Caption/Text**.
 - 3** Press the **▶** button and then use **▲ / ▼** button to select caption: **CC1**, **CC2**, **CC3**, **CC4**, **Text1**, **Text2**, **Text3**, or **Text4**.
 - **CAPTION**
The term for the words that scroll across the bottom of the TV screen; usually the audio portion of the program provided for the hearing impaired.
 - **TEXT**
The term for the words that appear in a large black frame and almost cover the entire screen; usually messages provided by the broadcaster.
 - 4** Press **EXIT** button to return to TV viewing or press **MENU** button to return to the previous menu.

* Digital Broadcasting System Captions

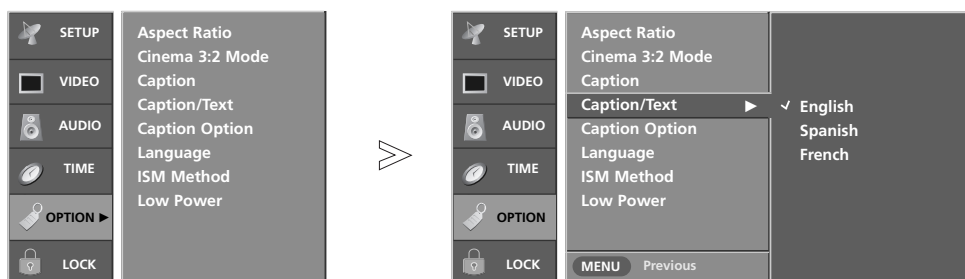

- Choose the language you want the DTV/CADTV Captions to appear in.
- Other languages can be chosen for digital sources only if they are included on the program.

- 1** Press the **MENU** button and then use **▲ / ▼** button to select the **OPTION** menu.
- 2** Press the **▶** button and then use **▲ / ▼** button to select **Caption/Text**.
- 3** Press the **▶** button and then use **▲ / ▼** button to select available caption languages: **English**, **Spanish**, or **French**.
- 4** Press **EXIT** button to return to TV viewing or press **MENU** button to return to the previous menu.



Option Menu Features continued

Caption Option

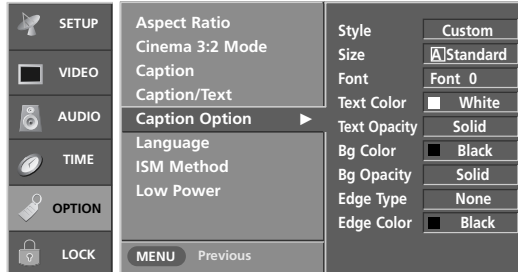
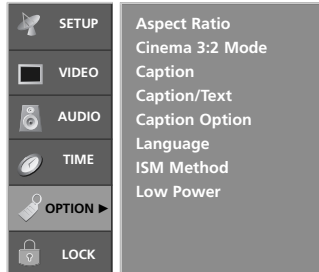

- Customize the DTV/CADTV captions that appear on your screen.

- 1 Press the **MENU** button and then use **▲ / ▼** button to select the **OPTION** menu.
- 2 Press the **▶** button and then use **▲ / ▼** button to select **Caption Option**.
- 3 Press the **▶** button and then use **◀ / ▶** button to select **Custom**.
- 4 Use **▲ / ▼** button to customize the Style, Font, etc., to your preference. A preview icon is provided at the bottom of the screen, use it to see the caption language.
 - **Size**: Set the size the words will appear in.
 - **Font**: Select a typeface for the words.
 - **Text Color**: Choose a color for the text.
 - **Text Opacity**: Specify the opacity for the text color.
 - **Bg (Background) Color**: Select a background color.
 - **Bg (Background) Opacity**: Select the opacity for the background color.
 - **Edge Type**: Select an edge type.
 - **Edge Color**: Select a color for the edges.
- 5 Press **EXIT** button to return to TV viewing or press **MENU** button to return to the previous menu.

Low Power (42PC1D**, 42PC3D**, 50PC3D** only)

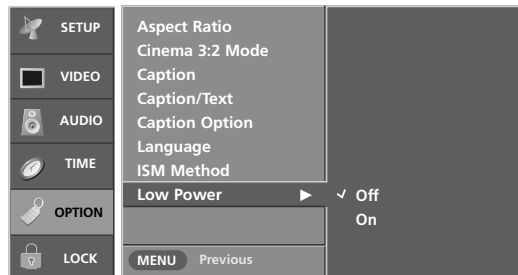
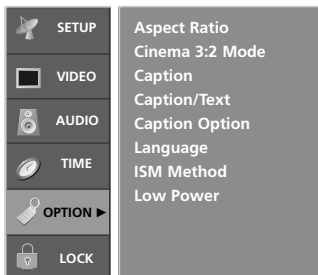

- Low power reduces the power consumption of plasma display.

- 1 Press the **MENU** button and then use **▲ / ▼** button to select the **OPTION** menu.
- 2 Press the **▶** button and then use **▲ / ▼** button to select **Low Power**.
- 3 Press the **▶** button and then use **▲ / ▼** button **On** or **Off**.
- 4 Press **EXIT** button to return to TV viewing or press **MENU** button to return to the previous menu.

ISM (Image Sticking Minimization) Method (42PC1D**, 42PC3D**, 50PC3D** only)

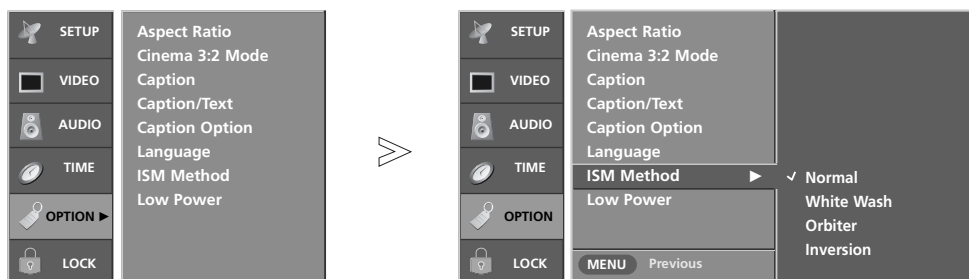

- A frozen still picture from a PC/video game displayed on the screen for prolonged periods will result in a ghost image ; even though the image is changed. Use our unique method to minimize any fixed image on the screen.

- 1** Press the **MENU** button and then use ▲ / ▼ button to select the **OPTION** menu.
- 2** Press the ► button and then use ▲ / ▼ button to select **ISM Method**.
- 3** Press the ► button and then use ▲ / ▼ button to select **Normal**, **White Wash**, **Orbiter** or **Inversion**.
 - **Normal**
If image sticking is never a problem, ISM is not necessary - set to Normal.
 - **White Wash**
White Wash removes permanent images from the screen.
Note: An excessive permanent image may be impossible to clear entirely with White Wash. To return to normal viewing, press the any button.
 - **Orbiter**
Orbiter may help prevent ghost images. However, it is best not to allow any fixed image to remain on the screen. To avoid a permanent image on the screen, the image will move once per 2 minutes: Left → Right → Upside → Downside → Right → Left → Downside → Upside.
 - **Inversion**
Inversion will automatically invert the plasma display panel color every 30 minutes.
- 4** Press **EXIT** button to return to TV viewing or press **MENU** button to return to the previous menu.

Lock Menu Options

Parental Control can be used to block specific channels, ratings and other viewing sources.

The Parental Control Function (V-Chip) is used to block program viewing based on the ratings sent by the broadcasting station. The default setting is to allow all programs to be viewed. Viewing can be blocked by the type of program and by the categories chosen to be blocked. It is also possible to block all program viewing for a time period. To use this function, the following must be done :

1. Set ratings and categories to be blocked.
2. Specify a password
3. Enable the lock

V-Chip rating and categories

Rating guidelines are provided by broadcasting stations. Most television programs and television movies can be blocked by TV Rating and/or Individual Categories. Movies that have been shown at the theaters or direct-to-video movies use the Movie Rating System (MPAA) only.

For USA

Ratings for Movies previously shown in theaters:

Movie Ratings :

- Blocking Off (Permits all programs)
- G (General audience)
- PG (Parental guidance suggested)
- PG-13 (Parents strongly cautioned)
- R (Restricted)
- NC-17 (No one 17 and under admitted)
- X (Adult only)

If you set PG-13 : G and PG movies will be available, PG-13, R, NC-17 and X will be blocked.

Ratings for Television programs including made-for-TV movies :

- TV-G (General audience)
- TV-PG (Parental guidance suggested)
- TV-14 (Parents strongly cautioned)
- TV-MA (Mature audience only)
- TV-Y (All children)
- TV-Y7 (Children 7 years older)

TV Rating-Children:

- Age (applies to TV-Y, TV-Y7)
- Fantasy Violence (applies to TV-Y7)

TV Rating-General:

- Age (applies to TV-G, TV-PG, TV-14, TV-MA)
- Dialogue- sexual dialogue (applies to TV-PG, TV-14)
- Language- adult language (applies to TV-PG, TV-14, TV-MA)
- Sex- sexual situations (applies to TV-PG, TV-14, TV-MA)
- Violence (applies to TV-PG, TV-14, TV-MA)

Input Block

- AV1, 2 (On, Off)
- Component 1, 2 (On, Off)
- RGB, HDMI/DVI (On, Off)

For Canada

TV Rating-English:

- E (Exempt)
- C (Children)
- C8+ (8 years and up)
- G (General programming. Suitable for all audiences)
- PG (Parental guidance suggested)
- 14+ (Viewers 14 years and up)
- 18+ (Adult programming)
- Blocking off (Permits all programming)

TV Rating-French:

- E (Exempt)
- G (General)
- 8 ans+ (8 years and up)
- 13 ans+ (13 years and up)
- 16 ans+ (16 years and up)
- 18 ans+ (Adults only)
- Blocking off (Permits all programming)

Input Block

- AV 1, 2 (On, Off)
- Component 1, 2 (On, Off)
- RGB and HDMI/DVI (On, Off)

Parental Lock Setup

* For U.S.A.

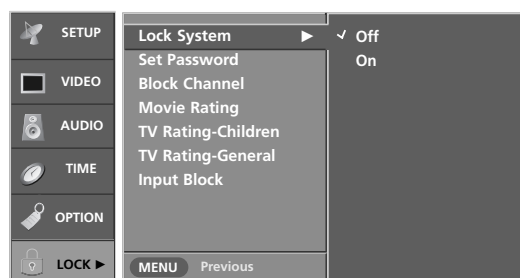
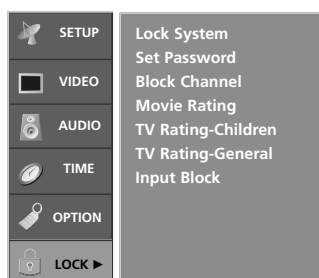

* For Canada

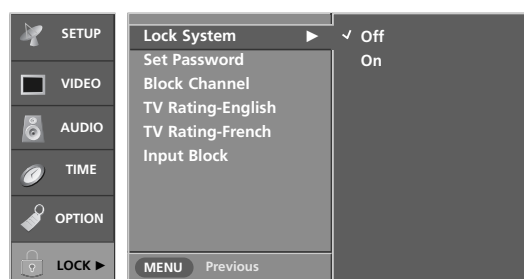
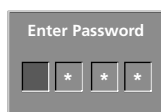
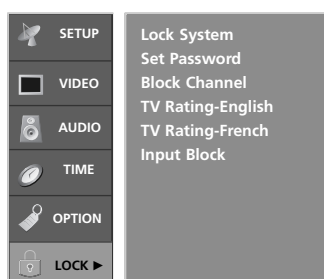

- Set up blocking schemes to block specific channels, ratings, and external viewing sources.
- A password is required to gain access to this menu if the Lock System is turned on.

- 1 Press the **MENU** button and then use **▲ / ▼** button to select the **LOCK** menu. Then, press the **►** button
 - If **Lock** is already set, enter the password as requested.
 - The TV is set up with the initial password "0-0-0-0".
- 2 Use the **▲ / ▼** button to choose from the following Lock Menu options. Once the option is selected, change the settings to your preference.
 - **Lock System:** Activates or disables the blocking scheme you set up previously.
 - **Set Password:** Change the password by inputting a new password twice.
 - **Block Channel.:** Select a channel number that you wish to block.
 - **Input block:** Enables you to select a source to block from the external source devices you have hooked up.

◆ For USA

- **Movie Rating (MPPA):** Blocks movies according to the movie ratings limits specified, so children cannot view certain movies. You can set the ratings limit by blocking out all the movies with the ratings above a specified level. Keep in mind that the movie ratings limit only applies to movies shown on TV, not TV programs, such as soap operas.
- **TV Rating-Children:** Prevents children from watching certain children's TV programs, according to the ratings limit set. The children rating does not apply to other TV programs. Unless you block certain TV programs intended for mature audiences in the TV Rating - sub menu, your children can view those programs.
- **TV Rating-General:** Based on the ratings, blocks certain TV programs that you and your family do not want to view.

◆ For Canada

- **TV Rating-English / TV Rating-French:** Selecting canadian English /French language rating system.

- 3 Press **EXIT** button to return to TV viewing or press **MENU** button to return to the previous menu.



- If you ever forget your password, key in '7', '7', '7', '7' on the remote control. Then, the password reset to '7', '7', '7', '7'.

External Control Device Setup

- Connect the RS-232C input jack to an external control device (such as a computer or an A/V control system) and control the Monitor's functions externally.
- Connect the serial port of the control device to the RS-232C jack on the TV back panel.
- RS-232C connection cables are not supplied with the TV.

RS-232C Setup

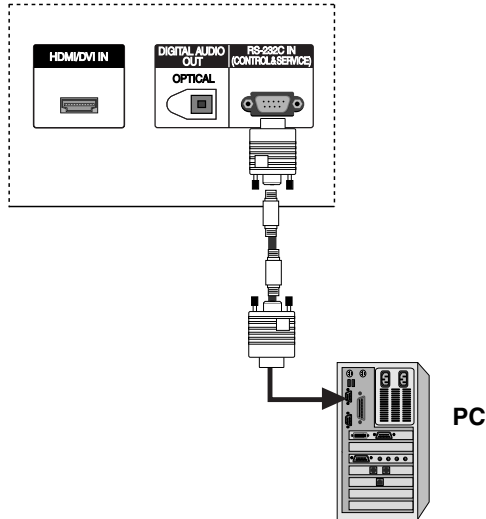

Type of Connector; D-Sub 9-Pin Male

No.	Pin Name
1	No connection
2	RXD (Receive data)
3	TXD (Transmit data)
4	DTR (DTE side ready)
5	GND
6	DSR (DCE side ready)
7	RTS (Ready to send)
8	CTS (Clear to send)
9	No Connection

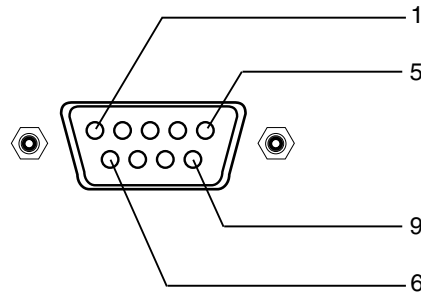

RS-232C Configurations

7-Wire Configurations (Serial female-female NULL modem cable)

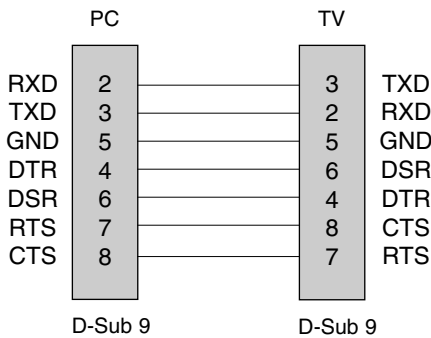

3-Wire Configurations (Not standard)

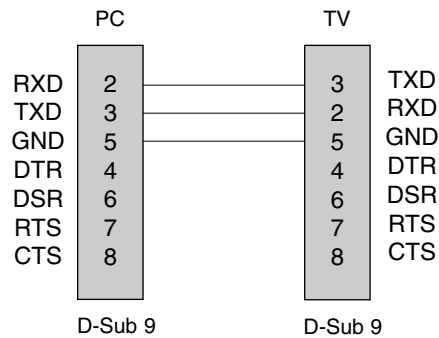

Set ID

- Use this function to specify a TV ID number.
- Refer to 'Real Data Mapping'. See page 56.

1. Press the **MENU** button and then use **▲** / **▼** button to select the **SETUP** menu.
2. Press the **▶** button and then use **▲** / **▼** button to select **Set ID**.
3. Press the **▶** button and then use **▲** / **▼** button to adjust **Set ID** to choose the desired TV ID number. The adjustment range of **Set ID** is 1 ~ 99.
4. Press **EXIT** button to return to TV viewing or press **MENU** button to return to the previous menu.

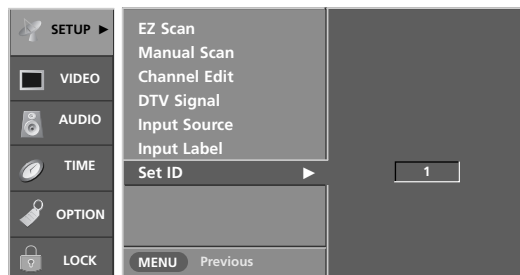

Communication Parameters

- Baud rate : 9600 bps (UART)
- Data length : 8 bits
- Parity : None
- Stop bit : 1 bit
- Communication code : ASCII code

* Use a crossed (reverse) cable.

Command Reference List

	COMMAND 1	COMMAND 2	DATA (Hexadecimal)
01. Power	k	a	0 ~ 1
02. Input Select	k	b	* (Refer to p.56)
03. Aspect Ratio	k	c	* (Refer to p.56)
04. Screen Mute	k	d	0 ~ 1
05. Volume Mute	k	e	0 ~ 1
06. Volume Control	k	f	0 ~ 64
07. Contrast	k	g	0 ~ 64
08. Brightness	k	h	0 ~ 64
09. Color	k	i	0 ~ 64
10. Tint	k	j	0 ~ 64
11. Sharpness	k	k	0 ~ 64
12. OSD Select	k	l	0 ~ 1
13. Remote Control Lock Mode	k	m	0 ~ 1
14. Treble	k	r	0 ~ 64
15. Bass	k	s	0 ~ 64
16. Balance	k	t	0 ~ 64
17. Color Temperature	k	u	0 ~ 2
18. ISM Method	j	p	* (Refer to p.58)
19. Low Power	j	q	0 ~ 1
20. Orbiter Time Setting	j	r	1 ~ FE
21. Orbiter Pixel Setting	j	s	1 ~3

* Command 18~21: 42PC1D**, 42PC3D**, 50PC3D** models only

	COM-MAND 1	COM-MAND 2	DATA 0 (Hexadecimal)	DATA 1 (Hexadecimal)	DATA 2 (Hexadecimal)	DATA 3 (Hexadecimal)	DATA 4 (Hexadecimal)	DATA 5 (Hexadecimal)
22. Channel Tuning	m	a	physical/program high	major/program low	major low	minor high	minor low	attribute
23. Channel Add/Del	m	b	00 ~ 01					
24. Key	m	c	key code					
25. Input Select	x	b	* (Refer to p.59)					

Transmission / Receiving Protocol

Transmission

[Command1][Command2][][Set ID][][Data][Cr]

- * [Command 1]: First command to control the set.(j,k,m or x)
- * [Command 2]: Second command to control the set.
- * [Set ID]: You can adjust the set ID to choose desired monitor ID number in Setup menu. Adjustment range is 1 ~ 99. When selecting Set ID '0', every connected the TV is controlled. Set ID is indicated as decimal (1~99) on menu and as Hexa decimal (0x0~0x63) on transmission/receiving protocol.
- * [DATA]: To transmit command data.
Transmit 'FF' data to read status of command.
- * [Cr]: Carriage Return
ASCII code '0x0D'
- * []: ASCII code 'space (0x20)'

OK Acknowledgement

[Command2][][Set ID][][OK][Data][x]

- * The Monitor transmits ACK (acknowledgement) based on this format when receiving normal data. At this time, if the data is data read mode, it indicates present status data. If the data is data write mode, it returns the data of the PC computer.

Error Acknowledgement

[Command2][][Set ID][][NG][Data][x]

- * The Monitor transmits ACK (acknowledgement) based on this format when receiving abnormal data from non-viable functions or communication errors.

Data 1: Illegal Code
2: Not supported function
3: Wait more time

09. Color (Command2:i)

- ▶ To adjust the screen color.
You can also adjust color in the Video menu.

Transmission

[k][i][][Set ID][][Data][Cr]

Data Min : 0 ~ Max : 64

- Refer to 'Real data mapping'. See page 56.

Acknowledgement

[i][][Set ID][][OK][Data][x]

10. Tint (Command2:j)

- ▶ To adjust the screen tint.
You can also adjust tint in the Video menu.

Transmission

[k][j][][Set ID][][Data][Cr]

Data Red : 0 ~ Green : 64

- Refer to 'Real data mapping'. See page 56.

Acknowledgement

[j][][Set ID][][OK][Data][x]

11. Sharpness (Command2:k)

- ▶ To adjust the screen sharpness.
You can also adjust sharpness in the Video menu.

Transmission

[k][k][][Set ID][][Data][Cr]

Data Min: 0 ~ Max: 64

- Refer to 'Real data mapping'. See page 56.

Acknowledgement

[k][][Set ID][][OK][Data][x]

12. OSD Select (Command2:l)

- ▶ To select OSD (On Screen Display) on/off.

Transmission

[k][l][][Set ID][][Data][Cr]

Data 0: OSD off 1: OSD on

Acknowledgement

[l][][Set ID][][OK][Data][x]

13. Remote Control Lock Mode (Command2:m)

- ▶ To lock the remote control and the front panel controls on the set.

Transmission

[k][m][][Set ID][][Data][Cr]

Data 0: Lock off 1: Lock on

Acknowledgement

[m][][Set ID][][OK][Data][x]

14. Treble (Command2:r)

- ▶ To adjust treble.
You can also adjust treble in the Audio menu.

Transmission

[k][r][][Set ID][][Data][Cr]

Data Min: 0 ~ Max: 64

- Refer to 'Real data mapping'. See page 56.

Acknowledgement

[r][][Set ID][][OK][Data][x]

15. Bass (Command2:s)

- ▶ To adjust bass.
You can also adjust bass in the Audio menu.

Transmission

[k][s][][Set ID][][Data][Cr]

Data Min: 0 ~ Max: 64

- Refer to 'Real data mapping'. See page 56.

Acknowledgement

[s][][Set ID][][OK][Data][x]

16. Balance (Command2:t)

- ▶ To adjust balance.
You can also adjust balance in the Audio menu.

Transmission

[k][t][][Set ID][][Data][Cr]

Data Min: 0 ~ Max: 64

- Refer to 'Real data mapping'. See page 56.

Acknowledgement

[t][][Set ID][][OK][Data][x]

17. Color Temperature (Command2:u)

- ▶ To adjust color temperature.
You can also adjust color temperature in the Video menu.

Transmission

[k][u][][Set ID][][Data][Cr]

Data 0: Medium 1: Cool 2: Warm

Acknowledgement

[u][][Set ID][][OK][Data][x]

These functions are available in 42PC1D**, 42PC3D**, 50PC3D** models only.

18. ISM Method (Command2:p)

► To avoid having a fixed image remain on screen.

Transmission

[j][p][][Set ID][][Data][Cr]

- Data 1: Inversion
- 2: Orbiter
- 4: White Wash
- 8: Normal

Acknowledgement

[p][][Set ID][][OK][Data][x]

19. Low Power (Command2:q)

► To control the Low Power function on/off. You can also adjust Low Power in Option menu.

Transmission

[j][q][][Set ID][][Data][Cr]

- Data 0: Low Power off
- 1: Low Power on

Acknowledgement

[q][][Set ID][][OK][Data][x]

20. Orbiter Time Setting (Command2:r)

► To adjust orbiter operation time term.

Transmission

[j][r][][Set ID][][Data][Cr]

Data Min: 1 ~ Max: FE

Acknowledgement

[r][][Set ID][][OK][Data][x]

21. Orbiter Pixel Setting (Command2:s)

► To adjust pixel number in orbiter function.

Transmission

[j][s][][Set ID][][Data][Cr]

Data Min: 1 ~ Max: 3

Acknowledgement

[s][][Set ID][][OK][Data][x]

22. Tune Command (Command: m a)

► To tune channel to following physical/major/minor number

Transmission

[m][a][][Set ID][][Data0][][Data1][][Data2][][Data3][][Data4][][Data5][Cr]

Data 0: Physical Channel Number(Transmit by Hexadecimal code)

- NTSC air:02~45
- NTSC cable: 01, 0E~7D
- ATSC air:01~45
- ATSC cable:01~87

Data 1,Data 2: Major Channel Number(two part) or Channel Number(One part)

- Data1: High byte
- Data2: Low byte

Two part channel number: Major number-Minor number
One part channel number: If the channel band is ATSC digital cable, it can be used. In case of using one part channel number, minor channel does not need.

Data 3, Data 4: Minor Channel Number Data3: High byte Data4: Low byte

Data 5:

7	Main Picture	6	Two/One Part Channel	5	Using Physical Channel	4 Reserved	3	2	1	0	Step
0	Main	0	Two	0	Use	x	0	0	0	0	NTSC Air
1		1	One	1	No Use	x	0	0	0	1	NTSC Cable
						x	0	0	1	0	ATSC Air
						x	0	0	1	1	ATSC Cable_std
						x	0	1	0	0	ATSC Cable_irc
						x	0	1	0	1	ATSC Cable_irc
						x	0	1	1	0	ATSC cable_auto
						x	0	1	1	1	Reserved
						x	x	x	x	x	...
						x	1	1	1	1	Reserved

* All data are transmitted by Hexadecimal code

***Two/One part Channel: 6th bit**

This bit is used in a cable-ready system.

***Using physical channel: 5th bit**

If the channel band is NTSC air or NTSC cable, channel tuning can be done by only physical channel. In this case, using physical channel bit must be low(0).

But if the channel band is ATSC air or ATSC cable, there are two cases that physical channel enable or disable.

If the physical channel sending is meaningful, you should set this bit low(0). If the physical channel sending is meaningless, you should set this bit high(1).

Example)

1. Analog channel: NTSC cable, channel number(35), main picture Command: ma 00 23 xx xx xx 01 attribute(0x01): main picture, two part(it's not mandatory), using physical channel, NTSC cable 'xx' data: don't care major and minor channel number in case analog channel tuning.
2. Digital channel: ATSC air, channel number(don't know physical channel, major(30), minor(3)), main picture Command: ma 00 xx 00 1E 00 03 22 attribute(0x22): main picture, two part, not using physical channel, ATSC air 'xx' data: don't care analog channel number in case digital channel tuning.
3. Digital channel: ATSC air, channel number (physical(20), major (30), minor (5)), main picture Command: ma 00 14 00 1E 00 05 02 attribute(0x02): main picture, two part, using physical channel, ATSC air.

Acknowledgement

[a][][Set ID][][OK][Data0][Data1][Data2][Data3][Data4][Data5][x]
[a][][Set ID][][NG][Data0][x]

23. Channel Add/Del (Command: m b)

- ▶ To add and delete the channels

Transmission

```
[m][b][ ][Set ID][ ][Data][Cr]
```

Data 0: Channel Delete
1: Channel Add

Acknowledgement

```
[b][ ][Set ID][ ][OK][Data][x]
[b][ ][Set ID][ ][NG][Data][x]
```

24. Key (Command: m c)

- ▶ To send IR remote key code

Transmission

```
[m][c][ ][Set ID][ ][Data][Cr]
```

Data Key code: Refer to page 61.

Acknowledgement

```
[c][ ][Set ID][ ][OK][Data][x]
```

25. Input select(Command: x b) (Main Picture Input)

- ▶ To select input source for TV.

Transmission

```
[x][b][ ][Set ID][ ][Data][Cr]
```

Data Structure

DATA(Hex)	INPUT
00	DTV (Antenna)
01	DTV (Cable)
10	Analog (Antenna)
11	Analog (Cable)
20	AV1
21	AV2
40	Component 1
41	Component 2
50	RGB DTV
60	RGB PC
90	HDMI/DVI

Acknowledgement

```
[b][ ][Set ID][ ][OK/NG][Data][x]
```

IR Codes

How to Connect

- ▶ Connect your wired remote control to the Remote Control port on the TV.

Remote Control IR Codes

▶ Output waveform

Single pulse, modulated with 37.917KHz signal at 455KHz

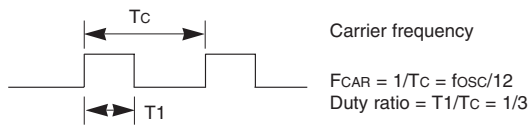

▶ Configuration of frame

- 1st frame

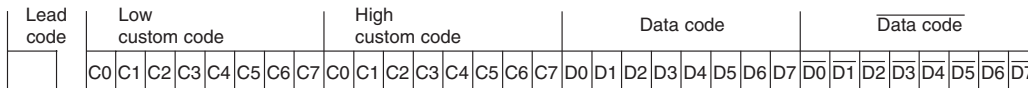

- Repeat frame

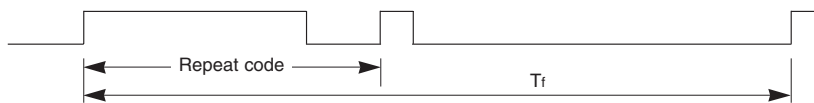

▶ Lead code

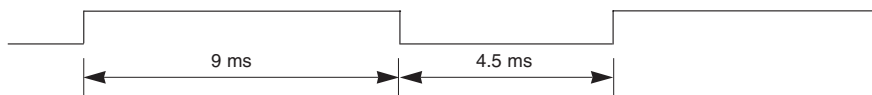

▶ Repeat code

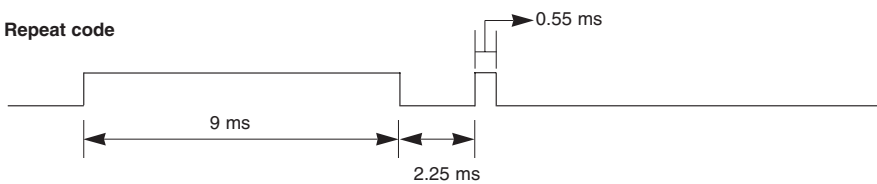

▶ Bit description

- Bit "0"

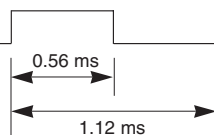

- Bit "1"

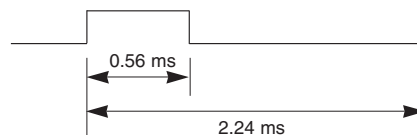

▶ Frame interval : Tf

The waveform is transmitted as long as a key is depressed.

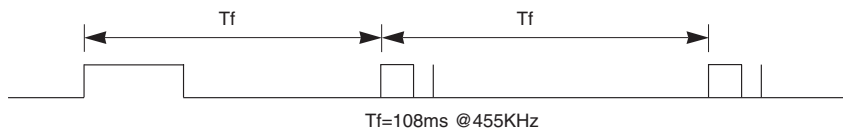

Code (Hexa)	Function	Note
0B	INPUT	R/C Button
0F	TV INPUT	R/C Button
08	POWER	R/C Button (Power On/Off)
C4	POWER ON	Discrete IR Code (Only Power On)
C5	POWER OFF	Discrete IR Code (Only Power Off)
79	RATIO	R/C Button
0E	TIMER	R/C Button
10 ~ 19	Number Key 0~ 9	R/C Button
4C	- (Dash)	R/C Button
1A	FLASHBK	R/C Button
09	MUTE	R/C Button
02	VOL ▲	R/C Button
03	VOL ▼	R/C Button
00	CH ▲	R/C Button
01	CH ▼	R/C Button
1E	FAV	R/C Button
AA	INFO	R/C Button
39	CC	R/C Button
40	▲	R/C Button
41	▼	R/C Button
07	◀	R/C Button
06	▶	R/C Button
44	ENTER	R/C Button
43	MENU	R/C Button
A9	GUIDE	R/C Button
52	EZ SOUND	R/C Button
4D	EZ PIC	R/C Button
5B	EXIT	R/C Button
65	FREEZE	R/C Button
0A	SAP	R/C Button
CB	ADJUST	R/C Button
D6	TV	Discrete IR Code (TV Input Selection)
5A	AV1	Discrete IR Code (AV1 Input Selection)
D0	AV2	Discrete IR Code (AV2 Input Selection)
BF	COMPONENT 1	Discrete IR Code (Component1 Input Selection)
D4	COMPONENT 2	Discrete IR Code (Component2 Input Selection)
D5	RGB-PC	Discrete IR Code (RGB-PC Input Selection)
D7	RGB-DTV	Discrete IR Code (RGB-DTV Input Selection)
C6	HDMI/DVI	Discrete IR Code (DVI-DTV Input Selection)
76	Ratio 4:3	Discrete IR Code (Only 4:3 Mode)
77	Ratio 16:9	Discrete IR Code (Only 16:9 Mode)
AF	Ratio Zoom	Discrete IR Code (Only Zoom1 Mode)

Programming the Remote

- ▶ The remote control is a multi-brand or universal remote control. It can be programmed to operate most remote-controllable devices of other manufacturers.

Note that the remote control may not control all models of other brands.

Programming a code into a remote mode

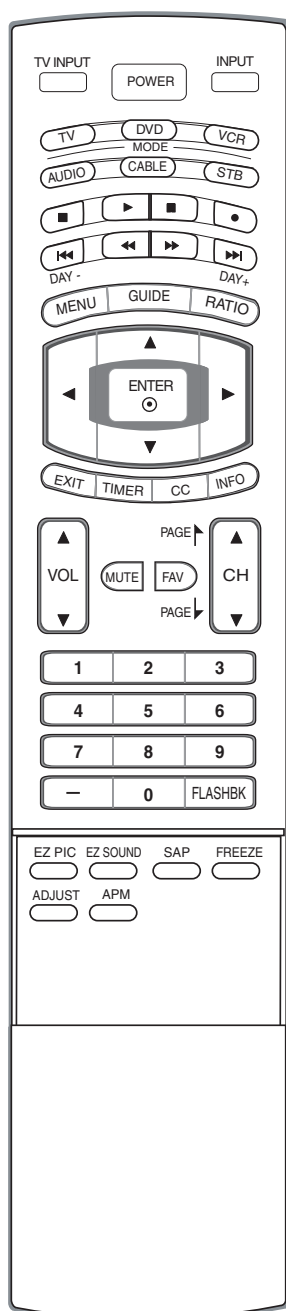

- 1** Test your remote control.
 To find out whether your remote control can operate the component without programming, turn on the component such as a VCR and press the corresponding **MODE** button (VCR) on the remote control, while illuminating on the selected component. Test the **POWER** button to see if the component responds properly. If not, the remote requires programming to operate the device.
- 2** Turn on the component to be programmed, then press the corresponding **MODE** button on the remote control.
- 3** Press the **MENU** and **MUTE** buttons simultaneously for 2 seconds, the button selected component lights on the remote control. If you don't press any button for 20 seconds, the button selected component will turn off on the remote control. At a moment, you have to repeat from step 2.
- 4** Enter a code number using the number buttons on the remote. When pressing the button, the light is blinked at a time. Programming code numbers for the corresponding component can be found on the following pages. Again, if the code is correct, the device will turn off.
- 5** Press the **MENU** button to store the code. After blinking twice, this code is stored.
- 6** Test the remote control functions to see if the component responds properly. If not, repeat from step 2.

Programming Codes

VCRs

Brand	Codes	Brand	Codes	Brand	Codes	Brand	Codes
AIWA	034	KENWOOD	014 034 039 043	PORTLAND	108	TATUNG	039 043
AKAI	016 043 046 124		047 048	PULSAR	072	TEAC	034 039 043
	125 146	LG (GOLDSTAR)	001 012 013 020	QUARTZ	011 014	TECHNICS	031 033 070
AMPRO	072		101 106 114 123	QUASAR	033 066 075 145	TEKNIKA	019 031 033 034
ANAM	031 033 103	LLOYD	034	RCA	013 020 033 034		101
AUDIO DYNAMICS	012 023 039 043	LXI	003 009 013 014		040 041 062 063	THOMAS	034
BROKSONIC	035 037 129		017 034 101 106	REALISTIC	107 109 140 144	TMK	006
CANON	028 031 033	MAGIN	040		145 147	TOSHIBA	008 013 042 047
CAPEHART	108	MAGNAVOX	031 033 034 041		003 008 010 014		059 082 112 131
CRAIG	003 040 135		067 068		031 033 034 040	TOTEVISION	040 101
CURTIS MATHES	031 033 041	MARANTZ	012 031 033 067	RICO	053 054 101	UNITECH	040
DAEWOO	005 007 010 064		069	RUNCO	058	VECTOR RESEARCH	012
	065 108 110 111	MARTA	101	SALORA	148	VICTOR	048
	112 116 117 119	MATSUI	027 030	SAMSUNG	014	VIDEO CONCEPTS	012 034 046
DAYTRON	108	MEI	031 033		032 040 102 104	VIDEOSONIC	040
DBX	012 023 039 043	MEMOREX	003 010 014 031		105 107 109 112	WARDS	003 013 017 024
DYNATECH	034 053		033 034 053 072		113 115 120 122		031 033 034 040
ELECTROHOME	059		101 102 134 139	SANSUI	125		053 054 131
EMERSON	006 017 025 027	MGA	045 046 059	SANYO	022 043 048 135	YAMAHA	012 034 039 043
	029 031 034 035	MINOLTA	013 020		003 007 010 014	ZENITH	034 048 056
	036 037 046 101	MITSUBISHI	013 020 045 046	SCOTT	102 134		058 072 080 101
	129 131 138 153		049 051 059 061		017 037 112 129		
FISHER	003 008 009 010		151	SEARS	131		
FUNAI	034	MTC	034 040		003 008 009 010		
GE	031 033 063 072	MULTITECH	024 034		013 014 017 020		
	107 109 144 147	NEC	012 023 039 043		031 042 073 081		
GO VIDEO	132 136		048	SHARP	101		
HARMAN KARDON	012 045	NORDMENDE	043	SHINTOM	031 054 149		
HITACHI	004 018 026 034	OPTONICA	053 054	SONY	024		
	043 063 137 150	PANASONIC	066 070 074 083		003 009 031 052		
INSTANTREPLAY	031 033		133 140 145		056 057 058 076		
JCL	031 033	PENTAX	013 020 031 033		077 078 149		
JCPENNY	012 013 015 033		063	SOUNDESIGN	034		
	040 066 101	PHILCO	031 034 067	STS	013		
JENSEN	043	PHILIPS	031 033 034 054	SYLVANIA	031 033 034 059		
JVC	012 031 033 043		067 071 101		067		
	048 050 055 060	PILOT	101	SYMPHONIC	034		
	130 150 152	PIONEER	013 021 048	TANDY	010 034		

Cable Box

Brand	Codes	Brand	Codes	Brand	Codes	Brand	Codes
ABC	003 004 039 042	GOLDEN CHANNEL	030	PIONEER	065 085 090	SPRUCER	047 078
	046 052 053	HAMLIN	049 050 055		034 051 052 063	STARCOM	002 004 008 009
AJIN	112	HITACHI	052 055		076	STARGATE	008 030
ANTRONIK	014	HOSPITALITY	070 077	POST NEWS WEEK	016	TADIRAN	030
ARCHER	005 007 014 024	JERROLD	002 003 004 008	PRUCER	059	TAEKWANG	110
CABLE STAR	026		009 010 052 069	PTS	011 048 071 072	TAIHAN	105
CENTURION	092		074		073 074	TANDY	017
CENTURY	007	LG (GOLDSTAR)	001 106 101 005	PULSAR	100	TEXSCAN	029
CITIZEN	007	M-NET	037	RCA	047	TOCOM	039 040 056
COLOUR VOICE	065 090	MACOM	033	REGAL	049 050	TOSHIBA	100
COMBANO	080 081	MAGNAVOX	010 012 064 079	REGENCY	057	UNIKA	007 014 024
COMTRONICS	019 030	MEMOREX	100	REMBRANT	025	UNITED CABLE	004 053
DIAMOND	023	MOVIE TIME	028 032	SAMSUNG	102 107 030 068	UNIVERSAL	005 007 014 024
EAGLE	020 030 040	NSC	015 028 038 071	SCIENTIFIC ATLANTA	003 011 041 042		026 027 032 035
EASTERN	057 062 066		073		043 045 046	VIEWSTAR	012 015 018 086
ELECTRICORD	032	OAK	016 031 037 053	SHERITECH	022		087 088 089
GE	072	PANASONIC	044 047	SIGNAL	030	ZENITH	100 114 060 093
GEMINI	008 022 025 054	PARAGON	100	SIGNATURE	052		
GI	052 074	PHILIPS	006 012 013 020	SL MARX	030		

Digital Cable/Satellite Box

Brand	Codes	Brand	Codes	Brand	Codes	Brand	Codes
ALPHASTAR DSR	123		133 134	PACE SKY SATELLITE	143		088 090 107 130
AMPLICA	050	GENERAL INSTRUMENT	003 004 016 029	PANASONIC	060 142		137
BIRDVIEW	051 126 129		031 059 101	PANSAT	121	TOSHIBA	002 127
CHANNEL MASTER	013 014 015 018	HITACHI	139 140	PERSONAL CABLE	117	UNIDEN	016 025 042 043
	036 055	HOUSTON TRACKER	033 037 039 051	PHILIPS	071		044 045 048 049
CHAPARRAL	008 009 012 077		057 104	PICO	105		078 079 080 086
CITOH	054	HUGHES	068	PRESIDENT	019 102		101
CURTIS MATHES	050 145	JANIEL	060 147	PRIMESTAR	030 110 111	UNIDEN	135 136
DRAKE	005 006 007 010	JERROLD	061	PROSAT	072	VIEWSTAR	115
	011 052 112 116	KATHREIN	108	RCA	066 106	WINEGARD	128 146
	141	LEGEND	057	REALISTIC	043 074	ZENITH	081 082 083 084
DX ANTENNA	024 046 056 076	LG	001	SAMSUNG	123		091 120
ECHOSTAR	038 040 057 058	LUTRON	132	SATELLITE SERVICE CO	028 035 047 057		
	093 094 095 096	LUXOR	062 144		085		
	097 098 099 100	MACOM	010 059 063 064	SCIENTIFIC ATLANTA	032 138		
	122		065	SONY	103		
ELECTRO HOME	089	MEMOREX	057	STARCAST	041		
EUROPLUS	114	NEXTWAVE	028 124 125	SUPER GUIDE	020 124 125		
FUJITSU	017 021 022 027	NORSAT	069 070	TEECOM	023 026 075 087		

Audio

Brand	Codes	Brand	Codes	Brand	Codes	Brand	Codes
AIWA	014 028 070 096	JVC	004 013 141	PHILIPS	026 112 143	TOSHIBA	137
	125 129 139 229	KEC	185 186 187	PIONEER	039 042 043 063	THE	061
	230	KENWOOD	038 050 067 089		065 091 093 094	VICTOR	088 131
AKAI	163		170 171 197 206		115 123 127 250	WARDS	089
ANAM	003 014 017 023		215 222	QUASAR	113	YAMAHA	054 055 066 092
	059 106 189 216	KOHEL	030	RCA	080		199
	217 235 236	NAD	045 046	RCX	092		
BURMECTER	252	LOTTE	014 016 036 098	REALISTIC	103 106		
CARVER	086		100 172 173 174	SAMSUNG	124 145 146 182		
CLARION	199		175 176 177 178		193 194 195 203		
DAEWOO	027 053 060 084		179 180 181 183		204 244 245 246		
	102 148 198 221		201 202 208 213	SANSUI	011 135 138 144		
DENON	015 075 130 143		214 219 223 232	SANYO	019 083 234		
FANTASIA	071		238 240	SCOTT	106 186		
FINEARTS	022	LXI	103	SHARP	031 032 051 052		
FISHER	089 099	MAGNAVOX	111		072 082 117 119		
LG(GOLDSTAR)	001 021 024 029	MARANTZ	002 018 020 025		156 184 199 200		
	087 107 108 110		034 041 081 090	SHERWOOD	206 209		
	190 191 192 210		097 112		005 006 158		
	211 212 239	MCINTOSH	049	SONY	044 045 109 114		
HAITAI	034 035 188 222	MCS	104		118 126 248 249		
HARMAN/KARDON	068	MEMOREX	107	TAEKWANG	012 020 073 074		
INKEL	037 058 062 069	NAD	046		076 077 105 161		
	078 079 095 121	ONKYO	013 040 041 047		162 163 164 165		
	122 149 150 151		048 056 057 132		166 167 168 169		
	152 153 154 155		133 140		205 231 233 242		
	157 158 159 160	OPTIMUS	158	TEAC	010 085 106 136		
	189 207 222 224	PANASONIC	007 033 064 113		185 187 237		
	225 226 227 243		142 220 241 251	TECHNICS	101 113 128 134		
	247	PENNEY	104		147 218		

DVD

Brand	Codes	Brand	Codes	Brand	Codes	Brand	Codes
APEX DIGITAL	022	MAGNAVOX	013	PHILIPS	013	SONY	007
DENON	020 014	MARANTZ	024	PIONEER	004 026	THOMPSON	005 006
GE	005 006	MITSUBISHI	002	PROCEED	021	TOSHIBA	019 008
HARMAN KARDON	027	NAD	023	PROSCAN	005 006	YAMAHA	009 018
JVC	012	ONKYO	008 017	RCA	005 006	ZENITH	010 016 025
LG	001 010 016 025	PANASONIC	003 009	SAMSUNG	011 015		

Troubleshooting Checklist

The operation does not work normally.	
The remote control doesn't work	<ul style="list-style-type: none"> • Check to see if there is any object between the product and the remote control causing obstruction. • Are batteries installed with correct polarity (+ to +, - to -)? • Correct remote operating mode set: TV, VCR etc.? • Install new batteries.
Power is suddenly turned off	<ul style="list-style-type: none"> • Is the sleep timer set? • Check the power control settings. Power interrupted • No broadcast on station tuned with Auto off activated.

The video function does not work.	
No picture & No sound	<ul style="list-style-type: none"> • Check whether the product is turned on. • Try another channel. The problem may be with the broadcast. • Is the power cord inserted into wall power outlet? • Check your antenna direction and/or location. • Test the wall power outlet, plug another product's power cord into the outlet where the product's power cord was plugged in.
Picture appears slowly after switching on	<ul style="list-style-type: none"> • This is normal, the image is muted during the product startup process. Please contact your service center, if the picture has not appeared after five minutes.
No or poor color or poor picture	<ul style="list-style-type: none"> • Adjust Color in menu option. • Keep a sufficient distance between the product and the VCR. • Try another channel. The problem may be with the broadcast. • Are the video cables installed properly? • Activate any function to restore the brightness of the picture.
Horizontal/vertical bars or picture shaking	<ul style="list-style-type: none"> • Check for local interference such as an electrical appliance or power tool.
Poor reception on some channels	<ul style="list-style-type: none"> • Station or cable product experiencing problems, tune to another station. • Station signal is weak, reorient antenna to receive weaker station. • Check for sources of possible interference.
Lines or streaks in pictures	<ul style="list-style-type: none"> • Check antenna (Change the direction of the antenna).

The audio function does not work.	
Picture OK & No sound	<ul style="list-style-type: none"> • Press the VOL or VOLUME button. • Sound muted? Press MUTE button. • Try another channel. The problem may be with the broadcast. • Are the audio cables installed properly?
No output from one of the speakers	<ul style="list-style-type: none"> • Adjust Balance in menu option.
Unusual sound from inside the product	<ul style="list-style-type: none"> • A change in ambient humidity or temperature may result in an unusual noise when the product is turned on or off and does not indicate a fault with the product.

There is a problem in PC mode. (Only PC mode applied)	
The signal is out of range.	<ul style="list-style-type: none"> • Adjust resolution, horizontal frequency, or vertical frequency. • Check it whether the signal cable is connected or loose. • Check the input source.
Vertical bar or stripe on background & Horizontal Noise & Incorrect position	<ul style="list-style-type: none"> • Work the Auto configure or adjust clock, phase, or H/V position. (Option)
Screen color is unstable or single color	<ul style="list-style-type: none"> • Check the signal cable. • Reinstall the PC video card.

Maintenance

- Early malfunctions can be prevented. Careful and regular cleaning can extend the amount of time you will have your new TV. Be sure to turn the power off and unplug the power cord before you begin any cleaning.

Cleaning the Screen

1. Here's a great way to keep the dust off your screen for a while. Wet a soft cloth in a mixture of lukewarm water and a little fabric softener or dish washing detergent. Wring the cloth until it's almost dry, and then use it to wipe the screen.
2. Make sure the excess water is off the screen, and then let it air-dry before you turn on your TV.

Cleaning the Cabinet

To remove dirt or dust, wipe the cabinet with a soft, dry, lint-free cloth. Please do not use a wet cloth.

Extended Absence



If you expect to leave your TV dormant for a long time (such as a vacation), it's a good idea to unplug the power cord to protect against possible damage from lightning or power surges.

Product Specifications

32LC2D (32LC2D-UD)	Dimensions (Width x Height x Depth)	including stand	31.9 x 24.8 x 9.3 inches 811 x 630 x 235 mm
		excluding stand	31.9 x 22.3 x 4.9 inches 811.0 x 566.8 x 123.5 mm
32LC2DC (32LC2DC-UD)	Weight	including stand	48.3 pounds / 21.9 kg
		excluding stand	40.8 pounds / 18.5 kg
37LC2D (37LC2D-UD)	Dimensions (Width x Height x Depth)	including stand	37.2 x 28.7 x 11.3 inches 944 x 729 x 286 mm
		excluding stand	37.2 x 26.0 x 5.1 inches 944.0 x 659.3 x 129.7 mm
	Weight	including stand	65.0 pounds / 29.5 kg
		excluding stand	54.9 pounds / 24.9 kg
42LC2D (42LC2D-UD)	Dimensions (Width x Height x Depth)	including stand	41.5 x 32.0 x 11.9 inches 1054 x 813 x 302 mm
		excluding stand	41.5 x 29.4 x 5.4 inches 1054.0 x 746.0 x 136.8 mm
	Weight	including stand	81.6 pounds / 37.0 kg
		excluding stand	67.0 pounds / 30.4 kg
Power requirement		AC100-240V ~ 50/60Hz	
Television System		NTSC-M, ATSC, 64 & 256 QAM	
Program Coverage		VHF 2 ~ 13, UHF 14 ~ 69, CATV 1 ~ 135, CADTV 1 ~ 135, DTV 2 ~ 69	
External Antenna Impedance		75 Ω	
Environmental condition	Operating Temperature		32 ~ 104°F (0 ~ 40°C)
	Operating Humidity		Less than 80%
	Storage Temperature		-4 ~ 140°F (-20 ~ 60°C)
	Storage Humidity		Less than 85%

- The specifications shown above may be changed without prior notice for quality improvement.

42PC1DVH (42PC1DVH-UD)	Dimensions (Width x Height x Depth)	including stand	44.4 x 29.5 x 15.0 inches 1129.0 x 748.5 x 380.0 mm
		excluding stand	44.5 x 27.4 x 4.1 inches 1129.0 x 695.0 x 103.7 mm
	Weight	including stand	61.1 pounds / 27.7 kg
		excluding stand	53.4 pounds / 24.2 kg
42PC3D (42PC3D-UD)	Dimensions (Width x Height x Depth)	including stand	44.4 x 29.5x 15.0 inches 1129.0 x 748.5 x 380.0 mm
		excluding stand	44.4 x 27.4 x 4.1 inches 1129.0 x 695 x 103.7 mm
42PC3DC (42PC3DC-UD)			
42PC3DH (42PC3DH-UD)	Weight	including stand	64.4 pounds / 29.2 kg
		excluding stand	55.8 pounds / 25.3 kg
42PC3DV (42PC3DV-UD)	Dimensions (Width x Height x Depth)	including stand	44.4 x 29.5x 15.0 inches 1129.0 x 748.5 x 380.0 mm
		excluding stand	44.4 x 27.4 x 4.1 inches 1129.0 x 695 x 103.7 mm
	Weight	including stand	62.6 pounds / 28.4 kg
		excluding stand	54.0 pounds / 24.5 kg
42PC3DVA (42PC3DVA-UD)			
50PC3D (50PC3D-UD)	Dimensions (Width x Height x Depth)	including stand	51.3 x 34.3 x 14.0 inches 1302.6 x 872.0 x 355.8 mm
		excluding stand	51.3 x 31.9 x 4.2 inches 1302.6 x 810.0 x 107.7 mm
50PC3DH (50PC3DH-UD)			
50PC3DX (50PC3DX-UD)	Weight	including stand	114.4 pounds / 51.9 kg
		excluding stand	95.0 pounds / 43.1 kg
Power requirement			AC100-240V ~ 50/60Hz
Television System			NTSC-M, ATSC, 64 & 256 QAM
Program Coverage			VHF 2 ~ 13, UHF 14 ~ 69, CATV 1 ~ 135, CADTV 1 ~ 135, DTV 2 ~ 69
External Antenna Impedance			75 Ω
Environmental condition	Operating Temperature		32 ~ 104°F (0 ~ 40°C)
	Operating Humidity		Less than 80%
	Storage Temperature		-4 ~ 140°F (-20 ~ 60°C)
	Storage Humidity		Less than 85%

- The specifications shown above may be changed without prior notice for quality improvement.