

SPECIFICATIONS

GENERAL

Power Source : AC, 117V or 110-120/220-240V 60/50 Hz
: DC, 15Volt, 10 "D" Cell Batteries or Car Input Jack.
Power Consumption : 48 w (AC)
Semiconductors : 8 Integrated Circuits
: 23 Transistors 42 Diodes
Dimensions-System : Width 25 inches (63.5 cm)
: Height 14 inches (36 cm)
: Depth 6 inches (15.6 cm)
Weight (without Batteries) : 19 Lbs (8.6 Kg)

AMPLIFIER

Peak Music Power : 50 Watt Per Channel/4 ohms
Continuous Power : 15 Watt RMS Per Channel/4 ohms
Frequency Response : 35-14,000 Hz
Output Impedance : Speaker-4 ohms, Headphone-8 ohms,
: Line Out 10 K ohms.
Input Impedance : Ext. Microphone 3.3 K ohms, Phono 47 K ohms,
: Line In 47 K ohms.

TUNER

Frequency Range : AM 530-1600KHz FM 88-108 MHz
: SW₁ 2.5 - 7MHz, SW₂ 7.5 - 22 MHz
FM Stereo Sensitivity : 25 dB
FM Stereo Separation : 30 dB

CASSETTE

Tape : Compact Cassette (C-90 or Less)
Tape Speed : 1-7/8 IPS (4.75 cm/sec)
Frequency Response : 35-14000 Hz, Metal
: 35-11000 Hz, Normal
S/N Ratio : 50 dB
Wow & Flutter : Less Than 0.3% WRMS
Recording System : AC bias
Erasing System : DC erase
Fast Forward/Rewind Time : 105 sec. (C-60)

SPEAKER ENCLOSURE

Specifications can be applied to either Right or Left speaker enclosure.
Type/Size : Woofer, Bass-Reflex. 8 inch (20 cm)
: Tweeter, Cone, 2 inch (5 cm)

The manufacturer reserves the right to vary specifications, design, or use alternative materials as may be deemed necessary or desirable at any time, any such change or variations being of a kind as not to reduce the quality, performance or appearance.

LASONIC ELECTRONICS CORP

1827 W. VALLEY BLVD
ALHAMBRA, CA 91803

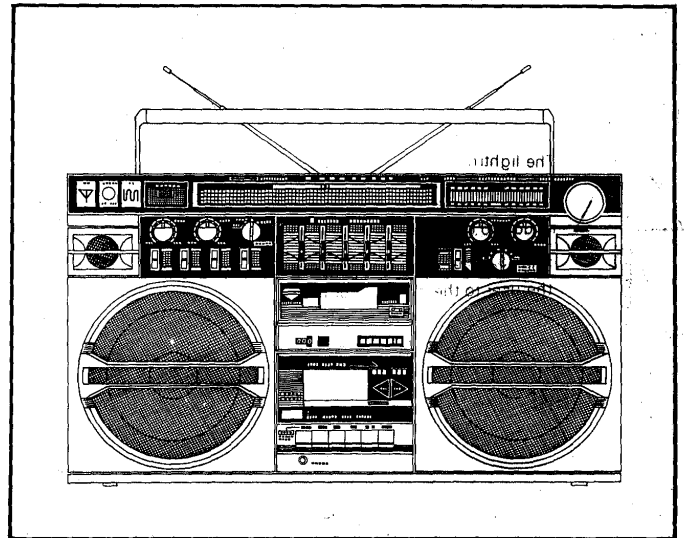

LASONIC®

Instruction Manual



DE LUXE JUMBO PORTABLE RADIO DOUBLE CASSETTE RECORDER MODEL TRC-931

Before operating this set, please read these instructions carefully

| | | |
|--|---|---|
|  | CAUTION RISK OF ELECTRIC SHOCK DO NOT OPEN |  |
| CAUTION: TO REDUCE THE RISK OF ELECTRIC SHOCK, DO NOT REMOVE COVER (OR BACK). NO USER-SERVICEABLE PARTS INSIDE. REFER SERVICING TO QUALIFIED SERVICE PERSONNEL. | | |

 The lightning flash with arrowhead symbol, within an equilateral triangle, is intended to alert the user to the presence of uninsulated "dangerous voltage" within the product's enclosure that may be of sufficient magnitude to constitute a risk of electric shock to persons.

 The exclamation point within an equilateral triangle is intended to alert the user to the presence of important operating and maintenance (servicing) instructions in the literature accompanying the appliance.

| |
|---|
| WARNING: TO REDUCE THE RISK OF FIRE OR ELECTRIC SHOCK, DO NOT EXPOSE THIS APPLIANCE TO RAIN OR MOISTURE. |
|---|

SERVICING INSTRUCTIONS

1. Disconnect the RADIO from the main supply before opening the cabinet.
2. Components identified with the Symbol  on the schematic diagram, are deemed to be critical with respect to the risks of fire and electrical shock associated with the RADIO.
3. Use only replacement parts that have the critical characteristics recommended by the manufacturer.
4. Service personnel shall make leakage-current or resistance measurements to determine that exposed parts are acceptably insulated from the supply current before returning the apparatus to the customer.

9. When recorder does not record from the PHONO INPUT jacks:
 - a. Check the connection of the PHONO INPUT jacks.
 - b. See that the FUNCTION selector is rotated in the "PHONO" position.
10. When the sound quality is distorted or out of tune in a playback mode:
 - a. Check if the batteries are weak.
 - b. If dirt or reddish-brown oxide has accumulated, clean the heads, pinch roller and capstan.
11. When the record mode does not work:
 - a. Check that the tab of cassette is not removed.

WARNING

We recommend exclusively the use of well known brands of cassette tape for use in this unit having a running time of no more than 45 minutes per side (C-90). The use of low quality tapes or lengths greater than C-90 may cause tape chewing which may result in damage to the cassette mechanism.

TROUBLE SHOOTING

Please check the following items before seeing your local service station

1. When neither Radio nor Tape recorder operates:
 - a. Check the batteries polarity.
 - b. Check that the batteries are not exhausted.
 - c. Check if the AC plug is connected to outlet or not.
2. When there is no sound (noise) in Radio mode:
 - a. See that the FUNCTION selector is rotated in the "RADIO" position.
 - b. See that the VOLUME control is not set at the minimum position.
3. When sound quality deteriorates:
 - a. Re-rotate the TUNING knob to your desired station exactly.
 - b. Check that the batteries are not exhausted.
4. When the cassette compartment lid does not close:
 - a. Check if the cassette fits into the cassette holder.
 - b. See that the PLAY button is not depressed already.
5. When the tape does not move:
 - a. Check if the batteries are weak.
 - b. See that the PAUSE button is not depressed.
6. When there is no sound (noise) from depressing the PLAY button:
 - a. See that the VOLUME control is not set at the minimum position.
 - b. See that the FUNCTION selector is rotated in the "TAPE" position.
7. When recorder does not record from the built-in radio:
 - a. See that the FUNCTION selector is rotated in the "RADIO" position.
 - b. Check if the radio program is being received.
 - c. See that the MIC selector is set to "INT MIC" position.
8. When recorder does not record from external microphones:
 - a. Check the connection of the EXT. MIC. MIX. jack.
 - b. See that the FUNCTION selector is rotated in the "TAPE" position.
 - c. See that the MIC selector is set to "EXT MIC" position.

THE PROPER USE OF THIS UNIT

This unit has been designed and manufactured to meet the highest international standards, but, like any electrical apparatus, care must be taken if the best results and safety are to be assured. These DOs and DON'Ts have been prepared to ensure that this unit is properly used.

- DO** read the operating instructions carefully before you attempt to use this unit.
- DO** ensure that all electrical connections (including the mains plug and any extension leads) are properly made and in accordance with the manufacturer's instructions.
- DO** ensure that this unit is switched off at the mains outlet if you go away for an extended period. Remove the plug if the mains outlet has no switch.
- DO** always ask the advice of a qualified engineer if you are ever in any doubt about the operation or safety of this unit. He is the best person to advise you.
- DON'T** expose the product to rain or moisture to prevent fire or electrical shock hazard.
- DON'T** continue to operate this unit if you have any doubt about it working normally, or if it is damaged in any way—withdraw the mains plug and consult a qualified engineer.
- DON'T** remove any fixed cover unless you are qualified to do so—and even then withdraw the mains plug before you start.
- DON'T** obstruct any of the ventilation slots in this equipment, or stand it close to curtains or on soft furnishings such as carpets. Obstructing these ventilation slots may cause overheating and shorten the life of the unit.

ABOVE ALL:

**never let children push anything into holes or slots in the case —
this could result in an electric shock !
never guess or take a chance with this unit — it is better to be
safe than sorry !**

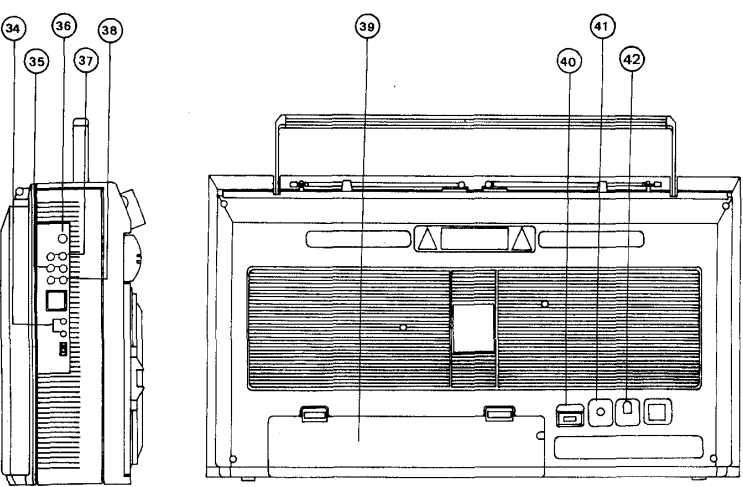
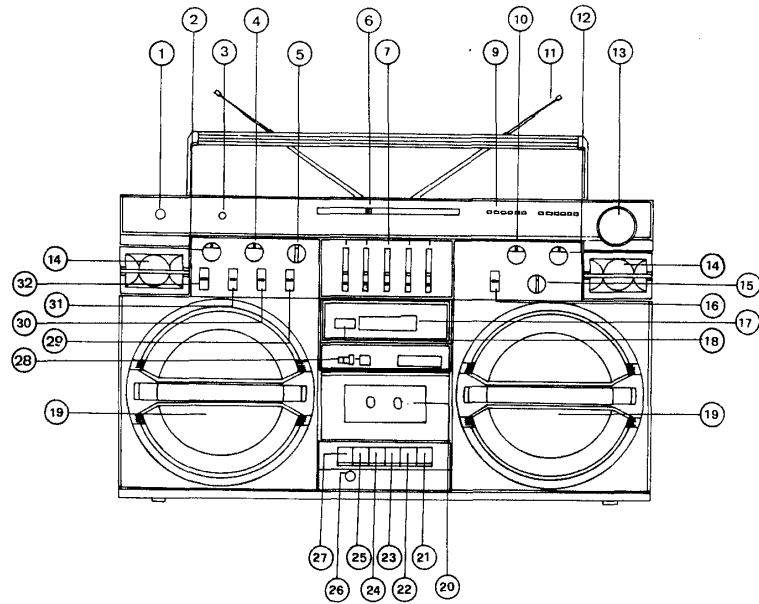

2. If the cassette feels 'tight' whilst performing the operation shown in fig. 2, the tape may be jamming due to 'ridges' in the winding of the tape (visible through the centre window). These may be removed in most cases by fast winding of the cassette from one end to the other and back again.

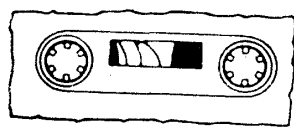

Fig. 1

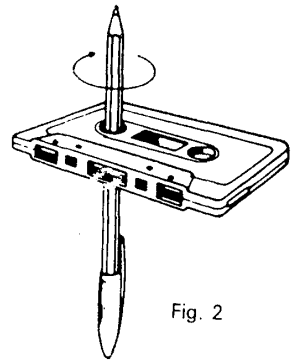

Fig. 2

RECORD PREVENT DEVICE

The cassette tape contains 'Knock Outs' on its rear end to prevent accidental recording on, or erasure of a pre-recorded tape. Recording can only be made when these 'Knock Outs' are intact. There is one knock out for each side (track) of the tape. To protect a recorded tape, proceed as follows:

With the record side of the tape facing upwards and the rear end (opposite the open end) facing you, use a small screwdriver to prise out the tab on your right-hand side

If after the tabs have been removed, you wish to re-record on the protected side, simply cover the hole with a piece of sticky tape, thereby activating the accidental record prevention lever built into this unit's mechanism.

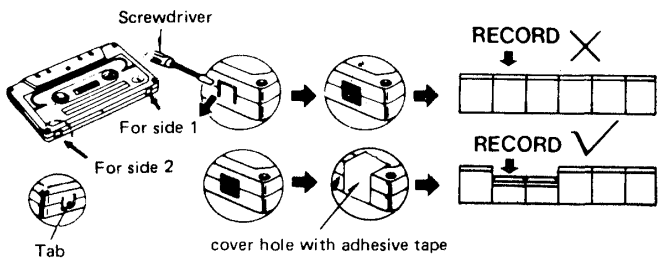

This is NOT A FAULT OF THE UNIT ITSELF but merely due to a deposit of oxide and other contamination on the tape heads. The head assembly, the capstan and the pinch roller are in constant contact with the tape. If these parts are dirty or have dust adherence, abnormal phenomena such as sound decrease, distortion, fluctuation or tape chewing will result.

Use a small cotton swab with tape cleaning alcohol to clean the tape head, capstan and pinch roller carefully (rubbing or drinking alcohol should not be used).

Another easy way to overcome the problem is by using of a proprietary brand of headcleaning cassette. Follow the instructions provided with the cleaner carefully and DO NOT OVERUSE as this may cause undue wear. The tape head is a delicate precision component and serious damage will result if you attempt to scrape the contamination away with a sharp implement.

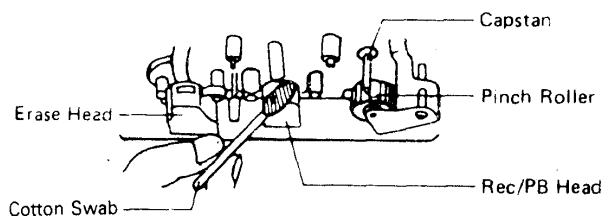

NOTE: 1. Don't bring articles of metal or magnetic material, such as a screwdriver near the head assembly.

2. After cleaning, be sure no particles of cotton are left.

Other common causes of trouble are:

- a. Tape jamming — leading to uneven speed on playback and record.
- b. Tape tangling — where the tape wraps/itself around vital parts of the mechanism.

To reduce the likelihood of these problems occurring, you must observe the following precautions:

1. Check that there are no loose layers of tape visible through the cassette centre window (see fig. 1). Take-up these loose layers using a pencil or ballpoint pen before inserting the cassette into the machine (see fig. 2).

FEATURES

- | | |
|---|--|
| 1. POWER SWITCH (ON/OFF/SLEEP) | 21. PAUSE BUTTON |
| 2. VOLUME CONTROL | 22. STOP/EJECT BUTTON |
| 3. BUILT-IN CONDENSER MICROPHONE | 23. FAST FORWARD BUTTON |
| 4. BALANCE CONTROL | 24. REWIND BUTTON |
| 5. FUNCTION SELECTOR (TAPE/RADIO/PHONO) | 25. PLAY BUTTON |
| 6. POINTER PLUS FM-STEREO INDICATOR | 26. HEADPHONES JACK |
| 7. 5 BAND GRAPHIC EQUALIZER CONTROLS | 27. RECORD BUTTON |
| 9. L.E.D. INDICATORS | 28. COUNTER AND RESET BUTTON |
| 10. MIC. MIX. VOL. CONTROL | 29. MIC SELECTOR (LINE IN & EXT MIC/INT MIC) |
| 11. TELESCOPIC ANTENNAS | 30. TAPE SELECTOR (METAL/NORMAL) |
| 12. RECORD VOLUME CONTROL | 31. MODE SELECTOR (STEREO/MONO) |
| 13. TUNING KNOB | 32. LOUDNESS SWITCH |
| 14. TWEETERS | 34. EXT. SPEAKER JACKS |
| 15. BAND SELECTOR (FM/AM/SW1/SW2) | 35. EXT. LINE IN JACKS |
| 16. A.L.C. BUTTON | 36. EXT. MIC. MIX JACK |
| 17. TAPE A CASSETTE COMPARTMENT | 37. PHONO INPUT JACKS |
| 18. F.FWD/EJECT BUTTON | 38. EXT. LINE OUT JACKS |
| 19. WOOFERS | 39. BATTERY/POWER CORD COMPARTMENT |
| 20. TAPE B CASSETTE COMPARTMENT | 40. AC/DC SELECTOR |
| | 41. BATTERY ADAPTOR JACK (DC IN 12V) |
| | 42. AC 110-120/220-240V SELECTOR |

POWER SUPPLY

This unit is designed to operate on AC (~) 117V or 110-120/220-240 Volts 60/50 Hz mains supply, and ensure the voltage should correspond to local voltage or DC 15 Volts by using 10 batteries, type 'D cells' (UM-1) or equivalent or battery adaptor (both not included).

AC OPERATION

This unit is equipped with a built in AC cord.

1. Before operating the unit for the first time, please make sure the setting of the voltage selector corresponds to the local power voltage and place the AC/DC SELECTOR (40) to the 'AC' position.

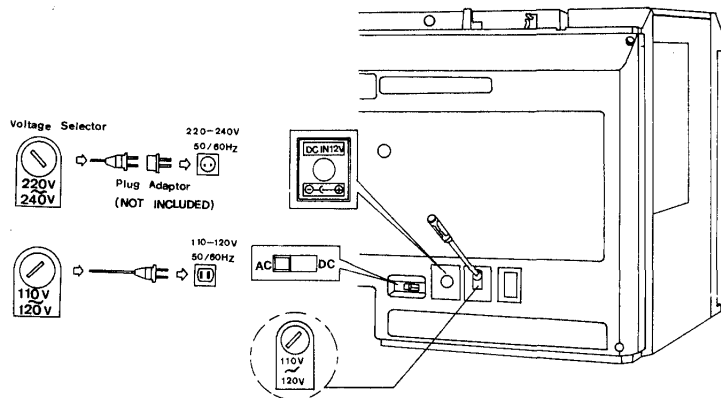

NOTE: This unit can be used with the extra AC plug adaptors in different countries. Please choose that fits the wall outlet where you are and use it in conjunction with the AC power cord attached to this unit. Assemble as shown in the above illustration.

The desired time can be selected by the amount of tape remaining to be used on the cassette reel.

| TAPE | MAX. SLEEP TIME |
|------|-----------------|
| C-30 | 15 minutes |
| C-60 | 30 minutes |
| C-90 | 45 minutes |

NOTE: You can use 'Continuous tape playback' character to get double or combined the above mentioned time as you desired.

The sound of the radio broadcast can now be heard. The radio broadcast can be heard only while the tape is moving. When the tape comes to its end, it stops automatically. The PLAY button (25) will return to its original position and the power to the radio is turned off.

L.E.D. INDICATORS

There are separate L.E.D. indicators (9) for right and left channels in all operations, the L.E.D. indicators will be flashing in rhythm to indicate the sound level of the unit. The flashing intensity of the L.E.D. indicators is not affected by the VOLUME, BALANCE and GRAPHIC EQUALIZER controls (2,4,7) just according to the input signal.

PRIVATE LISTENING

Insert an optionally available stereo headphones into the HEADPHONES jack (26). This will automatically disconnect the speakers.

LOUDNESS SWITCH

The LOUDNESS switch (32) when in the 'ON' (switched) position serves to enhance the high and low frequency response of the unit and may be used whenever unit is operating at low volume levels to compensate for the drop in frequency response. However, at higher output levels, this switch will have no effect.

MAINTENANCE

After a period of time, especially when inexpensive brands of tape are used, the sound on playback may become "muffled" or in extreme cases, almost inaudible.

Playback an external sound source through the unit

1. Connect an external sound source to the EXT. LINE IN jacks (35).
2. Rotate the FUNCTION selector (5) in the "TAPE" position.
3. Adjust the VOLUME, BALANCE and GRAPHIC EQUALIZER controls (2,4,7).

Playback through an amplifier

Connect the RCA type patch cords (not supplied) from the EXT. LINE OUT jacks (38) of the unit to your amplifier. The output level of the EXT. LINE OUT jacks (38) is fixed regardless of the VOLUME setting.

MIC. MIXING

Microphone mixing is possible when unit is playing or recording. Proceed as follows:

Playback mixing

1. Set the unit to either playback pre-recorded cassette, listen to radio broadcast material, or listen to stereo player, or auxiliary input.
2. Connect an optionally available microphone to the EXT. MIC. MIX jack (36) and let the MIC selector (29) in the 'LIN IN & EXT MIC' position.
3. Rotate the MIC. MIX VOLUME control (10) at a level high enough to allow your voice to be heard with respect to unit's sound.

Recording mixing

1. Set the unit to record from radio broadcast, or stereo player or auxiliary input.
2. Connect an optionally available microphone to the EXT. MIC. MIX jack (36) and let the MIC selector (29) in the "LINE IN & EXT MIC" position.
3. Place the MIC. MIXING VOLUME control (10) at a level high enough to allow your voice to be heard with respect to the material being recorded.

NOTE: In both above cases, to avoid "howling" between microphone and speakers, do not place microphone too close to the speakers or, alternatively, adjust the unit's MIC. MIX VOLUME control (10) (this will not affect recording levels).

SLEEP TIMER

1. Select the desired radio broadcast as described earlier in "Radio Operation" paragraph.
2. Place the POWER switch (1) in "SLEEP" position.
3. Insert a cassette tape into cassette compartment lid guides, and depress the PLAY button (25).

2. Open the BATTERY/POWER CORD COMPARTMENT (39) lid by pressing the tabs down and pulling the lid forward to take out the power cord.
3. Plug the power cord into an AC outlet.
4. Close the BATTERY/POWER CORD COMPARTMENT (39) lid as it has a small cutout through which the cord can pass.

NOTE: When using the unit on AC exclusively, the batteries should be removed from the unit to avoid damage to the unit. Unused batteries may leak and corrode, possibly damage your set.

DC OPERATION

Place the AC/DC SELECTOR (40) to the 'DC' position.

- NOTE:**
1. The battery lead and the BATTERY ADAPTOR jack (41) are connected so that the center contact of the BATTERY ADAPTOR jack (41) is positive and the outer contact is negative.
 2. The correct polarity of these leads must be strictly observed, failure to do so may result in severe damage to the receiver.

12 volts battery adaptor

Connect an optionally available battery adaptor into any appropriate local power mains supply. Plug the other end into the BATTERY ADAPTOR jack (41). The batteries are automatically disconnected when the battery adaptor is plugged into the BATTERY ADAPTOR jack (41).

NOTE: The BATTERY ADAPTOR is manufactured by Radio Shack, A Division of Tandy Corp., Cat. No. 270-1534A

This unit can be operated on external 12 volts DC power supply by using the DC connection lead.

1. Disconnect unit from AC mains supply.
2. Insert the DC connection lead to the BATTERY ADAPTOR jack (41).
3. The batteries are automatically disconnected when the DC connection lead is plugged into the BATTERY ADAPTOR jack (41).

15 volts batteries

This unit operates on 15 volts DC power by using 10 batteries, type 'D cells' (UM-1) or equivalent.

1. Remove the lid of the BATTERY/POWER CORD COMPARTMENT (39) by pressing the tabs down and pulling the lid forward.
2. Insert the batteries as indicated by the markings inside the BATTERY/POWER CORD COMPARTMENT (39).
3. Ensure the correct polarity is strictly observed.

NOTE: 1. When operating your unit on batteries, please ensure the AC cord is unplugged from AC outlet.

2. The batteries will last longer if you keep the volume down. Remember, the higher the volume, the shorter the life of the batteries.
3. Old batteries can leak and cause corrosion, so never leave rundown batteries in your unit which may cause corrosion and damage to the set.

CAR BATTERY OPERATION

1. Insert the plug of the car battery cord into the BATTERY ADAPTOR jack (41).
2. Plug the other end of this cord into the Cigarette Lighter socket in your car.

Upon plugging the car battery cord into the BATTERY ADAPTOR jack (41) the unit will automatically switch from internal battery to car battery operation.

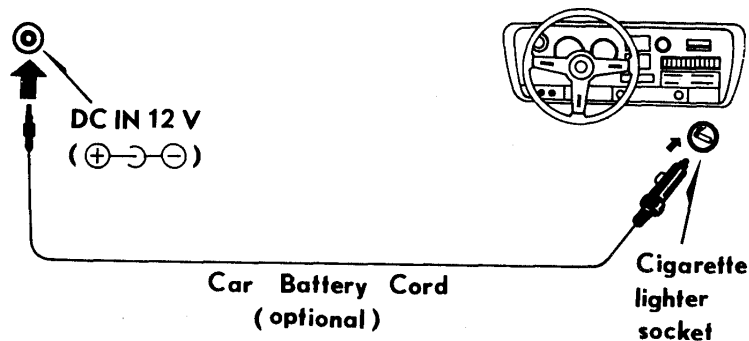

2. Rotate the FUNCTION selector (5) in the "TAPE" position.

3. Depress and lock the RECORD button (27), in the meantime, the PLAY button (25) will be locked automatically-specially designed with 'One Touch Recording' function.

Recording from another playback tape (TAPE A to TAPE B)

Since this unit features 'DOUBLE CASSETTE' device, you can operate this section without another unit

1. Follow steps 1-3 of 'CASSETTE OPERATION' paragraph.
2. Depress the STOP/EJECT button (22) to open the TAPE B cassette compartment lid and insert the blank tape in.
3. Insert the playback tape in the TAPE A CASSETTE COMPARTMENT (17).
4. Depress and lock the RECORD button (27), in the meantime, the PLAY button (25) will be locked automatically. Now recording will be started.

Erasure of recordings

When a new recording is made, all previous recordings on that part of tape are automatically erased and only the new recording remains.

NOTE: This applies to TAPE B cassette mechanism only.

PLAYBACK

Playback a recorded tape

Follow steps described in 'CASSETTE OPERATION' paragraph.

Continuous tape playback (TAPE A to TAPE B)

1. Follow steps 1-3 of 'CASSETTE OPERATION' paragraph.
2. Respectively insert the playback tapes in the TAPE A and TAPE B CASSETTE COMPARTMENT (17,20).
3. Depress the PLAY button (25). This unit is now playing TAPE A cassette tape material.
4. When the playback of TAPE A ends, the playback of TAPE B begins automatically.

Recording from external microphone

1. Connect an optionally available microphone to the EXT. MIC. MIX jack (36).
2. Rotate the FUNCTION selector (5) in the "TAPE" position, and let the MIC selector (29) in the LINE IN & EXT MIC position.
3. Follow steps 2,3 and 4 from "Recording from built-in radio broadcast" paragraph above.
4. The unit is now recording through the external microphone.

NOTE: To avoid "HOWLING" it may be necessary to adjust the MIC. MIX VOLUME controls (10) and do not place microphone too close to the speakers.

Recording from stereo player

1. Follow steps from "PHONO OPERATION" as described earlier.
2. Follow steps 2,3, and 4 from "Recording from built-in radio broadcast" paragraph above.
3. The unit is now recording material from the stereo player.

Recording from external sound source

1. Rotate the FUNCTION selector (5) in the "TAPE" position, and let the MIC selector (29) in the "LINE IN & EXT MIC" position.
2. Connect optional REC/PB cord from output of your tuner, amplifier, tape recorder of other source to the EXT. LINE-IN jacks (35) of the unit.
3. Follow steps 2,3, and 4 from "Recording from built-in radio broadcast" paragraph above.
4. The unit is now recording through the optional REC/PB cord from output of external sound source.

Recording from Telephone (Where permitted by law)

1. Connect the suction cup of the telephone pick-up (not supplied) to the telephone case and connect the pick-up lead to the EXT. MIC. MIX jack (36) of the unit.

NOTE: For the connection of an battery cord, follow the instructions provided with the cord.

BATTERIES-CHARGING OPERATION

1. Remove the lid of the BATTERY/POWER CORD COMPARTMENT (39) by pressing the tabs down and pulling the lid forward.
2. Plug the AC power cord into an AC outlet.
3. Insert the rechargeable batteries (Not included) as indicated by the markings inside the BATTERY/POWER CORD COMPARTMENT (39).
4. Place the BATTERIES-CHARGING switch (8) in the 'ON' position.
5. This unit is now charging the rundown batteries.

GRAPHIC EQUALIZER CONTROLS

By means of five independent frequency (80/250/800/2.5K/8KHz) controls with up to ± 10 dB adjustment, you can get your favorite sound shape flexibly. Typical frequency responses adjusted with the frequency controls are shown in fig. "Flat" response is obtained by setting the controls to the "0" positions.

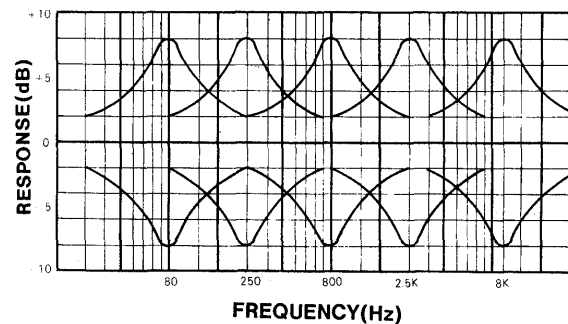

RADIO OPERATION

1. Select power supply using either AC or DC source as described earlier.
2. Switch the unit on by depressing the POWER switch (1) placing it in the 'ON' position. The 'STAND BY' indicators will glow indicating unit is on, and the scale indicator which is located on the pointer will glow in orange color.
3. Rotate the VOLUME, BALANCE, and GRAPHIC EQUALIZER controls (2,4,7) placing them in mid-range position.
4. Rotate the FUNCTION selector (5) in the 'RADIO' position.
5. Select your desired waveband by rotating the BAND selector (15) in either FM, AM, SW₁ or SW₂.
6. Select the desired station on the dial display by rotating the TUNING knob (13).
7. Re-adjust the VOLUME, BALANCE, and GRAPHIC EQUALIZER controls, (2,4,7) to suit personal preference.
8. To switch the unit off, depress and release the POWER switch (1) placing it in the 'OFF' position.

NOTE: 1. For AM reception, slight rotation of entire unit may improve reception. For FM, FM-STEREO and SW reception, be sure to fully extend the TELESCOPIC ANTENNAS(11) and adjust its angle for optimum reception.

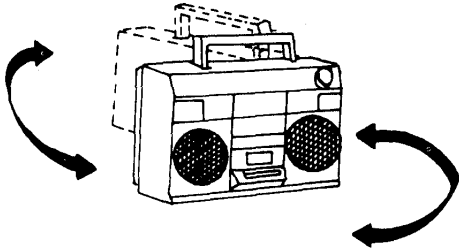

3. You can monitor through the speakers regardless of recording level, adjust the VOLUME, BALANCE and GRAPHIC EQUALIZER controls (2,4,7) for your desired sound.
4. When recording, if you wish to adjust volume by the REC. VOLUME control (12), then let the A.L.C. button (16) in the 'OFF' position.

Recording from built-in radio broadcast

1. Select the desired broadcast as described earlier in 'Radio Operation' paragraph.
2. Insert a blank tape in the cassette compartment lid guides. Ensure open end of the cassette tape exposing the tape is facing downward. Close the cassette compartment lid firmly.
3. Place the TAPE selector (30) either in the 'NORMAL' or 'METAL' position depending on the type of cassette tape formulation being used.
4. Depress and lock the RECORD button (27) in the meantime, the PLAY button (25) will be locked automatically-specially designed with 'One Touch Recording' function.
5. This unit is now recording the broadcast material.

NOTE: 1. Please note again, if you let the A. L. C. button (16) in the 'ON' position, the VOLUME, BALANCE, GRAPHIC EQUALIZER and REC. VOLUME controls (2,4,7,12) will have no effect on actual recording.

Recording from built-in condenser microphone

1. Rotate the FUNCTION selector (5) in the 'TAPE' position and let the MIC selector (29) in the 'INT MIC' position.
2. Follow steps 2,3 and 4 from 'Recording from built-in radio broadcast' paragraph above.
3. The unit is now recording through the BUILT-IN CONDENSER MICROPHONE (3).

NOTE: The built-in condenser microphone used in this unit have very high sensitivity. Therefore, it is not necessary to place the radio cassette recorder close to the source of sound.

PHONO OPERATION

1. Connect an optionally available player fitted with a stereo magnetic cartridge to the PHONO INPUT jacks (37).
2. Follow steps 1-3 of 'Radio Operation' paragraph.
3. Rotate the FUNCTION selector (5) in the "PHONO" position.
4. Operate your player as per instruction included with the player unit.
5. Re-adjust the VOLUME, BALANCE, and GRAPHIC EQUALIZER controls (2.4.7) as desired.
6. When unit is no longer being used, ensure to depress and release the POWER switch (1) placing unit in 'OFF' position.

RECORDING

This unit can be used to make recordings on to cassette tape from:

- a. Built-in radio broadcasts
- b. Built-in condenser microphone.
- c. Optionally available extension microphone (through EXT. MIC. MIX jack (36)).
- d. Optionally available stereo player (through PHONO INPUT jacks (37)).
- e. Optionally available external sound source (through EXT. LINE IN jacks (35)).
- f. Optionally available telephone pick-up.
- g. Optionally available playback tape.

NOTE: 1. Only TAPE B can proceed recording. When recording be sure the accidental record prevention tab has **not** been removed from rear of cassette tape, otherwise, recording cannot proceed (see the section on 'Record Prevent Device'). Do **NOT** use excessive force to press the RECORD button (27).

2. This unit features an Auto Level Control (A.L.C.) circuit, the VOLUME, BALANCE and GRAPHIC EQUALIZER controls (2.4.7) will have no effect on recording.

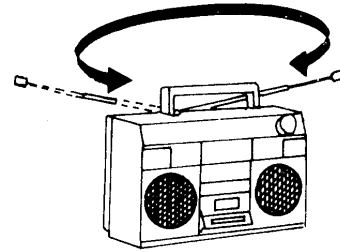

2. Many FM stations broadcast their programmes in stereo. When tuning in on stereo broadcasts, the FM-STEREO indicator (6) which is located on the pointer will glow in Red color automatically.
3. In case of weak FM-STEREO signal reception, placing the MODE selector (31) in 'MONO' position may improve reception.

CASSETTE OPERATION

1. Follow steps 1-3 of 'Radio Operation' paragraph.
2. Rotate the FUNCTION selector (5) in the 'TAPE' position.
3. Press the TAPE selector (30) either in the 'NORMAL' or 'METAL' position depending on the type of cassette tape formulation being used.

Since this unit features a 'DOUBLE CASSETTE DECK' tape mechanism, please select either TAPE A or TAPE B for tape playback.

If you use TAPE A, go on the following operation procedures.

4. Insert a pre-recorded cassette tape in the TAPE A CASSETTE COMPARTMENT (17) as figure, and ensure the tape is wound onto the outside spool. This unit is now playing the pre-recorded tape material.

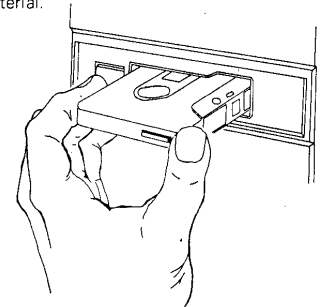

5. Adjust the VOLUME, BALANCE and GRAPHIC EQUALIZER controls (2,4,7) as desired.
6. If you wish to fast forward tape, half depress the F.FWD/EJECT button (18).
7. Depress the F.FWD/EJECT button (18) once again to remove playing cassette tape.
8. When unit is no longer being used, ensure to depress and release the POWER switch (1) placing unit in 'OFF' position.

If you use TAPE B, follow the operation procedures as under.

4. Depress the STOP/EJECT button (22) to open the cassette compartment lid.
5. Insert a pre-recorded cassette tape in the cassette compartment lid guides. Ensure open end of the cassette tape exposing the tape is facing downward and the tape is wound onto the left spool. Close the cassette compartment lid firmly.

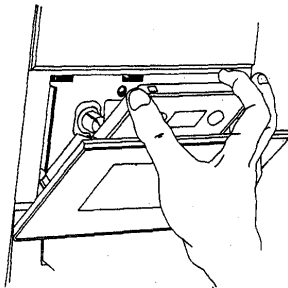

6. Depress the PLAY button (25).
7. Adjust the VOLUME, BALANCE and GRAPHIC EQUALIZER controls (2,4,7) as desired.

8. To stop playing cassette tape, depress the STOP/EJECT button (22). To remove cassette, depress the STOP/EJECT (22) once again to open cassette compartment lid.
9. If you wish to rewind tape, depress the REWIND button (24).
10. If you wish to fast forward tape, depress the FAST FORWARD button (23).
11. When unit is no longer being used, ensure to depress and release the POWER switch (1) placing unit in 'OFF' position.

- NOTE:**
1. When any button is in depressed position, before pressing any other button, always be sure to press STOP/EJECT button (22) first to release previous operation button. If this is not done, damage may result to both deck mechanism and cassette tape.
 2. This cassette mechanism is designed with a built-in tape end sensor which will automatically cancel any of the four cassette functions (Play, Record, Fast Forward and Rewind) when the tape reaches the end of its travel in either direction.
 3. This unit's mechanism also includes a PAUSE button (21) which, when pressed, instantly stops the tape's movement in the 'PLAY' and 'RECORD' modes of operation. When released, the tape movement resumes instantly. Please Note: even though the tape will be stationary when the PAUSE button (21) is depressed, the mechanism's motor is still running and power is being consumed. Therefore, do not leave the unit with pause button depressed for long periods as this will drain the batteries (in DC operation) almost as fast as if in actual play or Record modes.

TAPE COUNTER AND RESET BUTTON

The 3-digit counter built into this unit permits instant location of any point on a tape. When recording at the beginning of a cassette tape, press the reset button to set the counter numerals to "000". As you record various selections, make a note of the counter number as the beginning of each selection. To playback a particular selection, use the fast forward or rewind mode to move the tape until the counter registers the previously noted number for that selection.

NOTE: This applies to TAPE B cassette mechanism only.