

Nikon

DIGITAL CAMERA

COOLPIX L100

User's Manual

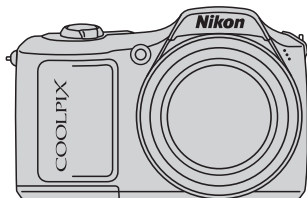

En

Trademark Information

- Microsoft, Windows and Windows Vista are either registered trademarks or trademarks of Microsoft Corporation in the United States and/or other countries.
- Macintosh, Mac OS, and QuickTime are trademarks of Apple Inc.
- Adobe and Acrobat are registered trademarks of Adobe Systems Inc.
- The SD logo is a trademark of the SD Card Association.
- PictBridge is a trademark.
- All other trade names mentioned in this manual or the other documentation provided with your Nikon product are trademarks or registered trademarks of their respective holders.

Introduction

First Steps



Basic Photography and Playback: Easy Auto Mode



Shooting in the Auto Mode



Shooting Suited for the Scene



Shooting continuously at high speed (Sport Continuous)



Shooting in the High Sensitivity Mode



Capturing Smiling Faces Automatically



More on Playback



Movies

Connecting to Televisions, Computers and Printers

MENU

Shooting, Playback and Setup Menus

Technical Notes

For Your Safety

To prevent damage to your Nikon product or injury to yourself or to others, read the following safety precautions in their entirety before using this equipment. Keep these safety instructions where all those who use the product will read them. The consequences that could result from failure to observe the precautions listed in this section are indicated by the following symbol:



This icon marks warnings, information that should be read before using this Nikon product, to prevent possible injury.

WARNINGS

Turn off in the event of malfunction

Should you notice smoke or an unusual smell coming from the camera or AC adapter, unplug the AC adapter and remove the battery immediately, taking care to avoid burns. Continued operation could result in injury. After removing or disconnecting the power source, take the equipment to a Nikon-authorized service representative for inspection.

Do not disassemble

Touching the internal parts of the camera or AC adapter could result in injury. Repairs should be performed only by qualified technicians. Should the camera or AC adapter break open as the result of a fall or other accident, take the product to a Nikon-authorized service representative for inspection, after unplugging the product and/or removing the battery.

Do not use the camera or AC adapter in the presence of flammable gas

Do not use electronic equipment in the presence of flammable gas, as this could result in explosion or fire.

Handle the camera strap with care

Never place the strap around the neck of an infant or child.

Keep out of reach of children

Particular care should be taken to prevent infants from putting the battery or other small parts into their mouths.

Observe caution when handling the battery

The battery may leak or explode if improperly handled. Observe the following precautions when handling the battery for use in this product:

- Before replacing the battery, turn the product off. If you are using the AC adapter, be sure it is unplugged.
- Do not combine old and new batteries or batteries of different makes or types.
- Insert batteries in the correct orientation.
- Do not short or disassemble the battery or attempt to remove or break the battery insulation or casing.
- Do not expose the battery to flame or to excessive heat.
- Do not immerse in or expose to water.
- Do not transport or store with metal objects such as necklaces or hairpins.
- Batteries are prone to leakage when fully discharged. To avoid damage to the product, be sure to remove the battery when no charge remains.
- Discontinue use immediately should you notice any change in the battery, such as discoloration or deformation.
- If liquid from the damaged battery comes in contact with clothing or skin, rinse immediately with plenty of water.

Use appropriate cables

When connecting cables to the input and output jacks, use only the cables provided or sold by Nikon for the purpose, to maintain compliance with product regulations.

Handle moving parts with care

Be careful that your fingers or other objects are not pinched by the lens cover or other moving parts.

CD-ROMs

The CD-ROMs supplied with this device should not be played back on audio CD equipment. Playing CD-ROMs on an audio CD player could cause hearing loss or damage the equipment.

Observe caution when using the flash

Using the flash close to your subject's eyes could cause temporary visual impairment. Particular care should be observed if photographing infants, when the flash should be no less than 1 m (3 ft. 4 in.) from the subject.

Do not operate the flash with the flash window touching a person or object

Failure to observe this precaution could result in burns or fire.

 **Avoid contact with liquid crystal**

Should the monitor break, care should be taken to avoid injury caused by broken glass and to prevent liquid crystal from the monitor touching the skin or entering the eyes or mouth.

Notices

Notice for Customers in the U.S.A.

Federal Communications Commission (FCC) Radio Frequency Interference Statement

This equipment has been tested and found to comply with the limits for a Class B digital device, pursuant to Part 15 of the FCC rules. These limits are designed to provide reasonable protection against harmful interference in a residential installation. This equipment generates, uses, and can radiate radio frequency energy and, if not installed and used in accordance with the instructions, may cause harmful interference to radio communications. However, there is no guarantee that interference will not occur in a particular installation. If this equipment does cause harmful interference to radio or television reception, which can be determined by turning the equipment off and on, the user is encouraged to try to correct the interference by one or more of the following measures:

- Reorient or relocate the receiving antenna.
- Increase the separation between the equipment and receiver.
- Connect the equipment into an outlet on a circuit different from that to which the receiver is connected.
- Consult the dealer or an experienced radio/television technician for help.



CAUTIONS

Modifications

The FCC requires the user to be notified that any changes or modifications made to this device that are not expressly approved by Nikon Corporation may void the user's authority to operate the equipment.

Interface Cables

Use the interface cables sold or provided by Nikon for your equipment. Using other interface cables may exceed the limits of Class B Part 15 of the FCC rules.

Notice for customers in the State of California

WARNING

Handling the cord on this product will expose you to lead, a chemical known to the State of California to cause birth defects or other reproductive harm.

Wash hands after handling.

Nikon Inc.,
1300 Walt Whitman Road
Melville, New York 11747-3064
USA
Tel: 631-547-4200

Notice for customers in Canada

CAUTION

This Class B digital apparatus complies with Canadian ICES-003.

ATTENTION

Cet appareil numérique de la classe B est conforme à la norme NMB-003 du Canada.

Symbol for Separate Collection in European Countries

This symbol indicates that this product is to be collected separately.



The following apply only to users in European countries:

- This product is designated for separate collection at an appropriate collection point. Do not dispose of as household waste.
- For more information, contact the retailer or the local authorities in charge of waste management.

This symbol on the battery indicates that the battery is to be collected separately.









The following apply only to users in European countries:

- All batteries, whether marked with this symbol or not, are designated for separate collection at an appropriate collection point. Do not dispose of as household waste.
- For more information, contact the retailer or the local authorities in charge of waste management.

Table of Contents

For Your Safety	ii
WARNINGS	ii
Notices.....	v
Introduction	1
About This Manual	1
Information and Precautions	2
Parts of the Camera	4
The Camera Body	4
Raising and Lowering the Built-in Flash	6
Attaching the Camera Strap and Lens Cap	7
The Monitor	8
Basic Operations.....	10
📷 (shooting mode) button	10
▶ (playback) button	10
The Multi Selector.....	11
MENU button	12
Switching Between Tabs.....	12
Help Displays.....	13
About the Shutter-release Button.....	13
First Steps	14
Inserting the Batteries	14
Applicable Batteries	14
Turning On and Off the Camera.....	14
Setting Display Language, Date and Time	16
Inserting Memory Cards	18
Removing Memory Cards.....	19
📷 Basic Photography and Playback: Easy Auto Mode	20
Step 1 Turn the Camera On and Select 📷 (Easy Auto) Mode	20
Indicators Displayed in 📷 (Easy auto) Mode.....	21
Step 2 Frame a Picture	22
Using the Zoom.....	23
Step 3 Focus and Shoot	24
Step 4 Viewing and Deleting Pictures	26
Viewing Pictures (Playback Mode).....	26
Deleting Pictures.....	26
Easy auto mode	28

Table of Contents

 Auto Mode.....	29
Shooting in the Auto Mode.....	29
Using the Flash.....	30
Setting the Flash Mode.....	30
Taking Pictures with the Self-timer	33
Macro Mode	34
Exposure Compensation	35
<hr/>	
 Shooting Suited for the Scene.....	36
Using the Scene Mode	36
Setting the Scene Mode.....	36
Features	37
Taking Pictures for Food Mode	44
Taking Pictures for a Panorama	46
<hr/>	
 Shooting continuously at high speed (Sport Continuous).....	48
Shooting in the Sport Continuous Mode	48
Sport Continuous Menu.....	49
<hr/>	
 High Sensitivity Mode.....	50
Shooting in the High Sensitivity Mode	50
<hr/>	
 Capturing Smiling Faces Automatically.....	52
Using the Smile Mode	52
<hr/>	
 More on Playback.....	54
Viewing Multiple Pictures: Thumbnail Playback	54
Calendar Display.....	55
Taking a Closer Look: Playback Zoom	56
Editing Pictures.....	57
Enhancing Brightness and Contrast: D-Lighting.....	58
Creating a Cropped Copy: Crop	59
Resizing Pictures: Small Picture	60
<hr/>	
 Movies	61
Recording Movies	61
The Movie Menu.....	62
Selecting Movie Options.....	62
Movie Playback.....	63





























Deleting Movie Files.....	63
Connecting to Televisions, Computers and Printers	64
Connecting to a TV	64
Connecting to a Computer.....	65
Before Connecting the Camera.....	65
Transferring Pictures from a Camera to a Computer	66
Connecting to a Printer.....	69
Connecting the Camera and Printer.....	70
Printing Pictures One at a Time	71
Printing Multiple Pictures	72
Creating a DPOF Print Order: Print Set.....	75
MENU Shooting, Playback and Setup Menus	77
Shooting Options: The Shooting Menu	77
Displaying the Shooting Menu	78
 Image Mode	79
 White Balance	81
 Continuous	83
 Color Options.....	84
 Distortion Control.....	85
Camera Settings that Cannot Be Set at the Same Time	86
Playback Options: The Playback Menu	87
Displaying the Playback Menu	87
 Slide Show	89
 Delete.....	90
Basic Camera Setup: The Setup Menu	91
Displaying the Setup Menu.....	92
 Menu.....	94
 Welcome Screen	95
 Date.....	96
 Monitor Settings	99
 Date Imprint.....	101
 Vibration reduction	102
 Motion Detection	103
 AF Assist	104
 Sound Settings	104
 Auto Off.....	105
 Format Memory/  Format Card	106
 Language.....	107
 Video Mode	107
 Blink Warning.....	108

Table of Contents

 Reset All	109
 Battery Type	111
 Protect	111
 Rotate Image	112
 Copy	113
 Firmware Version	114
<hr/>	
Technical Notes	115
Optional Accessories	115
Approved Memory Cards	115
Image File and Folder Names	116
Caring for the Camera	117
Cleaning	118
Storage	119
Error Messages	120
Troubleshooting	123
Specifications	128
Supported Standards	131
Index	132

About This Manual

Thank you for your purchase of a Nikon COOLPIX L100 digital camera. This manual was written to help you enjoy taking pictures with your Nikon digital camera. Read this manual thoroughly before use, and keep it where all those who use the product will read it.

Symbols and Conventions

To make it easier to find the information you need, the following symbols and conventions are used:



This icon marks cautions, information that should be read before use, to prevent damage to the camera.



This icon marks tips, additional information that may be helpful when using the camera.



This icon marks notes, information that should be read before using the camera.



This icon indicates that more information is available elsewhere in this manual or in the *Quick Start Guide*.

Notations

- A Secure Digital (SD) memory card is referred to as a “memory card”.
- The setting at the time of purchase is referred to as the “default setting”.
- The names of menu items displayed in the camera monitor, and the names of buttons or messages displayed in the computer monitor appear in bold.

Screen Samples

In this manual, images are sometimes omitted from monitor display samples so that monitor indicators can be more clearly shown.

Illustrations and Screen Display

Illustrations and text displays shown in this manual may differ from actual display.



Memory Cards

Pictures taken with this camera can be stored in the camera’s internal memory or on removable memory cards. If a memory card is inserted, all new pictures will be stored on the memory card and delete, playback and format operations will apply only to the pictures on the memory card. The memory card must be removed before the internal memory can be formatted or used to store, delete or view pictures.

Information and Precautions

Life-Long Learning

As part of Nikon's "Life-Long Learning" commitment to ongoing product support and education, continually updated information is available online at the following sites:

- For users in the U.S.A.: <http://www.nikonusa.com/>
- For users in Europe and Africa: <http://www.europe-nikon.com/support/>
- For users in Asia, Oceania, and the Middle East: <http://www.nikon-asia.com/>

Visit these sites to keep up-to-date with the latest product information, tips, answers to frequently asked questions (FAQs), and general advice on digital imaging and photography. Additional information may be available from the Nikon representative in your area. See the URL below for contact information:

<http://imaging.nikon.com/>

Use Only Nikon Brand Electronic Accessories

Nikon COOLPIX cameras are designed to the highest standards and include complex electronic circuitry. Only Nikon brand electronic accessories (including AC adapters) certified by Nikon specifically for use with this Nikon digital camera are engineered and proven to operate within the operational and safety requirements of this electronic circuitry.

THE USE OF NON-NIKON ELECTRONIC ACCESSORIES COULD DAMAGE THE CAMERA AND MAY VOID YOUR NIKON WARRANTY.

For more information about Nikon brand accessories, contact a local authorized Nikon dealer.

Before Taking Important Pictures

Before taking pictures on important occasions (such as at weddings or before taking the camera on a trip), take a test shot to ensure that the camera is functioning normally. Nikon will not be held liable for damages or lost profits that may result from product malfunction.

About the Manuals

- No part of the manuals included with this product may be reproduced, transmitted, transcribed, stored in a retrieval system, or translated into any language in any form, by any means, without Nikon's prior written permission.
- Nikon reserves the right to change the specifications of the hardware and software described in these manuals at any time and without prior notice.
- Nikon will not be held liable for any damages resulting from the use of this product.
- While every effort was made to ensure that the information in these manuals is accurate and complete, we would appreciate it were you to bring any errors or omissions to the attention of the Nikon representative in your area (address provided separately).

Notice Concerning Prohibition of Copying or Reproduction

Note that simply being in possession of material that was digitally copied or reproduced by means of a scanner, digital camera or other device may be punishable by law.

- **Items prohibited by law from being copied or reproduced**

Do not copy or reproduce paper money, coins, securities, government bonds or local government bonds, even if such copies or reproductions are stamped "Sample". The copying or reproduction of paper money, coins, or securities which are circulated in a foreign country is prohibited. Unless the prior permission of the government was obtained, the copying or reproduction of unused postage stamps or post cards issued by the government is prohibited. The copying or reproduction of stamps issued by the government and of certified documents stipulated by law is prohibited.

- **Cautions on certain copies and reproductions**

The government has issued cautions on copies or reproductions of securities issued by private companies (shares, bills, checks, gift certificates, etc.), commuter passes or coupon tickets, except when a minimum of necessary copies are to be provided for business use by a company. Also, do not copy or reproduce passports issued by the government, licenses issued by public agencies and private groups, ID cards and tickets, such as passes and meal coupons.

- **Comply with copyright notices**

The copying or reproduction of copyrighted creative works such as books, music, paintings, woodcut prints, maps, drawings, movies and photographs is governed by national and international copyright laws. Do not use this product for the purpose of making illegal copies or to infringe copyright laws.

Disposing of Data Storage Devices



Please note that deleting images or formatting data storage devices such as memory cards or built-in camera memory does not completely erase the original image data. Deleted files can sometimes be recovered from discarded storage devices using commercially available software, potentially resulting in the malicious use of personal image data. Ensuring the privacy of such data is the user's responsibility.

Before discarding a data storage device or transferring ownership to another person, erase all data using commercial deletion software, or format the device and then completely refill it with images containing no private information (for example, pictures of empty sky). Be sure to also replace any pictures selected for the welcome screen (📖 95). Care should be taken to avoid injury or damage to property when physically destroying data storage devices.

Parts of the Camera

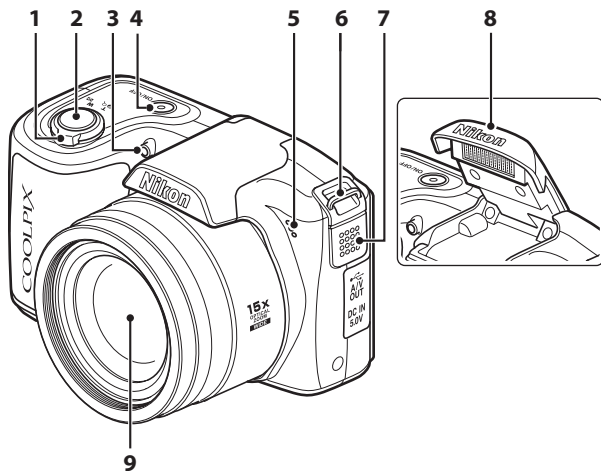
The Camera Body



1	Zoom control	23
	W : wide	23
	T : tele	23
	 : thumbnail playback	54
	 : playback zoom	56
	 : help	13
2	Shutter-release button	24
3	Self-timer lamp	33
	AF-assist illuminator	25, 104

4	Power switch/Power-on lamp	20, 105
5	Built-in microphone	61
6	Eyelet for camera strap	7
7	Speaker	63
8	Built-in flash	6, 30
9	Lens	118, 128

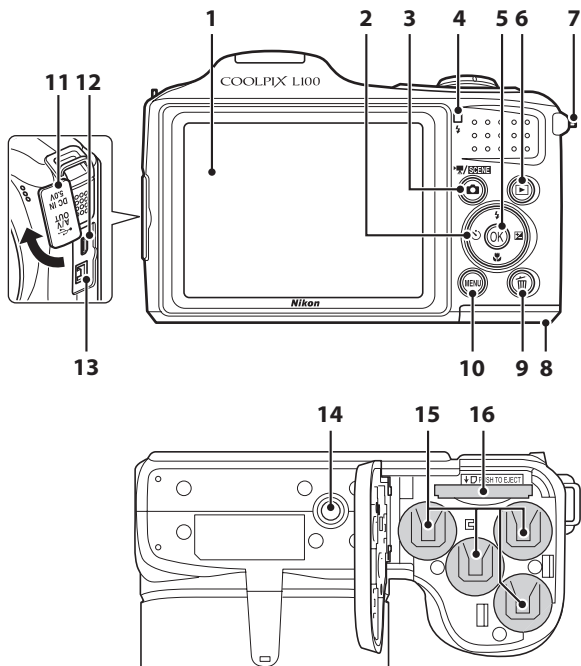

1	Monitor	8	9	(delete) button	26, 27, 63
2	Multi selector	11	10	MENU button	12, 62, 78, 87, 92
3	(shooting mode) button	10	11	Pin cover	64, 66, 70
4	Flash lamp	31	12	Cable connector	64, 66, 70
5	(apply selection) button	11	13	DC input connector (for AC adapter available separately from Nikon)	15, 115
6	(playback) button	10, 26	14	Tripod socket	
7	Eyelet for camera strap	7	15	Battery-chamber	14
8	Battery-chamber/ memory card slot cover	14, 18	16	Memory card slot	18

Raising and Lowering the Built-in Flash

Raising the Built-in Flash.

- See “Using the Flash” (📖 30) for more information about flash settings.

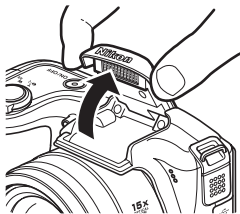

Lowering the Built-in Flash.

- Push the built-in flash down gently.
- When not using the flash, lower the built-in flash.

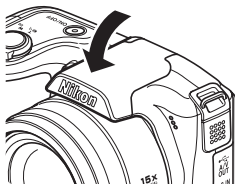

Attaching the Camera Strap and Lens Cap

Attach the lens cap to the camera strap, and then attach the strap to the camera (at two places).

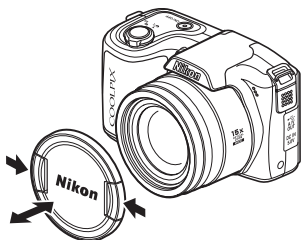
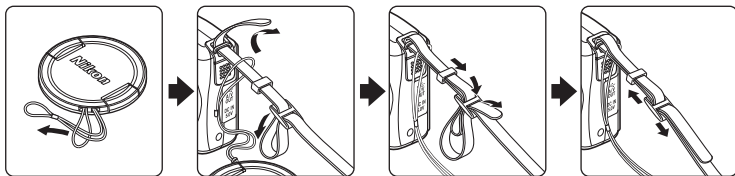
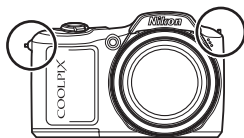

✓ Lens Cap

- Remove the lens cap before you shoot a picture.
- At times when you will not be shooting pictures such as when the power is off or while you are carrying the camera, attach the lens cap to the camera to protect the lens.

The Monitor

The following indicators may appear in the monitor during shooting and playback (actual display varies with current camera settings).

The indicators and photo info displayed during shooting and playback will turn off after a few seconds (📖 99).

Shooting

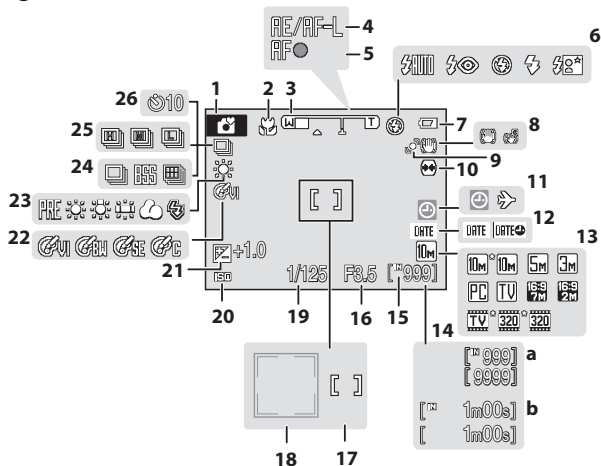

1	Shooting mode * ... 20, 29, 36, 48, 50, 52, 61
2	Macro mode 34
3	Zoom indicator 23, 34
4	AE/AF-L indicator 47
5	Focus indicator 24
6	Flash mode 30
7	Battery level indicator 20
8	Vibration reduction icon (still pictures) ... 21, 102
9	Electronic VR icon (movies) 61, 102
10	Motion detection icon 21, 103
11	"Date not set" indicator 120
12	Time zone indicator 96
13	Date imprint 101
14	Image mode 79
15	Movie options 62

16	Number of exposures remaining (still pictures) 20
17	Movie length 61
18	Internal memory indicator 21
19	Aperture 24
20	Focus area 22, 24
21	Focus area (Face Priority) 22, 24
22	Shutter speed 24
23	ISO sensitivity 31
24	Exposure compensation value 35
25	Color options 84
26	White balance mode 81
	Continuous shooting mode 83
	Type of sport continuous mode 48
	Self-timer indicator 33

* Differs according to the current shooting mode. Refer to the sections on each mode for details.

Playback

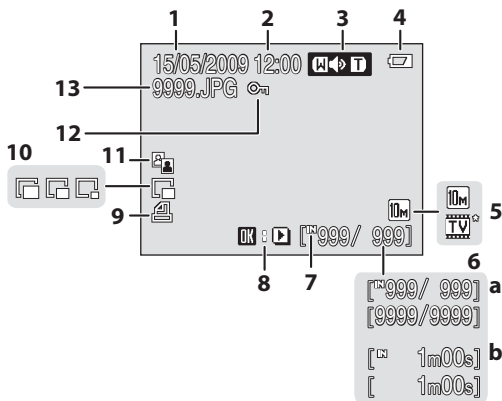



1	Date of recording	16	7	Internal memory indicator	26
2	Time of recording	16	8	Movie playback indicator	63
3	Volume	63	9	Print-order icon	75
4	Battery level indicator	20	10	Small picture	60
5	Image mode*	79	11	D-Lighting icon	58
	Movie options*	62	12	Protect icon	111
6	a Current frame number/ total number of frames	26	13	File number and type	116
	b Movie length	63			

* The displayed icons vary with the settings in shooting mode.

Basic Operations

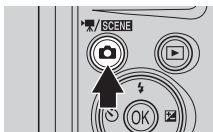
(shooting mode) button







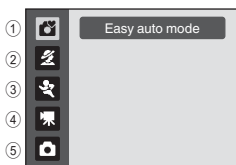

- Press  in playback mode to enter shooting mode.
- Press  in shooting mode to display the shooting-mode selection menu.

Shooting-mode Selection Menu

In the shooting-mode selection menu, use the multi selector to select the shooting mode.





- ①  Easy auto mode (📖 20)
- ②  Scene (📖 36)*
- ③  Sport continuous (📖 48),  High sensitivity (📖 50),  Smile (📖 52)*
- ④  Movie (📖 61)
- ⑤  Auto mode (📖 29)

* The displayed icons vary depending on the last mode selected.

While the shooting-mode selection menu is displayed, you can return to shooting mode by pressing  again.

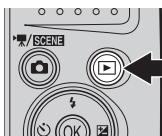
(playback) button





- During shooting mode, the camera enters the playback mode when  is pressed.
- If the camera is turned off, hold down  to turn the camera on in playback mode.

The Multi Selector

This section describes standard uses of the multi selector to select modes, select menu options and to apply selection.

For Shooting

Display  (flash mode) menu (📖 30)/select the item above.

Display  (self-timer) menu (📖 33).

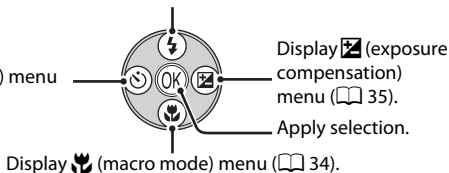

For Playback

Display the previous picture.

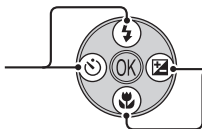

Display the next picture.

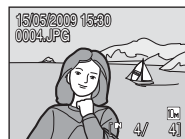

For the Menu Screen

Select the item above.

Select the item to the left/return to the previous screen.

Select the item below.

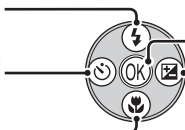



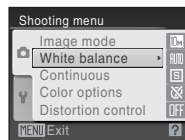

Apply selection (Go to the next screen).

Select the item to the right/go to the next screen (apply selection).



Notes on the Multi Selector

In this manual, , ,  and  are used in some cases for indicating the up, down, left and right operating parts of the multi selector.

MENU button

Press **MENU** to display the menu for the selected mode.

- Use the multi selector to apply settings (📖 11).
- Select the tab on the left to display the setup menu.
- To exit the menu display, press **MENU** again.

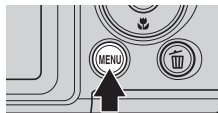

Upper tab: Menus available for the current mode are displayed.

Lower tab: Display the setup menu.

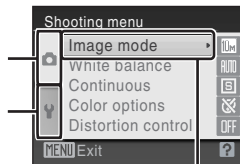

The selected option.

Displayed when the menu contains two or more pages.

Displayed when there are more previous menu items.

Displayed when there are one or more menu items to follow.

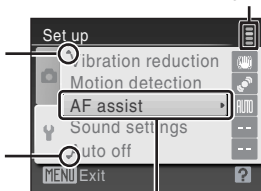

Press **OK** or the multi selector **▶** to proceed to the next set of options.

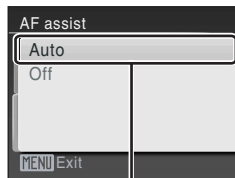

Press **OK** or the multi selector **▶** to apply selection.

Switching Between Tabs

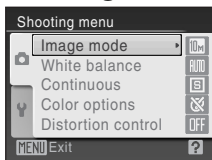

Press the multi selector **◀** to highlight the tab.

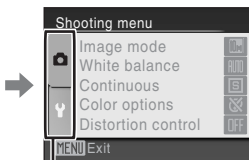

Press the multi selector **▲▼** to select a tab and press **OK** or **▶**.

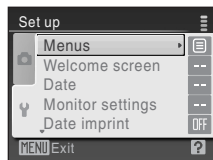

The selected menu will be displayed.

To display the tabs, press the multi selector **◀** while the menu is displayed in the following modes.

- 12 • Easy auto mode, scene mode, smile mode, movie mode

Help Displays

Rotate the zoom control to **T** (?) when **?** (?) is displayed at the lower right of the menu screen to view a description of the currently selected menu option.

To return to the original menu, rotate the zoom control to **T** (?) again.

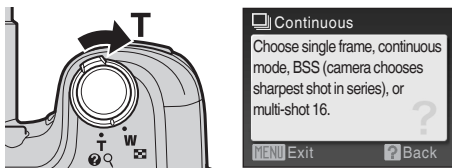

About the Shutter-release Button

The camera features a two-stage shutter-release button. To set focus and exposure, press the shutter-release button halfway, stopping when you feel resistance. Focus and exposure lock while the shutter-release button is held in this position. To release the shutter and take a picture, press the shutter-release button the rest of the way down. Do not use force when pressing the shutter-release button, as this may result in camera shake and blurred pictures.

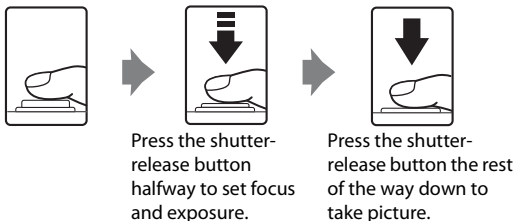

Inserting the Batteries

1 Open the battery-chamber/memory card slot cover.

- Before opening the battery-chamber/memory card slot cover, hold the camera upside down to prevent the batteries from falling out.

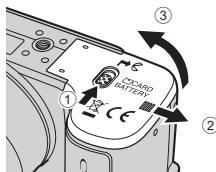

2 Inserting the Batteries

- Insert the batteries correctly as shown at right.

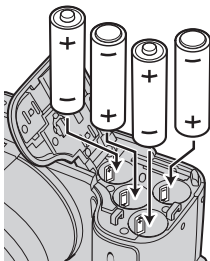

3 Close the battery-chamber/memory card slot cover.

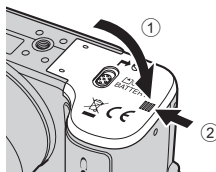

Applicable Batteries

This camera uses the following R6/AA-size batteries.

- Four LR6/L40 alkaline batteries (batteries supplied)
- Four FR6/L91 lithium batteries

Rechargeable batteries cannot be used.

Turning On and Off the Camera

After removing the lens cap, press the power switch to turn on the camera. The power-on lamp (green) will light for a moment, then the monitor will turn on. Press the power switch again to turn the camera off. When the camera turns off, both the power-on lamp and monitor will turn off.

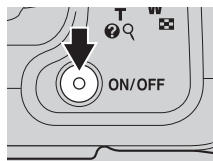

If the camera is turned off, hold down  to turn the camera on in playback mode.

✓ Removing the Batteries

Confirm the power-on lamp and the monitor are off and open the battery-chamber/ memory card slot cover.

✓ Additional Precautions Regarding Batteries

- Read and follow the warnings and cautions (📖 iii, 118).
- Be sure to read and follow the warnings for the battery on page iii and the section, "The Battery" (📖 118), before using the battery.
- Do not combine old and new batteries or batteries of different makes or types.
- Batteries with the following defects cannot be used:

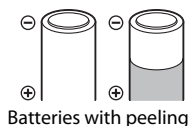

Batteries with peeling

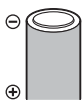

Batteries with insulation that does not cover the area around the negative terminal.

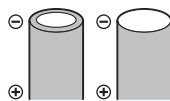

Batteries with a flat negative terminal

✓ Battery Type

To improve battery performance, select the type of battery currently inserted in the camera in the setup menu. The default setting is the type of battery supplied with purchase. When any other type of battery is used, turn the camera on and change the setting (📖 111).

✍ Alkaline Batteries

Performance of alkaline batteries may vary greatly depending on the manufacturer. Choose a reliable brand.

✍ Alternative Power Resources

To power the camera continuously for extended periods, use an AC Adapter EH-67 (available separately) (📖 115). **Do not, under any circumstances, use another make or model of AC adapter.** Failure to observe this precaution could result in overheating or in damage to the camera.

✍ Auto Power Off in Shooting Mode (Standby Mode)

If no operations are performed for about 30 seconds (default setting), the monitor turns off and the camera enters standby mode. After a further three minutes, the Auto off function will turn the camera off automatically.

While the monitor is off during standby mode, it will turn on again when the power switch or shutter-release button is pressed.

The amount of time that passes before the camera enters standby mode is determined by the **Auto off** setting (📖 105) in the setup menu (📖 91).

✍ Lens Error

If **Lens Error** is displayed, make sure that the lens cap has been removed, then turn the camera on again.

Setting Display Language, Date and Time

A language-selection and date setting screen for the internal clock is displayed the first time the camera is turned on.

1 Press the power switch to turn on the camera.

The power-on lamp (green) will light for a moment and the monitor will turn on.

Remove the lens cap.

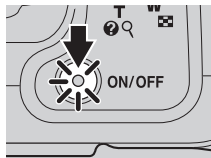

2 Use the multi selector to choose the desired language and press **OK**.

For information on using the multi selector, see "The Multi Selector" (11).



3 Choose **Yes** and press **OK**.

If **No** is selected, the date and time will not be set.

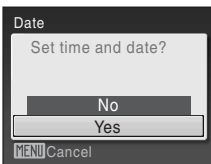

4 Press **◀** or **▶** to select your home time zone (city name) (98) and press **OK**.

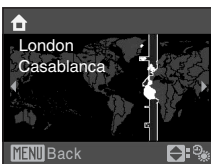

Daylight Saving Time

To use the camera in an area where daylight saving time is in effect, press **▲** on the home time zone in Step 4 to set the daylight saving time to on.

When the daylight saving time setting is selected, the  mark appears on the top of the monitor. To release the daylight saving time setting, press **▼**.

Daylight saving time

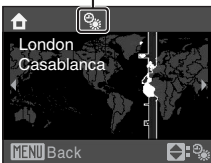

5 Change the date and time.

- Press ▲ or ▼ to edit the highlighted item.
- Press ► to move the cursor in the following order.
D -> M -> Y -> Hour -> Minute -> D M Y
- Press ◀ to return to the previous item.

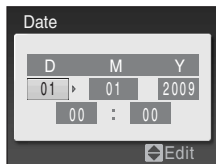
**6** Choose the order in which the day, month and year are displayed and press **OK** or ►.

- The settings are applied.

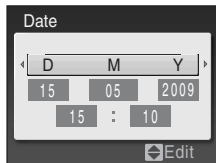
**7** Make sure that the lens cap has been removed, then press **Q**.

- The shooting-mode selection menu will be displayed.

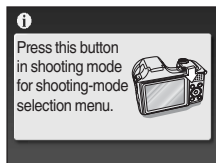
**8** When **Easy auto mode** is displayed, press **OK**.

- The camera enters the shooting mode and you can take pictures in Easy auto mode (📖 20).
- Press the multi selector ▲ or ▼ before **OK**, to switch to another shooting mode. See "Shooting in the Auto Mode" (📖 29), "Using the Scene Mode" (📖 36), "Shooting in the Sport Continuous Mode" (📖 48), "Shooting in the High Sensitivity Mode" (📖 50), "Using the Smile Mode" (📖 52), or "Recording Movies" (📖 61) for more information.

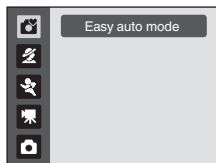
**🔧** Changing the date and time

- To change the date and time, select **Date** from **Date** (📖 96) in the setup menu (📖 91) and follow the instructions starting from the above step 5.
- To change the time zone and the daylight saving settings, select **Time zone** from **Date** in the setup menu (📖 96, 97).

Inserting Memory Cards

Pictures are stored in the camera's internal memory (approximately 44 MB) or on removable Secure Digital (SD) memory cards (available separately) (115).

If a memory card is inserted in the camera, pictures are automatically stored on the memory card and pictures recorded to the memory card can be played back, deleted or transferred. Remove the memory card to store pictures in the internal memory, or play back, delete or transfer pictures from the internal memory.

First Steps

1 Confirm the power-on lamp and the monitor are off and open the battery-chamber/memory card slot cover.

Be sure to turn off the camera before opening the battery-chamber/memory card slot cover.

Before opening the battery-chamber/memory card slot cover, hold the camera upside down to prevent the batteries from falling out.

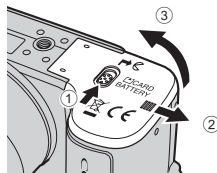

2 Insert the memory card.

Slide the memory card in correctly until it clicks into place.

Close the battery-chamber/memory card slot cover.

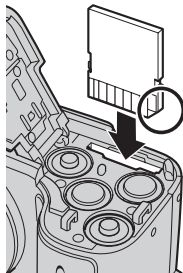

❌ Inserting Memory Cards

Inserting the memory card upside down or backwards could damage the camera or the memory card. Make sure that the memory card is correctly oriented.

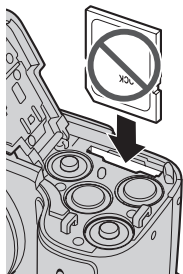

Removing Memory Cards

Before removing memory cards, **turn the camera off** and confirm that the power-on lamp and the monitor are off. Open the battery-chamber/memory card slot cover and press the card in ① to partially eject the card. Remove the card ②, being careful not to bend it.

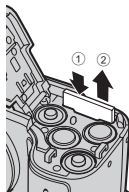

✔ Formatting Memory Cards

If the message at right is displayed, the memory card must be formatted before use (📖 106). **Note that formatting permanently deletes all pictures and other data on the memory card.** Be sure to make copies of any pictures you wish to keep before formatting the memory card.

Use the multi selector to choose **Yes** and press **OK**. The confirmation dialog will be displayed. To start formatting, choose **Format** and press **OK**.

- Do not turn the camera off or open the battery-chamber/memory card slot cover until formatting is complete.
- **The first time you insert the memory cards used in other devices into the camera, be sure to format them using this camera (📖 106).**

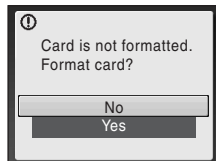

✔ The Write Protect Switch

SD memory cards are equipped with a write protect switch. Pictures cannot be recorded or deleted and the memory card cannot be formatted when this switch is in the "lock" position. Unlock by sliding the switch to the "write" position.

✔ Memory Cards

- Use only Secure Digital memory cards.
- Do not perform the following during formatting, while data is being written to or deleted from the memory card, or during data transfer to a computer. Failure to observe this precaution could result in the loss of data or in damage to the camera or memory card:
 - Insert or remove the card
 - Remove the batteries
 - Turn off the camera
 - Disconnect the AC adapter
- Do not format the memory card using a computer.
- Do not disassemble or modify.
- Do not drop, bend, or expose to water or strong physical shocks.
- Do not touch the metal terminals with your fingers or metal objects.
- Do not affix labels or stickers to the memory card.
- Do not leave in direct sunlight, closed vehicles or areas exposed to high temperatures.
- Do not expose to humidity, dust, or to corrosive gases.

Write protect switch

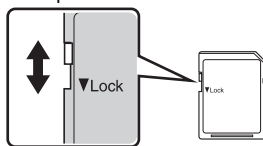

Step 1 Turn the Camera On and Select (Easy Auto) Mode

In  (easy auto) mode, the camera automatically determines an appropriate shooting mode when you frame a picture, allowing you to easily take pictures using a shooting mode that suits the scene.

1 Remove the lens cap and press the power switch to turn on the camera.

The power-on lamp (green) will light for a moment and the monitor will turn on. The lens will extend at this time.

Raise the built-in flash ( 6).

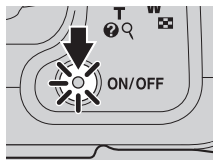

2 Press to display the shooting-mode selection menu.

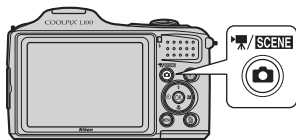



3 Press the multi selector to choose and press .

- The camera enters  (easy auto) mode.



4 Check the battery level and number of exposures remaining.

Battery level indicator

Monitor	Description
NO INDICATOR	The battery level is high.
	Batteries low. Prepare to replace batteries.
 Battery exhausted.	Cannot take pictures. Replace with new batteries.

Battery level indicator









Number of exposures remaining

Number of Exposures Remaining

The number of pictures that can be stored depends on the capacity of the internal memory or memory card and image mode setting ( 80).

Indicators Displayed in (Easy auto) Mode

Shooting mode

In easy auto mode, , , , , , , or  is displayed to indicate the shooting mode selected by the camera for the current subject and framing.

Motion detection icon

Reduce the blurring caused by subject movement or camera shake.

Vibration reduction icon

Reduce the effects of camera shake.



Internal memory indicator









Pictures will be recorded to internal memory (approximately 44 MB).
When memory card is inserted,  is not displayed and pictures will be recorded to memory card.

Image mode



Display image size and quality (compression) set in the image mode menu. The default setting is  Normal (3648 × 2736).

The indicators and photo info displayed during shooting and playback will turn off after a few seconds ( 99).



Available functions in easy auto mode

- When the camera is pointed at a person's face, the camera automatically recognizes the face and focuses on it.
- The self-timer ( 33) and exposure compensation ( 35) are available.
- In  (easy auto) mode, the image mode ( 79) can be changed by pressing **MENU**.
- See "Easy auto mode" ( 28) for more information.

Note on the Flash

When the built-in flash is lowered, the flash setting is fixed at off and  appears at the top of the monitor. In situations where flash is needed, such as in dark locations or when the subject is backlit, be sure to raise the built-in flash ( 6).

Notes on Vibration Reduction and Motion Detection

- See **Vibration reduction** ( 102) or **Motion detection** ( 103) in the setup menu ( 91) for more information.
- Set **Vibration reduction** to **Off** when using a tripod.

Step 2 Frame a Picture

1 Ready the camera.

Hold the camera steadily in both hands, keeping your fingers and other objects away from the lens, flash, AF-assist illuminator and microphone.

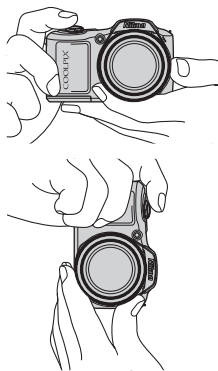

2 Frame the picture.

- When the camera determines the scene mode, the shooting mode icon will change (📖 28).
- When the camera recognizes a human face (front view), that face will be framed by a yellow double border. Up to 12 faces can be recognized. If more than one face is recognized, the face closest to the camera will be framed in the focus area by a double border, and the other faces will be framed by a single border.
- When shooting non-human subjects or when no faces are recognized, focus will be in the center of the monitor. Position the main subject near the center of the focus area.

Shooting mode icon

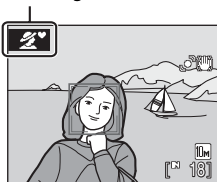

✓ Easy auto mode

- The desired scene mode may not be selected in certain conditions. In this case, select another shooting mode.
- When digital zoom is in effect, the shooting mode is 📷.

Using the Zoom

Use the zoom control to activate optical zoom.

Rotate the zoom control toward **T** to zoom in, increasing the size of the subject.

Rotate the zoom control toward **W** to zoom out, increasing the area visible in the frame.

A zoom indicator is displayed on the top of the monitor when the zoom control is rotated.

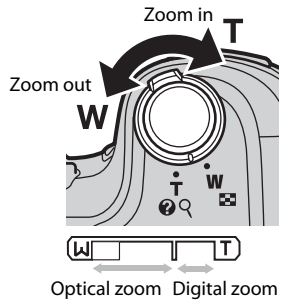

Digital Zoom

When the camera is zoomed in to the maximum optical zoom magnification, rotating and holding the zoom control at **T** triggers digital zoom. The subject is magnified up to 4x the magnification of the optical zoom.

The focus area is not displayed when digital zoom is in effect, and focus will be in the center of the screen.

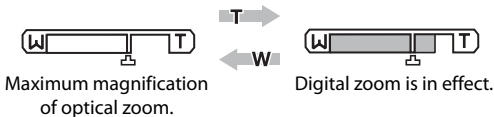

Digital Zoom and Interpolation

Unlike optical zoom, digital zoom uses a digital imaging process known as interpolation to magnify images, resulting in slight deterioration of picture quality.

Interpolation is applied at zoom positions beyond .

When zoom is increased beyond the  position, interpolation is initiated and the zoom indicator turns yellow to indicate that interpolation is being applied.

The position of  moves to the right as image size decreases, allowing for confirmation of the zoom positions at which shooting without interpolation is possible at the current image mode setting.



When the image size is small.

Step 3 Focus and Shoot

1 Press the shutter-release button halfway.

- Press halfway (📖 13) to focus. When the subject is in focus, the focus area will glow green.



When people's faces (front view) are recognized:

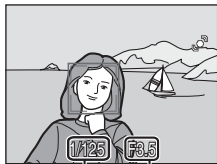

Shutter Speed Aperture

When shooting non-human subjects or when no faces are recognized:

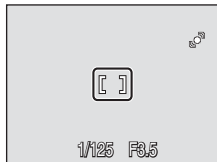

- When using the digital zoom, the camera focuses on the center of the frame, but the focus area is not displayed. When the subject is in focus, the focus indicator will glow green.

Focus indicator

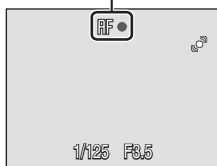

- The shutter speed and aperture are displayed when the shutter-release button is pressed halfway.
- Focus and exposure remain locked while the shutter release button is pressed halfway.
- When the camera is unable to focus, the focus area, or focus indicator, blinks red. Change the composition and try again.

2 Press the shutter-release button the rest of the way down.

- The picture will be recorded to the memory card or internal memory.



✓ During Recording

While pictures are being recorded, the number of exposures remaining display will blink. Do not open the battery-chamber/memory card slot cover.

Removing the memory card or the battery during recording may result in loss of data or in damage to the recorded data, camera or card.

✓ Autofocus

Autofocus may not perform as expected in the following situations. In some rare cases, the subject may not be in focus despite the fact that the focus area or the focus indicator glows green:

- Subject is very dark
- Objects of sharply differing brightness are included in the scene (e.g. the sun is behind the subject and is in deep shadow)
- No contrast between the subject and surroundings (e.g. when the subject is standing in front of a white wall, wearing a white shirt)
- Several objects are at different distances from the camera (e.g. the subject is inside a cage)
- Subject is moving rapidly

In these situations, try pressing the shutter-release button halfway again to refocus, several times if necessary. If the subject is still not in focus, select auto mode and use focus lock (📖 29) to take the picture by first focusing on an object that is the same distance from the camera as the desired subject.

📎 Notes about Face Priority

See "Notes about Face Priority" (📖 28) for more information.

📎 Blink Warning

If the **Did someone blink?** screen is displayed shortly after the picture is taken in the Face Priority, someone's eyes may have been closed during the shot.



- Human subjects with eyes closed will be framed by a yellow border in the **Did someone blink?** screen.
- To return to the shooting mode, press **OK** or press the shutter-release button halfway.

See "**Blink warning**" (📖 108) in the setup menu (📖 91) or "Operating the **Did someone blink?** Screen" (📖 108) for more information.

🔍 AF-assist Illuminator and Flash









If the subject is poorly lit, the AF-assist illuminator (📖 104) may light by pressing the shutter-release button halfway, or the flash (📖 30) may fire by pressing the shutter-release button all the way down.

Step 4 Viewing and Deleting Pictures

Viewing Pictures (Playback Mode)



Press  (playback).

The last picture taken will be displayed in full-frame playback mode.

Use the multi selector , ,  or  to view additional pictures. Hold down the multi selector , ,  or  to fast forward pictures.

Pictures may be displayed briefly at low resolution while being read from the memory card or internal memory.

Press  to switch to shooting mode.

When  is displayed, pictures stored in the internal memory will be displayed. When memory card is inserted,  is not displayed and pictures stored on the memory card will be displayed.

 (shooting mode)

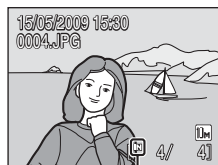
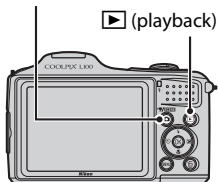

Internal memory indicator

Deleting Pictures

- 1 Press  to delete the picture currently displayed in the monitor.



- 2 Use the multi selector to select **Yes** and press .



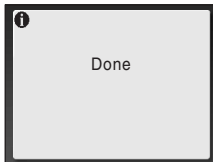
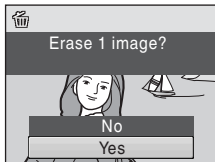

To exit without deleting the picture, choose **No** and press

.



Playback Mode



The following options are available in full-frame playback mode.

Option	Use	Description	
Playback zoom	T 	The picture can be enlarged up to about 10x. Press OK to return to full-frame playback.	56
View thumbnails/calendar	W 	Display 9, 16, or 25 picture thumbnails, or the calendar.	54
Switch to shooting mode		Press  to return to the last shooting mode selected.	10

Power on by pressing

When the camera is off, hold down  to turn on the camera in playback mode. The lens will not extend.

Viewing Pictures



- Pictures stored in the internal memory can only be viewed if no memory card is inserted.
- Pictures taken with face priority ( 24) will be automatically rotated when viewing them full-frame.
- While the monitor is off in standby mode to save power, press  or the power switch to turn the monitor on ( 105).

Deleting the last picture taken while in shooting mode

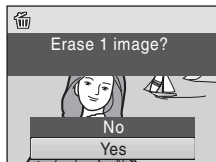
In shooting mode, press  to delete the last picture taken.









Selecting multiple pictures for deletion

When **Delete** ( 90) is selected from the playback menu ( 87), multiple pictures can be deleted.

Easy auto mode

Automatic Scene Selection

The camera automatically selects one of the following scenes when you point the camera at a subject.

-  Auto mode (general use) (📖 29)
-  Portrait (📖 37)
-  Landscape (📖 37)
-  Night landscape (📖 40)
-  Night portrait (📖 38)
-  Backlight (📖 42)
-  Close-up (📖 40)

Notes about Face Priority

- The camera may be unable to detect faces in the following situations:
 - When faces are partially hidden by sunglasses or other obstructions
 - When the subject is not looking directly at the camera
 - When faces take up too much or too little of the frame
- The camera's ability to detect faces depends on a variety of factors, including whether or not the subject is facing the camera.
- In some cases, included those noted in "Autofocus" (📖 25), autofocus may not perform as expected, and the subject may not be in focus despite the fact that the double border glows green. When the camera is unable to focus, use another mode, such as  (auto) mode, focus on another subject positioned at the same distance from the camera as the actual portrait subject, and use focus lock (📖 29).

Restrictions applied to the functions in the easy auto mode

The macro mode button (📖 11, 34) on the multi selector is not available.

Flash Settings in Easy Auto Mode

- When the built-in flash is raised, the camera automatically sets the flash mode (📖 30) according to the determined scene mode.  (flash mode) (📖 11) on the multi selector is not available.
- When the built-in flash is lowered, flash is set to off.

Shooting in the Auto Mode



In the  (auto) mode, you can set image mode, white balance, continuous shooting, color options and distortion control in the shooting menu, and take pictures.

1 Press to display the shooting-mode selection menu.

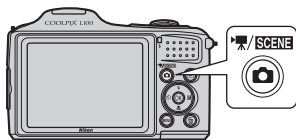
- The shooting-mode selection menu will be displayed.



2 Press the multi selector or to choose and press .

- The camera enters  (auto) mode.
- Press **MENU** to select an option from the shooting menu ( 77).

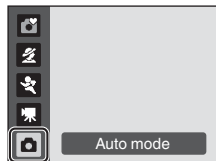

3 Frame the subject and shoot.

- Raise the built-in flash when using the flash.
- Camera focuses on subject in center of frame.

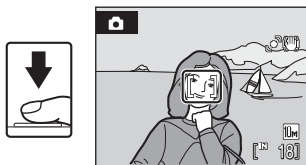

Focus Lock

When the camera focuses on an object in the center of the frame, you can use focus lock to focus on an off-center subject.

- Be sure that the distance between the camera and the subject does not change while focus is locked.
- When the shutter-release button is pressed halfway, exposure is locked.



Position the subject in the center of the frame.



Press the shutter release button halfway.



Confirm that the focus area is green.





Continue holding down the shutter-release button halfway and recompose the picture.





Press the shutter-release button the rest of the way down.

Available Functions in (Auto) Mode

In addition to the items in shooting menu, flash mode ( 30) can be changed and self-timer ( 33), macro mode ( 34) and exposure compensation ( 35) can be applied.

Using the Flash

In dark locations or when the subject is backlit, you can shoot pictures with flash by raising the built-in flash. When the built-in flash is lowered, the flash is  (off). When the built-in flash is raised, you can set the flash mode according to your shooting environment.

- In the  (easy auto) mode ( 20), the flash mode cannot be changed manually. The camera automatically sets the flash mode according to the determined scene mode.

AUTO Auto

Flash fires automatically when lighting is poor.

Auto with red-eye reduction

Reduces “red-eye” in portraits ( 32).

Off

Flash will not fire even when lighting is poor.

Fill flash

Flash fires when a picture is taken. Use to “fill-in” (illuminate) shadows and back-lit subjects.

Slow sync

Auto flash mode is combined with slow shutter speed.

Flash illuminates main subject; slow shutter speeds are used to capture background at night or under dim light.

Setting the Flash Mode

1 Raise the built-in flash (6).

When the built-in flash is lowered, it is fixed to  (off).



2 Press (flash mode).

The flash menu is displayed.



3 Use the multi selector to choose the desired flash mode and press .

The icon for the selected flash mode is displayed at the top of the monitor.

When  (auto) is applied,  will disappear after a few seconds regardless of the monitor settings ( 99).

If a setting is not applied by pressing  within a few seconds, the selection will be cancelled.

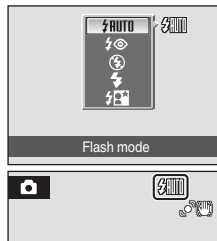

✓ Lowering the Built-in Flash

When not using the flash, lower the built-in flash (📖 6).

✓ Shooting When Lighting Is Poor and the Flash Is Disabled (🔋)

- Use of a tripod is recommended to stabilize the camera during shooting and avoid the effects of camera shake. Set **Vibration reduction** (📖 102) to **Off** when using a tripod.
- The **ISO** is displayed when the camera automatically increases sensitivity to minimize blur caused by slow shutter speed. Pictures taken when **ISO** is displayed may be slightly mottled.

✓ Note on Using the Flash

When using the flash, reflections from dust particles in the air may appear as bright spots in pictures. To reduce these reflections, set the flash to 🔋 (off).

🔧 The Flash Lamp

The flash lamp indicates flash status when the shutter-release button is pressed halfway.

- **On:** Flash will fire when picture is taken.
- **Blinks:** Flash charging. Wait a few seconds and try again.
- **Off:** Flash will not fire when picture is taken.

If the remaining battery level is low, the monitor will turn off until the flash has finished charging.

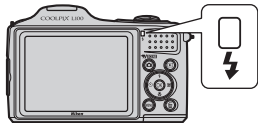

🔧 The Flash Mode Setting

The default setting of the flash mode depends on the shooting mode.

- 📷 (easy auto) mode: The camera automatically sets the flash mode according to the determined scene mode and uses the flash.
- 🏃 (sport continuous) mode: 🔋 Off (locked)
- 📷 (high sensitivity) mode: 📷 AUTO Auto
- 😊 (smile) mode: 📷 AUTO Auto
- Scene mode: The default setting depends on the scene menu (📖 36).
- 📷 (auto) mode: 📷 AUTO Auto

When the shooting mode is 📷 (auto) mode (📖 29) or high sensitivity mode (📖 50), the changed flash setting will be stored even if the camera is turned off.

🔧 Flash Range

In easy auto mode and auto mode, the flash has a range of about 0.5-6.5 m (1 ft. 8 in. to 21 ft.) when the camera is zoomed out all the way, and about 0.5-4.5 m (1 ft. 8 in. to 14 ft.) when the camera is zoomed in all the way.

In high sensitivity mode, the range is about 0.5-11.0 m (1 ft. 8 in. to 36 ft.) when the camera is zoomed out all the way, and about 0.5-9.0 m (1 ft. 8 in. to 29 ft.) when the camera is zoomed in all the way.

Red-eye Reduction

This camera is equipped with an advanced red-eye reduction system.

Pre-flashes are fired several times at low intensity before the main flash, to reduce “red-eye.”

If the camera detects “red-eye” after a picture is taken, Nikon’s own In-Camera Red Eye Fix processes the image as it is recorded. Therefore, there is a slight delay before the shutter-release button operates normally to take another picture.

Note the following when using red-eye reduction:

- Not recommended when shutter-release timing is essential because it takes a longer time than using the usual shooting mode from when the shutter-release button is pressed to when the shutter is released.
- After taking a picture, it takes more time than normal before you can take another picture.
- Red-eye reduction may not always produce the desired results.
- In some rare cases, other portions of pictures may be affected. Use flash modes other than auto with red-eye reduction in above cases.

Taking Pictures with the Self-timer

When using the self-timer, pictures are taken 10 seconds after the shutter-release button is pressed. When using the self-timer, use of a tripod is recommended.

1 Press (self-timer).

The self-timer menu is displayed.



2 Use the multi selector to choose **ON** and press .

The self-timer icon ( 10) is displayed.

If a setting is not applied by pressing  within a few seconds, the selection will be cancelled.



3 Frame the picture and press the shutter-release button halfway.

Focus and exposure will be set.

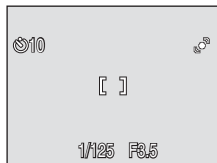

4 Press the shutter-release button the rest of the way down.

The self-timer starts and the number of seconds remaining until the shutter is released is displayed in the monitor. The self-timer lamp will blink. The lamp stops blinking one second before the picture is taken and remains lit until the shutter is released.

When the shutter is released, the self-timer will be set to **OFF**.

To stop the timer before a picture is taken, press the shutter-release button again.

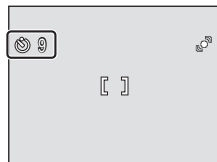

Macro Mode

Macro mode is used for taking pictures of objects as close as 1 cm (0.4 in.). Note that the flash may be unable to light entire subject at distances of less than 50 cm (1 ft. 8 in.).

Macro mode cannot be used with easy auto mode (📖 20).

1 Press 🌱 (macro mode).

- The macro menu is displayed.



2 Use the multi selector to choose **ON** and press **OK**.

The macro mode icon (🌱) is displayed.

If a setting is not applied by pressing **OK** within a few seconds, the selection will be cancelled.

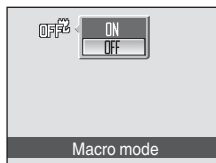

3 Use the zoom control and frame the picture.

The camera can focus at distances as close as 1 cm (0.4 in.) from the lens when 🌱 and the zoom indicator glow green (zoom indicator is positioned near △).

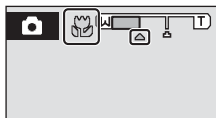

Macro Mode

In macro mode, the camera focuses continuously, even when the shutter-release button is not pressed halfway to lock focus. When the shutter-release button is halfway pressed, the focus is locked to adjust the exposure.

The Macro Mode Setting

When the shooting mode is 📷 (auto) mode (📖 29) or high sensitivity mode (📖 50), the macro mode setting will be stored even if the camera is turned off.

Exposure Compensation

Exposure compensation is used to alter exposure from the value suggested by the camera to make pictures brighter or darker.

1 Press (exposure compensation).

- The exposure compensation guide is displayed.



2 Use the multi selector to adjust exposure and press .

- When the picture is too dark: adjust the exposure compensation to "+" side.
- When the picture is too bright: adjust the exposure compensation to "-" side.
- Exposure compensation can be set to values between -2.0 and +2.0 EV.
- If a setting is not applied by pressing  within a few seconds, the selection will be cancelled.

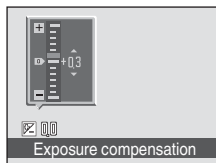

3 The setting is applied.

- The  icon is displayed in the monitor.



Exposure Compensation Value

When the shooting mode is  (auto) mode (📖 29) or high sensitivity mode (📖 50), the exposure compensation setting will be stored even if the camera is turned off.

Using Exposure Compensation

The camera tends to lower exposure when the frame is dominated by brightly lit objects and to increase exposure when the frame is mostly dark. Positive compensation may therefore be required to capture the brilliancy of very bright objects that fill the frame (for example, sunlit expanses of water, sand, or snow) or when the background is much brighter than the main subject. Negative compensation may be called for when large areas of the frame contain very dark objects (for example, a swath of dark green leaves) or when the background is much darker than the main subject.

Using the Scene Mode

Camera settings are automatically optimized for the selected subject type. The following scene modes are available.

Portrait	Beach/snow	Close-up	Backlight
Landscape	Sunset	Food	Panorama assist
Night portrait	Dusk/dawn	Museum	
Party/indoor	Night landscape	Copy	

Setting the Scene Mode

- 1 Press in shooting mode to display the shooting-mode selection menu and use the multi selector and to choose scene mode.

- (Portrait) is the default setting.
- The icon of the last scene mode used is displayed.



- 2 Press the multi selector to select a scene mode and press .

The camera enters scene mode.

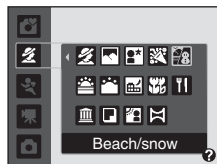

- 3 Frame the subject and shoot.

For scene modes that use the flash, be sure to raise the built-in flash before shooting.



Image Mode

You can set the **Image mode** (79) by pressing **MENU**. If the image mode setting is changed, the new image mode setting is also applied to other shooting modes (except sport continuous, high sensitivity, and movie modes).

Features

Portrait

Use this mode for portraits in which the main subject stands out clearly. Portrait subjects exhibit smooth, natural-looking skin tones.

- If the camera recognizes a person's face (front view), the camera will focus on that person (face priority: [book 24](#)).
- If the camera detects a smiling face of the subject, the smile indicator increases or decreases.
- If more than one face is recognized, the camera focuses on the face closest to the center of the monitor.
- If no faces are recognized, focus will be on the center of the screen.
- Digital zoom is not available.

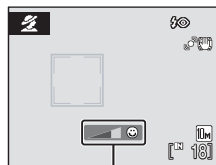

Smile indicator

			Off*		Off		0.0*
---	---	---	------	---	-----	---	------

* Other settings can be selected.

Landscape

Use this mode for vivid landscapes and cityscapes.





- Camera focuses at infinity. The focus area or focus indicator ([book 8](#)) always glows green when the shutter-release button is pressed halfway. Note, however, that objects in the foreground may not always be in focus.
- The AF-assist illumination turns off automatically regardless of the setting of the AF-assist illumination ([book 104](#)).



			Off*		Off		0.0*
---	---	---	------	---	-----	---	------

* Other settings can be selected.

Icons Used for Descriptions

The following icons are used for descriptions in this section: : flash mode when the built-in flash is raised ([book 30](#)); : self-timer ([book 33](#)); : macro mode ([book 34](#)); : exposure compensation ([book 35](#)).

Using the Scene Mode

Night portrait



Use this mode to achieve a natural balance between the main subject and background lighting in portraits taken at night.

- If the camera recognizes a person's face (front view), the camera will focus on that person (face priority: 24).
- If more than one face is recognized, the camera focuses on the face closest to the camera.
- If no faces are recognized, focus will be on the center of the screen.
- Shoot pictures with the built-in flash raised.
- Digital zoom is not available.
- Motion detection (103) does not function in this scene mode, even if it is turned on in the setup menu.



Off*²



Off



0.0*²

*¹ Fill flash with slow sync and red-eye reduction.

*² Other settings can be selected.

Party/indoor

Captures the effects of candlelight and other indoor background lighting.

- Camera focuses on subject in center of frame.
- As pictures are easily affected by camera shake, hold the camera steadily. In a dark place, the use of a tripod is recommended. Set **Vibration reduction** (102) to **Off** when using a tripod.



Off*²



Off



0.0*²

*¹ The flash may change to slow sync with red-eye reduction. Other settings can be selected.

*² Other settings can be selected.

: For those scene modes with , use of a tripod is recommended. Set **Vibration reduction** (102) to **Off** when using a tripod.

Beach/snow

Captures the brightness of such subjects as snowfields, beaches, or sunlit expanses of water.

- Camera focuses on subject in center of frame.



* Other settings can be selected.

Sunset

Preserves the deep hues seen in sunsets and sunrises.

- Camera focuses on subject in center of frame.



* Other settings can be selected.

Dusk/dawn

Preserves the colors seen in the weak natural light before sunrise or after sunset.

- Camera focuses at infinity. The focus area or focus indicator (📖 8) always glows green when the shutter-release button is pressed halfway. Note, however, that objects in the foreground may not always be in focus.
- The AF-assist illumination turns off automatically regardless of the setting of the AF-assist illumination (📖 104).
- Motion detection (📖 103) does not function in this scene mode, even if it is turned on in the setup menu.



* Other settings can be selected.



: For those scene modes with , use of a tripod is recommended. Set

Vibration reduction (📖 102) to **Off** when using a tripod.

Using the Scene Mode

Night landscape

Slow shutter speeds are used to produce stunning night landscapes.





- Camera focuses at infinity. The focus area or focus indicator ( 8) always glows green when the shutter-release button is pressed halfway. Note, however, that objects in the foreground may not always be in focus.
- The AF-assist illumination turns off automatically regardless of the setting of the AF-assist illumination ( 104).



* Other settings can be selected.



Close-up

Photograph flowers, insects and other small objects at close range.

- The macro mode ( 34) will turn **ON** and the zoom will automatically move to the closest possible shooting position.
- The camera can focus at distances as close as 1 cm (0.4 in.) from the lens when  and the zoom indicator glow green (zoom indicator is positioned near ).
- Camera focuses on subject in center of frame.
- The camera focuses continuously until the shutter-release button is pressed halfway to lock the focus.
- As pictures are easily affected by camera shake, check the **Vibration reduction** ( 102) setting and hold the camera steadily.



* Other settings can be selected. Note that the flash may be unable to light entire subject at distances of less than 50 cm (1 ft. 8 in.).

: For those scene modes with , use of a tripod is recommended. Set **Vibration reduction** ( 102) to **Off** when using a tripod.

Food

Use when shooting foods. See “Taking Pictures for Food Mode” (📖 44) for details.

- Camera focuses on subject in center of frame.



* Other settings can be selected.

Museum

Use indoors where flash photography is prohibited (for example, in museums and art galleries) or in other settings in which you do not want to use the flash.

- Camera focuses on subject in center of frame.
- BSS (best shot selector) can be used to shoot (📖 83).
- As pictures are easily affected by camera shake, check the **Vibration reduction** (📖 102) setting and hold the camera steadily.
- The AF-assist illumination turns off automatically regardless of the setting of the AF-assist illumination (📖 104).
- Motion detection (📖 103) does not function in this scene mode, even if it is turned on in the setup menu.



* Other settings can be selected.

Using the Scene Mode

Copy

Provides clear pictures of text or drawings on a white board or in print.

- Camera focuses on subject in center of frame.
- Use macro mode ( 34) to focus at short ranges.
- Colored text and drawings may not show up well.



* Other settings can be selected.

Backlight

Use when light is coming from behind your subject, throwing features or details into shadow. The flash fires automatically to “fill in” (illuminate) shadows.

- Camera focuses on subject in center of frame.
- Shoot pictures with the built-in flash raised.
- Motion detection ( 103) does not function in this scene mode, even if it is turned on in the setup menu.



* Other settings can be selected.

Panorama assist



Use when taking a series of pictures that will later be joined to form a single panorama using the supplied Panorama Maker software. See Taking Pictures for a Panorama ( 46) for details.



* Other settings can be selected.

Taking Pictures for Food Mode



Use when shooting foods.

1 Display the shooting-mode selection menu and choose Food 36).

- The macro mode  34 will turn **ON** and the zoom will automatically move to the closest possible shooting position.





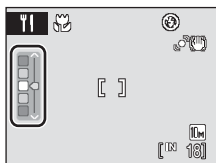

2 Use the multi selector or to choose white balance.

- Press  to increase the amount of red, or  to increase the amount of blue.



3 Frame the picture.

- The camera can focus at distances as close as 1 cm (0.4 in.) from the lens when  and the zoom indicator glow green (zoom indicator is positioned near ).
- As pictures are easily affected by camera shake, check the **Vibration reduction**  102 setting and hold the camera steadily.
- The camera focuses on the subject in the center of the frame. Use focus lock to frame the picture on an object not in the center of the frame  29).

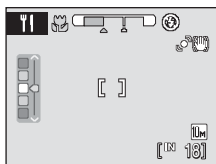

4 Press the shutter-release button to shoot.

- Pressing the shutter-release button halfway locks the focus, and pressing the shutter-release button the rest of the way down takes the picture.
- When the camera is unable to focus, the focus area will blink. Change the composition and try pressing the shutter-release button halfway again.

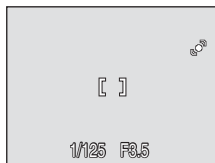

✓ Notes when using the food mode

The flash is disabled. The macro mode (📖 34) will be locked to **ON**.

✎ White balance in Food Mode

- Increasing the amount of red or blue will decrease illumination effects.
- Changing white balance in Food mode will not affect **White balance** in the shooting menu (📖 81).
- White balance setting in the food mode will be saved even when the power is turned off.

Taking Pictures for a Panorama





The camera focuses on the subject in the center of the frame. Use a tripod for best results. Set **Vibration reduction** (📖 102) to **Off** when using a tripod.

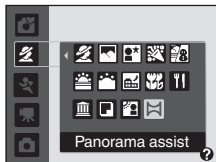

- 1 Display the shooting-mode selection menu and choose  Panorama assist (📖 36).

The panorama direction icon () is displayed to show the direction in which pictures will be joined.



- 2 Use the multi selector to choose the direction and press **OK**.

Select how pictures will be joined together in the completed panorama; right () , left () , up () or down () .

The yellow panorama direction icon () is displayed to the direction pressed and the direction is fixed when **OK** is pressed. The white fixed direction () is displayed.

Apply flash mode (📖 30), self-timer (📖 33), macro mode (📖 34) and exposure compensation (📖 35) settings with this step, if necessary. Press **OK** to reselect the direction.



- 3 Shoot the first picture.

The first picture is superimposed in the first third of the monitor.



- 4 Shoot the second picture.

Compose the next picture so that it overlaps 1/3 of the first picture and press the shutter-release button.

Repeat until you have taken the necessary number of pictures to complete the scene.



5 Press **OK** when shooting is completed.

- The camera returns to step 2.



✔ Panorama Assist

Apply flash mode, self-timer, macro mode and exposure compensation settings before taking the first picture. These settings cannot be changed after the first picture is taken. Image mode (📖 79) settings, zoom operation, and image deletion are not possible.

The panorama series is terminated if the camera enters standby mode with the auto off function (📖 105) during shooting. Setting the time allowed to elapse before the auto off function is enabled to a longer setting is recommended.

🔍 Note on AE/AF-L

AE/AF-L is displayed to indicate that white balance, exposure, and focus have been locked at the values set with the first shot. All pictures taken in a panorama series have the same white balance, exposure, and focus settings.



🔍 Panorama Maker

Install Panorama Maker from the supplied Software Suite CD.

Transfer pictures to a computer (📖 65) and use Panorama Maker (📖 68) to join them in a single panorama.





🔍 More Information

See, "Image File and Folder Names" (📖 116) for more information.

Shooting in the Sport Continuous Mode

Sport continuous mode allows rapid, continuous shooting while you press and hold the shutter-release button fully. With continuous shooting, instantaneous movements in moving subjects can be captured clearly.

- The shutter speed is set automatically within the range of 1/4000 s to 1/15 s.
- ISO sensitivity is set high.
- Image mode (📖 79) can be set to **3M Normal (2048)** or smaller.
- The focus, exposure, and white balance settings are fixed at the values for the first picture in each series.

- 1** Press  in shooting mode to enter the shooting-mode selection menu, use the multi selector  or  to select the third icon from the top, and then press .



- 2** Press the multi selector  or  to choose  and press .

The camera enters sport continuous mode.

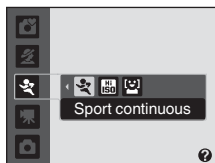

- 3** Press **MENU**, then set the items in the sport continuous menu.

- sport continuous menu → 📖 49
- Press **MENU** after setting the items to return to shooting mode.



- 4** Frame the subject and shoot.

- The camera focuses on the subject in the center of the frame. Pressing the shutter-release button halfway sets the focus and exposure.
- Continuous shooting continues as long as the shutter-release button is pressed fully, and stops when the number of shot frames reaches the maximum available number (📖 49).

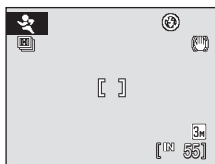

Sport Continuous Menu

The following items can be set in the sport continuous menu. In sport continuous mode, press **MENU** to display the sport continuous menu, then use the multi-selector to modify and apply settings.

Sport continuous

Select the type of sport continuous mode (maximum continuous shooting speed and maximum number of frames to be shot).







-  **Continuous H** (default setting): Approx. 13 frames per second (30 frames max.)
-  **Continuous M**: Approx. 6.5 frames per second (30 frames max.)
-  **Continuous L**: Approx. 4.3 frames per second (30 frames max.)

Image mode



Image mode ( 79) can be set.

In sport continuous mode, the following image mode settings are available:

 **Normal (2048)**,  **PC screen (1024)**,  **TV screen (640)**,  **16:9 (1920)**.

The image mode setting in the sport continuous menu is stored separately from the image mode setting in other shooting modes and is not applied to the other modes.

Notes on Sport Continuous Mode

- The speed of continuous shooting may be slower depending on shutter speed settings and the data transfer speed of the memory card.
- As the ISO sensitivity is automatically set to a high setting, the captured pictures may appear rough as a result.
- As the ISO sensitivity is fixed at 720 and over, proper exposure may not be obtained in clear weather (pictures may be overexposed).
- If bright objects such as the sun or electric lights are captured during high-speed continuous shooting, vertical streaks of light may appear in the recorded images. We recommend that you avoid capturing bright objects during Sport continuous shooting.
- When shooting under fluorescent or mercury lights that have a high flicker rate, exposure and white balance may differ from picture to picture.
- The flash setting is fixed at  (off).
- The exposure compensation ( 35) is available.
- The self-timer and macro mode are not available.
- During sport continuous mode, the camera continuously adjusts the focus with the autofocus function until you press the shutter-release button halfway, after which focus is locked.

More Information

See, "Autofocus" ( 25) for more information.

Shooting in the High Sensitivity Mode

In high sensitivity mode, ISO sensitivity is set high to reduce blurring caused by camera shake or subject movement even when shooting under low lighting or with zoom applied. This allows you to capture the atmosphere of the scene without flash, or extend the effective range of the flash compared to other shooting modes (📖 31).

- Image mode can be set to **3M Normal (2048)** or smaller.

- Enter shooting-mode selection menu by pressing  in shooting mode. Use the multi selector **▲** or **▼** to select the third icon from the top, and then press **▶**.



- Press the multi selector **◀** or **▶** to choose **HI ISO** and press **OK**.

The camera enters **HI ISO** high sensitivity mode.

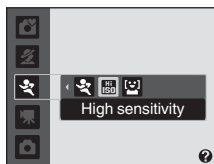

- Frame the subject and shoot.

- Raise the built-in flash when using the flash.
- When the camera recognizes a human face (front view), that face will be framed by a yellow double border.

Up to 12 faces can be recognized. If more than one face is recognized, the face nearest to the camera will be framed by a double border and the rest by a single border.

- When shooting non-human subjects or when no faces are recognized, focus will be in the center of the monitor. Position the main subject near the center of the focus area.



Notes on High Sensitivity Mode

- This mode reduces effects of camera shake even for shooting under low lighting; however, when shooting without the flash, use of a tripod is recommended. Set **Vibration reduction** (📖 102) to **Off** when using a tripod.
- As the ISO sensitivity is automatically set to a high setting, the captured pictures may appear rough as a result.
- As the ISO sensitivity is fixed at 720 and over, proper exposure may not be obtained in clear weather (pictures may be overexposed).
- Focus may not be precisely fixed in extremely dark places.

Options that can be used in High Sensitivity





- Settings can be changed for flash mode (📖 30), self-timer (📖 33), macro mode (📖 34) and exposure compensation (📖 35).
- Press **MENU** in high sensitivity mode to display the high sensitivity menu and set shooting options.
- In high sensitivity mode, the following image mode (📖 79) settings are available: **3M Normal (2048)**, **PC screen (1024)**, **TV TV screen (640)**, and **16:9 (1920)**.
- The image mode setting in the high sensitivity menu is stored separately from the image mode setting in other shooting modes and is not applied to the other modes.

More Information

See “Autofocus” (📖 25) or “Notes about Face Priority” (📖 28) for more information.

Using the Smile Mode

The camera detects a smiling face to shoot the face automatically.

- 1 Press  in shooting mode to enter the shooting-mode selection menu, use the multi selector  or  to select the third icon from the top, and then press .

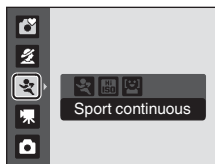

- 2 Press the multi selector  or  to choose  and press .

The camera enters smile mode.



- 3 Frame the picture.

- Raise the built-in flash when using the flash.
- Point the camera at the subject.
- If the camera recognizes a person's face (facing front), the face will be framed by a double yellow border in the focus area, and when the face comes into focus, the double border will instantly turn green and the focus will be locked.
- When the faces of multiple people are recognized, the face nearest the center of the screen will be framed by a double border in the focus area and the other faces will be framed by a single border. Up to three faces will be recognized.

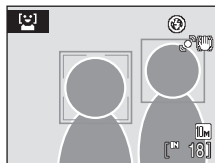

- 4 The shutter is automatically released.

- If the camera detects the smiling face of the person framed by a double border, the shutter is automatically released.
- If the camera recognizes a person's face, the self-timer lamp ( 4) blinks. Just after the shutter is released, the self-timer lamp blinks rapidly.
- Each time the shutter is released, the camera again begins face recognition and smile detection operations for continuous automatic shooting.

5 Exit smile mode by pressing .

Change to another shooting mode.



Face Priority and Smiling Face Detection features

When the camera is pointed at a person's face (front view) in the smile mode, the face is automatically recognized and the smiling face of the recognized person is detected.

- In some shooting conditions, face recognition does not work and faces cannot be detected.
- See "Face Priority" (📖 24) for more information about Face Priority.

Shooting in the Smile Mode

When using Smile mode, Auto off (📖 105) will turn the camera off if no operations are performed in the following situations:

- The camera does not recognize any faces.
- The camera recognized the face but cannot detect a smiling face.

Operation of Shutter-Release Button

Press the shutter-release button to shoot pictures.

- When Face priority takes effect, the focus is locked on the recognized face and the shutter is released.
- When the Face priority doesn't take effect, the camera focuses on subject in center of frame.

Available Functions in Smile Mode

- Settings can be changed for Flash mode (📖 30) and Exposure Compensation (📖 35).
- Pressing the **MENU** button in the smile mode can change the image mode (📖 79). If the image mode setting is changed, the new setting applies to all shooting modes (except sport continuous, high sensitivity, and movie modes).
- Digital zoom is not available.

More Information

See, "Autofocus" (📖 25) for more information.

Viewing Multiple Pictures: Thumbnail Playback

Rotate the zoom control to **W** (📐) in full-frame playback mode (📖 26) to display pictures in “contact sheets” of thumbnail images. The following operations can be performed while thumbnails are displayed.



To	Use	Description	
Choose pictures		Press the multi selector ▲, ▼, ◀ or ▶.	11
Increase the number of pictures displayed/ apply the calendar display	W (📐)	Rotate the zoom control to W (📐) to change the number of frames displayed from 9 → 16 → 25, or display the calendar. When the calendar is displayed, you can select images to view based on the day they were taken (📖 55). Rotate the zoom control to T (🕒) to return to thumbnail display mode.	–
Reduce the number of frames displayed	T (🕒)	Rotate the zoom control to T (🕒) to reduce the number of frames displayed from 25 → 16 → 9. While 9 frames are displayed, rotate the zoom control to T (🕒) again to return to full-frame display mode.	–
Switch to full-frame playback	OK (Ⓚ)	Press OK .	26
Switch to shooting mode		Press	10

Thumbnail Playback Mode Display

While pictures selected for **Print Set** (📖 75) and **Protect** (📖 111) are chosen, the icons shown at right are displayed with them. Movies are displayed as film frames.

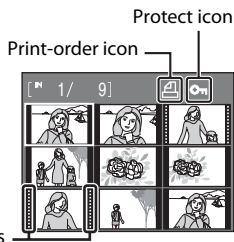

Calendar Display

When displaying 25 thumbnail frames in playback mode (📖 54), switch to calendar display by rotating the zoom control to **W** (🗓️).

You can select images to view based on the day they were taken. Days containing pictures have a yellow line under them.

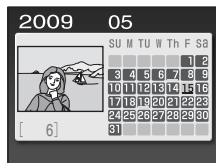

To	Use	Description	📖
Choose date		Press the multi selector ▲, ▼, ◀ or ▶.	11
Switch to full-frame playback		The first picture for that date will be displayed full-frame.	26
Switch to thumbnail display	T (📷)	Rotate the zoom control to T (📷) to return to 25 thumbnails display.	–

☑ Calendar display

- Pictures taken when the camera's date is not set are treated as pictures taken on January 1, 2009.
- The 🗑️ and MENU buttons are not available during calendar display.

Taking a Closer Look: Playback Zoom

Rotating the zoom control to **T** (Q) during full-frame playback mode (📖 26) zooms the current picture, with the center of the picture displayed in the monitor.

- The guide displayed in the right bottom in the monitor will show which part of the image is currently displayed.



The following operations can be performed while pictures are zoomed in.

To	Use	Description	📖
Zoom in	T (Q)	Zoom increases each time the zoom control is rotated to T (Q), up to about 10x.	–
Zoom out	W (📐)	Zoom decreases each time the zoom control is rotated to W (📐). When the magnification ratio reaches 1x, the display returns to full-frame playback mode.	–
View other areas of picture		Press the multi selector ▲ , ▼ , ◀ or ▶ to scroll to areas of the picture not visible in the monitor.	11
Switch to full-frame playback	OK	Press OK .	26
Crop picture	MENU	Press MENU to crop current picture to contain only the portion visible in the monitor.	59
Switch to shooting mode		Press to return to the last shooting mode selected.	10

Pictures taken in Face Priority

When the zoom control is rotated to **T** (Q) during full-frame playback mode for pictures taken in Face Priority (📖 24), the picture will be enlarged with the face detected with shooting at the center of the monitor.

- If several faces are recognized, the picture will be enlarged using the face which was focused on during shooting time as the centralized point, and pressing the multi selector **▲**, **▼**, **◀** or **▶** will enable you to switch between the people's faces.
- Rotate the zoom control toward **T** (Q) again or toward **W** (📐) to zoom in or out as normal.



Editing Pictures

Use the camera to edit pictures in-camera and store them as separate files (📖 116). The editing features described below are available.

Editing function	Description
D-Lighting (📖 58)	Create a copy of the current picture with enhanced brightness and contrast, brightening dark portions of the picture.
Crop (📖 59)	Enlarge the image or refine the composition and create a copy containing only the portion visible in the monitor.
Small picture (📖 60)	Create a small copy of pictures suitable for use on web pages or as e-mail attachments.

Picture Editing

- Pictures taken at an **Image mode** setting (📖 79) of **16:9** cannot be edited.
- Only pictures taken with the COOLPIX L100 can be edited with this camera.
- When using a different model of digital camera, pictures edited with this camera may not be displayed properly and may not be able to be transferred to a computer.
- Editing functions are not available when there is not enough free space in the internal memory or on the memory card.

Restrictions on Picture Editing

1st editing	2nd editing		
	D-Lighting	Crop	Small picture
D-Lighting	–	✓	✓
Crop	–	–	–
Small picture	–	–	–

- Pictures cannot be edited twice with the same editing function.
- The D-Lighting should be done first while the restricted use of combination exists.

Original Pictures and Edited

- Copies created with editing functions are not deleted if the original pictures are deleted. The original pictures are not deleted if copies created with editing functions are deleted.
- Edited copies are stored with the same recording date and time as the original.
- Edited copies do not retain the **Print set** (📖 75) and **Protect** (📖 111) settings of the original.

Enhancing Brightness and Contrast: D-Lighting

D-Lighting can be used to create copies with enhanced brightness and contrast, brightening dark portions of a picture. Enhanced copies are stored as separate files.

- 1 Select the desired picture from full-frame (📖 26) or thumbnail (📖 54) playback mode and press **MENU**.

The playback menu will be shown.

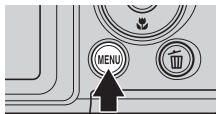

- 2 Use the multi selector to choose **D-Lighting** and press **OK**.

The original version will be shown on the left and the edited version will be shown on the right.

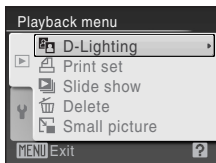

- 3 Choose **OK** and press **OK**.

A new copy with enhanced brightness and contrast is created.

To cancel D-Lighting, choose **Cancel** and press **OK**.

D-Lighting copies can be recognized by the  icon displayed during playback.

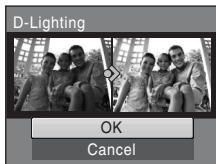

More Information

See, "Image File and Folder Names" (📖 116) for more information.

Creating a Cropped Copy: Crop

This function is only available when **MENU**  is displayed in the monitor with playback zoom ( 56) enabled. Cropped copies are stored as separate files.



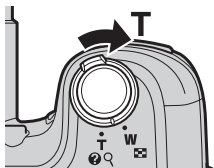

1 Rotate the zoom control to **T** (Q) in full-frame playback mode to zoom in on the image.

- Cropping can be done by enlarging the portrait image displayed until the right and left black bands on the screen cannot be seen, but the cropped image is displayed in the landscape position. If you want to crop the portrait image in the captured position, use **Rotate Image** ( 112) to change the position of the portrait image to landscape before cropping it, and then return the image to the captured position.



2 Refine copy composition.

Rotate the zoom control to **T** (Q) or **W** () to adjust the zoom ratio.

Press the multi selector , ,  or  to scroll the picture until only the portion you want to copy is visible in the monitor.



3 Press **MENU**.

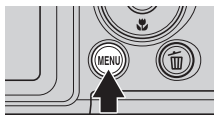



4 Use the multi selector to select **Yes** and press **OK**.

A new picture, containing only the portion visible in the monitor, is created.

To exit without cropping the picture, choose **No** and press **OK**.



About the size of the original image



The smaller the cropped area of the image, the smaller of the cropped image size (number of pixels). When the image is cropped and the size of the cropped copy is 320 × 240 or 160 × 120, a small picture icon  or  will be displayed on the left of the playback screen.

More Information

See, "Image File and Folder Names" ( 116) for more information.

Resizing Pictures: Small Picture

Create a small copy of the current picture. Small copies are stored as JPEG files with a compression ratio of 1:16. The following sizes are available.

Option	Description
 640×480	Suited to television playback.
 320×240	Suited to display on web pages.
 160×120	Suitable for e-mail attachments.

- 1 Select the desired picture from full-frame (📖 26) or thumbnail (📖 54) playback mode and press **MENU**.

The playback menu will be shown.

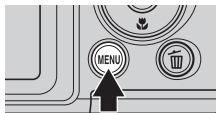

- 2 Use the multi selector to choose  **Small picture** and press **OK**.

Press **MENU** to return to the playback mode without creating a new picture.

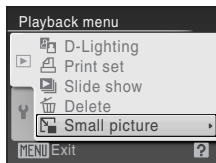

- 3 Choose the desired copy size and press **OK**.

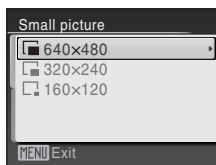

- 4 Choose **Yes** and press **OK**.

A new, smaller copy is created.

To exit without creating a smaller picture, choose **No** and press **OK**.

The copy is displayed with a gray frame.

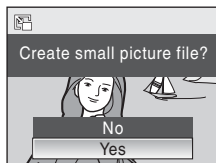





More Information

See, "Image File and Folder Names" (📖 116) for more information.

Recording Movies

To shoot movies with sound recorded via the built-in microphone, select shooting mode and follow the steps below.

- 1** Press  in shooting mode to display the shooting-mode selection menu and use the multi selector  or  to choose  and press .

The maximum length of the movie that can be recorded is displayed in the monitor.

When recording movies, electronic vibration

reduction is used automatically to reduce the effects of camera shake.  is shown on the monitor just before recording starts.

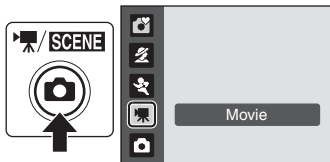

- 2** Press the shutter-release button all the way down to start recording.

Camera focuses on subject in center of frame.



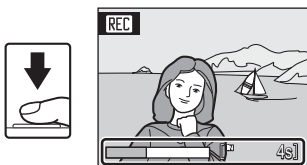

A progress bar at the bottom of the monitor shows the amount of recording time remaining.

To end recording, press the shutter-release button all the way down a second time.

Recording will end automatically if the internal memory or memory card becomes full, or after recording a single movie for 25 minutes.



Recording Movies

- Macro mode ( 34) is available. Flash mode ( 30), exposure compensation ( 35), self-timer ( 33) cannot be used.
- Macro mode settings cannot be applied or changed while movies are being recorded. Apply or change settings as necessary before movie recording begins.
- Optical zoom cannot be applied while movies are recorded. Digital zoom cannot be used just before recording a movie, but up to 2x digital zoom can be applied while movies are recorded.
- The angle of view (field of view) when recording movies is smaller than when shooting still pictures.

During Recording

The movie is being recorded from when the movie shooting was terminated to when the shooting screen appears.

Do not open the battery-chamber / memory card slot cover.

Removing the memory card or the battery during the movie recording may result in loss of the movie data or damage to the camera or the memory card.

Autofocus

Camera focuses when shutter-release button is pressed halfway and locks at this position during shooting. The focus is set to this position during shooting.

Changing Movie Settings



Movie options can be changed ( 62).

The Movie Menu



Movie options setting can be changed from the movie menu. Press **MENU** in movie mode to display the movie menu and use the multi selector to modify and apply settings.

Selecting Movie Options

The movie menu offers the options shown below.

Option	Image size and frame rate
 TV movie 640★ (default setting)	Image size: 640 × 480 pixels Frame rate: 30 frames per second
 Small size 320★	Image size: 320 × 240 pixels Frame rate: 30 frames per second
 Small size 320	Image size: 320 × 240 pixels Frame rate: 15 frames per second

Movie Options and Maximum Movie Length

Option	Internal memory (Approx. 44 MB)	Memory card (512 MB)
 TV movie 640★ (default setting)	40 s	Approx. 7 min 10 s
 Small size 320★	1 min 19 s	Approx. 14 min 10 s
 Small size 320	2 min 36 s	Approx. 25 min

* All figures are approximate. Maximum movie length or frames varies with make of memory card. The maximum recording time for movies is 25 minutes. Even if the memory card has capacity to record for more than 25 minutes, the camera displays no more than 25 minutes as the available recording time.

More Information

Image File and Folder Names →  116

Movie Playback

In full-frame playback mode (📖 26), movies are recognized by the Movie options icon (📖 62). To play a movie, display it in full-frame playback mode and press **OK**.



Use the zoom control **T** (🔍)/**W** (📐) during playback to adjust the volume.

Playback controls appear at the top of the monitor. Press the multi selector **◀** or **▶** to choose a control, then press **OK** to perform the selected operation. The following operations are available.

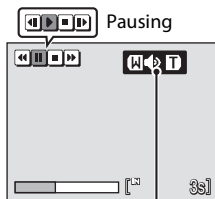

During playback Volume indicator

To	Press	Description
Rewind	⏮	Rewind movie. Playback resumes when OK is released.
Advance	⏭	Advance movie. Playback resumes when OK is released.
Pause	⏸	Pause playback. The following operations can be performed while playback is paused.
		⏮ Rewind movie by one frame. Rewind continues while OK is pressed.
		⏭ Advance movie by one frame. Advance continues while OK is pressed.
	▶	Resume playback.
End	⏹	End playback and return to full-frame playback.

Deleting Movie Files

Press **🗑** when displayed in full-frame playback mode (📖 26), or when selected in thumbnail (📖 54) playback mode. A confirmation dialog is displayed. Choose **Yes** and press **OK** to delete the movie, or choose **No** and press **OK** to return to the normal playback display without deleting the movie.



Connecting to a TV

Connect the camera to a television using the supplied audio video cable (AV cable) to play back pictures on the television.

1 Turn off the camera.

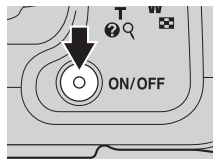

2 Connect the camera to the TV using the supplied audio video cable.

Connect the yellow plug to the video-in jack on the TV, and the white plug to the audio-in jack.

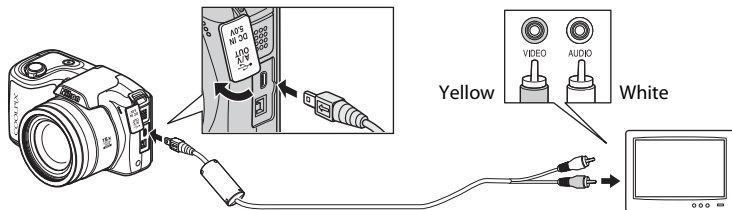

3 Tune the television to the video channel.

See the documentation provided with your television for details.

4 Hold down to turn on the camera.

The camera enters playback mode, and the pictures taken will be displayed on the television.

While connected to the TV, the camera monitor will remain off.

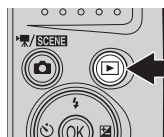

Connecting an AV Cable

When connecting the AV cable, be sure that the camera connector is oriented correctly. Do not use force when connecting the AV cable to the camera. When disconnecting the AV cable, do not pull the connector at an angle.

Video Mode

Be sure that the camera's video mode setting conforms to the standard used by your television. The video mode setting is an option set in the **Set up** menu (📖 91) > **Video mode** (📖 107).

Connecting to a Computer

Use the supplied USB cable to connect the camera to a computer, and copy (transfer) pictures to a computer with the supplied Nikon Transfer software.

Before Connecting the Camera

Install the Software

Before connecting the camera to a computer, software, including Nikon Transfer, and Panorama Maker for creating panorama images must be installed from the supplied Software Suite CD. For more information on installing the software, refer to the Quick Start Guide.

Compatible Operating Systems

Windows

Preinstalled versions of 32-bit Windows Vista Service Pack 1 (Home Basic/Home Premium/Business/Enterprise/Ultimate editions), Windows XP Service Pack 3 (Home Edition/Professional)

Macintosh

Mac OS X (version 10.3.9, 10.4.11, 10.5.5)

Refer to the Nikon website for the latest information on operating system compatibility.

Note on Power Source

When connecting the camera to a computer or printer, use batteries with adequate charge remaining to power the camera to prevent the camera from turning off unexpectedly.

To power the camera continuously for extended periods, use an AC Adapter EH-67 (available separately) (□ 115). Do not, under any circumstances, use another make or model of AC adapter. Failure to observe this precaution could result in overheating or in damage to the camera.

Transferring Pictures from a Camera to a Computer

- 1 Start the computer to which Nikon Transfer was installed.
- 2 Turn off the camera.
- 3 Connect the camera to the computer using the supplied USB cable.

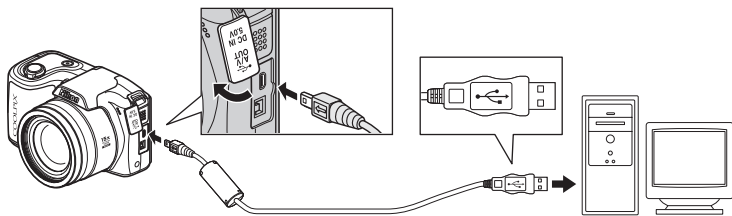

- 4 Turn on the camera.
The power-on lamp will light.

Windows Vista

When the AutoPlay dialog is displayed, select **Copy pictures to a folder on my computer using Nikon Transfer**. Nikon Transfer will start. To bypass this dialog in the future, check **Always do this for this device**.

Windows XP

When the action selection dialog is displayed, click **Nikon Transfer Copy pictures to a folder on my computer**, and click **OK**. Nikon Transfer will start. To bypass this dialog in the future, check **Always use this program for this action**.

Mac OS X

Nikon Transfer will start automatically if **Yes** was selected in the Auto-Launch setting dialog when Nikon Transfer was first installed.

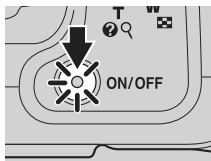

✓ Connecting the USB Cable

- When connecting the USB cable, be sure that the connectors are oriented correctly. Do not use force when connecting the USB cable. When disconnecting the USB cable, do not pull the connector at an angle.
- Connection may not be recognized when the camera is connected to a computer via a USB hub.

5 Transfer pictures when Nikon Transfer has finished loading.

- Click **Start Transfer** in Nikon Transfer. At the default setting, all pictures are transferred to the computer.

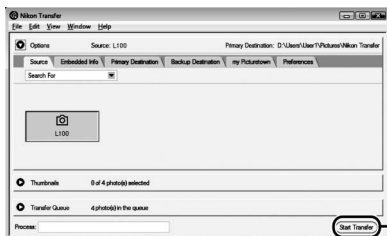

Start Transfer button

At the Nikon Transfer default setting, the folder to which pictures are transferred is automatically opened when transfer is complete.

When ViewNX is installed, ViewNX automatically starts to check the transferred pictures.

For more information on using Nikon Transfer or ViewNX, refer to the help information included with the respective software.

6 Disconnect the camera when transfer is complete.

Turn the camera off and disconnect the USB cable.

Using a Card Reader

The pictures stored on the memory card inserted into a card reader or similar device can also be transferred to the computer using Nikon Transfer.

- If the memory card has a capacity greater than 2 GB, or is SDHC-compliant, the intended device must support these features of the memory card.
- At the Nikon Transfer default settings, Nikon Transfer will start automatically when a memory card is inserted into the card reader or similar device. See step 5 of “Transferring Pictures from a Camera to a Computer” (📖 67)
- To transfer pictures stored in the camera’s internal memory to the computer, the pictures must first be copied to a memory card using the camera (📖 113).

Using Standard OS Operations to Open Image

- Navigate to the folder on the computer’s hard disk to which pictures were saved and open a picture in the viewer supplied with your operating system.

Panorama Creation with Panorama Maker

- Use a series of pictures taken using the **Panorama assist** option in scene mode (📖 36) to create a single panorama photo with Panorama Maker.
- Panorama Maker can be installed to a computer using the supplied Software Suite CD.
- After installation is complete, follow the procedure described below to start Panorama Maker.

Windows

Open **All Programs** from the **Start** menu>**ArcSoft Panorama Maker 4**>**Panorama Maker 4**.

Macintosh

Open Applications by selecting **Applications** from the Go menu, and double-click the **Panorama Maker 4** icon.

- For more information on using Panorama Maker, refer to the on-screen instructions and help information contained in Panorama Maker.

More Information

Image File and Folder Names → 📖 116

Connecting to a Printer

Users of PictBridge-compatible (📖 131) printers can connect the camera directly to the printer and print pictures without using a computer.

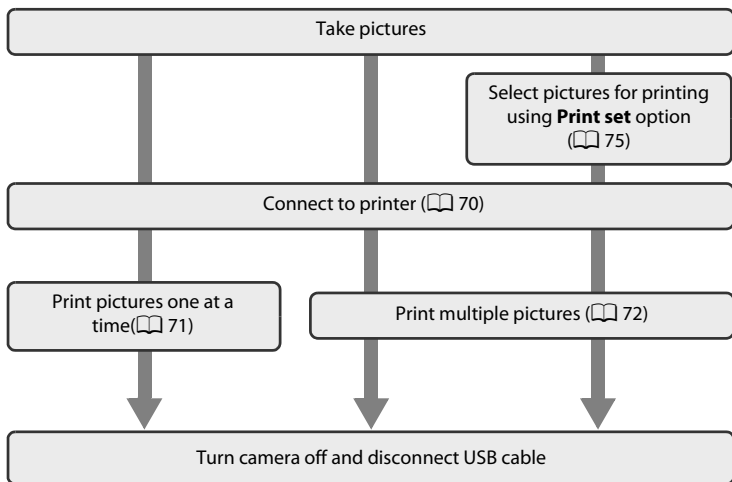

✔ Note on Power Source

When connecting the camera to a computer or printer, use batteries with adequate charge remaining to power the camera to prevent the camera from turning off unexpectedly.

To power the camera continuously for extended periods, use an AC Adapter EH-67 (available separately) (📖 115). Do not, under any circumstances, use another make or model of AC adapter. Failure to observe this precaution could result in overheating or in damage to the camera.

🔍 Printing Pictures

In addition to printing pictures transferred to a computer from your personal printer and printing over a direct camera-to-printer connection, the following options are also available for printing pictures:

- Insert a memory card into a DPOF-compatible printer's card slot
- Take a memory card to a digital photo lab

For printing using these methods, specify the pictures and the number of prints each using your camera's **Print set** menu (📖 75).

Connecting the Camera and Printer

- 1 Turn off the camera.

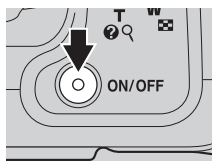

- 2 Turn on the printer.

Check printer settings.

- 3 Connect the camera to the printer using the supplied USB cable.

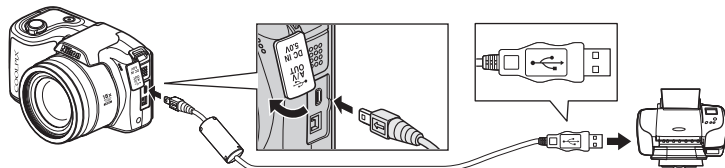

- 4 Turn on the camera.

- When connected correctly, the PictBridge startup screen ① will be displayed in the camera monitor. Then the **Print selection** screen will be displayed ②.

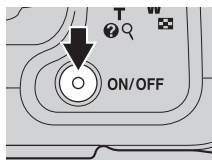

✓ Connecting the USB Cable

When connecting the USB cable, be sure that the connectors are oriented correctly. Do not use force when connecting the USB cable. When disconnecting the USB cable, do not pull the connector at an angle.

Printing Pictures One at a Time

After connecting the camera to the printer correctly (📖 70), print pictures by following the procedure below.

1 Use the multi selector to choose the desired picture and press **OK**.

- Rotate the zoom control to **W** (📷) to display 12 thumbnails, and **T** (🔍) to switch back to full-frame playback.

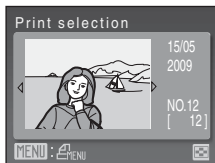

2 Choose **Copies** and press **OK**.

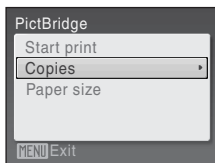

3 Choose the number of copies (up to nine) and press **OK**.



4 Choose **Paper size** and press **OK**.

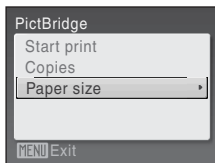

5 Choose the desired Paper size and press **OK**.

- To specify paper size using printer settings, choose **Default** in the paper size menu.

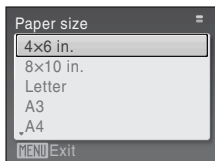

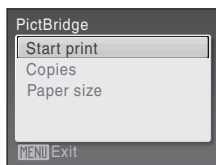
6 Choose **Start print** and press **OK**.**7** Printing starts.

Monitor display returns to that shown in step 1 when printing is complete.

To cancel before all copies have been printed, press **OK**.

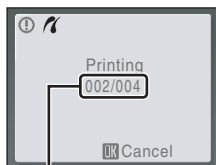

Current print/ total number of prints

Printing Multiple Pictures

After connecting the camera to the printer correctly (📖 70), print pictures by following the procedure below.

1 When the **print selection** screen is displayed, press **MENU**.

The **print menu** is displayed.

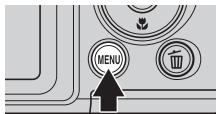
**2** Use the multi selector to choose **Paper size** and press **OK**.

Press **MENU** to exit the print menu.

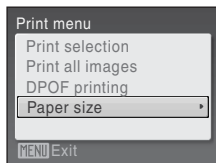
**3** Choose the desired Paper size and press **OK**.

To specify paper size using printer settings, choose **Default** in the paper size menu.

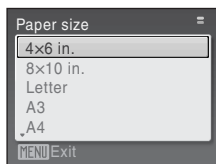

4 Choose **Print selection**, **Print all images** or **DPOF printing** and press **OK**.

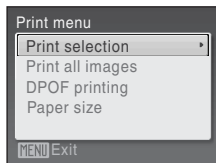

Print selection

Choose the pictures (up to 99) and number of copies (up to nine) of each.

Press the multi selector ◀ or ▶ to select pictures, and press ▲ or ▼ to set the number of copies for each.

Pictures selected for printing can be recognized by the check mark ✓ and the numeral indicating the number of copies to be printed. Pictures for which no copies have been specified will not be printed.

Rotate the zoom control to **T** (Q) to display full-frame playback, and **W** (R) to switch back to 12 thumbnails.

Press **OK** when setting is complete.

The menu shown at right will be displayed. To print, choose **Start print** and press **OK**.

Choose **Cancel** and press **OK** to return to the print menu.

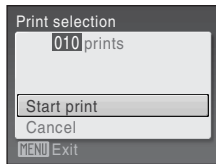
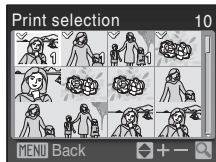

Print all images

All pictures stored in the internal memory, or on the memory card, are printed one at a time.

The menu shown at right will be displayed. To print, choose **Start print** and press **OK**.

Choose **Cancel** and press **OK** to return to the print menu.

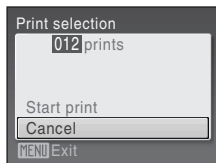

DPOF printing

Print pictures for which a print order was created in **Print set** (75).

- The menu shown at right will be displayed.
- To print, choose **Start print** and press **OK**.
- Choose **Cancel** and press **OK** to return to the print menu.
- To view the current print order, choose **View images** and press **OK**. To print pictures, press **OK** again.

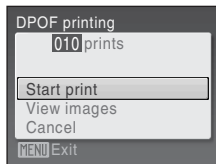

5 Printing starts.

Monitor display returns to the print menu (step 2) when printing is complete.

To cancel before all copies have been printed, press **OK**.

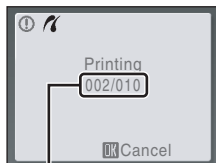

Current print/ total number of prints

Paper Size

The camera supports the following paper sizes: **Default** (the default paper size for the current printer), **3.5 × 5 in.**, **5 × 7 in.**, **100 × 150 mm**, **4 × 6 in.**, **8 × 10 in.**, **Letter**, **A3**, and **A4**. Only sizes supported by the current printer will be displayed. To specify paper size using printer settings, choose **Default** in the paper size menu.

Creating a DPOF Print Order: Print Set

The print set option in the playback menu is used to create digital “print orders” for printing on DPOF-compatible devices (📖 131).

When the camera is connected to a PictBridge-compatible printer, pictures can be printed from the printer according to the DPOF print order you have created for pictures on the memory card. If the memory card is removed from the camera, you can create the DPOF print order for pictures in the internal memory and print pictures according to the DPOF print order.

1 Press **MENU** in playback mode.

The playback menu is displayed.

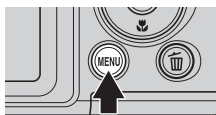

2 Use the multi selector to choose **Print set** and press **OK**.

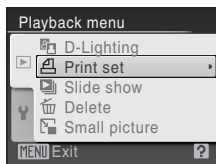

3 Choose **Select images** and press **OK**.

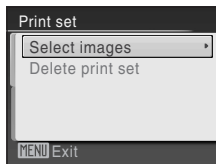

4 Choose the pictures (up to 99) and number of copies (up to nine) of each.

Press the multi selector ◀ or ▶ to choose the desired pictures. Press ▲ or ▼ to set the number of copies for each.

Pictures selected for printing can be recognized by the check mark and the numeral indicating the number of copies to be printed. Pictures for which no copies have been specified will not be printed.

Rotate the zoom control to **T** (📷) to display full-frame playback, and **W** (🖼️) to switch back to 12 thumbnails.

Press **OK** when setting is complete.

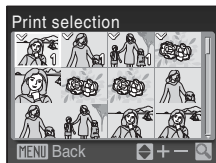



5 Choose whether or not to also print shooting date and photo information.

Choose **Date** and press **OK** to print date of recording on all pictures in the print order.

Choose **Info** and press **OK** to print photo information (shutter speed and aperture) on all pictures in the print order.

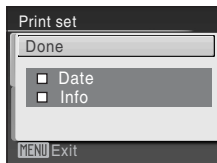

Choose **Done** and press **OK** to complete the print order and exit.

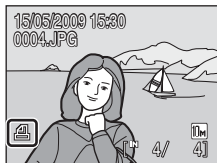

Pictures selected for printing are indicated by the  icon displayed during playback.



Notes on Printing Shooting Date and Photo Information

- When the **Date** and **Info** options are enabled in the print set menu, shooting date and photo information are printed on pictures when a DPOF-compatible ( 131) printer which supports printing of shooting date and photo information is used.
- Photo information cannot be printed when the camera is connected directly to a printer, via the supplied USB cable, for DPOF printing ( 73).
- **Date** and **Info** are reset each time the **print set** menu is displayed.

Deleting All Print Orders

Choose **Delete print set** in step 3 and press **OK**. Print orders for all pictures will be deleted.

Note on the Print Set Date Option

The date and time printed on pictures with DPOF printing when **Date** in the Print set menu is enabled, are those recorded with the picture when it was taken. Date and time printed using this option are not affected when the camera's date and time setting are changed from the setup menu after pictures are recorded.





Date Imprint











When date and time of recording are imprinted on pictures using the **Date imprint** option ( 101) in the setup menu, pictures with the date and time imprinted on them can be printed from printers that do not support printing of the date and time on pictures.

Only the Date imprint date and time on pictures will be printed, even if **Print set** is enabled with date selected in the print set screen.



Shooting Options: The Shooting Menu

The shooting menu in  (auto) mode ( 29) and the high sensitivity menu in  (high sensitivity) mode ( 50) contain the following options.





	Image mode*	 79
	Choose image size and quality (compression).	
	White balance	 81
	Match white balance to the light source.	
	Continuous	 83
	Change settings to Continuous or BSS (best shot selector).	
	Color options	 84
	Make colors more vivid or record pictures in monochrome.	
	Distortion control	 85
	Correct the distortion.	

* The Image mode setting is also available from other shooting menus (except the movie menu).

Camera settings that cannot be applied at the same time

Some functions may not be set at the same time ( 86).

Displaying the Shooting Menu

Press  in shooting mode to display the shooting-mode selection menu and set the shooting mode to  (auto) mode ( 29) or  (high sensitivity) mode ( 50).

Press **MENU** to display the shooting menu.

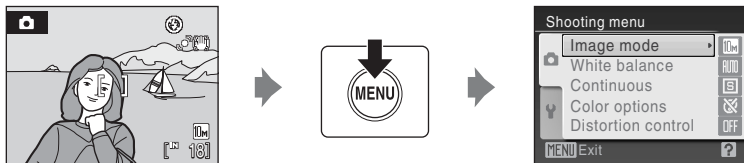

- Use the multi selector to choose and apply settings ( 11).
- To exit the shooting menu, press **MENU**.

Image Mode

Set to (auto) / (high sensitivity) → MENU (Shooting menu) → Image mode

Pictures taken with a digital camera are recorded as image files. The size of the files, and with it the number of images that can be recorded, depends on the size and quality (compression) of the images. Before shooting, choose an image mode according to how you plan to use the picture.

Setting	Size (pixels)	Description
High (3648 ★)	3648 × 2736	Highest quality, suitable for enlargements or high-quality prints. The compression ratio is approximately 1:4.
Normal (3648) (Default setting)	3648 × 2736	Best choice in most situations. The compression ratio is approximately 1:8.
Normal (2592)	2592 × 1944	
Normal (2048)	2048 × 1536	Smaller size allows more pictures to be stored. The compression ratio is approximately 1:8.
PC screen (1024)	1024 × 768	Suited to display on a computer monitor. The compression ratio is approximately 1:8.
TV screen (640)	640 × 480	Suited to full-screen display on a television, or distribution by e-mail or the web. The compression ratio is approximately 1:8.
16:9 (3584)	3584 × 2016	Pictures with an aspect ratio of 16:9 can be taken. The compression ratio is approximately 1:8.









The icon for the current setting is displayed in the monitor in shooting and playback modes (8, 9).

Image Mode for Sport Continuous Mode and High Sensitivity Mode

- In sport continuous mode (48) and high sensitivity mode (50), the following image mode settings are available; **Normal (2048)**, **PC screen (1024)**, **TV screen (640)**, and **16:9 (1920)** (image size 1920 × 1080, compression ratio 1/8).
- The image mode settings in the sport continuous menu and high sensitivity menu are stored separately from each other and from the image mode setting in other shooting modes, and are not applied to the other modes.

Number of Exposures Remaining

The following table lists the approximate number of pictures that can be stored in internal memory and on a 512 MB memory card. Note that the number of pictures that can be stored will differ depending on the composition of the picture (due to JPEG compression). In addition, this number may differ depending on the make of memory card, even if the capacity for the memory card is the same.

Image mode	Internal memory (Approx. 44 MB)	Memory card ^{*1} (512 MB)	Print size (printed at 300 dpi; cm/in.) ^{*2}
 High (3648 ★)	9	Approx. 95	Approx. 31 × 23/12 × 9
 Normal (3648)	18	Approx. 190	Approx. 31 × 23/12 × 9
 Normal (2592)	35	Approx. 375	Approx. 22 × 16/8.5 × 6.5
 Normal (2048)	55	Approx. 590	Approx. 17 × 13/7 × 5
 PC screen (1024)	188	Approx. 2010	Approx. 9 × 7/3.5 × 2.5
 TV screen (640)	353	Approx. 3770	Approx. 5 × 4/2 × 1.5
 16:9 (3584)	25	Approx. 265	Approx. 30 × 17/12 × 6.5
 16:9 (1920)	80	Approx. 860	Approx. 16 × 9/6.5 × 3.5

^{*1} If the number of exposures remaining is 10,000 or more, the number of exposures remaining display shows **9999**.

^{*2} Print sizes are calculated by dividing the number of pixels by printer resolution (dpi) and multiplying by 2.54 cm (1 in.). However, at the same image size, pictures printed at higher resolutions will print smaller than the size indicated, and those printed at lower resolutions will print larger than the size indicated.

WB White Balance

Set to (auto) / (high sensitivity) → MENU (Shooting menu) → White balance

The color of light reflected from an object varies with the color of the light source. The human brain is able to adapt to changes in the color of the light source, with the result that white objects appear white whether seen in the shade, direct sunlight, or under incandescent lighting. Digital cameras can mimic this adjustment by processing images according to the color of the light source. This is known as “white balance.”

Although the default setting, **Auto** can be used under most types of lighting, you can apply the white balance setting suited to a particular light source to achieve more accurate results.

Auto (default setting)

White balance automatically adjusted to suit lighting conditions. Best choice in most situations.

Preset manual

Neutral-colored object used as reference to set white balance under unusual lighting conditions. Please refer to “Preset Manual” for more information(82).

Daylight

White balance adjusted for direct sunlight.

Incandescent

Use under incandescent lighting.

Fluorescent

Use under most types of fluorescent lighting.

Cloudy

Use when taking pictures under overcast skies.

Flash

Use with the flash mode.

The effects of the selected option can be previewed in the monitor. At settings other than **Auto**, the icon for the current setting is displayed on the monitor (8).

Flash Mode

At white-balance settings other than **Auto** or **Flash**, turn the flash off (30).

Preset Manual

Preset manual is used with mixed lighting or to compensate for light sources with a strong color cast (for example, to make pictures taken under a lamp with a red shade look as though they had been taken under white light).

1 Place a white or gray reference object under the lighting that will be used during shooting.

2 Use the multi selector to choose **PRE Preset manual** in the **White balance** menu, and press **OK**.

The camera zooms in.

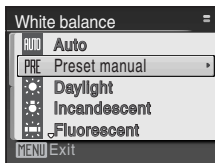

3 Choose **Measure**.

To apply the most recently measured value for preset manual, choose **Cancel** and press **OK**. The most recently measured value will be applied for white balance.

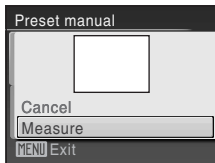

4 Frame the reference object.

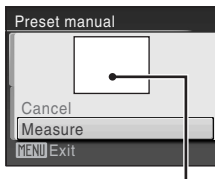

Reference object frame

5 Press **OK**.

The shutter is released and the new white-balance value is set.
No pictures are recorded.

✔ Note on Preset Manual

Regardless of the flash mode selected, the flash will not fire when **OK** is pressed in step 5. Therefore, the camera cannot measure a value for preset manual for when the flash is used.

Continuous

Set to  (auto) /  (high sensitivity) → MENU (Shooting menu) →  Continuous

Change settings to Continuous or BSS (best shot selector).

Flash will be switched off for **Continuous**, **BSS** or **Multi-shot 16**, and focus, exposure and white balance are fixed at the values for the first picture in each series.

Single (default setting)

One shot is taken each time shutter-release button is pressed.

Continuous



While the shutter-release button is held down, up to 7 pictures are taken at a rate of about 1.2 frames per second (fps) when image mode is set to  **Normal (3648)**.

BSS (Best Shot Selector)

The “best shot selector” is recommended when shooting with the flash off or the camera zoomed in, or in other situations in which inadvertent motion can result in blurred pictures.

When BSS is on, the camera takes up to 10 pictures while the shutter-release button is held down. The sharpest picture in the series is automatically selected and saved.

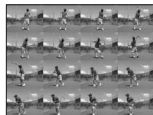

Multi-shot 16

Each time the shutter-release button is pressed all the way down, the camera takes 16 shots at a rate of about 7.5 frames per second (fps), then arranges them in a single picture. Image mode is locked at  **Normal (2592)** when using auto mode, and locked at  **Normal (2048)** when using high sensitivity mode. Digital zoom cannot be applied.



At settings other than **Single**, the indicator for the current setting is displayed in the monitor ( 8).

Note on Continuous Shooting

- The maximum frame rate with continuous shooting may vary, depending upon the current image mode setting and the memory card used.
- **Distortion control** ( 85) cannot be used at the same time as **Continuous**, **BSS**, or **Multi-shot 16** ( 86).

Note on BSS

BSS may not produce the desired results if the subject moves or the composition changes while the shutter-release button is pressed all the way down.

Note on Multi-shot 16

If bright objects such as the sun or electric lights are captured, vertical streaks of light may appear in the recorded images. We recommend that you avoid capturing bright objects during continuous shooting.

Color Options

Set to  (auto) /  (high sensitivity) → MENU (Shooting menu) →  Color options

Make colors more vivid or record pictures in monochrome.

 **Standard color (default setting)**
Use for pictures exhibiting natural color.

 **Vivid color**
Use to achieve a vivid, “photoprint” effect.

 **Black-and-white**
Record pictures in black-and-white.

 **Sepia**
Record pictures in sepia tones.

 **Cyanotype**
Record pictures in cyan-blue monochrome.

The effects of the selected option can be previewed in the monitor. At settings other than **Standard color**, the icon for the current setting is displayed in the monitor ( 8).

Distortion Control

Set to  (auto) /  (high sensitivity) → MENU (Shooting menu) →  Distortion control

Specify whether or not the distortion is corrected. Enabling distortion control reduces the size of the frame.

On

Distortion at frame peripheries is corrected.

Off (default setting)



No distortion correction performed.

At settings other than **Off**, the icon for the current setting is displayed in the monitor ( 8).

Note on Distortion Control

When **Distortion control** is set to **On**, **Continuous**, **BSS**, and **Multi-shot 16** cannot be used ( 86).

Camera Settings that Cannot Be Set at the Same Time

Restrictions apply to the following settings in  (auto) mode and  (high sensitivity) mode.



Flash mode

Setting **Continuous** to **Continuous**, **BSS** or **Multi-shot 16** fixes flash to  (off).
Applied setting is restored when **Single** is selected.

Self-timer

If self-timer is on, only one shot will be taken when shutter is released, regardless of settings chosen for **Continuous**.
Applied **Continuous** settings are restored when picture is taken or self-timer is turned off.

Continuous

If **Continuous** setting is set to **Multi-shot 16**, **Image mode** will be set to  **Normal (2592)** during auto mode, and set to  **Normal (2048)** during high sensitivity mode.
When another **Continuous** setting is selected, **Image mode** returns to the previous setting.

White balance











White balance is automatically set to **Auto** and cannot be adjusted when **Black-and-white**, **Sepia** or **Cyanotype** is selected for **Color options**.
Applied **White balance** setting is restored when **Standard color** or **Vivid color** is selected.

Distortion control

When **Distortion control** is set to **On**, **Continuous** mode is automatically set to **Single**. Even if **Distortion control** is changed back to **Off**, **Continuous** mode will still be set to **Single**.

Playback Options: The Playback Menu

The playback menu contains the following options.

	D-Lighting	 58
Enhances brightness and contrast in dark portions of pictures.		
	Print set	 75
Select pictures to print and the number of copies for each.		
	Slide show	 89
View pictures stored in the internal memory or on a memory card in an automatic slide show.		
	Delete	 90
Delete selected pictures or all pictures.		
	Small picture	 60
Create a small copy of the current picture.		

Displaying the Playback Menu

Press  to enter playback mode.

Display the playback menu by pressing **MENU**.

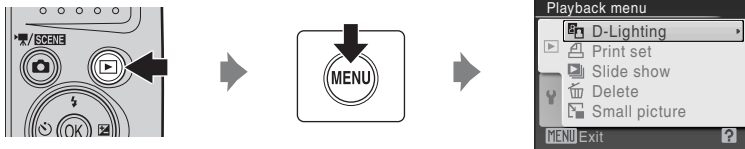

- Use the multi selector to choose and apply settings ( 11).
- To exit the playback menu, press **MENU**.

Selecting Multiple Pictures

The screen shown at right will be displayed in the menus (shown below) when choosing pictures.

Playback menu: **Print set: Select images** (📖 75)

Delete: Erase selected images
(📖 90)

Setup menu: **Welcome screen** (📖 95)

Protect (📖 111)

Rotate image (📖 112)

Copy: Selected images (📖 113)

Follow the procedure described below to choose the pictures.



- 1 Press the multi selector ◀ or ▶ to choose the desired picture.

Only one picture can be selected for **Rotate image** and **Welcome screen**. Proceed to step 3.

Rotate the zoom control to **T** (🔍) to display full-frame playback, and **W** (📐) to switch back to 12 thumbnails.





- 2 Press ▲ or ▼ to select **ON** or **OFF** (or the number of copies).

When **ON** is selected, a check mark (✓) is displayed in the top left corner of the current picture. Repeat steps 1 and 2 to select additional pictures.





- 3 To fix the selection of pictures, press **OK**.

Slide Show

Press the  button (Playback mode) → MENU (Playback menu) →  Slide show

Play back pictures, stored in the internal memory or on a memory card, one by one in an automated “slide show”.

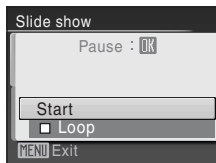

1 Use the multi selector to choose **Start** and press .

To repeat the slide show automatically, enable **Loop** and press  before choosing **Start**. The check mark () will be added to the loop option when enabled.



2 The slide show begins.

While the slide show is in progress, the following operations can be performed:

- Use the multi selector to switch pictures. Hold  or  down to fast forward or rewind.
- Press  to pause the slide show.





3 Choose **End** or **Restart**.

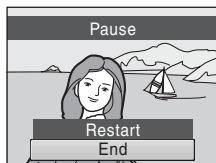

When the slide show ends or is paused, choose **End** and press  to return to the playback menu, or choose **Restart** to play the slide show again.



Notes on Slide Show

- Only the first frame of movies ( 63) included in slide shows is displayed.
- Even if **Loop** is selected, the monitor can continuously display the Slide Show for up to 30 minutes ( 105).

Delete

Press the  button (Playback mode) → MENU (Playback menu) →  Delete

Delete selected pictures or all pictures.



Erase selected images

Delete selected pictures ( 88).

Erase all images































Delete all pictures.

Notes on Deletion





- Once deleted, pictures cannot be recovered. Transfer important images to a computer before deletion.
- Pictures marked with the  icon are protected and cannot be deleted ( 111).

Basic Camera Setup: The Setup Menu

The setup menu contains the following options.

	Menus  94
	Choose how menus are displayed.
	Welcome screen  95
	Select screen displayed when camera is turned on.
	Date  96
	Set camera clock and choose home and destination time zones.
	Monitor settings  99
	Adjust photo info, image review, and brightness settings.
	Date imprint  101
	Imprint date on pictures.
	Vibration reduction  102
	Specify the vibration reduction setting for shooting still pictures.
	Motion detection  103
	Set whether or not motion detection is used to reduce blurring caused by subject motion or camera shake when shooting still pictures.
	AF assist  104
	Enable or disable AF-assist illumination.
	Sound settings  104
	Adjust sound settings.
	Auto off  105
	Set time before camera enters standby mode.
	Format memory/Format card  106
	Format internal memory or memory card.
	Language  107
	Choose the language used for camera monitor display.
	Video mode  107
	Adjust settings for connection to a television.
	Blink warning  108
	Set whether or not to detect human subjects with eyes closed when shooting pictures in the face priority ( 24).
	Reset all  109
	Restore camera settings to default values.

Basic Camera Setup: The Setup Menu

	Battery type 📖 111
	Select the type of batteries used.
	Protect 📖 111
	Protect selected pictures from accidental deletion.
	Rotate image 📖 112
	Change the orientation of a picture.
	Copy 📖 113
	Copy files between memory card and internal memory.
	Firmware version 📖 114
	Display camera firmware version.

Displaying the Setup Menu

Display the menu screen and select  (Setup).

1 Press MENU to display the menu screen.

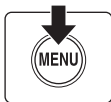

When using easy auto mode, smile mode, scene mode, or movie mode

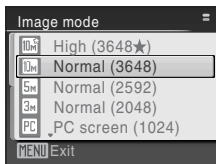

When using  (auto) mode, sport continuous mode, high sensitivity mode, or playback mode

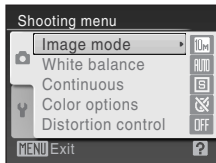

2 Press the multi selector .

You can now select a tab.

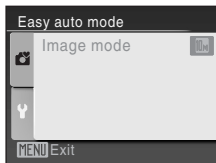

3 Press ▲ or ▼ to select the Y tab.

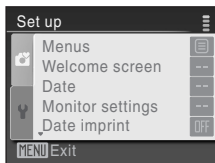

4 Press ► or OK.

- You can now select an item from the setup menu.
- Use the multi selector to choose and apply settings (📖 11).
- To exit the setup menu, press the **MENU** or press ◀ and select another tab.

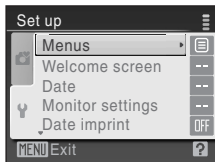

Menus

Press the **MENU** button →  (Setup menu) (📖 92) →  Menus

Choose the initial menu displayed.

Text (default setting)

Menus are displayed in list format.

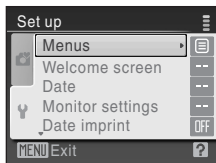



Icons

All menu items can be displayed in a single page.

Menu names



Welcome Screen

Press the **MENU** button →  (Setup menu) (📖 92) →  Welcome screen

You can select the welcome screen to be displayed when the camera is turned on.

None (default setting)

No welcome screen will be displayed.

COOLPIX

Displays a welcome screen.

Select an image

Select a picture in the internal memory or on the memory card for the welcome screen. Choose a picture in the **Select image** screen and press . As the selected image is stored in the camera, the image will appear in the welcome screen even if the original picture is deleted.

Pictures recorded at an **Image mode** setting of **16:9** (📖 79) and picture copies created using small picture (📖 60) or crop (📖 59) that are smaller than 320 × 240 cannot be selected.

Date

Press the **MENU** button → **Y** (Setup menu) (📖 92) →  Date





Set the camera clock.

When traveling, you can also set the time zone of the travel destination.



Date

Set camera clock to current date and time.

The operation of each option displayed is as follows.

-  : Move through the items (day, month, year, hour, minute and the order of the date).
-  : Adjusts the content of the selected item.
- : Activates the setting.

Time zone

Set the home () time zone (district) or daylight saving time. When the destination time zone () is selected, the time difference (📖 98) is automatically calculated and the date and time in the selected region are recorded. Useful when travelling.

Setting Travel Destination Time Zone

- 1 Use the multi selector to choose **Time zone** and press .

The Time zone menu is displayed.

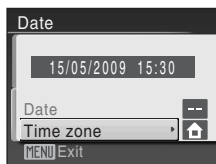

- 2 Choose  **Travel destination** and press .

The date and time displayed on the monitor changes according to the region currently selected.

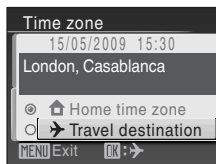

3 Press **▶**.

The new city time zone menu is displayed.

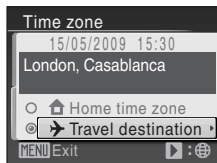
**4** Press **◀** or **▶** to choose the travel destination time zone (city name).

To use the camera in an area where daylight saving time is in effect, press **▲** to display the mark on the top of the monitor and set the daylight saving time. When the daylight saving time goes into effect, the time is automatically advanced one hour. To release the daylight saving time setting, press **▼**.

Press **OK** to enter the travel destination.

While the travel destination time zone is selected, the icon will be displayed in the monitor when the camera is in shooting mode.

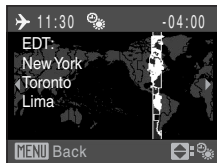
**✓ The Clock Battery**

The camera's clock is powered by a clock battery that is independent of the batteries that powers the camera. The clock battery charges when the main batteries are installed or an AC adapter is connected, and can provide several days of backup power after about ten hours of charging.

📎 (Home Time Zone)

- To switch to the home time zone, choose **Home** in step 2 and press **OK**.
- To change the home time zone, choose **Home** in step 2 and perform steps 3 and 4, to set the home time zone.

📎 Daylight Saving Time

When the summer saving time begins or ends, turn the daylight saving time option on or off using the home time zone display in Step 4.

 **Time Zones**  **16**

The camera supports the time zones listed below.

For time differences not listed below, set the camera clock to local time.

UTC +/-	Time zone	UTC +/-	Time zone
-11	Midway, Samoa	+1	Madrid, Paris, Berlin
-10	Hawaii, Tahiti	+2	Athens, Helsinki, Ankara
-9	Alaska, Anchorage	+3	Moscow, Nairobi, Riyadh, Kuwait, Manama
-8	PST (PDT): Los Angeles, Seattle, Vancouver	+4	Abu Dhabi, Dubai
-7	MST (MDT): Denver, Phoenix, La Paz	+5	Islamabad, Karachi
-6	CST (CDT): Chicago, Houston, Mexico City	+5.5	New Delhi
-5	EST (EDT): New York, Toronto, Lima	+6	Colombo, Dhaka
-4	Caracas, Manaus	+7	Bangkok, Jakarta
-3	Buenos Aires, Sao Paulo	+8	Beijing, Hong Kong, Singapore
-2	Fernando de Noronha	+9	Tokyo, Seoul
-1	Azores	+10	Sydney, Guam
±0	London, Casablanca	+11	New Caledonia
		+12	Auckland, Fiji

Monitor Settings

Press the **MENU** button → **Y** (Setup menu) (📖 92) →  Monitor settings

The following settings are available.

Photo info

Choose information displayed in monitor during shooting and playback mode.
(📖 100)

Image review

- **On** (default setting): Pictures are automatically displayed briefly immediately after shooting.
- **Off**: Pictures are not displayed after shooting.







Brightness

Choose from five settings for monitor brightness. The default setting is **3**.

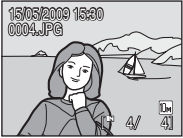

Photo Info

The following display options are available.

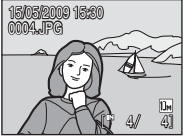
See “The Monitor” (📖 8, 9) for information on indicators in the monitor.

	Shooting mode	Playback mode
Show info		
Auto info (default setting)	After the same information as in Show info above is displayed for a few seconds, display will be the same as Hide info .	
Hide info		
Framing grid	 <p>In the following shooting modes, a framing grid is displayed to help frame pictures;</p> <ul style="list-style-type: none"> •  (Easy auto) •  (High sensitivity) •  (Auto) <p>In other shooting modes, the current settings or operation guide is displayed, as in Auto info above.</p>	 <p>The current settings or operation guide is displayed, as in Auto info above.</p>

Date Imprint

Press the **MENU** button →  (Setup menu) (📖 92) →  Date imprint

Date and time are imprinted on pictures. Date can be printed from printers that do not support the date imprinting (📖 76).

Off (default setting)

Date and time are not imprinted on pictures.

Date

Date is imprinted on the bottom right corner of pictures taken while this option is in effect.

Date and time

Date and time are imprinted on the bottom right corner of pictures taken while this option is in effect.

At settings other than **Off**, the icon for the current setting is displayed in the monitor (📖 8).

Date imprint

- Imprinted dates form a permanent part of image data and cannot be deleted.
- Date imprint is disabled in the following situations.
 - When scene mode is set to **Museum** or **Panorama assist**.
 - When **Continuous** (📖 83) is set to **Continuous** or **BSS**.
 - When using sport continuous mode.
 - When recording movies.
- Dates imprinted at an **Image mode** setting (📖 79) of **TV screen (640)** may be difficult to read. Choose **PC screen (1024)** or larger when using date imprint.
- The date is recorded using the format selected in the setup menu's **Date** item (📖 16, 96).

Date Imprint and Print Set

When pictures are printed from DPOF-compatible printers that can print date and photo information, you can use **Print Set** (📖 75) and print the shooting date and photo information on the pictures. In such a case, it is unnecessary to imprint date and time on pictures beforehand using **Date Imprint**.

Vibration reduction

Press the **MENU** button → **Y** (Setup menu) (📖 92) →  **Vibration reduction**

Specify the vibration reduction setting for shooting still pictures. Vibration reduction effectively corrects blur that commonly occurs when shooting with zooming or at slow shutter speeds.

Turn vibration reduction **off** when using a tripod to stabilize the camera during shooting.

On (default setting)

Vibration reduction is enabled.

Off

Vibration reduction is not enabled.

The vibration reduction setting can be confirmed on the monitor during shooting (When it is set to **Off**, nothing is displayed) (📖 21).

Notes on Vibration reduction

- Vibration reduction may take a few seconds to activate after the power is turned on, or the camera enters shooting mode from playback mode. Wait until the display stabilizes before shooting.
- Due to characteristics of the vibration reduction function, images displayed on the camera's monitor immediately after shooting may appear blurry.
- Vibration reduction may be unable to completely eliminate the effects of camera shaking in some situations.

Using Vibration Reduction with Movies

When recording movies, electronic vibration reduction is used automatically to reduce the effects of camera shake.

Motion Detection

Press the **MENU** button → **Y** (Setup menu) (📖 92) →  Motion detection

Set whether or not the camera automatically increases the shutter speed to reduce blurring when motion is detected while shooting still pictures.

Auto (default setting)

When camera detects the movement of the subject or camera shake, the shutter speed will be increased for reducing the blur.

However, motion detection is not active when the flash mode is set to fill flash.

Note that for some scene modes, motion detection turns off automatically even if **Auto** is selected (📖 38-43).

Motion detection is not active in the following situations:

- When using sport continuous mode (📖 48)
- When using high sensitivity mode (📖 50)
- When **Continuous** is set to **Multi-shot 16** (📖 83)

Off

Motion detection is not enabled.



The motion detection setting can be confirmed on the monitor during shooting (When it is set to **Off**, nothing is displayed) (📖 21).

When the camera detects shaking and increases shutter speed, the motion detection indicator turns green.

Notes on Motion detection

- Blurring caused by camera shake or subject movement may not be eliminated if there is excessive shake or movement.
- Motion detection may not function if the subject exhibits significant movement or is too dark.
- The pictures taken may become somewhat grainy.

AF Assist

Press the MENU button →  (Setup menu)  92 →  AF assist

Change settings for AF-assist illumination.



Auto (default setting)

AF-assist illumination will be used to assist the focus operation when the subject is poorly lit. The illuminator has a range of about 3.5 m (11 ft. 5 in.) at the maximum wide-angle position and 2.5 m (8 ft.) at the maximum telescopic position. However, the AF-assist illumination will not turn on in some scene modes even if **Auto** is selected ( 37-41).

Off

Disable this function. The camera may be unable to focus if lighting is poor.

Sound Settings

Press the MENU button →  (Setup menu)  92 →  Sound settings

Adjust the following sound settings.

Button sound

Turn the button sound **On** or **Off**. When **On** (default setting) is selected, a beep will sound once when operations are completed successfully, twice when the focus has been locked, and three times when an error is detected, and Start-up sound will also play when the camera is turned on.

Shutter sound

Choose shutter sound from **On** (default setting) or **Off**.

Auto Off

Press the **MENU** button → **Y** (Setup menu) (📖 92) →  Auto off

When the camera is on and a period of time passes without any operations, the camera will enter the standby mode (📖 15) to save power.

Once in standby mode, the power lamp will blink, and if no operations are performed for three minutes the camera turns off.

Use this option to set time before camera enters standby mode.

Auto off



Choose the time allowed to elapse before the camera enters standby mode if no operations are performed from **30 s** (default setting), **1 min**, **5 min**, and **30 min**.

Sleep mode

If **On** (default setting) is selected, the camera will enter standby mode when there is no change in the brightness of the subject, even before the time selected in the auto off menu has elapsed. The camera will enter sleep mode after 30 seconds when **Auto off** is set to **1 min** or less, or after 1 minute when **Auto off** is set to **5 min** or more.

Exiting Standby Mode

Press one of the following buttons to exit standby mode.

- Power switch
- Shutter-release button
-  button
-  button

Notes on Auto Off

The time allowed to elapse before the camera enters standby mode is fixed in the following cases:

- While menus are displayed: 3 minutes
- While slide show is in progress: Up to 30 minutes

Format Memory / **Format Card**

Press the **MENU** button →  (Setup menu) (📖 92) →  **Format memory** /  **Format card**

Use this option to format the internal memory or a memory card.

Formatting internal memory

To format the internal memory, remove the memory card from the camera.

The **Format memory** option appears in the setup menu.

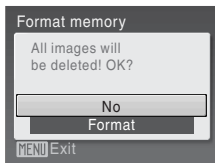

Formatting a Memory Card

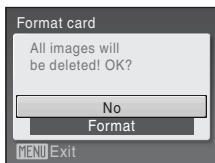

When the memory card is inserted in the camera, the **Format card** option appears in the setup menu.



Formatting Internal Memory and Memory Cards

- Formatting the internal memory or memory cards permanently deletes all data. Be sure to transfer important pictures to a computer before formatting.
- Do not turn the camera off or open the battery-chamber/memory card slot cover during formatting.
- The first time you insert the memory cards used in other devices into this camera, be sure to format them using this camera.

Language



Press the **MENU** button →  (Setup menu) (📖 92) →  Language

Choose one of 24 languages for display of camera menus and messages.

Čeština	Czech
Dansk	Danish
Deutsch	German
English	(default setting)
Español	Spanish
Ελληνικά	Greek
Français	French
Indonesia	Indonesian
Italiano	Italian
Magyar	Hungarian
Nederlands	Dutch
Norsk	Norwegian



Polski	Polish
Português	Portuguese
Русский	Russian
Suomi	Finnish
Svenska	Swedish
Türkçe	Turkish
عربي	Arabic
中文简体	Simplified Chinese
中文繁體	Traditional Chinese
日本語	Japanese
한글	Korean
ภาษาไทย	Thai

Video Mode

Press the **MENU** button →  (Setup menu) (📖 92) →  Video mode

Adjust settings for connection to a television. Choose from **NTSC** and **PAL**.

Blink Warning

Press the MENU button →  (Setup menu) (📖 92) →  Blink warning

Set whether or not to detect human subjects with eyes closed when shooting pictures in the face priority (📖 24).

On (default setting)

When the camera detects that one or more human subjects have closed their eyes shortly after recognizing the faces and shooting them, the **Did someone blink?** screen will appear on the monitor. The face of the human subject that may have closed his/her eyes is framed by a yellow border. In such a case, you can check the shot picture and determine if you take the picture again. When using smile mode (📖 52), the "Did someone blink?" screen is not displayed regardless of the blink warning setting.

Off







Blink warning doesn't take effect.

Operating the Did someone blink? Screen

When the camera detects a human subject with closed eyes, the **Did someone blink?** screen will appear on the monitor.

The following operations are available in the **Did someone blink?** screen. If no operations are performed for a few seconds, the screen automatically returns to the shooting mode screen.



To	Use	Description
Enlarge and display the detected face	T (🔍)	Rotate the zoom control to T (🔍).
Switch to full-frame playback	W (📷)	Rotate the zoom control to W (📷).
Select the face to be displayed		If the camera detects more than one human subjects with their eyes closed, press ▲▼◀▶ during the enlarged display to switch over the face displayed.
Delete the shot picture		Press  .
Switch to shooting mode		Press  or the shutter-release button.
		

Reset All

Press the **MENU** button → **Y** (Setup menu) (📖 92) →  Reset all

When **Reset** is selected, the camera's settings will be restored to their default values.

Pop-up Menu

Option	Default value
Flash mode (📖 30)	Auto
Self-timer (📖 33)	Off
Macro mode (📖 34)	Off
Exposure compensation (📖 35)	0.0

Scene mode

Option	Default value
Scene mode (📖 36)	Portrait
White balance in Food mode (📖 44)	Center



Sport continuous Menu

Option	Default value
Sport continuous (📖 48)	Continuous H
Image mode (📖 49)	 Normal

Movie Menu

Option	Default value
Movie options (📖 62)	TV movie 640★

Shooting Menu/High sensitivity Menu

Option	Default value
Image mode (📖 79)	 Normal/  Normal (High sensitivity mode)
White balance (📖 81)	Auto
Continuous (📖 83)	Single
Color options (📖 84)	Standard color
Distortion control (📖 85)	Off

Setup Menu

Option	Default value
Menus (📖 94)	Text
Welcome screen (📖 95)	Disable welcome
Photo info (📖 99)	Auto info
Image review (📖 99)	On
Brightness (📖 99)	3
Date imprint (📖 101)	Off
Vibration reduction (📖 102)	On
Motion detection (📖 103)	Auto
AF assist (📖 104)	Auto
Button sound (📖 104)	On
Shutter sound (📖 104)	On
Auto off (📖 105)	30 s
Sleep mode (📖 105)	On
Blink warning (📖 108)	On

Others

Option	Default value
Paper size (📖 71, 72)	Default

- Choosing **Reset all** also clears the current file number (📖 116) from the memory. Numbering will continue from the lowest number available. To reset file numbering to "0001", delete all pictures (📖 90) before selecting **Reset all**.
- The following settings in the menus will remain unaffected even if **Reset all** is performed.



Shooting menu:

Preset manual in the **White balance** menu (📖 82)

Setup menu:

Settings for picture registered for **Welcome screen** (📖 95), **Date** (📖 96), **Language** (📖 107), **Video mode** (📖 107), and **Battery type** (📖 111)

Battery Type

Press the MENU button →  (Setup menu) (📖 92) →  Battery type

To ensure that the camera shows the correct battery level (📖 20), choose the type that matches the batteries currently in use.

Alkaline (default setting)	LR6/L40 (AA-size) alkaline batteries
Lithium	FR6/L91 (AA-size) lithium batteries



Protect

Press the MENU button →  (Setup menu) (📖 92) →  Protect

Protect selected pictures from accidental deletion. See “Selecting Multiple Pictures” (📖 88) for more information on using this function. Note, however, that formatting the camera’s internal memory or the memory card will permanently erase protected files (📖 106).

Protected pictures are recognized by the  icon (📖 9, 54) in playback mode.

Rotate Image

Press the **MENU** button →  (Setup menu) (📖 92) →  Rotate image

Set the picture orientation (vertical or horizontal frame) displayed on the camera monitor after the pictures are taken.

Pictures can be rotated 90° clockwise or counterclockwise.

Pictures that were recorded in the portrait (vertical) orientation can be rotated up to 180° in either direction.

When the image is selected in the picture selection screen (📖 88), the Rotate image screen appears. Press the multi selector ◀ or ▶ to rotate the image 90°.

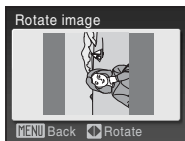

Rotate 90°
counterclockwise

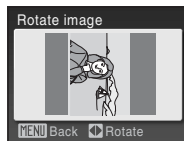
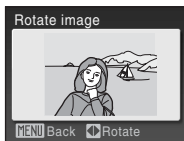

Rotate 90°
clockwise



Press **OK** to select the displayed direction and the vertical / horizontal position data will be recorded on the picture.



Copy

Press the MENU button →  (Setup menu) (📖 92) →  Copy

Copy pictures between the internal memory and a memory card.

1 Select an option from the copy screen using the multi selector and press .

 → : Copy pictures from internal memory to memory card.

 → : Copy pictures from memory card to internal memory.

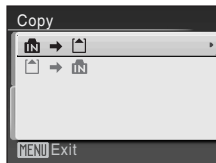

2 Choose the copy option and press .

Selected images: Copy pictures selected from the picture selection screen (📖 88).

All images: Copy all pictures.

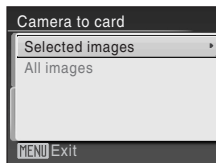

Notes on Copy

- JPEG- and AVI-format files can be copied. Files recorded in any other format cannot be copied.
- Pictures taken with another make of camera or that have been modified on a computer cannot be copied.
- Edited copies have the same protection marking (📖 111) as the original, but are not marked for printing (📖 75).

More Information

Image File and Folder Names → 📖 116

Ver. Firmware Version

Press the **MENU** button → **Y** (Setup menu) (📖 92) → **Ver.** Firmware version

View the current camera firmware version.



Firmware version

Optional Accessories

AC adapter	AC Adapter EH-67
USB Cable	USB Cable UC-E6
AV Cable	Audio Video Cable EG-CP14
Lens Cap	Lens Cap LC-CP20

Approved Memory Cards

The following Secure Digital (SD) memory cards have been tested and approved for use in this camera.

All cards of the designated make and capacity can be used, regardless of speed.

SanDisk	512 MB, 1 GB, 2 GB ^{*1} , 4 GB ^{*2} , 8 GB ^{*2} , 16 GB ^{*2}
TOSHIBA	512 MB, 1 GB, 2 GB ^{*1} , 4 GB ^{*2} , 8 GB ^{*2} , 16 GB ^{*2}
Panasonic	512 MB, 1 GB, 2 GB ^{*1} , 4 GB ^{*2} , 8 GB ^{*2} , 16 GB ^{*2}
Lexar	1 GB, 2 GB ^{*1} , 4 GB ^{*2} , 8 GB ^{*2}

^{*1} If the memory card will be used with a card reader or similar device, check that device supports 2 GB cards.



^{*2}  SDHC-compliant. If the memory card will be used with a card reader or similar device, check that device supports SDHC.

Operation is not guaranteed with other makes of card. Contact the manufacturer for details on the above cards.

Image File and Folder Names

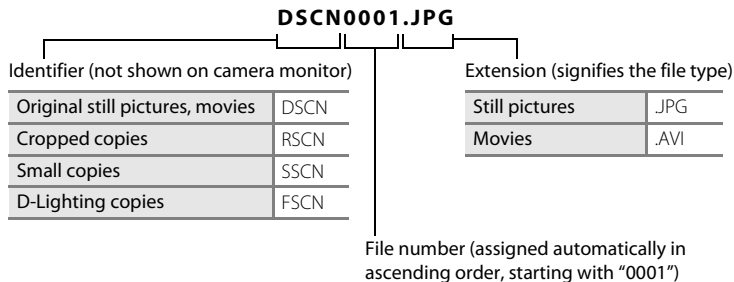
Pictures and movies are assigned file names as follows.



- Files are stored in folders named with a folder number followed by a five-character identifier: "P_" plus a three-digit sequence number for pictures taken using panorama assist (e.g. "101P_001";  46) and "NIKON" for all other pictures (e.g. "100NIKON"). When the number of files within a folder reaches 9999, a new folder will be created. File numbers will be assigned automatically starting with "0001".
- Files copied using **Copy > Selected images** are copied to the current folder, where they are assigned new file numbers in ascending order starting from the largest file number in memory. **Copy > All images** copies all folders from the source medium; file names do not change but new folder numbers are assigned in ascending order, starting from the largest folder number on the destination medium ( 113).
- Folders can hold up to 200 pictures; if a picture is taken when the current folder contains 200 pictures, a new folder will be created by adding one to the current folder number. If a picture is taken when the current folder is numbered 999 and contains 200 pictures or a picture numbered 9999, no further pictures can be taken until the medium is formatted ( 106) or a new memory card is inserted.

Caring for the Camera

To ensure continued enjoyment of this Nikon product, observe the following precautions when using or storing the device:

Keep dry

The device will be damaged if immersed in water or subjected to high humidity.

Do not drop

The product may malfunction if subjected to strong shock or vibration.

Handle the lens and all moving parts with care

Do not apply force to the lens, monitor, memory card slot or battery chamber. These parts are easily damaged. Applying force to the lens cover could result in camera malfunction or damage to the lens. Should the monitor break, care should be taken to avoid injury caused by broken glass and to prevent the liquid crystal from the display touching the skin or entering the eyes or mouth.

Do not point the lens at strong light sources for extended periods

Avoid pointing the lens at the sun or other strong light sources for extended periods when using or storing the camera. Intense light may cause deterioration of the image sensor, producing a white blur effect in photographs.

Keep away from strong magnetic fields

Do not use or store this device in the vicinity of equipment that generates strong electromagnetic radiation or magnetic fields. Strong static charges or the magnetic fields produced by equipment such as radio transmitters could interfere with the monitor, damage data stored on the memory card, or affect the product's internal circuitry.

Avoid sudden changes in temperature

Sudden changes in temperature, such as when entering or leaving a heated building on a cold day, can cause condensation to form inside the device. To prevent condensation, place the device in a carrying case or a plastic bag before exposing it to sudden changes in temperature.

Turn the product off before removing or disconnecting the power source

Do not remove the battery while the product is on, or while images are being recorded or deleted. Forcibly cutting power in these circumstances could result in loss of data or in damage to product memory or internal circuitry.

Caring for the Camera

The Battery

- Check the battery level when taking the camera out, and replace the batteries if necessary (📖 20). If possible, carry spare batteries when taking pictures on important occasions.
- Battery capacity tends to decrease on cold days. Be sure that the batteries are fresh before heading outside to take pictures in cold weather. Keep spare batteries in a warm place and exchange as necessary. Once warmed, a cold battery may recover some of its charge.
- Dirt on the battery terminals can prevent the camera from functioning.
- Used batteries are a valuable resource. Please recycle used batteries in accordance with local regulations.

Cleaning

Lens	Avoid touching glass parts with your fingers. Remove dust or lint with a blower (typically a small device with a rubber bulb attached to one end that is pumped to produce a stream of air out the other end). To remove fingerprints or other stains that cannot be removed with a blower, wipe the lens with a soft cloth, using a spiral motion that starts at the center of the lens and working toward the edges. If this fails, clean the lens using a cloth lightly dampened with commercial lens cleaner.
Monitor	Remove dust or lint with a blower. To remove fingerprints and other stains, clean the monitor with a soft, dry cloth, being careful not to apply pressure.
Body	Use a blower to remove dust, dirt or sand, then wipe gently with a soft, dry cloth. After using the camera at the beach or seaside, wipe off any sand or salt with a dry cloth lightly dampened with fresh water, then dry thoroughly. Note that foreign matter inside the camera could cause damage not covered by the warranty.

Do not use alcohol, thinner, or other volatile chemicals.

Storage

Turn the camera off when not in use. Check that the power-on lamp is off before putting the camera away. Remove the battery if the camera will not be used for an extended period. Do not store the camera with naphtha or camphor moth balls, or in any of the following locations:

- Next to equipment that produces strong electromagnetic fields, such as televisions or radios
- Exposed to temperatures below -10°C (14°F) or above 50°C (122°F)
- Poorly ventilated or subject to humidities of over 60 %

To prevent mold or mildew, take the camera out of storage at least once a month. Turn the camera on and release the shutter a few times before putting the camera away again.















Notes on the Monitor

- The monitor may contain a few pixels that are always lit or that do not light. This is a characteristic common to all TFT LCD displays, and does not indicate a malfunction. Images recorded using the product will not be affected.
- When framing bright subjects, vertical comet-like streaks that whiten toward either end may appear in the display. This phenomenon, known as “smear,” does not indicate a malfunction. In shooting modes other than Sport continuous mode, Multi-shot 16 and movie mode, smear has no effect on the images that are recorded.
- Images in the monitor may be difficult to see under bright lighting.
- The monitor is lit by an LED backlight. Should the monitor begin to dim or flicker, contact your Nikon-authorized service representative.



















Error Messages

The following table lists the error messages and other warnings displayed in the monitor, as well as the solutions for dealing with them.

Display	Problem	Solution	
 (blinks)	Clock not set.	Set clock.	96
	Battery running low.	Prepare to replace batteries.	14, 111
i Battery exhausted.	Battery exhausted.	Replace batteries.	
 ● (blinks red)	Camera cannot focus.	<ul style="list-style-type: none"> • Refocus. • Use focus lock. 	24, 25, 29
i Please wait for the camera to finish recording.	Camera cannot perform other operations until recording is complete.	Wait until message clears from display automatically when recording is complete.	25
i Memory card is write protected.	Write-protect switch is in "lock" position.	Slide write-protect switch to "write" position.	19
i This card cannot be used.	Error accessing memory card.	<ul style="list-style-type: none"> • Use approved card. • Check that connectors are clean. • Confirm that memory card is correctly inserted. 	115 18
i This card cannot be read.			18
i Card is not formatted. Format card? No Yes	Memory card has not been formatted for use in COOLPIX L100.	Choose Yes and press OK to format card.	19
i Out of memory.	Memory card is full.	<ul style="list-style-type: none"> • Choose smaller image mode. • Delete pictures. • Insert new memory card. • Remove memory card and use internal memory. 	79 26, 63, 90 18 19

Display	Problem	Solution	
 Image cannot be saved.	Error occurred while recording picture.	Format internal memory or memory card.	106
	Camera has run out of file numbers.	<ul style="list-style-type: none"> • Insert new memory card. • Format internal memory or memory card. 	18 106
	Picture cannot be used for welcome screen.	Choose picture 640 × 480 pixels or larger, or picture taken at an image mode setting other than 16:9 .	59, 60, 79
	There is not enough memory to copy the picture.	Delete pictures from destination.	90
 Image cannot be modified.	You are trying to edit a picture that cannot be edited.	Select picture that supports D-Lighting, crop or small picture.	57
 Cannot record movie.	Time out error while recording movie.	Choose memory card with faster write speed.	18
 Memory contains no images.	No pictures in the internal memory or memory card.	Remove memory card to play back pictures from internal memory.	113
 File contains no image data.	File not created with COOLPIX L100.	File cannot be viewed on this camera. View file using the computer or any other devices which was used to create or edit this file.	–
 This image cannot be deleted.	Picture is protected.	Disable protection.	111
 Travel destination is in the current time zone.	Destination in same time zone as home.	–	96
 Raise the flash.	The built-in flash is lowered.	<ul style="list-style-type: none"> • Raise the built-in flash when changing the flash mode. • Raise the built-in flash when shooting using the Night portrait and Backlight scene modes. 	6, 30 38, 42

Error Messages

Display	Problem	Solution	
 Lens error. (If the lens cap is attached, turn the camera off, remove the lens cap, and turn the camera on.)	Lens error.	Remove the lens cap if still attached, and turn camera off and then on again. If error persists, contact retailer or Nikon-authorized service representative.	20
 Communications error	USB cable disconnected during printing.	Turn camera off, reconnect USB cable.	70
System error 	Error has occurred in camera's internal circuitry.	Turn camera off, remove and reinsert battery, and turn camera on. If error persists, contact retailer or Nikon-authorized service representative.	14, 20
 Printer error: check printer status.	Running out of ink or printer error.	Check printer. After solving the problem, select Resume and press the  to resume printing.*	-
 Printer error: check paper	Specified size of paper is not loaded in printer.	Load the specified paper, select Resume and press  to resume printing.*	-
 Printer error: paper jam	Paper has jammed in the printer.	Eject the jammed paper, select Resume and press  to resume printing.*	-
 Printer error: out of paper	No paper is loaded in printer.	Load the specified paper, select Resume and press  to resume printing.*	-
 Printer error: check ink	Ink error.	Check ink, select Resume and press  to resume printing.*	-
 Printer error: out of ink	Ink cartridge is empty.	Replace ink, select Resume and press  to resume printing.*	-
 Printer error: file corrupt	An error caused by the image file has occurred.	Select Cancel and press  to cancel printing.	-

* See the documentation provided with your printer for further guidance and information.

Troubleshooting

If the camera fails to function as expected, check the list of common problems below before consulting your retailer or Nikon-authorized service representative. Refer to the page numbers in the right-most column for more information.





Display, Settings and Power Supply

Problem	Cause/Solution	
Monitor is blank	<ul style="list-style-type: none">• Camera is off.• Battery exhausted.• Standby mode for saving power: press the shutter-release button halfway.• When flash lamp blinks red, wait until flash has charged.• Camera and computer are connected via USB cable.• Camera and TV are connected via AV cable.	20 20 15, 24 31 66 64
Monitor is hard to read	<ul style="list-style-type: none">• Adjust monitor brightness.• Monitor is dirty. Clean monitor.	99 118
Camera turns off without warning	<ul style="list-style-type: none">• Battery exhausted.• Camera has turned off automatically to save power.• Battery is cold.	20 105 118
Date and time of recording are not correct	<ul style="list-style-type: none">• Pictures taken while the clock is not set will have a time stamp of "00/00/0000 00:00"; movies will be dated "01/ 01/2009 00:00." (The "Date not set" indicator blinks during shooting to indicate the clock is not set.) Set the correct date and time using Date in the setup menu.• Check camera clock regularly against more accurate timepieces and reset as required.	16 96
No indicators displayed in monitor	Hide info is selected for Photo info . Select Show info .	99
Date imprint not available	Camera clock has not been set.	16, 96
Date not appearing on pictures even when Date imprint is enabled	Date imprint is disabled in the following situations. <ul style="list-style-type: none">• When scene mode is set to Museum or Panorama assist.• When Continuous is set to Continuous or BSS.• When using sport continuous mode.• When recording movies.	41, 43 83 48 61
Camera settings reset	Backup battery is exhausted; all settings were restored to their default values.	97





Electronically Controlled Cameras

In extremely rare instances, unusual characters may appear in the monitor and the camera may stop functioning. In most cases, this phenomenon is caused by a strong external static charge. Turn the camera off, remove and replace the battery, then turn the camera on again. In the event of continued malfunction, contact your retailer or Nikon-authorized service representative. Note that disconnecting the power source as described above may result in the loss of any data not recorded to internal memory or the memory card at the time the problem occurred. Data already recorded will not be affected.

Shooting

Problem	Cause/Solution	
No picture taken when shutter-release button is pressed.	<ul style="list-style-type: none"> When camera is in playback mode, press . When menus are displayed, press MENU. Battery exhausted. When flash lamp blinks, flash is charging. 	10 12 20 31
Camera cannot focus.	<ul style="list-style-type: none"> The intended subject is one with which autofocus does not perform well. Set AF assist in the setup menu to Auto. Focus error. Turn camera off and then on again. 	25 104 20
Pictures are blurred.	<ul style="list-style-type: none"> Use flash. Use high sensitivity mode. Use vibration reduction and motion detection. Use BSS (Best Shot Selector). Use tripod and self-timer. 	30 50 102, 103 83 5, 33
Bright specks appear in pictures taken with flash.	Flash is reflecting off particles in air. Lower the built-in flash or set flash mode to  (Off).	6, 30
Flash does not fire.	<ul style="list-style-type: none"> The built-in flash is lowered, or flash mode is set to  (Off). Some scene modes that cannot turn on flash are selected. Sport continuous mode is selected.  mode is selected. Continuous or Multi-shot 16 or BSS is selected for Continuous in shooting menu. 	6, 30 36 48 61 83
Optical zoom cannot be used.	Optical zoom cannot be used while recording movies.	61

Problem	Cause/Solution	
Digital zoom cannot be used.	Digital zoom cannot be used in the following situations. <ul style="list-style-type: none"> • When Portrait or Night portrait is selected for Scene mode. • When the smile mode is selected. • Just before recording a movie (up to 2x can be applied while recording movies). • When Multi-shot 16 is selected for Continuous. 	37, 38 52 61 83
Image mode not available.	<ul style="list-style-type: none"> • Image mode cannot be adjusted when Multi-shot 16 is selected for Continuous. • Available image modes differ according to the current shooting mode. 	83 79
No sound when shutter is released.	<ul style="list-style-type: none"> • Off is selected for Sound settings > Shutter sound in setup menu. • Continuous or Multi-shot 16 or BSS is selected for Continuous in shooting menu. •  (Museum scene mode) is selected. • Sport continuous mode is selected. •  mode is selected. • Do not block the speaker. 	104 83 41 48 61 4
AF-assist illuminator does not light.	<ul style="list-style-type: none"> • Off is selected for AF assist option in camera setup menu. • AF-assist illuminator turns off automatically in some scene modes. 	104 37-43
Pictures appear smeared.	Lens is dirty. Clean lens.	118
Colors are unnatural.	White balance does not match light source.	81
Randomly spaced bright pixels ("noise") appear in image.	The subject is dark, so shutter speed is too slow or ISO sensitivity is too high. Noise can be reduced by using flash.	30
Pictures are too dark (underexposed).	<ul style="list-style-type: none"> • The built-in flash is lowered, or flash mode is set to  (Off). • Flash window is blocked. • Subject is beyond flash range. • Adjust exposure compensation. • Use high sensitivity mode. • Subject is backlit. Select  (Backlight scene mode) or use fill flash. 	6, 30 22 30 35 50 30, 42
Pictures are too bright (overexposed).	Adjust exposure compensation.	35

Problem	Cause/Solution	
<p>Unexpected results when flash set to  (auto with red-eye reduction).</p>	<p>When taking pictures with  (auto with red-eye reduction), or when taking pictures with Night portrait (either in easy auto mode or the Night portrait scene mode) and the fill flash with slow sync and red-eye reduction is used, red-eye reduction may be applied, in rare cases, to areas not affected by red-eye. Use any auto mode or scene mode other than Night portrait, and change the flash to any other settings other than  (auto with red-eye reduction) and try shooting again.</p>	<p>28, 30, 38</p>

Playback

Problem	Cause/Solution	
<p>File cannot be played back.</p>	<p>File was overwritten or renamed by computer or other make of camera.</p>	<p>-</p>
<p>Cannot zoom in on picture.</p>	<p>Playback zoom cannot be used with movies, small pictures, or pictures that have been cropped to below 320 × 240.</p>	<p>-</p>
<p>Cannot use D-Lighting, crop, or small picture options.</p>	<ul style="list-style-type: none"> • These options cannot be used with movies. • These options cannot be used with pictures taken when 16:9 is applied in the Image mode setting. • Select picture that supports D-Lighting, crop, or small picture. • Camera is unable to edit pictures taken with other cameras. • Pictures edited by this camera may not be displayed correctly in other cameras and cannot be transferred to computers from there. • Confirm the compatible operating systems. 	<p>63 79 57 57 57 65</p>
<p>Pictures not displayed on television.</p>	<ul style="list-style-type: none"> • Choose correct Video mode. • Memory card contains no pictures. Replace memory card. Remove memory card to play back pictures from internal memory. 	<p>107 18</p>

Problem	Cause/Solution	
Nikon Transfer does not start when camera is connected.	<ul style="list-style-type: none"> • Camera is off. • Battery exhausted. • USB cable is not correctly connected. • Camera is not recognized by the computer. • Computer is not set to launch Nikon Transfer automatically. For more information about Nikon Transfer, refer to help information contained in Nikon Transfer. 	20 20 66 – –
Pictures to be printed are not displayed.	Memory card contains no pictures. Replace memory card. Remove memory card to print pictures from internal memory.	18
Cannot select paper size with camera.	Even when using a PictBridge compatible printer, paper size cannot be selected from the camera in the following situations. Use the printer to select paper size. <ul style="list-style-type: none"> • The printer does not support the paper sizes used by the camera. • The printer automatically selects the paper size. 	71, 72

Specifications

Nikon COOLPIX L100 Digital Camera

Type	Compact digital camera
Effective pixels	10.0 million
Image sensor	1/2.33-in. CCD; total pixels: 10.70 million
Lens	15× optical zoom, NIKKOR lens
Focal length	5.0-75.0mm Equivalent with 35mm [135] format picture angle: 28-420mm
Aperture	f/3.5-5.4
Construction	12 elements in 8 groups
Digital zoom	Up to 4× Equivalent with 35mm [135] format picture angle: approx. 1680mm
Vibration reduction	Image-sensor shift (still pictures) Electronic (movies)
Autofocus (AF)	Contrast-detect AF
Focus range (from lens)	<ul style="list-style-type: none">• Approx. 50 cm (1 ft. 8 in.) to ∞ (W); approx. 1.5 m (5 ft.) to ∞ (T)• Macro mode: 1 cm (0.4 in.) (middle zoom position) to ∞
Focus-area selection	Center, face priority
Monitor	3-in., approx. 230k-dot, TFT LCD with anti-reflection coating and 5-level brightness adjustment
Frame coverage (shooting mode)	Approx. 97 % horizontal and 97 % vertical (Compared to actual picture)
Frame coverage (playback mode)	Approx. 100 % horizontal and 100 % vertical (Compared to actual picture)
Storage	
Media	Internal memory (Approx. 44 MB), Secure Digital (SD) memory cards
File system	DCF, Exif 2.2, and DPOF compliant
File formats	Compressed: JPEG-Baseline compliant Movies: AVI
Image size (pixels)	<ul style="list-style-type: none">• 3648 × 2736 [High (3648★) / Normal (3648)]• 2592 × 1944 [Normal (2592)]• 2048 × 1536 [Normal (2048)]• 1024 × 768 [PC screen (1024)]• 640 × 480 [TV screen (640)]• 3584 × 2016 [16:9 (3584)]• 1920 × 1080 [16:9 (1920)]
ISO sensitivity (Standard output sensitivity)	Auto ISO 80-800, 720-3200 (High sensitivity mode or Sport continuous mode)

Exposure	
Metering	256-segment matrix, center-weighted (with 2× digital zoom), spot (digital zoom 2× or more)
Exposure control	Programmed auto exposure with motion detection and exposure compensation (-2.0 to +2.0 EV in steps of 1/3 EV)
Range (ISO 100)	[W]: 0.6 to 15.9 EV [T]: 1.8 to 17.1 EV
Shutter	Mechanical and charge-coupled electronic shutter
Speed	1/1000 - 2 s, 1/4000 - 1/15 s (Sport continuous mode)
Aperture	Electronically-controlled ND filter (-2 AV) selection
Range	2 steps (f/3.5 and f/7 [W])
Self-timer	Approx. 10 seconds
Built-in flash	
Range (approx.) (High sensitivity mode)	[W]: 0.5 to 11.0 m (1 ft. 8 in. to 36 ft.) [T]: 0.5 to 9.0 m (1 ft. 8 in. to 29 ft.)
Flash control	TTL auto flash with monitor preflashes
Interface	Hi-Speed USB
Data transfer protocol	MTP, PTP
Video output	Can be selected from NTSC and PAL
I/O terminal	Audio video output/digital I/O, DC input connector
Supported languages	Arabic, Chinese (Simplified and Traditional), Czech, Danish, Dutch, English, Finnish, French, Greek, German, Hungarian, Indonesian, Italian, Japanese, Korean, Polish, Portuguese, Norwegian, Russian, Spanish, Swedish, Thai, Turkish
Power sources	<ul style="list-style-type: none"> • Four LR6/L40 (AA-size) alkaline batteries • Four FR6/L91 (AA-size) lithium batteries • AC Adapter EH-67 (available separately)
Number of Exposures Possible (Battery life)*	Approx. 350 shots with alkaline or 900 shots with lithium
Dimensions (W × H × D)	Approx. 110 × 72 × 78 mm (4.3 × 2.8 × 3 in.) (excluding projections)
Weight	Approx. 355 g (12.5 oz) (without battery and SD memory card)
Operating environment	
Operating temperature	0 to 40°C (32 to 104°F)
Humidity	Less than 85% (no condensation)

Specifications

- These performance specifications are applicable when fresh batteries are used at normal temperatures (25°C/77°F).
- * Based on Camera and Imaging Products Association (CIPA) standards for measuring the life of camera batteries. Measured at 23 (±2) °C (69 to 77°F); zoom adjusted with each shot, flash fired with every other shot, image mode set to [0.4 Normal]. Battery life may vary depending on shooting interval and length of time menus and images are displayed. Supplied batteries are for trial use only.

Specifications

Nikon will not be held liable for any errors this manual may contain.























The appearance of this product and its specifications are subject to change without notice.

Supported Standards

- **DCF:** Design Rule for Camera File System is a standard widely used in the digital camera industry to ensure compatibility among different makes of camera.
- **DPOF:** Digital Print Order Format is an industry-wide standard that allows pictures to be printed from print orders stored on the memory card.
- **Exif version 2.2:** This camera supports Exif (Exchangeable Image File Format for Digital Still Cameras) version 2.2, a standard that allows information stored with photographs to be used for optimal color reproduction when images are output from Exif-compliant printers.
- **PictBridge:** A standard developed cooperatively by the digital camera and printer industries, allowing photographs to be output directly to a printer without connecting the camera to a computer.

Index



Symbols

-  (apply selection) button 5, 11
-  (delete) button 27
-  (Playback) button 5, 10
-  (shooting mode) button 5, 10
-  Auto mode 29
-  Delete button 5, 26, 63
-  D-Lighting 58
-  Easy auto mode 28, 20
-  Exposure compensation 35
-  Flash mode 30
-  High sensitivity mode 50
-  Macro mode 34
-  Movie mode 61
-  Playback mode 26
-  Scene mode 36
-  Self-timer 33
-  Smile mode 52
-  Sport continuous mode 48
-  AE/AF-L 47
- W** button 4, 23, 27, 54, 55, 56
-  button 4, 23, 27, 54, 55, 56
- T** button 4, 13, 23, 27, 54, 55, 56
-  button 4, 23, 27, 54, 55, 56
-  button 4, 13
- MENU** button 5, 12



A

- AC adapter 15, 115
- AF-assist illumination 4, 25, 104
- Alkaline 15
- Alkaline batteries 14
- Aperture 24
- Audio Video/USB Cable 64, 70
- Audio-in/Video-in jack 64
- Auto flash 30
- Auto off 15, 105
- Autofocus 24, 34
- AV Cable 64
- AVI 116

B

- Backlight  42
- Batteries 14, 97
- Battery level 20
- Battery type 15, 111
- Battery-chamber 5
- Battery-chamber/memory card slot cover 5, 14, 18
- Beach/snow  39
- Best Shot Selector 83
- Black-and-white 84
- Blink warning 108
- Brightness 99
- BSS 83
- Built-in flash 4, 30
- Built-in microphone 4
- Button sound 104

C

- Cable connector 5, 64, 65, 70
- Calendar display 55
- Close-up  40
- Cloudy 81
- Color options 84
- Compression ratio 79
- Computer 65
- Continuous 83
- Copy 113
- Copy  42
- Crop 59
- Cyanotype 84

D

- Date 16, 96
- Date imprint 101
- Daylight 81
- Daylight saving time 16, 97
- DC input connector 5
- Delete 26, 27, 63, 90
- Digital zoom 23
- Direct print 69

Distortion control 85

D-Lighting 57, 58

DPOF 131

DPOF printing 74

DSCN 116

Dusk/dawn  39

E

Easy auto mode 20, 28

EH-67 15

Exposure compensation 35

Extension 116

Eyelet for camera strap 4

F

File names 116

Fill flash 30

Firmware version 114

Flash 30, 31

Flash lamp 5, 31

Fluorescent 81

Focus 13, 24

Focus lock 25, 29

Folder names 116

Food  41, 44

Format 19, 106

Format memory card 19, 106

Formatting internal memory 106

FSCN 116

H

Halfway 13

Help 13

High sensitivity mode 50

I

Identifier 116

Image mode 21, 36, 79

Image review 99

Incandescent 81

Indicator lamp 5

Internal memory 18

ISO sensitivity 31, 48, 50

J

JPG 116

L

Landscape  37

Language 107

Lens 4, 128

Lithium batteries 14

M

Macro mode 34

Memory capacity 20

Memory card 18, 115

Memory card slot 5, 18

Menus 94

Monitor 5, 8, 118

Monitor settings 99

Motion detection 103

Movie menu 61, 62

Movie playback 63

Movie settings 62

Multi-selector 5, 11

Multi-shot 16 83

Museum  41

N

Night landscape  40

Night Portrait  38

Nikon Transfer 66

Number of Exposures Remaining 20, 80

O



Off 30

Optical zoom 23

Optional Accessories 115

P

Panorama assist  43, 46

Paper size 71, 72
Party/indoor  38
Photo info 99
PictBridge 69, 131
Playback 26, 27, 54, 56, 63
Playback button 5, 10
Playback menu 87
Playback zoom 56
Portrait  37
Power 14, 16, 20
Power switch 4, 14, 20
Power-on lamp 4, 14, 20
Preset manual 82
Print 71, 72, 75
Print set 75
Print Set (Date) 76
Printer 69
Protect 111

R

Recording movies 61
Red-eye reduction 30, 32
Replay mode 26, 27
Reset all 109
Rotate image 112
RSCN 116

S

Scene mode 36, 37
Self-timer 33
Self-timer lamp 4, 33
Sepia 84
Setup menu 91
Shooting 20, 22, 24
Shooting Menu 77
Shooting mode button 5, 10
Shooting-mode Selection menu 10
Shutter sound 104
Shutter speed 24
Shutter-release button 4, 24
Single 83

Sleep Mode 105
Slide show 89
Slow Sync 30
Small picture 60
Smile mode 52
Sound settings 104
Speaker 4
Sport continuous mode 48
SSCN 116
Standard color 84
Strap 7
Sunset  39

T

Tabs 12
Thumbnail playback 54
Time zone 16, 96, 98
Tripod socket 5
TV 64
TV movie 62

U

USB Cable 65, 66

V

Vibration reduction 102
Video Mode 107
Vivid color 84
Volume 63

W

Welcome screen 95
White balance 81

Z

Zoom control 4, 23, 63

Nikon

No reproduction in any form of this manual, in whole or in part (except for brief quotation in critical articles or reviews), may be made without written authorization from NIKON CORPORATION.



NIKON CORPORATION

Fuji Bldg., 2-3 Marunouchi 3-chome,
Chiyoda-ku, Tokyo 100-8331, Japan

© 2009 Nikon Corporation

Printed in Europe
CT9B01(11)
6MM69111-01