

Nikon

DIGITAL CAMERA

COOLPIX L22/L21

User's Manual

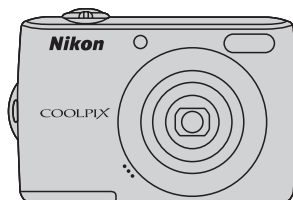
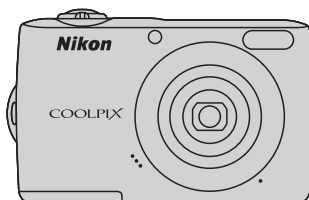

En

Trademark Information

- Microsoft, Windows and Windows Vista are either registered trademarks or trademarks of Microsoft Corporation in the United States and/or other countries.
- Macintosh, Mac OS, and QuickTime are trademarks of Apple Inc.
- Adobe and Acrobat are registered trademarks of Adobe Systems Inc.
- SD and SDHC Logos are trademarks of SD-3C, LLC.
- PictBridge is a trademark.
- All other trade names mentioned in this manual or the other documentation provided with your Nikon product are trademarks or registered trademarks of their respective holders.

Introduction

First Steps



**Basic Photography and Playback:
Easy Auto Mode**



Shooting in the Auto Mode



Shooting Suited for the Scene



**Taking Pictures of Smiling Faces
(Smart Portrait Mode)**



More on Playback



Movies

Connecting to Televisions, Computers and Printers

MENU

Shooting, Playback and Setup Menus

Technical Notes

For Your Safety

To prevent damage to your Nikon product or injury to yourself or to others, read the following safety precautions in their entirety before using this equipment. Keep these safety instructions where all those who use the product will read them. The consequences that could result from failure to observe the precautions listed in this section are indicated by the following symbol:



This icon marks warnings, information that should be read before using this Nikon product, to prevent possible injury.

WARNINGS

Turn off in the event of malfunction

Should you notice smoke or an unusual smell coming from the camera or AC adapter, unplug the AC adapter and remove the batteries immediately, taking care to avoid burns. Continued operation could result in injury. After removing or disconnecting the power source, take the equipment to a Nikon-authorized service representative for inspection.

Do not disassemble

Touching the internal parts of the camera or AC adapter could result in injury. Repairs should be performed only by qualified technicians. Should the camera or AC adapter break open as the result of a fall or other accident, take the product to a Nikon-authorized service representative for inspection, after unplugging the product and/or removing the batteries.

Do not use the camera or AC adapter in the presence of flammable gas

Do not use electronic equipment in the presence of flammable gas, as this could result in explosion or fire.

Handle the camera strap with care

Never place the strap around the neck of an infant or child.

Keep out of reach of children

Particular care should be taken to prevent infants from putting the batteries or other small parts into their mouths.

Observe caution when handling batteries

Batteries may leak or explode if improperly handled. Observe the following precautions when handling batteries for use in this product:

- Before replacing the batteries, turn the product off. If you are using an AC adapter, be sure it is unplugged.
- Use only the batteries approved for use in this product (📖 14). Do not combine old and new batteries or batteries of different makes or types.
- If Nikon rechargeable Ni-MH batteries EN-MH2 (EN-MH2-B2 or EN-MH2-B4) are purchased separately, charge and use each of them as a set. Do not combine batteries from different pairs.
- The EN-MH2 rechargeable batteries are for use with Nikon digital cameras only, and are compatible with COOLPIX L22/L21.
Do not use EN-MH2 rechargeable batteries with incompatible devices.
- Insert batteries in the correct orientation.
- Do not short or disassemble batteries or attempt to remove or break battery insulation or casing.
- Do not expose batteries to flame or to excessive heat.
- Do not immerse in or expose to water.
- Do not transport or store with metal objects such as necklaces or hairpins.
- Batteries are prone to leakage when fully discharged. To avoid damage to the product, be sure to remove the batteries when no charge remains.

- Discontinue use immediately should you notice any change in the batteries, such as discoloration or deformation.
- If liquid from damaged batteries comes in contact with clothing or skin, rinse immediately with plenty of water.

Observe the following precautions when handling the Battery Chargers (available separately)

- Keep Dry. Failure to observe this precaution could result in fire or electric shock.
- Dust on or near the metal parts of the plug should be removed with a dry cloth. Continued use could result in fire.
- Do not handle the power cable or go near the battery charger during lightning storms. Failure to observe this precaution could result in electric shock.
- Do not damage, modify, forcibly tug or bend the power cable, place it under heavy objects, or expose it to heat or flame. Should the insulation be damaged and the wires become exposed, take it to a Nikon-authorized service representative for inspection. Failure to observe these precautions could result in fire or electric shock.
- Do not handle the plug or battery charger with wet hands. Failure to observe this precaution could result in electric shock.

For Your Safety

- Do not use with travel converters or adapters designed to convert from one voltage to another or with DC-to-AC inverters. Failure to observe this precaution could damage the product or result in overheating or fire.

Use appropriate cables

When connecting cables to the input and output jacks, use only the cables provided or sold by Nikon for the purpose, to maintain compliance with product regulations.

Handle moving parts with care

Be careful that your fingers or other objects are not pinched by the lens cover or other moving parts.

CD-ROMs

The CD-ROMs supplied with this device should not be played back on audio CD equipment. Playing CD-ROMs on an audio CD player could cause hearing loss or damage the equipment.

Observe caution when using the flash

Using the flash close to your subject's eyes could cause temporary visual impairment. Particular care should be observed if photographing infants, when the flash should be no less than 1 m (3 ft. 4 in.) from the subject.

Do not operate the flash with the flash window touching a person or object

Failure to observe this precaution could result in burns or fire.

Avoid contact with liquid crystal

Should the monitor break, care should be taken to avoid injury caused by broken glass and to prevent liquid crystal from the monitor touching the skin or entering the eyes or mouth.

Turn the power off when using inside an airplane or the hospital

Turn the power off while inside the airplane during take off or landing. Follow the instructions of the hospital when using while in a hospital. The electromagnetic waves given out by this camera may disrupt the electronic systems of the airplane or the instruments of the hospital.

Notices

Notice for Customers in the U.S.A.

Federal Communications Commission (FCC) Radio Frequency Interference Statement

This equipment has been tested and found to comply with the limits for a Class B digital device, pursuant to Part 15 of the FCC rules. These limits are designed to provide reasonable protection against harmful interference in a residential installation. This equipment generates, uses, and can radiate radio frequency energy and, if not installed and used in accordance with the instructions, may cause harmful interference to radio communications. However, there is no guarantee that interference will not occur in a particular installation. If this equipment does cause harmful interference to radio or television reception, which can be determined by turning the equipment off and on, the user is encouraged to try to correct the interference by one or more of the following measures:

- Reorient or relocate the receiving antenna.
- Increase the separation between the equipment and receiver.
- Connect the equipment into an outlet on a circuit different from that to which the receiver is connected.
- Consult the dealer or an experienced radio/television technician for help.



CAUTIONS

Modifications

The FCC requires the user to be notified that any changes or modifications made to this device that are not expressly approved by Nikon Corporation may void the user's authority to operate the equipment.

Interface Cables

Use the interface cables sold or provided by Nikon for your equipment. Using other interface cables may exceed the limits of Class B Part 15 of the FCC rules.

Notice for customers in the State of California

WARNING

Handling the cord on this product will expose you to lead, a chemical known to the State of California to cause birth defects or other reproductive harm.

Wash hands after handling.

Nikon Inc.,
1300 Walt Whitman Road
Melville, New York 11747-3064
USA
Tel: 631-547-4200

Notice for customers in Canada

CAUTION

This Class B digital apparatus complies with Canadian ICES-003.

ATTENTION

Cet appareil numérique de la classe B est conforme à la norme NMB-003 du Canada.

Symbol for Separate Collection in European Countries

This symbol indicates that this product is to be collected separately.



The following apply only to users in European countries:

- This product is designated for separate collection at an appropriate collection point. Do not dispose of as household waste.
- For more information, contact the retailer or the local authorities in charge of waste management.

This symbol on the battery indicates that the battery is to be collected separately.









The following apply only to users in European countries:

- All batteries, whether marked with this symbol or not, are designated for separate collection at an appropriate collection point. Do not dispose of as household waste.
- For more information, contact the retailer or the local authorities in charge of waste management.

Table of Contents

For Your Safety	ii
WARNINGS	ii
Notices	v
<hr/>	
Introduction	1
About This Manual	1
Information and Precautions	2
Parts of the Camera	4
The Camera Body	4
The Monitor	8
Basic Operations	10
📷 (shooting mode) button	10
▶ (playback) button	10
The Multi Selector	11
MENU button	12
Switching Between Tabs	12
Help Displays	13
About the Shutter-release Button	13
Attaching the Camera Strap	13
<hr/>	
First Steps	14
Inserting the Batteries	14
Applicable Batteries	14
Turning On and Off the Camera	14
Setting Display Language, Date and Time	16
Inserting Memory Cards	18
Removing Memory Cards	19
<hr/>	
📷 Basic Photography and Playback: Easy Auto Mode	20
Step 1 Turn the Camera On and Select 📷 (Easy Auto) Mode	20
Indicators Displayed in 📷 (Easy auto) Mode	21
Step 2 Frame a Picture	22
Using the Zoom	23
Step 3 Focus and Shoot	24
Step 4 Viewing and Deleting Pictures	26
Viewing Pictures (Playback Mode)	26
Deleting Pictures	26
Easy auto mode	28

Table of Contents

 Auto Mode.....	29
Shooting in the Auto Mode.....	29
Using the Flash.....	30
Taking Pictures with the Self-timer	32
Macro Mode	33
Exposure Compensation	34
<hr/>	
 Shooting Suited for the Scene.....	35
Using the Scene Mode	35
Setting the Scene Mode.....	35
Features	36
Taking Pictures for Food Mode.....	43
Taking Pictures for a Panorama	44
<hr/>	
 Taking Pictures of Smiling Faces (Smart Portrait Mode)	46
Using Smart Portrait Mode	46
<hr/>	
 More on Playback.....	48
Viewing Multiple Pictures: Thumbnail Playback	48
Calendar Display.....	49
Taking a Closer Look: Playback Zoom	50
Editing Pictures.....	51
Enhancing Brightness and Contrast: D-Lighting.....	52
Resizing Pictures: Small Picture.....	53
Creating a Cropped Copy: Crop	54
<hr/>	
 Movies	55
Recording Movies	55
The Movie Menu.....	56
 Selecting Movie Options	56
Movie Playback.....	57
Deleting Movie Files.....	57

Connecting to Televisions, Computers and Printers	58
Connecting to a TV	58
Connecting to a Computer	59
Before Connecting the Camera	59
Transferring Pictures from a Camera to a Computer	60
Connecting to a Printer	64
Connecting the Camera and Printer	65
Printing Pictures One at a Time	66
Printing Multiple Pictures	67
Creating a DPOF Print Order: Print Set	70



























MENU Shooting, Playback and Setup Menus	72
Shooting Options: The Shooting Menu	72
Displaying the Shooting Menu	73
 Image mode	74
 White Balance	76
 Continuous	78
 Color Options	79
Camera Settings that Cannot Be Set at the Same Time	80
Playback Options: The Playback Menu	81
Displaying the Playback Menu	81
 Slide Show	83
 Delete	84

Table of Contents

Basic Camera Setup: The Setup Menu	85
Displaying the Setup Menu.....	86
 Menus	87
 Welcome Screen.....	88
 Date.....	89
 Monitor Settings.....	92
 Date Imprint.....	94
 Electronic VR.....	95
 Motion detection.....	96
 AF Assist	97
 Sound Settings	98
 Auto Off.....	99
 Format Memory/  Format Card	100
 Language.....	101
 Video Mode	101
 Blink Warning.....	102
 Reset All.....	103
 Battery Type.....	105
 Protect.....	106
 Rotate Image.....	107
 Copy.....	108
 Firmware Version	109
<hr/>	
Technical Notes	110
Optional Accessories	110
Approved Memory Cards	110
Image File and Folder Names	111
Caring for the Camera	112
Cleaning	114
Storage.....	115
Error Messages	116
Troubleshooting	119
Specifications	124
Supported Standards	128
Index	129

About This Manual

Thank you for your purchase of a Nikon COOLPIX L22/COOLPIX L21 digital camera. This manual was written to help you enjoy taking pictures with your Nikon digital camera. Read this manual thoroughly before use, and keep it where all those who use the product will read it.

Symbols and Conventions

To make it easier to find the information you need, the following symbols and conventions are used:



This icon marks cautions, information that should be read before use, to prevent damage to the camera.



This icon marks tips, additional information that may be helpful when using the camera.



This icon marks notes, information that should be read before using the camera.



This icon indicates that more information is available elsewhere in this manual or in the *Quick Start Guide*.

Notations

- In this manual, the product names “COOLPIX L22” and “COOLPIX L21” may sometimes be abbreviated as “L22” and “L21”.
- A Secure Digital (SD) memory card is referred to as a “memory card”.
- The setting at the time of purchase is referred to as the “default setting”.
- The names of menu items displayed in the camera monitor, and the names of buttons or messages displayed in the computer monitor appear in bold.

Screen Samples

In this manual, images are sometimes omitted from monitor display samples so that monitor indicators can be more clearly shown.

Illustrations and Screen Display

- Illustrations and text displays shown in this manual are for COOLPIX L22. Illustrations and text displays for COOLPIX L21 may also be shown in this manual if necessary.
- Illustrations and text displays shown in this manual may differ from actual appearance or display.



Memory Cards

Pictures taken with this camera can be stored in the camera’s internal memory or on removable memory cards. If a memory card is inserted, all new pictures will be stored on the memory card and delete, playback and format operations will apply only to the pictures on the memory card. The memory card must be removed before the internal memory can be formatted or used to store, delete or view pictures.

Information and Precautions

Life-Long Learning

As part of Nikon's "Life-Long Learning" commitment to ongoing product support and education, continually updated information is available online at the following sites:

- For users in the U.S.A.: <http://www.nikonusa.com/>
- For users in Europe and Africa: <http://www.europe-nikon.com/support/>
- For users in Asia, Oceania, and the Middle East: <http://www.nikon-asia.com/>

Visit these sites to keep up-to-date with the latest product information, tips, answers to frequently asked questions (FAQs), and general advice on digital imaging and photography. Additional information may be available from the Nikon representative in your area. See the URL below for contact information:

<http://imaging.nikon.com/>

Use Only Nikon Brand Electronic Accessories

Nikon COOLPIX cameras are designed to the highest standards and include complex electronic circuitry. Only Nikon brand electronic accessories (including battery chargers, batteries and AC adapters) certified by Nikon specifically for use with this Nikon digital camera are engineered and proven to operate within the operational and safety requirements of this electronic circuitry.

THE USE OF NON-NIKON ELECTRONIC ACCESSORIES COULD DAMAGE THE CAMERA AND MAY VOID YOUR NIKON WARRANTY.

For more information about Nikon brand accessories, contact a local authorized Nikon dealer.

Before Taking Important Pictures

Before taking pictures on important occasions (such as at weddings or before taking the camera on a trip), take a test shot to ensure that the camera is functioning normally. Nikon will not be held liable for damages or lost profits that may result from product malfunction.

About the Manuals

- No part of the manuals included with this product may be reproduced, transmitted, transcribed, stored in a retrieval system, or translated into any language in any form, by any means, without Nikon's prior written permission.
- Nikon reserves the right to change the specifications of the hardware and software described in these manuals at any time and without prior notice.
- Nikon will not be held liable for any damages resulting from the use of this product.
- While every effort was made to ensure that the information in these manuals is accurate and complete, we would appreciate it were you to bring any errors or omissions to the attention of the Nikon representative in your area (address provided separately).

Notice Concerning Prohibition of Copying or Reproduction

Note that simply being in possession of material that was digitally copied or reproduced by means of a scanner, digital camera or other device may be punishable by law.

- **Items prohibited by law from being copied or reproduced**

Do not copy or reproduce paper money, coins, securities, government bonds or local government bonds, even if such copies or reproductions are stamped "Sample". The copying or reproduction of paper money, coins, or securities which are circulated in a foreign country is prohibited. Unless the prior permission of the government was obtained, the copying or reproduction of unused postage stamps or post cards issued by the government is prohibited. The copying or reproduction of stamps issued by the government and of certified documents stipulated by law is prohibited.

- **Cautions on certain copies and reproductions**

The government has issued cautions on copies or reproductions of securities issued by private companies (shares, bills, checks, gift certificates, etc.), commuter passes or coupon tickets, except when a minimum of necessary copies are to be provided for business use by a company. Also, do not copy or reproduce passports issued by the government, licenses issued by public agencies and private groups, ID cards and tickets, such as passes and meal coupons.

- **Comply with copyright notices**

The copying or reproduction of copyrighted creative works such as books, music, paintings, woodcut prints, maps, drawings, movies and photographs is governed by national and international copyright laws. Do not use this product for the purpose of making illegal copies or to infringe copyright laws.

Disposing of Data Storage Devices

Please note that deleting images or formatting data storage devices such as memory cards or built-in camera memory does not completely erase the original image data. Deleted files can sometimes be recovered from discarded storage devices using commercially available software, potentially resulting in the malicious use of personal image data. Ensuring the privacy of such data is the user's responsibility.



Before discarding a data storage device or transferring ownership to another person, erase all data using commercial deletion software, or format the device and then completely refill it with images containing no private information (for example, pictures of empty sky). Be sure to also replace any pictures selected for the welcome screen (📖 88). Care should be taken to avoid injury or damage to property when physically destroying data storage devices.

Parts of the Camera

The Camera Body

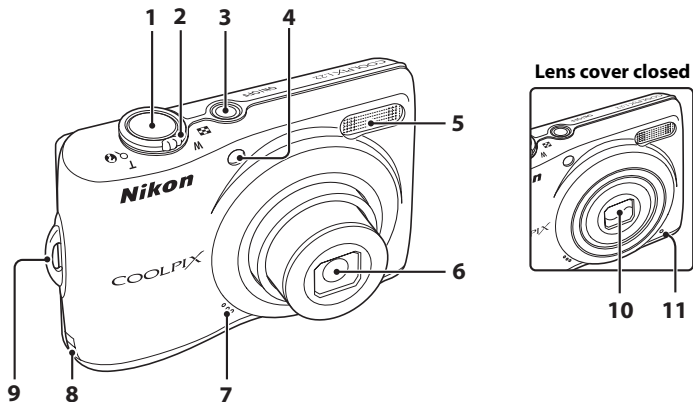
COOLPIX L22 Front View



1	Shutter-release button	24	5	Built-in flash	30
	Zoom control	23	6	Lens	114, 124
	W : wide	23	7	Speaker	57
2	T : tele	23	8	Power connector cover (for connecting optional AC adapter)	110
	 : Thumbnail playback	48	9	Eyelet for camera strap	13
	 : playback zoom	50	10	Lens cover	112
	 : help	13	11	Built-in microphone	55
3	Power switch/Power-on lamp	20, 99			
4	Self-timer lamp	32			
	AF-assist illuminator	25, 97			

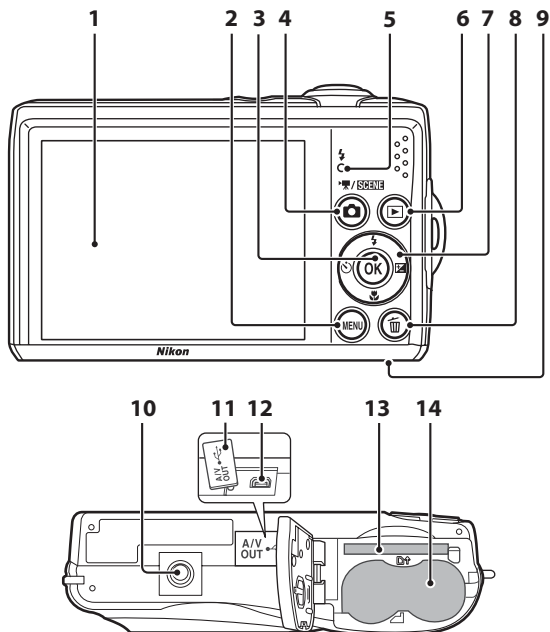

COOLPIX L22 Rear View

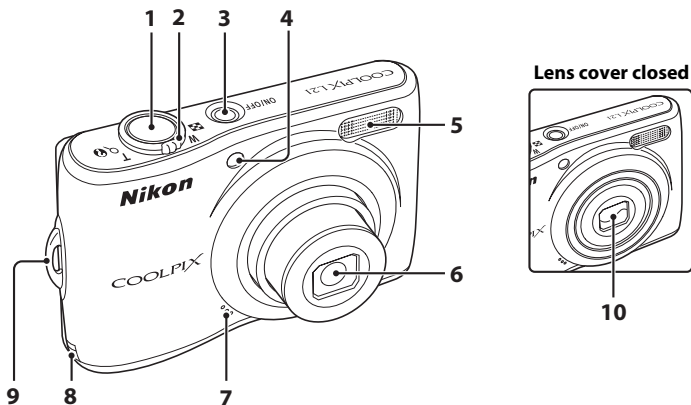

1	Monitor	8	9	Battery-chamber/ memory card slot cover	14, 18
2	MENU button	12, 56, 73, 81, 86	10	Tripod socket	
3	OK (apply selection) button	11	11	Pin cover	58, 60, 65
4	⌂ (shooting mode) button	10	12	USB connector and audio/video output	58, 60, 65
5	Flash lamp	31	13	Memory card slot	18
6	▶ (playback) button	10, 26	14	Battery-chamber	14
7	Multi selector	11			
8	⌫ (delete) button	26, 27, 57			

COOLPIX L21 Front View



1	Shutter-release button 24	5	Built-in flash 30
2	Zoom control 23	6	Lens 114, 124
	W : wide 23	7	Built-in microphone 55
	T : tele 23	8	Power connector cover (for connecting optional AC adapter) 110
	 : Thumbnail playback 48	9	Eyelet for camera strap 13
	 : playback zoom 50	10	Lens cover 112
	 : help 13		
3	Power switch/Power-on lamp 20, 99		
4	Self-timer lamp 32		
	AF-assist illuminator 25, 97		

COOLPIX L21 Rear View

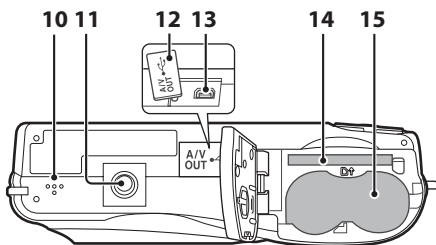
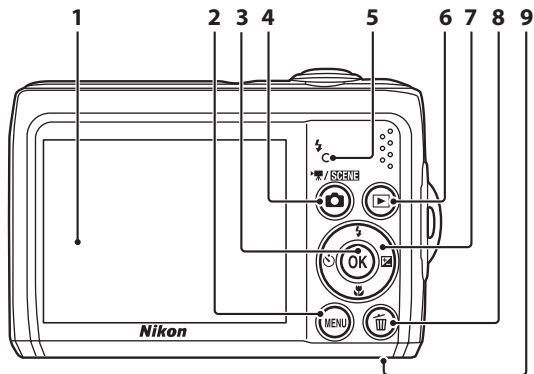

1	Monitor	8	9	Battery-chamber/ memory card slot cover	14, 18
2	MENU button	12, 56, 73, 81, 86	10	Speaker	57
3	OK (apply selection) button	11	11	Tripod socket	
4	📷 (shooting mode) button	10	12	Pin cover	58, 60, 65
5	Flash lamp	31	13	USB connector and audio/video output	58, 60, 65
6	▶ (playback) button	10, 26	14	Memory card slot	18
7	Multi selector	11	15	Battery-chamber	14
8	🗑️ (delete) button	26, 27, 57			

The Monitor

The following indicators may appear in the monitor during shooting and playback (actual display varies with current camera settings).

The indicators and photo info displayed during shooting and playback will turn off after a few seconds (📖 92).

Shooting

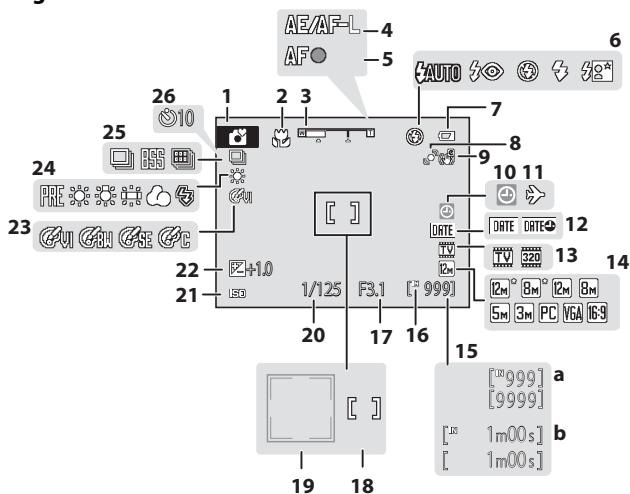

1 Shooting mode* ¹20, 29, 35, 46, 55	15 a Number of exposures remaining (still pictures) 20
2 Macro mode 33	b Movie length 55
3 Zoom indicator23, 33	16 Internal memory indicator 21
4 AE/AF-L indicator 45	17 Aperture 24
5 Focus indicator 24	18 Focus area22, 24
6 Flash mode 30	19 Focus area (Face Detection)22, 24
7 Battery level indicator 20	20 Shutter speed 24
8 Motion detection indicator21, 96	21 ISO sensitivity 31
9 Electronic VR 95	22 Exposure compensation value 34
10 "Date not set" indicator89, 116	23 Color options 79
11 Travel destination indicator 89	24 White balance mode 76
12 Date imprint 94	25 Continuous shooting mode 78
13 Movie options 56	26 Self-timer indicator 32
14 Image mode* ² 74	



*¹ Differs according to the current shooting mode. Refer to the sections on each mode for details.

*² 📷^a and 📷^b are displayed on L22, and 📷^c is displayed on L21.

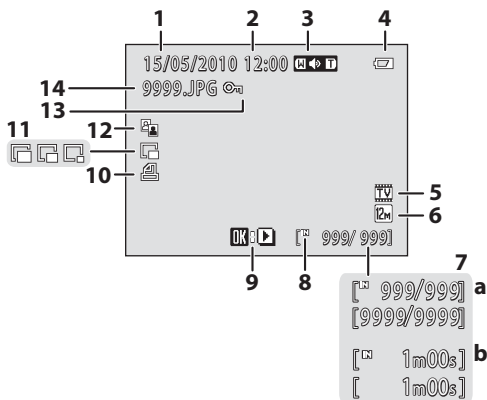
Playback





1	Date of recording	16	8	Internal memory indicator	26
2	Time of recording	16	9	Movie playback indicator	57
3	Volume	57	10	Print-order icon	70
4	Battery level indicator	20	11	Small picture	53
5	Movie options*	56	12	D-Lighting icon	52
6	Image mode*	74	13	Protect icon	106
7	a Current frame number/ total number of frames	26	14	File number and type	111
	b Movie length	57			

* The displayed icons vary with the settings in shooting mode.  and  are displayed on L22, and  is displayed on L21.

Basic Operations

(shooting mode) button









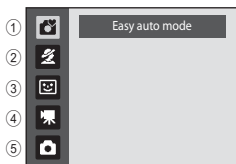



- When  is pressed in playback mode, the camera enters shooting mode.
- When  is pressed in shooting mode, the shooting-mode selection menu is displayed, which allows you to change the shooting mode.

Shooting-mode Selection Menu

The multi selector ( 11) can be used to select one of the following shooting modes.





- ①  Easy auto mode ( 20)
- ②  Scene ( 35)*
- ③  Smart portrait ( 46)
- ④  Movie mode ( 55)
- ⑤  Auto mode ( 29)

* The displayed icons vary depending on the last mode selected.

When  is pressed while the shooting-mode selection menu is displayed, the camera returns to shooting mode without changing the current shooting mode.

(playback) button



- During shooting mode, the camera enters the playback mode when  is pressed.
- If the camera is turned off, hold down  to turn the camera on in playback mode.

The Multi Selector

This section describes standard uses of the multi selector to select modes, select menu options and to apply selection.

Operate the multi selector by pressing it up, down, left, right, and by pressing **OK**.

For Shooting

Display  (flash mode) menu (📖 30)/select the item above.

Display  menu (📖 32).

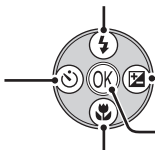

Display  (exposure compensation) guide (📖 34).

Apply selection.

Display  (macro mode) menu (📖 33)/select the item below.

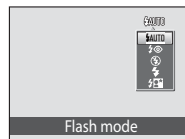

For Playback

Display the previous picture.

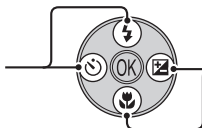

Display the next picture.



For the Menu Screen

Select the item above.

Select the item to the left/return to the previous screen.

Select the item below.

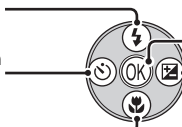



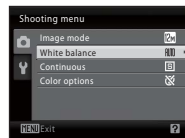

Apply selection (Go to the next screen).

Select the item to the right/go to the next screen (apply selection).



Notes on the Multi Selector

In this manual, , ,  and  are used in some cases for indicating the up, down, left and right operating parts of the multi selector.

MENU button

Press **MENU** to display the menu for the selected mode.

- Use the multi selector to apply settings (📖 11).
- Select a tab on the left side of the monitor to display the corresponding menu.
- To exit the menu display, press **MENU** again.

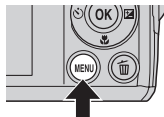

Upper tab: Menus available for the current mode are displayed.

Lower tab: Display the setup menu.

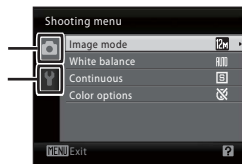

Displayed when the menu contains two or more pages.

Displayed when there are more previous menu items.

Displayed when there are one or more menu items to follow.

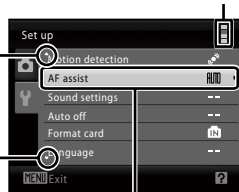

While an item is selected, press **OK** or the multi selector **▶** to display that item's options.

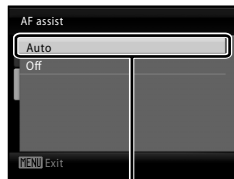

Press **OK** or the multi selector **▶** to apply selection.

Switching Between Tabs

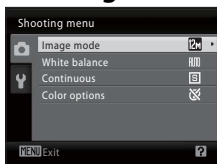

Press the multi selector **◀** to highlight the tab.

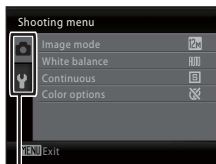

Press the multi selector **▲▼** to select a tab and press **OK** or **▶**.

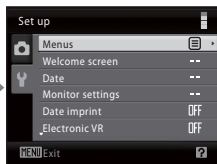

The selected menu will be displayed.

When using the following modes, you can display the tabs by pressing the multi selector **◀** while the menu is displayed.

- Easy auto mode, scene mode, smart portrait mode and movie mode

Help Displays

Rotate the zoom control to **T** (?) when **?** (?) is displayed at the lower right of the menu screen to view a description of the currently selected option.

To return to the original menu, rotate the zoom control to **T** (?) again.

COOLPIX L22

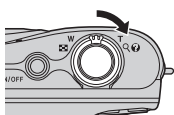

COOLPIX L21

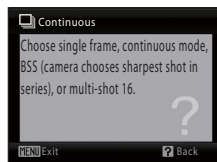
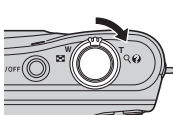

About the Shutter-release Button

The camera features a two-stage shutter-release button. To set focus and exposure, press the shutter-release button halfway, stopping when you feel resistance. Focus and exposure lock while the shutter-release button is held in this position. To release the shutter and take a picture, press the shutter-release button the rest of the way down. Do not use force when pressing the shutter-release button, as this may result in camera shake and blurred pictures.



Press the shutter-release button halfway to set focus and exposure.

Press the shutter-release button the rest of the way down to take picture.

Attaching the Camera Strap

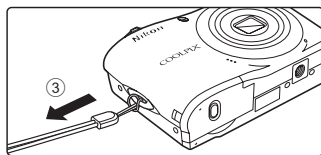
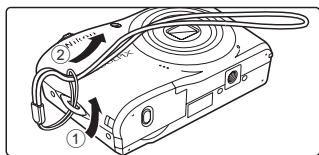

Inserting the Batteries

1 Open the battery-chamber/memory card slot cover.

- Before opening the battery-chamber/memory card slot cover, hold the camera upside down to prevent the batteries from falling out.

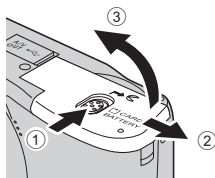

2 Inserting the Batteries.

- Confirm that the positive (+) and negative (-) terminals are oriented correctly as described on the label at the entrance of the battery chamber, and insert the batteries.

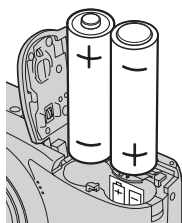

3 Close the battery-chamber/memory card slot cover.

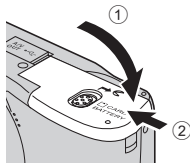

Applicable Batteries

- Two LR6/L40 (AA-size) alkaline batteries (batteries supplied)
- Two FR6/L91 (AA-size) lithium batteries
- Two EN-MH2 Ni-MH (nickel metal hydride) rechargeable batteries

Turning On and Off the Camera

Press the power switch to turn on the camera. After the power-on lamp (green) lights for a moment, the monitor turns on. When the camera turns off, both the power-on lamp and monitor will turn off.

COOLPIX L22

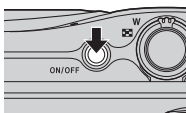

COOLPIX L21

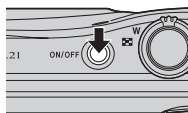

- If the camera is turned off, hold down  to turn the camera on in playback mode (📖 26).

✔ Removing the Batteries

Confirm the power-on lamp and the monitor are off and open the battery-chamber/ memory card slot cover.

✔ Additional Precautions Regarding Batteries

- Read and follow the warnings and cautions (📖 iii, 113).
- Be sure to read and follow the warnings for the battery on page iii and the section, “The Battery” (📖 113), before using the battery.
- Do not combine old and new batteries or batteries of different makes or types.
- Batteries with the following defects cannot be used:

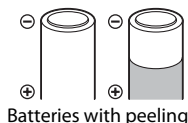

Batteries with peeling

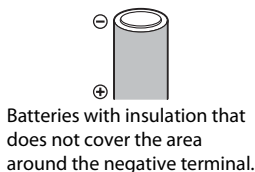

Batteries with insulation that does not cover the area around the negative terminal.

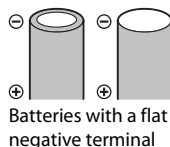

Batteries with a flat negative terminal

✔ Notes for EN-MH1 Rechargeable Batteries, MH-70/71 Battery Charger

This camera can also use EN-MH1 Ni-MH rechargeable batteries.

Be sure to read and follow the warnings for the battery found in the section, “The Battery” (📖 113), before using the battery.

✔ Battery Type

By setting **Battery type** (📖 105) in the setup menu (📖 85) to match the type of batteries inserted in the camera, the batteries can perform more efficiently.

The default setting is the type of battery supplied with purchase. When any other type of battery is used, turn the camera on and change the setting (📖 105).

📎 Alkaline Batteries



Performance of alkaline batteries may vary greatly depending on the manufacturer. Choose a reliable brand.

📎 Alternative Power Sources

To power the camera continuously for extended periods, use an AC Adapter EH-65A (available separately) (📖 110). **Do not, under any circumstances, use another make or model of AC adapter.** Failure to observe this precaution could result in overheating or in damage to the camera.

📎 Auto Power Off in Shooting Mode (Standby Mode)

If no operations are performed for about 30 seconds (default setting), the monitor will turn off automatically and the camera will enter standby mode. After a further three minutes, the Auto off function will turn the camera off automatically.

- While the monitor is off during standby mode (the power-on lamp flashes), it will turn on again when the power switch, shutter-release button,  button, or  button is pressed.
- The time allowed to elapse before the camera enters standby mode can be changed from the **Auto off** option (📖 99) in the setup menu (📖 85).

Setting Display Language, Date and Time

A language-selection dialog is displayed the first time the camera is turned on.

1 Press the power switch to turn on the camera.

The power-on lamp (green) will light for a moment and the monitor will turn on.

COOLPIX L22

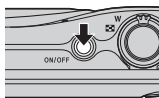

COOLPIX L21

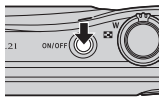

2 Use the multi selector to choose the desired language and press **OK**.

For information on using the multi selector, see "The Multi Selector" (📖 11).

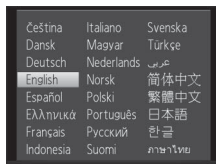

3 Choose **Yes** and press **OK**.

If **No** is selected, the date and time will not be set.

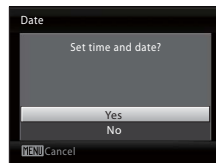

4 Press **◀** or **▶** to select your home time zone (city name) (📖 91) and press **OK**.

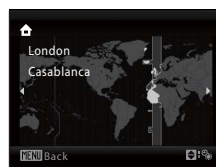

Daylight Saving Time

To use the camera in an area where daylight saving time is in effect, press **▲** on the home time zone in Step 4 to set the daylight saving time to on.

When the daylight saving time setting is selected, the  mark appears on the top of the monitor. To release the daylight saving time setting, press **▼**.



5 Change the date and time.

- Press ▲ or ▼ to edit the highlighted item.
- Press ► to move the cursor in the following order.
D -> M -> Y -> Hour -> Minute -> **D M Y**
- Press ◀ to return to the previous item.

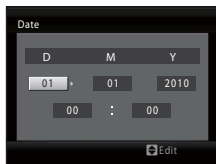

6 Choose the order in which the day, month and year are displayed and press OK or ►.

- The settings are applied.

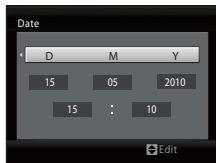

7 Press [Camera icon] to exit the screen.

- The shooting-mode selection menu will be displayed.

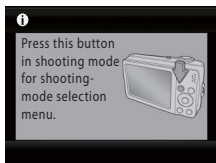

8 When Easy auto mode is displayed, press OK.

- The camera enters the shooting mode and you can take pictures in Easy auto mode (📖 20).
- Press the multi selector ▲ or ▼ before OK, to switch to another shooting mode. See "Shooting in the Auto Mode" (📖 29), "Using the Scene Mode" (📖 35), "Using Smart Portrait Mode" (📖 46) or "Recording Movies" (📖 55) for more information.

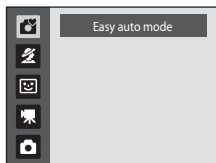

📷 Changing the Date and Time, Date Imprint

- To change the date and time, select **Date** from **Date** (📖 89) in the setup menu (📖 85) and follow the instructions starting from the above step 5.
- To change the time zone and the daylight saving settings, select **Time zone** from **Date** in the setup menu (📖 89, 90).
- To imprint the shooting date into images when taking pictures, make sure the date and time are set, then set **Date imprint** (📖 94) in the setup menu.

Inserting Memory Cards

Images are saved in the camera's internal memory (approximately 19 MB) or on removable Secure Digital (SD) memory cards (available separately) (110).

If a memory card is inserted in the camera, pictures are automatically stored on the memory card and pictures recorded to the memory card can be played back, deleted or transferred. Remove the memory card to store pictures in the internal memory, or play back, delete or transfer pictures from the internal memory.

First Steps

- 1 Confirm the power-on lamp and the monitor are off and open the battery-chamber/memory card slot cover.

Be sure to turn off the camera before opening the battery-chamber/memory card slot cover.

Before opening the battery-chamber/memory card slot cover, hold the camera upside down to prevent the batteries from falling out.

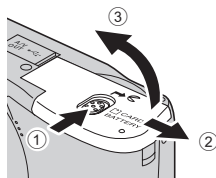

- 2 Insert the memory card.

Slide the memory card in correctly until it clicks into place.

Close the battery-chamber/memory card slot cover.

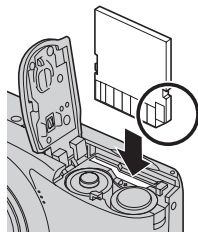

✓ Inserting Memory Cards

Inserting the memory card upside down or backwards could damage the camera or the memory card. Make sure that the memory card is correctly oriented.

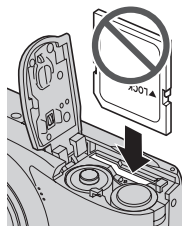

Removing Memory Cards

Before removing memory cards, **turn the camera off** and confirm that the power-on lamp and the monitor are off. Open the battery-chamber/memory card slot cover and press the card in (1) to partially eject the card. Remove the card (2), being careful not to bend it.

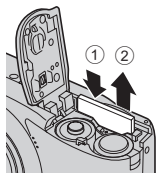

✓ Formatting Memory Cards

If the message shown on the right is displayed, the memory card must be formatted before use. **Note that formatting permanently deletes all pictures and other data on the memory card.** Be sure to make copies of any pictures you wish to keep before formatting the memory card.

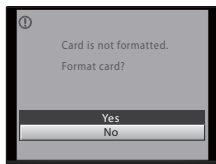

To format, use the multi selector to select **Yes** and press **OK**. The confirmation dialog will be displayed. To start formatting, choose **Format** and press **OK**.

- Do not turn the camera off or open the battery-chamber/memory card slot cover until formatting is complete.
- **The first time you insert the memory cards used in other devices into the camera, be sure to format them using this camera** (100).

✓ The Write Protect Switch

SD memory cards are equipped with a write protect switch. Pictures cannot be recorded or deleted and the memory card cannot be formatted when this switch is in the "lock" position. Unlock by sliding the switch to the "write" position.

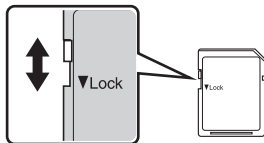

Write protect switch



✓ Memory Cards

- Use only Secure Digital memory cards.
- Do not perform the following during formatting, while data is being written to or deleted from the memory card, or during data transfer to a computer. Failure to observe this precaution could result in the loss of data or in damage to the camera or memory card:
 - Insert or remove the card
 - Remove the batteries
 - Turn off the camera
 - Disconnect the AC adapter
- Do not format the memory card using a computer.
- Do not disassemble or modify.
- Do not drop, bend, or expose to water or strong physical shocks.
- Do not touch the metal terminals with your fingers or metal objects.
- Do not affix labels or stickers to the memory card.
- Do not leave in direct sunlight, closed vehicles or areas exposed to high temperatures.
- Do not expose to humidity, dust, or to corrosive gases.

Step 1 Turn the Camera On and Select (Easy Auto) Mode

In  (easy auto) mode, the camera automatically determines an appropriate shooting mode when you frame a picture, allowing you to easily take pictures using a shooting mode that suits the scene ( 28).

1 Press the power switch to turn on the camera.

The power-on lamp (green) will light for a moment and the monitor will turn on. The lens will extend at this time.

Easy auto mode is set at the time of purchase. Proceed to step 4.

COOLPIX L22

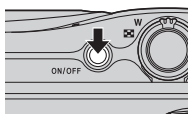

COOLPIX L21

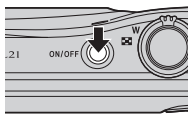

2 Press to display the shooting-mode selection menu.

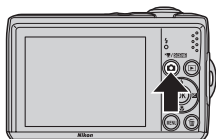

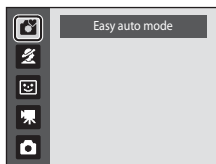

3 Press the multi selector to choose and press .

- The camera enters  (easy auto) mode.



4 Check the battery level and number of exposures remaining.

Battery level indicator

Monitor	Description
NO INDICATOR	The battery level is high.
	Batteries low. Prepare to replace batteries.
 Battery exhausted.	Cannot take pictures. Replace with new batteries.

Battery level indicator

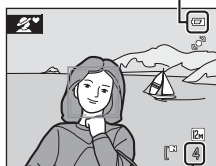







Number of exposures remaining

Number of Exposures Remaining

The number of pictures that can be stored depends on the capacity of the internal memory or memory card and image mode setting ( 75).

Indicators Displayed in (Easy auto) Mode

Shooting mode

When using easy auto mode, , , , , , , or  is displayed to indicate the shooting mode selected by the camera for the current subject and framing.

Motion detection indicator
Reduce the blurring caused by subject or camera shake.

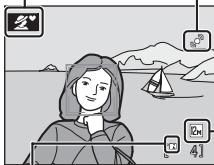

Internal memory indicator





Pictures will be recorded to internal memory (approximately 19 MB).
When memory card is inserted,  is not displayed and pictures will be recorded to memory card.







Image mode

Display image size and quality set in the image mode menu.
The default settings are as follows:
L22:  4000×3000
L21:  3264×2448

The indicators and photo info displayed during shooting and playback will turn off after a few seconds ( 92).

When the monitor has turned off in standby mode to save power, press the power switch, the shutter-release button, or  to reactivate it ( 99).







Available functions in easy auto mode

- When the camera is pointed at a person's face, the camera automatically detects the face and focuses on it ( 24, 28).
- The flash setting can be set to  (off) ( 30).
- The self-timer ( 32) and exposure compensation ( 34) are available.
- The macro mode button on the multi selector ( 11, 33) is disabled. Changes to macro mode when the camera selects close-up scene mode.
- Image mode ( 74) can be changed by pressing **MENU**.

Motion Detection

See **Motion detection** ( 96) in the setup menu ( 85) for more information.

Electronic Vibration Reduction

When the flash mode ( 30) is set to  (off) or  (slow sync) while **Electronic VR** ( 95) in the setup menu is set to **Auto**, the  icon may be displayed in the monitor.  indicates shooting conditions in which the effects of camera shake can be pronounced. In these situations, the camera reduces the effects of camera shake in pictures before saving them.

Step 2 Frame a Picture

1 Ready the camera.

Hold the camera steadily in both hands, keeping your fingers and other objects away from the lens, flash, self-timer lamp and microphone.



When taking pictures in “tall” orientation, turn the camera so that the built-in flash is above the lens.

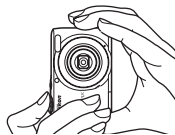

2 Frame the picture.

- When the camera determines the scene mode, the shooting mode icon will change (📖 28).
- When the camera detects a human face, that face will be framed by a yellow double border.
- Up to 12 faces can be recognized. If more than one face is recognized, the face closest to the camera will be framed in the focus area by a double border, and the other faces will be framed by a single border.
- When shooting non-human subjects or when no faces are detected, focus will be in the center of the monitor. Position the main subject near the center of the monitor.

Shooting mode icon

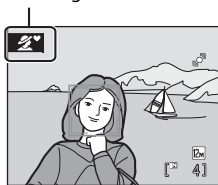

✓ Easy auto mode

- The desired scene mode may not be selected in certain conditions. In this case, select another shooting mode.
- When digital zoom is in effect, the shooting mode is .

Using the Zoom

Use the zoom control to activate optical zoom.

Rotate the zoom control to **T** to zoom in on the subject.

Rotate the zoom control to **W** to zoom out.

The zoom indicator is displayed at the top of the monitor when the zoom control is rotated.

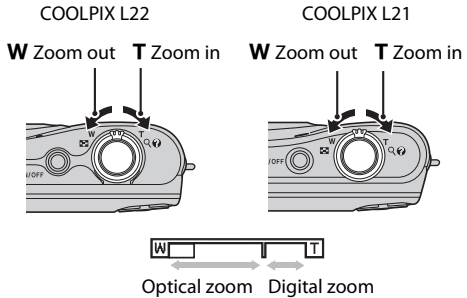

Digital Zoom

When the camera is zoomed in to the maximum optical zoom position, rotating and holding the zoom control at **T** triggers digital zoom. Digital zoom can magnify the subject up to about 4x beyond the magnification of the optical zoom.

The focus area is not displayed when digital zoom is in effect, and focus will be in the center of the screen.

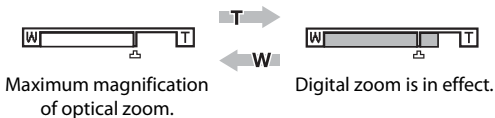

Digital Zoom and Interpolation

Unlike optical zoom, digital zoom uses a digital imaging process known as interpolation to magnify images, resulting in slight deterioration of picture quality.

Interpolation is applied at zoom positions beyond .

When zoom is increased beyond the  position, interpolation is initiated and the zoom indicator turns yellow to indicate that interpolation is being applied.

The position of  moves to the right as image size decreases, allowing for confirmation of the zoom positions at which shooting without interpolation is possible at the current image mode setting.



Step 3 Focus and Shoot

1 Press the shutter-release button halfway.

- Press halfway (📖 13) to focus. When the subject is in focus, the focus area will glow green.

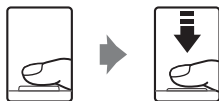

When a face is detected:



Shutter Speed Aperture

When no faces are detected:



Focus indicator

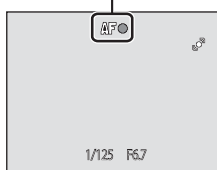

- When using the digital zoom, the camera focuses on the center of the frame, but the focus area is not displayed. When the subject is in focus, the focus indicator (📖 8) will glow green.
- The shutter speed and aperture are displayed when the shutter-release button is pressed halfway.
- Focus and exposure remain locked while the shutter release button is pressed halfway.
- When the camera is unable to focus, the focus area, or focus indicator, blinks red. Change the composition and try pressing the shutter-release button halfway again.

2 Press the shutter-release button the rest of the way down.

- The picture will be recorded to the memory card or internal memory.



During Recording

While pictures are being recorded, the number of exposures remaining display will blink. **Do not open the battery-chamber/memory card slot cover.**

Removing the battery or the memory card while data is being saved may result in loss of data or in damage to the saved data, camera or card.

Autofocus performance

Autofocus may not perform as expected in the following situations. In some rare cases, the subject may not be in focus despite the fact that the focus area or the focus indicator glows green:



- Subject is very dark
- Objects of sharply differing brightness are included in the scene (e.g. the sun is behind the subject and the subject is in deep shadow)
- No contrast between the subject and surroundings (e.g. when the subject is standing in front of a white wall, wearing a white shirt)
- Several objects are at different distances from the camera (e.g. the subject is inside a cage)
- Subject is moving rapidly

In these situations, try pressing the shutter-release button halfway again to refocus, several times if necessary. If the subject is still not in focus, select auto mode and use focus lock ( 29) to take the picture by first focusing on an object that is the same distance from the camera as the desired subject.



Notes about Face Detection

See "Notes about Face Detection" ( 28) for more information.

The Did someone blink? Screen

When  **Blink warning** is set to **On**, the **Did someone blink?** screen ( 102) is displayed after taking a picture if the camera detects a face with closed eyes.

AF-assist Illuminator and Flash

If the subject is poorly lit, the AF-assist illuminator ( 97) may light when the shutter-release button is pressed halfway, and the flash ( 30) may fire when the shutter-release button is pressed all the way down.

Step 4 Viewing and Deleting Pictures

Viewing Pictures (Playback Mode)



Press  (playback).

The last picture taken will be displayed in full-frame playback mode.

Use the multi selector , ,  or  to view additional pictures. Hold down the multi selector , , , or  to scan quickly through pictures.

Pictures may be displayed briefly at low resolution while being read from the memory card or internal memory.

Press  to switch to shooting mode.

When  is displayed, pictures stored in the internal memory will be displayed. When memory card is inserted,  is not displayed and pictures stored on the memory card will be displayed.

 (shooting mode) button

 (playback)

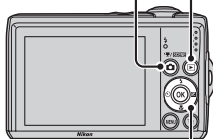

Multi selector

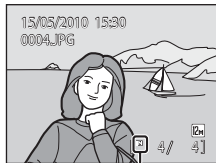

Internal memory indicator

Deleting Pictures

- 1 Press  to delete the picture currently displayed in the monitor.

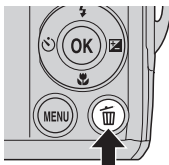

- 2 Use the multi selector to select **Yes** and press .







Deleted pictures cannot be recovered.

To exit without deleting the picture, choose **No** and press .



Playback Mode



The following options are available in full-frame playback mode.

Option	Use	Description	
Playback zoom	T 	The picture can be enlarged up to about 10x. Press OK to return to full-frame playback.	50
View thumbnails	W 	Rotate the zoom control to W to display 4, 9 or 16 picture thumbnails. While viewing 16 picture thumbnails, rotate the zoom control to W  to switch to calendar display.	48, 49
Switch to shooting mode		Press  .	10

Power ON by Pressing

When the camera is off, hold down  to turn on the camera in playback mode. The lens will not extend.

Viewing Pictures



- Pictures stored in the internal memory can only be viewed if no memory card is inserted.
- Pictures taken using face detection ( 24) will be automatically rotated when viewing them full-frame.
- When the monitor has turned off in standby mode to save power, press the power switch, the shutter-release button, or  to reactivate it ( 99).

Deleting the Last Picture Taken While in Shooting Mode

In shooting mode, press  to delete the last picture taken.









Selecting Multiple Pictures for Deletion

When **Delete** ( 84) is selected from the playback menu ( 81), multiple pictures can be deleted.

Easy auto mode

Automatic Scene Selection

The camera automatically selects one of the following scenes when you point the camera at a subject.

-  Auto mode (general use)
-  Portrait (📖 36)
-  Landscape (📖 36)
-  Night portrait (📖 37)
-  Night landscape (📖 39)
-  Close-up (📖 40)
-  Backlight (📖 41)







Notes about Face Detection

- Depending on shooting conditions, such as whether or not the subject is facing the camera, faces may not be detected.

The camera may be unable to detect faces in the following situations:

- When faces are partially hidden by sunglasses or other obstructions
- When faces take up too much or too little of the frame
- When there are multiple people in the frame, the face on which the camera focuses depends on a variety of shooting conditions, such as whether or not the subject is facing the camera.
- In some cases, included those noted in “Autofocus performance” (📖 25), autofocus may not perform as expected, and the subject may not be in focus despite the fact that the double border glows green. When the camera is unable to focus, use another mode, such as  (auto) mode, focus on another subject positioned at the same distance from the camera as the actual portrait subject, and use focus lock (📖 29).

Shooting in the Auto Mode





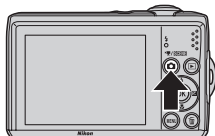

In  (auto) mode, macro mode ( 33) and exposure compensation ( 34) can be applied and pictures can be taken using the flash mode ( 30) and self-timer ( 32). Pressing the **MENU** button in  (auto) mode allows you to set the items in the shooting menu ( 72) according to shooting conditions.

1 Press to display the shooting-mode selection menu.

- The shooting-mode selection menu will be displayed.



2 Press the multi selector or to choose and press .

- The camera enters  (auto) mode.
- Set the flash ( 30), self-timer ( 32), macro mode ( 33) and exposure compensation ( 34) according to shooting conditions.
- By pressing **MENU**, you can also set the items in the shooting menu ( 72) according to shooting conditions.



3 Frame the subject and shoot.

Camera focuses on subject in center of frame.

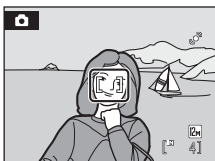

Focus Lock

When the camera focuses on an object in the center of the frame, you can use focus lock to focus on an off-center subject.

- Be sure that the distance between the camera and the subject does not change while focus is locked.
- When the shutter-release button is pressed halfway, exposure is locked.



Position the subject in the center of the frame.



Press the shutter release button halfway.



Confirm that the focus area is green.



Continue holding down the shutter-release button halfway and recompose the picture.



Press the shutter-release button the rest of the way down.

Using the Flash

The flash mode allows you to specify the settings according to shooting conditions.

- For L22, the flash has a range of approx. 0.5-7.0 m (1 ft. 8 in.-23 ft.) when the camera is zoomed out all the way, and 0.5-3.0 m (1 ft. 8 in.-9 ft. 10 in.) when the maximum optical zoom is applied. For L21, the flash has a range of approx. 0.5-5.5 m (1 ft. 8 in.-18 ft.) when the camera is zoomed out all the way, and 0.5-2.5 m (1 ft. 8 in.-8 ft.) when the maximum optical zoom is applied.
- Note that when using easy auto mode (📖 20), only **⚡AUTO Auto** (default setting) and **👁️ Off** are available. When **⚡AUTO Auto** is applied, the camera automatically selects the optimum flash mode setting for the scene mode it has selected.
- The following flash modes are available when shooting in auto mode (📖 29) and certain scene modes (📖 35).

⚡AUTO Auto

Flash fires automatically when lighting is poor.

👁️ Auto with red-eye reduction

Reduces “red-eye” in portraits (📖 31).

👁️ Off

Flash will not fire even when lighting is poor.

👉 Fill flash

Flash fires when a picture is taken. Use to “fill-in” (illuminate) shadows and back-lit subjects.

👉📷 Slow sync

Auto flash mode is combined with slow shutter speed.

Suitable for taking portraits with the night landscape as the background. Flash illuminates main subject; slow shutter speeds are used to capture background at night or under dim light.

Setting the Flash Mode

- 1 Press **⚡** (flash mode) on the multi selector.

The flash menu is displayed.



- 2 Press the multi selector **▲** or **▼** to select a mode and press **OK**.

The icon for the selected flash mode is displayed at the top of the monitor.

⚡AUTO will disappear after a few seconds regardless of the **Photo info** option (📖 92).

If a setting is not applied by pressing **OK** within a few seconds, the selection will be cancelled.

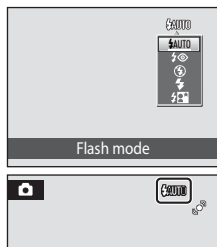

✓ Shooting When Lighting Is Poor and the Flash Is Disabled (🔋)

- Use of a tripod is recommended to stabilize the camera during shooting and avoid the effects of camera shake.
- The **ISO** is displayed when the camera automatically increases sensitivity to minimize blur caused by slow shutter speed. Pictures taken when **ISO** is displayed may be slightly mottled.

✓ Note on Using the Flash

When using the flash, reflections from dust particles in the air may appear as bright spots in pictures. To reduce these reflections, set the flash to 🚫 (Off).

🔧 The Flash Lamp

The flash lamp indicates flash status when the shutter-release button is pressed halfway.

- **On:** Flash will fire when picture is taken.
- **Blinks:** Flash charging. Wait a few seconds and try again.
- **Off:** Flash will not fire when picture is taken.

If the remaining battery level is low, the monitor will turn off until the flash has finished charging.

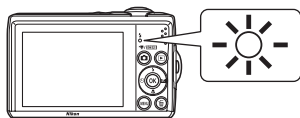

🔧 The Flash Mode Setting

The default setting of the flash mode depends on the shooting mode.

- 📷 (easy auto): 🚫AUTO Auto
- Scene: varies with the selected scene mode (📖 35-42).
- 😊 (smart portrait): 🚫AUTO Auto
- 📷 (auto): 🚫AUTO Auto

Flash cannot be used simultaneously with certain features. → "Camera Settings that Cannot Be Set at the Same Time" (📖 80)

When the shooting mode is 📷 (auto) mode, the changed flash setting will be stored even if the camera is turned off.

🔧 Red-eye Reduction

This camera uses advanced red-eye reduction ("In-Camera Red-Eye Fix").

If the camera detects "red-eye" when a picture is taken, Nikon's own In-Camera Red-Eye Fix processes the image before it is saved.

Note the following when taking pictures:

- The time required to save images increases slightly.
- Red-eye reduction may not always produce the desired results.
- In some rare cases, other portions of pictures may be affected. Use flash modes other than auto with red-eye reduction in above cases.

Taking Pictures with the Self-timer

When using the self-timer, pictures are taken 10 seconds after the shutter-release button is pressed. When using the self-timer, use of a tripod is recommended.

1 Press (self-timer) on the multi selector.

The self-timer menu is displayed.



2 Press the multi selector or to select **ON** and press .

The self-timer icon ( 10) is displayed.

If a setting is not applied by pressing  within a few seconds, the selection will be cancelled.

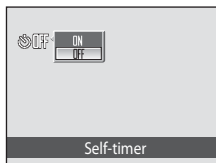

3 Frame the picture and press the shutter-release button halfway.

Focus and exposure will be set.



4 Press the shutter-release button the rest of the way down.

The self-timer starts and the number of seconds remaining until the shutter is released is displayed in the monitor. The self-timer lamp will blink. The lamp stops blinking one second before the picture is taken and remains lit until the shutter is released.



When the shutter is released, the self-timer will be set to **OFF**.

To stop the timer before a picture is taken, press the shutter-release button again.

COOLPIX L22





COOLPIX L21



Macro Mode

Macro mode is used for taking pictures of objects as close as 5 cm (2 in.). Note that the flash may be unable to light entire subject at distances of less than 50 cm (1 ft. 8 in.).

When using  (easy auto) mode ( 20), the macro mode button cannot be used to activate macro mode.

1 Press (macro mode) on the multi selector.

- The macro menu is displayed.





2 Press the multi selector or to select ON and press .

The macro mode icon () is displayed.

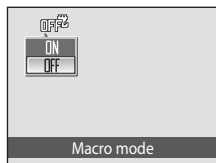
If a setting is not applied by pressing  within a few seconds, the selection will be cancelled.



3 Rotate the zoom control to move to the wide zoom position.

- Macro mode can be used to take a picture at the current zoom position when  or the zoom indicator glows green.
- The camera can focus on objects as close as about 5 cm (2 in.) at the widest zoom position, and as close as about 7 cm (2.8 in.) at the position where  is displayed.

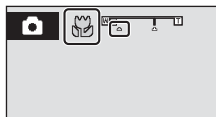

Autofocus

When using macro mode, the camera focuses continuously until the shutter-release button is pressed halfway to lock the focus. A sound will be heard while the camera focuses.

The Macro Mode Setting

When the shooting mode is  (auto) mode, the macro mode setting will be stored even if the camera is turned off.

Exposure Compensation



Exposure compensation is used to alter exposure from the value suggested by the camera to make pictures brighter or darker.

1 Press (exposure compensation) on the multi selector.

- The exposure compensation guide is displayed.



2 Press the multi selector or to select the desired setting and press .

- To make the subject brighter, adjust the exposure compensation to the "+" side.
- To make the subject darker, adjust the exposure compensation to the "-" side.
- Exposure compensation can be set to values between -2.0 and +2.0 EV.
- If a setting is not applied by pressing  within a few seconds, the selection will be cancelled.
- When set to any value other than **0.0**,  and the value are displayed.

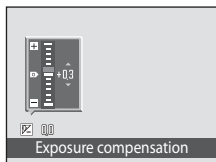

3 Press the shutter-release button to shoot.

- To turn off exposure compensation, repeat from step 1 and set the value to **0.0**, then press .

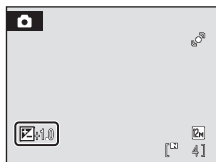

Exposure Compensation Value

When the shooting mode is  (auto) mode ( 29), the exposure compensation setting will be stored even if the camera is turned off.

Using Exposure Compensation



The camera tends to reduce exposure when the frame is dominated by brightly lit objects and to increase exposure when the frame is mostly dark. Positive compensation may therefore be required to capture the brilliancy of very bright objects that fill the frame (for example, sunlit expanses of water, sand, or snow) or when the background is much brighter than the main subject. Negative compensation may be called for when large areas of the frame contain very dark objects (for example, a swath of dark green leaves) or when the background is much darker than the main subject.

Using the Scene Mode

Camera settings are automatically optimized for the selected subject type. The following scene modes are available.

 Portrait	 Party/indoor	 Night landscape	 Fireworks show
 Landscape	 Beach/snow	 Close-up	 Copy
 Sports	 Sunset	 Food	 Backlight
 Night portrait	 Dusk/dawn	 Museum	 Panorama assist

Setting the Scene Mode

- 1 Press  in shooting mode to display the shooting-mode selection menu and use the multi-selector  and  to select scene mode.

The icon of the last scene mode used is displayed.  (Portrait) is the default setting.



- 2 Press , press , , , or  to select a scene mode, then press .

- The shooting mode screen for the selected scene is displayed.
- “Features” →  36

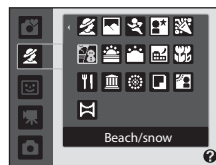

- 3 Frame the subject and shoot.

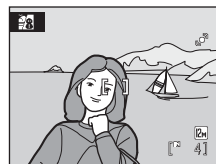





Image Mode

When using scene mode, you can set the **Image mode** setting ( 74) by pressing **MENU**. If the image mode setting is changed, the new image mode setting is also applied to other shooting modes (except movie mode).

Features

The following icons are used for descriptions in this section:  = flash mode (📖 30),  = self-timer (📖 32),  = macro mode (📖 33),  = exposure compensation (📖 34).

Portrait

Use this mode for taking portraits in which the main subject stands out clearly.

- If the camera detects a face, it focuses on the face. See “Face Detection” (📖 24) for more information.
- If more than one face is recognized, the camera focuses on the face closest to the camera.
- If no faces are detected, focus will be on the center of the frame.
- Digital zoom is not available.



* Other settings can be selected.

Landscape

Use this mode for vivid landscapes and cityscapes.



- Camera focuses at infinity. The focus area or focus indicator (📖 8) always glows green when the shutter-release button is pressed halfway. Note, however, that objects in the foreground may not always be in focus.
- The AF-assist illuminator (📖 97) does not light.



* Other settings can be selected.

Sports

Use this mode for dynamic action shots that freeze the action in a single shot and record motion in a series of pictures.

- The camera focuses on the subject in the center of the frame. The camera focuses continuously until the shutter-release button is pressed halfway to lock the focus.
- While the shutter-release button is held down, the L22 shoots up to 5 frames at 0.9 frames per second (fps), and the L21 shoots up to 5 frames at 1 fps (when image mode is set to  **4000×3000** for L22 and  **3264×2448** for L21).
- The maximum frame rate with continuous shooting may vary depending upon the current image mode setting and the memory card used.
- Focus, exposure compensation, and white balance are fixed at the values determined with the first shot in each series.
- The AF-assist illuminator ( 97) does not light.



* Other settings can be selected.

Night portrait

Use this mode to achieve a natural balance between the main subject and background lighting in portraits taken at night. Flash is used to illuminate the subject while maintaining the mood of the background.

- If the camera detects a person's face, the camera will focus on that person (face detection:  24).
- If more than one face is recognized, the camera focuses on the face closest to the camera.
- If no faces are recognized, focus will be on the center of the screen.
- Digital zoom is not available.



*1 Flash mode is set to fill flash with slow sync and red-eye reduction, and cannot be changed.

**2 Other settings can be selected.

: For those scene modes with , use of a tripod is recommended.

Using the Scene Mode

Party/indoor

Captures the effects of candlelight and other indoor background lighting.

- Camera focuses on subject in center of frame.
- As pictures are easily affected by camera shake, hold the camera steadily. In a dark place, the use of a tripod is recommended.



*¹The flash may change to slow sync with red-eye reduction. Other settings can be selected.

*²Other settings can be selected.

Beach/snow

Captures the brightness of such subjects as snowfields, beaches, or sunlit expanses of water.

- Camera focuses on subject in center of frame.



* Other settings can be selected.

Sunset



Preserves the deep hues seen in sunsets and sunrises.

- Camera focuses on subject in center of frame.





* Other settings can be selected.

: For those scene modes with , use of a tripod is recommended.

Dusk/dawn

Preserves the colors seen in the weak natural light before sunrise or after sunset.



- Camera focuses at infinity. The focus area or focus indicator ( 8) always glows green when the shutter-release button is pressed halfway. Note, however, that objects in the foreground may not always be in focus.
- The AF-assist illuminator ( 97) does not light.



* Other settings can be selected.

Night landscape

Slow shutter speeds are used to produce stunning night landscapes.

- Camera focuses at infinity. The focus area or focus indicator ( 8) always glows green when the shutter-release button is pressed halfway. Note, however, that objects in the foreground may not always be in focus.
- The AF-assist illuminator ( 97) does not light.



* Other settings can be selected.

: For those scene modes with , use of a tripod is recommended.

Using the Scene Mode

Close-up

Photograph flowers, insects and other small objects at close range.

- Macro mode (📖 33) will turn **ON** and the zoom will move to a position that allows macro shooting.
- The camera can focus on objects as close as about 5 cm (2 in.) at the widest zoom position, and as close as about 7 cm (2.8 in.) at the position where  is displayed.
- Camera focuses on subject in center of frame. Use focus lock to frame the picture on an object not in the center of the frame (📖 29).
- The camera focuses continuously until focus is locked by pressing the shutter-release button halfway.



* Other settings can be selected. Note that the flash may be unable to light entire subject at distances of less than 50 cm (1 ft. 8 in.).

Food

Use this mode when taking pictures of food. See "Taking Pictures for Food Mode" (📖 43) for details.

- Camera focuses on subject in center of frame.



* Other settings can be selected.

Museum

Use indoors where flash photography is prohibited (for example, in museums and art galleries) or in other settings in which you do not want to use the flash.



- Camera focuses on subject in center of frame.
- BSS (best shot selector) can be used to shoot (📖 78).
- As pictures are easily affected by camera shake, hold the camera steadily.
- The AF-assist illuminator (📖 97) does not light.



* Other settings can be selected.

Fireworks show

Slow shutter speeds are used to capture the expanding burst of light from fireworks.

- Camera focuses at infinity. When the shutter-release button is pressed halfway, the focus indicator ( 8) always glows green. Note, however, that objects in the foreground may not always be in focus.
- The AF-assist illuminator ( 97) does not light.



Copy

Provides clear pictures of text or drawings on a white board or in print.

- Camera focuses on subject in center of frame.
- Use macro mode ( 33) to focus at short ranges.
- Colored text and drawings may not show up well.



* Other settings can be selected.

Backlight

Use when light is coming from behind your subject, throwing features or details into shadow. The flash fires automatically to “fill in” (illuminate) shadows.

- Camera focuses on subject in center of frame.



* Other settings can be selected.

: For those scene modes with , use of a tripod is recommended.

Panorama assist





Use when taking a series of pictures that will later be joined to form a single panorama using the supplied Panorama Maker software. See Taking Pictures for a Panorama (📖 44) for details.



* Other settings can be selected.



Taking Pictures for Food Mode



Use this mode when taking pictures of food.

- 1 Press  in shooting mode to display the shooting-mode selection menu and use the multi selector to select  **Food** (📖 35).

- The macro mode (📖 33) will turn **ON** and the zoom will automatically move to the closest possible shooting position.



- 2 Press the multi selector  or  to adjust the color if necessary.

- You can adjust the hues to compensate for changes in the subject's color caused by the surrounding lighting. Press  to increase the amount of red, or  to increase the amount of blue.

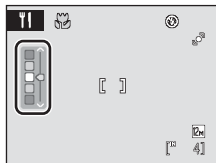

- 3 Frame the picture.

- The camera can focus on objects as close as about 5 cm (2 in.) at the widest zoom position, and as close as about 7 cm (2.8 in.) at the position where  is displayed.
- The camera focuses on the subject in the center of the frame. Use focus lock to frame the picture on an object not in the center of the frame (📖 29).

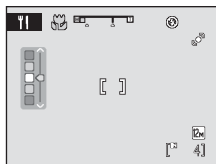

- 4 Press the shutter-release button to shoot.

- Pressing the shutter-release button halfway locks the focus, and pressing the shutter-release button the rest of the way down takes the picture.
- When the camera is unable to focus, the focus area will blink. Change the composition and try pressing the shutter-release button halfway again.



Notes when using the food mode



The flash is disabled. The macro mode (📖 33) will be locked to **ON**.

Adjusting Hues When Using Food Mode

Hue settings that are adjusted in food mode are saved in the camera's memory even after the camera is turned off, and are used the next time food mode is selected.

Taking Pictures for a Panorama





The camera focuses on the subject in the center of the frame. Use a tripod for best results.



- 1 Press  in shooting mode to display the shooting-mode selection menu and use the multi selector to select  **Panorama assist** (📖 35).

The panorama direction icon () is displayed to show the direction in which pictures will be joined.



- 2 Use the multi selector to choose the direction and press .

Select how pictures will be joined together in the completed panorama; right () , left () , up () or down () .

The yellow panorama direction icon () is displayed to the direction pressed and the direction is fixed when  is pressed. The white fixed direction  is displayed.

Apply flash mode (📖 30), self-timer (📖 32), macro mode (📖 33) and exposure compensation (📖 34) settings with this step, if necessary. Press  to reselect the direction.



- 3 Shoot the first picture.

The first picture is superimposed in the first third of the monitor.



- 4 Shoot the second picture.

Frame the next picture so that one third of the frame overlaps the first picture, and press the shutter-release button.

Repeat until you have taken the necessary number of pictures to complete the scene.



5 Press **OK** when shooting is completed.

- The camera returns to step 2.



Panorama Assist

Set flash mode, self-timer, macro mode and exposure compensation before taking the first picture. They cannot be changed after the first picture is taken. Pictures cannot be deleted, nor can zoom or **Image mode** setting (📖 74) be adjusted after the first picture is taken.

The panorama series is terminated if the camera enters standby mode with the auto off function (📖 99) during shooting. Setting the time allowed to elapse before the auto off function is enabled to a longer setting is recommended.

Note on AE/AF-L

When using panorama assist mode, all pictures taken in a panorama series have the same white balance, exposure, and focus settings as the first picture taken.

When the first picture is shot, **AE/AF-L** is displayed to indicate that exposure, white balance, and focus are locked.



Panorama Maker

Install Panorama Maker from the supplied Software Suite CD.





Transfer pictures to a computer (📖 59) and use Panorama Maker (📖 63) to join them in a single panorama.

More Information

See, "Image File and Folder Names" (📖 111) for more information.

Using Smart Portrait Mode

The camera detects a smiling face to shoot the face automatically.

- 1** Press  in shooting mode to display the shooting-mode selection menu and use the multi-selector  and  to select , then press .

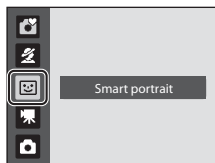

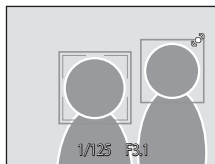

- 2** Frame the picture.

- Point the camera at the subject.
- If the camera detects a person's face, the face will be framed by a double yellow border in the focus area, and when the face comes into focus, the double border will instantly turn green and the focus will be locked.
- Up to three faces will be recognized. When the faces of multiple people are detected, the face nearest the center of the frame will be framed by a double border in the focus area and the other faces will be framed by a single border.



- 3** The shutter is automatically released.

- If the camera detects the smiling face of the person framed by a double border, the shutter is automatically released.
- The self-timer lamp ( 4) blinks when the camera detects a human face. Just after the shutter is released, the self-timer lamp blinks rapidly.
- Each time the shutter is released, the camera again begins face detection and smile detection operations for continuous automatic shooting.
- Pictures can also be taken by pressing the shutter-release button. If the camera does not detect any faces, the camera focuses on the subject in the center of the frame.

- 4** Press  to exit smart portrait mode.

Change to another shooting mode.



Face Detection and Smiling Face Detection features

If the camera is pointed at a person's face while the camera is in smart portrait mode, the face is automatically detected, and the smile of the detected face can also be detected.

- In some shooting conditions, face recognition does not work and faces cannot be detected.
- See "Face Detection" (📖 24) for more information about face detection.

Auto Off (Standby Mode) When Using Smart Portrait Mode

When using smart portrait mode, auto off (📖 99) will turn the camera off if no operations are performed in the following situations:

- The camera does not recognize any faces.
- The camera detected a face but cannot detect a smiling face.

Functions Available in Smart Portrait Mode

- Flash mode (📖 30) can be changed.
- Self-timer (📖 32) and macro mode (📖 33) cannot be used.
- Exposure compensation (📖 34) can be adjusted.
- When **MENU** is pressed to display the 😊 (smart portrait) menu, **Image mode** (📖 74) can be adjusted. If the image mode setting is changed, the new image mode setting is also applied to other shooting modes (except movie mode).
- Digital zoom is not available.

More Information

See, "Autofocus" (📖 25) for more information.

Viewing Multiple Pictures: Thumbnail Playback

Rotate the zoom control to **W** (📐) in full-frame playback mode (📖 26) to display pictures in “contact sheets” of thumbnail images. The following operations can be performed while thumbnails are displayed.



To	Use	Description	📖
Choose pictures		Press the multi selector ▲, ▼, ◀ or ▶.	11
Display the calendar/ Change the number of frames displayed	W (📐) T (🕒)	Rotate the zoom control to W (📐) to change the number of frames displayed from 4 → 9 → 16, or to display the calendar. When the calendar is displayed, you can select images to view based on the day they were taken (📖 49). Rotate the zoom control to T (🕒) to return to thumbnail display mode.	–
Reduce the number of frames displayed	T (🕒)	Rotate the zoom control to T (🕒) to change the number of frames displayed from 16 → 9 → 4. While 4 frames are displayed, rotate the zoom control to T (🕒) again to return to full-frame display mode.	–
Switch to full-frame playback	OK (Ⓞ)	Press OK .	26
Switch to shooting mode		Press	10

Thumbnail Playback Mode Display

While pictures selected for **Print set** (📖 70) and **Protect** (📖 106) are chosen, the icons shown at right are displayed with them. Movies are displayed as film frames.

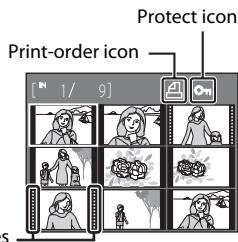

Calendar Display

Rotate the zoom control to **W** (📷) when the pictures are displayed in 16-thumbnail (📖 48) in playback mode to switch to calendar display.

You can select images to view based on the day they were taken. Days containing pictures have a yellow line under them.

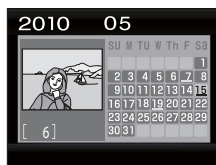

The following operations are available in calendar display.

To	Use	Description	📖
Choose date		Press the multi selector ▲, ▼, ◀ or ▶.	11
Switch to full-frame playback		The first picture for that date will be displayed full-frame.	26
Switch to thumbnail display	T (📷)	Rotate the zoom control to T (📷).	–

☑ Calendar display

- Pictures taken when the camera's date is not set are treated as pictures taken on January 1, 2010.
- The 🗑 and MENU buttons are not available during calendar display.

Taking a Closer Look: Playback Zoom

Rotating the zoom control to **T** (Q) during full-frame playback mode (📖 26) zooms the current image, with the center of the picture displayed in the monitor.

- The guide displayed in the right bottom in the monitor will show which part of the image is currently displayed.



The following operations can be performed while pictures are zoomed in.

To	Use	Description	📖
Zoom in	T (Q)	Rotate the zoom control to T (Q). Images can be magnified by up to 10x.	-
Zoom out	W (📐)	Rotate the zoom control to W (📐). When the magnification ratio reaches 1x, the display returns to full-frame playback mode.	-
View other areas of picture		Press the multi selector ▲ , ▼ , ◀ or ▶ to scroll to areas of the picture not visible in the monitor.	11
Switch to full-frame playback	OK	Press OK .	26
Crop picture	MENU	Press MENU to crop current picture to contain only the portion visible in the monitor.	54
Switch to shooting mode		Press .	10

Pictures taken using face detection

When the zoom control is rotated to **T** (Q) during full-frame playback mode, pictures taken using face detection (📖 24) are magnified using the face that was focused on at the time of shooting as the centralized point.

- If several faces are recognized, the picture will be enlarged using the face which was focused on during shooting time as the centralized point, and pressing the multi selector **▲**, **▼**, **◀** or **▶** will enable you to switch between the people's faces.
- Rotating the zoom control to **T** (Q) or **W** (📐) further can change the magnification ratio and the pictures will be zoomed in as usual.



Editing Pictures

The editing features described below are available. Use the camera to edit pictures in-camera and store them as separate files (📖 111).

Editing function	Description
D-Lighting (📖 52)	Create a copy of the current picture with enhanced brightness and contrast, brightening dark portions of the picture.
Small picture (📖 53)	Create a small copy of pictures suitable for use on web pages or as e-mail attachments.
Crop (📖 54)	Enlarge the image or refine the composition and create a copy containing only the portion visible in the monitor.

✔ Notes on In-camera Editing

- Pictures taken at an **Image mode** setting (📖 74) of 📷 3968×2232 on L22 and 📷 3200×1800 on L21 cannot be edited.
- Only pictures taken with the COOLPIX L22/COOLPIX L21 can be edited with this camera.
- When using a different model of digital camera, pictures edited with this camera may not be displayed properly and may not be able to be transferred to a computer.
- Editing functions are not available when there is not enough free space in the internal memory or on the memory card.

✍ Restrictions on Picture Editing

The following limitations apply when editing pictures that were created by editing.

Copies Created By:	Can Be Edited By:
D-Lighting	Small picture and crop can be used.
Small picture Crop	Additional editing is not possible.

- Copies created by the editing functions cannot be edited again using the same edit function.
- To use D-Lighting together with small picture or crop, use the D-Lighting first.

📷 Original Pictures and Edited Copies

- Copies created with editing functions are not deleted if the original pictures are deleted. The original pictures are not deleted if copies created with editing functions are deleted.
- Edited copies are stored with the same recording date and time as the original.
- Print set (📖 70) and Protect (📖 106) settings configured for original pictures are not reflected in their edited copies.

Enhancing Brightness and Contrast: D-Lighting

Create a copy of the current image with enhanced brightness and contrast, brightening dark portions of the picture. Enhanced copies are saved as separate files.

- 1 Select the desired picture from full-frame (📖 26) or thumbnail (📖 48) playback mode and press **MENU**.

The playback menu will be shown.

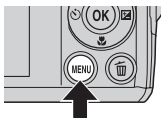

- 2 Use the multi selector to choose **D-Lighting** and press **OK**.

The original version will be shown on the left and the edited version will be shown on the right.

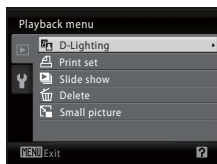

- 3 Choose **OK** and press **OK**.

A new copy with enhanced brightness and contrast is created.

To cancel, select **Cancel** and press **OK**.

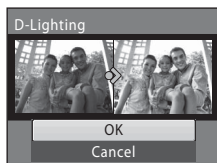

D-Lighting copies can be recognized by the  icon displayed during playback.



More Information

See, "Image File and Folder Names" (📖 111) for more information.

Resizing Pictures: Small Picture

Create a small copy of the current picture. Suitable for uploading to web sites or sending by e-mail. The following sizes are available:  **640×480**,  **320×240**, and  **160×120**.

Small copies are saved as JPEG files with a compression ratio of 1:16.

- 1 Select the desired picture from full-frame (📖 26) or thumbnail (📖 48) playback mode and press **MENU**.

The playback menu will be shown.

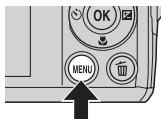

- 2 Use the multi selector to choose  **Small picture** and press **OK**.

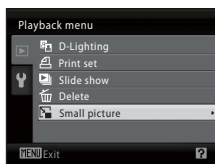

- 3 Choose the desired copy size and press **OK**.

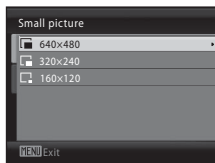

- 4 Choose **Yes** and press **OK**.

A new, smaller copy is created.

To cancel, select **No** and press **OK**.

The copy is displayed with a gray frame.

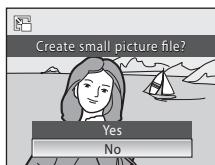

More Information

See, "Image File and Folder Names" (📖 111) for more information.

Creating a Cropped Copy: Crop

This function is only available when **MENU**  is displayed in the monitor with playback zoom ( 50) enabled. Cropped copies are saved as separate files.

1 Rotate the zoom control to **T** () in full-frame playback mode to zoom in on the image.

- To crop a picture displayed in “tall” (portrait) orientation, zoom in on the picture until the black bars displayed on the both sides of the monitor disappear. The cropped picture will be displayed in landscape orientation. If you want to crop the portrait image in the captured position, use **Rotate Image** ( 107) to change the position of the portrait image to landscape before cropping it, and then return the image to the captured position.

COOLPIX L22

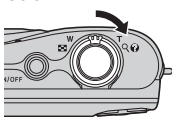

COOLPIX L21

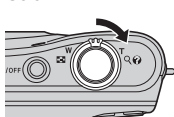

2 Refine copy composition.

Rotate the zoom control to **T** () or **W** () to adjust the zoom ratio.

Press the multi selector , , , or  to scroll the picture until only the portion you want to copy is visible in the monitor.

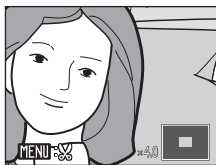

3 Press **MENU**.

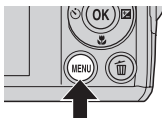



4 Use the multi selector to select **Yes** and press .

A new picture, containing only the portion visible in the monitor, is created.

To cancel, select **No** and press .



About the size of the original image





The smaller the cropped area of the image, the smaller of the cropped image size (number of pixels). When the image is cropped and the size of the cropped copy is 320 × 240 or 160 × 120, the image is displayed with a gray border on the playback screen, and the small picture icon  or  is displayed on the left of the playback screen.

More Information

See, “Image File and Folder Names” ( 111) for more information.

Recording Movies

To shoot movies with sound recorded via the built-in microphone, select shooting mode and follow the steps below.

- 1 Press  in shooting mode to display the shooting-mode selection menu and use the multi-selector  and  to select , then press .

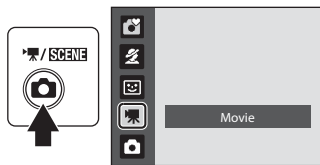

The maximum length of the movie that can be recorded is displayed in the monitor ( 56). Regardless of the remaining memory on the memory card, the maximum size of a single movie is 2 GB, and the maximum length of a single movie is 29 minutes.

- 2 Press the shutter-release button all the way down to start recording.

Camera focuses on subject in center of frame.

A progress bar at the bottom of the monitor shows the amount of recording time remaining.

To end recording, press the shutter-release button all the way down a second time.

If recording time runs out, recording stops automatically.

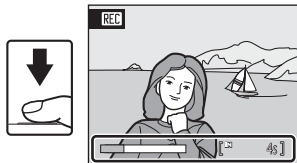

Recording Movies



- The camera focuses when the shutter-release button is pressed halfway, and the focus remains locked while the shutter-release button is pressed halfway. Focus is locked while recording.
- Optical zoom cannot be applied while movies are recorded. Digital zoom cannot be used just before recording a movie, but up to 2x digital zoom can be applied while movies are recorded.
- Smear ( 115) visible in the monitor when shooting movies is visible in the saved movie file. Avoiding bright objects such as the sun, reflections of the sun, and electric lights is recommended to avoid smear effects.

While the Camera is Saving Movies

When movie recording stops, the shooting screen is displayed after the movie has been completely saved. Do not open the battery-chamber / memory card slot cover.

Removing the memory card or the battery while a movie is being saved may result in loss of the movie data or damage to the camera or the memory card.



Options Available When Shooting Movies

- Macro mode ( 33) can be used. Apply or change settings as necessary before movie recording begins. Settings cannot be changed while recording a movie. Flash, self-timer, and exposure compensation cannot be used.
- Press **MENU** to display the  (movie) menu and set **Movie options** ( 56).

The Movie Menu

Movie options setting can be changed from the movie menu.

Displaying the Movie Menu

Press  in shooting mode to display the shooting-mode selection menu and set the shooting menu to  (movie) mode (📖 55).

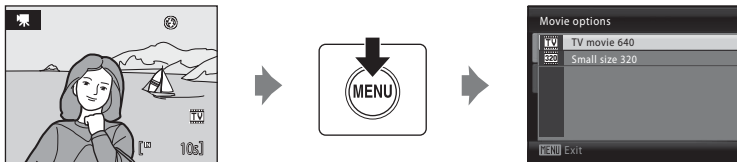

Press **MENU** to display the movie menu.





- Use the multi selector to choose and apply settings (📖 11).
- To exit the menu, press **MENU**.

Selecting Movie Options

The movie menu offers the options shown below.

Option	Resolution and Frame Rate
 TV movie 640 (default setting)	Resolution: 640×480 Frame rate: About 30 frames per second
 Small size 320	Resolution: 320×240 Frame rate: About 30 frames per second

Movie Options and Maximum Movie Length

Option	Internal memory (Approx. 19 MB)	Memory card (4 GB)*
 TV movie 640 (default setting)	10 s	40 min
 Small size 320	42 s	2 h 45 min

All figures are approximate. Maximum movie length or frames varies with make of memory card.

* Regardless of the remaining memory on the memory card, the maximum size of a single movie is 2 GB, and the maximum length of a single movie is 29 minutes. The maximum recording time that is displayed is the maximum recording time for one movie.

More Information

See, "Image File and Folder Names" (📖 111) for more information.

Movie Playback

In full-frame playback mode (📖 26), movies are recognized by the Movie options icon (📖 56). To play a movie, display it in full-frame playback mode and press **OK**.



Use the zoom control **T/W** to adjust playback volume. Playback controls appear at the top of the monitor. Press the multi selector **◀** or **▶** to choose a control, then press **OK** to perform the selected operation. The following operations are available.

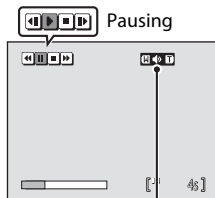

During playback Volume indicator

To	Press	Description
Rewind	⏮	Rewind movie. Playback resumes when OK is released.
Advance	⏭	Advance movie. Playback resumes when OK is released.
Pause	⏸	Pause playback. The following operations can be performed while playback is paused.
		⏮ Rewind movie by one frame. Rewind continues while OK is pressed.
		⏭ Advance movie by one frame. Advance continues while OK is pressed.
	▶	Resume playback
End	⏹	End playback and return to full-frame playback.

Deleting Movie Files

Press **🗑** when displayed in full-frame playback mode (📖 26), or when selected in thumbnail (📖 48) playback mode. A confirmation dialog is displayed. Choose **Yes** and press **OK** to delete the movie, or choose **No** and press **OK** to return to the normal playback display without deleting the movie.



Connecting to a TV

Connect the camera to a television using an optional audio video cable (AV cable) (📖 110) to play back pictures on a television.

1 Turn off the camera.

COOLPIX L22

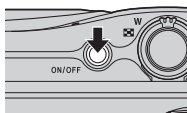

COOLPIX L21

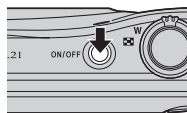

2 Connect the camera to the TV using the supplied audio video cable.

Connect the yellow plug to the video-in jack on the TV, and the white plug to the audio-in jack.

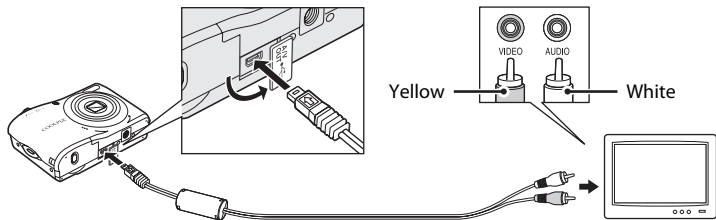

3 Tune the television to the video channel.

See the documentation provided with your television for details.

4 Hold down to turn on the camera.

The camera enters playback mode, and the pictures taken will be displayed on the television.

While connected to the TV, the camera monitor will remain off.



✔ Connecting an AV Cable

When connecting the AV cable, be sure that the camera connector is oriented correctly. Do not use force when connecting the AV cable to the camera. When disconnecting the AV cable, do not pull the connector at an angle.

✔ Video Mode

Be sure that the camera's video mode setting conforms to the standard used by your television. The video mode setting is an option set in the **Set up** menu (📖 85) > **Video mode** (📖 101).

Connecting to a Computer

Use the supplied USB cable to connect the camera to a computer, and copy (transfer) pictures to a computer with the supplied Nikon Transfer software.

Before Connecting the Camera

Install the Software

Before connecting the camera to a computer, software, including Nikon Transfer, ViewNX for displaying transferred pictures, and Panorama Maker for creating panorama photos, must be installed using the supplied Software Suite CD. For more information on installing the software, refer to the *Quick Start Guide*.

Compatible Operating Systems

Windows

- Windows 7 (Home Basic/Home Premium/Professional/Enterprise/Ultimate editions)
- Windows Vista Service Pack 2 (Home Basic/Home Premium/Business/Enterprise/Ultimate editions)
- 32-bit versions of Windows XP Service Pack 3 (Home Edition/Professional)

Macintosh

Mac OS X (version 10.4.11, 10.5.8, 10.6)

Refer to the Nikon website for the latest information on operating system compatibility.

Note on Power Source

When connecting the camera to a computer, use fully charged batteries to prevent the camera from turning off unexpectedly.

If the AC Adapter EH-65A (☞ 110) (available separately) is used, COOLPIX L22/L21 can be powered from an electrical outlet. Do not use any other make or model of AC adapter as they may cause the camera to overheat or malfunction.

Transferring Pictures from a Camera to a Computer

- 1 Start the computer to which Nikon Transfer was installed.
- 2 Be sure that the camera is off.
- 3 Connect the camera to the computer using the supplied USB cable.

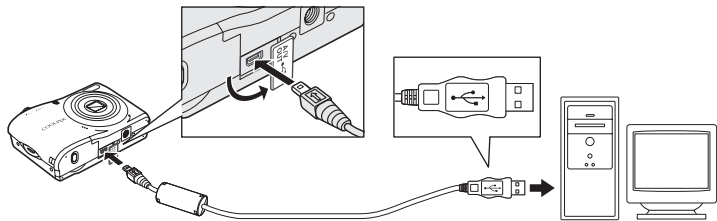

- 4 Turn on the camera.
The power-on lamp will light. The camera monitor will remain off.

COOLPIX L22

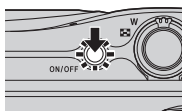

COOLPIX L21

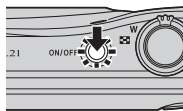

Connecting the USB Cable

- Be sure that connectors are properly oriented. Do not attempt to insert connectors at an angle, and do not use force when connecting or disconnecting the USB cable.
- The connection may not be recognized if the camera is connected to the computer via a USB hub.

5 Start Nikon Transfer installed on the computer.

• Windows 7

When the **Devices and Printers** ► **L22/L21** screen is displayed, click **Change program** under **Import pictures and videos**. Select **Copy pictures to a folder on my computer** in the **Change program** dialog and click **OK**.

Double-click **Copy pictures to a folder on my computer** on the **Devices and Printers** ► **L22/L21** screen.

• Windows Vista

When the **AutoPlay** dialog is displayed, click **Copy pictures to a folder on my computer using Nikon Transfer**.

• Windows XP

When the action selection dialog is displayed, select **Nikon Transfer Copy pictures to a folder on my computer**, and click **OK**.

• Mac OS X

Nikon Transfer will start automatically when the camera is connected to the computer if **Yes** was selected in the Auto-Launch setting dialog when Nikon Transfer was first installed.

- If there are a large number of images on the memory card, it may take some time for Nikon Transfer to start.

6 Confirm that the source device is displayed in the transfer options **Source** panel and click **Start Transfer**.

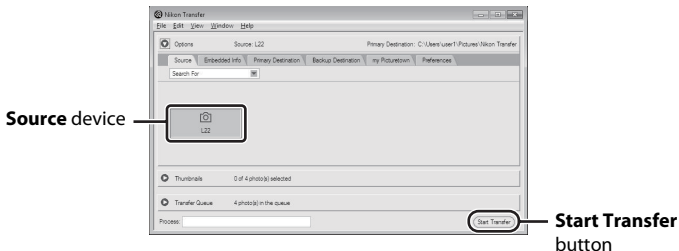

At the Nikon Transfer default settings, all pictures are transferred to the computer.

Connecting to a Computer

At the Nikon Transfer default settings, ViewNX starts automatically when transfer is complete and transferred pictures can be viewed.

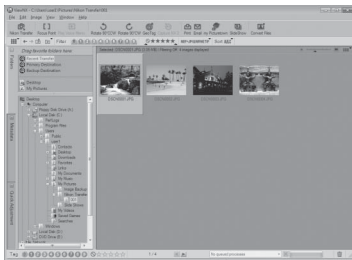

For more information on using Nikon Transfer or ViewNX, refer to help information contained in Nikon Transfer or ViewNX (📖 62).

Disconnecting the camera

Do not turn off the camera or disconnect the camera from the computer during transfer.

When transfer is complete, turn off the camera and disconnect the USB cable.

Using a Card Reader

The pictures stored on the memory card inserted into a card reader or similar device can also be transferred to the computer using Nikon Transfer.

- If the memory card capacity is 2 GB or more, or if the memory card is SDHC-compliant, the card reader or similar device must support these memory card specifications.
- Insert a memory card into the card reader or similar device, and refer to the steps 5 and 6 (📖 61) to transfer pictures.
- To transfer pictures stored in the camera's internal memory to the computer, the pictures must first be copied to a memory card using the camera (📖 108).

Starting Nikon Transfer or ViewNX Manually

Windows

Choose **Start menu>All Programs>Nikon Transfer>Nikon Transfer** (or **All Programs>ViewNX>ViewNX**).

Double-clicking the Nikon Transfer or ViewNX shortcut icon on the desktop will also start Nikon Transfer or ViewNX.

Macintosh

Open **Applications** and double-click **Nikon Software>Nikon Transfer>Nikon Transfer** (or **Nikon Software>ViewNX>ViewNX**).

Clicking the Nikon Transfer or ViewNX icon on the Dock will also start Nikon Transfer or ViewNX.

Viewing Nikon Transfer and ViewNX Help Information

For more information on Nikon Transfer or ViewNX, start Nikon Transfer or ViewNX and select **Nikon Transfer Help** or **ViewNX Help** from the **Help** menu.

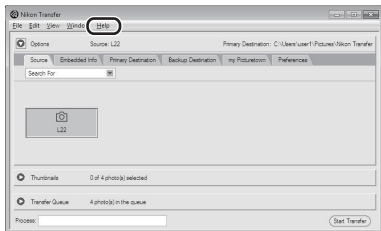

Panorama Creation with Panorama Maker

- Use a series of pictures taken in **Panorama assist** scene mode ( 42) to create a single panorama photo with Panorama Maker.
- Panorama Maker can be installed on a computer using the supplied Software Suite CD.
- After installation is complete, follow the procedure described below to start Panorama Maker.

Windows

Choose **Start menu>All Programs>ArcSoft Panorama Maker 5>Panorama Maker 5**.

Macintosh

Open **Applications** and double-click the **Panorama Maker 5** icon.

- For more information on using Panorama Maker, refer to the on-screen instructions and help information contained in Panorama Maker.

Image File Names and Folder Names

See "Image File and Folder Names" ( 111) for more information.

Connecting to a Printer

Users of PictBridge-compatible (📖 128) printers can connect the camera directly to the printer and print pictures without using a computer.

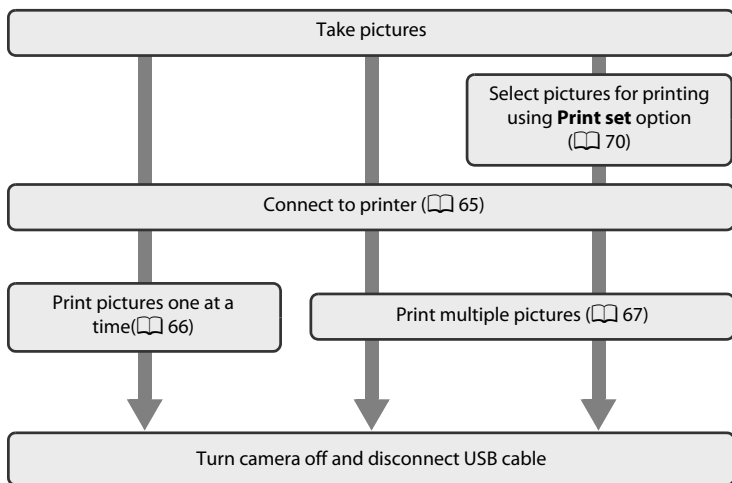

✔ Note on Power Source

When connecting the camera to a printer, use a fully charged batteries to prevent the camera from turning off unexpectedly.

To power the camera continuously for extended periods, use an AC Adapter EH-65A (available separately) (📖 110). Do not, under any circumstances, use another make or model of AC adapter. Failure to observe this precaution could result in overheating or in damage to the camera.

🔍 Printing Pictures

In addition to printing pictures transferred to a computer from your personal printer and printing over a direct camera-to-printer connection, the following options are also available for printing pictures:

- Insert a memory card into a DPOF-compatible printer's card slot
- Take a memory card to a digital photo lab

For printing using these methods, you can specify the pictures and the number of prints each using **Print set** in the playback menu (📖 70).

Connecting the Camera and Printer

- 1** Turn off the camera.

COOLPIX L22

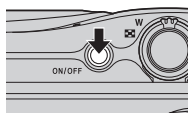

COOLPIX L21

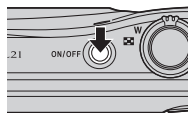

- 2** Turn on the printer.

Check printer settings.

- 3** Connect the camera to the printer using the supplied USB cable.

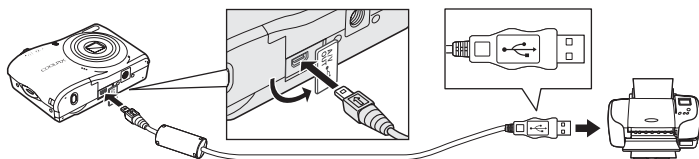

- 4** Turn on the camera.

- When connected correctly, the **PictBridge** startup screen (①) is displayed in the camera monitor, then the **Print selection** screen (②) is displayed.

COOLPIX L22

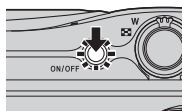

COOLPIX L21

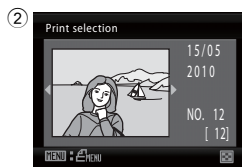
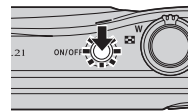

✓ Connecting the Audio Video/USB Cable

When connecting the USB cable, be sure that the connectors are oriented correctly. Do not use force when connecting the USB cable. When disconnecting the USB cable, do not pull the connector at an angle.

Printing Pictures One at a Time

After connecting the camera to the printer correctly (📖 65), print pictures by following the procedure below.

1 Use the multi selector to choose the desired picture and press **OK**.

- Rotate the zoom control to **W** (🖼️) to display 12 thumbnails, and to **T** (🔍) to switch back to full-frame playback.

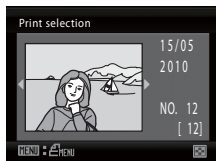

2 Choose **Copies** and press **OK**.

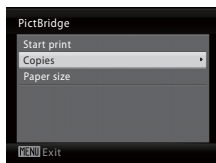

3 Choose the number of copies (up to nine) and press **OK**.

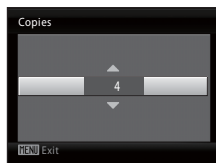

4 Choose **Paper size** and press **OK**.

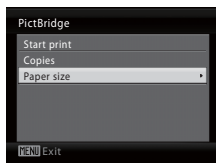

5 Choose the desired Paper size and press **OK**.

- To specify paper size using printer settings, choose **Default** in the paper size menu.

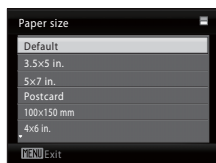

- 6** Choose **Start print** and press **OK**.

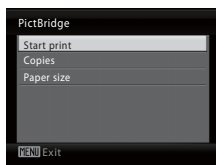

- 7** Printing starts.

Monitor display returns to that shown in step 1 when printing is complete.

To cancel before all copies have been printed, press **OK**.

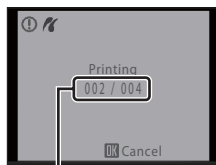

Current print/ total number of prints

Printing Multiple Pictures

After connecting the camera to the printer correctly (📖 65), print pictures by following the procedure below.

- 1** When the **print selection** screen is displayed, press **MENU**.

The **Print menu** is displayed.

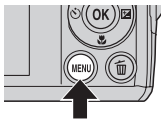

- 2** Use the multi selector to choose **Paper size** and press **OK**.

Press **MENU** to exit the print menu.

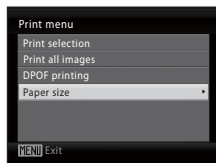

- 3** Choose the desired Paper size and press **OK**.

To specify paper size using printer settings, choose **Default** in the paper size menu.

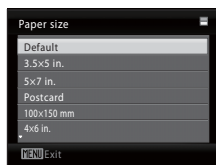

4 Choose **Print selection**, **Print all images** or **DPOF printing** and press **OK**.

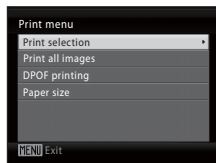

Print selection

Select the images (up to 99) and the number of copies (up to nine) of each image.

Press the multi selector ◀ or ▶ to select pictures, and press ▲ or ▼ to set the number of copies for each.

Pictures selected for printing can be recognized by the check mark ✓ and the numeral indicating the number of copies to be printed. Pictures for which no copies have been specified will not be printed.

Rotate the zoom control to **T** (Q) to switch to full-frame playback. Rotate the zoom control to **W** (R) to switch back to thumbnail display. Press **OK** when setting is complete.



When the menu shown on the right is displayed, select **Start print** and press **OK** to start printing. Choose **Cancel** and press **OK** to return to the print menu.

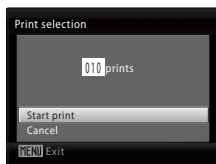

Print all images

All pictures stored in the internal memory, or on the memory card, are printed one at a time.

When the menu shown on the right is displayed, select **Start print** and press **OK** to start printing. Choose **Cancel** and press **OK** to return to the print menu.

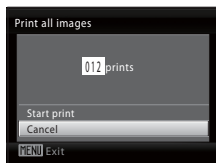

DPOF printing

Print pictures for which a print order was created in **Print set** (📖 70).

- When the menu shown on the right is displayed, select **Start print** and press **OK** to start printing. Choose **Cancel** and press **OK** to return to the print menu.
- To view the current print order, choose **View images** and press **OK**. To print pictures, press **OK** again.



5 Printing starts.

Monitor display returns to the print menu (step 2) when printing is complete.

To cancel before all copies have been printed, press **OK**.

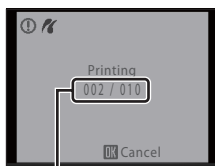

Current print/ total number of prints

Paper Size

The camera supports the following paper sizes: **Default** (the default paper size for the current printer), **3.5 × 5 in.**, **5 × 7 in.**, **100 × 150 mm**, **4 × 6 in.**, **8 × 10 in.**, **Letter**, **A3**, and **A4**. Only sizes supported by the current printer will be displayed. To specify paper size using printer settings, choose **Default** in the paper size menu.

Creating a DPOF Print Order: Print Set

Before printing images saved on a memory card using one of the methods listed below, you can create a digital “print order” that specifies which images should be printed and how many copies of each image should be printed, and save this information on the memory card.

- Printing with a DPOF-compatible (📖 128) printer that features a memory card slot.
- Printing using a digital photo lab that supports DPOF.
- Printing by connecting the camera (📖 64) to a PictBridge-compatible (📖 128) printer (If the memory card is removed from the camera, you can create the print order for images saved in the internal memory and print images according to the print order.)

1 Press **MENU** in playback mode.

The playback menu is displayed.

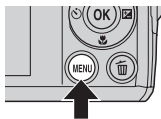

2 Use the multi selector to choose **Print set** and press **OK**.

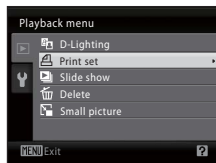

3 Choose **Select images** and press **OK**.

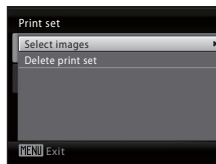

4 Choose the pictures (up to 99) and the number of copies (up to nine) for each.

Press the multi selector ◀ or ▶ to choose the desired pictures. Press ▲ or ▼ to set the number of copies for each. Pictures selected for printing can be recognized by the check mark and the numeral indicating the number of copies to be printed. Pictures for which no copies have been specified will not be printed.

Rotate the zoom control to **T** (📷) to switch to full-frame playback. Rotate the zoom control to **W** (🖼️) to switch back to thumbnail display.

Press **OK** when setting is complete.





5 Choose whether or not to also print shooting date and photo information.

Choose **Date** and press **OK** to print date of recording on all pictures in the print order.

Choose **Info** and press **OK** to print photo information (shutter speed and aperture) on all pictures in the print order.

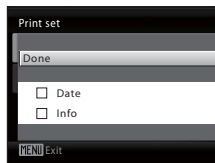
Choose **Done** and press **OK** to complete the print order and exit.



Pictures selected for printing are indicated by the  icon displayed during playback.

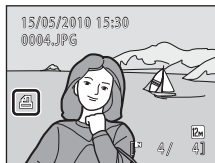

✓ Notes on Printing Shooting Date and Photo Information

- When the **Date** and **Info** options are enabled in the print set menu, shooting date and photo information are printed on pictures when a DPOF-compatible printer (📖 128) which supports printing of shooting date and photo information is used.
- Photo information cannot be printed when the camera is connected directly to a printer, via the supplied USB cable, for DPOF printing (📖 68).
- **Date** and **Info** are reset each time the **print set** menu is displayed.
- The date and time printed on pictures with DPOF printing when **Date** in the Print set menu is enabled, are those recorded with the picture when it was taken. Date and time printed using this option are not affected when the camera's date and time setting are changed from the setup menu after pictures are recorded.

✏ Deleting All Print Orders



Choose **Delete print set** in step 3 of the print set procedure and press **OK** to delete print orders for all pictures.





🕒 Date Imprint

The shooting date and time can be imprinted in pictures at the time of shooting by using **Date imprint** (📖 94) in the setup menu. This information can be printed even from printers that do not support printing of date and time (📖 71). Only the Date imprint date and time on pictures will be printed, even if **Print set** is enabled with date selected in the print set screen.

Shooting Options: The Shooting Menu



While shooting in  (auto) mode ( 29), the shooting menu contains the following options.

 **Image mode**  74



Choose image size and quality. Also available when using other shooting modes (except movie mode).

WB **White balance**  76

Match white balance to the light source.

 **Continuous**  78

Change settings to Continuous or BSS (best shot selector).



 **Color options**  79

Make colors more vivid or record pictures in monochrome.

Camera settings that cannot be applied at the same time

Some functions may not be set at the same time ( 80).

Displaying the Shooting Menu

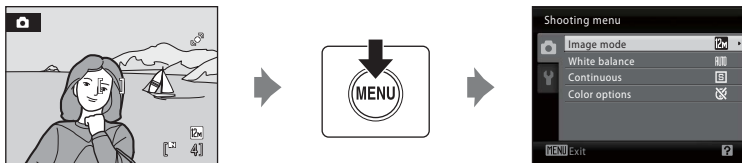

Press  in shooting mode to display the shooting-mode selection menu and set the shooting menu to  (auto) mode (📖 29).

Press **MENU** to display the shooting menu.













- Use the multi selector to choose and apply settings (📖 11).
- To exit the shooting menu, press **MENU**.

Image mode

Set  (Auto) mode (📖 29) → MENU (shooting menu) →  image mode

Pictures taken with a digital camera are recorded as image files. The size of the files, and with it the number of images that can be recorded, depends on the size and quality of the images. Before shooting, choose an image mode according to how you plan to use the picture.

Setting	Size (pixels)	Description
 4000×3000★ (L22 Only)	4000×3000	Highest quality; suitable for enlargements or high-quality prints. The compression ratio is approximately 1:4.
 3264×2448★ (L21 Only)	3264×2448	
 4000×3000* (L22 Only)	4000×3000	Best choice in most situations. The compression ratio is approximately 1:8.
 3264×2448*	3264×2448	
 2592×1944	2592×1944	
 2048×1536	2048×1536	Smaller size allows more pictures to be saved. The compression ratio is approximately 1:8.
 1024×768	1024×768	Suited to display on a computer monitor. The compression ratio is approximately 1:8.
 640×480	640×480	Suited to full-screen display on a 4:3 television, or distribution by e-mail or the web. The compression ratio is approximately 1:8.
 3968×2232 (L22 Only)	3968×2232	Pictures with an aspect ratio of 16:9 can be taken. The compression ratio is approximately 1:8.
 3200×1800 (L21 Only)	3200×1800	

*  **4000×3000** is the default setting for L22.  **3264×2448** is the default setting for L21.











The icon for the current setting is displayed in the monitor in shooting and playback modes (📖 8, 9).

Image mode

- If the image mode setting is changed, the new image mode setting is also applied to other shooting modes (except movie mode).
- This feature cannot be used simultaneously with certain features. → “Camera Settings that Cannot Be Set at the Same Time” (📖 80).

Number of Exposures Remaining

The following table lists the approximate number of pictures that can be stored in internal memory and on a 4 GB memory card. Note that the number of pictures that can be stored will differ depending on the composition of the picture (due to JPEG compression). In addition, this number may differ depending on the make of memory card, even if the capacity for the memory card is the same.

Image mode	Internal memory (Approx. 19 MB)	Memory card ^{*1} (4 GB)	Print size (printed at 300 dpi; cm/in.) ^{*2}
 4000×3000 ★ (L22 Only)	2	500	34 × 25/13.4 × 9.8
 3264×2448 ★ (L21 Only)	3	760	28 × 21/11 × 8.3
 4000×3000 (L22 Only)	4	1010	34 × 25/13.4 × 9.8
 3264×2448	6	1520	28 × 21/11 × 8.3
 2592×1944	10	2410	22 × 16/8.7 × 6.3
 2048×1536	16	3860	17 × 13/6.7 × 5.1
 1024×768	46	11000	9 × 7/3.5 × 2.8
 640×480	75	17700	5 × 4/2 × 1.6
 3968×2232 (L22 Only)	5	1370	34 × 19/13.4 × 7.5
 3200×1800 (L21 Only)	8	2110	27 × 15/10.6 × 5.9

^{*1} If the number of exposures remaining is 10,000 or more, the number of exposures remaining display shows **9999**.

^{*2} When the printer resolution is set to 300 dpi.

Print sizes are calculated by dividing the number of pixels by printer resolution (dpi) and multiplying by 2.54 cm (1 in.). However, at the same image size, pictures printed at higher resolutions will print smaller than the size indicated, and those printed at lower resolutions will print larger than the size indicated.

WB White Balance

Set  (Auto) mode (📖 29) → MENU (shooting menu) → WB White Balance

The color of light reflected from an object varies with the color of the light source. The human brain is able to adapt to changes in the color of the light source, with the result that white objects appear white whether seen in the shade, direct sunlight, or under incandescent lighting. Digital cameras can mimic this adjustment by processing images according to the color of the light source. This is known as “white balance”.

Although the default setting, **Auto** can be used under most types of lighting, you can apply the white balance setting suited to a particular light source to achieve more accurate results.

AUTO Auto (default setting)

White balance automatically adjusted to suit lighting conditions. Best choice in most situations.

PRE Preset manual

Neutral-colored object used as reference to set white balance under unusual lighting conditions. Please refer to “Preset Manual” for more information (📖 77).

Daylight

White balance adjusted for direct sunlight.

Incandescent

Use under incandescent lighting.

Fluorescent

Use under most types of fluorescent lighting.

Cloudy

Use when taking pictures under overcast skies.

Flash

Use with the flash mode.

The effects of the selected option can be previewed in the monitor. At settings other than **Auto**, the icon for the current setting is displayed on the monitor (📖 8).

White Balance

- This feature cannot be used simultaneously with certain features. → “Camera Settings that Cannot Be Set at the Same Time” (📖 80)
- At white-balance settings other than **Auto** or **Flash**, turn the flash off (🔇) (📖 30).

Preset Manual

Preset manual is used with mixed lighting or to compensate for light sources with a strong color cast (for example, to make pictures taken under a lamp with a red shade look as though they had been taken under white light).

1 Place a white or gray reference object under the lighting that will be used during shooting.

2 Display the shooting menu (📖 73), use the multi selector to set **White balance** to **PRE Preset manual**, then press **OK**.

The camera zooms in.

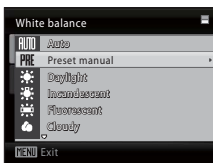

3 Choose **Measure**.

To apply the most recently measured value for preset manual, choose **Cancel** and press **OK**.

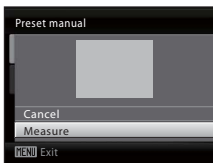

4 Frame the reference object.

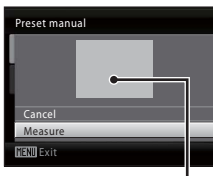

Reference object frame



5 Press **OK**.

The shutter is released and the new white balance value is set (no picture is recorded).

✔ Note on Preset Manual

The camera cannot measure a white balance value for when the flash fires. When shooting with the flash, set **White balance** to **Auto** or **Flash**.

Continuous

Set  (Auto) mode (📖 29) → MENU (shooting menu) →  Continuous

Change settings to Continuous or BSS (best shot selector).

Flash will be switched off for **Continuous**, **BSS** or **Multi-shot 16**, and focus, exposure and white balance are fixed at the values for the first picture in each series.

Single (default setting)

One shot is taken each time shutter-release button is pressed.

Continuous

While the shutter-release button is held down, the L22 shoots up to 5 frames at 0.9 frames per second (fps), and the L21 shoots up to 5 frames at 1 fps (when image mode is set to  **4000×3000** for L22 and  **3264×2448** for L21).

BSS (Best Shot Selector)

The “best shot selector” is recommended when shooting with the flash off or the camera zoomed in, or in other situations in which inadvertent motion can result in blurred pictures.

When BSS is on, the camera takes up to 10 pictures while the shutter-release button is held down. The sharpest picture in the series is automatically selected and saved.

Multi-shot 16

Each time the shutter-release button is pressed all the way down, 16 pictures are shot at about 24 frames per second (fps) and the camera arranges them in a single picture. Images are captured with the image mode fixed at  (image size is 2560×1920). Digital zoom cannot be applied.

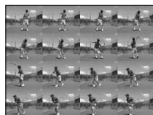

The icon for the current setting is displayed in the monitor when the camera is in shooting mode (📖 8). No icon is displayed when **Single** is selected.

Note on Continuous Shooting

- The maximum frame rate with continuous shooting may vary, depending upon the current image mode setting, the memory card used, and shooting conditions.
- This feature cannot be used simultaneously with certain features. → “Camera Settings that Cannot Be Set at the Same Time” (📖 80)

Note on BSS

BSS is best suited to situations where the subject is not moving. **BSS** may not produce the desired results if the subject moves or if the composition is changed while the shutter-release button is pressed all the way down.





✔ Note on Multi-shot 16

Smear (📖 115) visible in the monitor when shooting with **Multi-shot 16** is visible in the saved image. Avoiding bright objects such as the sun, reflections of the sun, and electric lights is recommended to avoid smear effects.

🔧 Color Options

Set 📷 (Auto) mode (📖 29) → MENU (shooting menu) → 🔧 Color Options

Make colors more vivid or record pictures in monochrome.

-  **Standard color (default setting)**
Use for pictures exhibiting natural color.
-  **Vivid color**
Use to achieve a vivid, “photoprint” effect.
-  **Black-and-white**
Record pictures in black-and-white.
-  **Sepia**
Record pictures in sepia tones.
-  **Cyanotype**
Record pictures in cyan-blue monochrome.

The icon for the current setting is displayed in the monitor when the camera is in shooting mode (📖 8). No icon is displayed when **Standard color** is selected. The effects of the current setting can be previewed in the monitor.

✔ Notes on Color Options

This feature cannot be used simultaneously with certain features. → “Camera Settings that Cannot Be Set at the Same Time” (📖 80)





Camera Settings that Cannot Be Set at the Same Time

Certain settings in the shooting menu cannot be used with other functions.

Restricted Functions	Setting	Description
Flash mode	Continuous (📖 78)	If set to Continuous , BSS , or Multi-shot 16 , the flash cannot be used.
Digital zoom	Continuous (📖 78)	When using Multi-shot 16 , the digital zoom cannot be used.
Image mode	Continuous (📖 78)	When using Multi-shot 16 , Image mode is fixed at 5M (image size is 2560×1920).
Continuous	Self-timer (📖 32)	When using the self-timer, the setting is fixed at Single .
White balance	Color options (📖 79)	When using Black-and-white , Sepia , or Cyanotype , the White balance setting is fixed at Auto .
Motion detection	Continuous (📖 78)	When Multi-shot 16 is selected, Motion detection is not enabled.

Playback Options: The Playback Menu

The following functions are available in playback mode.

	D-Lighting 52
Enhances brightness and contrast in dark portions of pictures.	
	Print set 70
Select pictures to print and the number of copies for each.	
	Slide show 83
View pictures stored in the internal memory or on a memory card in an automatic slide show.	
	Delete 84
Delete pictures. Multiple pictures can be deleted with one operation.	
	Small picture 53
Create a small copy of the current picture.	

Displaying the Playback Menu

Press  to enter playback mode (26).

Display the playback menu by pressing **MENU**.

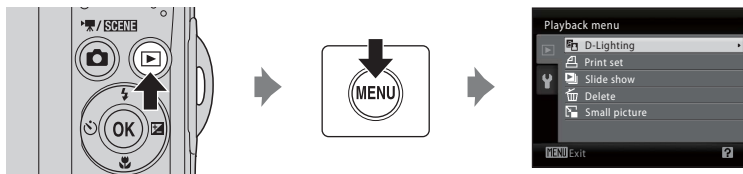

- Use the multi selector to choose and apply settings (11).
- To exit the playback menu, press **MENU**.

Selecting Multiple Pictures

The screen shown at right will be displayed in the menus (shown below) when choosing pictures.

Playback menu: Print set: **Select images** (📖 70)

Delete: **Erase selected images**
(📖 84)

Setup menu: Welcome screen: **Select an image**
(📖 88)

Protect (📖 106)

Rotate image (📖 107)

Copy: **Selected images** (📖 108)

Follow the procedure described below to choose the pictures.



- 1 Press the multi selector ◀ or ▶ to choose the desired picture.

Only one picture can be selected for **Rotate image** and **Welcome screen**. Proceed to step 3.

Rotate the zoom control to **T** (🔍) to switch to full-frame playback. Rotate the zoom control to **W** (📐) to switch back to thumbnail display.





- 2 Press ▲ or ▼ to select **ON** or **OFF** (or the number of copies).

When **ON** is selected, a check mark (☑) is displayed in the top left corner of the current picture. Repeat steps 1 and 2 to select additional pictures.



- 3 To fix the selection of pictures, press (OK).

Slide Show

Press  (playback mode) → MENU (playback menu) →  Slide show

View pictures stored in the internal memory or on a memory card in an automatic slide show.



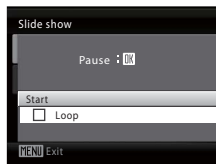

1 Use the multi selector to choose **Start** and press **OK**.

To repeat the slide show automatically, enable **Loop** and press **OK** before choosing **Start**. The check mark (✓) will be added to the loop option when enabled.



2 The slide show begins.

While the slide show is in progress, the following operations can be performed:

- During playback, press the multi selector  to display the next image and  to display the previous image (press and hold  or  to fast-forward or rewind, respectively).
- Press **OK** to pause the slide show.



3 Choose **End** or **Restart**.

When the slide show ends or is paused, choose **End** and press **OK** to return to the playback menu, or choose **Restart** to play the slide show again.

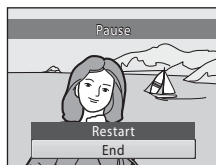

Notes on Slide Show

- Only the first frame of movies (📖 57) included in slide shows is displayed.
- Even if **Loop** is selected, the monitor can continuously display the Slide Show for up to 30 minutes (📖 99).

Delete

Press  (playback mode) → MENU (playback menu) →  Delete

Delete selected pictures or all pictures.



Erase selected images

Delete selected pictures. → “Selecting Multiple Pictures” ( 82)

Erase all images































Delete all pictures.





Notes on Deletion

- Once deleted, pictures cannot be recovered. Transfer important images to a computer before deletion.
- Pictures marked with the  icon are protected and cannot be deleted ( 106).

Basic Camera Setup: The Setup Menu

The setup menu contains the following settings.

	Menus  87
	Select the method for displaying menus.
	Welcome screen  88
	Specify the welcome screen displayed when the camera is turned on.
	Date  89
	Set camera clock and choose home and destination time zones.
	Monitor settings  92
	Choose whether or not to display information in the monitor, whether or not pictures are shown on the display for review after taking them, and set the monitor brightness.
	Date imprint  94
	Imprint the shooting date and time on pictures.
	Electronic VR  95
	Specify the electronic vibration reduction setting for taking still pictures.
	Motion detection  96
	Set whether or not the camera automatically increases the shutter speed to reduce blurring when motion is detected while shooting still pictures.
	AF assist  97
	Enable or disable AF-assist illumination.
	Sound settings  98
	Adjust sound settings.
	Auto off  99
	Set time before camera enters standby mode to conserve power.
	Format memory/Format card  100
	Format internal memory or memory card.
	Language  101
	Choose the language used for camera monitor display.
	Video mode  101
	Adjust settings for connection to a television.
	Blink warning  102
	Set whether or not to detect human subjects with eyes closed when shooting pictures using face detection.
	Reset all  103
	Restore camera settings to their default values.

	Battery type 📖 105
	Select the type of batteries used.
	Protect 📖 106
	Protect selected pictures from accidental deletion.
	Rotate image 📖 107
	Change the orientation of a picture.
	Copy 📖 108
	Copy files between memory card and internal memory.
Ver	Firmware version 📖 109
	Display camera firmware version.

Displaying the Setup Menu

Display the menu screen and select  (Setup).

- 1 Press **MENU** to display the menu screen.

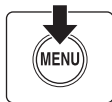

When using easy auto mode, scene mode, smart portrait mode, or movie mode, press  on the multi selector (📖 11) to display the tab.

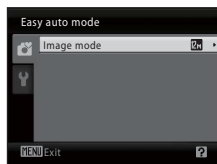

- 2 Press the multi selector  to enter the menu.

You can now select a tab.

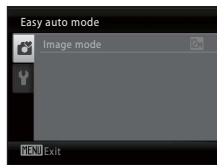

- 3 Press  or  to select the .

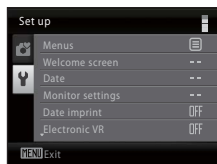

4 Press **▶** or **OK**.

- You can now select an item from the setup menu.
- Use the multi selector to choose and apply settings (📖 11).
- To exit the setup menu, press the **MENU** or press **◀** and select another tab.

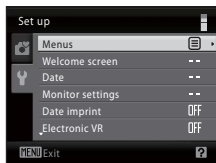

MENU Menus

Press **MENU** → **Y** (setup menu) (📖 86) → **MENU** Menus

Select the method for displaying menus.

Text (default setting)

Menus are displayed in list format.

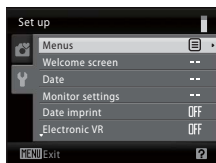



Icons

All menu items can be displayed in a single page.

Menu names



Welcome Screen

Press **MENU** →  (setup menu) ( 86) →  Welcome screen

Specify the welcome screen displayed when the camera is turned on.

None (default setting)

The welcome screen is not displayed when the camera is turned on; the shooting mode or playback mode screen is displayed.





COOLPIX

The welcome screen is displayed when the camera is turned on, then the shooting mode or playback mode screen is displayed.

Select an image

An image captured with this camera is used as the welcome screen.

When the image selection screen is displayed ( 82), select the desired image and press **OK** to register the image as the welcome screen.

- As the selected image is stored in the camera, the image will appear in the welcome screen even if the original picture is deleted.
- Pictures taken at an **Image mode** setting ( 74) of  **3968×2232** for L22 or  **3200×1800** for L21, as well as pictures that are 320×240 or smaller after being edited using small picture ( 53) or crop ( 54), cannot be used.

Date







Press **MENU** →  (setup menu) ( 86) →  Date

Set the camera clock.



Date

Set camera clock to current date and time.

Use the multi selector to set the date and time.

- Highlight an item (day, month, year, hour, minute, and the order in which day, month, and year are displayed): Press  or .
- Edit the highlighted item: Press  or .
- Finish setting: After selecting the order in which the day, month, and year are displayed, press  ( 16).

Time zone

Set the home () time zone (district) or daylight saving time. When the destination () time zone is selected, the time difference ( 91) is automatically calculated and the date and time in the selected region are recorded. Useful when travelling.

Setting Travel Destination Time Zone

- 1 Use the multi selector to choose **Time zone** and press .

The **Time zone** menu is displayed.

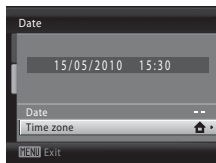

- 2 Choose  **Travel destination** and press .

The date and time displayed on the monitor changes according to the region currently selected.

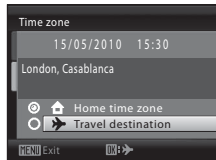

3 Press ►.

The new city time zone menu is displayed.

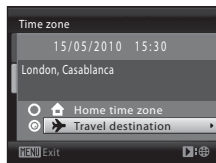

4 Press ◀ or ▶ to select the travel destination region (time zone).

When using the camera in an area where daylight saving time is in effect, press ▲ to adjust the camera's time for daylight saving time. ☀ will be displayed in the top of the monitor and the time will advance one hour. To turn off the daylight saving time setting, press ▼.

Press OK to enter the travel destination.

While the travel destination time zone is selected, the 📍 icon will be displayed in the monitor when the camera is in shooting mode.



✓ The Clock Battery

The camera's clock is powered by a clock battery that is independent of the batteries that powers the camera. The clock battery charges when the main batteries are installed or an AC adapter is connected, and can provide several days of backup power after about ten hours of charging.

📍 (Home Time Zone)

- To switch to the home time zone, choose 🏠 in step 2 and press OK.
- To change the home time zone, choose 🏠 in step 2 and perform steps 3 and 4, to set the home time zone.

🕒 Daylight Saving Time

When the summer saving time begins or ends, turn the daylight saving time option on or off using the home time zone display in Step 4.

📅 Imprinting the date on pictures

After setting the date and time, set the **Date imprint** setting in the setup menu (📖 94). Once **Date imprint** is set, the shooting date and time can be imprinted on the image data when taking pictures.



 **Time Zones**

The camera supports the time zones listed below.

For time zones not listed below, set the camera's clock manually to local time using **Date** in the setup menu.

UTC +/-	Time zone	UTC +/-	Time zone
-11	Midway, Samoa	+1	Madrid, Paris, Berlin
-10	Hawaii, Tahiti	+2	Athens, Helsinki, Ankara
-9	Alaska, Anchorage	+3	Moscow, Nairobi, Riyadh, Kuwait, Manama
-8	PST (PDT): Los Angeles, Seattle, Vancouver	+4	Abu Dhabi, Dubai
-7	MST (MDT): Denver, Phoenix, La Paz	+5	Islamabad, Karachi
-6	CST (CDT): Chicago, Houston, Mexico City	+5.5	New Delhi
-5	EST (EDT): New York, Toronto, Lima	+6	Colombo, Dhaka
-4.5	Caracas	+7	Bangkok, Jakarta
-4	Manaus	+8	Beijing, Hong Kong, Singapore
-3	Buenos Aires, Sao Paulo	+9	Tokyo, Seoul
-2	Fernando de Noronha	+10	Sydney, Guam
-1	Azores	+11	New Caledonia
±0	London, Casablanca	+12	Auckland, Fiji

Monitor Settings

Press **MENU** →  (setup menu)  86 →  Monitor settings

The following settings are available.

Photo info

Choose information displayed in monitor during shooting and playback mode.
→  93

Image review

- **On** (default setting): Pictures are automatically displayed briefly immediately after shooting.
- **Off**: Pictures are not displayed after shooting.







Brightness

Choose from five settings for monitor brightness. The default setting is **3**.

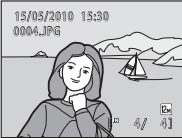
Photo Info

Select whether or not photo info is displayed.

See “The Monitor” (📖 8, 9) for information on indicators in the monitor.

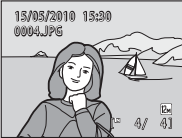
	Shooting mode	Playback mode
Show info		
Auto info (default setting)	The same information as in Show info is displayed. If no operations are performed after a few seconds, the display will be the same as Hide info . The information is displayed again when an operation is performed.	
Hide info		
Framing grid	 <p>In the following shooting modes, a framing grid appears to help frame pictures, in addition to the information displayed in Auto info.</p> <ul style="list-style-type: none"> •  Easy auto mode •  Auto mode <p>In other shooting modes, the same information as in Auto info is displayed.</p>	 <p>The current settings or operation guide is displayed, as in Auto info above.</p>

DATE Date Imprint

Press **MENU** → **Y** (setup menu) (📖 86) → **DATE** Date imprint

Imprint the shooting date and time on pictures. Date can be printed from printers that do not support the date imprinting (📖 71).



Off (default setting)

Date and time are not imprinted on pictures.

Date

The date is imprinted in the bottom right corner of pictures.

Date and time

The date and time is imprinted in the bottom right corner of pictures.

At settings other than **Off**, the icon for the current setting is displayed in the monitor (📖 8).



✓ Date imprint

- Imprinted dates form a permanent part of image data and cannot be deleted.
- Date imprint is disabled in the following situations.
 - When using the **Panorama assist** scene mode
 - When using movie mode
- Dates imprinted at an **Image mode** setting (📖 74) of **VGA 640×480** may be difficult to read. Choose **PC 1024×768** or larger when using date imprint.
- The date is recorded using the format selected in the setup menu's **Date** item (📖 16, 89).

📎 Date Imprint and Print Set

When pictures are printed from DPOF-compatible printers that can print date and photo information, you can use **Print Set** (📖 70) and print the shooting date and photo information on the pictures. In such a case, it is unnecessary to imprint date and time on pictures beforehand using **Date Imprint**.

Electronic VR

Press the **MENU** button →  (Setup menu) (📖 85) →  Electronic VR

Choose whether to use electronic VR (vibration reduction) when taking still pictures.

Auto

When all of the following conditions are met while taking still pictures, electronic VR is applied and the effects of camera shake are reduced.

- The flash is turned off or set to slow sync mode.
- The shutter speed is slow.
- The **Continuous** setting is set to **Single**.
- When the subject is dark.

Off (default setting)



Electronic VR is disabled.

When **Auto** is selected,  appears on the monitor (📖 8), and electronic VR is applied depending on shooting conditions.

Notes on Electronic Vibration Reduction

- Electronic VR is disabled while the flash is used, except when using slow sync mode. Note that Electronic VR is disabled even when flash mode is slow sync with red-eye reduction (📖 37, 38).
- If the exposure period exceeds a certain period of time, **Electronic VR** will not function.
- Electronic VR cannot be used when using the following scene modes.
 - Sports (📖 37)
 - Night portrait (📖 37)
 - Dusk/dawn (📖 39)
 - Night landscape (📖 39)
 - Museum (📖 40)
 - Fireworks show (📖 41)
 - Backlight (📖 41)
- The effectiveness of **Electronic VR** decreases as camera shake increases.
- Pictures taken using motion detection may be somewhat grainy.

Motion detection

Press **MENU** →  (setup menu) (📖 86) →  Motion detection

Set whether or not the camera automatically increases the shutter speed to reduce blurring when motion is detected while shooting still pictures.

Auto (default setting)

In order to reduce the effects of camera shake or subject movement, ISO sensitivity and shutter speed are increased when the camera detects camera shake or subject movement.

However, motion detection does not function in the following situations.

- When flash mode is set to  (fill flash)
- When **Multi-shot 16** (📖 78) is selected
- When scene mode is set to **Night portrait** (📖 37), **Dusk/dawn** (📖 39), **Fireworks show** (📖 41) or **Backlight** (📖 41)

Off



Motion detection is not enabled.

The icon for the current setting is displayed in the monitor when the camera is in shooting mode (📖 21). When the camera detects shaking and increases shutter speed, the motion detection indicator turns green. No icon is displayed when **Off** is selected.

Notes on Motion Detection

- Blurring caused by camera shake or subject movement may not be eliminated in some situations.
- Motion detection may not function if camera shake or subject movement is excessive, or if there is insufficient lighting.
- The pictures taken may become somewhat grainy.

AF Assist

Press MENU →  (setup menu)  86 →  AF assist

Change settings for AF-assist illumination.

Auto (default setting)

AF-assist illumination will be used to assist the focus operation when the subject is poorly lit. The illuminator has a range of about 1.9 m (6 ft. 2 in.) at the maximum wide-angle position and 1.1 m (3 ft. 7 in.) at the maximum telescopic position. However, the AF-assist illumination will not turn on in some scene modes even if **Auto** is selected ( 36-41).

Off

Disable this function. The camera may be unable to focus if lighting is poor.

🔊 Sound Settings

Press MENU → 🗨️ (setup menu) (📖 86) → 🔊 Sound settings

Adjust the following sound settings.

Button sound

Turn the button sound **On** or **Off**. When **On** (default setting) is selected, a beep will sound once when operations are completed successfully, two times when the focus has been locked, and three times when an error is detected, and welcome sound is played when the camera is turned on.

Shutter sound

Choose shutter sound from **On** (default setting) or **Off**.

Even when set to **On**, the shutter sound is not heard in the following situations.

- When using **Continuous**, **BSS**, or **Multi-shot 16**
- When using **Sports** or **Museum**
- When shooting movies

Auto Off

Press **MENU** → **Y** (setup menu) (📖 86) →  Auto off

When the camera is on and a period of time passes without any operations, the camera will enter the standby mode (📖 15) to save power.

When the camera enters standby mode, the power-on lamp flashes. If no operations are performed within three minutes, the camera turns off.

Use this option to set the amount of time that passes before the camera enters standby mode.

Auto off

Choose the time allowed to elapse before the camera enters standby mode if no operations are performed from **30 s** (default setting), **1 min**, **5 min**, and **30 min**.

Sleep Mode

If **On** (default setting) is selected, the camera will enter standby mode when there is no change in the brightness of the subject, even before the time selected in the auto off menu has elapsed. The camera will enter sleep mode after 30 seconds when **Auto off** is set to **1 min** or less, or after 1 minute when **Auto off** is set to **5 min** or more.



Notes on Auto Off

The time allowed to elapse before the camera enters standby mode is fixed in the following cases:





- While menus are displayed: 3 minutes
- While slide show is in progress: Up to 30 minutes

Canceling standby mode

Cancel standby mode and reactivate the monitor by pressing any of the following buttons.

- Power switch
- Shutter-release button
-  button
-  button

Format Memory/ **Format Card**

Press **MENU** →  (setup menu)  86 →  **Format memory/** **Format card**

Use this option to format the internal memory or a memory card.

Formatting internal memory

To format the internal memory, remove the memory card from the camera.

The **Format memory** option appears in the setup menu.

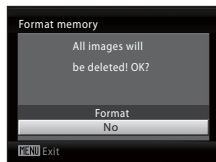

Formatting a Memory Card

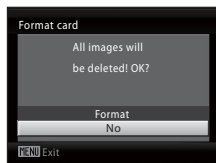

When the memory card is inserted in the camera, the **Format card** option appears in the setup menu.



Formatting Internal Memory and Memory Cards

- Formatting the internal memory or memory cards permanently deletes all data. Be sure to transfer important pictures to a computer before formatting.
- Do not turn the camera off or open the battery-chamber/memory card slot cover during formatting.
- The first time you insert the memory cards used in other devices into this camera, be sure to format them using this camera.

Language



Press **MENU** →  (setup menu) (📖 86) →  Language

Select the language used for camera monitor display.

Čeština	Czech
Dansk	Danish
Deutsch	German
English	(default setting)
Español	Spanish
Ελληνικά	Greek
Français	French
Indonesia	Indonesian
Italiano	Italian
Magyar	Hungarian
Nederlands	Dutch
Norsk	Norwegian

Polski	Polish
Português	Portuguese
Русский	Russian
Suomi	Finnish
Svenska	Swedish
Türkçe	Turkish
عربي	Arabic
简体中文	Simplified Chinese
繁體中文	Traditional Chinese
日本語	Japanese
한글	Korean
ภาษาไทย	Thai

Video Mode

Press **MENU** →  (setup menu) (📖 86) →  Video mode

Adjust settings for connection to a television. Choose from **NTSC** and **PAL**.

Blink Warning

Press **MENU** → **Y** (setup menu) (📖 86) →  Blink warning

Choose whether or not blinking eyes are detected when using face detection (📖 24) in the following shooting modes.

-  (easy auto) mode
- **Portrait** (📖 36) and **Night portrait** (📖 37) scene modes

On

When the camera detects that one or more human subjects have closed their eyes shortly after recognizing the faces and shooting them, the **Did someone blink?** screen will appear on the monitor. The face of the human subject that may have closed his/her eyes is framed by a yellow border. In such a case, you can check the shot picture and determine if you take the picture again. → “Operating the Did someone blink? Screen” (📖 102)

Off (default setting)







Blink warning doesn't take effect.

Operating the Did someone blink? Screen

The following operations are available while the **Did someone blink?** screen is displayed.

If no operations are performed for a few seconds, the screen automatically returns to the shooting mode screen.



To	Use	Description
Enlarge and display the face of the person who blinked	T (Q)	Rotate the zoom control to T (Q).
Switch to full-frame playback	W (📷)	Rotate the zoom control to W (📷).
Select the face to be displayed		If the camera detects more than one human subjects with their eyes closed, press ▲▼◀▶ during the enlarged display to switch over the face displayed.
Delete the shot picture		Press  .
Switch to shooting mode		Press  or the shutter-release button.
		

Reset All

Press **MENU** →  (setup menu) (📖 86) →  Reset all

When **Reset** is selected, the camera's settings will be restored to their default values.

Pop-up Menu

Option	Default value
Flash mode (📖 30)	Auto
Self-timer (📖 32)	Off
Macro mode (📖 33)	Off
Exposure compensation (📖 34)	0.0



Scene mode

Option	Default value
Scene mode (📖 35)	Portrait
Hue adjustment in food mode (📖 43)	Center

Movie Menu

Option	Default value
Movie options (📖 56)	TV movie 640

Shooting Menu

Option	Default value
Image mode (📖 74)	L22:  4000×3000 L21:  3264×2448
White balance (📖 76)	Auto
Continuous (📖 78)	Single
Color options (📖 79)	Standard color

Setup Menu

Option	Default value
Menus (📖 87)	Text
Welcome screen (📖 88)	None
Photo info (📖 92)	Auto info
Image review (📖 92)	On
Brightness (📖 92)	3
Date imprint (📖 94)	Off
Electronic VR (📖 95)	Off
Motion detection (📖 96)	Auto
AF assist (📖 97)	Auto
Button sound (📖 98)	On
Shutter sound (📖 98)	On
Auto off (📖 99)	30 s
Sleep mode (📖 99)	On
Blink warning (📖 102)	Off

Others

Option	Default value
Paper size (📖 66, 67)	Default

- Choosing **Reset all** also clears the current file number (📖 111) from the memory. Numbering will continue from the lowest number available. To reset file numbering to "0001", delete all pictures (📖 84) before selecting **Reset all**.
- The following settings in the menus will remain unaffected even if **Reset all** is performed.



Shooting menu:

Preset manual in the **White balance** menu (📖 77)

Setup menu:

Settings for picture registered for **Welcome screen** (📖 88), **Date** (📖 89), **Language** (📖 101), **Video mode** (📖 101), and **Battery type** (📖 105)



Battery Type

Press **MENU** →  (setup menu) (📖 86) →  Battery type

To ensure that the camera shows the correct battery level (📖 20), choose the type that matches the batteries currently in use.

Alkaline (default setting)	LR6/L40 (AA-size) Alkaline batteries
COOLPIX (Ni-MH)	Nikon EN-MH2 Ni-MH (nickel metal hydride) rechargeable batteries
Lithium	FR6/L91 (AA-size) lithium batteries

Protect



Press MENU →  (setup menu) (📖 86) →  Protect

Protect selected pictures from accidental deletion. You can turn protection on and off for images selected in the picture selection screen. → “Selecting Multiple Pictures” (📖 82)

Note, however, that formatting the camera’s internal memory or the memory card will permanently erase protected files (📖 100).

Protected pictures are recognized by the  icon (📖 9, 48) in playback mode.



Rotate Image

Press **MENU** →  (setup menu) (📖 86) →  Rotate image

Set the picture orientation (vertical or horizontal frame) displayed on the camera monitor after the pictures are taken.

Pictures can be rotated 90° clockwise or counterclockwise.

Pictures that were recorded in the portrait (vertical) orientation can be rotated up to 180° in either direction.

Select a picture in the picture selection screen (📖 82), and press **OK** to display the Rotate image screen. Press the multi selector  or  to rotate the picture 90°.

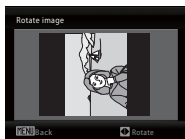

Rotate 90°
counterclockwise

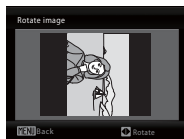

Rotate 90°
clockwise



Press **OK** to select the displayed direction and the vertical / horizontal position data will be recorded on the picture.

Copy

Press MENU →  (setup menu) (📖 86) →  Copy

Copy pictures between the internal memory and a memory card.

1 Select an option from the copy screen using the multi selector and press .

 → : Copy pictures from internal memory to memory card.

 → : Copy pictures from memory card to internal memory.

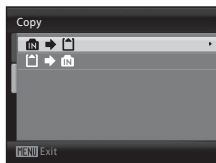

2 Choose the copy option and press .

Selected images: Copy pictures selected from the picture selection screen (📖 82).

All images: Copy all pictures.

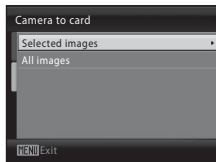

Notes on Copying Pictures

- JPEG- and AVI-format files can be copied. Files recorded in any other format cannot be copied.
- Pictures taken with another make of camera or that have been modified on a computer cannot be copied.
- Edited copies have the same protection marking (📖 106) as the original, but are not marked for printing (📖 70).

More Information

Image File and Folder Names → 📖 111

Ver. Firmware Version

Press **MENU** → **Y** (setup menu) (📖 86) → **Ver.** Firmware version

View the current camera firmware version.

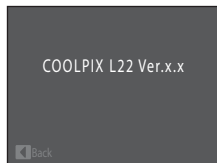

Optional Accessories

Rechargeable battery	Rechargeable Ni-MH batteries EN-MH2-B2 (set of two EN-MH2 batteries)* ¹ Rechargeable Ni-MH batteries EN-MH2-B4 (set of four EN-MH2 batteries)* ¹
Battery charger	Battery Charger MH-72 (includes two rechargeable Ni-MH batteries EN-MH2)* ¹ Battery Charger MH-73 (includes four rechargeable Ni-MH batteries EN-MH2)* ¹
AC adapter	AC Adapter EH-65A <div style="text-align: center;"> <p><How to attach EH-65A></p> </div> <p>AC Adapter EH-62B cannot be used.</p>
USB Cable	USB Cable UC-E6
AV Cable	Audio/Video Cable EG-CP14

*¹ To charge EN-MH2 batteries, use only Battery Charger MH-72 or MH-73. Do not use these battery chargers to charge any other type of battery.

Approved Memory Cards

The following Secure Digital (SD) memory cards have been tested and approved for use in this camera.

All cards of the designated make and capacity can be used, regardless of speed.

SanDisk	2 GB* ¹ , 4 GB* ² , 8 GB* ² , 16 GB* ² , 32 GB* ²
TOSHIBA	2 GB* ¹ , 4 GB* ² , 8 GB* ² , 16 GB* ² , 32 GB* ²
Panasonic	2 GB* ¹ , 4 GB* ² , 8 GB* ² , 12 GB* ² , 16 GB* ² , 32 GB* ²
Lexar	2 GB* ¹ , 4 GB* ² , 8 GB* ²

*¹ If the memory card will be used with a card reader or similar device, check that device supports 2 GB cards.



*²  SDHC-compliant. If the memory card will be used with a card reader or similar device, check that device supports SDHC.

Contact the manufacturer for details on the above cards.

Image File and Folder Names

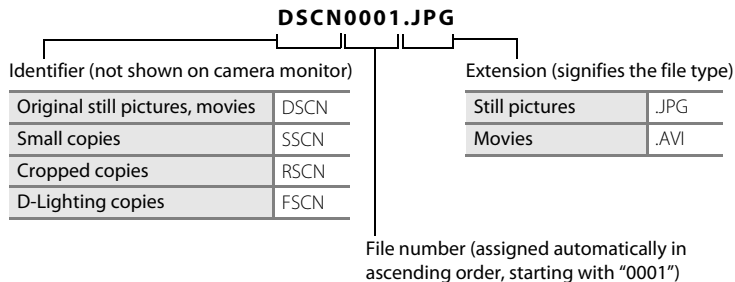
Pictures and movies are assigned file names as follows.



- Files are stored in folders named with a folder number followed by a five-character identifier: "P_" plus a three-digit sequence number for pictures taken using panorama assist (e.g. "101P_001";  44) and "NIKON" for all other pictures (e.g. "100NIKON"). When the number of files within a folder reaches 9999, a new folder will be created. File numbers will be assigned automatically starting with "0001".
- Files copied using **Copy > Selected images** are copied to the current folder, where they are assigned new file numbers in ascending order starting from the largest file number in memory. **Copy > All images** copies all folders from the source medium; file names do not change but new folder numbers are assigned in ascending order, starting from the largest folder number on the destination medium ( 108).
- Folders can hold up to 200 pictures; if a picture is taken when the current folder contains 200 pictures, a new folder will be created by adding one to the current folder number. If a picture is taken when the current folder is numbered 999 and contains 200 pictures or a picture numbered 9999, no further pictures can be taken until the medium is formatted ( 100) or a new memory card inserted.

Caring for the Camera

To ensure continued enjoyment of this Nikon product, observe the following precautions when using or storing the device:

Keep dry

The device will be damaged if immersed in water or subjected to high humidity.

Do not drop

The product may malfunction if subjected to strong shock or vibration.

Handle the lens and all moving parts with care

Do not apply force to the lens, lens cover, monitor, memory card slot or battery chamber. These parts are easily damaged. Applying force to the lens cover could result in camera malfunction or damage to the lens. Should the monitor break, care should be taken to avoid injury caused by broken glass and to prevent the liquid crystal from the display touching the skin or entering the eyes or mouth.

Do not point the lens at strong light sources for extended periods

Avoid pointing the lens at the sun or other strong light sources for extended periods when using or storing the camera. Intense light may cause deterioration of the image sensor, producing a white blur effect in photographs.

Keep away from strong magnetic fields

Do not use or store this device in the vicinity of equipment that generates strong electromagnetic radiation or magnetic fields. Strong static charges or the magnetic fields produced by equipment such as radio transmitters could interfere with the monitor, damage data stored on the memory card, or affect the product's internal circuitry.

Avoid sudden changes in temperature

Sudden changes in temperature, such as when entering or leaving a heated building on a cold day, can cause condensation to form inside the device. To prevent condensation, place the device in a carrying case or a plastic bag before exposing it to sudden changes in temperature.

Turn the product off before removing or disconnecting the power source

Do not remove the batteries while the product is on, or while images are being recorded or deleted. Forcibly cutting power in these circumstances could result in loss of data or in damage to product memory or internal circuitry.

 **The Battery**

- Check the battery level when taking the camera out, and replace the batteries if necessary (📖 20). If possible, carry spare batteries when taking pictures on important occasions.
- When recharging rechargeable batteries, do not recharge batteries that contain a different amount of charge, or batteries of different model numbers.
- When charging EN-MH2 batteries using Battery Charger MH-72, charge two batteries at a time. When charging EN-MH2 batteries using Battery Charger MH-73, charge two or four batteries at a time. To charge EN-MH2 batteries, use only Battery Charger MH-72 or MH-73. Do not use these battery chargers to charge any other type of battery.
- Do not use any battery charger other than the MH-70/71 to recharge EN-MH1 batteries. Do not use the MH-70/71 to charge any batteries other than EN-MH1 batteries. Set the Battery type setting (📖 105) to **COOLPIX (Ni-MH)**.
- Battery capacity tends to decrease on cold days. Be sure that the batteries are fresh before heading outside to take pictures in cold weather. Keep spare batteries in a warm place and exchange as necessary. Once warmed, a cold battery may recover some of its charge.
- Dirt on the battery terminals can prevent the camera from functioning.
- Used batteries are a valuable resource. Please recycle used batteries in accordance with local regulations.

Cleaning

Lens	Avoid touching glass parts with your fingers. Remove dust or lint with a blower (typically a small device with a rubber bulb attached to one end that is pumped to produce a stream of air out the other end). To remove fingerprints or other stains that cannot be removed with a blower, wipe the lens with a soft cloth, using a spiral motion that starts at the center of the lens and working toward the edges. If this fails, clean the lens using a cloth lightly dampened with commercial lens cleaner.
Monitor	Remove dust or lint with a blower. To remove fingerprints and other stains, clean the monitor with a soft, dry cloth, being careful not to apply pressure.
Body	Use a blower to remove dust, dirt or sand, then wipe gently with a soft, dry cloth. After using the camera at the beach or seaside, wipe off any sand or salt with a dry cloth lightly dampened with fresh water, then dry thoroughly. Note that foreign matter inside the camera could cause damage not covered by the warranty.

Do not use alcohol, thinner, or other volatile chemicals.

Storage

Turn the camera off when not in use. Check that the power-on lamp is off before putting the camera away. Remove the batteries if the camera will not be used for an extended period. Do not store the camera with naphtha or camphor moth balls, or in any of the following locations:

- Next to equipment that produces strong electromagnetic fields, such as televisions or radios
- Exposed to temperatures below -10°C (14°F) or above 50°C (122°F)
- Poorly ventilated or subject to humidities of over 60%

To prevent mold or mildew, take the camera out of storage at least once a month. Turn the camera on and release the shutter a few times before putting the camera away again.



Notes on the Monitor

- The monitor may contain a few pixels that are always lit or that do not light. This is a characteristic common to all TFT LCD displays, and does not indicate a malfunction. Images recorded using the product will not be affected.
- When framing bright subjects, vertical comet-like streaks that whiten toward either end may appear in the display. This phenomenon, known as “smear”, does not indicate a malfunction. In shooting modes other than movie mode, smear has no effect on the images that are recorded.
- Images in the monitor may be difficult to see under bright lighting.
- The monitor is lit by an LED backlight. Should the monitor begin to dim or flicker, contact your Nikon-authorized service representative.

























Notes on Smear

White or colored streaks may be visible when bright subjects are framed in the monitor. This phenomenon, known as “smear,” occurs when extremely bright light strikes the image sensor; it is characteristic of image sensors and does not indicate a malfunction. Smear may also take the form of partial discoloration in the monitor during shooting. It does not appear in images recorded with the camera except in the cases of movies and of images recorded with **Multi-shot 16** selected for **Continuous**. When shooting in these modes, we recommend that you avoid bright subjects such as the sun, reflected sunlight, and electric lights.













Error Messages

The following table lists the error messages and other warnings displayed in the monitor, as well as the solutions for dealing with them.

Display	Problem	Solution	
 (blinks)	Clock not set.	Set clock.	89
	Battery running low.	Prepare to change the batteries.	14, 105
 Battery exhausted.	Battery exhausted.	Replace batteries.	
 (blinks red)	Camera cannot focus.	<ul style="list-style-type: none"> • Refocus. • Use focus lock. 	24, 25, 29
 Please wait for the camera to finish recording.	Camera cannot perform other operations until recording is complete.	Wait until message clears from display automatically when recording is complete.	25
 Memory card is write protected.	Write-protect switch is in "lock" position.	Slide write-protect switch to "write" position.	19
 This card cannot be used.	Error accessing memory card.	<ul style="list-style-type: none"> • Use approved card. • Check that connectors are clean. • Confirm that memory card is correctly inserted. 	110
 This card cannot be read.			18
 Card is not formatted. Format card? Yes No	Memory card has not been formatted for use in COOLPIX L22/L21.	All data saved on the memory card will be deleted. If there is any data on the card that you want to keep, select No , and backup the data to a computer before formatting the memory card. To format the memory card, select Yes and press  .	19
 Out of memory.	Memory card is full.	<ul style="list-style-type: none"> • Choose smaller image mode. • Delete pictures. • Insert new memory card. • Remove memory card and use internal memory. 	74 26, 57, 84 18 19

Display	Problem	Solution	
 Image cannot be saved.	Error occurred while recording picture.	Format internal memory or memory card.	100
	Camera has run out of file numbers.	Replace the memory card, or format the internal memory/memory card.	18 100
	Picture cannot be used for welcome screen.	The following pictures cannot be used. <ul style="list-style-type: none"> • Pictures taken at an Image mode setting of  3968x2232 for L22 and  3200x1800 for L21 • Pictures created using the small picture or crop functions that are 320 x 240 or smaller in size 	53, 54, 74
	There is not enough memory to copy the picture.	Delete pictures from destination.	84
 Image cannot be modified.	You are trying to edit a picture that cannot be edited.	Confirm the conditions that are required for editing.	51
 Cannot record movie.	Time out error while recording movie.	Choose memory card with faster write speed.	18
 Memory contains no images.	No pictures in the internal memory or memory card.	Remove memory card to play back pictures from internal memory.	108
 File contains no image data.	File not created with COOLPIX L22/L21.	File cannot be viewed on this camera. View file using the computer or any other devices which was used to create or edit this file.	–
 This image cannot be deleted.	Picture is protected.	Disable protection.	106
 Travel destination is in the current time zone.	Destination in same time zone as home.	–	89

Error Messages

Display	Problem	Solution	
Lens error 	Lens error.	Turn camera off and then on again. If error persists, contact retailer or Nikon-authorized service representative.	20
 Communications error	USB cable disconnected during printing.	Turn camera off, reconnect USB cable.	65
System error 	Error has occurred in camera's internal circuitry.	Turn camera off, remove and reinsert batteries, and turn camera on. If error persists, contact retailer or Nikon-authorized service representative.	14, 20
 Printer error: check printer status.	Running out of ink or printer error.	Check printer. After checking the ink or solving the problem, select Resume and press  to resume printing.*	–
 Printer error: check paper	Specified size of paper is not loaded in printer.	Load the specified paper, select Resume and press  to resume printing.*	–
 Printer error: paper jam	Paper has jammed in the printer.	Eject the jammed paper, select Resume and press  to resume printing.*	–
 Printer error: out of paper	No paper is loaded in printer.	Load the specified paper, select Resume and press  to resume printing.*	–
 Printer error: check ink	Ink error.	Check ink, select Resume and press  to resume printing.*	–
 Printer error: out of ink	Ink cartridge is empty.	Replace ink, select Resume and press  to resume printing.*	–
 Printer error: file corrupt	An error caused by the image file has occurred.	Select Cancel and press  to cancel printing.	–

* See the documentation provided with your printer for further guidance and information.

Troubleshooting

If the camera fails to function as expected, check the list of common problems below before consulting your retailer or Nikon-authorized service representative. Refer to the page numbers in the right-most column for more information.



Display, Settings and Power Supply



Problem	Cause/Solution	
Monitor is blank	<ul style="list-style-type: none">• Camera is off.• Battery exhausted.• Standby mode for saving power: press the shutter-release button halfway.• When flash lamp blinks red, wait until flash has charged.• Camera and computer are connected via USB cable.• Camera and TV are connected via AV cable.	20 20 15, 24 31 60 58
Monitor is hard to read	<ul style="list-style-type: none">• Adjust monitor brightness.• Monitor is dirty. Clean monitor.	92 114
Camera turns off without warning	<ul style="list-style-type: none">• Battery exhausted.• Camera has turned off automatically to save power.• Battery is cold.	20 99 113
Date and time of recording are not correct	<ul style="list-style-type: none">• Pictures taken while the clock is not set will have a time stamp of "00/00/0000 00:00" movies will be dated "01/ 01/2010 00:00". (The "Date not set" indicator blinks during shooting to indicate the clock is not set.) Set the correct date and time using Date in the setup menu.• Check camera clock regularly against more accurate timepieces and reset as required.	16 89
No indicators displayed in monitor	Hide info is selected for Photo info . Select Show info .	92
Date imprint not available	Camera clock has not been set.	16, 89
Date not appearing on pictures even when Date imprint is enabled	Date imprint is disabled in the following situations. <ul style="list-style-type: none">• When the scene mode is set to Panorama assist• Movies	42 55
Camera settings reset	The clock battery is exhausted; all settings were restored to their default values.	90





Electronically Controlled Cameras

In extremely rare instances, unusual characters may appear in the monitor and the camera may stop functioning. In most cases, this phenomenon is caused by a strong external static charge. Turn the camera off, remove and replace the battery, then turn the camera on again. In the event of continued malfunction, contact your retailer or Nikon-authorized service representative. Note that disconnecting the power source as described above may result in the loss of any data not recorded to internal memory or the memory card at the time the problem occurred. Data already recorded will not be affected.



Shooting

Problem	Cause/Solution	
No picture taken when shutter-release button is pressed.	<ul style="list-style-type: none"> When camera is in playback mode, press . When menus are displayed, press MENU. Battery exhausted. When flash lamp blinks, flash is charging. 	10
		12
		20
		31
Camera cannot focus.	<ul style="list-style-type: none"> The intended subject is one with which autofocus does not perform well. Set AF assist in the setup menu to Auto. Focus error. Turn camera off and then on again. 	25
		97
		20
Pictures are blurred.	<ul style="list-style-type: none"> Use flash. Use electronic vibration reduction or motion detection. Use BSS (Best Shot Selector). Use tripod and self-timer. 	30
		95, 96
		78
		5, 32
Bright specks appear in pictures taken with flash.	Flash is reflecting off particles in air. Turn flash off.	30
Flash does not fire.	<ul style="list-style-type: none"> Flash is off. Some scene modes that cannot turn on flash are selected. Movie mode is selected. Continuous or Multi-shot 16 or BSS is selected for Continuous in shooting menu. 	30
		35
		55
		78
Optical zoom cannot be used.	Optical zoom cannot be used while recording movies.	55

Problem	Cause/Solution	
Digital zoom cannot be used.	Digital zoom cannot be used in the following situations. <ul style="list-style-type: none"> • When Portrait or Night portrait is selected for Scene mode. • When using smart portrait mode. • Just before recording a movie (up to 2x can be applied while recording movies). • When Multi-shot 16 is selected for Continuous. 	36, 37 46 55 78
Image mode not available.	<ul style="list-style-type: none"> • Image mode cannot be adjusted when Multi-shot 16 is selected for Continuous. 	78
No sound when shutter is released.	<ul style="list-style-type: none"> • Off is selected for Sound settings > Shutter sound in setup menu. Even when set to On, the shutter sound is not heard depending on the current shooting mode or settings. • Do not block the speaker. 	98 4
AF-assist illuminator does not light.	<ul style="list-style-type: none"> • Off is selected for AF assist option in camera setup menu. • AF-assist illuminator turns off automatically in some scene modes. 	97 36-42
Pictures appear smeared.	Lens is dirty. Clean lens.	114
Hues are unnatural.	White balance does not match light source.	76
Randomly spaced bright pixels ("noise") appear in image.	The subject is dark, so shutter speed is too slow or ISO sensitivity is too high. Noise can be reduced by: <ul style="list-style-type: none"> • Using flash. 	30
Pictures are too dark (underexposed).	<ul style="list-style-type: none"> • Flash is off. • Flash window is blocked. • Subject is beyond flash range. • Adjust exposure compensation. • Subject is backlit. Select the Backlight scene mode, or set the flash mode to  (fill flash). 	30 22 30 34 30, 41
Pictures are too bright (overexposed).	Adjust exposure compensation.	34

Problem	Cause/Solution	
Unexpected results when flash set to  (auto with red-eye reduction).	When taking pictures with  (auto with red-eye reduction), or when taking pictures with Night portrait (either in easy auto mode or the Night portrait scene mode) and the fill flash with slow sync and red-eye reduction is used, red-eye reduction may be applied, in rare cases, to areas not affected by red-eye. Use any auto mode or scene mode other than Night portrait , and change the flash to any other settings other than  (auto with red-eye reduction) and try shooting again.	28, 30, 37

Playback

Problem	Cause/Solution	
File cannot be played back.	File was overwritten or renamed by computer or other make of camera.	–
Cannot zoom in on picture.	Playback zoom cannot be used with movies, small pictures, or pictures that have been cropped to 320 × 240 or smaller.	–
Cannot use D-Lighting, small picture, or crop options.	<ul style="list-style-type: none"> • These options cannot be used with movies. • Pictures taken at an Image mode setting of  3968×2232 for L22 and  3200×1800 for L21 cannot be edited. • Select picture that supports D-Lighting, small picture, or crop. • Camera is unable to edit pictures taken with other cameras. 	57 74 51 51
Pictures not displayed on television.	<ul style="list-style-type: none"> • Choose correct Video mode. • Memory card contains no pictures. Replace memory card. Remove memory card to play back pictures from internal memory. 	101 18
Nikon Transfer does not start when camera is connected.	<ul style="list-style-type: none"> • Camera is off. • Battery exhausted. • USB cable is not correctly connected. • Camera is not recognized by the computer. • Computer is not set to launch Nikon Transfer automatically. For more information about Nikon Transfer, refer to help information contained in Nikon Transfer. 	20 20 60 – –

Problem	Cause/Solution	
Pictures to be printed are not displayed.	Memory card contains no pictures. Replace memory card. Remove memory card to print pictures from internal memory.	18
Cannot select paper size with camera.	Even when using a PictBridge compatible printer, paper size cannot be selected from the camera in the following situations. Use the printer to select paper size. <ul style="list-style-type: none"><li data-bbox="401 375 829 421">• The printer does not support the paper sizes used by the camera.<li data-bbox="401 425 816 471">• The printer automatically selects the paper size.	66, 67

Specifications



Nikon COOLPIX L22/COOLPIX L21 Digital Camera

Type	Compact digital camera
Effective pixels	COOLPIX L22: 12.0 million COOLPIX L21: 8.0 million
Image sensor	COOLPIX L22: 1/2.3-in. CCD; total pixels: 12.39 million COOLPIX L21: 1/2.5-in. CCD; total pixels: 8.29 million
Lens	3.6x optical zoom, NIKKOR lens
Focal length	6.7-24.0mm COOLPIX L22: angle of view equivalent to that of 37-134mm lens in 35mm [135] format COOLPIX L21: angle of view equivalent to that of 41-145mm lens in 35mm [135] format
f/-number	f/3.1-6.7
Construction	7 elements in 6 groups
Digital zoom	Up to 4x COOLPIX L22: angle of view equivalent to that of approx. 536mm lens in 35mm [135] format COOLPIX L21: angle of view equivalent to that of approx. 580mm lens in 35mm [135] format
Vibration reduction	Electronic VR
Autofocus (AF)	Contrast-detect AF
Focus range (from lens)	<ul style="list-style-type: none">• Approx. 30 cm (1 ft.) to ∞ (W); approx. 70 cm (2 ft. 4 in.) to ∞ (T)• Macro mode: 5 cm (2 in.) to ∞ (wide-angle position)
Focus-area selection	Center, face detection
Monitor	COOLPIX L22: 3-in., approx. 230k-dot, TFT LCD with 5-level brightness adjustment COOLPIX L21: 2.5-in., approx. 230k-dot, TFT LCD with 5-level brightness adjustment
Frame coverage (shooting mode)	Approx. 98% horizontal and 98% vertical (Compared to actual picture)
Frame coverage (playback mode)	Approx. 100% horizontal and 100% vertical (Compared to actual picture)

Storage	
Media	Internal memory (Approx. 19 MB), Secure Digital (SD) memory cards
File system	DCF, Exif 2.2, and DPOF compliant
File formats	Still images: JPEG Movies: AVI (Motion-JPEG compliant)
Image size (pixels)	COOLPIX L22: <ul style="list-style-type: none"> • 12M (High) [4000 × 3000 ★] • 12M [4000 × 3000] • 8M [3264 × 2448] • 5M [2592 × 1944] • 3M [2048 × 1536] • PC [1024 × 768] • VGA [640 × 480] • 16:9 [3968 × 2232] COOLPIX L21: <ul style="list-style-type: none"> • 8M (High) [3264 × 2448 ★] • 8M [3264 × 2448] • 5M [2592 × 1944] • 3M [2048 × 1536] • PC [1024 × 768] • VGA [640 × 480] • 16:9 [3200 × 1800]
ISO sensitivity (Standard output sensitivity)	Auto (ISO 80-1600)
Exposure	
Metering	256-segment matrix, center-weighted (when using up to 2x digital zoom), spot (digital zoom 2x or more)
Exposure control	Programmed auto exposure with motion detection and exposure compensation (-2.0 to +2.0 EV in steps of 1/3 EV)
Range (📷 (auto) mode)	[W]: -0.7 to + 16.2 EV [T]: 1.5 to 18.4 EV (exposure values achieved with automatic ISO sensitivity adjustment converted to ISO 100 values)
Shutter	
Speed	1/2000 - 1 s, 4 s (Fireworks show scene mode)

Specifications

Aperture	Electronically-controlled ND filter (-1.7 AV) selection
Range	2 steps (f/3.1 and f/5.5 [W])
Self-timer	Approx. 10 seconds
Built-in flash	
Range (approx.)	COOLPIX L22: [W]: 0.5 to 7.0 m (1 ft. 8 in. to 23 ft.), [T]: 0.5 to 3.0 m (1 ft. 8 in. to 9 ft. 10 in.) COOLPIX L21: [W]: 0.5 to 5.5 m (1 ft. 8 in. to 18 ft.), [T]: 0.5 to 2.5 m (1 ft. 8 in. to 8 ft.)
Flash control	TTL auto flash with monitor preflashes
Interface	Hi-Speed USB
Data transfer protocol	MTP, PTP
Video output	Can be selected from NTSC and PAL
I/O terminal	Audio video output/digital I/O (USB)
Supported languages	Arabic, Chinese (Simplified and Traditional), Czech, Danish, Dutch, English, Finnish, French, Greek, German, Hungarian, Indonesian, Italian, Japanese, Korean, Polish, Portuguese, Norwegian, Russian, Spanish, Swedish, Thai, Turkish
Power sources	<ul style="list-style-type: none"> • Two LR6/L40 (AA-size) alkaline or batteries • Two FR6/L91 (AA-size) lithium batteries • Two EN-MH2 rechargeable Ni-MH batteries (available separately) • AC Adapter EH-65A (available separately)
Number of Exposures Possible (Battery life)*	COOLPIX L22: <ul style="list-style-type: none"> • About 240 shots when using alkaline batteries • About 660 shots when using lithium batteries • About 420 shots when using EN-MH2 batteries COOLPIX L21: <ul style="list-style-type: none"> • About 280 shots when using alkaline batteries • About 780 shots when using lithium batteries • About 500 shots when using EN-MH2 batteries
Dimensions (W × H × D)	COOLPIX L22: Approx. 97.7 × 60.5 × 28.3 mm (3.9 × 2.4 × 1.2 in.) (excluding projections) COOLPIX L21: Approx. 92 × 61.1 × 28.3 mm (3.7 × 2.4 × 1.2 in.) (excluding projections)
Weight	COOLPIX L22: Approx. 183 g (6.5 oz.) (including battery and SD memory card) COOLPIX L21: Approx. 169 g (6.0 oz.) (including battery and SD memory card)
Operating environment	
Operating temperature	0 to 40°C (32 to 104°F)
Humidity	Less than 85% (no condensation)

- Unless otherwise stated, all figures are for a camera with fully-charged EN-MH2 batteries operated at an ambient temperature of 25°C (77°F).
- * Based on Camera and Imaging Products Association (CIPA) standards for measuring the life of camera batteries. Measured at 23 (±2) °C (69 to 77°F); zoom adjusted with each shot, flash fired with every other shot, image mode set to L22:  **4000 × 3000**/L21:  **3264 × 2448**. Battery life may vary depending on shooting interval and length of time menus and images are displayed. Supplied batteries are for trial use only.

Specifications

Nikon will not be held liable for any errors this manual may contain.

The appearance of this product and its specifications are subject to change without notice.

Supported Standards

- **DCF:** Design Rule for Camera File System is a standard widely used in the digital camera industry to ensure compatibility among different makes of camera.
- **DPOF:** Digital Print Order Format is an industry-wide standard that allows pictures to be printed from print orders stored on the memory card.
- **Exif version 2.2:** This camera supports Exif (Exchangeable Image File Format for Digital Still Cameras) version 2.2, a standard that allows information stored with photographs to be used for optimal color reproduction when images are output from Exif-compliant printers.
- **PictBridge:** A standard developed cooperatively by the digital camera and printer industries, allowing photographs to be output directly to a printer without connecting the camera to a computer.

Index

Symbols

 (apply selection) button 5, 7, 11

 (Playback) button 5, 7

 Auto mode 29

 Delete button 5, 7, 26, 57

 D-Lighting 52

 Easy auto mode 20, 28

 Electronic VR 95

 Exposure compensation 34

 Flash mode 30

 Macro mode 33

MENU button 5, 7, 12

 Movie mode 55

 Playback mode 26

 Scene mode 35

 Self-timer 32

 Smart Portrait Mode 46

AE/AF-L 45

W button 4, 6, 23, 27, 48, 49, 50

 button 4, 6, 23, 27, 48, 49, 50

T button 4, 6, 13, 23, 27, 48, 49, 50

 button 4, 6, 23, 27, 48, 49, 50

 button 4, 6, 13

A

AC adapter 15, 110

AF-assist illumination 4, 6, 25, 97

Alkaline 15

Alkaline batteries 14

Aperture 24

Audio Video/USB Cable 58, 65

Audio-in/Video-in jack 58

Auto flash 30

Auto off 15, 99

Autofocus 24, 25, 29, 33

AV Cable 58

AVI 111

B

Backlight  41

Batteries 14, 90

Battery level 20

Battery type 15, 105

Battery-chamber 5, 7

Battery-chamber/memory card slot cover
5, 7, 14, 18

Beach/snow  38

Best Shot Selector 78

Black-and-white 79

Blink warning 102

Brightness 92

BSS 78

Built-in flash 4, 6, 30

Built-in microphone 4

Button sound 98

C

Calendar display 49

Close-up  40

Cloudy 76

Color options 79

Compression ratio 74

Computer 59

Continuous 78

Copy  41

Copying pictures 108

Crop 54

Cyanotype 79

D

Date 16, 89

Date imprint 94

Daylight 76

Daylight saving time 16, 90

Delete 26, 27, 57, 84

Digital zoom 23

Direct print 64

D-Lighting 51, 52

DPOF 128

DPOF printing 69



DSCN 111

Dusk/dawn  39

E

Easy auto mode 20, 28
 EH-65A 15
 EN-MH1 15, 110
 EN-MH2 14, 105, 110, 113
 Exposure compensation 34
 Extension 111
 Eyelet for camera strap 4, 6

F

File names 111
 Fill flash 30
 Fireworks show  41
 Firmware version 109
 Flash 30, 31
 Flash lamp 5, 7, 31
 Flash off 30
 Fluorescent 76
 Focus 13, 24
 Focus lock 25, 29
 Folder names 111
 Food  40, 43
 Format 19, 100
 Format memory card 19, 100
 Formatting internal memory 100
 FSCN 111
 Full-frame playback mode 26, 27

H

Halfway 13
 Help 13

I

Identifier 111
 Image mode 21, 35, 74
 Image review 92
 Incandescent 76
 Indicator lamp 5, 7
 Internal memory 18
 ISO sensitivity 31

J

JPG 111



L

Landscape  36
 Language 101
 Lens 4, 6, 124
 Lithium batteries 14

M

Macro mode 33
 Memory capacity 20
 Memory card 18, 110
 Memory card slot 5, 7, 18
 Menus 87
 Monitor 5, 7, 8, 114
 Monitor settings 92
 Motion detection 96
 Movie menu 55, 56
 Movie playback 57
 Movie settings 56
 Multi selector 5, 7, 11
 Multi-shot 16 78
 Museum  40



N

Nickel-metal hydride batteries 14
 Night landscape  39
 Night Portrait  37
 Nikon Transfer 60
 Number of Exposures Remaining 20, 75

O

Optical zoom 23
 Optional Accessories 110

P

Panorama assist  42, 44
 Paper size 66, 67
 Party/indoor  38
 Photo info 92
 PictBridge 64, 128



Playback 26, 27, 48, 50, 57
Playback button 5, 7, 10
Playback menu 81
Playback zoom 50
Portrait  36
Power 14, 16, 20
Power switch 4, 6, 14, 20
Power-on lamp 14, 20
Preset manual 77
Print 66, 67, 70
Print set 70
Print Set (Date) 71
Printer 64
Protect 106

R

Recording movies 55
Red-eye reduction 30, 31
Reset all 103
Rotate image 107
RSCN 111

S

Scene mode 35, 36
Self-timer 32
Self-timer lamp 4, 6, 32
Sepia 79
Setup menu 85
Shooting 20, 22, 24
Shooting Menu 72
Shooting mode button 5, 7, 10
Shooting-mode Selection menu 10
Shutter sound 98
Shutter speed 24
Shutter-release button 4, 6, 24
Single 78
Sleep Mode 99
Slide show 83
Slow Sync 30
Small picture 53
Small size 56

Smart Portrait Mode 46
Sound settings 98
Speaker 4, 6
Sports  37
SSCN 111
Standard color 79
Strap 13
Sunset  38

T

Tabs 12
The  (Playback) Button 10
Thumbnail playback 48
Time zone 16, 89, 91
Tripod socket 5, 7
TV 58
TV movie 56

U

USB Cable 59, 60
USB connector and audio/video output 5, 7, 58, 59, 65

V

Video Mode 101
ViewNX 62
Vivid color 79
Volume 57

W

Welcome screen 88
White balance 76

Z

Zoom button 4, 6, 57



A series of horizontal dashed lines spanning the width of the page, intended for handwriting practice. There are 15 lines in total, starting from the top right and extending to the bottom left.



A series of horizontal dashed lines spanning the width of the page, intended for handwriting practice. There are 15 lines in total, starting from the top right and extending to the bottom left.



A series of horizontal dashed lines spanning the width of the page, intended for handwriting practice. There are 15 lines in total, starting from the top right and extending to the bottom left.

Nikon

No reproduction in any form of this manual, in whole or in part (except for brief quotation in critical articles or reviews), may be made without written authorization from NIKON CORPORATION.



NIKON CORPORATION

Fuji Bldg., 2-3 Marunouchi 3-chome,
Chiyoda-ku, Tokyo 100-8331, Japan

© 2010 Nikon Corporation

Printed in Europe

CT9L02(11)

6MM79211-02