

Nikon
N75 N75 QD

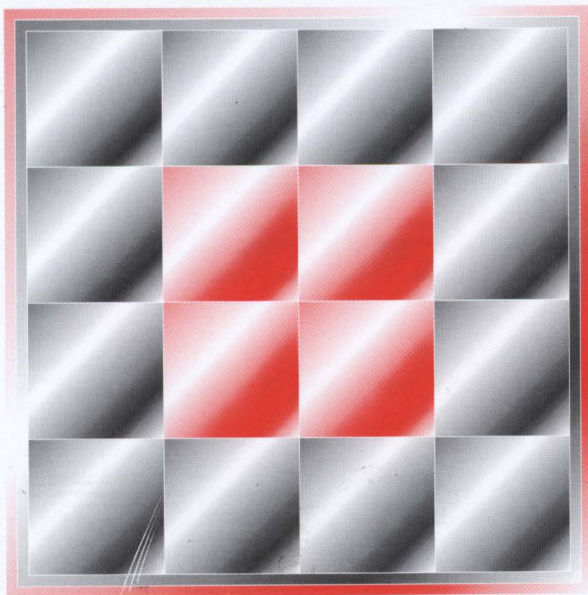

INSTRUCTION MANUAL

En

Introduction

■ Thank you for purchasing the Nikon N75/N75QD—a camera that is sure to make photography a bigger part of your life.

Get to know your N75/N75QD camera, and be sure to read this manual thoroughly before using it. We recommend that you keep this manual handy.

Supplied accessories



Body cap (P. 19)

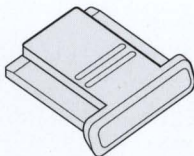

Accessory shoe cover
(P. 108)

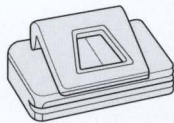

Eyepiece cap DK-5 (P. 82)

■ Take trial shots



Take trial shots before shooting at important occasions like weddings or graduations.



■ Have Nikon spot-check your camera regularly

Nikon recommends that you have your camera serviced by an authorized dealer or service center at least once every two years.

■ Using your camera correctly

The Nikon N75/N75QD's performance has been optimized for use with Nikon brand accessories. Accessories made by other manufacturers may not meet Nikon's criteria for specifications, and nonconforming accessories could damage the N75/N75QD's components. Nikon cannot guarantee the N75/N75QD's performance when it is used with other than Nikon brand accessories.

Note: CUSTOM  

CUSTOM   (numbers from 1 to 12) indicates that the function/mode changes according to Custom Setting menu number.

Contents

BEFORE YOU BEGIN	2-11
Introduction.....	2-3
Nomenclature	6-7
LCD Panel/Viewfinder Display	8-9
Available Exposure Modes	10-11
Start Shooting Immediately	12-13
About Shutter Release Button	14
PREPARATION	15-22
1. Install Batteries and Check Battery Power	16-17
2. Mount Lens	18-19
3. Load Film.....	20-21
4. Set Date and Time (N75QD only)	22
BASIC OPERATION 1	23-31
1. Set Focus Mode and AF Area Mode	24-25
2. Set Exposure Mode to 	26-27
3. Hold Camera and Focus	28-29
4. Release Shutter	30-31
About Metering Systems and Exposure	32
BASIC OPERATION 2	33-42
Shooting with Vari-Program	34-37
Using Built-In Speedlight.....	38-39
Self-Timer Operation	40-41
Imprinting Date/Time (N75QD only).....	42
FOCUS OPERATION	43-52
Focus Mode.....	44-45
Focus Area Mode	46-47
Focus Area Selection.....	48-49
AF-Assist Illuminator.....	50-51
Focus Lock	52
EXPOSURE MODE.....	53-62
Auto-Multi Program	54-55
Shutter-Priority Auto Exposure Mode	56-57
Aperture-Priority Auto Exposure Mode	58-59
Manual Exposure Mode	60-61
Long Time Exposure	62

ADVANCED OPERATION63-70

Exposure Compensation	64-65
Auto Exposure Bracketing.....	66-68
Multiple Exposure.....	69-70

CUSTOM SETTING71-76

Menu/Features of Custom Setting	72-76
---------------------------------------	-------

OTHER FUNCTIONS.....77-88

Film Rewind	78
Film Advance Mode	79
Auto Exposure Lock	80-81
Diopter Adjustment/Viewfinder Accessories	82
Depth-of-Field Preview	83
Remote Control Operation (optional)	84-87
Available Mode Combinations	88

FLASH PHOTOGRAPHY.....89-101

Built-In Speedlight/Ready-Light	90-91
Flash Sync Mode Features.....	92-94
Using Built-In Speedlight.....	95-101
Flash Shooting Distance Range	98
Available Flash Sync Mode Combinations.....	99
Usable Lenses with Built-In Speedlight	100-101

About Depth of Field.....	102
---------------------------	-----

MISCELLANEOUS103-131

Lens Compatibility	104-106
Usable Optional Speedlights.....	107-111
Optional Accessories.....	112-113
Camera Care	114-115
Notes on Batteries	116
Troubleshooting	117-120
Glossary.....	121-123
Specifications	124-128
Index	129-130
Custom Setting Menu	131

Nomenclature

Built-in Speedlight (p. 38/90)

LCD illuminator button (p. 8)

Camera strap eyelet

Self-timer/remote control button (p. 40/84)

LCD panel (p. 8)

Aperture (p. 61)/Exposure Compensation button (p. 64)/
Film rewind button (p. 78)

Shutter release button (p. 14/17)

Power switch (p. 16)

Remote control sensor (p. 84)

Self-timer (p. 40)/AF-Assist Illuminator (p. 50)/
Red-Eye Reduction lamp (p. 93)

Depth-of-field preview button (p. 83)

Camera strap eyelet

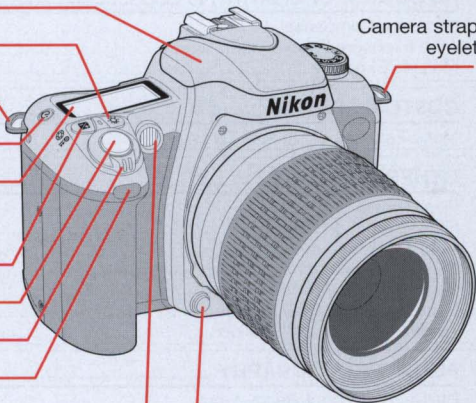

Flash lock-release (p. 95)/
Flash sync mode button (p. 92)

Auto Exposure Bracketing (p. 66)/Multiple Exposure (p. 69)/Film rewind button (p. 78)

Camera back lock release lever (p. 20)

Lens release button (p. 19)

Focus mode selector (pp. 44-45)

Tripod socket

Battery chamber cover lock release lever (p. 16)

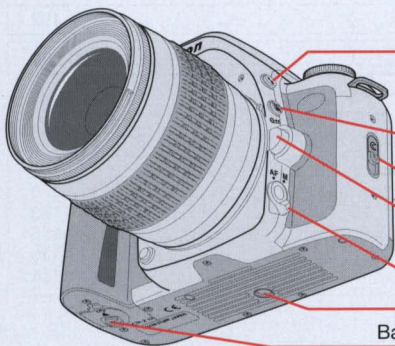

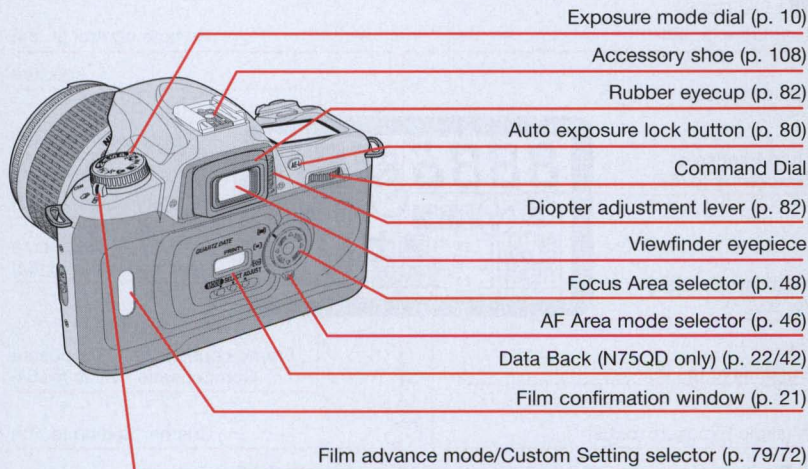

* Illustration shown is the N75QD. The camera back of the N75 differs from the N75QD.

■ N75QD only: Data imprint LCD/buttons

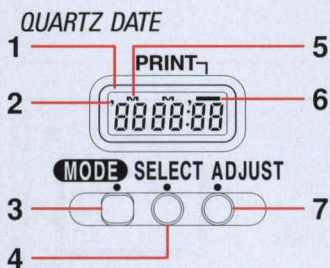

1. Date/time LCD
2. **Y**: Year indicator
3. MODE button: Push to select one of five available displays.
4. SELECT button: Push to select date/time to be adjusted.
5. **M**: Month indicator
6. **█**: Data imprint indicator: Blinks approx. 2 sec. when data is imprinted.
7. ADJUST button: Push to adjust date/time.

LCD Panel/Viewfinder Display

■ LCD panel

Self-timer (p. 40)

Remote control (p. 84)

Shutter speed

Aperture

Auto Exposure Bracketing (p. 66)

Beep sound (p. 28)

Flash sync mode (p. 92/95)

Battery power (p. 17)

Exposure Compensation (p. 64)

Focus area (p. 48)

Frame counter (p. 21)/Exposure Compensation value (p. 64)

Multiple Exposure (p. 69)

Custom Setting (p. 72)

* The illustrations are fully labelled for your reference.

NOTE: About LCD

The LCD panel and viewfinder displays tend to turn darker at high temperatures and have slower response time at low temperatures. In either case, when the temperature returns to normal, the displays also return to normal.

LCD illuminator button

Pressing the  button turns exposure meter on (p. 17), and the LCD panel is illuminated and can be confirmed in the dark. The illumination remains on as long as the exposure meter is on. Illumination turns off after lightly pressing the shutter release button or shutter release.

CUSTOM : The illuminator can be set to come on when any button is pressed (p. 76).



Viewfinder display

Battery power (p. 17)

Film status (p. 21)

Focus indicator
(p. 29/44)

Shutter speed

Aperture

Electronic analog exposure (p. 61)/ Exposure
Compensation value display (p. 64)

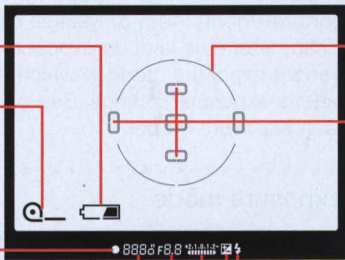



12mm-dia. reference circle
for Center-Weighted
Metering area (p. 60)

Focus area (focus
brackets) (p. 28/48)

Flash ready-light (p. 39/91)/Flash
recommended indication (p. 95)

Exposure Compensation (p. 64)

Vari-Brite focus area and warning indications

The N75/N75QD employs the convenient Vari-Brite Focus Area display system; it enables clear display of the focus brackets at the selected focus area in the viewfinder for easy identification. When the finder image is bright, the focus brackets are displayed in black and when the finder image is dark, the focus brackets are momentarily illuminated in red. Also, when battery power is low or film is not loaded properly, warning indications such as  or  are displayed in the viewfinder.

* Due to characteristics of the LCD used in the Vari-Brite Focus Area display system, a thin line outside the selected focus area may also be displayed or the entire viewfinder may be illuminated in red under certain conditions. These are not malfunctions.

CUSTOM 4 : Focus area highlight can be canceled or can be set to appear in any situation (p. 74).

CUSTOM 2 : Warning indications in the viewfinder can be set not to appear (p. 74).

CAUTION: About viewfinder

The viewfinder will be dark without battery power but brightens after installation of fresh batteries. This is not a malfunction.

Available Exposure Modes

The exposure mode dial of the Nikon N75/N75QD can be divided into two sections. One is the user-controlled exposure mode with Auto-Multi Program, Shutter-Priority Auto, Aperture-Priority Auto or Manual exposure modes, where the photographer can determine various exposure factors. The other section is the point-and-shoot exposure mode in which the camera automatically controls various exposure settings. See pages 26-27, 35-37, 54-62 for more details on each exposure mode.

■ User-controlled exposure mode



P: Auto-Multi Program (p. 54)

Camera controls shutter speed and aperture automatically. Other settings, such as Flexible Program (page 55) or Exposure Compensation (page 64) are possible.



S: Shutter-Priority Auto (p. 56)

You set desired shutter speed, and the camera selects the correct aperture. Freeze the motion of a moving subject or blur the subject.



A: Aperture-Priority Auto (p. 58)

You set the desired aperture, and the camera selects the correct shutter speed. Lets you determine depth of the in-focus area.



M: Manual (p. 60)

Shutter speed and aperture are set manually. Suitable for taking photographs with unique effects.



■ Point-and-shoot exposure mode



AUTO mode (p. 26)

Camera automatically controls all the exposure settings. Suitable for taking pictures right away.



Portrait mode (p. 35)

Use this mode to take portraits. The background is blurred to accentuate your main subject.



Landscape mode (p. 35)

Use this mode to take pictures of distant daytime or nighttime scenes. The overall landscape will be sharply focused.



Close-Up mode (p. 36)

Use this mode to take up-close pictures of subjects such as flowers or insects.



Sports mode (p. 36)

Use this mode to freeze the motion of fast-moving subjects.



Night Portrait mode (p. 37)

Use this mode for subjects with an evening or night background.



Start Shooting Immediately

- 1** Open the battery chamber and install batteries while the camera's power is off (page 16).

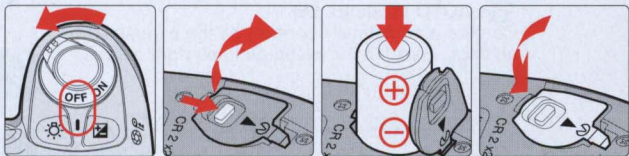

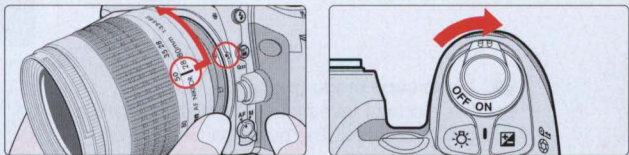

- 2** Attach the lens and turn the power switch on (page 18).

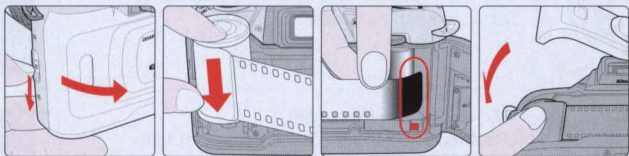

- 3** Open the camera back and install the film (page 20).

- When the camera back is closed, the film is automatically advanced and the number of available exposures is displayed in the LCD panel.



- 4** Set the focus mode selector to AF (autofocus) (page 24), AF Area mode to Dynamic AF Mode with Closest-Subject Priority (page 24) and the exposure mode dial to  (AUTO mode) (page 26).

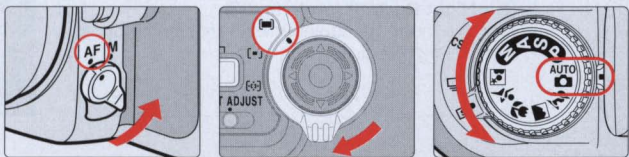

5 Hold the camera properly, compose frame and focus (page 28) by lightly pressing the shutter release button (page 18).

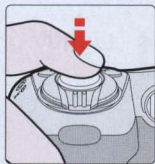

6 Confirm focus indicator ● appears without blinking and in-focus beep sound is emitted, and slowly depress the shutter release button (page 30).

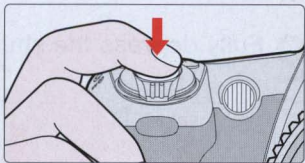

7 Film starts to rewind automatically when it reaches the end of the roll (page 31).

- Make sure **Q** in the viewfinder and **E** in the LCD panel are blinking when removing the film cartridge.

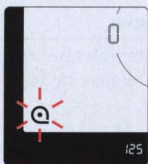
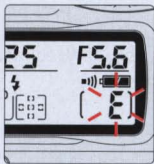
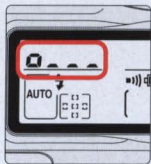

About Shutter Release Button

Lightly pressing the shutter release button and holding it halfway down activates the camera's exposure meter and pressing it all the way down releases the shutter.

1 Lightly press the shutter release button.

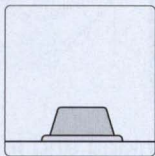

Before pressing



Lightly pressing

- When the focus mode selector is set to AF (autofocus), camera starts to focus on the subject when the shutter release button is lightly pressed (page 28).
- Lightly pressing the shutter release button activates the indications in the LCD panel and viewfinder (for approx. 5 sec. from removal of finger). (See page 17 for information on the exposure meter.)

2 Fully depress the shutter release button.

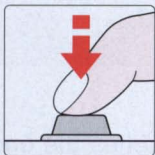

Lightly pressing



Fully
depressing

- Fully depressing the shutter release button releases shutter and film automatically advances to the next frame.

NOTE: Camera shake

Pressing the shutter release button abruptly can result in picture blur. Make sure to press the shutter release button slowly.

PREPARATION

This section introduces the various operations necessary before you start shooting.



- Install batteries and check battery power
- Mount lens
- Load film
- Set date and time (N75QD only)

1

Install Batteries and Check Battery Power

Use two CR2-type 3V lithium batteries.

- 1 Turn the power switch off and open the battery chamber cover by sliding the battery chamber cover lock release lever toward indicated direction.

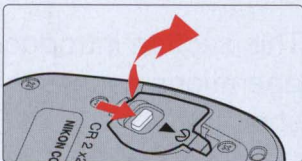
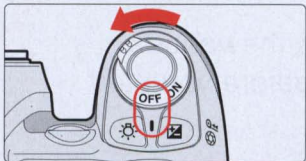

- When replacing batteries, be sure to turn the power switch off and replace both batteries at the same time. Always use fresh batteries of the same brand.

NOTE: Storing batteries

Keep the batteries out of children's reach. If swallowed, contact a doctor immediately. (For "Notes on Batteries", see page 116.)

- 2 Insert batteries with the \oplus and \ominus ends positioned as marked inside the battery chamber, then firmly close the battery chamber cover.

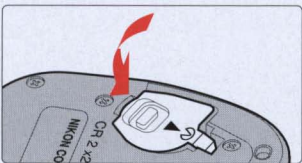
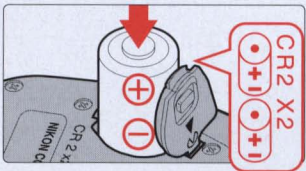

- Make sure to firmly close the battery chamber cover until it locks into place.
- Incorrect positioning of \oplus and \ominus poles may damage the camera.

Check points

- We recommend that you take spare batteries with you, especially when travelling.
- For the number of film rolls that can be shot with fresh batteries, see page 128.



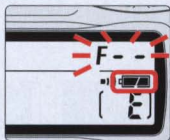

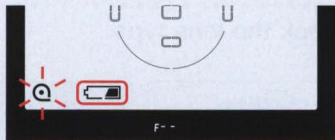

3 Turn the power switch on and confirm battery power with the indication.





Sufficient battery power



Insufficient battery power

LCD panel	Viewfinder		Meaning
	Camera's meter on	Camera's meter off	
 (appears)	No indication	No indication	Sufficient battery power.
 (appears)	 (appears)	No indication	Batteries are nearing exhaustion. Have a fresh set ready. (Viewfinder indications turn off when exposure meter is off.)
 (blinks)	 (blinks)	 (appears)	Batteries are exhausted. Replace batteries. (Shutter locks.)

-  in the viewfinder disappears when the power is off.
-  blinks in the viewfinder when the film is not loaded.

CUSTOM 2 : Warning indications in the viewfinder can be set not to appear (p. 74).

Lightly press the shutter release button to activate the exposure meter.

Lightly pressing the shutter release button reactivates the exposure meter and indications in the LCD panel and viewfinder. Shutter speed and aperture (F - - when lens is not attached) indications in the LCD panel automatically turn off 5 sec. after removing your finger from the shutter release button. (All indications in the viewfinder turn off.) See page 14 for information on the shutter release button.

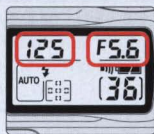

CUSTOM 8 : The duration of inactive time before automatic meter switch-off occurs can be set to 3, 10 or 20 sec. (p. 75).

- When the power switch is turned off with batteries installed, the frame counter display remains on in the LCD panel

2

Mount Lens

Turn the power switch off and mount the lens to the camera body.

1 Check the lens type.

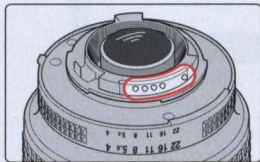

CPU contacts of CPU Nikkor lens

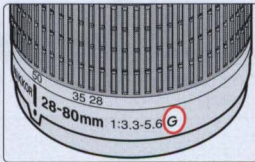

① G-type Nikkor lens

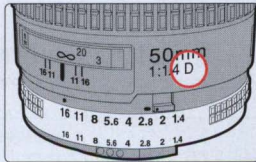

② CPU Nikkor lens other than G-type

- ① G-type Nikkor lens, without aperture ring
- ② CPU Nikkor lenses other than G-type (Illustration is D-type Nikkor lens), with aperture ring

G-type Nikkor lens

The G-type Nikkor lens has no aperture ring; aperture should be selected from camera body. Unlike other CPU Nikkor lenses, aperture does not need to be set to minimum.

Check points

- Use a G- or D-type AF Nikkor lens to utilise all of this camera's functions.
- Make sure to turn the power switch off when attaching/detaching the lens.
- Avoid direct sunlight when attaching/detaching the lens.

NOTE: Non-CPU Nikkor lens

When a non-CPU Nikkor lens is attached and the power switch is turned on, F - - blinks in the LCD panel and viewfinder, and the shutter cannot be released (except in Manual exposure mode). See page 106 for a non-CPU lens.

2 Turn the power switch off and mount the lens to the camera body.

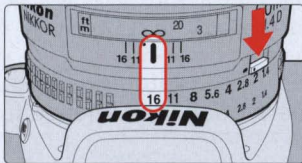
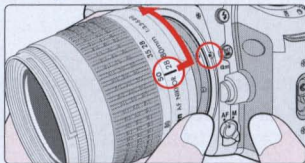

- Position lens in the camera's bayonet mount so that the mounting indexes on lens and camera body are aligned, then twist lens anticlockwise until it locks into place. (Be sure not to touch the lens release button.)
- **With CPU Nikkor lens with aperture ring (other than G-type), set the lens aperture to its minimum and lock.** When the lens is not set to its minimum aperture setting and the power switch is turned on, $f\bar{E}$ blinks in the LCD panel and viewfinder and the shutter cannot be released.

3 Detach the lens.

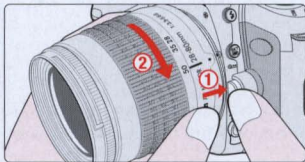

- Push and hold the lens release button, then turn the lens clockwise to detach the lens.

When camera is left unattended without lens

When you leave the camera unattended without a lens attached, be sure to attach the supplied body cap (page 2), or optional body cap BF-1A. (BF-1 body cap cannot be used.)

3 Load Film

Turn the power switch on and load DX-coded film. With DX-coded film, film speed will be set automatically (ISO 25-5000). When the camera back is closed, the film automatically advances and the number of available exposures is displayed in the LCD panel.

1 Turn the power switch on, open the camera back by sliding the camera back lock release lever and load film.

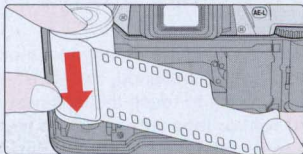
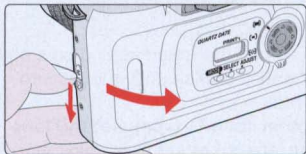

- Film cartridge can be loaded smoothly if inserted from the bottom.
- Make sure to insert the film cartridge all the way in.

2 Pull film leader across to red index mark.

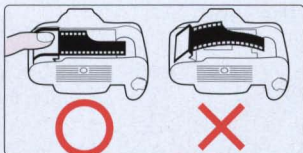
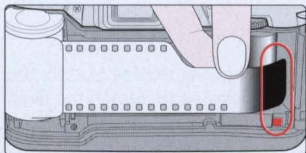

- Make sure to align the film leader to the red index mark; if the film leader is not properly aligned to the index mark (short of or beyond the mark), film may not be loaded properly.
- Hold the film cartridge and ensure film is properly positioned with no slack.

NOTE: Loading/removing film

Shutter curtains are very thin. Do not touch the shutter curtains with your finger or the film leader.



3 Gently close the camera back until the camera back snaps closed.

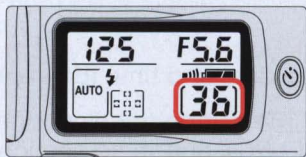
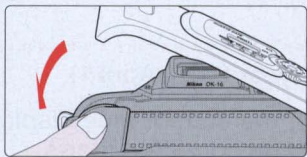

- The film automatically advances to the final frame with blinking α , α ., α .., α ... as indicated in the LCD panel, and film rewinds one frame at a time as photos are taken. The LCD panel indicates number of exposures left on film.
- When the film has completed set up, a shutter sound is let out but no picture has been taken.
- When E appears in the LCD panel, or Err and E in the LCD panel and \square in the viewfinder blink, film is not properly installed. Open the camera back again and reload film by aligning the film leader to the red index mark. \square blinks in the viewfinder when the film is not loaded.
- Pictures taken on frames beyond the indicated number of the exposures for the film roll may be discarded in the process of developing.

CUSTOM 2 : Warning indications in the viewfinder can be set not to appear (p. 74).

DX-coded film

With DX-coded film, film speed will be set automatically between ISO 25 to ISO 5000. Film speed is set to ISO 100 with non-DX-coded film.

DX-coded film

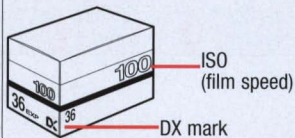

Check points

- Avoid direct sunlight when changing film outdoors.
- You can check the number of available exposures on the film roll and film speed through the film confirmation window.
- Infrared films cannot be used with this camera since an infrared sensor is used for the detection of the film frame position.

4

Set Date and Time (N75QD only)

This camera allows you to imprint Year/Month/Day, Day/Hour/Minute (24-hour clock), Month/Day/Year or Day/Month/Year on your picture in any exposure mode. (For imprinting date/time, see page 42.)

■ Adjusting date and time (Example: year 2003, April 1)

- 1 Push **MODE** button to select one of the date or time displays. Push **SELECT** button so section to be corrected starts blinking.

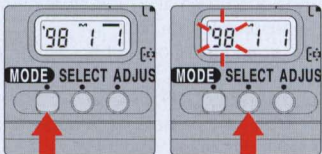

- Date cannot be set in Day/Hour/Minute display. To set date, select Year/Month/Day, Month/Day/Year or Day/Month/Year.
- Set the time in Day/Hour/Minute display.

- 2 Push **ADJUST** button to change the blinking numbers and after correction, push **SELECT** button until the numbers stop blinking.

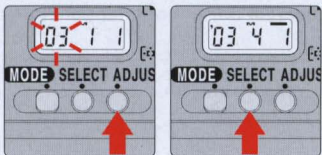

- Each time you push the **ADJUST** button, year section moves up from 98 to 49 (back to 98 after 49).
- To change the numerical indication rapidly, hold the **ADJUST** button down for more than 1 sec.
- Push **SELECT** button until the date/time display stops blinking. When the imprint indicator  appears in the data imprint LCD panel, the setting is complete.

Quartz Date power source

Batteries in the camera body also power the quartz date. Set the date and time after installing batteries for the first time. When changing batteries, date and time remain in the quartz date memory up to approx. 30 minutes without batteries. If the date and time data are lost, reset them. Note that the time the data remains in the memory becomes shorter at low temperatures.

BASIC OPERATION 1

This section features the settings for most common picture-taking situations using AUTO mode (AUTO) to enable easy operation even for beginners.



Shooting modes/functions explained in this section are as follows:

Lens attached	G-type AF Nikkor (p. 18)
Focus mode	AF (autofocus) (p. 24)
Focus area	Dynamic AF Mode with Closest-Subject Priority (p. 24)
Exposure metering system	25-segment 3D Matrix Metering* (p. 26)
Exposure mode	AUTO mode (AUTO) (p. 26)
Flash sync mode	Front-Curtain Sync (F/FR)* (p. 92)
Film advance mode	Single frame (S) (p. 79)
Custom setting	Default (initial) settings (p. 72)

* Automatically set when AUTO mode is selected.

1

Set Focus Mode and AF Area Mode

Set focus mode to AF (autofocus) and AF Area mode to Dynamic AF Mode with Closest-Subject Priority. (See pages 44 and 46 for details.)

1 Turn the power switch on and set the focus mode selector to AF (autofocus).

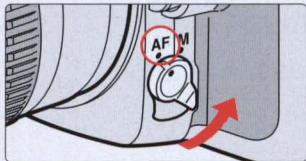

- Make sure to turn the focus mode selector until it clicks into position.
- To focus, lightly press the shutter release button (page 14).

NOTE: AF focus mode

Do not rotate the lens focusing ring manually when the focus mode selector is set to AF.

2 Set the AF Area mode selector to [■].

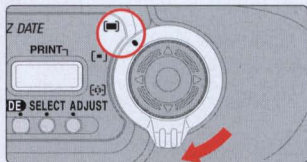

- When the focus mode is set to AF (p. 36) and AF Area mode selector is set to [■] (except Close-Up mode), Dynamic AF Mode with Closest-Subject Priority is selected.
- Dynamic AF Mode with Closest-Subject Priority automatically focuses on the subject located closest to any of five focus areas (page 46). If the subject moves from the selected focus area, the camera automatically focuses on the subject determining the data from the other focus areas.

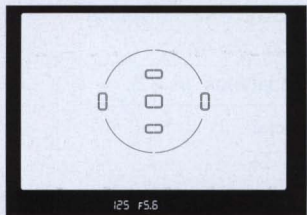

■ Situations where autofocus may not work as expected

Autofocus may not work as expected in the following situations. In such situations, focus manually using the clear matte field (page 45) or focus on a different subject located at the same distance, use focus lock (page 52) then recompose.

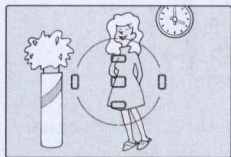

Low-contrast scenes

For example, where the subject is wearing clothing the same color as a wall or other background.



Scenes with subjects within the focus brackets located at different distances from the camera

For example, when photographing an animal in a cage or a person in a forest.

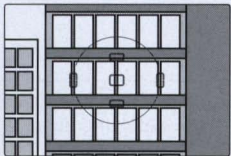

Patterned subject or scene

For example, building windows.

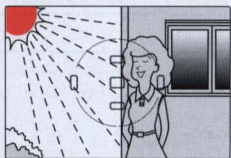



Scenes with pronounced differences in brightness within the focus brackets

For example, when the sun is in the background and the main subject is in shadow.

2

Set Exposure Mode to

When the exposure mode is set to , the camera automatically controls all the exposure settings.

Set exposure mode to .

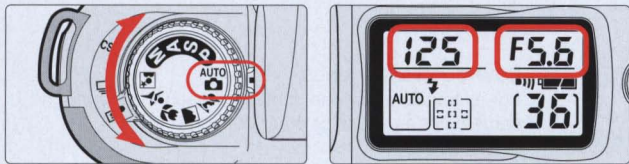

- When the shutter release button is lightly pressed, shutter speed and aperture are indicated in the LCD panel and viewfinder.
- When the exposure mode is set to , **Matrix Metering** is automatically selected.

Matrix Metering (page 32)

The Matrix Meter employed in the N75/N75QD uses a 25-segment sensor to achieve superior metering results even in extremely complex lighting conditions.

The microcomputer analyses data including scene brightness and contrast—and subject distance when you use a G- or D-type Nikkor lens (**3D Matrix Metering** is performed)—and makes the calculations necessary to assure correct exposure. This camera automatically selects Matrix Metering in all exposure modes except Manual exposure mode (page 60). Center-Weighted Metering is selected in Manual exposure mode.

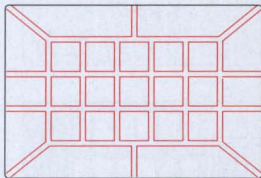







Check point

In  mode, Flexible Program (p. 55), Exposure Compensation (p. 64), Auto Exposure Bracketing (p. 66), Multiple Exposure (p. 69), Slow Sync (p. 92), Rear-Curtain Sync (p. 93) and Red-Eye Reduction with Slow Sync (p. 93) cannot be set.

■ About exposure mode

Four exposure modes besides  and five Vari-Program modes are available with this camera. Utilising the characteristics of each exposure mode, effective results can be achieved with various types of subjects or shooting situations. And the five Vari-Program modes enable you to easily choose proper exposure controls by simply selecting the desired mode for various shooting situations.

See each reference page for operating instructions and details.

Symbol	Exposure mode	Characteristics/Shooting situations
	AUTO p. 26	The easiest exposure mode for general shooting. Camera controls shutter speed and aperture automatically depending on the subject's brightness—allowing you to freely take pictures, concentrating only on the shutter release opportunity.
Vari-Program	 Portrait p. 35	Use this mode to take portraits. The background is blurred to accentuate your main subject.
	 Landscape p. 35	Use this mode to take pictures of distant scenes. The overall landscape will be sharply focused. This mode is also suitable for capturing nighttime or twilight scenes.
	 Close-Up p. 36	Use this mode to take up-close pictures of subjects such as flowers or insects. Your close-ups will be taken with an artistically blurred background.
	 Sports p. 36	Use this mode to take sports pictures. Using a fast shutter speed, it freezes the motion of fast-moving subjects to create exciting action photos.
	 Night Portrait p. 37	Use this mode for subjects with an evening or night background. This mode captures all lighting in the scene, including the foreground subject which is illuminated by the flash, and the background.
P	Auto-Multi Program p. 54	Camera controls shutter speed and aperture automatically, while allowing you to make other settings, such as Flexible Program (page 55) or Exposure Compensation (page 64).
S	Shutter-Priority Auto p. 56	You set desired shutter speed, and the camera selects the correct aperture. Freeze the motion of a moving subject using a fast shutter speed or blur the subject using a slower speed.
A	Aperture-Priority Auto p. 58	You set the desired aperture, and the camera selects the correct shutter speed. Lets you determine depth of the in-focus area (page 102), so you can choose whether near or far subjects are in sharp focus, or whether foreground or background is to be blurred.
M	Manual p. 60	Shutter speed and aperture are set manually. Suitable for situations where it is difficult to attain the desired effect using other exposure modes. Long Time exposure is possible with this exposure mode.

3

Hold Camera and Focus



Lightly pressing the shutter release button automatically focuses the camera on the subject.

1 Hold the camera properly.



- Keep your elbow propped against your body for support.
- Stand with one foot forward a half step and keep your upper body still.
- Grasp the camera handgrip with your right hand and use your left hand to cradle the camera (or lens).



NOTE: Camera shake

Camera shake is likely to occur when the camera is not held steady or with slow shutter speed. The built-in Speedlight automatically fires in dark conditions (where slow shutter speed is required) in  or Vari-Program (except for  and ) with this camera but always remember to hold the camera correctly.

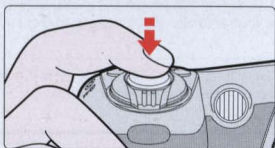
2 Compose frame, center focus brackets on your subject, and focus by lightly pressing the shutter release button.



- Compose frame so that the subject to be focused is located closest at any of five focus areas and lightly press the shutter release button. When the Dynamic AF Mode with Closest-Subject Priority (pages 26, 47) is set, camera automatically maintains focus on the subject located closest to any of five focus areas.
- Lightly pressing the shutter release button automatically focuses the camera on the subject and when the subject is in focus, that focus area is highlighted with Vari-Bright display (p. 9), beep sound is emitted and ● appears in the viewfinder.



- Focus indicator appears or blinks as follows:
 - appears: Subject is in focus.
 - blinks: Unable to focus using autofocus.
- With dark subjects, the camera's AF-Assist Illuminator (page 50) is automatically activated to guide autofocus (except in  or .

CUSTOM  : In-focus beep sound can be set not to be emitted (p. 74).

Check points

- Diopter adjustment (page 82) enables you to see more clearly through the viewfinder.
- To take a picture of a subject outside the focus area, shift the focus area (page 48) or use focus lock (page 52).
- In situations where autofocus may not work as expected, see page 25.

Built-in Speedlight

When the subject is dark or backlit and the shutter release button is lightly pressed, the built-in Speedlight automatically pops up in  or Vari-Program (except in  or ). See page 38 for details.

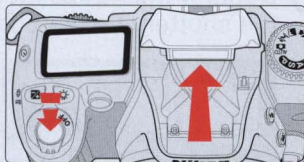

NOTE: Composing frame

The N75/N75QD's viewfinder frame shows approximately 89% of the image actually exposed on the film frame. Therefore, the actual exposed frame is somewhat larger than the image you see through the viewfinder. Note that the edges of a negative film are partially cropped by most labs.

4

Release Shutter

Confirm that ● (in-focus indicator) appears in the viewfinder, then slowly, fully depress the shutter release button. With a moving subject, Continuous Servo AF (page 44) activates and camera continuously focuses on the subject.

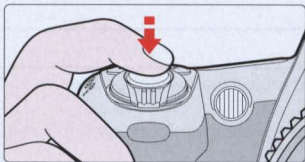

1 Confirm indications in the viewfinder while lightly pressing the shutter release button.

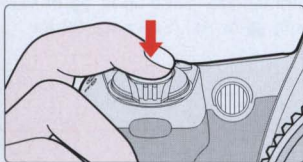

- When the subject is dark or backlit and shutter release button is lightly pressed, the built-in Speedlight automatically pops up and starts charging (pages 38, 95).

2 Confirm that focus indicator ● appears and slowly depress the shutter release button.



- After the shutter is released, the film automatically advances to the next frame and the next shot can be taken.
- When exposures remaining in the film becomes 5 or less,  appears and  blinks for five sec. in the viewfinder.

3 Film starts to rewind automatically when the last shot is taken.

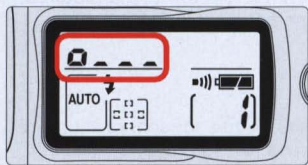

- □, □□, □□□, □□□□, and then □ is displayed during film rewind.

4 Confirm that film is completely rewound, then remove film cartridge.

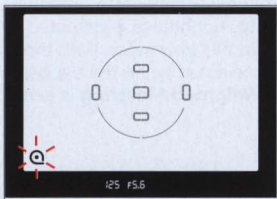
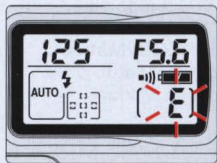

- Film is completely rewound when the frame counter shows blinking **E** in the LCD panel and **Q** in the viewfinder. (**E** appears without blinking and **Q** disappears when the exposure meter is off.) Make sure the film is completely rewound (**E** and **Q** are blinking), open the camera back away from sunlight and remove the film cartridge.

CUSTOM 2 : Warning indications in the viewfinder can be set not to appear (p. 74).

Check points

- If any other warning indications appear, see page 117.
- For mid-roll rewind, see page 78.

About Metering Systems and Exposure

Metering systems and exposure are important factors for taking pictures. Knowing the characteristics of each factor helps you widen your photographic expression.

■ Metering Systems

As the proper combination of shutter speed and aperture for correct exposure is determined according to subject brightness and film sensitivity, measuring subject brightness is very important.

In general, brightness inside the viewfinder is not uniform. The N75/N75QD provides two metering systems: **Matrix Metering** (page 26) and **Center-Weighted Metering** (page 60). With **Matrix Metering**, data on scene brightness is detected by the 25-segment Matrix sensor. Using G- or D-type Nikkor lenses, the N75/N75QD camera performs **25-segment 3D Matrix Metering** by adding distance information to determine correct exposure. With **Center-Weighted Metering**, brightness is detected at the central areas including five focus areas in the viewfinder. With the N75/N75QD, **Matrix Metering** is automatically selected when the exposure mode is set to other than Manual and **Center-Weighted Metering** is selected with Manual exposure mode.

■ Exposure

Light from the subject passes through the lens and exposes the film. Light reaching the film is controlled by the shutter speed and aperture. The proper combination of shutter speed and aperture for subject brightness and film sensitivity results in the correct exposure.

The N75/N75QD's **AUTO** mode (page 26), Auto-Multi Program (page 54) and Vari-Program (page 34) automatically control shutter speed and aperture. Vari-Program gives you the option to choose from Portrait, Landscape, Close-Up, Sports or Night Portrait mode—designed for specific picture-taking situations and photographic images. In Shutter-Priority Auto exposure mode (page 56), you can manually set shutter speed and the camera automatically sets the proper aperture. In Aperture-Priority Auto exposure mode (page 58), you can manually set aperture and the camera automatically sets the proper shutter speed. In Manual exposure mode (page 60), you manually set both shutter speed and aperture.



BASIC OPERATION 2

This section describes the following basic operations:



- Shooting with Vari-Program
- Using Built-In Speedlight
- Self-Timer Operation
- Imprinting Date/Time (N75QD only)

Shooting with Vari-Program

Vari-Program gives you the option to choose from Portrait, Landscape, Close-Up, Sports or Night Portrait mode—designed for specific picture-taking situations and photographic images.

- 1 Set the exposure mode dial to the desired Vari-Program, then lightly press the shutter release button.

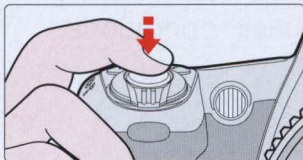

- Center the focus brackets on your subject (where you want the focus) and lightly press the shutter release button. Lightly pressing the shutter release button automatically focuses the camera on the subject and when the subject is in focus, that focus area is highlighted with Vari-Bright display (p. 9), beep sound is emitted and ● appears in the viewfinder.
- When ● is blinking in the viewfinder, the camera is unable to focus using autofocus.

- 2 Confirm that focus indicator ● appears and slowly depress the shutter release button.

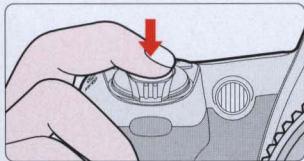

- Shutter speed and aperture are automatically determined to suit the selected Vari-Program and are displayed in the LCD panel and viewfinder.
- When the subject is dark or backlit, the built-in Speedlight automatically pops up and fires (except in 🏠 or 📷).

: Portrait mode

Use this mode whenever you are taking pictures of people. It creates a blurred background to accentuate your main subject.

- 85mm to 200mm telephoto lenses with large maximum apertures are recommended.
- Distancing the main subject and the background emphasises the effect.



: Landscape mode

Use this mode whenever you're taking a picture of a distant scene. The overall picture, whether the subject is near or far, is sharply focused. It also allows you to capture the beauty of nighttime or twilight scenes.

- Built-in Speedlight does not fire even when the subject is dark or backlit.
- In some shooting situations, especially shooting night scenes, slow shutter speed is selected. To avoid camera shake, use a tripod. Use of self-timer or remote control also helps to avoid camera shake.
- A wide-angle lens is suited to capturing a wide view of the landscape.



NOTE: Vari-Program

Flexible Program (page 55), Auto Exposure Bracketing (page 66) and Multiple Exposure (page 69) cannot be performed in Vari-Program. When using the flash in Vari-Program, available Flash Sync modes differ with each program (page 96).

Shooting with Vari-Program—continued



Close-Up mode

Use this mode when you are taking pictures up close. It creates a blurred background to accentuate your main subject. Useful in taking close-ups of subjects such as flowers or insects.

- Dynamic AF Mode with Center-Subject Priority and center focus area are automatically selected (page 46) even when the AF Area mode is set to Dynamic AF Mode with Closest-Subject Priority.
- In some shooting situations, slow shutter speed is selected. To avoid camera shake, use a tripod. Use of self-timer or remote control also helps to avoid camera shake.
- Effect is maximized at minimum focusing distance of the lens in use. When using a zoom lens, use telephoto zoom position.
- For more professional uses, Micro-Nikkor lenses are recommended.

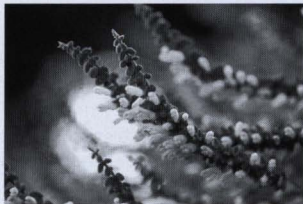

Sports mode

Use this mode to freeze action. It uses a fast shutter speed suitable for stop-action photography. In Sports mode, Continuous Servo AF (page 44) is automatically activated and the camera continues to focus on the subject without Focus lock (page 52).

- Built-in Speedlight does not fire even when the subject is dark or backlit.
- 80mm to 300mm telephoto lenses are recommended.
- Continuous shooting is possible when film advance mode is set to  continuous (p.79).
- Use of ISO 400 or faster film speed is recommended.
- A tripod is recommended when using a telephoto lens to avoid camera shake.





: Night Portrait mode

Use this mode for subjects with an evening or night background. Night Portrait mode captures all the lighting in the scene, including the foreground subject and background.

- Use  Landscape mode for twilight or nighttime scene without foreground subject.
- Use of ISO 400 or faster film speed is recommended.
- To avoid camera shake, use a tripod.



Using Built-In Speedlight

When the subject is dark or backlit and the shutter release button is lightly pressed, the built-in Speedlight automatically pops up in **AUTO** or Vari-Program (except in **M** or **S**). Fully depress the shutter release button to take pictures with the Speedlight.

- 1** When the subject is dark or backlit and the shutter release button is lightly pressed, the built-in Speedlight automatically pops up and starts charging.

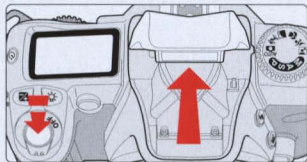



- When the built-in Speedlight is ready to fire, **⚡** appears without blinking in the viewfinder (when the camera's meter is on).
- When you want to take a picture without the flash, close the built-in Speedlight until it clicks shut while lightly pressing the shutter release button. (When the flash is canceled in this manner, as long as the shutter release button is kept lightly pressed, flash is canceled for subsequent shots. When you remove your finger from the shutter release button and shutter release button is lightly pressed again, the built-in Speedlight pops up again and flash starts charging.)
- To cancel the flash, select the Flash Cancel mode (page 93) before lightly pressing the shutter release button.

Built-in Speedlight and Multi-Sensor Balanced Fill-Flash

- The built-in Speedlight offers an angle of coverage of 28mm lens with a guide number of 12 (ISO 100, m). When a wide-angle lens of less than 28mm focal length is used in flash photography using the built-in Speedlight, the flash may not reach the peripheral area and may result in a dark picture.
- Using CPU Nikkor lenses such as a G- or D-type Nikkor lens enables use of **3D Multi-Sensor Balanced Fill-Flash**. Analysing the brightness and contrast level derived from Matrix Metering, the **3D Multi-Sensor Balanced Fill-Flash** ensures proper exposure of the main subject and background, while providing adequate flash output to create natural-looking flash photography. See page 91 for details.

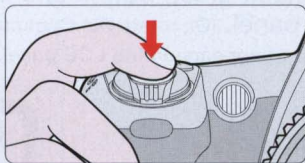
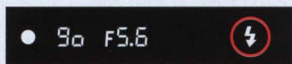
2 Confirm  in viewfinder, then compose, focus and take the picture with flash by fully depressing the shutter release button.



- The shutter cannot be released unless  appears without blinking in the viewfinder.
-  blinks in the viewfinder approx. 3 sec. after full flash output. If this happens, underexposure may have occurred. Check the flash shooting distance range (page 98) and shoot again.
- With dark subjects, the camera's AF-Assist Illuminator is automatically activated to guide autofocus. See page 50 for details.

NOTE: Continuous use of built-in Speedlight





After continuous use of the built-in Speedlight, it may stop firing to protect the firing tube. Wait for a while before using the built-in Speedlight again.

Check points

- Be sure to remove (or store) the lens hood before flash shooting.
- Some lenses have limitations using the built-in Speedlight and may cause vignetting (a shadow may appear within the frame) (page 100).
- Normal Front-Curtain Sync flash mode is introduced in this section. Various flash sync modes are also available. For details, see page 92.

Self-Timer Operation

You can use the self-timer when you want to be in the photograph or reduce camera shake.

- 1** Press  (self-timer) button and confirm that  appears on the LCD panel. (Or, rotate the Command Dial while pressing the  button until  appears on the LCD panel.)

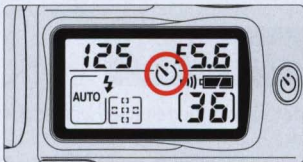

The display changes as follows:

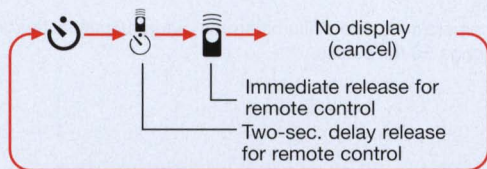





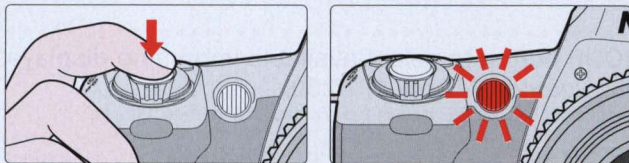

Check points

- Use a tripod or place the camera on a stable surface before using the self-timer.
- To shoot in an exposure mode other than Manual, cover the eyepiece with the supplied eyepiece cap DK-5 (page 82) or with your hand before pressing the shutter release button to prevent interference from stray light and achieve correct exposure.
- Do not stand in front of the lens when setting the self-timer in autofocus mode.

2 Compose picture, focus by lightly pressing the shutter release button and fully depress the shutter release button.



- Self-timer shooting cannot be performed unless the camera's shutter can be released (i.e. when subject cannot be brought into focus with autofocus).
- Once the self-timer is activated, the shutter will release in 10 seconds. The self-timer lamp will blink for 8 sec. and then illuminate for 2 sec. before the shutter is released. During activation of the self-timer, beep sound is emitted.
- Self-timer is canceled after shutter is released.
- When Red-Eye Reduction (page 93) is set, self-timer activates and the self-timer/red-eye reduction lamp lights for 1 sec. before the shutter releases at the same output level as the normal Red-Eye Reduction function.
- To cancel the self-timer mode or the self-timer during self-timer operation, either turn the power switch off, press the  button until  and  disappear from the LCD panel or rotate the Command Dial while pressing the  button until  and  disappear from the LCD panel.

CUSTOM  : Self-timer beep sound can be set not to be emitted (p. 74).

CUSTOM  : The time delay of the self-timer can be set to 2, 5 or 20 sec. (p. 76).

Imprinting Date/Time (N75QD only)

You can imprint the following date information on your picture:
Year/Month/Day, Day/Hour/Minute, Month/Day/Year or Day/Month/Year. See page 22 to set date and time.

1 Push MODE button to select available imprinting displays. (Example: year 2003, April 1, 15:30)

Each time you push the MODE button the display changes as follows:

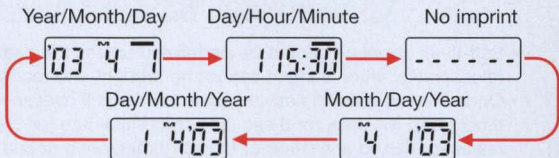
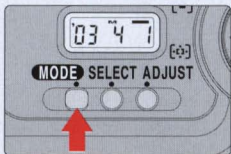

- The data displayed on the data imprint LCD will be imprinted on the picture. Select - - - - - (no imprint) to cancel data imprint. Compatible film speeds for data imprinting are ISO32-3200.

2 Compose picture, focus and fully depress the shutter release button to take a picture with the imprinted date/time.

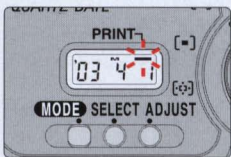

- Data imprint indicator  blinks for approx. two to three sec. immediately after the shutter is released (when film is loaded).

Imprinted date/time

The illustration at right indicates the position of the imprinted date/time on the film. It may be difficult to read against bright colors such as white or reddish hues.



FOCUS OPERATION

This section features detailed descriptions of focusing operations.



- Focus mode
- Focus area mode
- AF-Assist Illuminator
- Focus lock

Focus Mode

Two focus modes, autofocus using the Auto-Servo AF (Single Servo AF and Continuous Servo AF) and Manual focus, are available with the N75/N75QD.

■ Autofocus

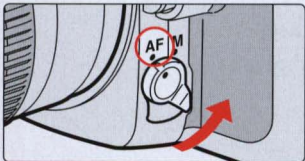

- With the focus mode selector set to **AF**, lightly pressing the shutter release button automatically focuses the camera on the subject at the focus area (page 9/48) and causes ● to appear in the viewfinder.

■ Auto-Servo AF

Camera automatically chooses Single Servo AF or Continuous Servo AF operation according to the subject status, i.e. stationary or moving.

• Single Servo AF

Automatically activated when shooting a stationary subject.

The shutter can be released when the focus indicator ● appears in the viewfinder. Once focused on a subject, keeping the shutter release button lightly pressed locks focus (Focus Lock, page 52). However, if the subject starts moving, Focus Lock is deactivated, and the focus mode automatically switches to Continuous Servo AF.

• Continuous Servo AF

Continuous Servo AF is automatically activated when the subject is moving. The shutter can be released when the focus indicator ● appears in the viewfinder; however, focus is not locked and the camera continues to focus on the subject until shutter release. With a moving subject, Focus Tracking (page 122) is activated and the camera continuously focuses on the subject. Also, N75/N75QD will continue to focus firmly on a main subject with Lock-On™.

- When  Sports mode is selected, Continuous Servo AF is automatically activated and the camera continuously focuses on the subject.

About Lock-On™

Lock-On™ Autofocus keeps focus firmly on a main subject even if some other object momentarily blocks it in the viewfinder.

Manual focus

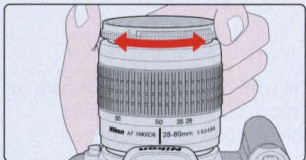
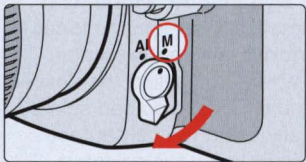

- Set the focus mode selector to **M**. Look through the viewfinder and rotate the lens focusing ring until the image appears sharp on the clear matte field in the viewfinder. The shutter can be released whether or not the subject is in focus and regardless of the focus indicator status.
- Use Manual focus in situations where autofocus may not work as expected (page 25) or with lenses which do not allow autofocus operation when attached to the N75/N75QD (page 104).
- When using a lens with the A-M select function, set the switch/ring to M to focus manually. If M/A (autofocus with manual priority) is available with your lens, Manual focus is possible either with the switch/ring set to M or M/A. See the instruction manual of your lens for details.

Manual focus using Electronic Rangefinder

Set the focus mode selector to **M**. The focus can be confirmed with ● indication in the viewfinder. The Electronic Rangefinder works with most Nikkor lenses (including AF Nikkors when operated manually) having a maximum aperture of f/5.6 or faster. Lightly press the shutter release button and while the meter is on, rotate the lens focusing ring until ● appears in the viewfinder. The shutter can be released anytime. The Electronic Rangefinder can be activated with any of five focus brackets selected as the focus area (pages 9/48).

Focus Area Mode





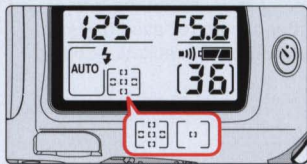
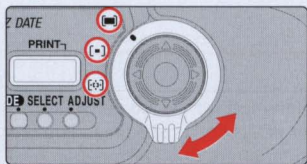

The N75/N75QD's five focus areas cover a wide frame area. When the focus mode is set to **AF** (page 44), you can select either **Dynamic AF Mode with Closest-Subject Priority**, where the camera automatically selects the focus area, **Dynamic AF Mode with Center-Subject Priority**, where the camera selects center focus area, or **Dynamic AF Mode**, where you select the desired focus area. When the focus mode is set to **M** (manual focus), you can select either **Center Area Mode**, where you focus manually using the center focus area, or **Single Area Mode**, where you focus manually using the selected focus area.

Tip

Dynamic AF Mode with Closest-Subject Priority is useful when you want the camera to take automatic control over focus operations, or when shooting a moving subject. Dynamic AF Mode is useful in achieving focus on a particular part of a subject, or when the composition of the photograph is your top priority.

Rotate AF Area mode selector to select AF Area mode.



- When the focus mode is set to **AF** (autofocus), **Dynamic AF Mode with Closest-Subject Priority** is selected with the AF Area mode selector set to  (except in  Vari-Program, p. 36), **Dynamic AF Mode with Center-Subject Priority** is selected with the AF Area mode selector set to , and **Dynamic AF Mode** with the AF Area mode selector set to . When the focus mode is set to **M** (manual focus), **Center Area Mode** is selected with the AF Area mode selector set to either  or , and **Single Area Mode** with the AF Area mode selector set to .
- All five focus areas are displayed in the LCD panel when Dynamic AF Mode with Closest-Subject Priority is selected. When a subject is in-focus, focus brackets located at in-focus subject is highlighted momentarily with the Vari-Bright display (p. 9) in the viewfinder.

■ When focus mode is set to Autofocus

: **Dynamic AF Mode with Closest-Subject Priority**

Dynamic AF Mode with Closest-Subject Priority automatically maintains focus on the subject located closest to any of five focus areas and focus is locked once it is achieved*. The focus area of the subject in focus is highlighted with the Vari-Bright display (p. 9). If the subject moves from the selected focus area, the camera automatically focuses on the subject determining the data from the other focus areas.

: **Dynamic AF Mode with Center-Subject Priority**

Dynamic AF Mode with Center-Subject Priority automatically maintains focus on the subject located at center focus areas and focus is locked once it is achieved*. If the subject moves from the center focus area, the camera automatically focuses on the subject determining the data from the other focus areas. Center focus area is highlighted with the Vari-Bright display (p. 9).



: **Dynamic AF Mode**

Focus is obtained at the selected focus area and focusing is locked (as long as the shutter release button is lightly pressed) once it is achieved*. If the subject moves from the selected focus area, the camera automatically focuses on the subject determining the data from the other focus areas. Selected focus area is highlighted with the Vari-Bright display (p. 9).

* In Continuous Servo AF, focus is not locked and camera continuously focuses on the subject (see page 44).

■ When focus mode is set to Manual

/: **Center Area Mode**

Focus is obtained only at the center focus area when the AF Area mode selector is set to either  or  and when using the manual focus. Center focus area is highlighted with the Vari-Bright display (p. 9).

: **Single Area Mode**

Focus is obtained only at the selected focus area when using the manual focus. Selected focus area is highlighted with the Vari-Bright display (p. 9).

Focus Area Selection

This camera's five focus areas cover a wide frame area, and you can select among them, depending on the subject's position in the frame or your desired composition. They reliably provide sharp focus without use of focus lock (page 52).

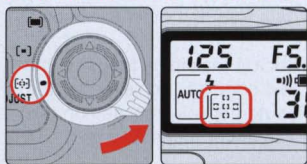

1 Set the AF Area mode selector to [AF-ON].

- Dynamic AF Mode is selected with the focus mode set to autofocus, and Single Area mode is selected with the focus mode set to manual.
- Focus Area selector is locked and focus area cannot be selected when AF Area mode other than [AF-ON] is selected.

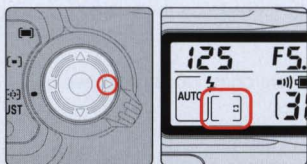



2 Press the focus area selector to select a focus area.

- Lightly press the shutter release button and press the focus area selector up/down/right/left to change the focus area toward the corresponding direction. Selected focus area is highlighted with the Vari-Brite display (p. 9). Selected focus area is also indicated in the LCD panel.







Check points

- When exposure mode is set to  or Vari-Program in autofocus, turning the power switch off and on again resets the focus area to the center. When exposure mode is set to **P, S, A** or **M**, or in manual focus, selected focus area remains.
- When exposure mode is changed within  and any of Vari-Program, or changed to  or Vari-Program from **P, S, A** or **M** in auto focus, focus area resets to the center. When exposure mode is changed within **P, S, A** and **M** in autofocus, or in manual focus, selected focus area remains.
- Select the focus area while exposure meter is on. Focus area cannot be selected when exposure meter is off.

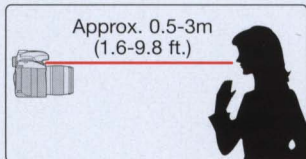
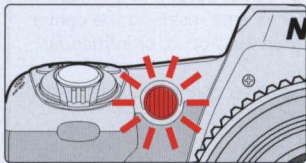
AF-Assist Illuminator

When the subject is dark and the shutter release button is pressed lightly, the camera's AF-Assist Illuminator automatically turns on and enables autofocus operation in a dark environment.



- AF-Assist Illuminator automatically turns on in the following situations:
Focus mode is autofocus, AF Nikkor lens is used, subject is dark and center focus area is selected or Dynamic AF Mode with Closest-Subject Priority is activated.
 - AF-Assist Illuminator does not turn on in  or .
 - Focal length of the usable AF Nikkor lens is 24-200mm.
 - The distance range of the AF-Assist Illuminator is approx. 0.5-3m (1.6-9.8 ft.). Autofocus using the camera's AF-Assist Illuminator cannot be performed due to vignetting with some lenses at a shooting distance less than 1m (page 51).
 - When the optional Speedlight with AF-Assist Illuminator is attached and the conditions for the AF-Assist Illumination are met, the AF-Assist Illuminator of the optional Speedlight automatically turns on. With other optional Speedlights, the camera's Illuminator turns on (page 109).
- CUSTOM**  : AF-Assist Illuminator can be canceled (p. 76).

NOTE: Continuous use of the AF-Assist Illuminator

When the AF-Assist Illuminator is used continuously, illumination is limited temporarily to protect the firing tube. The illumination restarts after a few moments. Also, when the AF-Assist Illuminator is used repeatedly in a short period of time, be careful not to touch the AF-Assist Illuminator lamp because it may become hot.

NOTE: Lenses incompatible with AF-Assist Illuminator

- Autofocus using the camera's AF-Assist Illuminator cannot be performed with following lenses at a shooting distance within 1m (3.3 ft.) due to vignetting.
 - AF Micro 200mm f/4 IF-ED
 - AF-S 17-35mm f/2.8 ED
 - AF 18-35mm f/3.5-4.5 ED
 - AF 20-35mm f/2.8 IF
 - AF 24-85mm f/2.8-4 IF
 - AF 24-120mm f/3.5-5.6 IF
 - AF Micro 70-180mm f/4.5-5.6 ED
- Autofocus using the camera's AF-Assist Illuminator cannot be performed with following lens at a shooting distance within 1.5m (4.9 ft.) at telephoto due to vignetting.
 - AF-S 28-70mm f/2.8 IF-ED at 70mm (usable at approx. 1m [3.3 ft.] or longer shooting distance at wideangle)
- Autofocus using the camera's AF-Assist Illuminator cannot be performed with following lenses due to vignetting.
 - AF-S 80-200mm f/2.8 IF-ED
 - AF 80-200mm f/2.8 ED
 - AF VR 80-400mm f/4.5-5.6 ED

Focus Lock

Focus lock is useful in autofocus shooting when you want to capture a subject that's framed outside of the N75/N75QD's five focus areas.



Tip

Focus lock is best suited for a photograph where composition is your top priority, and in situations where autofocus may not work as expected (page 25).

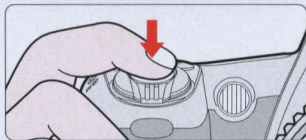
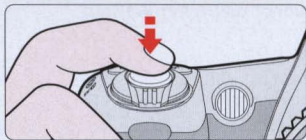

1 Position the focus area on the subject and lightly press the shutter release button. (For example, when center focus area is selected.)

- ● appears when the subject is in focus and the focus is locked as long as the shutter release button is kept lightly pressed.
- Focus lock cannot be used in .
- Focus is not locked with a moving subject. To lock focus on a stationary subject which has been moving, remove your finger from the shutter release button and lightly press the shutter release button again.

2 Confirm focus indicator ●, compose while lightly pressing the shutter release button and shoot.

- After you have locked focus, do not change the camera-to-subject distance.

EXPOSURE MODE

This section describes how to take pictures in each exposure mode.



- Auto-Multi Program
- Shutter-Priority Auto
- Aperture-Priority Auto
- Manual

Auto-Multi Program



P: Auto-Multi Program

The camera automatically controls exposure to achieve correct exposure in any shooting situation. For more complex shooting, use Flexible Program (page 55), Exposure Compensation (page 64) or Auto Exposure Bracketing (page 66).

- **P** (Auto-Multi Program) can only be used with a CPU Nikkor lens such as G- or D-type Nikkor (page 104).



Tip

Auto-Multi Program is best suited for snapshots.

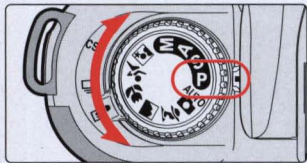

1

Set the exposure mode dial to **P**.

NOTE: CPU Nikkor lenses other than G-type



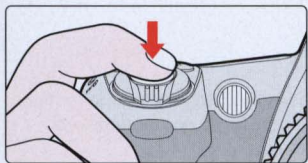

Always set the aperture ring of a CPU Nikkor lens (except G-type) to its minimum (largest f-number). When the lens is not set to its minimum aperture setting, **fE E** blinks in the LCD panel and viewfinder, and the shutter locks.

Difference between (AUTO mode) and P (Auto-Multi Program)

Although exposure controls are the same, with Auto-Multi Program, you can select functions such as Flexible Program, Exposure Compensation, Auto Exposure Bracketing, Multiple Exposure (page 69) or Slow Sync flash (page 92) for more flexible shooting. In Auto-Multi Program, however, the built-in Speedlight does not pop up automatically with a dark or backlit subject.



2 Compose picture, confirm focus indicator ● and shoot.

- When the subject is too dark or too bright, one of the following warning indications will appear in the viewfinder and LCD panel.
 -  : Use ND filter (optional).
 -  : Use Speedlight.
- If the subject is too dark or backlit, the flash recommended indication  blinks in the viewfinder when you lightly press the shutter release button. Use the Speedlight (pages 95/107).

Flexible Program

By rotating Command Dial in Auto-Multi Program, you can change the combination of shutter speed and aperture while maintaining correct exposure. With this function, you can shoot in Auto-Multi Program as though shooting in Shutter-Priority Auto or Aperture-Priority Auto. To cancel the Flexible Program, either change the exposure mode, turn off the power switch, or use the built-in Speedlight (page 95).

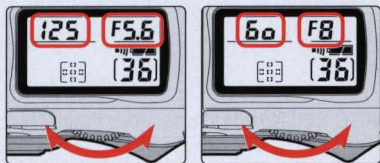

Shutter-Priority Auto Exposure Mode



Fast shutter speed 1/500 sec.



Slow shutter speed 1/4 sec.

S: Shutter-Priority Auto

Enables you to manually set the desired shutter speed (30-1/2000 sec.); the camera automatically selects the proper aperture to provide correct exposure.

- **S** (Shutter-Priority Auto) can only be used with a CPU Nikkor lens such as G- or D-type Nikkor (page 104).



Tip

With high shutter speeds, you can freeze the motion of a fast-moving subject; with slower speeds, you can create a motion effect.

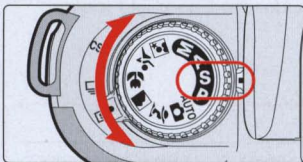

1 Set the exposure mode dial to S.

NOTE: CPU Nikkor lenses other than G-type

Always set the aperture ring of a CPU Nikkor lens (except G-type) to its minimum (largest f-number). When the lens is not set to its minimum aperture setting, **FE** blinks in the LCD panel and viewfinder, and the shutter locks.

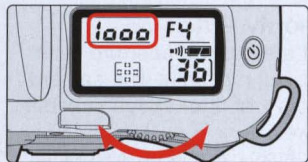

2 Set the shutter speed (30-1/2000 sec.) with the Command Dial.

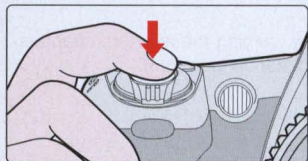

3 Compose picture, confirm focus indicator ● and shoot.

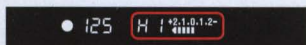

Overexposure

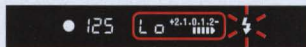

Underexposure

- When the subject is too dark or too bright, one of the following warning indications will appear in the viewfinder and LCD panel. (Over- or underexposure value is indicated with the electronic analog exposure display in the viewfinder.)

- **H**: Select higher shutter speed. If the warning indication still remains on, use an ND filter (optional).

- **L**: Select slower shutter speed. If the warning indication still remains on, use the Speedlight. When the Speedlight is used, fastest shutter speed is limited to 1/90 sec.

- If the subject is too dark or backlit, the flash recommended indication  blinks in the viewfinder when you lightly press the shutter release button. Use the Speedlight (pages 95/107).

Check point

- If -- (Long Time exposure) is selected in Manual exposure mode and the exposure mode is changed to Shutter-Priority Auto without cancelling --, -- blinks and the shutter locks. To shoot in Shutter-Priority Auto exposure mode, select shutter speed other than -- by rotating the Command Dial.

Aperture-Priority Auto Exposure Mode

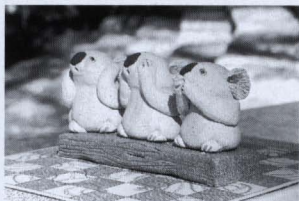

Small aperture f/32

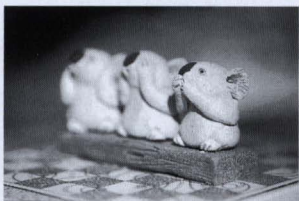

Large aperture f/2.8

A: Aperture-Priority Auto

Enables you to set the desired aperture (lens' minimum to maximum) manually. The camera automatically selects a shutter speed suitable for correct exposure.

- **A** (Aperture-Priority Auto) can only be used with a CPU Nikkor lens such as G- or D-type Nikkor (page 104).
- In flash photography, varying the aperture changes the flash shooting distance (page 98).



Tip

By varying the aperture, and thus controlling the depth of field (page 102), you can sharpen the background and foreground, or blur the background.

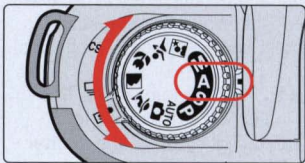

1

Set the exposure mode dial to **A**.

NOTE: CPU Nikkor lenses other than G-type

Always set the aperture ring of a CPU Nikkor lens (except G-type) to its minimum (largest f-number). When the lens is not set to its minimum aperture setting, **fEE** blinks in the LCD panel and viewfinder, and the shutter locks.

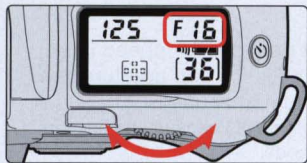

2 Set the aperture (lens' minimum to maximum) by rotating the Command Dial.

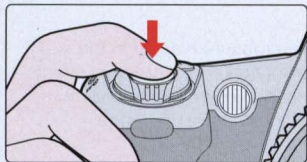

3 Compose picture, confirm focus indicator ● and shoot.

- When the subject is too dark or too bright, one of the following warning indications will appear in the viewfinder and LCD panel. (Over- or underexposure value is indicated with the electronic analog exposure display in the viewfinder.)



Overexposure

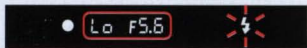

Underexposure

- **H** **f**: Select smaller aperture (larger f-number). If the warning indication remains on, use an ND filter (optional).
- **L** **o**: Select larger aperture (smaller f-number). If the warning indication remains on, use the Speedlight.
- If the subject is too dark or backlit, the flash recommended indication  blinks in the viewfinder when you lightly press the shutter release button. Use the Speedlight (pages 95/107).

Manual Exposure Mode



M: Manual

Enables you to set both shutter speed (- - [Time] and 30-1/2000 sec.) and aperture (lens' minimum to maximum) manually.

- Non-CPU lenses (page 106) can only be used in Manual exposure mode.



Tip

With electronic analog exposure display in the viewfinder, you can produce various creative effects by adjusting the exposure. Long Time exposure (Time) can be set in Manual exposure mode.



1 Set the exposure mode dial to M.

- Metering system automatically switches to **Center-Weighted** from Matrix in Manual exposure mode.
- When a non-CPU Nikkor lens is attached, F- appears in the LCD panel and viewfinder. Set/confirm aperture with the lens aperture ring. Camera's exposure meter cannot be used. See page 106 for details.

Center-Weighted Metering

Center-Weighted Metering places special emphasis on brightness within the 12mm-diameter circle in the viewfinder and is thus useful for basing exposure on a specific area of the scene.

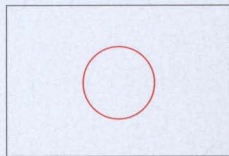





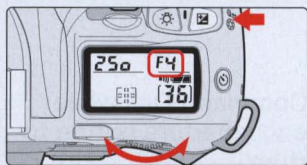
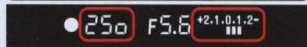
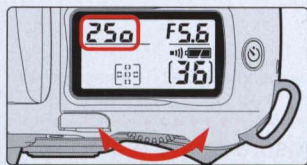

NOTE: CPU Nikkor lenses other than G-type

Always set the aperture ring of a CPU Nikkor lens (except G-type) to its minimum (largest f-number). When the lens is not set to its minimum aperture setting, **F E** blinks in the LCD panel and viewfinder, and the shutter locks.



2 Set the shutter speed and aperture while checking the electronic analog exposure display in the viewfinder.

- Set the shutter speed (- - [Time] and 30-1/2000 sec.) by rotating the Command Dial and aperture (minimum to maximum) by rotating the Command Dial while pressing the  aperture button.
- The electronic analog display in the viewfinder indicates the difference between the selected exposure (shutter speed and aperture) and the correct exposure. The electronic analog exposure display blinks when the subject brightness is beyond the camera's exposure range. (Electronic analog exposure display is not available with Long Time exposure.) The following examples show electronic analog exposure display indications:

	Over 2 EV
	+1 EV
	Correct exposure
	-1/2 EV
	Under -2 EV

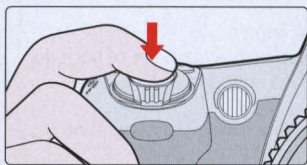

3 Compose picture, focus and shoot.

- If the subject is too dark or backlit, the flash recommended indication  blinks in the viewfinder when you lightly press the shutter release button. Use the Speedlight (pages 95/107).

Long Time Exposure

■ Long Time (Time) exposure of more than 30 sec.

When the exposure mode dial is set to M (Manual), set the shutter speed indication to -- (next after 30 sec.) to set Long Time (Time) exposure. Depress the shutter release button once to open the shutter, then press the shutter release button again to close the shutter. This function is useful for shooting nighttime scenes or stars.

Tip

In Long Time exposure, camera shake can be reduced by using the Self-Timer (page 40) or Remote Control (page 84) and tripod.

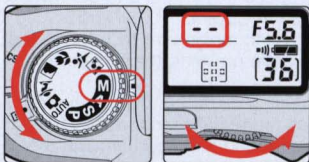

1 Set the exposure mode dial to **M** and rotate the Command Dial to set the shutter speed indication to --.

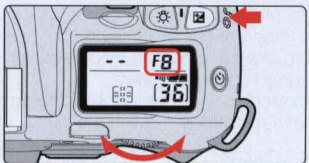

2 Rotate the Command Dial while pressing the  aperture button to set the aperture.

3 Compose picture, focus and shoot.

- Depressing the shutter release button once opens the shutter and the self-timer lamp flickers slightly during Long Time (Time) exposure.
- -- and other indications such as aperture are displayed in the LCD panel, but all the indications turn off in the viewfinder.
- Press the shutter release button again to close the shutter.
- Continuous exposure is possible for approx. 4 hours with a fresh set of batteries. Note that continuous exposure time is reduced when shooting at low temperatures.
- Auto Exposure Bracketing (page 66) cannot be performed during Long Time (Time) exposure.

ADVANCED OPERATION

This section features descriptions of operations using the N75/N75QD's advanced functions.



- Exposure Compensation
- Auto Exposure Bracketing
- Multiple Exposure

Exposure Compensation

To modify exposure control (i.e. from the ISO standard), use the Exposure Compensation function. This can be useful when intentionally achieving under- or overexposure to obtain a specific photographic effect. This camera offers compensation of -3 EV to $+3$ EV in $1/2$ steps.

- Exposure Compensation can be set in **P**, **S**, **A** and Vari-Program.

Tip

Compensate to the $+$ side to brighten, and the $-$ side to darken overall picture to obtain the specific photographic effect you desire.

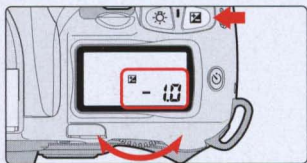

Electronic analog exposure display

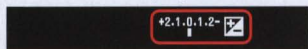

No compensation

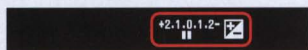

+0.5 EV compensation

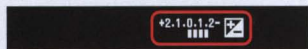

-1.5 EV compensation

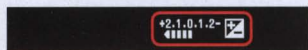

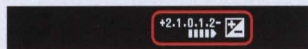

Over +2.0 EV compensation



Under -2.0 EV compensation

- 1 Set Exposure Compensation by rotating the Command Dial while pressing the  button until the desired compensation value appears (-3 EV to $+3$ EV in $1/2$ steps).

- When the Exposure Compensation is set,  appears in the LCD panel and viewfinder.
- The compensation value can be checked in the LCD panel and viewfinder by pressing the  button. (Confirm the compensation value between -2 EV to -3 EV and $+2$ to $+3$ EV in the LCD panel.)

NOTE: Setting Exposure Compensation

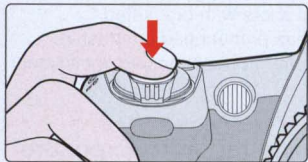

Normally, you should compensate exposure to the + side when the background is brighter than your main subject, or to the - side when the background is darker.



2 Compose picture, confirm focus indicator ● and shoot.

- To cancel Exposure Compensation, rotate the Command Dial while pressing the  button to reset the compensation value to 0.0. In Vari-Program, changing the exposure mode also cancels the Exposure Compensation. (Turning the power switch off does not cancel the Exposure Compensation.)

Check points

- The Exposure Compensation cannot be set in  or **M** exposure mode.
- Once the Exposure Compensation is set in each **P**, **S** or **A** exposure mode, compensation remains in that exposure mode. Changing the exposure mode to **M**,  or Vari-Program temporarily cancels the compensation.
- Exposure Compensation set in Vari-Program is canceled when exposure mode is changed.
- In any of the exposure modes, both flash output level for the flash illuminated subject and exposure on the background are bracketed when a Speedlight is used.

Auto Exposure Bracketing

Auto Exposure Bracketing allows you to shoot in selected compensated EV values (maximum of ± 2 EV) shifting from the automatically set proper exposure (or selected exposure in Manual exposure mode) for three shots each time the shutter is released.

- Auto Exposure Bracketing is available in **P**, **S**, **A** and **M** exposure modes.

Tip

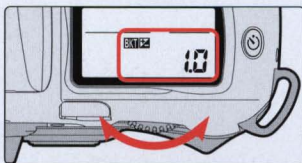
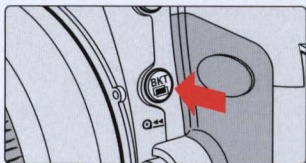

Bracketing is useful in selecting one shot out of several shots with bracketed exposures after processing the film, when the subject has pronounced contrast in shooting with color slide film and where the latitude of the proper exposure is minimal.

- 1 Rotate the Command Dial while pressing the Auto Exposure Bracketing  button to set desired bracketing value (within ± 2 EV without combining exposure compensation).



The display changes as follows:



- When the bracketing value is set (and while the exposure meter is on), **BKT** appears and  blinks in the LCD panel, and  and electronic analog exposure display blink in the viewfinder.
- Bracketing value can be confirmed by pressing the  button.
- Shutter speed and aperture in P, aperture in S and shutter speed in A and M exposure mode are bracketed.
- In any of the exposure modes, both flash output level for the flash illuminated subject and exposure on the background are bracketed when a Speedlight is used.

■ Compensated EV value and bracketing order

Compensated EV value	Bracketing order
0.5	0, -0.5, +0.5
1.0	0, -1.0, +1.0
1.5	0, -1.5, +1.5
2.0	0, -2.0, +2.0

CUSTOM 3 : Bracketing order can be set to change from negative EV value to positive EV value (p. 74).

2 Compose picture, confirm focus indicator ● and shoot.

- Each time the shutter release button is depressed, correct EV, under EV, and over EV exposure are performed in that order while the blinking electronic analog exposure display shows the correct, under-, then overexposure. Compensated shutter speed and aperture values are displayed during shooting.

Auto Exposure Bracketing—continued

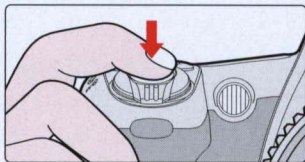

- If the Exposure Compensation function (page 64) is also set, bracketing will be combined with the Exposure Compensation values. It is useful to perform Bracketing with a compensated value of over +2 EV or under -2 EV (maximum of ± 5 EV).
- If the end of the film roll is reached during bracketing, the remaining shots can be taken after new film has been loaded. Also, if you turn the power switch off during bracketing, the remaining shots can be taken after the power is turned back on.

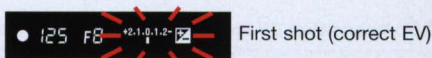

Electronic analog exposure display
(Example: bracketing value 1.0, in **A** mode)



3 Auto Exposure Bracketing is completed and automatically canceled when the third shot is taken.

- **BKT** and  in the LCD panel and  and the electronic analog exposure display in the viewfinder disappear when the bracketing is completed.
- To cancel the bracketing, rotate the Command Dial while pressing the  button so **BKT** disappears from the LCD panel. Turning the power switch off does not cancel bracketing.



Check points

- Auto Exposure Bracketing cannot be performed in  and Vari-Program.
- Auto Exposure Bracketing and Multiple Exposure (page 69) cannot be set simultaneously.
- Auto Exposure Bracketing and Long Time exposure (page 62) cannot be set simultaneously.

Multiple Exposure

Multiple Exposure consists of two or more exposures of one or more subjects in the same frame.

- Multiple Exposure can be set in **P**, **S**, **A** and **M** exposure modes.

1 Rotate the Command Dial while pressing the multiple exposure  button so  appears in the LCD panel. The display changes as follows:

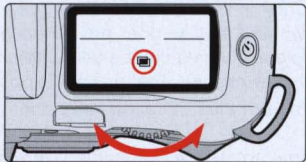
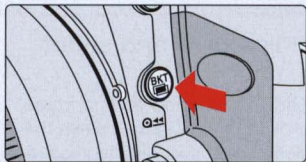

-  appears in the LCD panel when the Multiple Exposure is set.

2 Rotate the Command Dial while pressing the  button to set the necessary Exposure Compensation.

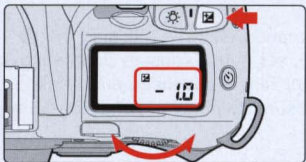

- Test shooting is recommended since the compensation actually required varies depending on the shooting situation.
- When the background is completely dark and subjects do not overlap, no compensation is necessary for each shot.
- In some cases, frames may shift slightly in multiple exposure. In particular, film advance becomes unstable at the beginning and near the end of a film roll so multiple exposure is not recommended.

Multiple Exposure—continued

Standard compensation value in multiple exposure

Number of exposures	Compensation value
Two	-1.0 EV
Three	-1.5 EV
Four	-2.0 EV
Eight or nine	-3.0 EV





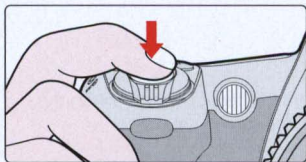

Exposure Compensation is necessary depending on the number of exposures in multiple exposure since more than one image is exposed in the same frame.

3 Compose picture, confirm focus indicator ● and shoot.



- The first shot is taken and  and frame counter blink in the LCD panel when the shutter release button is fully depressed. The frame counter in the LCD panel does not count down and the film does not advance, and multiple exposures can be taken from the second shutter release. The multiple exposure

is canceled, film advances and  disappears from the LCD panel when the second shot is taken.

- To take more than two shots on the same frame, rotate the Command Dial while pressing the  button again after the first shot is taken by depressing the shutter release button and while  is blinking so  appears without blinking. Repeat this operation as many times as you wish to continue taking pictures on the same frame.
- To cancel multiple exposure, rotate the Command Dial while pressing the  button so  disappears from the LCD panel, set Auto Exposure Bracketing, or set the exposure mode to  or Vari-Program. Film is advanced and frame counter counts down when the multiple exposure is canceled before or during multiple exposure operation.

Check points

- Multiple Exposure cannot be performed in  or Vari-Program.
- Multiple Exposure and Auto Exposure Bracketing (page 66) cannot be set simultaneously.

CUSTOM SETTING

Using the Custom Setting feature, you can create a combination of functions that is different from the initial factory settings. The functions listed in this section can be selected with the N75/N75QD.

Menu/Features of Custom Setting

■ Creating Custom Setting

- 1 Set the Custom Setting selector to **CSM** and select a menu number by rotating the Command Dial.

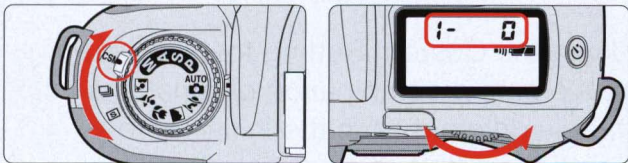

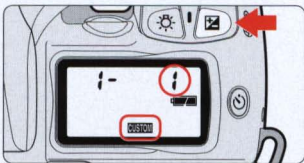

- 12 menus (i- 1 to i- 12) are available.

- 2 Select the desired option number by pressing the **Fn** button.



- The option number changes as you press the **Fn** button.
- When the option number other than initial setting is displayed in the LCD panel, **CUSTOM** appears in the LCD panel. Rotate the film advance mode/Custom Setting selector to set desired film advance mode.
- The shutter cannot be released when the film advance mode/Custom Setting selector is set to **CSM**. Set the dial to the desired film advance mode before shooting.

■ Cancelling Custom Setting

Set the Custom Setting selector to **CSM** and press the  and  buttons simultaneously for more than two sec.

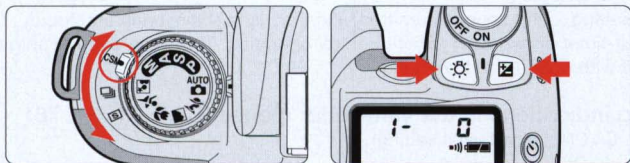

- All the Custom Settings are canceled and reset to their initial factory settings. **CUSTOM** disappears from the LCD panel.
- Each Custom Setting can be canceled and reset to initial setting by selecting the number of “initial setting” (e.g. 0 with Custom Setting menu number 1) at step 2 of the “Creating Custom Setting”.

Menu/Features of Custom Setting—continued

■ Menu number and Custom Setting options

* Refer also to the Custom Setting Menu table at the end of this instruction manual.



1. Beep sound (pages 28, 41, 84)

Options: : Activated (initial setting)
i: Disabled

At initial setting, beep sound is emitted when focus is achieved in autofocus, during self-timer or two-sec. remote control operation. This beep sound can be turned off with option *i* in this menu.

2. Warning indications in the viewfinder (pages 9, 17, 21, 31, 78)

Options: : Displayed (initial setting)
i: Off

At initial setting, when battery power is low, no film is loaded, or film is not loaded properly, warning indications such as  or  appear in the viewfinder. However, these warning indications can be turned off.

3. Bracketing order (page 67)

Options: : Metered value, under, over (initial setting)
i: Under, metered value, over

Bracketing is normally performed in the order of the initial setting. However, this Bracketing order can be changed to be performed from negative compensation to positive compensation.

4. Focus area illumination (page 9)

Options: : Automatically illuminated for low light (initial setting)
i: Canceled
2: Always illuminated

At initial setting, selected focus area (focus brackets) in the viewfinder is temporarily illuminated in red depending on the subject brightness for easy identification. However, it can be set not to be illuminated or always illuminated regardless of the subject brightness.

5. Auto Exposure Lock when shutter release button is lightly pressed (page 80)

Options: **0**: Disabled (initial setting)
1: Activated

At initial setting, Auto Exposure Lock can be performed by pressing the **(AE-L)** button. However, Auto Exposure can be set to be locked by lightly pressing the shutter release button.

6. AE-L button (pages 52/80)

Options **0**: Auto Exposure lock only (initial setting)
1: AE/AF simultaneous lock
2: AF operation only starts by pressing **(AE-L)** button

At initial setting, only Auto Exposure is locked when the **(AE-L)** button is pressed. However, Auto Exposure and autofocus can be set to be locked simultaneously. Also at initial setting, autofocus starts when the shutter release button is lightly pressed, but it can be set to activate when the **(AE-L)** button is pressed. (In this setting, pressing the shutter release button lightly does not start autofocus.)

7. Metering system in the Auto Exposure lock (page 80)

Options: **0**: Center-Weighted (initial setting)
1: Matrix
2: Spot

At initial setting, the exposure metering system automatically changes to Center-Weighted Metering when Auto Exposure lock is performed. However, it can be set to Matrix or Spot Metering.

8. Time delay for auto meter-switch-off (page 17)

Options **3**: 3 sec.
5: 5 sec. (initial setting)
10: 10 sec.
20: 20 sec.

Note that the usable number of film rolls per batteries decreases with the longer delay time for auto meter-switch-off since it consumes more power.

Menu/Features of Custom Setting—continued

9. Self-timer duration (page 40)

Options 2 : 2 sec.

10 : 10 sec. (initial setting)

5 : 5 sec.

20 : 20 sec.

10. Standby duration for the remote control operation (page 84)

Options 1 : 1 min. (initial setting)

5 : 5 min.

10 : 10 min.

11. LCD illuminates by pressing any function button (page 8)

Options 0: Disabled (initial setting)

1: Activated

At initial setting, pressing the  button activates the LCD illuminator. However, it can be set to be activated with a press of any button.

12. AF-Assist Illuminator activation (page 50)

Options 0: Activated (initial setting)

1: Disabled

Note that AF-Assist Illuminator of the optional Speedlight cannot be turned off with this option.

OTHER FUNCTIONS

This section describes other useful camera functions and information.









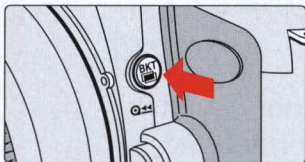



- Film rewind
- Film advance mode
- Diopter adjustment
- Viewfinder accessories
- Available mode combinations

Film Rewind

This section explains mid-roll rewind and what to do if the film does not rewind.





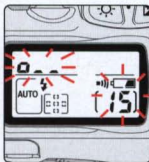

Mid-roll rewind

- To rewind film at mid-roll, press the two film rewind  buttons simultaneously for approx. 1 sec. Shutter sound is let out and film rewind will start.
- , ,  and then  appear in the LCD panel during film rewind and the frame counter counts backwards until rewind is complete.
- Film is completely rewound when a blinking  shows in the LCD panel and  in the viewfinder. ( appears without blinking and  disappears when the exposure meter is off.) Make sure  and  are blinking, open the camera back away from sunlight and remove the film cartridge.



If film does not start to rewind or film rewind stops at mid-roll

- When battery power is very low, or at low temperatures, film may not start rewinding or film rewind may stop at mid-roll, and , frame number and insufficient battery power indication  will blink in the LCD panel, and  and  will blink in the viewfinder. In this case, turn the power switch off, change batteries, then turn the power switch on to rewind film again. (The frame counter display does not change until camera back is opened once and closed again after removing the film cartridge.)

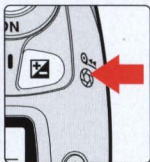
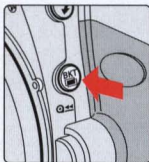

CUSTOM 2 : Warning indications in the viewfinder can be set not to appear (p. 74).

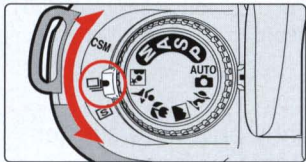

Film Advance Mode

Two film advance modes, single-frame and continuous shooting are available with the N75/N75QD.



Set the film advance mode selector to  or .

: Single-frame shooting

Fully pressing the shutter release button takes one picture and automatically advances the film by one frame.

: Continuous shooting

Shots are taken continuously at the rate of up to approx. 1.5 fps as long as you keep the shutter release button fully pressed.

Continuous shooting cannot be performed in flash photography.

Film advance speed is tested using camera settings of focus mode M, exposure mode M, shutter speed 1/125 sec. or faster, aperture other than maximum, at normal temperature of 20°C/68°F, with fresh batteries, for the 1st to 36th frames of a film.

Auto Exposure Lock

When you want to control the exposure of a specific area within a scene, measure the exposure on that area and press the **(AEL)** button to lock the exposure, then recompose the picture. This function is useful when there is a pronounced difference between the brightness of an area you want to set the exposure on and the area surrounding it. Set exposure to a mode other than Manual.

- 1** Position focus area on subject and lightly press the shutter release button, then press the **(AEL)** button. Confirm focus indicator ● appears in the viewfinder.

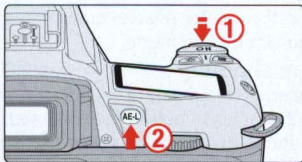
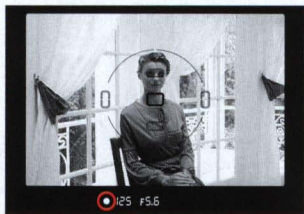

- When the **(AEL)** button is pressed, Center-Weighted metering is automatically selected and exposure at the 12mm-diameter circle at center of frame is locked and remains locked as long as the button is kept pressed.
- **CUSTOM 7** : Metering system in the Auto Exposure lock can be changed (page 75).
- At initial setting, the exposure metering system automatically changes to Center-Weighted Metering when Auto Exposure lock is performed. However, it can be set to Matrix or Spot Metering using the Custom Setting.
- When Spot Metering is selected, exposure on the 4mm-diameter area within the focus brackets (approx. 1% of the total frame) is measured. Note that the measured focus area differs with the AF Area mode selected.
 - When Dynamic AF Mode with Closest-Subject Priority (p. 47) or Dynamic AF Mode with Center-Subject Priority or Center Area Mode (p. 47) is selected: Exposure on the center focus area is measured.
 - When Dynamic AF Mode or Single Area Mode is selected (p. 47): Exposure on the selected focus area is measured.

2 While keeping the **AE-L** button pressed, recompose, focus and shoot.

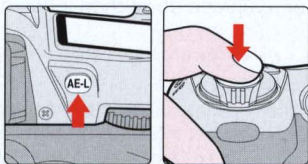

CUSTOM 5 : Auto Exposure Lock can be set to be activated by lightly pressing the shutter release button (p. 75).

CUSTOM 6 : Auto Exposure Lock and Autofocus lock can be set to be activated simultaneously by pressing the **AE-L** button (p. 75).

NOTE: When AF operation with **AE-L button is selected with the Custom Setting (p. 75)**

When option **2** in the Custom Setting menu **6** is selected, Auto Exposure cannot be locked by pressing the **AE-L** button. To lock exposure, set the option other than **2** in the Custom Setting menu **6**, or select option **1** in Custom Setting menu **5** to activate Auto Exposure Lock by lightly pressing the shutter release button.

Dioptr Adjustment/Viewfinder Accessories

The N75/N75QD enables near- or far-sighted photographers to adjust the eyepiece diopter to suit their vision. Viewfinder accessories such as an eyepiece cap or eyepiece correction lens can also be attached.

Dioptr adjustment

- Remove the rubber eyecup and slide the diopter adjustment lever while looking through the viewfinder until the focus brackets or other displays in the viewfinder appear sharp. Attach the rubber eyecup again after adjustment.
- The adjustable range of the finder diopter is -1.5m^{-1} to $+0.8\text{m}^{-1}$. Nine optional eyepiece correction lenses provide a viewfinder diopter range of -5m^{-1} to $+3\text{m}^{-1}$ (page 112).

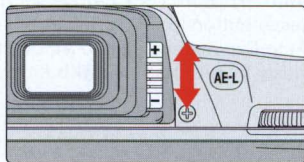
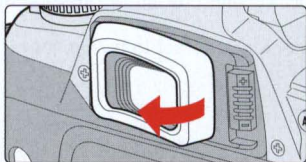

NOTE: Using the diopter adjustment lever

Since the diopter adjustment lever is located next to the viewfinder, be careful not to poke yourself in the eye with your finger or fingernail while sliding the lever.

Attaching viewfinder accessories

- To attach the eyepiece cap DK-5 or eyepiece correction lens, remove the rubber eyecup and slide down the eyepiece cap or eyepiece correction lens.
- To reattach the rubber eyecup after removing the DK-5 or eyepiece correction lens, make sure the “**Nikon** DK-16” stamp is at the bottom.

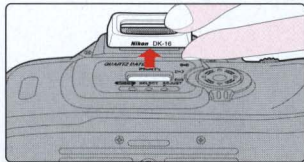
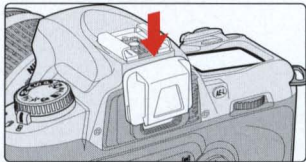

Depth-of-Field Preview

Electronic preview function is available with this camera. Depress the depth-of-field preview button to confirm the depth of field through the viewfinder (see page 102).

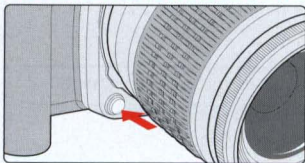

- Pressing the depth-of-field preview button stops the lens down to the aperture controlled in  (AUTO mode), Vari-Program, Auto-Multi Program or Shutter-Priority Auto exposure mode, and down to the aperture selected in Aperture-Priority Auto or Manual exposure mode. By looking through the viewfinder, the approximate depth of field with the given aperture can be confirmed.

Check point

Electronic preview function is executed when CPU Nikkor lens is attached. It cannot be performed with non-CPU lenses (p. 106).





Remote Control Operation (optional)

Use the optional remote control to release the camera's shutter from a distance. As with self-timer operation, the remote control can also be used when you want to be in the photograph. You can also use the remote control instead of a cable release to reduce camera shake.

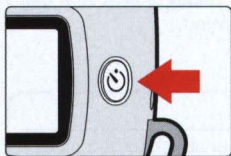
NOTE: Before using the remote control





When using the remote control for the first time, make sure to pull out the insulation sheet placed on the battery inside the remote control unit that is set when purchased.

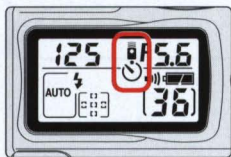

- 1** Press the  remote control button a number of times so  (immediate release) or  (two-sec. delay release) appears in the LCD panel. (Or, rotate the Command Dial while pressing the  remote control button.)

The display changes as follows:







- You can choose to release the shutter either immediately after () or two sec. after () the shutter release button on the remote control unit is pressed.
- Once remote control operation is set, the camera remains ready to receive a signal from the remote control unit for 1 min. If no signal is sent for 1 min., the remote control mode is canceled and  or  disappears from the LCD panel.
- The remote control cannot be operated unless the camera's shutter can be released (i.e. when subject is not in focus with autofocus).
- After the shutter is released, the camera remains ready to receive another signal from the remote control unit for 1 minute.

CUSTOM I3 : Standby duration for the remote control operation can be changed to 5 or 10 min. (p.76).



2 Point the remote control unit toward the camera and press the shutter release button.

- When immediate release is selected, the self-timer lamp lights after shutter release (except when the Speedlight is used). When Red-Eye Reduction (page 93) is also set, the self-timer lamp lights at the same output level as the normal Red-Eye Reduction before the shutter releases and the flash fires when the shutter is released.
- The shutter is released after the self-timer lamp lights for approx. 2 sec. in two sec. delay mode. When Red-Eye Reduction (page 93) is also set, the self-timer lamp lights at the same output level as the normal Red-Eye Reduction after the self-timer lamp lights for approx. 2 sec. and the flash fires when the shutter is released.
- To cancel the remote control operation, press the  button again or rotate the Command Dial while pressing the  button so  or  disappears from the LCD panel. Or, turn the power switch off.
- To cancel the remote control operation after the shutter release button is pressed and before shutter release, turn the power switch off or press the  button.

Focusing in remote control operation

Two methods to shoot with autofocus with remote control:

1. Autofocus activated by signal from remote control:
Shutter is released when (or two sec. after) the subject is in focus. However, when focus cannot be achieved, it remains in standby mode.
2. Autofocus activated by lightly pressing shutter release button on the camera body before remote control operation:
Lightly press the shutter release button on the camera body while the remote control is standing by to achieve focus. Once focus is achieved, focus is locked (even though the finger is removed from the shutter release button). Shutter is released when (or two sec. after) the shutter release signal is received from the remote control unit. The focus remains locked until remote control is canceled.

Remote Control Operation (optional)—continued

Check points

- Use a tripod or place the camera on a stable surface before using the remote control.
- When you are taking pictures but not looking through the viewfinder, cover the eyepiece with the supplied eyepiece cap DK-5 (page 82) or with your hand before pressing the shutter release button to prevent interference from stray light and achieve correct exposure.
- The shooting distance for remote control operation is within 5m directly in front of the camera. To shoot beyond the shooting distance of the remote control, use the self-timer (page 40). Remote control operation cannot be performed when the camera has extreme backlighting. Change the camera position in this case.
- If the shutter cannot be released with the remote control, change the battery inside the remote control unit (page 87). (The life of the battery inside the remote control unit is approx. 5 years.)
- Use one 3V CR2025 lithium battery in the remote control unit.

Long Time (Time) exposure with remote control

When the camera is set to Long Time (Time) exposure (page 62), pressing the remote control's shutter release button opens the camera's shutter and pressing the shutter release button again closes the shutter. This function is useful for shooting nighttime scenes or stars. (Use of a tripod is recommended.) Self-timer lamp flickers slightly once every 2 sec. during Time exposure.

■ Changing battery inside the remote control unit

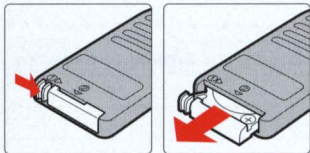

1 While keeping the battery holder release lever pressed as the arrow on the remote control unit indicates to release the lock, pull out the battery holder from the remote control unit.

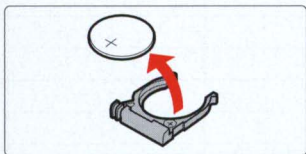

2 Remove the used battery.

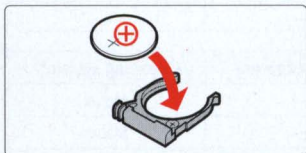

3 Insert a new CR2025 3V lithium battery with ⊕ side facing up.

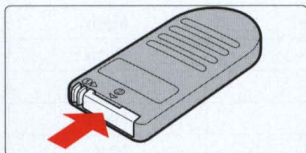







4 Insert the battery holder until it clicks shut.







NOTE: Storing batteries

Keep batteries out of children's reach. If swallowed, contact a doctor immediately. (For "Notes on Batteries", see page 116.)

Available Mode Combinations

The following chart lists available modes when a CPU Nikkor lens such as a G- or D-type lens is attached.

Exposure mode	AF-Assist Illuminator	Flexible Program	Exposure compensation
 AUTO	○	—	—
	○	—	○
	—	—	○
	○	—	○
	—	—	○
	○	—	○
P	○	○	○
S	○	—	○
A	○	—	○
M	○	—	—

Exposure mode	Auto Exposure Bracketing	Multiple exposure	Metering system*
 AUTO	—	—	Matrix
	—	—	Matrix
	—	—	Matrix
	—	—	Matrix
	—	—	Matrix
	—	—	Matrix
P	○	○	Matrix
S	○	○	Matrix
A	○	○	Matrix
M	○	○	Center-Weighted

○: Available

—: Unavailable

* Automatically set when the exposure mode is selected.

FLASH PHOTOGRAPHY



This section introduces various aspects of flash photography using the built-in Speedlight.



- Built-in Speedlight (Automatic Balanced Fill-Flash with TTL Multi Sensor, Standard TTL Flash)/Ready-light
- Flash sync mode features
- Using built-in Speedlight

Built-In Speedlight/Ready-Light

■ Built-in Speedlight and TTL Flash modes

This camera is equipped with a built-in Speedlight that provides an angle of coverage for a 28mm lens with a guide number of 12/39 (ISO 100, m/ft.). When the subject is dark or backlit, in **Auto** or Vari-Program (except in  or ) , the built-in Speedlight automatically pops up. When the shutter is released, the flash fires to create natural-looking flash photography utilising **3D Multi-Sensor Balanced Fill-Flash** or **Multi-Sensor Balanced Fill-Flash**. In **P**, **S**, **A** or **M** exposure mode, when the subject is dark or backlit, flash recommended indication  blinks in the viewfinder, and the Speedlight pops up when the Speedlight lock-release button is pressed and the **3D Multi-Sensor Balanced Fill-Flash** or **Multi-Sensor Balanced Fill-Flash** is possible. (In **M** exposure mode, **Standard TTL Flash** is selected.) In addition to shooting in dim light, the flash can be used in daylight to reduce shadows on the main subject or to put catchlights in your subject's eyes. Five flash sync modes—**Front-Curtain Sync** (Normal Sync), **Slow Sync**, **Rear-Curtain Sync**, **Red-Eye Reduction** and **Red-Eye Reduction with Slow Sync**—are available with this camera.

- See below for the TTL Flash modes, page 95 for using the built-in Speedlight and page 92 for the flash sync modes.

.....

■ The following TTL Auto Flash modes are available with built-in Speedlight depending on the type of lens used.

Lens	TTL Auto Flash mode
D- or G-type Nikkor lens	3D Multi-Sensor Balanced Fill-Flash*1 (with Distance Information and Monitor Pre-Flash*2)
CPU Nikkor lens other than D/G-type (except AF Nikkor for F3AF)	Multi-Sensor Balanced Fill-Flash*1 (with Monitor Pre-Flash*2)
Non-CPU Nikkor lens	Standard TTL*3

*1 When built-in Speedlight is used and the exposure mode is set to Manual, TTL Auto Flash mode automatically changes to Standard TTL Flash.

*2 To cancel Monitor Pre-Flash, select Manual exposure mode.

*3 Monitor-Pre Flash is not fired in Standard TTL Flash.

3D Multi-Sensor Balanced Fill-Flash



- 3D Multi-Sensor Balanced Fill-Flash is automatically set in , Vari-Program, **P**, **S** or **A** exposure mode with D- or G-type Nikkor lens attached. In this flash mode, just after you press the shutter release button and before the shutter is activated, the built-in Speedlight will fire a series of imperceptible pre-flashes that are detected by the N75/N75QD's five-segment TTL Multi Sensor, then analysed for brightness and contrast. Furthermore, it integrates

Distance Information from the lens with other exposure control information, automatically compensating the flash output level so that flash output and ambient light are balanced. 3D Multi-Sensor Balanced Fill-Flash enables flash photography in very difficult situations, such as a scene that includes an object with extremely high reflectivity or a subject against an "infinite" background (empty sky, clouds, etc.).

Multi-Sensor Balanced Fill-Flash

- Multi-Sensor Balanced Fill-Flash, without the Distance Information added to the 3D Multi-Sensor Balanced Fill-Flash, can be performed with a combination of the N75/N75QD camera and CPU Nikkor lens other than D/G-type.



3D Multi-Sensor Balanced Fill-Flash together with Multi-Sensor Balanced Fill-Flash is called Automatic Balanced Fill-Flash with TTL Multi Sensor

Standard TTL Flash

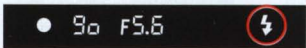

- Standard TTL Flash is automatically selected when the exposure mode is set to **M**. In Standard TTL Flash, the main subject is correctly exposed but background exposure is not considered. Standard TTL Flash is useful when you want to highlight the main subject.

Ready-light





- When using the built-in Speedlight or an optional Speedlight (p. 107), the ready-light  appears in the viewfinder when the Speedlight is fully charged and ready to fire.
- If the ready-light  blinks approx. 3 sec. after full flash output, underexposure may have occurred. Check the focus distance, aperture or flash shooting distance range (p. 98) and shoot again.

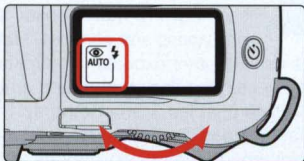
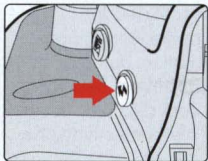

Flash Sync Mode Features

Five flash sync modes can be selected for desired photographic effect depending on the conditions when using the built-in Speedlight. In  and  modes, flash is not available even when the subject is dark or backlit.



Set the flash sync mode by rotating the Command Dial while pressing the flash sync mode button .





 /  : **Front-Curtain Sync (Normal Sync)**

Set the flash sync mode to Front-Curtain Sync for normal flash photography. The camera's shutter speed is automatically set between 1/60-1/90 sec. for flash photography in  or , and to 1/90 sec. in , **P** or **A** exposure mode.



 /  : **Slow Sync**

Slow Sync can be used in , **P** or **A** exposure mode. Normally, the camera's shutter speed is automatically set to 1/90 sec. for flash photography. However, for shooting nighttime scenes, Slow Sync uses a slower shutter speed (down to maximum of 30 sec., 1 sec. in ) to bring out background details using all of the available light. To avoid camera shake, use a tripod. Use of self-timer also helps to avoid camera shake.







/ : Rear-Curtain Sync

Rear-Curtain Sync can be used in **P**, **S**, **A**, or **M** exposure mode. Normally, the Speedlight fires at the end of the exposure, turning available light into a stream of light that follows the flash-illuminated moving subject. When Rear-Curtain Sync is set in **P** or **A** exposure mode, Slow Sync is automatically set. (With an optional Speedlight SB-26, 25 and 24, set the Speedlight's sync mode selector to REAR.)



/ : Red-Eye Reduction





The Red-Eye Reduction lamp lights for approx. 1 sec. before the flash fires in order to reduce the red-eye effect in photos of people or animals. Red-Eye Reduction can be used in  ^{AUTO}, Vari-Program (except for ,  and ) , **P**, **S**, **A**, or **M** exposure mode.





/ : Red-Eye Reduction with Slow Sync

Red-Eye Reduction with Slow Sync can be used in  ^{AUTO}, **P** or **A** exposure mode. Red-Eye Reduction and Slow Sync mode are simultaneously set.

: Flash Cancel

Flash Cancel can only be selected in  ^{AUTO} or Vari-Program (except for  and ) with the Command Dial and  button. Set Flash Cancel when you want to cancel the flash and have the photograph exposed only with the natural light. Flash Cancel cannot be set when the built-in Speedlight is in the up position. Set the Flash Cancel before lightly pressing the shutter release button.

- If  or  is set when the built-in Speedlight is in the up position, flash is automatically canceled.
- To cancel Flash Cancel, turn camera power off, change the exposure mode or turn attached optional Speedlight on.



Flash Sync Mode Features—continued

NOTE: Flash Sync Modes

- In Front- and Rear-Curtain Sync, shutter speed shifts automatically to 1/90 sec. when the shutter speed is set to faster than 1/90 sec. in S or M exposure mode. In this case, **90** is displayed in the LCD panel and the viewfinder.
- When Red-Eye Reduction or Red-Eye Reduction with Slow Sync is selected, the Red-Eye Reduction lamp lights for approx. 1 sec. before the flash fires. Do not move the camera or let the subject move until the shutter is released. (Red-Eye Reduction is not recommended in shooting situations where shutter release is your top priority.)
- With some lenses, light from the Red-Eye Reduction lamp may not reach the subject's eyes. In some cases, the red-eye effect may not be sufficiently reduced due to the location of the subject.
- With Slow Sync and Red-Eye Reduction with Slow Sync, keep the camera steady to prevent picture blur since the shutter speed is slow. Use of a tripod is recommended.

Using Built-In Speedlight



This section explains how to use the built-in Speedlight set to desired flash sync mode when a G- or D-type AF Nikkor lens is attached.

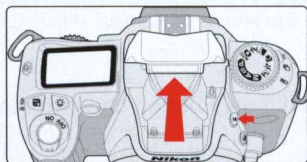



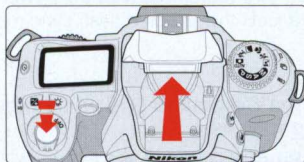



- 1 In **P**, **S**, **A** or **M** exposure mode, release the built-in Speedlight by pressing the  flash lock-release button. In **AUTO** or Vari-Program (except in  or ) , when the subject is dark or backlit and the shutter release button is lightly pressed, the built-in Speedlight automatically pops up.



In **P**, **S**, **A** or **M** exposure mode



In **AUTO** or Vari-Program
(except  or )

- When the subject is dark or backlit and shutter release button is lightly pressed, the flash recommended indication  blinks in the viewfinder in **P**, **S**, **A** or **M** exposure mode. To use built-in Speedlight, press the  flash lock-release button.
- In **AUTO**,  or ,  is displayed in the LCD panel; in ,  is displayed.
- When the Speedlight is ready to fire,  appears without blinking in the viewfinder (when the camera's meter is on).
- Press the Speedlight down gently until it clicks into place to retract it.

- 2 Set the flash sync mode by rotating the Command Dial while pressing the  flash sync button.

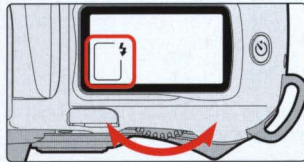
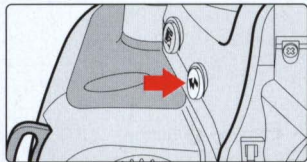

Using Built-In Speedlight—continued

- If or is set when the built-in Speedlight is in the up position, flash is automatically canceled.
- **Multi-Sensor Balanced Fill-Flash** is selected in exposure modes other than **M** and **Standard TTL Flash** is selected for **M** exposure mode. See page 91 for details.
- See the table on pages 97, 98 and 99 for shutter speed and aperture, available sync mode in each exposure mode.
- In **P**, **S**, **A** or **M** exposure mode, selected flash sync mode remains once it is set. To change the flash sync mode, rotate the Command Dial while pressing the button to select another flash sync mode.
- In or Vari-Program, turning the power switch off or selecting another exposure mode cancels the selected flash sync mode and returns to its initial setting (page 99).

■ Rotating the Command Dial while pressing the button changes the display as follows.

In or Vari-Program (except , or):



In :



In **P** or **A** exposure mode:

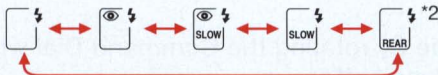

In **S** or **M** exposure mode:

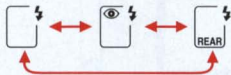



*1 cannot be set when the built-in Speedlight is up.

*2 The display changes to when you leave your finger from the button.





3 Confirm appears in the viewfinder, make sure the subject is within the flash shooting distance range and shoot.



- The shutter cannot be released unless  appears without blinking in the viewfinder.
-  in the viewfinder blinks approx. 3 sec. after full flash output. This may indicate underexposure has occurred. Check the focus distance, aperture or flash shooting distance range and shoot again.
- When the subject is dark, the AF-Assist Illuminator automatically turns on to guide autofocus. See page 50 for details.



■ Available shutter speed and aperture in each exposure mode

- In Front-Curtain Sync, Red-Eye Reduction or Rear-Curtain Sync (in **S** or **M** exposure mode only)

Exposure mode	Available shutter speed	Available aperture	Page
	Automatically set to 1/90-1/60 sec.	Automatically set	26
			35
 *1	Automatically set to 1/90-1/15 sec.		35
	Automatically set to 1/90 sec.		36
 *1			36
P			54
S	1/90-30 sec.*2	Desired setting*3	56
A	Automatically set to 1/90 sec.		58
M	1/90-30 sec.*2, -- (Time)		60

- In Slow Sync, Red-Eye Reduction with Slow Sync or Rear-Curtain Sync (in **P** or **A** exposure mode only)

Exposure mode	Available shutter speed	Available aperture	Page
 *1	Automatically set to 1/90-1 sec.	Automatically set	37
P	Automatically set to 1/90-30 sec.		54
A		Desired setting*3	58

*1 Built-in Speedlight is automatically set to Flash Cancel in  or ; however, optional Speedlight can be used (p. 107).

*2 Shutter speed shifts automatically to 1/90 sec. when the shutter speed is set to faster than 1/90 sec. and the built-in Speedlight pops up.

*3 Flash shooting distance range depends on the ISO speed of the film in use and aperture setting. In **A** or **M** exposure mode, set the aperture according to the flash shooting distance range table on the next page.

Using Built-In Speedlight—continued

■ Flash shooting distance range







Flash shooting distance for the built-in Speedlight changes according to the film speed in use and aperture setting.







ISO film speed	25	50	100	200	400	800	Flash shooting distance range
Guide number m/ft.	6/20	8.5/28	12/39	17/56	24/79	34/112	
Aperture value	—	—	1.4	2	2.8	4	2-8.5m/6.6-27.9 ft.
	—	1.4	2	2.8	4	5.6	1.4-6m/4.6-19.7 ft.
	1.4	2	2.8	4	5.6	8	1-4.2m/3.3-13.8 ft.
	2	2.8	4	5.6	8	11	0.7-3m/2.3-9.8 ft.
	2.8	4	5.6	8	11	16	0.6-2.1m/2.0-6.9 ft.
	4	5.6	8	11	16	22	0.6-1.5m/2.0-4.9 ft.
	5.6	8	11	16	22	32	0.6-1.1m/2.0-3.6 ft.
8	11	16	22	32	—	0.6-0.8m/2.0-2.6 ft.	

- The maximum flash shooting distance can also be calculated by dividing the guide number by the selected aperture value.

Example: When f/2.8 is selected with ISO 100 film using the camera's built-in Speedlight, the maximum flash shooting distance will be: $12/2.8 = \text{approx. } 4.2\text{m}$ or $39/2.8 = \text{approx. } 13.8\text{ ft.}$

Available flash sync mode combinations

Exposure mode	TTL Auto Flash	Front-Curtain Sync	Red-Eye Reduction
	①	⊙	○
	①	⊙	○
	—	—	—
	①	⊙	○
	—	—	—
	①	—	—
P	①	○	○
S	①	○	○
A	①	○	○
M	②	○	○

Exposure mode	Red-Eye Reduction with Slow Sync	Slow Sync	Rear-Curtain Sync	Flash Cancel
	—	—	—	○*1
	—	—	—	○*1
	—	—	—	⊙*2
	—	—	—	○*1
	—	—	—	⊙*2
	○	⊙	—	○*1
P	○	○	○	—
S	—	—	○	—
A	○	○	○	—
M	—	—	○	—

①: 3D Multi-Sensor Balanced Fill-Flash

②: Standard TTL flash

○: Available

⊙: Automatically set when the exposure mode is selected. (Other flash sync mode also selectable.)

—: Unavailable

*1 Selectable when built-in Speedlight is retracted.

*2 Flash is automatically canceled if  or  is selected when built-in Speedlight is up.

Using Built-In Speedlight—continued

■ Usable lenses with built-in Speedlight

28mm to 200mm non-zoom CPU Nikkor lenses, AF 300mm f/4 ED and AF-S 300mm f/4 ED lenses can be used with the built-in Speedlight. Vignetting occurs at the edges of the frame resulting in underexposure with the following lenses, which have limitations in usable focal length or shooting distance.

NOTE: Using built-in Speedlight

- Make sure to remove the lens hood.
- The built-in Speedlight cannot be used with zoom lenses set to Macro in wideangle.
- AF-S 17-35mm f/2.8 ED zoom lens cannot be used with the built-in Speedlight.
- Vignetting is reduced with regular color print film compared to color slide film since the edges of the frame are cropped out in film processing with color print film.

With standard color print film

Lens	Limitations
AF 18-35mm f/3.5-4.5	35mm focal length at 0.7m (2.3 ft.) or longer shooting distance
AF 20-35mm f/2.8	35mm focal length at 1.2m (3.9 ft.) or longer shooting distance
AF 24-85mm f/2.8-4	35mm or longer focal length; and at 35mm, 0.8m (2.6 ft.) or longer shooting distance
AF-S 24-85mm f/3.5-4.5G ED	28mm or longer focal length; and at 28mm, 0.7m (2.3 ft.) or longer shooting distance
AF-S VR 24-120mm f/3.5-5.6G ED	35mm or longer focal length; and at 35mm, 1.2m (3.9 ft.) or longer shooting distance
AF 24-120mm f/3.5-5.6	28mm or longer focal length; and at 28mm, 2.5m (8.2 ft.) or longer shooting distance; at 35mm, 0.8m (2.6 ft.) or longer shooting distance
AF 28mm f/1.4	0.9m (3.0 ft.) or longer shooting distance
AF-S 28-70mm f/2.8 ED	50mm or longer focal length; and at 50mm, 1.2m (3.9 ft.) or longer shooting distance
AF 28-80mm f/3.5-5.6	At 28mm, 0.7m (2.3 ft.) or longer shooting distance
AF 28-100mm f/3.5-5.6G	At 28mm, 1.2m (3.9 ft.) or longer shooting distance
AF 28-200mm f/3.5-5.6	35mm or longer focal length
AF 35-70mm f/2.8	At 35mm, 1.2m (3.9 ft.) or longer shooting distance
AF Micro 70-180mm f/4.5-5.6 ED	At 70mm, 0.7m (2.3 ft.) or longer shooting distance
AF-S VR 70-200mm f/2.8G ED	At 70mm, 3m (9.8 ft.) or longer shooting distance

With color slide film

Lens	Limitations
AF 18-35mm f/3.5-4.5	35mm focal length at 0.9m (3.0 ft.) or longer shooting distance
AF 20-35mm f/2.8	35mm focal length at 2m (6.6 ft.) or longer shooting distance
AF 24-85mm f/2.8-4	35mm or longer focal length; and at 35mm, 1m (3.3 ft.) or longer shooting distance
AF-S 24-85mm f/3.5-4.5G ED	28mm or longer focal length; and at 28mm, 0.7m (2.3 ft.) or longer shooting distance
AF-S VR 24-120mm f/3.5-5.6G ED	35mm or longer focal length; and at 35mm, 1.5m (4.9 ft.) or longer shooting distance
AF 24-120mm f/3.5-5.6	35mm or longer focal length; and at 35mm, 0.9m (3.0 ft.) or longer shooting distance
AF 28mm f/1.4	0.9m (3.0 ft.) or longer shooting distance
AF-S 28-70mm f/2.8 ED	50mm or longer focal length; and at 50mm, 1.5m (4.9 ft.) or longer shooting distance
AF 28-80mm f/3.3-5.6G	At 28mm, 0.8m (2.6 ft.) or longer shooting distance
AF 28-100mm f/3.5-5.6G	At 28mm, 2m (6.6 ft.) or longer shooting distance
AF 28-105mm f/3.5-4.5	At 28mm, 0.7m (2.3 ft.) or longer shooting distance
AF 28-200mm f/3.5-5.6	35mm or longer focal length
AF 35-70mm f/2.8	At 35mm, 2m (6.6 ft.) or longer shooting distance
AF Micro 70-180mm f/4.5-5.6 ED	At 70mm, 0.7m (2.3 ft.) or longer shooting distance
AF-S VR 70-200mm f/2.8G ED	80mm or longer focal length; and at 80mm, 2m (6.6 ft.) or longer shooting distance

About Depth of Field

Basics of the relationship between focus and depth of field are explained in this section.

■ Depth of field

When focusing, depth of field should be considered. Depth of field is the zone of sharpest focus in front of and behind the subject on which the lens is focused. It varies according to shooting distance, focal length and, above all, aperture. Smaller apertures (larger f-numbers) will produce a deeper depth of field where the background and foreground become sharper; larger apertures (smaller f-numbers) will produce a shallower depth of field where the background becomes blurred. Similarly, shorter shooting distance or longer focal length will produce a shallower depth of field, and longer shooting distance or shorter focal length will produce a deeper depth of field. Note that depth of field tends to be shallower in front of and deeper behind the subject in focus.



Large aperture $f/2.8$

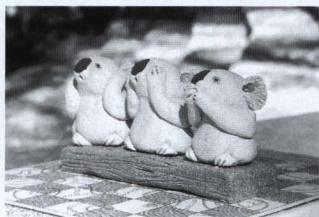

Small aperture $f/32$



MISCELLANEOUS

This section explains miscellaneous information.



- Lens compatibility
- Usable optional Speedlights
- Optional accessories
- Camera care
- Notes on batteries
- Troubleshooting
- Glossary
- Specifications
- Index
- Custom Setting menu

Lens Compatibility

Use a CPU Nikkor lens (except IX-Nikkor) with this camera. G- or D-type AF lenses give you access to all available functions.

Mode Lens/accessories		Focus mode			Exposure mode		Metering system		
		Autofocus	Manual with electronic rangefinder	Manual	Any mode other than M	M	Matrix		Center-Weighted*1
							3D 25-segment	25-segment	
CPU Nikkor*2	G-type AF Nikkor, D-type AF Nikkor*3,	○	○	○	○	○	○	—	○
	AF-S, AF-I Nikkor	○	○	○	○	○	○	—	○
	PC Micro-Nikkor 85mm f/2.8D*4	—	○*5	○	—	○	—	—	○
	AF-S, AF-I Teleconverter*6	○	○*7	○	○	○	○	○	○
	Non-G or D-type AF Nikkor (except AF Nikkor for F3AF)	○	○	○	○	○	—	○	○
	AI-P Nikkor	—	○*8	○	○	○	—	○	○
Non-CPU Nikkor*9	AI-S or AI type Nikkor, Series-E, AI-modified Nikkor	—	○*8	○	—	○*10	—	—	—
	Medical-Nikkor 120mm f/4	—	○	○	—	○*11	—	—	—
	Reflex-Nikkor	—	—	○	—	○*10	—	—	—
	PC-Nikkor	—	○*5	○	—	○*10	—	—	—
	AI-S or AI type Teleconverters	—	○*7	○	—	○*10	—	—	—
	Bellows Focusing Attachment PB-6*12	—	○*7	○	—	○*10	—	—	—
	Auto Extension Rings (PK-11A, PK-12, PK-13 and PN-11)	—	○*7	○	—	○*10	—	—	—

- *1 Metering system automatically switches to Center-Weighted Metering when the exposure mode is set to Manual.
- *2 IX-Nikkor lenses cannot be attached.
- *3 This camera is compatible with the Vibration Reduction function of the VR Nikkor lens.
- *4 The camera's exposure metering and flash control system do not work properly when shifting and/or tilting the lens, or when using an aperture other than the maximum aperture.
- *5 Without shifting and/or tilting the lens.
- *6 Compatible with AF-S and AF-I Nikkor except AF-S 17-35mm f/2.8D IF-ED, AF-S 24-85mm f/3.5-4.5G IF-ED and AF-S 28-70mm f/2.8D IF-ED.
- *7 With maximum effective aperture of f/5.6 or faster.
- *8 With maximum aperture of f/5.6 or faster.
- *9 Some lenses/accessories cannot be attached. (See page 106.)
- *10 With exposure mode set to Manual. The exposure meter cannot be used.
- *11 With exposure mode set to Manual and shutter speed set to 1/90 sec. or slower, the exposure meter cannot be used.
- *12 Attach the PB-6 vertically. (PB-6 can be set to horizontal position after attaching.)
 - When using AF-S VR Nikkor lens, it is recommended that you carry spare batteries and change them frequently.
 - AS-15 must be attached in combination with Medical-Nikkor 200mm f/5.6 for the lens to fire the flash.
 - Reprocody Outfit PF-4 can be attached in combination with Camera Holder PA-4.

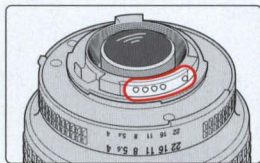

CPU contacts of CPU
Nikkor lens

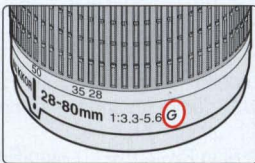

G-type Nikkor lens

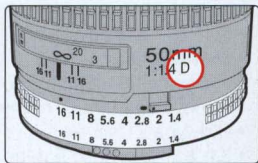

D-type Nikkor lens

G-type Nikkor and other CPU Nikkor lens (page 19)

- The G-type Nikkor lens has no aperture ring; aperture should be selected from the camera body. Unlike other CPU Nikkor lenses, aperture does not need to be set to minimum (largest f-number).
- CPU Nikkor lenses other than G-type Nikkor lens have an aperture ring. Set the lens aperture to its minimum and lock. When the lens is not set to its minimum aperture setting and the power switch is turned on, fEE blinks in the LCD panel and viewfinder and the shutter cannot be released.

Lens Compatibility—continued

When a non-CPU lens is attached

Set exposure mode to M with a non-CPU lens. (When other modes are selected, shutter cannot be released.) The camera's exposure meter cannot be used and the aperture cannot be set using the Command Dial when using non-CPU lenses. F - - appears in place of the aperture indication in the LCD panel and viewfinder; set/confirm aperture using the lens aperture ring.

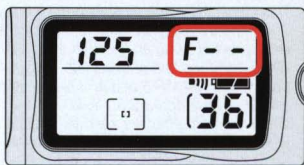

CAUTION: Nikkor lenses/accessories that cannot be attached to the N75/N75QD

The following non-CPU Nikkor lenses/accessories cannot be attached to the N75/N75QD (otherwise camera body or lens may be damaged):

- TC-16A Teleconverter
- Non-AI lenses
- 400mm f/4.5, 600mm f/5.6, 800mm f/8 and 1200mm f/11 with Focusing Unit AU-1
- Fisheye 6mm f/5.6, 7.5mm f/5.6, 8mm f/8 and OP 10mm f/5.6
- Old-type 21mm f/4
- K1, K2 Ring, Auto Extension Ring PK-1, PK-11, Auto Ring BR-2, BR-4
- ED 180-600mm f/8 (No. 174041-174180)
- ED 360-1200mm f/11 (No. 174031-174127)
- 200-600mm f/9.5 (No. 280001-300490)
- 80mm f/2.8, 200mm f/3.5 and TC-16 Teleconverter for F3AF
- PC 28mm f/4 (No. 180900 or smaller)
- PC 35mm f/2.8 (No. 851001-906200)
- Old-type PC 35mm f/3.5
- Old-type Reflex 1000mm f/6.3
- Reflex 1000mm f/11 (No. 142361-143000)
- Reflex 2000mm f/11 (No. 200111-200310)

Usable Optional Speedlights

Usable optional Speedlights and available flash modes are listed in the following table. Available modes are listed assuming a CPU lens is attached.

Flash mode Speedlight	Automatic Balanced Fill-Flash with TTL Multi Sensor*1	Non-TTL Auto flash	Manual	Repeating Flash	Rear- Curtain Sync*2	Red-Eye Reduction*2
SB-80DX, SB-28, SB-28DX	○	○	○	○	○	○
SB-27	○	○	○	—	○	○
SB-26*3, SB-25, SB-24	○	○	○	○	○	○
SB-50DX*4, SB-23, SB-29s/29*5, SB-21B*5	○	—	○	—	○	○
SB-30, SB-22s, SB-22, SB-20, SB-16B, SB-15	○	○	○	—	○	○
SB-11*6, SB-14*6, SB-140*6	○	○	○	—	○	○

*1 Selecting Manual exposure mode automatically changes the Automatic Balanced Fill-Flash with TTL Multi Sensor to Standard TTL Flash (page 91).

*2 Can be set from camera.

*3 Wireless Slave Flash can be performed. Shutter speed is automatically controlled to 1/60 sec. (or 1/60 sec. or slower in S or M exposure mode) with the Wireless Slave Flash selector set to D.

*4 When double-flash operation is performed with Built-in Speedlight, set the exposure mode to P, S, A, or M.

*5 With the SB-29s/29 and SB-21B, autofocus can only be used when an AF Micro-Nikkor (60mm, 105mm, 200mm and 70-180mm) is attached.

*6 TTL Auto Flash is possible with TTL Remote Cord SC-23.

In A or M flash mode, attach SU-2 to SC-13 with SB-11 and SB-14, or attach SU-3 to SC-13, SC-11 or SC-15 to AS-15 with SB-140.

Ultraviolet photography can be performed only when SB-140 is set to M. (Infrared photography cannot be performed.)



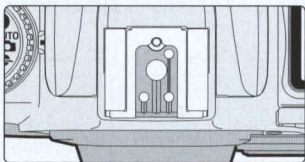

Usable Optional Speedlights—continued



■ Accessory shoe





- An optional Speedlight, i.e. SB-80DX, SB-50DX, SB-30, SB-28/28DX, SB-27, SB-23 or SB-22s can be attached directly to the accessory shoe of the N75/N75QD without a cord. This accessory shoe is equipped with a safety lock which prevents accidental drop when a Speedlight with a safety-lock pin (SB-80DX, SB-30, SB-28/28DX, SB-27, SB-26, SB-25 or SB-22s) is attached.
- Remove accessory shoe cover when attaching an optional Speedlight to the accessory shoe.

■ Available flash sync mode with optional Speedlight



Exposure mode	Front-Curtain Sync	Red-Eye Reduction	Red-Eye Reduction with Slow Sync	Slow Sync	Rear-Curtain Sync	Flash Cancel
AUTO	○	○	—	—	—	—
	○	○	—	—	—	—
 *	○	○	—	—	—	—
	○	○	—	—	—	—
 *	○	○	—	—	—	—
 *	—	—	○	○	—	—
P	○	○	○	○	○	—
S	○	○	—	—	○	—
A	○	○	○	○	○	—
M	○	○	—	—	○	—

* Built-in Speedlight is always set to Flash Cancel when  or  is selected but flash shooting becomes possible with optional Speedlight. However, turning the optional Speedlight power off activates Flash Cancel mode.

■ Notes on using optional Speedlights

- See your Speedlight manual for details. If the camera groups are defined in the manual of the Speedlight with TTL Auto Flash, see the section for camera **group I**.
- Flash sync speed is 1/90 sec. or slower when using an optional Speedlight.
- Available film speeds for TTL Auto Flash are ISO 25 to ISO 800.
- When Red-Eye Reduction or Red-Eye Reduction with Slow Sync is set on a camera attached with the Speedlight with Red-Eye Reduction function, the Red-Eye Reduction lamp of the Speedlight lights up. With other Speedlights without Red-Eye Reduction function, the Red-Eye Reduction lamp of the camera body lights up.
- When optional Speedlight with AF-Assist Illuminator, SB-80DX, 50DX, 28/28DX, 27, 26, 25 or 24, is attached, the AF-Assist Illuminator of the optional Speedlight emits light when the focus mode is set to AF, an AF Nikkor lens is attached, the subject is dark and center focus area is selected or Dynamic AF Mode with Closest-Subject Priority is activated. With other optional Speedlights, the AF-Assist Illuminator on the camera emits light.
- Set the exposure mode to Aperture-Priority Auto or Manual to take flash pictures with flash mode other than TTL auto (non-TTL auto or manual).
- With the SB-26, 25 or 24, even if Front-Curtain Sync is set on the camera body, the Speedlight performs Rear-Curtain Sync when Rear-Curtain Sync is set on the Speedlight in **P**, **S**, **A** or **M** exposure mode (camera setting is overridden). In  or Vari-Program (except ), Speedlight performs Front-Curtain Sync even if Rear-Curtain Sync is set on Speedlight (Speedlight setting is overridden).
- With the SB-26, 25 or 24, when Slow Sync is set on the camera body in , Rear-Curtain Sync is performed if Rear-Curtain Sync is set on the Speedlight.
- With the SB-26, 25 or 24, when Red-Eye Reduction or Red-Eye Reduction with Slow Sync is set on the camera body, Speedlight performs Red-Eye Reduction or Red-Eye Reduction with Slow Sync even if Rear-Curtain Sync is set on the Speedlight.

Usable Optional Speedlights—continued



- **FE** in the LCD panel and **FE** and $\frac{1}{2}$ in the viewfinder blink and the shutter cannot be released when the exposure mode is set to **P**,  or Vari-Program and the attached optional Speedlight is not set to TTL Auto Flash. Set the Speedlight flash mode to TTL, or set the camera's exposure mode to **S**, **A** or **M**.
- When the attached optional Speedlight is turned on while Flash Cancel mode is selected on the camera, the Flash Cancel indication in the LCD panel disappears and attached Speedlight will fire flash. With some optional Speedlights, the Flash Cancel indication does not disappear but the optional Speedlight will fire normally.
- With SK-6 and SB-24 attached, the AF-Assist Illuminators of the camera body and the Speedlight do not emit light.
- In **P** or  exposure mode, the camera automatically controls the maximum available aperture as follows in relation to the film speed:

ISO film speed		25	50	100	200	400	800
Maximum available aperture	Built-in Speedlight	2	2.4	2.8	3.3	4	4.8
	Optional Speedlight	2.8	3.3	4	4.8	5.6	6.7



* When film speed increases by one step, the maximum available aperture is stopped down by 1/2 f/stop. If you are using a lens with a maximum aperture smaller than that listed above, the automatically controlled aperture range is from the lens' maximum to minimum aperture.

- Use the optional Accessory Shoe Adaptor AS-15 to use the sync terminal.

NOTE: When optional Speedlight is attached

Turn on the optional Speedlight power switch or set the built-in Speedlight to Flash Cancel mode so the built-in Speedlight won't pop up automatically when an optional Speedlight is attached. When the built-in Speedlight automatically pops up in  or Vari-Program (except  or ) , vignetting or uneven illumination may result since the Speedlight may not pop up all the way.

NOTE: Flash attachments made by manufacturers other than Nikon

Use only Nikon Speedlights. Other units may damage the camera's electrical circuit due to incompatible voltage requirements (not compatible with 250V or higher), electric contact alignment or switch phase. When flash attachments made by manufacturers other than Nikon are attached, the built-in Speedlight may not pop up all the way (with power switch of the Speedlight on or off). When the built-in Speedlight is automatically fired in  or Vari-Program (except  or ) , vignetting or uneven illumination may result.

Optional Accessories

A variety of optional accessories, including power source and Speedlight is available for the N75/N75QD.

Battery Pack MB-18

- With Battery Pack MB-18, four 1.5V AA-type alkaline-manganese, lithium, NiCd or Ni-MH batteries can be used to power the N75/N75QD. When AA-type lithium batteries are used, the usable number of film rolls increases and stable performance is maintained at low temperatures. (Film advance speed in  mode remains the same [as that of batteries installed only in the camera body] with the MB-18.)
- Alternate shutter release button for vertical shooting is provided.

Remote Control Unit ML-L3

- Remote control releases the camera's shutter from a distance. As with self-timer operation, the remote control can also be used when you want to be in the photograph. You can also use the remote control instead of a cable release to reduce camera shake.

Eyepiece correction lenses

- Eyepiece correction lenses enable near- or far-sighted photographers to adjust the eyepiece diopter to suit their vision, and can be attached easily by inserting onto the viewfinder eyepiece. Nine optional eyepiece correction lenses provide viewfinder diopter settings of -5 , -4 , -3 , -2 , 0 , $+0.5$, $+1$, $+2$ and $+3m^{-1}$ (combined diopter with setting on camera body). We recommend that you actually look through the viewfinder with various correction lenses attached before making a purchase, since viewfinder diopter differs from one person to another. Use the optional eyepiece correction lens when you need eyepiece correction over -1.5 to $+0.8m^{-1}$ that can be adjusted using the N75/N75QD's diopter adjustment lever.
The rubber eyecup cannot be used together with the eyepiece correction lenses.

Lenses

- A wide variety of AF lenses—wideangle, telephoto, zoom, Micro or DC (Defocus image Control)—is available for the N75/N75QD.

Filters

- Nikon filters can be divided into three types: screw-in, drop-in and rear-interchange. With the N75/N75QD, the filter factor need not be considered except for the R60 filter. Compensate exposure +1 EV when using the R60.
Note that when special filters available from manufacturers other than Nikon are used, autofocus or the electronic rangefinder may not operate properly.
- Use circular-polarising filter C-PL instead of polarising filter Polar. The linear polarising filter cannot be used with the N75/N75QD.
- Use NC filter when using the filter to protect the lens.
- Moiré may occur when shooting a subject against bright light or if a bright light source is in the frame. In this case, remove the filter before shooting.

Speedlight SB-80DX/SB-50DX/SB-30

- Speedlight SB-80DX normally uses four AA-type alkaline-manganese batteries with a guide number of 38/125 (manual flash, 35mm zoom-head position, ISO 100, m/ft., 20°C/68°F). Optional external power source SD-7 and SD-8A or Power Bracket SK-6A can also be used. When used with the N75/N75QD camera, flash photography such as bounce flash and wireless multiple flash is possible. Also, Non-TTL Auto Flash is compatible with the SB-80DX.
- Speedlight SB-50DX uses two 3V lithium batteries with a guide number of 22/72 (manual flash, 35mm zoom-head position, ISO 100, m/ft., 20°C/68°F). When used with the N75/N75QD camera, flash photography such as bounce flash and wireless multiple flash is possible. Also, using the camera's built-in Speedlight and the SB-50DX in P, S, A or M exposure mode, double-flash operation and bounce-flash operation with double flash can be performed.
- Speedlight SB-30 uses one 3V lithium battery with a guide number of 16/53 (manual flash, 28mm zoom-head position, ISO 100, m/ft., 20°C/68°F). When used with the N75/N75QD camera, flash photography such as wireless multiple flash using the camera's built-in Speedlight as a master Speedlight and Non-TTL Auto Flash is possible.

Soft case (CF-63)

- Camera case CF-63 is available for this camera. The camera body fits inside the case with AF 28-80mm f/3.3-5.6G or smaller lens attached.

Neckstraps/Handstrap AH-4

- Braid-type AN-4B (black) and AN-4Y (yellow), wide braid-type AN-6Y (yellow) and AN-6W (burgundy) neckstraps are available.
- Handstrap AH-4 helps you hold the camera firmly and easily, and shoot in quick-motion.

Camera Care

• **Cleaning camera body**

Use a blower brush to remove dirt and dust from the camera body and clean it with a soft, clean cloth. After using the camera near seawater, wipe the camera body with a soft, clean cloth slightly moistened with pure water to remove salt, and then dry it with a dry cloth. **NEVER use organic solvents like thinner or benzene.** They may damage the camera.

• **Cleaning mirror and lens**

Use a blower brush to remove dirt and dust from the mirror or lens. To remove fingerprints or smudges from the lens' surface, use a soft, clean cotton cloth or lens tissue moistened with ethanol (alcohol) or lens cleaner.

• **Do not subject the camera or lens to strong vibration or shock**

Do not drop the camera body and lens or hit them against a hard surface as this may damage their precision mechanism.

• **Do not touch the shutter curtains**

The shutter is made of very thin curtains. Do not hold, poke, or blow strongly with a blower brush. Doing so may scratch, deform or tear the shutter curtains.

• **Avoid strong electric or magnetic fields**

The camera may not function properly in strong electric or magnetic fields such as near a transmitter tower. Avoid using the camera in such locations.

• **Store the camera in a cool, dry place**

Store the camera in a cool, dry place to prevent mould and mildew. Keep it away from naphthalene or camphor (moth repellent), electrical appliances that generate magnetic fields or an excessively hot place such as inside a vehicle during the summer or near a heater.

• **Avoid extreme temperature change**

An extreme temperature change can cause condensation inside the camera body. When taking the camera to a very hot place from a very cold place or vice versa, place it inside an airtight container such as a plastic bag and leave it inside a while to expose the camera gradually to the temperature change.

• **Avoid water or moisture**

Keep the camera away from water or moisture. When using the camera near water, guard against splashes, especially saltwater spray.

• **Remove the batteries and store the camera with a desiccant**

If you do not intend to use the camera for a long time, remove the batteries to protect the camera from battery leakage.

- In a humid environment, store the camera inside a plastic bag with a desiccant to keep out dust, moisture and salt. Note, however, that storing leather cases in vinyl bags may cause the leather to deteriorate. Keep the batteries in a cool, dry place away from heat or humidity.
- Change the desiccant occasionally since it does not absorb moisture effectively after a while.
- Leaving the camera unused for a long period of time may cause mould to grow and result in malfunction. Turn the power on and release the shutter a few times once per month.
- To maintain the built-in Speedlight in peak condition, fire it a few times every month. This will enable you to use the flash for many years.

Nikon cannot be held responsible for any malfunction resulting from the use of the camera other than as specified in this manual.

Notes on Batteries



WARNING



Do not leave

Keep batteries out of children's reach.
If someone accidentally swallows batteries, call a doctor immediately.

• Use two CR2-type 3V lithium batteries

Use two CR2-type 3V lithium batteries.

- Change the batteries well before the end of their life and prepare spare batteries before important photographic occasions.

• Turn the camera power off when changing batteries

Turn the camera power off before changing batteries and insert the batteries with ⊕ and ⊖ ends positioned correctly.

- Stains on the battery poles may cause lack of contact. Wipe the batteries well with a dry cloth before installing.

• Use fresh batteries at low temperatures











Battery power diminishes at extremely low temperatures and the camera may not function properly with old batteries. Use a fresh set of batteries at low temperatures, keep spare batteries warm, and use them alternately.

- Film advance speed lowers and number of usable film rolls becomes less at low temperatures. However, battery power may recover when the temperature returns to normal.

• Do not throw batteries into a fire or short circuit batteries

Do not throw batteries into a fire. Do not short, disassemble, heat or charge batteries.

Troubleshooting

LCD panel	Viewfinder	Cause	Remedy	Page
<i>FE E</i> blinks	<i>FE E</i> blinks	<ul style="list-style-type: none"> • CPU Nikkor lens other than G-type is not set to its minimum aperture. 	<ul style="list-style-type: none"> • Set lens to minimum aperture. 	19, 105
<i>FE E</i> blinks	<i>FE E</i> and  blink	<ul style="list-style-type: none"> • Attached Speedlight is not set at TTL Auto Flash in , Vari-Program or P mode. 	<ul style="list-style-type: none"> • Set the Speedlight flash mode to TTL, or set the camera's exposure mode to S, A or M. 	110
 appears	 appears (When exposure meter is on)	<ul style="list-style-type: none"> • Batteries are nearing exhaustion. 	<ul style="list-style-type: none"> • Have fresh ones ready. 	17
 blinks (appears without blinking when exposure meter is off)	 blinks (appears without blinking when exposure meter is off)	<ul style="list-style-type: none"> • Batteries are just about exhausted. 	<ul style="list-style-type: none"> • Turn the power off and replace batteries with new ones. 	17
 ,  and frame counter blink	 and  blink	<ul style="list-style-type: none"> • Batteries are exhausted during film rewind. 	<ul style="list-style-type: none"> • Turn the power off, replace batteries with new ones and turn the power on again. If this warning appears frequently, contact authorized Nikon dealer or service center. 	78
<i>F - -</i> blinks	<i>F - -</i> blinks	<ul style="list-style-type: none"> • Non-CPU lens is attached or lens is not attached. 	<ul style="list-style-type: none"> • Attach CPU lens. With a non-CPU lens, set the exposure mode to M and set the aperture with lens' aperture ring. 	18, 106

Troubleshooting—continued

LCD panel	Viewfinder	Cause	Remedy	Page
E appears	☉ blinks	<ul style="list-style-type: none"> Film is not correctly installed. 	<ul style="list-style-type: none"> Reload film. 	21
Err and E blink	☉_ blinks	<ul style="list-style-type: none"> Film is not correctly advanced. 	<ul style="list-style-type: none"> Reload film. 	21
E blinks when exposure meter is turned on	☉ blinks	<ul style="list-style-type: none"> Film remains in the camera after film rewind is complete. 	<ul style="list-style-type: none"> Remove the film cartridge. 	31
—	● blinks	<ul style="list-style-type: none"> Autofocus is not possible. 	<ul style="list-style-type: none"> Focus manually. 	29
H i appears	H i appears	<ul style="list-style-type: none"> Overexposure warning (subject is too bright). 	<ul style="list-style-type: none"> In P mode, use ND filter. In S mode, select faster shutter speed. In A mode, select smaller aperture (larger f-number). If the warning indication remains after performing above remedies in S or A mode, use ND filter as well. 	55 57 59
l o appears	l o appears	<ul style="list-style-type: none"> Underexposure warning (subject is too dark). 	<ul style="list-style-type: none"> In P mode, use flash. In S mode, select slower shutter speed. In A mode, select larger aperture (smaller f-number). If the warning indication remains after performing above remedies in S or A mode, use flash as well. 	55 57 59

LCD panel	Viewfinder	Cause	Remedy	Page
—	◀ or ▶ blinks (in M exposure mode)	<ul style="list-style-type: none"> • Subject brightness is beyond camera's exposure range. 	<ul style="list-style-type: none"> • When the subject is bright, use ND filter and when the subject is dark, use flash. The electronic analog exposure display remains blinking when the Speedlight is used. 	61
-- blinks	-- blinks	<ul style="list-style-type: none"> • Shutter speed is set to -- (Time) in S mode. • Auto Exposure Bracketing is set during Long Time exposure. 	<ul style="list-style-type: none"> • Cancel the -- by selecting 30 sec. or faster shutter speed, or select M mode to perform Long Time Exposure. • Select shutter speed other than -- to cancel Long Time exposure, or cancel Auto Exposure Bracketing. 	57, 62 62, 68
∞ appears (when shutter speed faster than 1/90 sec. is selected)	∞ appears	<ul style="list-style-type: none"> • Shutter speed faster than sync speed is selected in S or M mode in flash photography. 	<ul style="list-style-type: none"> • Simply release the shutter to take a flash picture. (Shutter speed automatically shifts to 1/90 sec.) 	94, 97
—	⚡ blinks	<ul style="list-style-type: none"> • Subject is too dark and flash is recommended in P, S, A or M mode. 	<ul style="list-style-type: none"> • Use Speedlight. 	55, 57, 59, 61, 90, 95

Troubleshooting—continued

LCD panel	Viewfinder	Cause	Remedy	Page
—	⚡ blinks for 3 sec. after flash	<ul style="list-style-type: none">Flash has fired at full output and underexposure may have occurred.	<ul style="list-style-type: none">Shoot again after confirming focus distance, aperture or flash shooting distance range.	91, 97, 98
<i>Err</i> blinks	<i>Err</i> blinks	<ul style="list-style-type: none">Malfunction detected.	<ul style="list-style-type: none">Turn the power off once and then on again. If the warning indication remains, or this warning appears frequently, contact authorized Nikon dealer or service center.	

In certain cases, due to static electricity, the N75/N75QD's microcomputer may turn the camera off, even with fresh, properly installed batteries. For the same reason, the film may not advance properly. In each of these cases, to resume operation, simply turn the power off, then turn it on again. Or, remove and reinstall the batteries.

Glossary

CPU

Central Processing Unit. The electronic component that controls an electronic product's functions.

AF Nikkor (including G- and D-type AF Nikkor) and AI-P-Nikkor lenses have built-in CPUs.

Depth of Field

See the column on page 102.

EV

Exposure Value: A number representing the available combinations of shutter speeds and apertures that give the same exposure effect under conditions of similar scene brightness and ISO.

At ISO 100, the combination of a one-second shutter speed and an aperture of $f/1.4$ is defined as EV1.

The camera can be used only within the EV range of the exposure meter. For example, with the N75/N75QD, the exposure metering range is from EV1 to EV20 at ISO 100 with an $f/1.4$ lens.

Exposure

See the column on page 32.

Exposure bracketing

Shooting the same subject a number of times at a range of different exposures to attain proper exposure. Three shots with metered EV, under EV, and over EV exposure are performed in that order with the N75/N75QD.

Automatic exposure bracketing is performed with varied shutter speeds and/or apertures.

Exposure Compensation

In a situation such as when your subject is strongly backlit, exposure compensation enables you to intentionally compensate the standard exposure value measured by the camera to create a desired effect. Exposure compensation of -3 EV to $+3$ EV in $1/2$ steps is available with the N75/N75QD.

Flash shooting distance range

The distance range over which a flash can effectively provide light. Flash shooting distance range is controlled by the amount of flash output available. Each automatic Speedlight's flash output varies from maximum duration to minimum duration. Close-up subjects will require lower (to minimum) output, while more distant subjects will require more light up to the maximum output. The flash shooting distance range varies with the aperture, film speed, etc.

Flash synchronization

Timing of the flash so it coincides with release of the camera's shutter. There are two types of synchronization: Front-Curtain Sync, which fires the flash at the start of the exposure, and Rear-Curtain Sync, which fires the flash at the end of the exposure.

Flash sync speed

Shutter speed at which the entire film frame is exposed when the flash is fired in flash shooting. The N75/N75QD's flash sync speed is $1/90$ sec. or slower.

Glossary—continued

Flexible Program

Flexible Program function temporarily shifts an automatically selected shutter speed/aperture combination while maintaining correct exposure. That is, the desired shutter speed or aperture can be selected in Auto-Multi Program.

f-number

The f-number represents the aperture value and is calculated from lens' focal length divided by the effective aperture opening. The standard numbers for calibration are 1, 1.4, 2, 2.8, 4, 5.6, 8, 11, 16, 22, 32, etc.

The smallest f-number is called maximum aperture and the largest f-number is called minimum aperture. Lenses with large maximum apertures (smaller f-numbers) are 'fast' lenses that allow photographers to use faster shutter speeds in dim light. Lenses with smaller maximum apertures (larger f-numbers) allow the use of lower shutter speeds for available light but are also lighter and smaller than faster lenses. With some zoom lenses, aperture varies depending on the focal length setting.

Focal length

The distance from the principal point to the focal point. In 35mm-format cameras, lenses with a focal length of approx. 50mm are called normal or standard lenses. Lenses with a focal length less than approx. 35mm are called wideangle lenses, and lenses with a focal length more than approx. 85mm are called telephoto lenses. Lenses which allow the user to continuously vary the focal length without changing focus are called zoom lenses.

Focus Tracking

Enables the camera to analyse the speed of a moving subject according to the focus data detected, and to obtain correct focus by anticipating the subject's position—at the exact moment of exposure.

Lock-On™ Autofocus keeps focus firmly on a main subject during Focus Tracking even if some other object momentarily blocks it in the viewfinder.

Front-Curtain Sync

The flash fires an instant after the front curtain of a focal plane shutter has completed its travel across the film plane. This is the way the N75/N75QD operates with the flash sync mode at Normal Sync. (See "Rear-Curtain Sync".)

Guide number

The guide number indicates the power of a flash in relation to ISO film speed. The guide number of the built-in Speedlight of the N75/N75QD is 12/39 (ISO 100, m/ft.). Guide numbers are quoted in either meters or feet. Guide numbers are used to calculate the f/stop for correct exposure as follows:

$$f/stop = \frac{\text{guide number}}{\text{flash-to-subject distance}}$$

Using a selected aperture, we can calculate the required flash-to-subject distance with the formula:

$$\text{flash-to-subject distance} = \frac{\text{guide number}}{f/stop}$$

Useful for determining the maximum flash-to-subject distance for flash photography.

ISO film speed

The international standard for representing film sensitivity. The higher the number, the greater the sensitivity, and vice versa. A film speed of ISO 200 is twice as sensitive as ISO 100, and half that of ISO 400 film.

Metering system

See the column on page 32.

Rear-Curtain Sync

Flash fires an instant before the second (rear) curtain of the focal plane shutter begins to move. When slow shutter speeds are used, this feature can create a blur effect from the ambient light, i.e., flowing-light patterns following a moving subject with subject movement frozen at the end of the light flow. (See “Front-Curtain Sync”.)

Slow Sync

A flash technique for using the flash at a slow shutter speed. Flash shooting in dim light or at night at a fast shutter speed often results in a flash-illuminated subject against a dark background. Using a slower shutter speed with the flash brings out the background details in the picture.



The N75/N75QD's Slow Sync mode extends the automatically controlled shutter speed range down to 30 sec. (in Auto-Multi Program, Aperture-Priority Auto) or 1 sec. (in  Night Portrait mode).

Vignetting









Progressively diminished illumination on the film from the center to the corners. There are two kinds of vignetting—natural vignetting caused by the lens, and vignetting that is caused by improper use of accessories such as a lens hood or filter.



Specifications

Type of camera	Integral-motor autofocus 35mm single-lens reflex with electronically controlled focal-plane shutter and built-in Speedlight
Exposure modes	AUTO : AUTO mode Vari-Program (☞: Portrait, 🌄: Landscape, 📷: Close-Up, ⚡: Sports, 🌃: Night Portrait mode) P : Auto-Multi Program (Flexible Program possible) S : Shutter-Priority Auto A : Aperture-Priority Auto M : Manual
Picture format	24 x 36mm (standard 35mm film format)
Lens mount	Nikon F mount (with AF coupling, AF contacts)
Lens	Nikkor and Nikon lenses having Nikon F mount* * With limitations; see chart on page 104.
Viewfinder	Fixed-eyelevel penta-Dach-mirror type, built-in diopter adjustment (-1.5 to +0.8m ⁻¹)
Eyepoint	17mm (at -1.0m ⁻¹)
Focusing screen	B-type Clear Matte Screen V with focus brackets
Viewfinder frame coverage	Approx. 89%
Finder magnification	Approx. 0.68-0.60x with 50mm lens set to infinity (at -1.5 to +0.8m ⁻¹)
Viewfinder information (with illuminator)	Focus indications, focus area, shutter speed, aperture, electronic analog exposure display/Exposure Compensation value display, Exposure Compensation, flash ready-light/flash recommended/full flash output, film status, battery power Five sets of focus brackets (area), 12mmø reference circle for Center-Weighted metering
Reflex mirror	Automatic, instant-return type
Lens aperture	Instant-return type

Autofocus	TTL phase detection, Nikon Multi-CAM900 autofocus module with AF-Assist Illuminator (approx. 0.5m-3m [1.6-9.8 ft.]) <ul style="list-style-type: none"> • Detection range: EV -1 to EV 19 (ISO 100, at normal temperature)
Lens servo	AF: Auto-Servo AF: camera automatically chooses Single Servo AF or Continuous Servo AF operation according to the subject status, i.e. stationary or moving. <ul style="list-style-type: none"> • Single Servo AF (focus is locked when the subject is in-focus) • Continuous Servo AF (camera continues to focus on a moving subject, automatically selected when  mode is set); Focus Tracking with Lock-On™ automatically activated by subject's status M: Manual focus
Focus area	One of five focus areas can be selected
Focus area mode	AF focus mode: <ul style="list-style-type: none"> • Dynamic AF Mode with Closest-Subject Priority • Dynamic AF Mode with Center-Subject Priority • Dynamic AF Mode M focus mode: <ul style="list-style-type: none"> • Center Area Mode • Single Area Mode
Metering system	TTL full-aperture exposure metering system <ul style="list-style-type: none"> • 3D 25-segment Matrix Metering: with G- or D-type AF Nikkor • 25-segment Matrix Metering: with AF Nikkor other than G- or D-type (except AF Nikkor for F3AF and IX-Nikkor), AI-P Nikkor • Center-Weighted Metering: automatically selected with Manual exposure mode • Spot Metering: in Auto Exposure lock with Custom Setting option (metering system in the Auto Exposure lock)
Metering range	3D 25-segment Matrix Metering: EV 1-20 Center-Weighted Metering: EV 1-20 Spot Metering: EV 4-20 (at normal temperature, ISO 100, f/1.4 lens)
Exposure meter coupling	CPU
Exposure compensation	Exposure compensated in ± 3 EV range, in 1/2 steps (except in M or )

Specifications—continued

Auto Exposure Bracketing	Bracketing range: ± 2 EV; number of shots: three; bracketing steps: 0.5, 1, 1.5 or 2 EV (except in  or Vari-Program)
Film speed setting	<ul style="list-style-type: none"> Automatically set to ISO film speed of DX-coded film in use (manual not selectable) Film speed range: DX: ISO 25-5000, automatically set to ISO 100 with non-DX-coded film
Shutter	Electronically controlled vertical-travel focal-plane shutter
Shutter speeds	<ul style="list-style-type: none"> In , , , , , A: Automatically set between 30 and 1/2000 sec. In S: 30 to 1/2000 sec. (in 1/2 steps) In M: 30 to 1/2000 sec. (in 1/2 steps), Time
Sync contact	X-contact only; flash synchronization up to 1/90 sec.
Built-in Speedlight	<ul style="list-style-type: none"> In , Vari-Program (except in  or ) Automatically activated In P, S, A, M: Activated by pressing flash lock-release button <p>Guide number: 12/39 (at ISO 100, m/ft.); flash coverage: 28mm or longer lens; film speed range: ISO 25 to ISO 800</p>
Flash control	<p>Controlled by TTL Sensor</p> <ul style="list-style-type: none"> Automatic Balanced Fill-Flash with TTL Multi Sensor: 3D Multi-Sensor Balanced Fill-Flash compatible with built-in Speedlight or optional Speedlight and D- or G-type Nikkor lens, Multi-Sensor Balanced Fill-Flash compatible with built-in Speedlight or optional Speedlight and CPU Nikkor lens other than D/G-type (except in Manual exposure mode) Standard TTL: in Manual exposure mode Film speed range in TTL auto flash: ISO 25 to 800 <p>* See pages 90-91 and 107-111 for details.</p>
Flash sync mode	Front-Curtain Sync (normal sync), Slow Sync, Rear-Curtain Sync, Red-Eye Reduction, Red-Eye Reduction with Slow Sync, Flash Cancel
Ready-light	<ul style="list-style-type: none"> Flash fully charged: ready-light lights Full output warning: ready-light blinks
Flash recommended indication	Blinks when the subject is dark or backlit and Speedlight is recommended in P , S , A and M
Accessory shoe	Standard ISO-type hot-shoe contact (sync contact, ready-light contact, TTL Auto Flash contact, GND), safety lock provided

Self-timer	Electronically controlled; timer duration: 10 sec.
Remote control (optional)	Infrared, activated by pressing the shutter release button; immediate release mode and 2-sec. delay mode; operating distance: approx. 5m directly in front of the camera; battery: one 3V CR2025 lithium battery; battery life: approx. 5 years (may differ with usage amount or other operating conditions); dimensions: approx. 60 x 28 x 7mm or 2.4 x 1.1 x 0.3 in. (W x H x D); weight: approx. 10g or 0.35 oz. including battery
Depth-of-field preview button	Stop-down lens aperture by pressing depth-of-field button; electronically controlled
Film loading	Easy loading, automatic prewind with built-in motor; film automatically advances to first frame (frame of the maximum number of available exposure) when camera back is closed
Film advance	<ul style="list-style-type: none"> • Automatic advance with built-in motor • : Single-frame shooting, : Continuous shooting • Film advance speed: approx. 1.5 fps (fresh batteries)
Film rewind	<ul style="list-style-type: none"> • Automatic rewind with built-in motor • Mid-roll rewind available
Multiple exposure	Selectable in P, S, A, M
LCD panel information	Shutter speed, aperture, exposure compensation, exposure compensation value, auto exposure bracketing, multiple exposure, flash sync mode, focus area, battery power, frame counter, self-timer, remote control
Date/time imprint function (N75QD only)	Built-in clock: 24-hour type with timing accuracy within ± 90 seconds a month; leap year adjustment until December 31, 2049 Usable film: ISO 32 to 3200 DX-coded film Display mode: Year/Month/Day, Day/Hour/Minute, No Imprint, Month/Day/Year and Day/Month/Year
Camera back	Hinged back with film confirmation window N75QD: data imprint LCD panel/buttons
Power source	Two 3V CR2 lithium batteries
Power switch	Power ON and OFF position
Exposure meter	Auto meter shut-off 5 sec. after power turned on if no operations are performed; activated by lightly pressing shutter release button after power is turned on

Specifications—continued

Battery power confirmation	In LCD panel and viewfinder, with exposure meter on			
	LCD panel	Viewfinder	Status	Meaning
		—	Stays on	Sufficient power
			Stays on	Batteries are nearing exhaustion
			Blinking	Batteries are just about exhausted
Usable number of 36-exposure (24-exposure) film rolls per set of two fresh 3V lithium batteries		At 20°C/68°F	At -10°C/14°F	
	Without flash	Approx. 40 (60)	Approx. 23 (34)	
	With flash and AF-Assist Illuminator for half of all exposures	Approx. 12 (18)	Approx. 7 (10)	
	<i>Autofocus operation using an AF Zoom-Nikkor 28-80mm f/3.3-5.6G lens, covering the full range from infinity (∞) to the closest distance and back to infinity (∞) before each shot, with a shutter speed of 1/90 sec. or faster.</i>			
Tripod socket	1/4 (ISO 1222)			
Dimensions (W x H x D)	N75: Approx. 131 x 92.5 x 65mm or 5.2 x 3.6 x 2.6 in. N75QD: Approx. 131 x 92.5 x 67.5mm or 5.2 x 3.6 x 2.7 in.			
Weight (without batteries)	N75: Approx. 380g or 13.4 oz. N75QD: Approx. 385g or 13.6 oz.			
Optional exclusive accessories	Battery Pack MB-18, Soft case CF-63			

All specifications apply when fresh batteries are used at normal temperature (20°C/68°F).

Specifications and design are subject to change without notice.

Index

A

- AF-Assist Illuminator.....29, 39, 50-51, 88, 97, 109-110
- Aperture-Priority Auto exposure mode10, 27, 32, 58-59, 88, 97, 99
- Auto Exposure Bracketing.....35, 54-55, 62, 66-68, 70, 88, 121
- Autofocus24-25, 44
- Automatic Balanced Fill-Flash with TTL
 - Multi Sensor90-91, 107
- AUTO mode11, 26, 27, 55, 88, 97, 99
- Auto-Multi Program10, 27, 32, 54-55, 88, 97, 99
- Auto-Servo AF44

C

- Center Area Mode.....46-47, 80
- Center-Weighted Metering9, 32, 60
- Continuous shooting36, 79
- Continuous Servo AF30, 36, 44, 47
- CPU Nikkor lens18-19, 104-105, 121
- Custom Setting72-76

D

- Depth of field58, 102
- Diopter adjustment82
- Distance information26, 32
- D-type Nikkor lens18, 104-105
- DX-coded film.....21

- Dynamic AF Mode.....46-47
- Dynamic AF Mode with Center-Subject Priority36, 46-47
- Dynamic AF Mode with Closest-Subject Priority24, 36, 46-47

E

- Electronic rangefinder.....45
- Exposure Compensation64, 88, 121
- Exposure meter14, 17
- Exposure mode10-11, 26-27, 54-62, 88, 97, 99, 104

F

- Film advance mode79
- Flash Cancel.....38, 93, 99
- Flash shooting distance range98, 121
- Flash sync mode.....92-94, 96, 99, 107
- Flexible Program55, 88, 122
- Focus brackets (area)8, 9, 28, 46-49
- Focus Lock25, 52
- Focus mode.....24, 44-45, 88, 104
- Focus Tracking44, 122
- Front-Curtain Sync39, 92, 94, 99, 109, 122

G

- G-type Nikkor lens18, 104-105
- Guide number.....38, 90, 98, 122

Index—continued

L

Long Time exposure (Time).....57, 62

M

Manual exposure mode.....

.....10, 27, 32, 60-62, 88, 97, 99

Manual focus.....25, 45

Manual focus with electronic rangefinder ...

.....45

Matrix Metering.....26, 32

Maximum aperture.....58, 60, 110

Metering system.....26, 32, 60, 88, 104

Minimum aperture...19, 54, 56, 58, 60, 105

Multiple Exposure.....69-70, 88

Multi-Sensor Balanced Fill-Flash.....

.....38, 90-91, 99

R

Rear-Curtain Sync..90, 93-94, 99, 109, 123

Ready-light.....9, 39, 91, 95, 97

Red-Eye Reduction.....41, 93, 99, 109

Red-Eye Reduction with Slow Sync.....

.....93, 99, 109

Remote control.....84-87, 112

S

Self-timer.....40-41

Shutter-Priority Auto exposure mode.....

.....10, 27, 32, 56-57, 88, 97, 99

Single Area Mode.....46-47

Single-frame shooting.....79

Single Servo AF.....44

Slow Sync flash.....92, 99, 123

Spot Metering.....75, 80

Standard TTL flash.....90-91, 99

Sync shutter speed.....97

T

3D Multi-Sensor Balanced Fill-Flash.....

.....38, 90-91, 99

3D 25-Segment Matrix Metering.....26, 32

V

Vari-Program.....

.....11, 27, 32, 34-37, 88, 97, 99

Vignetting.....51, 100-101

Custom Setting Menu

	Function	Options
1	Beep sound	0: Activated (initial setting) 1: Disabled
2	Warning indications in the viewfinder	0: Displayed (initial setting) 1: Off
3	Bracketing order	0: Metered value, under, over (initial setting) 1: Under, metered value, over
4	Focus area illumination	0: Automatically illuminated for low light (initial setting) 1: Canceled 2: Always illuminated
5	Auto Exposure Lock when shutter release button is lightly pressed	0: Disabled (initial setting) 1: Activated
6	AE-L button	0: Auto Exposure lock only (initial setting) 1: AE/AF simultaneous lock 2: AF operation only starts by pressing AE-L/AF-L button
7	Metering system in the Auto Exposure lock	0: Center-Weighted (initial setting) 1: Matrix 2: Spot
8	Time delay for auto meter-switch-off	3: 3 sec. 5: 5 sec. (initial setting) 10: 10 sec. 20: 20 sec.
9	Self-timer duration	2: 2 sec. 5: 5 sec. 10: 10 sec. (initial setting) 20: 20 sec.
10	Standby duration for the remote control operation	1: 1 min. (initial setting) 5: 5 min. 10: 10 min.
11	LCD illuminates by pressing any function button	0: Disabled (initial setting) 1: Activated
12	AF-Assist Illuminator activation	0: Activated (initial setting) 1: Disabled

No reproduction in any form of this manual, in whole or in part (except for brief quotation in critical articles or reviews), may be made without written authorization from NIKON CORPORATION.

Nikon

NIKON CORPORATION

FUJI BLDG., 2-3, MARUNOUCHI 3-CHOME,
CHIYODA-KU, TOKYO 100-8331, JAPAN

Printed in Thailand