

Nokia C3-00 User Guide

Contents		Nokia Xpress audio messages	21
		Nokia Messaging Service	21
		Voice messages	22
		Message settings	22
Safety	4		
Support	5	Contacts	22
Nokia C3 in brief	5	Music	23
Key features	5	Media player	23
Keys and parts	6	FM radio	24
Get started	8	Photos	25
Insert SIM card and battery	8	Capture images and record videos	25
Switch on or off	9	View your images and videos	26
Antennas	9	Applications	26
Charge the battery	10	Alarm clock	26
Headset	10	Gallery	26
Insert a microSD card	11	Extras	26
Remove the microSD card	12	Voice recorder	27
Connect a USB data cable	12	To-do list	27
Attach the wrist strap	13	Calendar	27
Access codes	13	Settings	28
PUK codes	13	Profiles	28
Home screen	14	Tones	28
Keypad lock	16	Display	28
Use your device without a SIM card	16	Date and time	28
Applications running in background	16	Shortcuts	29
Calls	16	Synchronization and backup	29
Make and answer a call	16	Connectivity	29
Loudspeaker	17	Call and phone	33
Dialing shortcuts	17	Accessories	33
Write text	17	Configuration	34
Write text using the keyboard	17	Restore factory settings	34
Predictive text input	18	About Ovi Browser	34
Navigate the menus	19	Operator menu	35
Messaging	19	SIM services	35
Text and multimedia messages	19		
Flash messages	21		

Protect the environment 35

Save energy 35

Recycle 35

Product and safety information 36**Index 43**

Safety

Read these simple guidelines. Not following them may be dangerous or illegal. Read the complete user guide for further information.

SWITCH ON SAFELY



Do not switch the device on when wireless phone use is prohibited or when it may cause interference or danger.

ROAD SAFETY COMES FIRST



Obey all local laws. Always keep your hands free to operate the vehicle while driving. Your first consideration while driving should be road safety.

INTERFERENCE



All wireless devices may be susceptible to interference, which could affect performance.

QUALIFIED SERVICE



Only qualified personnel may install or repair this product.

ACCESSORIES AND BATTERIES



Use only approved accessories and batteries. Do not connect incompatible products.

WATER-RESISTANCE



Your device is not water-resistant. Keep it dry.

Support

When you want to learn more about how to use your product or you are unsure how your phone should function, read the user guide thoroughly.

If this does not resolve your issue, do one of the following:

- Reboot your phone. Switch off the phone, and remove the battery. After about a minute, replace the battery, and switch on the phone.
- Update your phone software
- Restore the original factory settings

If your issue remains unsolved, contact Nokia for repair options. Go to www.nokia.com/repair, or in Latin America, www.nokia-latinoamerica.com/centrosdeservicio. Before sending your phone for repair, always back up your data.

For additional product support information, see the warranty and reference leaflet included with your Nokia phone.

Nokia C3 in brief

Model number: Nokia C3-00

Key features

- Enjoy the messaging features with the full QWERTY keyboard.
- Manage your social networking profiles while on the move.
- Read and reply to your mail when out and about.
- Access the internet easily through a Wi-Fi network.
- View your correspondence with someone in the conversational messaging view.

Keys and parts

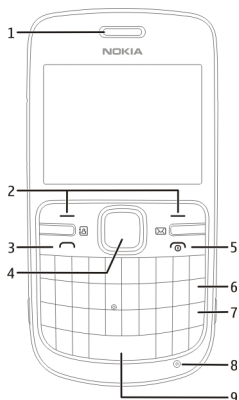

- 1 Earpiece
- 2 Selection keys
- 3 Call key
- 4 Navi™ key (scroll key)
- 5 End/Power key
- 6 Backspace key
- 7 Enter key
- 8 Microphone
- 9 Space key

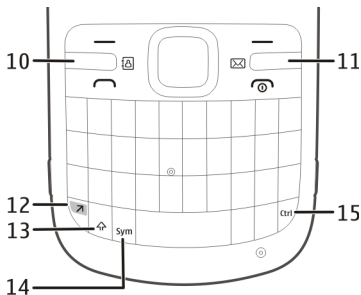

- 10 Contacts key
- 11 Messaging key

- 12 Function key
- 13 Shift key
- 14 Symbol key
- 15 Ctrl key

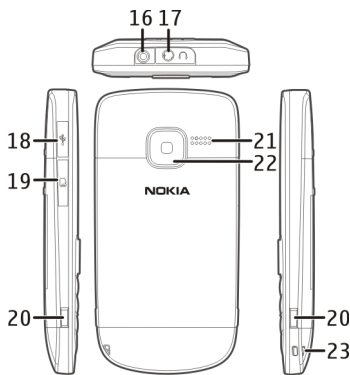

- 16 Charger connector
- 17 Headset connector/Nokia AV connector (3.5 mm)
- 18 Micro USB connector
- 19 Memory card slot
- 20 Release button
- 21 Loudspeaker
- 22 Camera lens
- 23 Wrist strap eyelet

Special key functions

- **Contacts key and messaging key.** To access some messaging or contacts features, press the contacts or messaging key. You can assign different functions to the keys.
- **Function key.** To change the writing language, press the function key, then the ctrl key.
- **Shift key.** To switch between the character cases, press the shift key. To copy or cut text, press and hold the shift key, and scroll to highlight the word, phrase, or line of text you want to copy or cut. Press and hold the ctrl key, and then press C (copy) or X (cut).
- **Symbol key.** To insert a special symbol, press the symbol key, and select the desired symbol.

Get started

Insert SIM card and battery

Safe removal. Always switch the device off and disconnect the charger before removing the battery.

! **Important:** Do not use a mini-UICC SIM card, also known as a micro-SIM card, a micro-SIM card with an adapter, or a SIM card that has a mini-UICC cutout (see figure) in this device. A micro-SIM card is smaller than the standard SIM card. This device does not support the use of micro-SIM cards and use of incompatible SIM cards may damage the card or the device, and may corrupt data stored on the card.



The SIM card and its contacts can be easily damaged by scratches or bending, so be careful when handling, inserting, or removing the card.

- 1 Press the back cover release buttons, and remove the back cover (1, 2). Remove the battery (3).

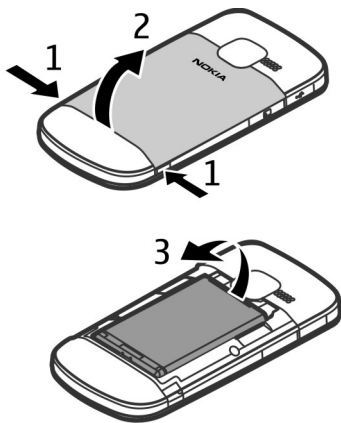

- 2 Make sure the contact area of the SIM card is facing down, and place the SIM card in the SIM card holder (4, 5, 6).

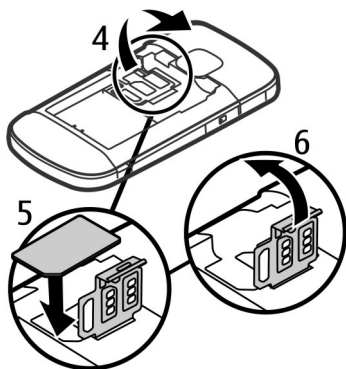

- 3 Replace the battery and back cover (7, 8, 9).

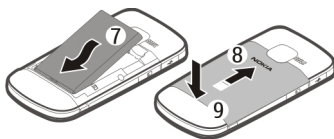

Switch on or off

Press and hold the power key.

Antennas

Your device may have internal and external antennas. Avoid touching the antenna area unnecessarily while the antenna is transmitting or receiving. Contact with antennas affects the communication quality and may cause a higher power level during operation and may reduce the battery life.

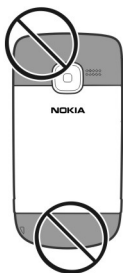

Charge the battery

Your battery has been partially charged at the factory. If the device indicates a low charge, do the following:

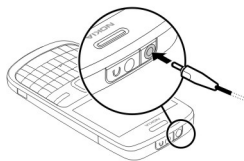

- 1 Connect the charger to a wall outlet.
- 2 Connect the charger to the device.
- 3 When the device indicates a full charge, disconnect the charger from the device, then from the wall outlet.

You do not need to charge the battery for a specific length of time, and you can use the device while it charges. If the battery is completely without charge, it may take several minutes before the charging indicator appears on the display or before any calls can be made.

Headset

Warning:

When you use the headset, your ability to hear outside sounds may be affected. Do not use the headset where it can endanger your safety.

When connecting any external device or any headset, other than those approved by Nokia for use with this device, to the Nokia AV Connector, pay special attention to volume levels.

Do not connect products that create an output signal as this may cause damage to the device. Do not connect any voltage source to the Nokia AV Connector.

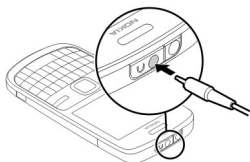

Insert a microSD card

Use only compatible microSD cards approved by Nokia for use with this device. Nokia uses approved industry standards for memory cards, but some brands may not be fully compatible with this device. Incompatible cards may damage the card and the device and corrupt data stored on the card.



Your phone supports microSD cards with a capacity of up to 8 GB.

A compatible memory card may be supplied with the device, and may already be inserted in the device. If not, do the following:

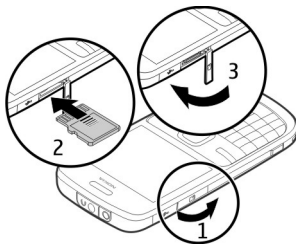

- 1 Open the cover of the memory card slot.
- 2 Insert the card into the memory card slot with the contact surface facing up, and press until it locks into place.
- 3 Close the cover of the memory card slot.

Remove the microSD card

! **Important:** Do not remove the memory card during an operation when the card is being accessed. Doing so may damage the memory card and the device, and corrupt data stored on the card.

You can remove or replace the memory card during phone operation without switching the device off, but you need to ensure that no application is currently accessing the memory card.

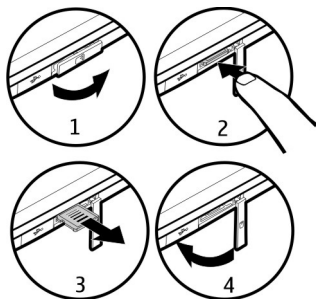

Connect a USB data cable

Connect a compatible USB data cable to the USB connector. You may need to purchase a USB data cable separately.

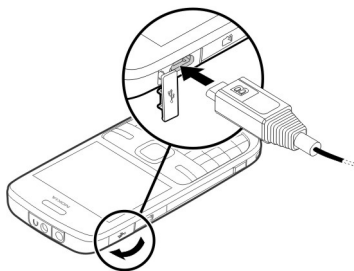

To modify the USB settings, select **Menu** > **Settings** > **Connectivity** > **USB data cable** and the desired mode.

Attach the wrist strap

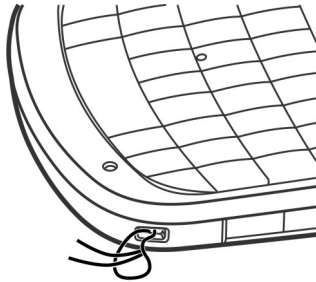

Thread the wrist strap as shown, and tighten it.

Access codes

The security code helps to protect your device against unauthorized use. You can create and change the code, and set the device to request the code. Keep the code secret and in a safe place separate from your device. If you forget the code and your device is locked, your device will require service. Additional charges may apply, and all the personal data in your device may be deleted. For more information, contact a Nokia Care point or your device dealer.

The PIN code supplied with the SIM card protects the card against unauthorised use. The PIN2 code supplied with some SIM cards is required to access certain services. If you enter the PIN or PIN2 code incorrectly three times in succession, you are asked for the PUK or PUK2 code. If you do not have them, contact your service provider.

The module PIN is required to access the information in the security module of your SIM card. The signing PIN may be required for the digital signature. The restriction password is required when using the call restriction service.

To set how your device uses the access codes and security settings, select **Menu > Settings > Security**.

PUK codes

The personal unblocking key (PUK) code and the universal personal unblocking key (UPUK) code (8 digits) are required to change a blocked PIN code and UPIN code, respectively. The PUK2 code (8 digits) is required to change a blocked PIN2 code. If the codes are not supplied with the SIM card, contact your local service provider for the codes.

Home screen

When the device is ready for use, and you have not entered any characters, the device is in the home screen.

Display

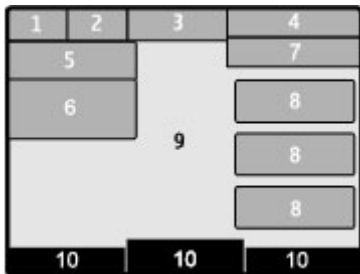

- 1 Network signal strength
- 2 Battery charge status
- 3 Indicators
- 4 Network name or the operator logo
- 5 Profile
- 6 Clock
- 7 Date (if the enhanced home screen is deactivated)
- 8 Widget
- 9 Display
- 10 Function of the selection key

Enhanced home screen

With the enhanced home screen, you can display a list of selected information and features that you can directly access.

Select **Menu** > **Settings and Display** > **Home screen**.

Activate the enhanced home screen

Select **Home screen mode** > **On**.

Organize and customize the enhanced home screen

Select **Personalize view**.

Select the key used to activate the enhanced home screen

Select **Home screen key**.

Navigate in the home screen

Scroll up or down to navigate the list, and select **Select**, **View**, or **Edit**. The arrows indicate that further information is available.

Stop navigating

Select **Exit**.

Add favorite contacts to the home screen

With the Favorite contacts widget, you can easily communicate with your family and friends.

- 1 To activate the enhanced home screen, select **Menu** > **Settings and Display** > **Home screen** > **Home screen mode** > **On**.
- 2 Select **Personalize view**. This step is not needed if there are currently no widgets added to the home screen.
- 3 Scroll to the desired content zone, and select **Change** or **Assign**.
- 4 Select **Favorite contacts**.

In the home screen, scroll to the Favorite contacts widget.

Add a favorite contact

Select **Options** > **Add new favorite**.

Call or send a text message to a favorite contact

Scroll to the contact, and select **Options** > **Call** or **Send message**.

Change the image for a favorite contact

Scroll to the contact, and select **Options** > **Change image**.

Organize your favorite contacts

Scroll to the contact, and select **Options** > **Organize favorites** > **Move**. Scroll to the new location, and select **OK**.

Remove a favorite contact

Scroll to the contact, and select **Options** > **Remove from favorites**.

Removing a favorite contact does not delete the contact from your contacts list.

Keypad lock

Lock the keypad

Select **Menu**, and press the function key within 3.5 seconds.

Unlock the keypad

Select **Unlock**, and press the function key within 3 seconds. If requested, enter the lock code.

Answer a call when the keypad is locked

Press the call key. When you end or reject a call, the keypad locks automatically.

Set automatic keypad lock

Select **Menu > Settings > Phone > Automatic keyguard > On**, and set the length of time, after which the keypad locks.

When the device or keypad is locked, calls may be possible to the official emergency number programmed into your device.

Use your device without a SIM card

Some features of your device may be used without inserting a SIM card, such as games. Features that are unavailable in the offline profile cannot be selected in menus.

Applications running in background

Leaving applications running in the background increases the demand on battery power and reduces the battery life.

Applications that usually run in the background are, for example, the Radio and Music player applications.

Calls

Make and answer a call

Make a call

Enter the phone number, including the country and area code if necessary, and press the call key.

Answer an incoming call

Press the call key.

Reject a call

Press the end key.

Adjust the volume

During a phone call, scroll up or down.

Loudspeaker

If available, you may select **Loudspeaker**. or **Handset** to use the loudspeaker or the earpiece of the phone during a call.

Warning:

Continuous exposure to high volume may damage your hearing. Listen to music at a moderate level, and do not hold the device near your ear when the loudspeaker is in use.

Dialing shortcuts

Assign a phone number to a number key

Select **Menu** > **Contacts** > **More** > **1-touch dialing**, scroll to a desired number (2-9), and select **Assign**. Enter the desired phone number, or select **Search** and a saved contact.

Activate speed dialling

Select **Menu** > **Settings** > **Call** > **1-touch dialing** > **On**.

Make a call using speed dialling

In the home screen, press and hold the desired number key.

Write text

The input methods provided in the device may vary according to different sales markets.

Write text using the keyboard

Your device has a full keyboard.

Set the writing language

Select **Options** > **Writing language** and the desired language. To change the writing language, you can also press the function key, then the ctrl key.

Switch between number and letter mode

Press the function key repeatedly, until the symbol for the desired input method is displayed.

Lock number mode

Press the function key twice.

Unlock number mode

Press the function key.

Switch between the character cases

Press the shift key.

Insert numbers or characters printed at the upper right corner of keys

Press and hold the corresponding key.

Delete a character

Select **Clear**. You can also press the backspace key.

Insert special symbols

Press the symbol key, and select the desired symbol. To view more symbols, press the symbol key again.

Insert a new line

Press the enter key.

Insert a space

Press the space key.

Copy or cut text

Press and hold the shift key, and scroll to highlight the word, phrase, or line of text you want to copy or cut. Press and hold the ctrl key, and then press **C** (copy) or **X** (cut).

Paste text

Go to the desired location, press and hold the ctrl key, and then press **V**.

Predictive text input

Predictive text input is based on a built-in dictionary. Not all languages are supported.

Activate or deactivate predictive text input

Select **Options** > **More** > **Prediction settings** > **Prediction** > **On** or **Off**.

Switch between predictive and traditional text input

Press and hold the ctrl key, and then press the space key.

You can also select and hold **Options**.

Write text with predictive text input

- 1 Start writing a word, using the character keys. Your device suggests possible words.
- 2 To confirm a word, scroll right or press the space key.
If the word is not correct, scroll down to access a list of suggested words, and select the desired word.
- 3 Start writing the next word.

Navigate the menus

The device functions are grouped into menus. Not all menu functions or option items are described here.

In the home screen, select **Menu** and the desired menu and submenu.

Exit the current menu level

Select **Exit** or **Back**.

Return to the home screen

Press the end key.

Change the menu view

Select **Menu** > **Options** > **Main menu view**.

Messaging

Create and receive messages, such as text and multimedia, with your device. The messaging services can only be used if your network or service provider supports them.

Text and multimedia messages

You can create a message and optionally attach, for example, a picture. Your phone automatically changes a text message to a multimedia message when a file is attached.

Text messages

Your device supports text messages beyond the limit for a single message. Longer messages are sent as two or more messages. Your service provider may charge accordingly. Characters with accents, other marks, or some language options take more space, and limit the number of characters that can be sent in a single message.

The total number of characters left and the number of messages needed for sending are displayed.

To send messages, the correct message centre number must be stored in your device. Normally, this number is set by default through your SIM card.

To set the number manually, do the following:

- 1 Select **Menu** > **Messaging** > **More** > **Message settings** > **Text messages** > **Message center**.
- 2 Enter the name and number supplied by your service provider.

Multimedia messages

A multimedia message can contain text, pictures, and sound or video clips.

Only devices that have compatible features can receive and display multimedia messages. The appearance of a message may vary depending on the receiving device.

The wireless network may limit the size of MMS messages. If the inserted picture exceeds this limit, the device may make it smaller so that it can be sent by MMS.

 **Important:** Exercise caution when opening messages. Messages may contain malicious software or otherwise be harmful to your device or PC.

For availability and subscription to the multimedia messaging service (MMS), contact your service provider.

Create a message

- 1 Select **Menu** > **Messaging** > **Create message**.
- 2 Write your message.
 - To insert a special character or a smiley, select **Options** > **Insert symbol**.
 - To attach an object to the message, select **Options** > **Insert object**. The message type changes automatically to multimedia message.
- 3 To add recipients, select **Send to** and a recipient.
 - To enter a phone number or mail address manually, select **Number or mail**. Enter a phone number, or select **Mail**, and enter a mail address.
- 4 Select **Send**.

Multimedia messages are indicated with an icon at the top of the display.

Service providers may charge differently depending on the message type. For details, contact your service provider.

Conversation view

Your device supports conversational messaging view. This feature displays text and multimedia messages received from and sent to a contact as a conversation. This allows you to view your correspondence with a contact, without opening different folders.

When you receive a message, it opens in the conversation view.

View a tracked conversation with a contact

Select **Menu** > **Messaging** > **Conversations** and the desired conversation.

Flash messages

Flash messages are text messages that are instantly displayed upon reception.

Select **Menu** > **Messaging**.

- 1 Select **More** > **Other messages** > **Flash message**.
- 2 Write your message.
- 3 Select **Send to** and a contact.

Nokia Xpress audio messages

Create and send audio messages using MMS in a convenient way.

Select **Menu** > **Messaging**.

- 1 Select **More** > **Other messages** > **Audio message**. The voice recorder opens.
- 2 To record your message, select .
- 3 To stop recording, select .
- 4 Select **Send to** and a contact.

Nokia Messaging Service

Your device may support the Nokia Messaging Service, which includes Mail and Chat for social networking.

- With Mail, you can use your cellular phone to access your mail accounts from different e-mail service providers.
- With Chat, you can use your cellular phone to chat with other online users.

To check if this messaging system is available, select **Menu** > **Mail**. If

NOKIA

is displayed at the top of the main view, the Nokia Messaging Service is in use.

This feature is not available in all countries. For details, contact your service provider.

Voice messages

The voice mailbox is a network service to which you may need to subscribe. For more information, contact your service provider.

Call your voice mailbox

Press and hold **1**.

Edit your voice mailbox number

Select **Menu > Messaging > More > Voice messages and Voice mailbox number**.

Message settings

Select **Menu > Messaging and More > Message settings**.

Select from the following:

General settings — Set the font size for messages, and activate graphical smileys and delivery reports.

Text messages — Set up message centers for text messages and SMS mail.

Multimedia messages — Allow delivery reports and the reception of multimedia messages and advertisements, and set up other preferences related to multimedia messages.

Service messages — Activate service messages and set up preferences related to service messages.

Contacts

You can save names and phone numbers in the device memory and on the SIM card. In the phone memory, you can save contacts with numbers and text items. Names and numbers saved in the SIM card memory are indicated with .

Select **Menu > Contacts > Names**.

Add a contact

Select **Options > Add new > Add new contact**.

Add details to a contact

Ensure that the memory in use is either **Phone** or **Phone and SIM**. Scroll to a contact, and select **Details > Options > Add detail**.

Search for a contact

Select **Names**. Scroll through the list of contacts, or enter the first characters of the contact's name.

Copy a contact between the device memory and SIM card

Select **Names**, scroll to the contact, and select **Options** > **More** > **Copy contact**. In the SIM card memory, you can save only one phone number per name.

To select the SIM card or device memory for your contacts, to select how the names and numbers in the contacts list are displayed, and to view the memory capacity for contacts, select **Settings** and the appropriate option.

You can send and receive a person's contact information as a business card from a compatible device that supports the vCard standard.

Send a business card

Select a contact, **Options** > **More** > **Business card**, and the sending type.

Music

Media player

Your device includes a media player for listening to songs or other MP3 or AAC sound files.

Warning:

Continuous exposure to high volume may damage your hearing. Listen to music at a moderate level, and do not hold the device near your ear when the loudspeaker is in use.

Select **Menu** > **Music** > **My music**.

Start or pause playing

Press the scroll key.

Skip to the beginning of the current song

Scroll left.

Skip to the previous song

Scroll left twice.

Skip to the next song

Scroll right.

Rewind the current song

Press and hold the scroll key to the left.

Fast-forward the current song

Press and hold the scroll key to the right.

Adjust the volume

Scroll up or down.

Mute or unmute the media player

Press #.

Leave the media player playing in the background

Press the call key.

Close the media player

Press and hold the end key.

FM radio

The FM radio depends on an antenna other than the wireless device antenna. A compatible headset or accessory needs to be attached to the device for the FM radio to function properly.

Warning:

Continuous exposure to high volume may damage your hearing. Listen to music at a moderate level, and do not hold the device near your ear when the loudspeaker is in use.

Select **Menu > Music > Radio**.

Search for a neighboring station

Press and hold the scroll key to the left or right.

Save a station

Tune to the desired station, and select **Options > Save station**.

Switch between saved stations

Scroll left or right to switch between stations, or press the corresponding number key of the memory location of a desired station.

Adjust the volume

Scroll up or down.

Leave the radio playing in the background

Press the end key.

Close the radio

Press and hold the end key.

Photos

Capture images and record videos

Your device supports an image capture resolution of 1600x1200 pixels.

Camera mode

Use the still image function

Select **Menu** > **Photos** > **Camera**.

Zoom in or out

Scroll up or down.

Capture an image

Select **Capture**.

Set the preview mode and time

Select **Options** > **Settings** > **Photo preview time**.

Activate the self-timer

Select **Options** and the desired option.

Video mode

Use the video function

Select **Menu** > **Photos** > **Video camera**.

Start recording a video

Select **Record**.

Switch between camera and video mode

In camera or video mode, scroll left or right.

View your images and videos

View your images

Select **Menu** > **Photos** > **My photos**.

Watch your videos

Select **Menu** > **Photos** > **My videos**.

Applications

Alarm clock

You can set an alarm to sound at a desired time.

Set the alarm

- 1 Select **Menu** > **Applications** > **Alarm clock**.
- 2 Set the alarm, and enter the alarm time.
- 3 To issue an alarm on selected days of the week, select **Repeat:** > **On** and the days.
- 4 Select the alarm tone. If you select the radio as the alarm tone, connect the headset to the device.
- 5 Set the length of the snooze time-out period, and select **Save**.

Stop the alarm

Select **Stop**. If you let the alarm sound for a minute or select **Snooze**, the alarm stops for the length of the snooze time-out period, then resumes.

Gallery

In Gallery, you can manage images, videos, and music files.

View the Gallery contents

Select **Menu** > **Applications** > **Gallery**.

Extras

Your device may include some games and Java™ applications specially designed for your device.

Select **Menu** > **Applications** > **Extras**.

Open a game or application

Select **Games**, **Collection**, or the memory card, and a game or an application.

View the amount of memory available for game and application installations

Select **Options** > **Memory status**.

Download a game or application

Select **Options** > **Downloads** > **Game downloads** or **App. downloads**.

Your device supports J2ME™ Java applications. Ensure that the application is compatible with your device before downloading it.

! **Important:** Only install and use applications and other software from sources that you trust. Applications from untrusted sources may include malicious software that can access data stored in your device, cause financial harm, or damage your device.

The downloaded applications may be saved in Gallery instead of Applications.

Voice recorder

Select **Menu** > **Applications** > **Voice recorder**.

Start recording

Select the record icon.

Start recording during a call

Select **Options** > **More** > **Record**. When recording a call, hold the phone in the normal position near to your ear. The recording is saved in the Recordings folder in Gallery.

Listen to the latest recording

Select **Options** > **Play last recorded**.

Send the last recording in a multimedia message

Select **Options** > **Send last recorded**.

To-do list

Select **Menu** > **Applications** > **To-do list**.

The to-do list is displayed and sorted by priority. To manage the to-do list, select **Options** and the appropriate option.

Calendar

Select **Menu** > **Calendar**.

The current day is framed. If there are any notes set for the day, the day is in bold.

Add a calendar note

Scroll to a date, and select **Options** > **Make a note**.

View the details of a note

Scroll to a note, and select **View**.

Delete all notes from the calendar

Select **Options** > **Delete notes** > **All notes**.

Settings

Profiles

Waiting for a call, but can't let your device ring? There are various settings groups called profiles, which you can customize with ringing tones for different events and environments.

Select **Menu** > **Settings** > **Profiles**.

Select the desired profile and from the following:

Activate — Activate the profile.

Customize — Modify the profile settings.

Timed — Set the profile to be active until a certain time. When the time set for the profile expires, the previous profile that was not timed becomes active.

Tones

You can edit the tone settings of the selected active profile.

Select **Menu** > **Settings** > **Tones**. You can find the same settings in the Profiles menu.

Display

To view or adjust the wallpaper, font size, or other features related to the device display, select **Menu** > **Settings** > **Display**.

Date and time

Select **Menu** > **Settings** > **Date and time**.

Set the date and time

Select **Date & time settings**.

Set the date and time format

Select **Date & time format**.

Update the time automatically according to the current time zone

Select **Auto-update of time** (network service).

Shortcuts

With personal shortcuts, you can get quick access to frequently used functions.

Select **Menu > Settings > My shortcuts**.

Assign functions to the selection keys

Select **Right selection key** or **Left selection key** and a function from the list.

Assign shortcut functions to the contacts or messaging key

Select **Contacts key** or **Messaging key** and a function from the list.

Assign shortcut functions to the scroll key

Select **Navigation key**. Scroll to the desired direction, and select **Change** or **Assign** and a function from the list.

Synchronization and backup

Select **Menu > Settings > Sync & backup**.

Select from the following:

Phone switch — Synchronize or copy selected data, such as your contacts, calendar entries, notes, or messages, between your device and another device.

Create backup — Back up selected data.

Restore backup — Restore data from a backup. To view the details of a backup file, select **Options > Details**.

Sync with server — Synchronize or copy selected data between your device and a PC or network server (network service).

Connectivity

Your phone has several features that allow you to connect to other devices to transmit and receive data. You can also connect the phone to a Wi-Fi network to access the internet.

Wi-Fi connectivity

You can use a Wi-Fi network to connect to the internet. You can search and connect to available networks, save and manage preferred networks, and modify connectivity settings.

Your device supports automatic Wi-Fi hotspot authentication and will automatically detect if this type of authentication is required to access the internet, for example, in some public places.

To save battery power, close your Wi-Fi connection when not in use. If a Wi-Fi connection is not used for about 5 minutes, it closes automatically.

Deactivating Bluetooth may improve Wi-Fi connection stability.

Features using Wi-Fi increase the demand on battery power and reduce the battery life.

 **Note:** Using Wi-Fi may be restricted in some countries. For example, in France, you are only allowed to use Wi-Fi indoors. For more information, contact your local authorities.

Connect to a Wi-Fi network

Select **Menu** > **Settings** > **Connectivity** > **Wi-Fi**.

Search for available Wi-Fi networks

Select **Available Wi-Fi** and the desired Wi-Fi network.

Update the Wi-Fi network list

Select **Options** > **Refresh list**.

Connect to a Wi-Fi network

Scroll to the Wi-Fi network, and select **Connect**.

Save a connected Wi-Fi network

Scroll to the Wi-Fi network, and select **Options** > **Save**.

Disconnect from a Wi-Fi network

Scroll to the Wi-Fi network, and select **Disconn..**

View saved Wi-Fi networks

Select **Saved Wi-Fi**.

Modify internet connection settings

Select **Internet connection** > **Ask first** or **Do not ask**. If you select **Ask first**, you are asked for the connection method every time you open an application that requires an internet connection, such as Browser or Mail. If you select **Do not ask**, the device

connects to a saved Wi-Fi, if available, when an application requires an internet connection.

Hidden Wi-Fi networks do not broadcast their service set identifier (SSID). They are marked as **(Hidden network)** in the list of available Wi-Fi networks. You can only connect to a hidden network if you know its SSID.

Connect to a hidden network

- 1 Select **(Hidden network)**.
- 2 Enter the SSID of the network, and select **OK**.

When you save the hidden network, it is displayed in the list of available Wi-Fi networks.

 **Important:** Always enable one of the available encryption methods to increase the security of your wireless LAN connection. Using encryption reduces the risk of unauthorized access to your data.

Saved Wi-Fi

Display, manage, connect to, and prioritize your saved Wi-Fi networks.

Select **Menu** > **Settings** > **Connectivity** > **Wi-Fi and Saved Wi-Fi**.

The Wi-Fi network with the highest priority is listed first.

Manage your Wi-Fi

Select **Options** and from the following:

Connect — Connect to the Wi-Fi network manually.

Remove from list — Remove the Wi-Fi network.

Organize priority — Change the priorities of saved Wi-Fi networks.

Forward settings — Forward the settings of a saved Wi-Fi network. Enter the security code and phone number, and select **Send**.

Add new network — Add a new Wi-Fi network, and define the settings.

Edit Wi-Fi parameters

Scroll to a Wi-Fi network, and select **Edit** and from the following:

Connection method — Connect to an available Wi-Fi network automatically.

Network name — Enter a name for the Wi-Fi network.

Network settings — Define the Wi-Fi settings.

Bluetooth wireless technology

Bluetooth technology allows you to connect your device, using radio waves, to a compatible Bluetooth device or accessory that is within 10 meters (32 feet).

Select **Menu > Settings > Connectivity > Bluetooth**.

Set up a Bluetooth connection

- 1 Select **My phone's name**, and enter a name for your device.
- 2 Select **Bluetooth > On**.  indicates that Bluetooth connectivity is active.
- 3 To connect your device to an audio accessory, select **Conn. to audio acc.** and the device that you want to connect to.
- 4 To pair your device with any Bluetooth device in range, select **Paired devices > Add new device**.
Scroll to a found device, and select **Add**.
Enter a passcode (up to 16 characters) on your device, and allow the connection on the other Bluetooth device.

If you are concerned about security, deactivate the Bluetooth function, or set **Phone visibility** to **Hidden**. Accept Bluetooth communication only from those you trust.

Connect your PC to the internet

You can use Bluetooth technology to connect your compatible PC to the internet without the PC Suite software. Your device must be able to connect to the internet (network service), and your PC must support Bluetooth technology. After connecting to the network access point (NAP) service of the device, and pairing with your PC, your device automatically opens a GPRS connection to the internet.

This device is compliant with Bluetooth Specification 2.1 + EDR supporting the following profiles: generic access, hands-free, headset, object push, file transfer, dial-up networking, serial port, SIM access, and generic object exchange. To ensure interoperability between other devices supporting Bluetooth technology, use Nokia approved accessories for this model. Check with the manufacturers of other devices to determine their compatibility with this device.

Features using Bluetooth technology increase the demand on battery power and reduce the battery life.

Packet data

General packet radio service (GPRS) is a network service that allows cellular phones to send and receive data over an internet protocol (IP) based network.

To define how to use the service, select **Menu > Settings > Connectivity > Packet data > Packet data connection** and from the following:

When needed — Establish a GPRS connection when needed by an application. The connection is closed when the application is closed.

Always online — Automatically connect to a GPRS network when you switch the device on.

You can use your device as a modem by connecting it to a compatible PC using Bluetooth technology. For details, see the Nokia PC Suite documentation.

Call and phone

Select **Menu > Settings > Call**.

Divert incoming calls

Select **Call forwarding** (network service). For details, contact your service provider.

Automatically redial ten times after an unsuccessful attempt

Select **Automatic redial > On**.

Get a notification of incoming calls while you are on a call

Select **Call waiting > Activate** (network service).

Display or hide your number to the person you are calling

Select **Send my caller ID** (network service).

Select **Menu > Settings > Phone**.

Set the display language

Select **Language settings > Phone language**.

Accessories

This menu is only available if the device is or has been connected to a compatible accessory.

Select **Menu > Settings > Accessories**. Select an accessory and an option, depending on the accessory.

Hearing aid

Optimize the sound quality when using a T-coil hearing aid

Select **Hearing aid > T-coil hearing aid > On**.  indicates that T-coil hearing aid is active.

Configuration

You can configure your device with settings that are required for certain services. Your service provider may also send you these settings.

Select **Menu > Settings and Configuration**

Select from the following:

Default config. settings — View the service providers saved in the device, and set a default service provider.

Activate def. in all apps. — Activate the default configuration settings for supported applications.

Preferred access point — View the saved access points.

Personal settings — Add new personal accounts for various services, and activate or delete them. To add a new personal account, select **Add new** or **Options > Add new**. Select the service type, and enter the required information. To activate a personal account, scroll to the account, and select **Options > Activate**.

Restore factory settings

To restore the device back to the default settings, select **Menu > Settings > Rest. factory sett.**

To reset all preference settings without deleting any personal data, select **Settings only**.

To reset all preference settings and delete all personal data, such as contacts, messages, media files, and activation keys, select **All**.

About Ovi Browser

Select **Menu > Applications > Collection > Internet**.

Catch up on the news and visit your favorite websites. You can use Ovi Browser to view web pages on the internet.

Ovi Browser compresses and optimizes web content for your device, so you can browse the web more quickly and save on data costs.

To browse the web, you must have an internet access point configured in your device and be connected to a network.

For availability, pricing, and instructions, contact your service provider.

You may receive the configuration settings required for browsing as a configuration message from your service provider.

Operator menu

Access a portal to services provided by your network operator. For more information, contact your network operator. The operator can update this menu with a service message.

SIM services

Your SIM card may provide additional services. You can access this menu only if it is supported by your SIM card. The name and contents of the menu depend on the available services.

Protect the environment

Save energy

You do not need to charge your battery so often if you do the following:

- Close applications and data connections, such as your Wi-Fi or Bluetooth connection, when not in use.
- Turn off unnecessary sounds, such as key tones.

Recycle



When this phone has reached the end of its working life, all of its materials can be recovered as materials and energy. To guarantee the correct disposal and reuse, Nokia co-operates with its partners through a program called We:recycle. For information on how to recycle your old Nokia products and where to find collection sites, go to www.nokia.com/werecycle, or call the Nokia Contact Center.

Recycle packaging and user guides at your local recycling scheme.

For more information on the environmental attributes of your phone, go to www.nokia.com/ecoprofile.

Product and safety information

General information

About your device

The wireless device described in this guide is approved for use on the (E)GSM 850, 900, 1800, and 1900 MHz networks. Contact your service provider for more information about networks.

Your device may have preinstalled bookmarks and links for third-party internet sites and may allow you to access third-party sites. These are not affiliated with Nokia, and Nokia does not endorse or assume liability for them. If you access such sites, take precautions for security or content.

Warning:

To use any features in this device, other than the alarm clock, the device must be switched on. Do not switch the device on when wireless device use may cause interference or danger.

When using this device, obey all laws and respect local customs, privacy and legitimate rights of others, including copyrights. Copyright protection may prevent some images, music, and other content from being copied, modified, or transferred.

Make back-up copies or keep a written record of all important information stored in your device.

When connecting to any other device, read its user guide for detailed safety instructions. Do not connect incompatible products.

The images in this guide may differ from your device display.

Refer to the user guide for other important information about your device.

Network services

To use the device you must have service from a wireless service provider. Some features are not available on all networks; other features may require that you make specific arrangements with your service provider to use them. Network services involve transmission of data. Check with your service provider for details about fees in your home network and when roaming on other networks. Your service provider can explain what charges will apply. Some networks may have limitations that affect how you can use some features of this device requiring network support such as support for specific technologies like WAP 2.0 protocols (HTTP and SSL) that run on TCP/IP protocols and language-dependent characters.

Your service provider may have requested that certain features be disabled or not activated in your device. If so, these features will not appear on your device menu. Your device may also have customized items such as menu names, menu order, and icons.

Shared memory

The following features in this device may share memory: multimedia messaging (MMS). Use of one or more of these features may reduce the memory available for the remaining features. If your device displays a message that the memory is full, delete some of the information stored in the shared memory.

Accessories

Warning:

Use only batteries, chargers, and accessories approved by Nokia for use with this particular model. The use of any other types may invalidate any approval or guarantee, and may be dangerous. In particular, use of unapproved chargers or batteries may present a risk of fire, explosion, leakage, or other hazard.

For availability of approved accessories, please check with your dealer. When you disconnect the power cord of any accessory, grasp and pull the plug, not the cord.

Battery**Battery and charger information**

Your device is powered by a rechargeable battery. The battery intended for use with this device is BL-5J. Nokia may make additional battery models available for this device. This device is intended for use when supplied with power from the following chargers: AC-3. The exact charger model number may vary depending on the type of plug. The plug variant is identified by one of the following: E, EB, X, AR, U, A, C, K, or UB.

The battery can be charged and discharged hundreds of times, but it will eventually wear out. When the talk and standby times are noticeably shorter than normal, replace the battery. Use only Nokia approved batteries, and recharge your battery only with Nokia approved chargers designated for this device.

If a battery is being used for the first time or if the battery has not been used for a prolonged period, it may be necessary to connect the charger, then disconnect and reconnect it to begin charging the battery. If the battery is completely discharged, it may take several minutes before the charging indicator appears on the display or before any calls can be made.

Safe removal. Always switch the device off and disconnect the charger before removing the battery.

Proper charging. Unplug the charger from the electrical plug and the device when not in use. Do not leave a fully charged battery connected to a charger, since overcharging may shorten its lifetime. If left unused, a fully charged battery will lose its charge over time.

Avoid extreme temperatures. Always try to keep the battery between 59°F and 77°F (15°C and 25°C). Extreme temperatures reduce the capacity and lifetime of the battery. A device with a hot or cold battery may not work temporarily. Battery performance is particularly limited in temperatures well below freezing.

Do not short-circuit. Accidental short-circuiting can occur when a metallic object such as a coin, clip, or pen causes direct connection of the positive (+) and negative (-) terminals of the battery. (These look like metal strips on the battery.) This might happen, for example, when you carry a spare battery in your pocket or purse. Short-circuiting the terminals may damage the battery or the connecting object.

Disposal. Do not dispose of batteries in a fire as they may explode. Dispose of batteries according to local regulations. Please recycle when possible. Do not dispose as household waste.

Leak. Do not dismantle, cut, open, crush, bend, puncture, or shred cells or batteries. In the event of a battery leak, prevent battery liquid contact with skin or eyes. If this happens, flush the affected areas immediately with water, or seek medical help.

Damage. Do not modify, remanufacture, attempt to insert foreign objects into the battery or immerse or expose it to water or other liquids. Batteries may explode if damaged.

Correct use. Use the battery only for its intended purpose. Improper battery use may result in a fire, explosion, or other hazard. If the device or battery is dropped, especially on a hard surface, and you believe the battery has been damaged, take it to a service center for inspection before continuing to use it. Never use any charger or battery that is damaged. Keep your battery out of the reach of small children.

Take care of your device

Handle your device, battery, charger and accessories with care. The following suggestions help you protect your warranty coverage.

- Keep the device dry. Precipitation, humidity, and all types of liquids or moisture can contain minerals that corrode electronic circuits. If your device gets wet, remove the battery, and allow the device to dry.
- Do not use or store the device in dusty or dirty areas. Moving parts and electronic components can be damaged.
- Do not store the device in high temperatures. High temperatures can shorten the life of the device, damage the battery, and warp or melt plastics.
- Do not store the device in cold temperatures. When the device warms to its normal temperature, moisture can form inside the device and damage electronic circuits.

38 Product and safety information

- Do not attempt to open the device other than as instructed in the user guide.
- Unauthorized modifications may damage the device and violate regulations governing radio devices.
- Do not drop, knock, or shake the device. Rough handling can break internal circuit boards and mechanics.
- Only use a soft, clean, dry cloth to clean the surface of the device.
- Do not paint the device. Paint can clog moving parts and prevent proper operation.
- Switch off the device and remove the battery from time to time for optimum performance.
- Keep your device away from magnets or magnetic fields.
- To keep your important data safe, store it in at least two separate places, such as your device, memory card, or computer, or write down important information.

Recycle

Always return your used electronic products, batteries, and packaging materials to dedicated collection points. This way you help prevent uncontrolled garbage disposal and promote the recycling of materials. Check how to recycle your Nokia products at www.nokia.com/recycling.

About Digital Rights Management

When using this device, obey all laws and respect local customs, privacy and legitimate rights of others, including copyrights. Copyright protection may prevent you from copying, modifying, or transferring pictures, music, and other content.

Content owners may use different types of digital rights management (DRM) technologies to protect their intellectual property, including copyrights. This device uses various types of DRM software to access DRM-protected content. With this device you can access content protected with WMDRM 10, OMA DRM 1.0, OMA DRM 1.0 forward lock, and OMA DRM 2.0. If certain DRM software fails to protect the content, content owners may ask that such DRM software's ability to access new DRM-protected content be revoked. Revocation may also prevent renewal of such DRM-protected content already in your device. Revocation of such DRM software does not affect the use of content protected with other types of DRM or the use of non-DRM-protected content.

Digital rights management (DRM) protected content comes with an associated license that defines your rights to use the content.

Other transfer methods may not transfer the licenses which need to be restored with the content for you to be able to continue the use of OMA DRM-protected content after the device memory is formatted. You may also need to restore the licenses if the files on your device become corrupted.

If your device has WMDRM-protected content, both the licenses and the content are lost if the device memory is formatted. You may also lose the licenses and the content if the files on your device become corrupted. Losing the licenses or the content may limit your ability to use the same content on your device again. For more information, contact your service provider.

Some licenses may be connected to a specific SIM card, and the protected content can be accessed only if the SIM card is inserted in the device.

Additional safety information

The surface of this device is nickel-free.

Small children

Your device and its accessories are not toys. They may contain small parts. Keep them out of the reach of small children.

Operating environment

This device meets RF exposure guidelines in the normal use position at the ear or at least 1.5 centimeters (5/8 inch) away from the body. Any carry case, belt clip, or holder for body-worn operation should not contain metal and should position the device the above-stated distance from your body.

To send data files or messages requires a quality connection to the network. Data files or messages may be delayed until such a connection is available. Follow the separation distance instructions until the transmission is completed.

Parts of the device are magnetic. Metallic materials may be attracted to the device. Do not place credit cards or other magnetic storage media near the device, because information stored on them may be erased.

Medical devices

Operation of radio transmitting equipment, including wireless phones, may interfere with the function of inadequately protected medical devices. Consult a physician or the manufacturer of the medical device to determine whether they are adequately shielded from external RF energy. Switch off your device when regulations posted instruct you to do so. Hospitals or health care facilities may use equipment sensitive to external RF energy.

Implanted medical devices

Manufacturers of medical devices recommend a minimum separation of 15.3 centimeters (6 inches) between a wireless device and an implanted medical device, such as a pacemaker or implanted cardioverter defibrillator, to avoid potential interference with the medical device. Persons who have such devices should:

- Always keep the wireless device more than 15.3 centimeters (6 inches) from the medical device.
- Not carry the wireless device in a breast pocket.
- Hold the wireless device to the ear opposite the medical device.
- Turn the wireless device off if there is any reason to suspect that interference is taking place.
- Follow the manufacturer directions for the implanted medical device.

If you have any questions about using your wireless device with an implanted medical device, consult your health care provider.

Hearing aids

Some digital wireless devices may interfere with some hearing aids.

Your mobile device model complies with FCC rules governing hearing aid compatibility. These require a M3 microphone or higher value. Your device M-value is shown on the box. A higher M-value generally indicates that a device model has a lower RF emissions level, which may improve the likelihood that the device will operate with certain hearing aids. Some hearing aids are more immune than others to interference. Please consult your hearing health professional to determine whether your hearing aid will work with this device. More information on accessibility can be found at www.nokiaaccessibility.com.

Accessibility solutions

Nokia is committed to making mobile phones easy to use for all individuals, including those with disabilities. For more information, visit the Nokia website at www.nokiaaccessibility.com.

Hearing

 **Warning:**
When you use the headset, your ability to hear outside sounds may be affected. Do not use the headset where it can endanger your safety.

Some wireless devices may interfere with some hearing aids.

Vehicles

RF signals may affect improperly installed or inadequately shielded electronic systems in motor vehicles such as electronic fuel injection, electronic antilock braking, electronic speed control, and air bag systems. For more information, check with the manufacturer of your vehicle or its equipment.

Only qualified personnel should service the device or install the device in a vehicle. Faulty installation or service may be dangerous and may invalidate your warranty. Check regularly that all wireless device equipment in your vehicle is mounted and operating properly. Do not store or carry flammable liquids, gases, or explosive materials in the same compartment as the

40 Product and safety information

device, its parts, or accessories. Remember that air bags inflate with great force. Do not place your device or accessories in the air bag deployment area.

Switch off your device before boarding an aircraft. The use of wireless teledevices in an aircraft may be dangerous to the operation of the aircraft and may be illegal.

Potentially explosive environments

Switch off your device in any area with a potentially explosive atmosphere. Obey all posted instructions. Sparks in such areas could cause an explosion or fire resulting in bodily injury or death. Switch off the device at refueling points such as near gas pumps at service stations. Observe restrictions in fuel depots, storage, and distribution areas; chemical plants; or where blasting operations are in progress. Areas with a potentially explosive atmosphere are often, but not always, clearly marked. They include areas where you would be advised to turn off your vehicle engine, below deck on boats, chemical transfer or storage facilities and where the air contains chemicals or particles such as grain, dust, or metal powders. You should check with the manufacturers of vehicles using liquefied petroleum gas (such as propane or butane) to determine if this device can be safely used in their vicinity.

Emergency calls

 **Important:** This device operates using radio signals, wireless networks, landline networks and user-programmed functions. If your device supports voice calls over the internet (internet calls), activate both the internet calls and the cellular phone. The device may attempt to make emergency calls over both the cellular networks and through your internet call provider if both are activated. Connections in all conditions cannot be guaranteed. You should never rely solely on any wireless device for essential communications like medical emergencies.

To make an emergency call:

- 1 If the device is not on, switch it on. Check for adequate signal strength. Depending on your device, you may also need to complete the following:
 - Insert a SIM card if your device uses one.
 - Remove certain call restrictions you have activated in your device.
 - Change your profile from Offline or Flight profile to an active profile.
- 2 Press the end key as many times as needed to clear the display and ready the device for calls.
- 3 Enter the official emergency number for your present location. Emergency numbers vary by location.
- 4 Press the call key.

When making an emergency call, give all the necessary information as accurately as possible. Your wireless device may be the only means of communication at the scene of an accident. Do not end the call until given permission to do so.

Certification information (SAR)

This mobile device meets guidelines for exposure to radio waves.

Your mobile device is a radio transmitter and receiver. It is designed not to exceed the limits for exposure to radio waves recommended by international guidelines. These guidelines were developed by the independent scientific organization ICNIRP and include safety margins designed to assure the protection of all persons, regardless of age and health.

The exposure guidelines for mobile devices employ a unit of measurement known as the Specific Absorption Rate or SAR. The SAR limit stated in the ICNIRP guidelines is 2.0 watts/kilogram (W/kg) averaged over 10 grams of tissue. Tests for SAR are conducted using standard operating positions with the device transmitting at its highest certified power level in all tested frequency bands. The actual SAR level of an operating device can be below the maximum value because the device is designed to use only the power required to reach the network. That amount changes depending on a number of factors such as how close you are to a network base station.

The highest SAR value under the ICNIRP guidelines for use of the device at the ear is 1.09 W/kg .

Use of device accessories may result in different SAR values. SAR values may vary depending on national reporting and testing requirements and the network band. Additional SAR information may be provided under product information at www.nokia.com.

Your mobile device is also designed to meet the requirements for exposure to radio waves established by the Federal Communications Commission (USA) and Industry Canada. These requirements set a SAR limit of 1.6 W/kg averaged over one gram of tissue. The highest SAR value reported under this standard during product certification for use at the ear is 1.11 W/kg and when properly worn on the body is 0.87 W/kg .

Copyright and other notices

DECLARATION OF CONFORMITY

CE 0434 Ⓢ

Hereby, NOKIA CORPORATION declares that this RM-614 product is in compliance with the essential requirements and other relevant provisions of Directive 1999/5/EC. A copy of the Declaration of Conformity can be found at http://www.nokia.com/phones/declaration_of_conformity/.

© 2011 Nokia. All rights reserved.

Nokia, Nokia Connecting People, and Navi are trademarks or registered trademarks of Nokia Corporation. Nokia tune is a sound mark of Nokia Corporation. Other product and company names mentioned herein may be trademarks or tradenames of their respective owners.

Reproduction, transfer, distribution, or storage of part or all of the contents in this document in any form without the prior written permission of Nokia is prohibited. Nokia operates a policy of continuous development. Nokia reserves the right to make changes and improvements to any of the products described in this document without prior notice.



Includes RSA BSAFE cryptographic or security protocol software from RSA Security.



Java and all Java-based marks are trademarks or registered trademarks of Sun Microsystems, Inc.

This product is licensed under the MPEG-4 Visual Patent Portfolio License (i) for personal and noncommercial use in connection with information which has been encoded in compliance with the MPEG-4 Visual Standard by a consumer engaged in a personal and noncommercial activity and (ii) for use in connection with MPEG-4 video provided by a licensed video provider. No license is granted or shall be implied for any other use. Additional information, including that related to promotional, internal, and commercial uses, may be obtained from MPEG LA, LLC. See <http://www.mpegla.com>.

TO THE MAXIMUM EXTENT PERMITTED BY APPLICABLE LAW, UNDER NO CIRCUMSTANCES SHALL NOKIA OR ANY OF ITS LICENSORS BE RESPONSIBLE FOR ANY LOSS OF DATA OR INCOME OR ANY SPECIAL, INCIDENTAL, CONSEQUENTIAL OR INDIRECT DAMAGES HOWSOEVER CAUSED.

THE CONTENTS OF THIS DOCUMENT ARE PROVIDED "AS IS". EXCEPT AS REQUIRED BY APPLICABLE LAW, NO WARRANTIES OF ANY KIND, EITHER EXPRESS OR IMPLIED, INCLUDING, BUT NOT LIMITED TO, THE IMPLIED WARRANTIES OF MERCHANTABILITY AND FITNESS FOR

42 Copyright and other notices

A PARTICULAR PURPOSE, ARE MADE IN RELATION TO THE ACCURACY, RELIABILITY OR CONTENTS OF THIS DOCUMENT. NOKIA RESERVES THE RIGHT TO REVISE THIS DOCUMENT OR WITHDRAW IT AT ANY TIME WITHOUT PRIOR NOTICE.

The availability of particular products and applications and services for these products may vary by region. Please check with your Nokia dealer for details and availability of language options. This device may contain commodities, technology or software subject to export laws and regulations from the US and other countries. Diversion contrary to law is prohibited.

The third-party applications provided with your device may have been created and may be owned by persons or entities not affiliated with or related to Nokia. Nokia does not own the copyrights or intellectual property rights to the third-party applications. As such, Nokia does not take any responsibility for end-user support, functionality of the applications, or the information in the applications or these materials. Nokia does not provide any warranty for the third-party applications.

BY USING THE APPLICATIONS YOU ACKNOWLEDGE THAT THE APPLICATIONS ARE PROVIDED AS IS WITHOUT WARRANTY OF ANY KIND, EXPRESS OR IMPLIED, TO THE MAXIMUM EXTENT PERMITTED BY APPLICABLE LAW. YOU FURTHER ACKNOWLEDGE THAT NEITHER NOKIA NOR ITS AFFILIATES MAKE ANY REPRESENTATIONS OR WARRANTIES, EXPRESS OR IMPLIED, INCLUDING BUT NOT LIMITED TO WARRANTIES OF TITLE, MERCHANTABILITY OR FITNESS FOR A PARTICULAR PURPOSE, OR THAT THE APPLICATIONS WILL NOT INFRINGE ANY THIRD-PARTY PATENTS, COPYRIGHTS, TRADEMARKS, OR OTHER RIGHTS.

FCC/INDUSTRY CANADA NOTICE

Your device may cause TV or radio interference (for example, when using a telephone in close proximity to receiving equipment). The FCC or Industry Canada can require you to stop using your telephone if such interference cannot be eliminated. If you require assistance, contact your local service facility. This device complies with part 15 of the FCC rules. Operation is subject to the following two conditions: (1) This device may not cause harmful interference, and (2) this device must accept any interference received, including interference that may cause undesired operation. Any changes or modifications not expressly approved by Nokia could void the user's authority to operate this equipment.

/Issue 3.1 EN-US

Index**A**

access codes	13
accessories	33
alarm clock	26
antennas	9
audio messages	21

B

backing up data	29
battery	8
— charging	10
battery charge level	14
Bluetooth	32
browser	
<i>See web browser</i>	
business cards	22

C

cable connection	12
calendar	27
calls	16
camera	25
configuration	34
connectivity	30
contacts	15, 22
conversation view	21

D

date and time	28
display settings	28

E

environmental tips	35
extras	26

F

factory settings, restoring	34
flash messages	21

G

Gallery	26
games	26

H

headset	10
hearing aid	33
home screen	14

I

image mode	25
images	26
indicators	14
internet	
<i>See web browser</i>	

K

keyboard	17
keyguard	16
keypad lock	16
keys and parts	6

M

media player	23
memory card	11
menus	19
message center number	19
Message settings	22
messages	20, 21
microSD card	11

N

Nokia Messaging Service	21
Nokia support information	5

O

offline profile	16
operator menu	35
Ovi Browser	34

P

passwords	13
PIN code	13
powering device on/off	9
profiles	28
PUK codes	13

R

recycling	35
restoring settings	34

S

security code	13
settings	28
— phone	33
settings, display	28
shortcuts	29
signal strength	14
SIM card	8, 16
speed dialling	17
support	5
switching device on/off	9
synchronization	29

T

text input	17, 18
text messages	19
to-do notes	27
tones	28
turning device on/off	9

U

USB connection	12
----------------	----

V

video mode	25
videos	26
voice messages	22
voice recorder	27

W

web browser	34
Wi-Fi	30, 31
Wi-Fi network	30
write text	17