

# QuickStart Guide

## D-580ZOOM / C-460ZOOM / X-400

OLYMPUS AMERICA INC.  
Two Corporate Center Drive, Melville,  
NY 11747-3157, U.S.A.  
<http://www.olympusamerica.com/support>

Olympus Europa GmbH  
Wendenstrasse 14-18,  
20097 Hamburg, Germany  
<http://www.olympus-europa.com>

# OLYMPUS

<http://www.olympus.com/>

# START HERE

It is strongly recommended that you follow these step-by-step numbered instructions to set up and quickly begin using your new Digital camera.

For more detailed instructions on advanced features, please refer to the printed Basic Manual included in your package, or the Reference Manual on the CD-ROM.

## 1 UNPACKING THE BOX CONTENTS

Gather your Digital camera and the parts as shown in the illustration. You'll need these to complete the steps for the camera set-up procedures that follow. The items, such as batteries, supplied with the camera may differ depending on the area you purchase the product.

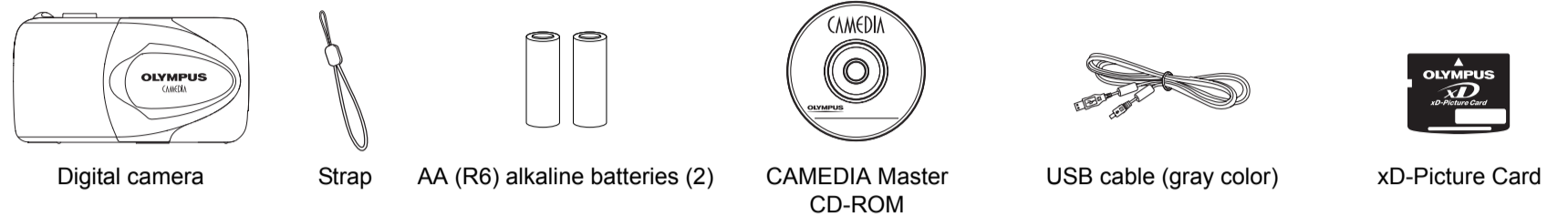

The following items are also included in the Digital camera package: Basic Manual, AV cable, warranty card, registration card (not provided in some areas), and safety precautions booklet.

## 2 PREPARING THE CAMERA FOR USE

Before you begin using your Olympus Digital camera...

### a. Loading the battery

**Note: The batteries and xD-Picture card compartments are accessed by opening the respective compartment covers.**

- Close the lens barrier.
- Slide the battery compartment cover to the direction of the arrow, and lift open the cover as shown in the illustration.
- Insert the batteries into the compartment.
- Close the battery compartment cover so that it pushes the battery in and slide the cover while pressing the mark.

**Note: If the battery compartment cover is hard to close, do not force it. Press on the cover firmly to close the cover, and then slide it into position.**

- To remove the batteries, make sure that the monitor and the lamps at the side of the viewfinder are off.

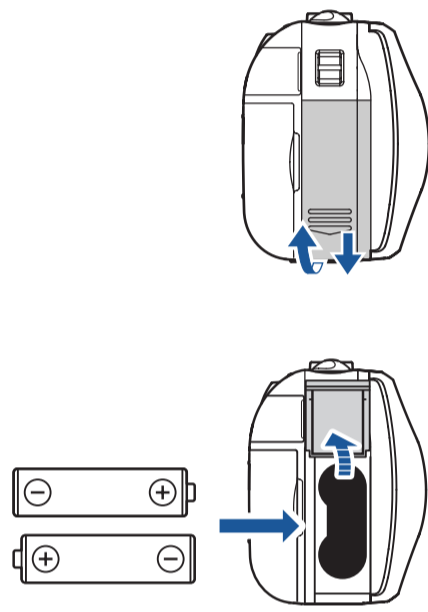

### b. Inserting the xD-Picture Card

The xD-Picture Card is where the camera stores your pictures and is available in a variety of memory capacities. The pictures you take with the camera remain on the xD-Picture Card even when the camera is turned off and/or the batteries are removed.

- Open the card cover.
- Face the card the correct way and insert it into the card slot.
- Insert the xD-Picture Card into the spring-loaded card slot as shown in the illustration. Push the card fully into the slot. The card will lock into place when fully inserted.
- To remove, push the card all the way in to unlock it, then let it return slowly.
- Close the card cover securely.

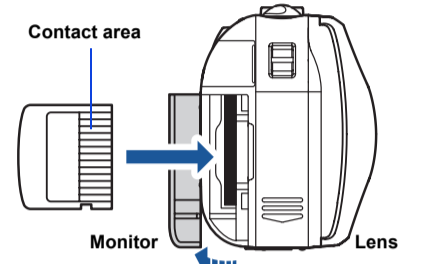

Confirm you have installed the battery and xD-Picture Card properly by pressing . The "NO PICTURE" message should be displayed in the monitor. Turn the camera off by pressing again.

### c. Attaching the strap (OPTIONAL)

Attach the strap as illustrated to make the camera easier to handle.

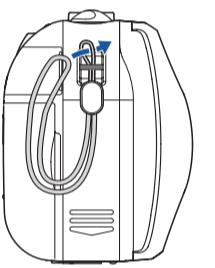

## 3 TURNING ON THE CAMERA

All you need to do is slide the lens barrier open or closed to turn the camera ON or OFF.

### a. Turning the camera ON (SHOOTING MODE)

- Slide the lens barrier open fully until it clicks. The lens extends and the subject is displayed on the monitor.
- To turn the camera off, slide the lens barrier until you feel the first click. Wait until the lens is fully retracted, then close the lens barrier all the way.

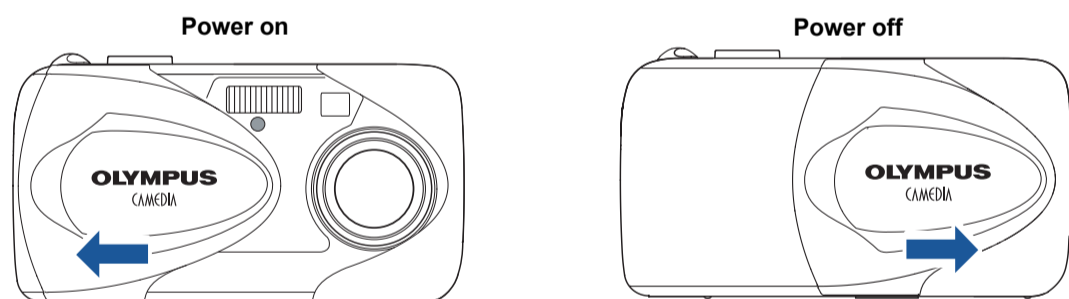

**TIP** To maximize battery life, the built-in power-saver operates, and the camera enters sleep mode after approximately three (3) minutes of non-use.

### b. Setting the Date and Time (OPTIONAL)

Set the date and time before using the camera for the first time. This affects the way image file names are created, and will conveniently include this information with each picture.

- With the front lens barrier closed, press once. The monitor will turn on with "NO PICTURE" displayed in the monitor. The date and time can also be set when the camera is in the shooting mode.
- Press to display the top menu.
- Press to select MODE MENU.
- Press to select SETUP, and then press .
- Press to select , and then press .
- Use to select the date format.
- Adjust the date and time in the appropriate fields by using to select the field, and to set the proper value. Repeat this step until all date/time fields have been set.

**Note: Time is entered using the 24-hour format.**

- Press twice to set the date and time and exit the menu.

### c. Camera Diagram and Controls

Now take a moment to familiarize yourself with the key areas of camera controls by reviewing the illustrations.

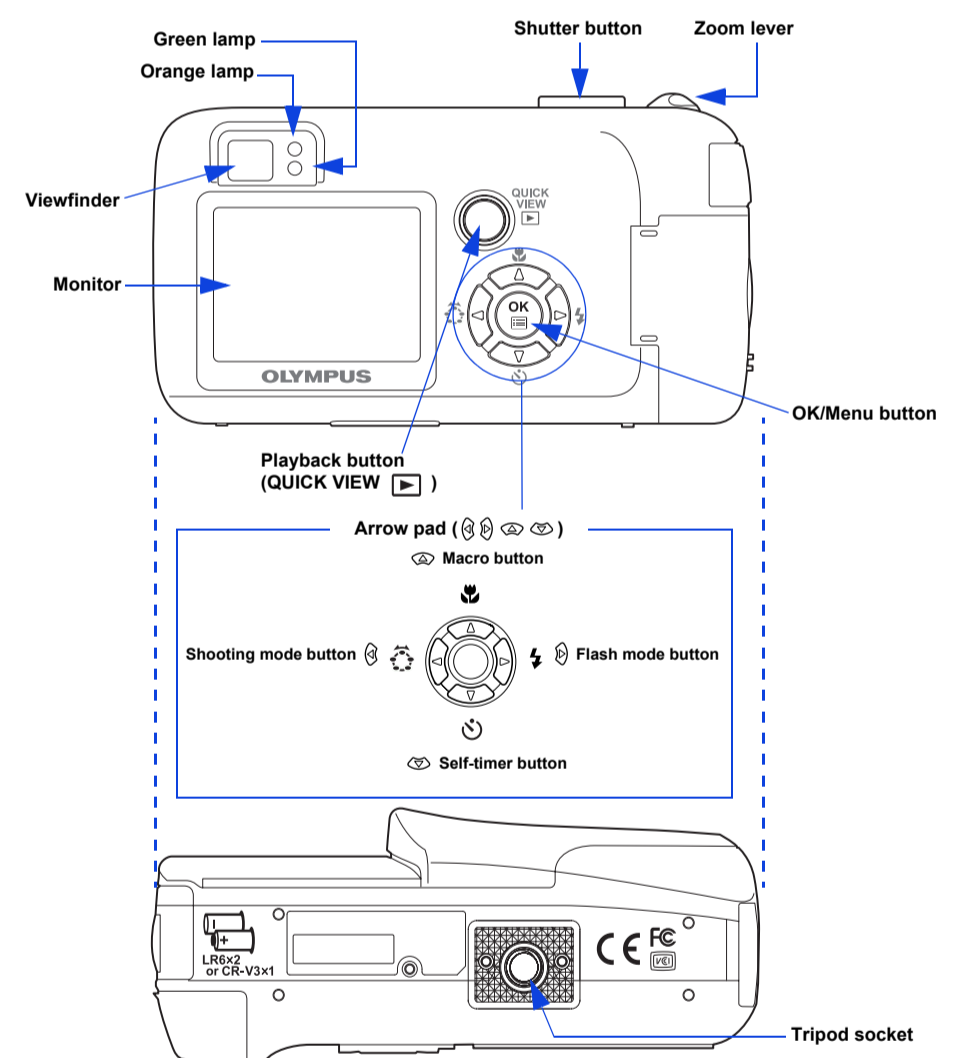
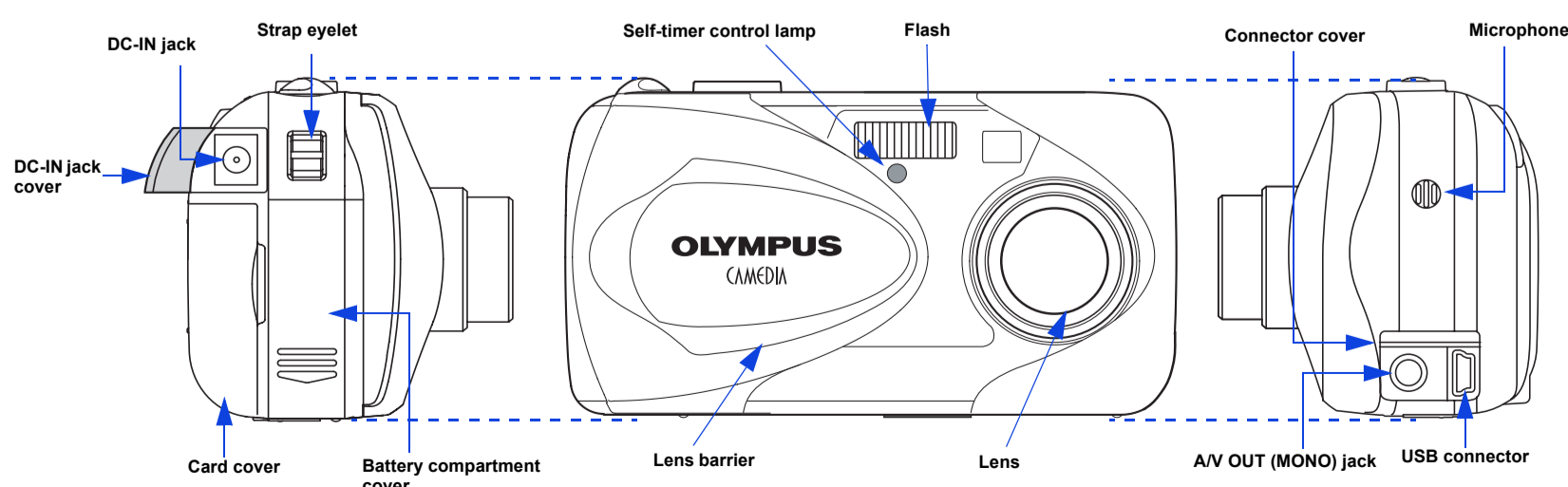

#### Camera Settings in Shooting Mode as shown in Monitor

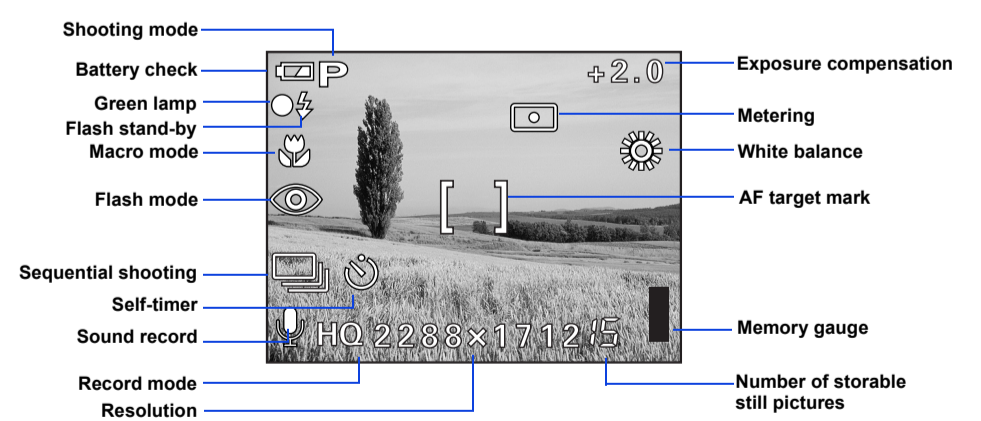

#### Camera Settings in Playback Mode as shown in Monitor



**Note: Depending on the camera settings, not all indicators will be displayed.**

# 4 TAKING PICTURES

There are two ways to compose your subject: using the monitor or with the viewfinder. Depending upon the shooting situation, there is advantages to each method. Please refer to the printed Basic Manual for more information.

## a. Taking a Picture with the Monitor

- Open the lens barrier fully.
- Decide the composition while looking at the image on the monitor.



Icons representing camera settings appear on the monitor, telling you important information such as the Flash and record modes, battery life, and the number of frames remaining.

- Press the shutter button halfway. The green lamp will light steadily when the focus and exposure are set.
- Press the shutter button completely to take the picture. A short beep confirms your picture has been taken.

## b. Taking a Picture with the Viewfinder

- Open the lens barrier fully.
- Frame your subjects using the AF target mark in the viewfinder.
- Press the shutter button halfway.

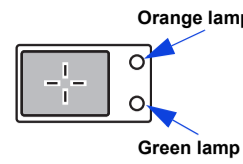

The Digital camera confirms the focus and exposure are properly set when the green lamp in the viewfinder lights steadily. The orange lamp lights up when it is recommended to use the flash and/or when the flash is recharging (when blinking) or ready to fire (when steady).

- Press the shutter button completely to take the picture. A short beep confirms your picture has been taken.

## c. Zooming

This Digital camera features a zoom lens, allowing you to get closer to action, or capture wide-angle shots and get everything into the picture.

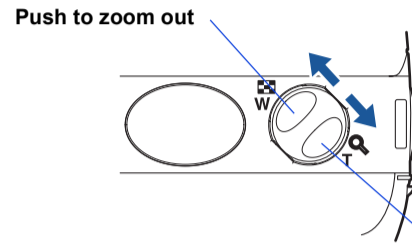

- Push the zoom lever to zoom out and get everything into the picture.
- Pull the zoom lever to choose telephoto shooting and get closer to the action.

## d. Flash Modes

This Digital camera features multiple flash modes. Please note that not all flash modes are available depending on the shooting mode selected.

Icon	Flash Mode	Description
No indication	Auto-flash	The camera automatically decides if the flash is needed.
👁️	Red-eye Reduction Flash	Reduces incidence of red-eye by emitting pre-flashes to shrink pupil size before firing the main flash. The strobe effect is normal operation for this mode.
⚡	Fill-in Flash	The flash always fires with every picture.
🚫	Flash Off	Turns the flash off for times when flash photography is prohibited or not desired. The flash never fires.

With the shutter button depressed halfway, the flash is ready to fire when the ⚡ indicator in the monitor or the orange lamp next to the viewfinder lights. When the orange lamp is blinking, the flash is charging.

## e. Number of Storable Pictures

Your digital camera can handle xD-Picture Cards from 16 MB to 512 MB. The number of storable pictures depends on the image quality selected.

See the Reference Manual for complete descriptions of each recording mode and the storable frame capacity for that of xD-Picture Card.

**TIP** To find out how many frames you have left, turn on the monitor and look for the number in the lower right corner. Remember, you can always delete unwanted pictures to make room for more. (See Step 5.)

# 5 VIEWING AND ERASING PICTURES

With a Digital camera, you can easily view the photos you want—and delete the ones you don't.

## a. Viewing Pictures

There are two ways to access the Playback mode:

- If the camera is OFF and the lens barrier closed, press once.
- OR**
- If the camera is in the shooting mode with the lens barrier fully open, press (QUICK VIEW).

The last picture taken appears in the monitor. Use to scroll through all the images saved on your xD-Picture Card.

When you are finished reviewing your pictures:

- Press to turn the monitor off.
- OR**
- To return to the shooting mode, press the shutter button halfway.

## b. Erasing Pictures

**Once erased, pictures cannot be restored.**

The beauty of digital photography is your ability to keep the photos you want, delete the rest, and reuse empty memory space to take new pictures. This Digital camera offers two ways to permanently erase unwanted digital photos:

**Single-Frame Erase:** Deletes only the picture currently displayed in the monitor.

- With the lens barrier closed, press and use the arrow pad to display the picture you want to erase.
- Press .
- Press to select ERASE.
- Press to select YES, and then press .

**TIP** Images can also be erased while in the "Quick View" mode described in step 5a. This makes it easy to quickly erase a picture that you just took.

**All-Frame Erase:** Deletes all pictures on the xD-Picture Card in one operation, except for pictures you have protected.

- With the lens barrier closed, press .
- Press , then press to select MODE MENU.
- Use to select the CARD tab, then press twice to access the CARD SETUP screen.
- ALL ERASE should be highlighted. Press .
- As a safeguard, the Digital camera will ask you to select YES or NO to confirm erasing, as this process permanently deletes all unprotected pictures. Select YES and press .

# 6 CONNECTING THE CAMERA TO A COMPUTER

**TIP** Olympus recommends using the optional AC adapter to ensure a consistent power supply when downloading images.

**Make sure that the camera is turned off before connecting it to your computer.**

**Windows 98 users must install the "USB Driver for Windows 98" software before connecting the Digital camera to the computer. Refer to the Software Installation Guide for complete information.**

Olympus makes it simple to connect the Digital camera to your computer.

- Turn the camera off.
- Plug the supplied USB cable into the USB connector on your camera and computer as illustrated on the right.
- The camera turns on automatically.
- The monitor turns on and the selection screen for the USB connection is displayed.
- Press to select PC, and then press on the USB screen. The camera starts communicating with the PC.

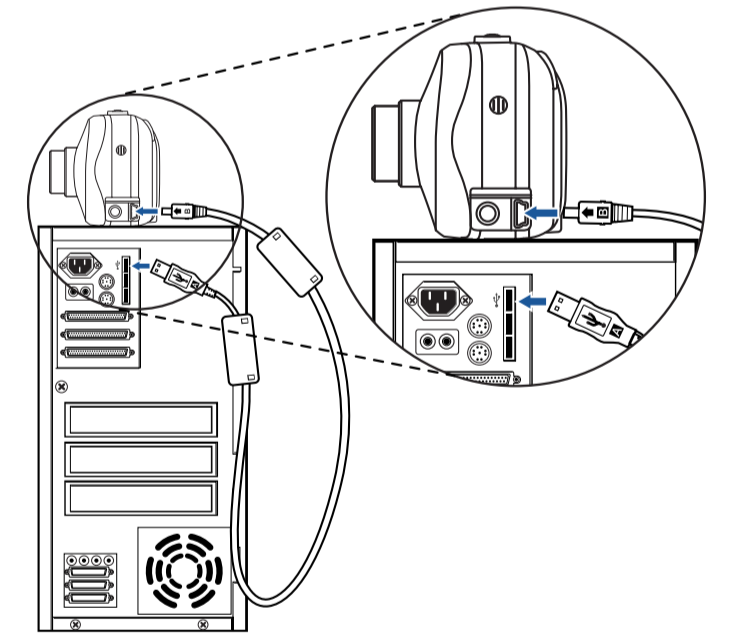

# 7 INSTALLING THE CAMERA SOFTWARE

You've now mastered the basic functionality of your new Olympus Digital Camera! You are now ready to begin exploring the possibilities that digital photography brings to your computer. Activities such as photo editing, printing, and much more are only steps away!



## About the Olympus CAMEDIA Master CD-ROM

Your Olympus Digital Camera comes bundled with a suite of software and documentation. The CD includes:

- **CAMEDIA Master:** To download pictures from the camera, view, organize, retouch and print your digital photos and movies.
- **USB Driver for Windows 98:** This utility must be installed to allow the camera to communicate with your computer if it uses the Microsoft Windows 98 operating system.
- **Olympus Digital Camera Reference Manual:** A complete reference guide in digital form, saved on the CD in PDF format.

## You are now ready to install the computer software.

- Open the CAMEDIA Master CD-ROM package and locate the Software Installation Guide in the language you wish to use.
- Continue to follow the step-by-step instructions for installing the software, and enjoy your new digital photo processing capabilities!

## Additional Camera Features

This Digital camera offers a host of advanced features to expand your creativity. Here's just a small sampling. See the Basic Manual for details on these capabilities, and more!

- **7 Scene Program Shooting Modes:** By using the on-line mode dial (virtual dial), you can easily select the camera settings that most closely match your shooting situation.
- **Sequential Shooting:** Take a rapid succession of still pictures.
- **Still Picture Editing:** Edit still pictures and store them as new pictures.
- **Macro Mode:** For close-ups as tight as 0.7 ft. (0.2m), select Macro Mode.
- **Movie Recording:** Yes, this Digital camera records movies!
- **Two-in-one Pictures:** Combine two separate images taken in succession and store them as a single picture.
- **Close-up Playback:** Enlarge the pictures in the monitor to check details of the selected image.
- **Index Display:** View several thumbnail pictures on the monitor at once.
- **Protecting Pictures:** Prevents you from accidentally erasing photos.
- **Video Playback:** View your pictures and movies on a television monitor.
- **Panorama Shooting:** Connect overlapping images into a single picture using the panorama mode and Olympus CAMEDIA Master software.

**TIP** Remember to complete and return your Registration Card (not provided in some areas), and keep all camera documentation handy.

**Technical Support (USA)**  
1-888-553-4448 (Toll-free)  
8:00 AM - 10:00 PM ET  
Monday - Friday

**European Technical Customer Support**  
00800 - 67 10 83 00 (Toll-free)  
+49 180 5 - 67 10 83 or +49 40 - 237 73 899  
(Charged)  
9:00 AM - 6:00 PM MET  
Monday - Friday