

# ONKYO®

## 7.1ch Home Theater System

# HT-S5100

**AV Receiver (HT-R560)**

**Speaker Package (HTP-560)**

**Front Speakers (SKF-560F L/R)**

**Center Speaker (SKC-560C)**

**Surround Speakers (SKM-560S L/R)**

**Surround Back Speakers (SKB-560 L/R)**

**Subwoofer (SKW-560)**

**Dock for iPod (DS-A1L)**

## Instruction Manual

Thank you for purchasing an Onkyo 7.1ch Home Theater System. Please read this manual thoroughly before making connections and plugging in the unit. Following the instructions in this manual will enable you to obtain optimum performance and listening enjoyment from your new 7.1ch Home Theater System.

Please retain this manual for future reference.

## Contents

Introduction ..... 2

Connection ..... 21

Turning On & First Time Setup..... 41

### Basic Operation

Playing your AV components ..... 47

Using the Tuner..... 51

SIRIUS Satellite Radio ..... 55

DS-A1L Dock for the iPod..... 65

Enjoying the Listening Modes ..... 67

Advanced Operation ..... 74

Troubleshooting ..... 90

Specifications..... 93



## WARNING:

TO REDUCE THE RISK OF FIRE OR ELECTRIC SHOCK, DO NOT EXPOSE THIS APPARATUS TO RAIN OR MOISTURE.

## CAUTION:

TO REDUCE THE RISK OF ELECTRIC SHOCK, DO NOT REMOVE COVER (OR BACK). NO USER-SERVICEABLE PARTS INSIDE. REFER SERVICING TO QUALIFIED SERVICE PERSONNEL.



**WARNING**  
RISK OF ELECTRIC SHOCK  
DO NOT OPEN

**AVIS**  
RISQUE DE CHOC ELECTRIQUE  
NE PAS OUVRIR



The lightning flash with arrowhead symbol, within an equilateral triangle, is intended to alert the user to the presence of uninsulated “dangerous voltage” within the product’s enclosure that may be of sufficient magnitude to constitute a risk of electric shock to persons.



The exclamation point within an equilateral triangle is intended to alert the user to the presence of important operating and maintenance (servicing) instructions in the literature accompanying the appliance.

## Important Safety Instructions

1. Read these instructions.
2. Keep these instructions.
3. Heed all warnings.
4. Follow all instructions.
5. Do not use this apparatus near water.
6. Clean only with dry cloth.
7. Do not block any ventilation openings. Install in accordance with the manufacturer’s instructions.
8. Do not install near any heat sources such as radiators, heat registers, stoves, or other apparatus (including amplifiers) that produce heat.
9. Do not defeat the safety purpose of the polarized or grounding-type plug. A polarized plug has two blades with one wider than the other. A grounding type plug has two blades and a third grounding prong. The wide blade or the third prong are provided for your safety. If the provided plug does not fit into your outlet, consult an electrician for replacement of the obsolete outlet.
10. Protect the power cord from being walked on or pinched particularly at plugs, convenience receptacles, and the point where they exit from the apparatus.
11. Only use attachments/accessories specified by the manufacturer.
12. Use only with the cart, stand, tripod, bracket, or table specified by the manufacturer, or sold with the apparatus. When a cart is used, use caution when moving the cart/apparatus combination to avoid injury from tip-over.  

PORTABLE CART WARNING  
S3125A
13. Unplug this apparatus during lightning storms or when unused for long periods of time.
14. Refer all servicing to qualified service personnel. Servicing is required when the apparatus has been damaged in any way, such as power-supply cord or plug is damaged, liquid has been spilled or objects have fallen into the apparatus, the apparatus has been exposed to rain or moisture, does not operate normally, or has been dropped.
15. Damage Requiring Service  
Unplug the apparatus from the wall outlet and refer servicing to qualified service personnel under the following conditions:
  - A. When the power-supply cord or plug is damaged,
  - B. If liquid has been spilled, or objects have fallen into the apparatus,
  - C. If the apparatus has been exposed to rain or water,
  - D. If the apparatus does not operate normally by following the operating instructions. Adjust only those controls that are covered by the operating instructions as an improper adjustment of other controls may result in damage and will often require extensive work by a qualified technician to restore the apparatus to its normal operation,
  - E. If the apparatus has been dropped or damaged in any way, and
  - F. When the apparatus exhibits a distinct change in performance this indicates a need for service.
16. Object and Liquid Entry  
Never push objects of any kind into the apparatus through openings as they may touch dangerous voltage points or short-out parts that could result in a fire or electric shock.  
The apparatus shall not be exposed to dripping or splashing and no objects filled with liquids, such as vases shall be placed on the apparatus.  
Don’t put candles or other burning objects on top of this unit.
17. Batteries  
Always consider the environmental issues and follow local regulations when disposing of batteries.
18. If you install the apparatus in a built-in installation, such as a bookcase or rack, ensure that there is adequate ventilation.  
Leave 20 cm (8") of free space at the top and sides and 10 cm (4") at the rear. The rear edge of the shelf or board above the apparatus shall be set 10 cm (4") away from the rear panel or wall, creating a flue-like gap for warm air to escape.

# Precautions

---

1. **Recording Copyright**—Unless it's for personal use only, recording copyrighted material is illegal without the permission of the copyright holder.
2. **AC Fuse**—The AC fuse inside the unit is not user-serviceable. If you cannot turn on the unit, contact your Onkyo dealer.
3. **Care**—Occasionally you should dust the unit all over with a soft cloth. For stubborn stains, use a soft cloth dampened with a weak solution of mild detergent and water. Dry the unit immediately afterwards with a clean cloth. Don't use abrasive cloths, thinners, alcohol, or other chemical solvents, because they may damage the finish or remove the panel lettering.

## 4. Power

### WARNING

BEFORE PLUGGING IN THE UNIT FOR THE FIRST TIME, READ THE FOLLOWING SECTION CAREFULLY.

AC outlet voltages vary from country to country. Make sure that the voltage in your area meets the voltage requirements printed on the unit's rear panel (e.g., AC 230 V, 50 Hz or AC 120 V, 60 Hz).

The power cord plug is used to disconnect this unit from the AC power source. Make sure that the plug is readily operable (easily accessible) at all times.

Pressing the [ON/STANDBY] button to select Standby mode does not fully shutdown the unit. If you do not intend to use the unit for an extended period, remove the power cord from the AC outlet.

5. **Never Touch this Unit with Wet Hands**—Never handle this unit or its power cord while your hands are wet or damp. If water or any other liquid gets inside this unit, have it checked by your Onkyo dealer.
6. **Handling Notes**
  - If you need to transport this unit, use the original packaging to pack it how it was when you originally bought it.
  - Do not leave rubber or plastic items on this unit for a long time, because they may leave marks on the case.
  - This unit's top and rear panels may get warm after prolonged use. This is normal.
  - If you do not use this unit for a long time, it may not work properly the next time you turn it on, so be sure to use it occasionally.

## For U.S. models

### FCC Information for User

#### CAUTION:

The user changes or modifications not expressly approved by the party responsible for compliance could void the user's authority to operate the equipment.

#### NOTE:

This equipment has been tested and found to comply with the limits for a Class B digital device, pursuant to Part 15 of the FCC Rules. These limits are designed to provide reasonable protection against harmful interference in a residential installation.

This equipment generates, uses and can radiate radio frequency energy and, if not installed and used in accordance with the instructions, may cause harmful interference to radio communications. However, there is no guarantee that interference will not occur in a particular installation. If this equipment does cause harmful interference to radio or television reception, which can be determined by turning the equipment off and on, the user is encouraged to try to correct the interference by one or more of the following measures:

- Reorient or relocate the receiving antenna.
- Increase the separation between the equipment and receiver.
- Connect the equipment into an outlet on a circuit different from that to which the receiver is connected.
- Consult the dealer or an experienced radio/TV technician for help.

## For Canadian Models

**NOTE:** THIS CLASS B DIGITAL APPARATUS COMPLIES WITH CANADIAN ICES-003.

For models having a power cord with a polarized plug:

**CAUTION:** TO PREVENT ELECTRIC SHOCK, MATCH WIDE BLADE OF PLUG TO WIDE SLOT, FULLY INSERT.

## Modèle pour les Canadien

**REMARQUE:** CET APPAREIL NUMÉRIQUE DE LA CLASSE B EST CONFORME À LA NORME NMB-003 DU CANADA.

Sur les modèles dont la fiche est polarisée:

**ATTENTION:** POUR ÉVITER LES CHOCS ÉLECTRIQUES, INTRODUIRE LA LAME LA PLUS LARGE DE LA FICHE DANS LA BORNE CORRESPONDANTE DE LA PRISE ET POUSSER JUSQU'AU FOND.

### For British models

Replacement and mounting of an AC plug on the power supply cord of this unit should be performed only by qualified service personnel.

#### IMPORTANT

The wires in the mains lead are coloured in accordance with the following code:

Blue: Neutral

Brown: Live

As the colours of the wires in the mains lead of this apparatus may not correspond with the coloured markings identifying the terminals in your plug, proceed as follows:

The wire which is coloured blue must be connected to the terminal which is marked with the letter N or coloured black.

The wire which is coloured brown must be connected to the terminal which is marked with the letter L or coloured red.

#### IMPORTANT

The plug is fitted with an appropriate fuse. If the fuse needs to be replaced, the replacement fuse must be approved by ASTA or BSI to BS1362 and have the same ampere rating as that indicated on the plug. Check for the ASTA mark or the BSI mark on the body of the fuse. If the power cord's plug is not suitable for your socket outlets, cut it off and fit a suitable plug. Fit a suitable fuse in the plug.

### For European Models

#### Declaration of Conformity

We, ONKYO EUROPE  
ELECTRONICS GmbH  
LIEGNITZERSTRASSE 6,  
82194 GROEBENZELL,  
GERMANY



declare in own responsibility, that the ONKYO product described in this instruction manual is in compliance with the corresponding technical standards such as EN60065, EN55013, EN55020 and EN61000-3-2, -3-3.

GROEBENZELL, GERMANY

A handwritten signature in black ink, appearing to read 'K. Miyagi', is written over the printed name.

K. MIYAGI

ONKYO EUROPE ELECTRONICS GmbH

## Speaker Precautions

### Placement

- The subwoofer cabinet is made out of wood and is therefore sensitive to extreme temperatures and humidity, do not put it in locations subject to direct sunlight or in humid places, such as near an air conditioner, humidifier, bathroom, or kitchen.
- Do not put water or other liquids close to the speakers. If liquid is spilled over the speakers, the drive units may be damaged.
- Speakers should only be placed on sturdy, flat surfaces that are free from vibration. Putting them on uneven or unstable surfaces, where they may fall and cause damage, will affect the sound quality.
- Subwoofer is designed to be used in the upright vertical position only. Do not use it in the horizontal or tilted position.
- If the unit is used near a turntable, CD player or DVD player, howling or slipping of sound may occur. To prevent this, move the unit away from the turntable, CD player or DVD player, otherwise lower the unit's output level.

### Using Close to a TV or Computer

TVs and computer monitors are magnetically sensitive devices and as such are likely to suffer discoloration or picture distortion when conventional speakers are placed nearby. To prevent this, the SKF-560F and SKC-560C feature internal magnetic shielding. In some situations, however, discoloration may still be an issue, in which case you should turn off your TV or monitor, wait 15 to 30 minutes, and then turn it back on again. This normally activates the degaussing function, which neutralizes the magnetic field, thereby removing any discoloration effects. If discoloration problems persist, try moving the speakers away from your TV or monitor. Note that discoloration can also be caused by a magnet or demagnetizing tool that's too close to your TV or monitor.

Do not place SKM-450S close to TV or a computer monitor because they have no magnetic shield.

### Input Signal Warning

The speakers can handle the specified input power when used for normal music reproduction. If any of the following signals are fed to them, even if the input power is within the specified rating, excessive current may flow in the speaker coils, causing burning or wire breakage:

1. Interstation noise from an untuned FM radio.
2. Sound from fast-forwarding a cassette tape.
3. High-pitched sounds generated by an oscillator, electronic musical instrument, and so on.
4. Amplifier oscillation.
5. Special test tones from audio test CDs and so on.
6. Thumps and clicks caused by connecting or disconnecting audio cables (Always turn off your amplifier before connecting or disconnecting cables.)
7. Microphone feedback.

# Package Contents

Make sure you have the following items:

## AV Receiver HT-R560

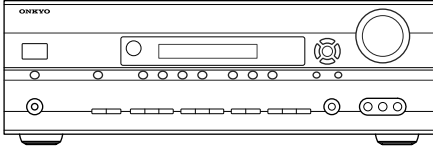

HT-R560

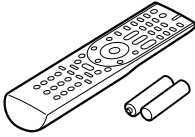

Remote controller and two batteries (AA/R6)



Speaker setup microphone

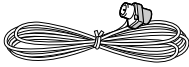

Indoor FM antenna



AM loop antenna

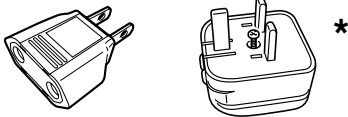

### Power-plug adapter

Only supplied in certain countries. Use this adapter if your AC outlet does not match with the plug on the AV receiver's power cord. (Adapter varies from country to country.)

### \*How to mount the AC plug:

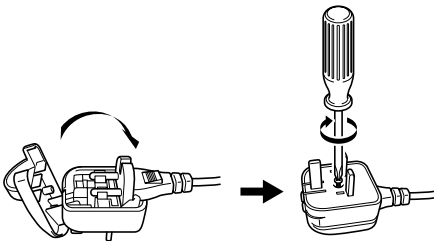

## Speaker Package HTP-560

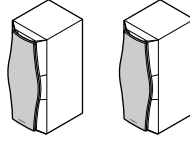

Front speakers  
(SKF-560F L/R)

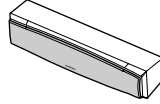

Center speaker  
(SKC-560C)

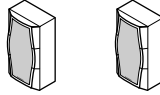

Surround speakers  
(SKM-560S L/R)

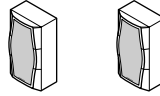

Surround back  
speakers  
(SKB-560 L/R)

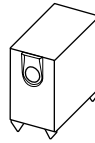

Subwoofer (SKW-560)

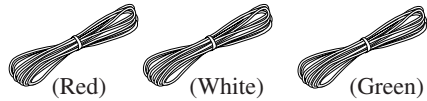

Speaker cable for front speakers and center speaker  
10 ft. (3.0 m)

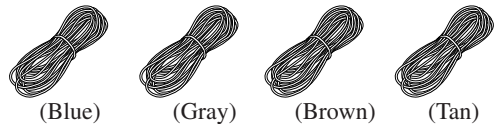

Speaker cables for surround and surround back  
speakers 30 ft. (9 m)



RCA cable for subwoofer connection 10 ft. (3 m)

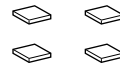

4 floor pads for the subwoofer

**Dock for iPod DS-A1L**

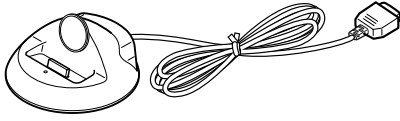

\* In catalogs and on packaging, the letter at the end of the product name indicates the color. Specifications and operation are the same regardless of color.

# Using Two Sets of Speakers

## Speaker Sets A and B

You can use two sets of speakers with the AV receiver: *speaker set A* and *speaker set B*.

**Speaker set A** should be used in your main listening room for up to 7.1-channel playback.

\*While speaker set B is on, speaker set A is reduced to 5.1-channel playback.

**Speaker set B** can be used in another room and offers 2-channel stereo playback.

\*Only analog input sources are output by speaker set B.

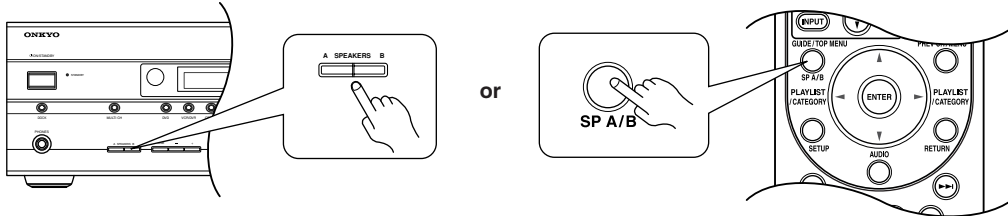

Speaker set A	Speaker set B	Indicator	Output
On	On	<b>A</b> <b>B</b>	Set A: 5.1 channels Set B: 2 channels
	Off	<b>A</b>	Set A: 7.1 channels
Off	On	<b>B</b>	Set B: 2 channels
	Off		No sound

## Main Room (speaker set A)

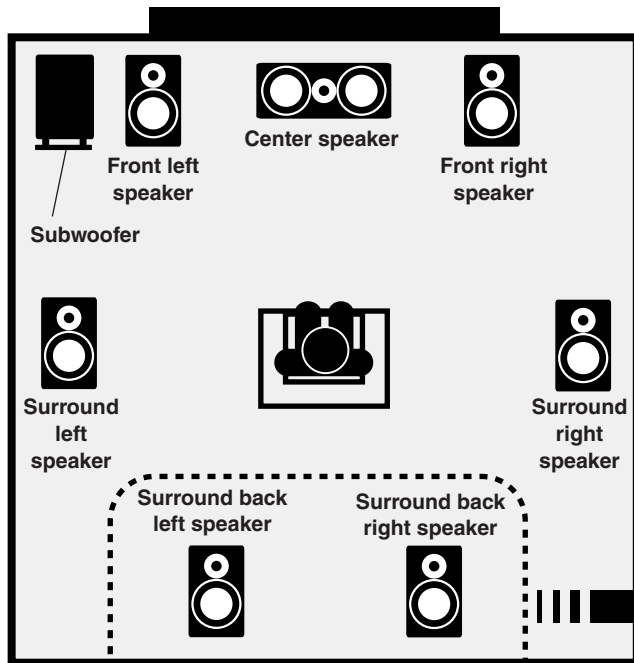

\* While speaker set B is on, the surround back speakers output no sound.

## Sub Room (speaker set B)

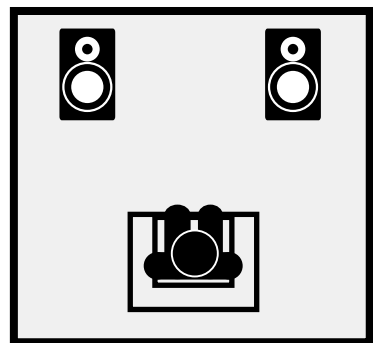

\* Digital input sources are not output by speaker set B. Connect your source component with an analog connection.

# Features

## AV Receiver HT-R560

### Amplifier

- 75 Watts/Channel @ 8 ohms (FTC)
- 130 Watts/Channel @ 6 ohms (IEC)
- WRAT-Wide Range Amplifier Technology (5Hz–100kHz bandwidth)
- High-Current Low-Impedance Drive
- Optimum Gain Volume Circuitry
- H.C.P.S. (High Current Power Supply) Massive High Power Transformer

### Processing

- Dolby Digital EX and Pro Logic IIx<sup>\*1</sup>
- DTS and DTS-ES, DTS 96/24 and DTS Neo:6 Processing<sup>\*2</sup>
- Direct Mode
- Music Optimizer<sup>\*3</sup> for Compressed Music
- CinemaFILTER
- Non-Scaling Configuration
- A-Form Listening Mode Memory
- 24-bit/192kHz D/A Converters
- Powerful and Highly Accurate 32-bit DSP Processing

### Connections

- 3 HDMI<sup>\*4</sup> Inputs and 1 Output
- HDTV-Ready Component Video Switching (2 Inputs/1 Output)
- 4 Digital Inputs (2 Optical/2 Coaxial/4 Assignable)
- 3 S-Video Inputs/2 Outputs
- Color-Coded 7.1 Multichannel Inputs (Ready for Dolby Digital and DTS Formats for High-Definition Discs)
- Subwoofer Pre Outs
- Dedicated DOCK jack for quick and simple DS-A1L Dock connection and iPod playback

### Miscellaneous

- 40 AM/FM/SIRIUS<sup>\*5</sup> Presets
- Audyssey 2EQ<sup>\*6</sup> Room Correction and Speaker Calibration
- Audyssey Dynamic EQ Loudness Correction
- Crossover Adjustment (40/50/60/80/100/120/150/200Hz)
- A/V Sync Control Function (up to 100 ms)
- Theater Dimensional Virtual Surround Function<sup>\*7</sup>
- Preprogrammed **RI**-Compatible Remote

## Speaker Package HTP-560

### SKF-560F L/R 2-Way Front Speakers

- 12 cm OMF cone woofer
- 2.5 cm Balanced dome tweeter
- Max. input power:130 W
- Magnetically shielded
- 8-ohm impedance
- Color-coded speaker terminals and speaker cable

### SKM-560S L/R Full-Range Surround Speakers

### SKB-560 L/R Full-Range Surround Back Speakers

- 8 cm full-range speaker
- Max. input power:130 W
- 8-ohm impedance
- Color-coded speaker terminals and speaker cable

### SKC-560C 2-Way Center Speaker

- 8 cm OMF cone woofer × 2
- 2.5 cm Balanced dome tweeter
- Max. input power:130 W
- Magnetically shielded
- 8-ohm impedance
- Color-coded speaker terminals and speaker cable

### SKW-560 Bass Reflex Powered Subwoofer

- 25 cm cone woofer
- Max. power:290 W

## Dock DS-A1L

- Play your iPod music through your Onkyo audio system and enjoy great sound
- Control your iPod with your Onkyo remote controller
- Supports all iPod models with an iPod connector, except 3rd Generation iPod models
- Charges your iPod's battery while you enjoy your music



Manufactured under license from Dolby Laboratories. Dolby, Pro Logic and the double-D symbol are trademarks of Dolby Laboratories.



Manufactured under license under U.S. Patent #'s: 5,451,942; 5,956,674; 5,974,380; 5,978,762; 6,226,616; 6,487,535; 7,003,467; 7,212,872 & other U.S. and worldwide patents issued & pending. DTS, DTS Digital Surround, ES, and Neo:6 are registered trademarks and the DTS logos, Symbol and DTS 96/24 are trademarks of DTS, Inc. ©1996-2007 DTS, Inc. All Rights Reserved.



## Features—Continued

---

\*3 Music Optimizer™ is a trademark of Onkyo Corporation.

\*4 **HDMI**

HDMI, the HDMI logo and High Definition Multimedia Interface are trademarks or registered trademarks of HDMI Licensing, LLC.

\*5 **SIRIUS**  
R E A D Y

©2005 SIRIUS Satellite Radio Inc. “SIRIUS,” SiriusConnect, the SIRIUS dog logo, channel names and logos are trademarks of SIRIUS Satellite Radio Inc. Available only in the contiguous United States (excluding Alaska and Hawaii) and Canada.

\*6 **AUDYSSEY**  
2EQ  
DYNAMIC EQ

Manufactured under license from Audyssey Laboratories. U.S. and foreign patents pending. Audyssey 2EQ and Dynamic EQ are trademarks of Audyssey Laboratories.

\*7 

Theater-Dimensional  
Theater-Dimensional is a trademark of Onkyo Corporation.



\* iPod is a trademark of Apple Inc., registered in the U.S. and other countries.

# Contents

---

<b>Important Safety Instructions</b> .....	2	Making HDMI Connections .....	36
<b>Precautions</b> .....	3	Connecting a Camcorder, Game Console, or Other Device .....	37
<b>Speaker Precautions</b> .....	4	Connecting the Supplied DS-A1L Dock .....	37
<b>Package Contents</b> .....	5	Connecting a CD Player or Turntable .....	38
AV Receiver HT-R560 .....	5	Connecting a Cassette, CDR, MiniDisc, or DAT Recorder .....	39
Speaker Package HTP-560 .....	5	Connecting Onkyo <b>RI</b> Components .....	40
Dock for iPod DS-A1L .....	6	Connecting the Power Cord .....	40
<b>Using Two Sets of Speakers</b> .....	7	<b>Turning On the AV Receiver</b> .....	<b>41</b>
Speaker Sets A and B .....	7	Turning On and Standby .....	41
Sub Room (speaker set B) .....	7	<b>First Time Setup</b> .....	<b>42</b>
Main Room (speaker set A) .....	7	Automatic Speaker Setup (Audyssey 2EQ) .....	42
<b>Features</b> .....	8	HDMI Input Setup .....	44
AV Receiver HT-R560 .....	8	Component Video Input Setup .....	45
Speaker Package HTP-560 .....	8	Digital Input Setup .....	46
Dock DS-A1L .....	8	Changing the Input Display .....	46
<b>Getting to Know the AV Receiver</b> .....	12	<b>Playing Your AV Components</b> .....	<b>47</b>
Front Panel .....	12	Basic AV Receiver Operation .....	47
Display .....	13	<b>Common Functions</b> .....	<b>48</b>
Rear Panel .....	14	Setting the Display Brightness .....	48
<b>Speaker Package</b> .....	16	Muting the AV Receiver .....	48
Subwoofer (SKW-560) .....	16	Using the Sleep Timer .....	48
Front, Center, Surround, Surround Back speakers (SKF-560F, SKC-560C, SKM-560S, SKB-560) .....	17	Using Headphones .....	49
<b>Remote Controller</b> .....	18	Displaying Source Information .....	49
Controlling the AV Receiver .....	18	Specifying the Digital Signal Format .....	50
Controlling a Dock DS-A1L .....	19	<b>Listening to the Radio</b> .....	<b>51</b>
Installing the Batteries .....	20	AM Frequency Step Setup (on some models) .....	51
Using the Remote Controller .....	20	Listening to AM/FM Stations .....	52
<b>Connecting Your Speakers</b> .....	21	Presetting AM/FM Stations .....	54
Enjoying Home Theater .....	21	<b>Listening to SIRIUS Satellite Radio</b> .....	<b>55</b>
Connecting Speaker Set A .....	23	Listening to SIRIUS Satellite Radio® (Only North American Model) .....	55
Connecting Speaker Set B .....	23	Setting the Satellite Radio Mode .....	56
Wall Mounting .....	24	Selecting SIRIUS Satellite Radio .....	56
Using the Floor Pads for Subwoofer .....	24	Signing Up for SIRIUS Satellite Radio .....	56
<b>Connecting Antennas</b> .....	25	Selecting SIRIUS Satellite Radio Channels .....	57
Connecting the Indoor FM Antenna .....	25	Displaying SIRIUS Satellite Radio Information ..	59
Connecting the AM Loop Antenna .....	25	Positioning the SiriusConnect Home Tuner .....	60
Connecting an Outdoor FM Antenna .....	26	Parental Lock .....	61
Connecting an Outdoor AM Antenna .....	26	Changing the PIN Number .....	62
<b>Connecting Your Components</b> .....	27	Using RDS (European models only) .....	63
About AV Connections .....	27	<b>DS-A1L Dock for the iPod</b> .....	<b>65</b>
Connecting Audio and Video Signals to the AV Receiver .....	28	About the DS-A1L Dock .....	65
Which Connections Should I Use? .....	28	Compatible iPod models .....	65
Connecting a TV or Projector .....	29	Putting Your iPod in the Dock .....	65
Connecting a DVD player .....	30	Function Overview .....	65
Connecting a VCR or DVR for Playback .....	32	<b>Using the Listening Modes</b> .....	<b>67</b>
Connecting a VCR or DVR for Recording .....	33	Selecting the Listening Modes .....	67
Connecting a Satellite, Cable, or Terrestrial Set-top box or Other Video Source .....	34	Listening Modes Available for Each Source Format .....	68
Connecting Components with HDMI .....	35	About the Listening Modes .....	71

## Contents—Continued

---

<b>Recording</b> .....	<b>73</b>
Recording the Input Source .....	73
Recording from Different AV Sources .....	73
<b>Adjusting the Listening Modes</b> .....	<b>74</b>
Using the Audio Adjust Settings .....	74
Using the Audio Settings .....	75
<b>Advanced Setup</b> .....	<b>77</b>
Speaker Setup .....	77
<b>Controlling Other Components</b> .....	<b>82</b>
Preprogrammed Remote Control Codes .....	82
Entering Remote Control Codes .....	82
Resetting the Remote Controller .....	83
Controlling a DVD Player, or DVD Recorder .....	84
Controlling a VCR, or PVR .....	85
Controlling a Satellite Receiver or Cable Receiver .....	86
Controlling a CD Player, CD Recorder, or MD Player .....	87
Controlling a Cassette Recorder .....	88
Controlling a TV .....	89
<b>Troubleshooting</b> .....	<b>90</b>
<b>Specifications</b> .....	<b>93</b>
7.1ch Home Theater Speaker Package .....	94
Dock DS-A1L .....	94

\* To reset the AV receiver to its factory defaults, turn it on and, while holding down the [VCR/DVR] button, press the [ON/STANDBY] button (see page 90).

# Getting to Know the AV Receiver

## Front Panel

### North American model

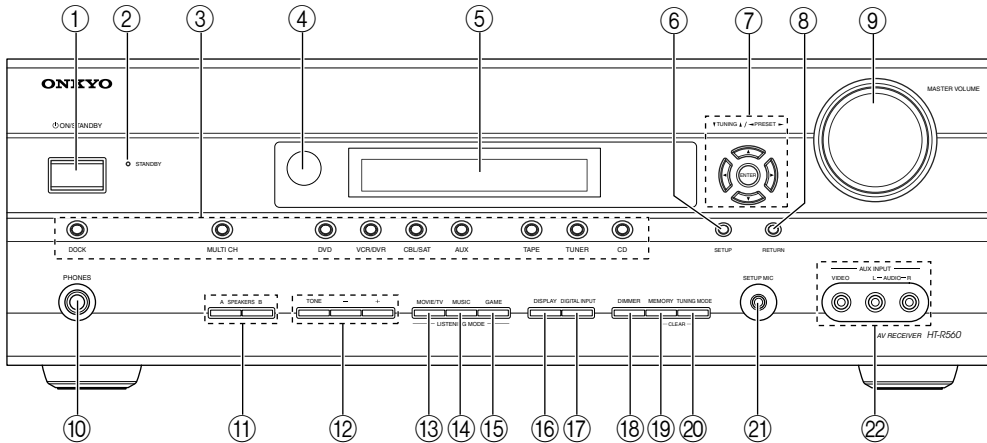

### Other models

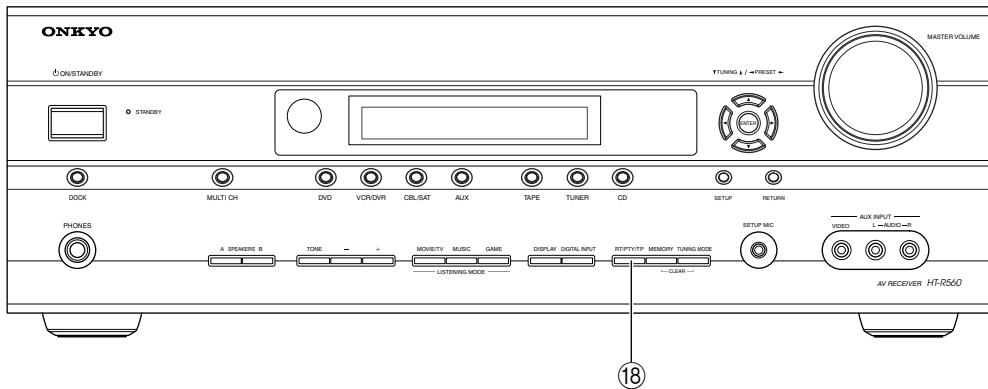

The actual front panel has various logos printed on it. They are not shown here for clarity.

The page numbers in parentheses show where you can find the main explanation for each item.

- ① **ON/STANDBY button (41)**  
Sets the AV receiver to On or Standby.
- ② **STANDBY indicator (41)**  
Lights up when the AV receiver is on Standby and flashes while a signal is being received from the remote controller.
- ③ **Input selector buttons (47)**  
Select the following input sources: DVD, VCR/DVR, CBL/SAT, AUX, TAPE, TUNER, CD, DOCK.  
The [MULTI CH] button selects the multichannel DVD input.
- ④ **Remote-control sensor (20)**  
Receives control signals from the remote controller.
- ⑤ **Display**  
See “Display” on page 13.
- ⑥ **SETUP button**  
Opens and closes the setup menu.
- ⑦ **TUNING, PRESET, Arrow, and ENTER buttons**  
When AM or FM is selected, the TUNING [▲] [▼] buttons are used for radio tuning, and the PRESET [◀] [▶] buttons are used to select radio presets (see page 54). With the setup menus, they work as arrow buttons and are used to select and set items. The ENTER button is also used with the setup menus.
- ⑧ **RETURN button**  
Selects the previously displayed setup menu.

## Getting to Know the AV Receiver—Continued

For detailed information, see the pages in parentheses.

- ⑨ **MASTER VOLUME control (47)**  
Sets the volume of the AV receiver to Min, 1 through 79, or Max.
- ⑩ **PHONES jack (49)**  
This 1/4-inch phone jack is for connecting a standard pair of stereo headphones for private listening.
- ⑪ **SPEAKER A B buttons**  
Turn speaker set A and B on or off.
- ⑫ **TONE, –, and + buttons (75)**  
Used to adjust the tone (bass and treble).
- ⑬ **MOVIE/TV button (67)**  
Selects the listening modes intended for use with movies and TV.
- ⑭ **MUSIC button (67)**  
Selects the listening modes intended for use with music.
- ⑮ **GAME button (67)**  
Selects the listening modes intended for use with video games.
- ⑯ **DISPLAY button (49)**  
Displays various information about the currently selected input source.
- ⑰ **DIGITAL INPUT button (46)**  
Used to assign digital inputs to input selectors.
- ⑱ **DIMMER (RT/PTY/TP) button (64, 48)**  
Adjusts the display brightness.  
On the European modes, this is the RT/PTY/TP button, and it's used with RDS (Radio Data System). See "Using RDS (European models only)" on page 63.
- ⑲ **MEMORY button (54)**  
Used when storing or deleting radio presets.
- ⑳ **TUNING MODE button (52)**  
Selects the Auto or Manual tuning mode for AM and FM radio.
- ㉑ **SETUP MIC (42)**  
The automatic speaker setup microphone connects here.
- ㉒ **AUX INPUT (37, 73)**  
Used to connect a camcorder, game console, and so on. There are input jacks for composite video and analog audio.

### Display

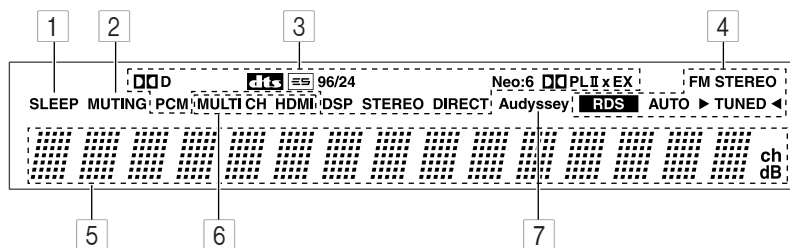

For detailed information, see the pages in parentheses.

- ① **SLEEP indicator (48)**  
Lights up when the Sleep function has been set.
- ② **MUTING indicator (48)**  
Flashes while the AV receiver is muted.
- ③ **Listening mode and format indicators (67)**  
Show the selected listening mode and audio input signal format.
- ④ **Tuning indicators (52)**  
**FM STEREO (52):** Lights up when tuned to a stereo FM station.  
**RDS (63):** Lights up when tuned to a radio station that supports RDS (Radio Data System).  
**AUTO (52):** Lights up when Auto Tuning mode is selected for AM or FM radio. Goes off when Manual Tuning mode is selected.
- ⑤ **TUNED (52):** Lights up when tuned to a radio station.
- ⑥ **Message area**  
Displays various information.
- ⑦ **Audio input indicators**  
Indicate the type of audio input that's selected as the audio source: MULTI CH, or HDMI.
- ⑧ **Audyssey indicator (43)**  
Lights up during automatic speaker setup.

## Rear Panel

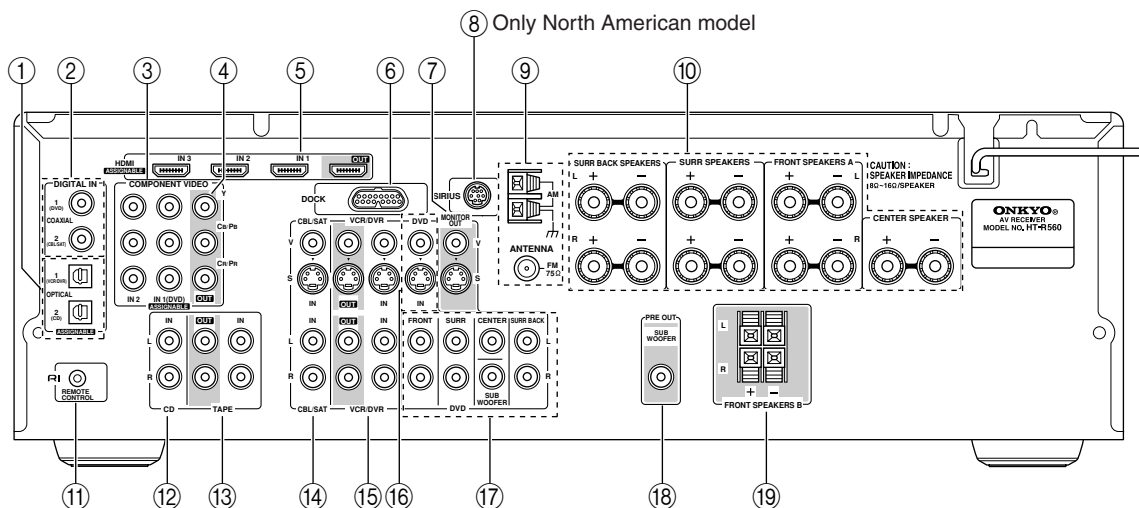

**① DIGITAL IN OPTICAL 1 and 2**

These optical digital audio inputs are for connecting components with an optical digital audio output, such as a CD player or DVD player. They're assignable, which means you can assign each one to an input selector to suit your setup. See "Digital Input Setup" on page 46.

**② DIGITAL IN COAXIAL 1 and 2**

These coaxial digital audio inputs are for connecting components with a coaxial digital audio output, such as a CD player or DVD player. They're assignable, which means you can assign each one to an input selector to suit your setup. See "Digital Input Setup" on page 46.

**③ COMPONENT VIDEO IN 1 and 2**

These RCA component video inputs are for connecting components with a component video output, such as a DVD player, DVD recorder, or DVR (digital video recorder). They're assignable, which means you can assign each one to an input selector to suit your setup. See "Component Video Input Setup" on page 45.

**④ COMPONENT VIDEO OUT**

This RCA component video output is for connecting a TV or projector with a component video input.

**⑤ HDMI IN 1–3 and OUT**

HDMI (High Definition Multimedia Interface) connections carry digital audio and digital video.

The HDMI inputs are for connecting components with an HDMI output, such as a DVD player, DVD recorder, or DVR (digital video recorder). They're assignable, which means you can assign each one to an input selector to suit your setup. See "HDMI Input Setup" on page 44.

The HDMI outputs are for connecting a TV or projector with an HDMI input.

**⑥ DOCK**

This jack is for connecting the supplied DS-A11 Dock.

**⑦ MONITOR OUT**

The S-Video or composite video jack should be connected to a video input on your TV or projector.

**⑧ SIRIUS (only for the North American model)**

This jack is for connecting the SiriusConnect receiver (not supplied).

**⑨ AM and FM ANTENNA**

The AM push terminals are for connecting an AM antenna. The FM jack is for connecting an FM antenna.

**⑩ FRONT L/R, CENTER, SURR L/R, and SURR BACK L/R SPEAKERS**

These terminal posts are for connecting the front speakers, center, surround, and surround back speakers.

**⑪ RI REMOTE CONTROL**

This **RI** (Remote Interactive) jack can be connected to the **RI** jack on another **RI**-capable Onkyo component for remote and system control.

To use **RI**, you must make an analog audio connection (RCA) between the AV receiver and the other component, even if they are connected digitally.

**⑫ CD IN**

This analog audio input is for connecting a CD player's analog audio output.

⑬ **TAPE IN/OUT**

These analog audio input and output jacks are for connecting a recorder with an analog audio input and output, such as a cassette deck, MD recorder, etc.

⑭ **CBL/SAT IN**

A cable or satellite receiver can be connected here. There are S-Video and composite video input jacks for connecting the video signal, and there are analog audio input jacks for connecting the audio signal.

⑮ **VCR/DVR IN/OUT**

A video component, such as a VCR or DVR, can be connected here for recording and playback. There are S-Video and composite video input and output jacks for connecting the video signal, and there are analog audio input jacks for connecting the audio signal.

⑯ **DVD IN**

This input is for connecting a DVD player. There are S-Video and composite video input jacks for connecting the video signal.

⑰ **DVD FRONT L/R, CENTER, SUBWOOFER, SURR L/R, and SURR BACK L/R**

This analog multichannel input is for connecting a component with a 5.1/7.1-channel analog audio output, such as a DVD player, DVD-Audio or SACD-capable player, or an MPEG decoder.

⑱ **SUBWOOFER PRE OUT**

This analog audio output can be connected to a powered subwoofer.

⑲ **FRONT SPEAKERS B**

These push terminals are for connecting speaker set B.

See pages 21–40 for hookup information.

# Speaker Package

## Subwoofer (SKW-560)

For detailed information, see the pages in parentheses.

### ■ Front

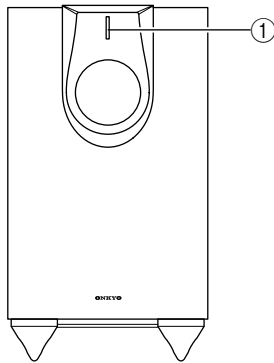

### ■ Rear

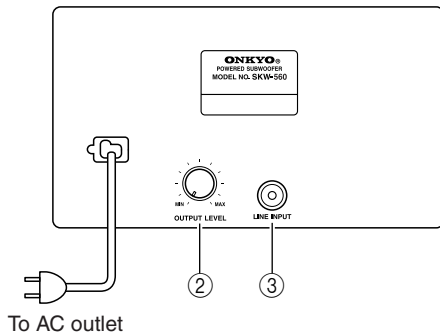

#### ① **STANDBY/ON indicator**

Red: Subwoofer in standby mode

Blue: Subwoofer on

With the Auto Standby function, the SKW-560 automatically turns on when an input signal is detected in Standby mode. When there's no input signal for a while, the SKW-560 automatically enters Standby mode.

#### ② **OUTPUT LEVEL control (47)**

This control is used to adjust the volume of the subwoofer.

#### ③ **LINE INPUT (23)**

This RCA input should be connected to the subwoofer pre out on the AV receiver with supplied RCA cable.

#### **Note:**

The Auto Standby function turns the subwoofer on when the input signal exceeds a certain level. If the Auto Standby function does not work reliably, try slightly increasing or decreasing the subwoofer output level on the AV receiver (page 80).



### Front, Center, Surround, Surround Back speakers (SKF-560F, SKC-560C, SKM-560S, SKB-560)

#### ■ Rear

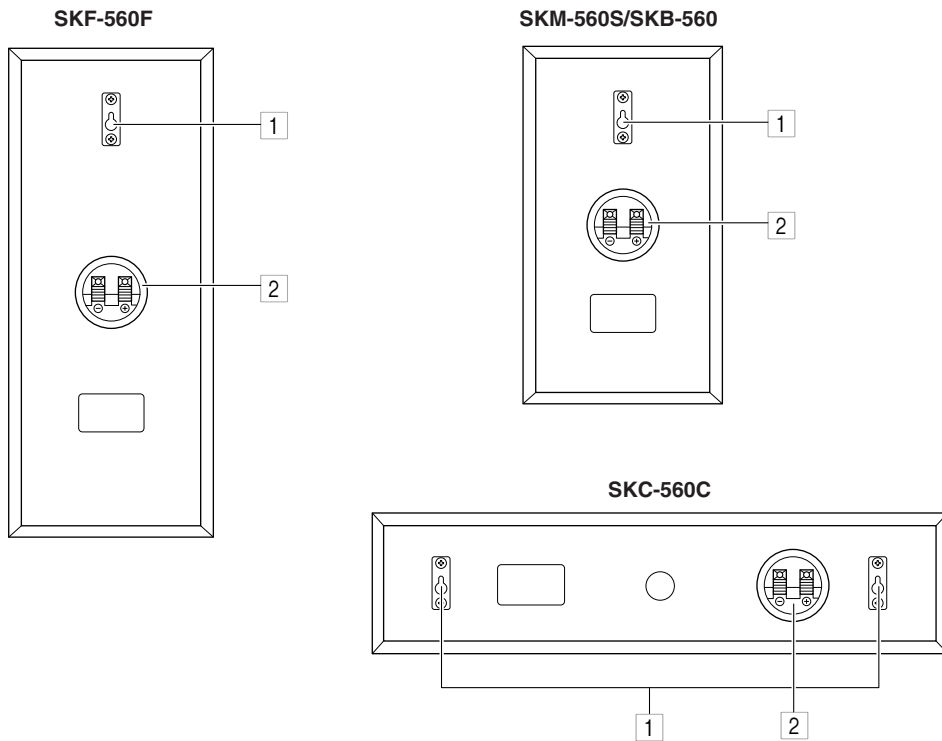

#### 1 Keyhole slots

These keyhole slots can be used to wall-mount the speaker. See page 24 for mounting instructions.

#### 2 Speaker terminals

These push terminals are for connecting the speaker to the HT-R560 with the supplied speaker cables. The supplied speaker cables are color-coded for easy identification. Simply connect each cable to the same-colored positive speaker terminal.

# Remote Controller

## Controlling the AV Receiver

### ■ Controlling the receiver

To control the AV receiver, press the [RECEIVER] REMOTE MODE button to select Receiver mode first.

You can also use the remote controller to control your DVD player, CD player, and other components. See page 82 for more details.

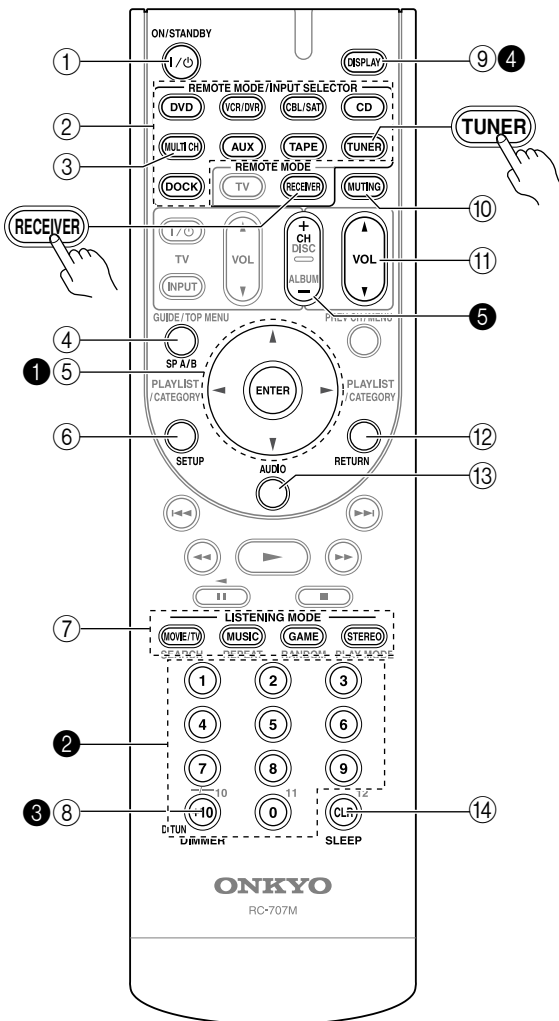

For detailed information, see the pages in parentheses.

- ① **ON/STANDBY button (41)**  
Sets the AV receiver to On or Standby.
- ② **REMOTE MODE/INPUT SELECTOR buttons (47, 84–89)**  
Selects the remote controller modes and the input sources.

- ③ **MULTI CH button (47)**  
Selects the multichannel DVD input.
- ④ **SP A/B button**  
Turns speaker set A or B on or off.
- ⑤ **Arrow [▲]/[▼]/[◀]/[▶] and ENTER buttons**  
Used to select and adjust settings.
- ⑥ **SETUP button**  
Used to change settings.
- ⑦ **LISTENING MODE buttons (67)**  
Used to select the listening modes.
- ⑧ **DIMMER button (48)**  
Adjusts the display brightness.
- ⑨ **DISPLAY button (49)**  
Displays information about the current input source.
- ⑩ **MUTING button (48)**  
Mutes or unmutes the AV receiver.
- ⑪ **VOL [▲]/[▼] button (47)**  
Adjusts the volume of the AV receiver regardless of the currently selected remote controller mode.
- ⑫ **RETURN button**  
Returns to the previous display when changing settings.
- ⑬ **AUDIO button (75)**  
Used to change audio settings.
- ⑭ **SLEEP button (48)**  
Used with the Sleep function.

### ■ Controlling the tuner

To control the AV receiver's tuner, press the [TUNER] (or [RECEIVER]) REMOTE MODE button. You can select AM or FM by pressing the [TUNER] button repeatedly.

- ① **Arrow [▲]/[▼]/[◀]/[▶] buttons**  
Used to tune into radio stations and select preset.
- ② **Number buttons (53)**  
Used to select AM and FM radio stations and preset stations directly.
- ③ **D.TUN button (53)**  
Selects the Direct tuning mode.
- ④ **DISPLAY button(53)**  
Displays information about the band, frequency, preset number, and so on.
- ⑤ **CH +/- button (54)**  
Selects radio presets.

#### Note:

- An Onkyo cassette recorder connected via **RI** can also be controlled in Receiver (see page 88).

## Controlling a Dock DS-A1L

To control your iPod when it's seated in the supplied DS-A1L Dock, which is connected to the HT-R560's DOCK jack, press the [DOCK] REMOTE MODE button.

See page 37 for details on connecting the DS-A1L Dock. To control an RI Dock other than the DS-A1L, see "Controlling Other Components" on page 82.

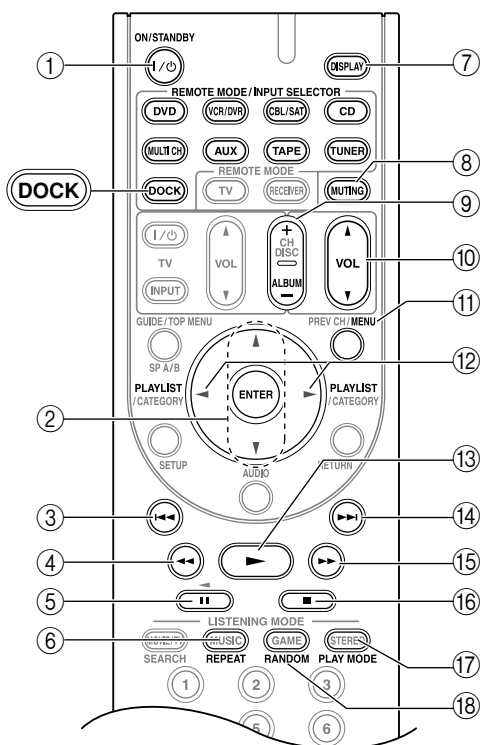

\* With some components, certain buttons may not work as expected, and some may not work at all.

### ① ON/STANDBY button

Turns the iPod on or off.

#### Notes:

- Your iPod may not respond the first time you press this button, in which case you should press it again. This is because the remote controller transmits the On and Standby commands alternately, so if your iPod is already on, it will remain on when the remote controller transmits an On command. Similarly, if your iPod is already off, it will remain off when the remote controller transmits an Off command.

### ② Arrow [▲]/[▼] and ENTER buttons\*

Used to navigate menus and select items.

### ③ Previous [⏮] button

Restarts the current song. Press it twice to select the previous song.

### ④ Rewind [◀◀] button

Press and hold to rewind.

### ⑤ Pause [⏸] button

Pauses playback. (With 3rd generation iPod models, it works as a Play/Pause button.)

### ⑥ REPEAT button\*

Used with the repeat function.

### ⑦ DISPLAY button\*

Turns on the backlight for 30 seconds.

### ⑧ MUTING button (48)

Mutes or unmutes the AV receiver.

### ⑨ ALBUM +/- button\*

Selects the next or previous album.

### ⑩ VOL [▲]/[▼] button (47)

Adjusts the volume of the AV receiver.

### ⑪ MENU button\*

Displays a menu.

### ⑫ PLAYLIST [◀]/[▶] buttons\*

Selects the previous or next playlist on the iPod.

### ⑬ Play [▶] button

Starts playback. If the component is off, it will turn on automatically. (With 3rd generation iPod models, this button works as a Play/Pause button.)

### ⑭ Next [▶▶] button

Selects the next song.

### ⑮ Fast Forward [▶▶] button

Press and hold to fast forward.

### ⑯ Stop [■] button

Stops playback and displays a menu.

### ⑰ PLAY MODE button

Selects play modes on components with selectable play modes.

### ⑱ RANDOM button\*

Used with the shuffle function.

\*Buttons marked with an asterisk (\*) are not supported by 3rd generation iPod models.

### Installing the Batteries

- 1 To open the battery compartment, press the small lever and remove the cover.**

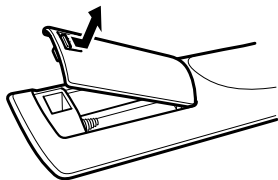

- 2 Insert the two supplied batteries (AA/R6) in accordance with the polarity diagram inside the battery compartment.**

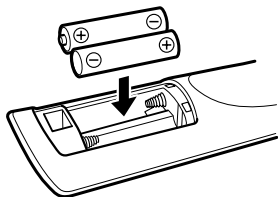

- 3 Replace the cover and push it shut.**

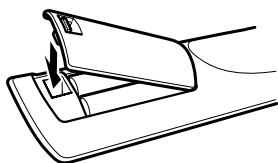

#### Notes:

- If the remote controller doesn't work reliably, try replacing the batteries.
- Don't mix new and old batteries or different types of batteries.
- If you intend not to use the remote controller for a long time, remove the batteries to prevent damage from leakage or corrosion.
- Expired batteries should be removed as soon as possible to prevent damage from leakage or corrosion.

### Using the Remote Controller

When using the remote controller, point it toward the AV receiver's remote control sensor, as shown below.

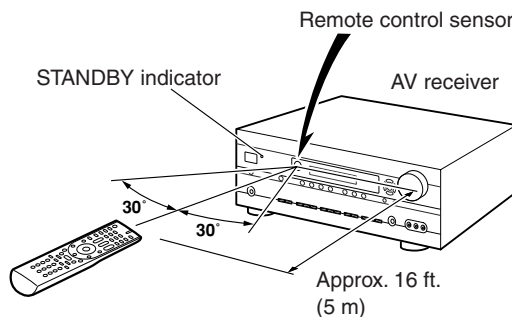

#### Notes:

- The remote controller may not work reliably if the AV receiver is subjected to bright light, such as direct sunlight or inverter-type fluorescent lights. Keep this in mind when installing.
- If another remote controller of the same type is used in the same room, or the AV receiver is installed close to equipment that uses infrared rays, the remote controller may not work reliably.
- Don't put anything on top of the remote controller, such as a book or magazine, because a button may be pressed continuously, thereby draining the batteries.
- The remote controller may not work reliably if the AV receiver is installed in a rack behind colored glass doors. Keep this in mind when installing.
- The remote controller will not work if there's an obstacle between it and the AV receiver's remote control sensor.

# Connecting Your Speakers

## Enjoying Home Theater

Thanks to the AV receiver's superb capabilities, you can enjoy surround sound with a real sense of movement in your own home—just like being in a movie theater or concert hall. You can enjoy DVDs featuring Dolby Digital or DTS. With analog or digital TV, you can enjoy Dolby Pro Logic IIx, DTS Neo:6, or Onkyo's original DSP listening modes.

### Front left and right speakers (SKF-560F)

These output the main sound. Their role in a home theater is to provide a solid anchor for the sound image. They should be positioned facing the listener at about ear level, and equally spaced from the TV. Angle them inward slightly so as to create a triangle, with the listener at the apex.

### Center speaker (SKC-560C)

This speaker enhances the front left and right speakers, making sound movements distinct and providing a full sound image. For movies it's used mainly for dialog.

Position it close to your TV (preferably on top) facing forward at about ear level, or at the same height as the front left and right speakers.

### Subwoofer (SKW-560)

The subwoofer handles the bass sounds of the LFE (Low-Frequency Effects) channel. The volume and quality of the bass output from your subwoofer will depend on its position, the shape of your listening room, and your listening position. In general, a good bass sound can be obtained by installing the subwoofer in a front corner, or at one-third the way along the front wall, as shown.

**Tip:** To find the best position for your subwoofer, while playing a movie or some music with good bass, experiment by placing your subwoofer at various positions within the room and choose the one that provides the most satisfying results.

### Surround left and right speakers (SKM-560S)

These speakers are used for precise sound positioning and to add realistic ambience.

Position them at the sides of the listener, or slightly behind, about 2–3 feet (60–100 cm) above ear level. Ideally they should be equally spaced from the listener.

### Surround back left and right speakers (SKB-560)

These speakers are necessary to enjoy Dolby Digital EX, DTS-ES Matrix, DTS-ES Discrete, etc. They enhance the realism of surround sound and improve sound localization behind the listener. Position them behind the listener about 2–3 feet (60–100 cm) above ear level.

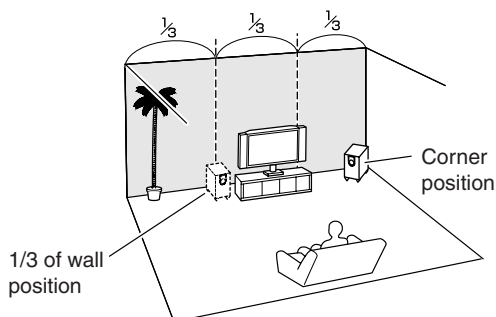
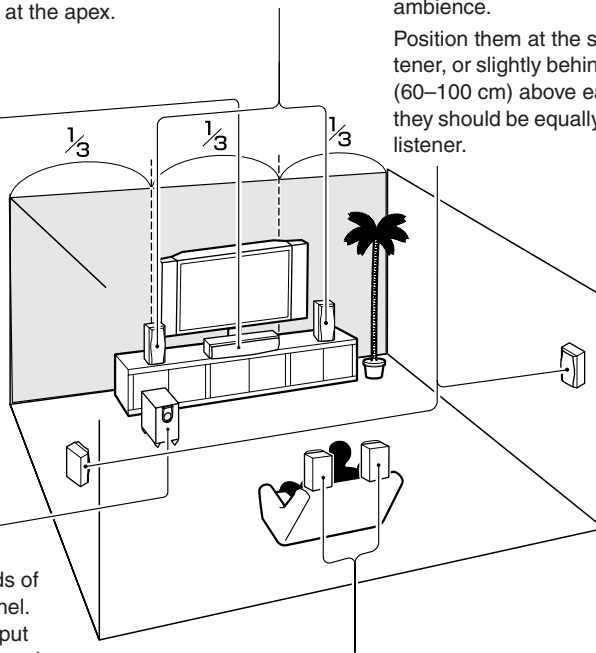

## Connecting Your Speakers—Continued

### Speaker Configuration

For 7.1-channel surround-sound playback, you need seven speakers and a powered subwoofer.

The following table shows which channels you should use based on the number of speakers you have.

Number of speakers:	2	3	4	5	6	7
Front left	✓	✓	✓	✓	✓	✓
Front right	✓	✓	✓	✓	✓	✓
Center		✓		✓	✓	✓
Surround left			✓	✓	✓	✓
Surround right			✓	✓	✓	✓
Surround back*					✓	
Surround back left						✓
Surround back right						✓

\* If you're using only one surround back speaker, connect it to the SURR BACK L terminals.

No matter how many speakers you use, a powered subwoofer is recommended for a powerful and solid bass.

To get the best from your surround-sound system, you must set the speaker settings. You can do this automatically (see page 42) or manually (see page 77).

### Speaker Connection Precautions

Read the following before connecting your speakers:

- You can connect speakers with an impedance of between 8 and 16 ohms. If you use speakers with a lower impedance, and use the amplifier at high volume levels for a long period of time, the built-in amp protection circuit may be activated.
- Disconnect the power cord from the wall outlet before making any connections.
- Read the instructions supplied with your speakers.
- Pay close attention to speaker wiring polarity. Connect positive (+) terminals to only positive (+) terminals, and negative (–) terminals to only negative (–) terminals. If you get them the wrong way around, the sound will be out of phase and will sound unnatural.
- Unnecessarily long or very thin speaker cables may affect the sound quality and should be avoided.
- Be careful not to short the positive and negative wires. Doing so may damage the AV receiver.
- Don't connect more than one cable to each speaker terminal. Doing so may damage the AV receiver.
- Don't connect a speaker to several terminals.

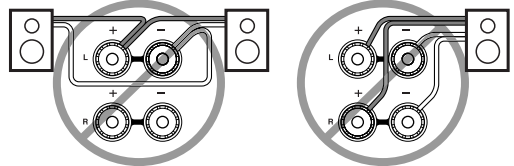
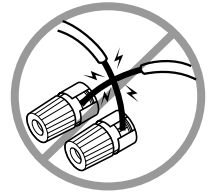

# Connecting Your Speakers—Continued

## Connecting Speaker Set A

**1** Strip 5/8" (15 mm) of insulation from the ends of the speaker cables, and twist the bare wires tightly, as shown.

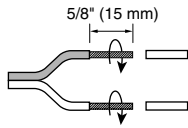

**2** Unscrew the terminal. Fully insert the bare wire, making sure that it's touching the threaded shaft in the center. Screw the terminal tight.

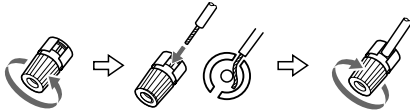

## Connecting Speaker Set B

**1** Strip 3/8" (10 mm) of insulation from the ends of the speaker cables, and twist the bare wires tightly, as shown.

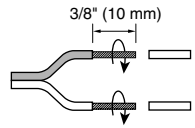

**2** While pressing the lever, insert the wire into the hole, and then release the lever. Make sure that the terminals are gripping the bare wires, not the insulation.

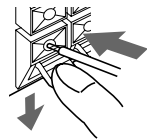

**Note:**

While speaker set B is on, speaker set A is reduced to 5.1-channel playback.

The following illustration shows which speaker should be connected to each pair of terminals.

If you're using only one surround back speaker, connect it to the left (L) SURR BACK SPEAKERS terminals.

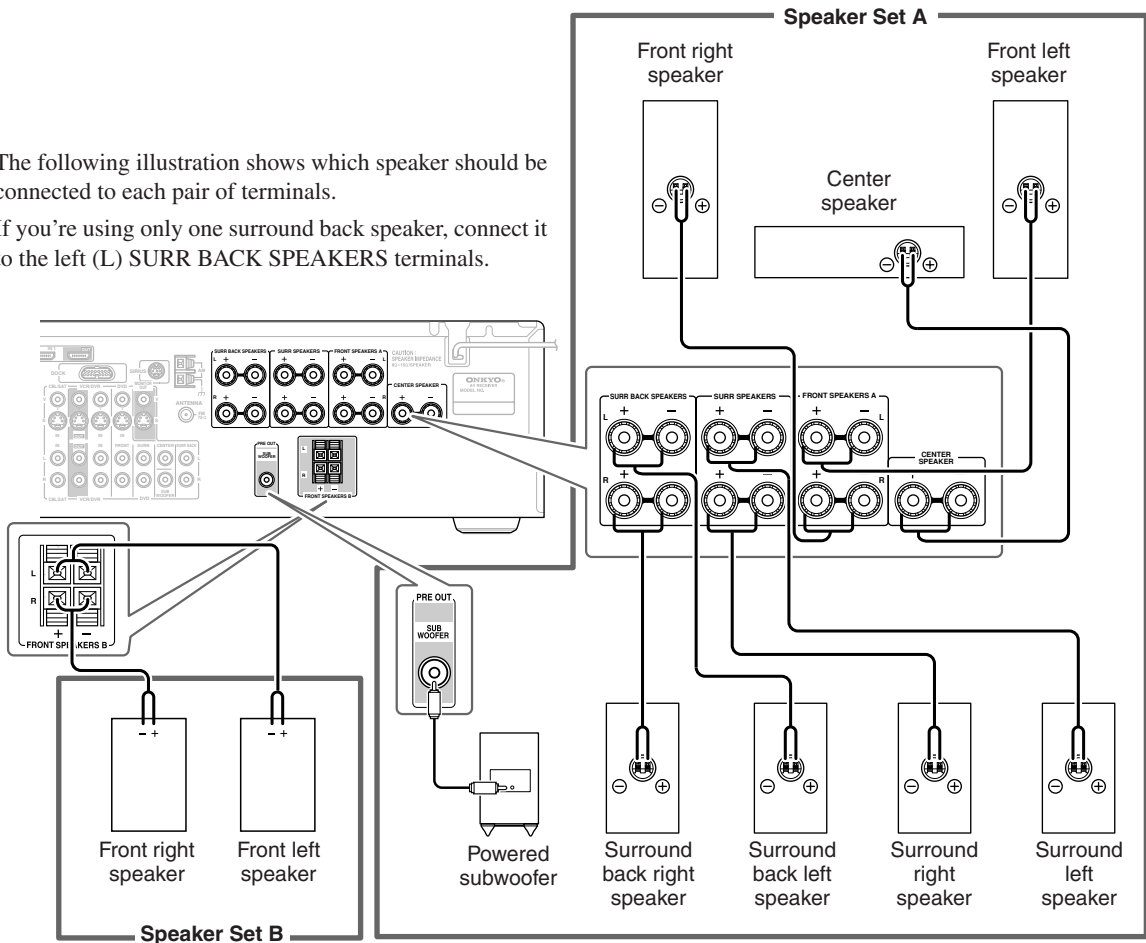

## Connecting Your Speakers—Continued

### Wall Mounting

The speakers can easily be wall mounted by using the keyhole slots.

To mount the front or surround speakers vertically, use the keyhole slot shown to hang each speaker on a screw that's securely screwed into the wall.

#### Front speaker (SKF-560F)

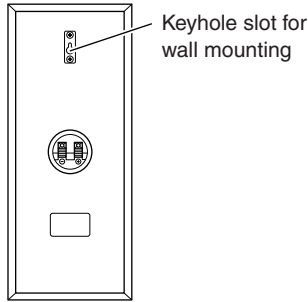

#### Surround speaker/ Surround back speaker (SKM-560S/SKB-560)

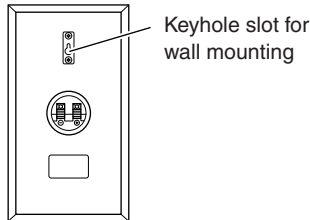

To mount the center speaker horizontally, use the two keyhole slots shown to hang each speaker on two screws that are securely screwed into the wall.

#### Center speaker (SKC-560C)

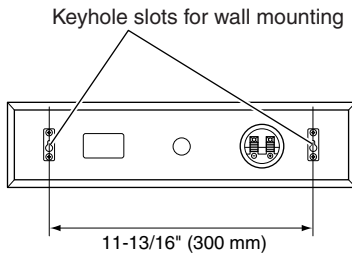

#### Caution:

A mounting screw's ability to support a speaker depends on how well it's anchored to the wall. If you have hollow walls, screw each mounting screw into a stud. If there are no studs, or the walls are solid, use suitable wall anchors. Use screws with a head diameter of  $5/16"$  (9 mm) or less and a shank diameter of  $1/8"$  (4 mm) or less. With hollow walls, use a cable/pipe detector to check for any power cables or water pipes before making any holes.

Leave a gap of between  $3/16"$  (5 mm) and  $7/16"$  (10 mm) between the wall and the base of the screw head, as shown.

(We recommend that you consult a home installation professional.)

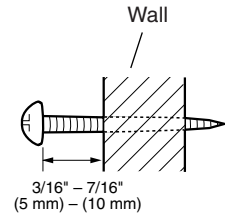

### Using the Floor Pads for Subwoofer

If the subwoofer is placed on a hard floor (wood, vinyl, tile, etc.) and playback is very loud, the subwoofer's feet may damage the flooring. To prevent this, place the supplied pads underneath the subwoofer's feet. The pads also provide a stable base for the subwoofer.

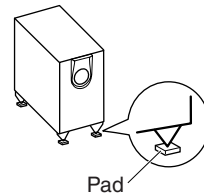



# Connecting Antennas

This section explains how to connect the supplied indoor FM antenna and AM loop antenna, and how to connect commercially available outdoor FM and AM antennas. The AV receiver won't pick up any radio signals without any antenna connected, so you must connect the antenna to use the tuner.

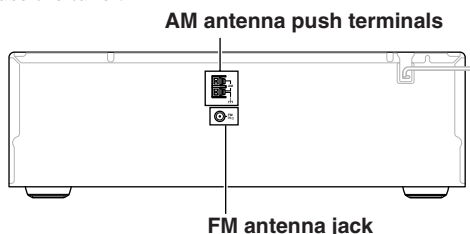

## Connecting the Indoor FM Antenna

The supplied indoor FM antenna is for indoor use only.

### 1 Attach the FM antenna, as shown.

#### ■ American Model

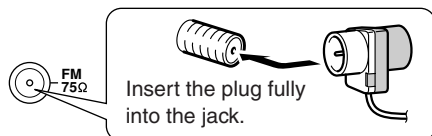

#### ■ Other Models

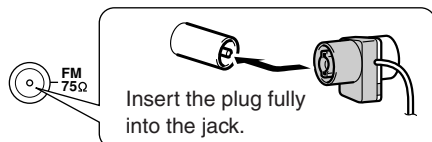

Once your AV receiver is ready for use, you'll need to tune into an FM radio station and adjust the position of the FM antenna to achieve the best possible reception.

### 2 Use thumbtacks or something similar to fix the FM antenna into position.

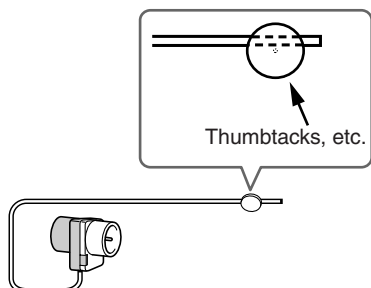

**Caution:** Be careful that you don't injure yourself when using thumbtacks.

If you cannot achieve good reception with the supplied indoor FM antenna, try a commercially available outdoor FM antenna instead (see page 26).

## Connecting the AM Loop Antenna

The supplied indoor AM loop antenna is for indoor use only.

### 1 Assemble the AM loop antenna, inserting the tabs into the base, as shown.

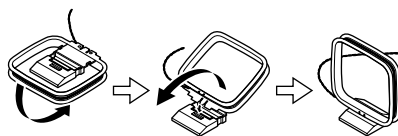

### 2 Connect both wires of the AM loop antenna to the AM push terminals, as shown.

(The antenna's wires are not polarity sensitive, so they can be connected either way around).

Make sure that the wires are attached securely and that the push terminals are gripping the bare wires, not the insulation.

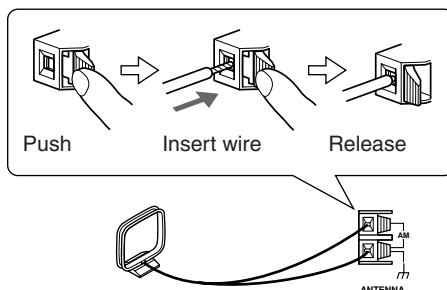

Once your AV receiver is ready for use, you'll need to tune into an AM radio station and adjust the position of the AM antenna to achieve the best possible reception.

Keep the antenna as far away as possible from your AV receiver, TV, speaker cables, and power cords.

If you cannot achieve good reception with the supplied indoor AM loop antenna, try using it with a commercially available outdoor AM antenna (see page 26).

### Connecting an Outdoor FM Antenna

If you cannot achieve good reception with the supplied indoor FM antenna, try a commercially available outdoor FM antenna instead.

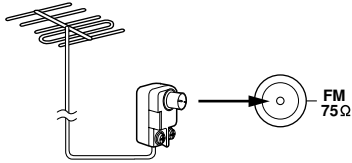

#### Notes:

- Outdoor FM antennas work best outside, but usable results can sometimes be obtained when installed in an attic or loft.
- For best results, install the outdoor FM antenna well away from tall buildings, preferably with a clear line of sight to your local FM transmitter.
- Outdoor antenna should be located away from possible noise sources, such as neon signs, busy roads, etc.
- For safety reasons, outdoor antenna should be situated well away from power lines and other high-voltage equipment.
- Outdoor antenna must be grounded in accordance with local regulations to prevent electrical shock hazards.

#### ■ Using a TV/FM Antenna Splitter

It's best not to use the same antenna for both FM and TV reception, as this can cause interference problems. If circumstances demand it, use a TV/FM antenna splitter, as shown.

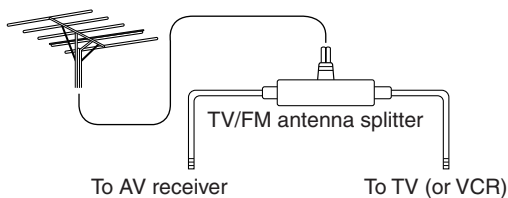

### Connecting an Outdoor AM Antenna

If good reception cannot be achieved using the supplied AM loop antenna, an outdoor AM antenna can be used in addition to the loop antenna, as shown.

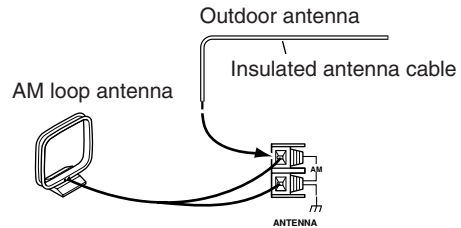

Outdoor AM antennas work best when installed horizontally outside, but good results can sometimes be obtained indoors by mounting horizontally above a window. Note that the AM loop antenna should be left connected.

Outdoor antenna must be grounded in accordance with local regulations to prevent electrical shock hazards.

# Connecting Your Components

## About AV Connections

- Before making any AV connections, read the manuals supplied with your other AV components.
- Don't connect the power cord until you've completed and double-checked all AV connections.

## Optical Digital Jacks

The AV receiver's optical digital jacks have shutter-type covers that open when an optical plug is inserted and close when it's removed. Push plugs in all the way.

**Caution:** To prevent shutter damage, hold the optical plug straight when inserting and removing.

## AV Connection Color Coding

RCA-type AV connections are usually color coded: red, white, and yellow. Use red plugs to connect right-channel audio inputs and outputs (typically labeled "R"). Use white plugs to connect left-channel audio inputs and outputs (typically labeled "L"). And use yellow plugs to connect composite video inputs and outputs.



- Push plugs in all the way to make good connections (loose connections can cause noise or malfunctions).
- To prevent interference, keep audio and video cables away from power cords and speaker cables.

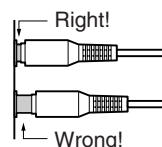

## AV Cables and Jacks

### Video

Cable	Jack	Description
		HDMI connections can carry uncompressed standard- or high-definition digital video and audio and offer the best picture and sound quality.
		Component video separates the luminance (Y) and color difference signals (Pr, Pb), providing the best picture quality. (Some TV manufacturers label their component video jacks slightly differently.)
		S-Video separates the luminance and color signals and provides better picture quality than composite video.
		Composite video is commonly used on TVs, VCRs, and other video equipment.

### Audio

		This offers the best sound quality and allows you to enjoy Dolby Digital and DTS. The audio quality is the same as for coaxial.
		This offers the best sound quality and allows you to enjoy Dolby Digital and DTS. The audio quality is the same as for optical.
		This cable carries analog audio. It's the most common connection format for analog audio and can be found on virtually all AV components.
		This cable carries multichannel analog audio and is typically used to connect DVD players with a 7.1-channel analog audio output. Several standard analog audio cables can be used instead of a multichannel cable.

**Note:** The AV receiver does not support SCART connections.

## Connecting Audio and Video Signals to the AV Receiver

By connecting both the audio and video outputs of your DVD player and other AV components to the AV receiver, you can switch the audio and video signals simultaneously simply by changing the input source on the AV receiver.

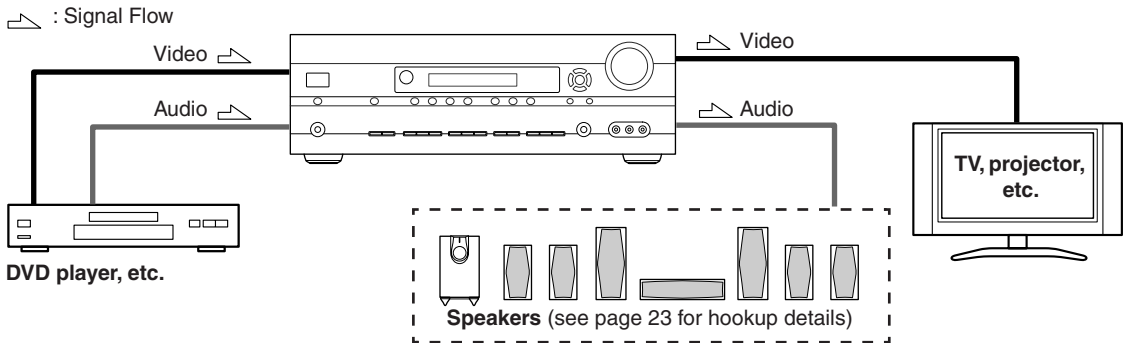

## Which Connections Should I Use?

The AV receiver supports several connection formats for compatibility with a wide range of AV equipment. The format you choose will depend on the formats supported by your other components. Use the following sections as a guide.

For video components, you must make an audio connection and a video connection.

### Video Connection Formats

Video equipment can be connected to the AV receiver by using any one of the following video connection formats: composite video, S-Video, component video, or HDMI, the latter offering the best picture quality.

When choosing a connection format, bear in mind that the AV receiver doesn't convert between formats, so only outputs of the same format as the input will output the signal.

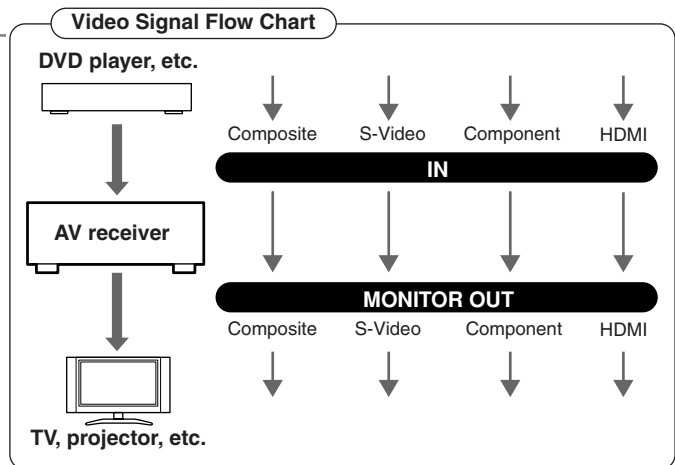

### Audio Connection Formats

Audio equipment can be connected to the AV receiver by using any of the following audio connection formats: analog, optical, coaxial, analog multichannel, or HDMI.

When you connect audio equipment to an HDMI, OPTICAL, or COAXIAL input, you must assign that input to an input selector (see pages 44 and 46).

Audio signals received by the HDMI IN jacks are output only by the HDMI OUT (pass thru). HDMI sources are not output by the speakers connected to the AV receiver.

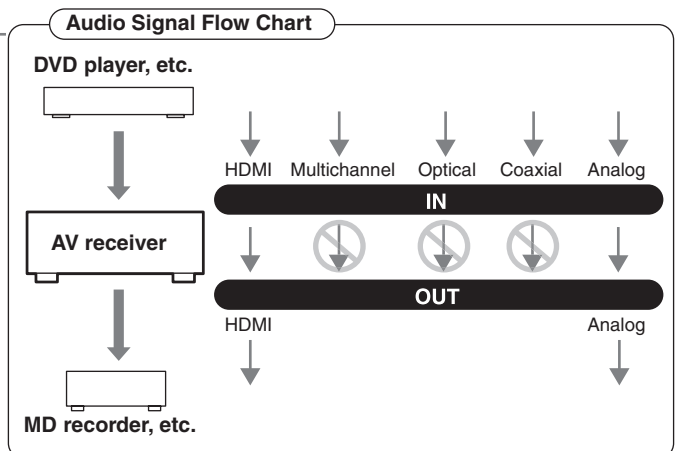

# Connecting Your Components—Continued

## Connecting a TV or Projector

### Step 1: Video Connection

Choose a video connection that matches your TV (**A**, **B**, or **C**), and then make the connection.

### Step 2: Audio Connection

Choose an audio connection that matches your TV (**a**, **b**, or **c**), and then make the connection.

- To enjoy Dolby Digital and DTS, use connection **b** or **c**.

Connection	AV receiver	Signal flow	TV	Picture quality
<b>A</b>	COMPONENT VIDEO OUT	⇒	Component video input	Best
<b>B</b>	MONITOR OUT S	⇒	S-Video input	Better
<b>C</b>	MONITOR OUT V	⇒	Composite video input	Standard
<b>a</b>	CBL/SAT IN L/R	⇐	Analog audio L/R output	
<b>b</b>	DIGITAL IN COAXIAL 2	⇐	Digital coaxial output	
<b>c</b>	DIGITAL IN OPTICAL 1	⇐	Digital optical output	

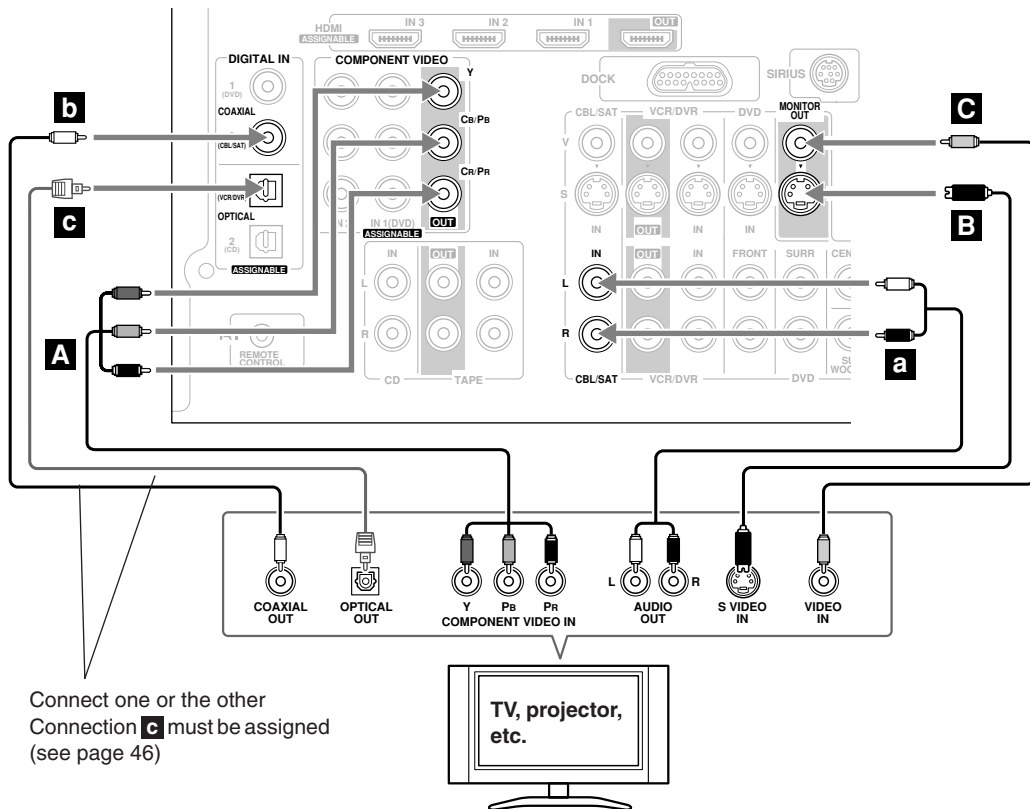

**Hint!** If your TV has no audio outputs, connect an audio output from your VCR or cable or satellite receiver to the AV receiver and use its tuner to listen to TV programs through the AV receiver (see pages 32 and 34).

## Connecting a DVD player

### Step 1: Video Connection

Choose a video connection that matches your DVD player (**A**, **B**, or **C**), and then make the connection. You must connect the AV receiver to your TV with the same type of connection.

### Step 2: Audio Connection

Choose an audio connection that matches your DVD player (**a**, **b**, or **c**), and then make the connection.

- To enjoy Dolby Digital and DTS, use connection **b** or **c**.
- If your DVD player has main left and right outputs and multichannel left and right outputs, be sure to use the main left and right outputs for connection **a**.

Connection	AV receiver	Signal flow	DVD player	Picture quality
<b>A</b>	COMPONENT VIDEO IN 1	←	Component video output	Best
<b>B</b>	DVD IN S	←	S-Video output	Better
<b>C</b>	DVD IN V	←	Composite video output	Standard
<b>a</b>	DVD IN FRONT L/R	←	Analog audio L/R output	
<b>b</b>	DIGITAL IN COAXIAL 1	←	Digital coaxial output	
<b>c</b>	DIGITAL IN OPTICAL 1	←	Digital optical output	

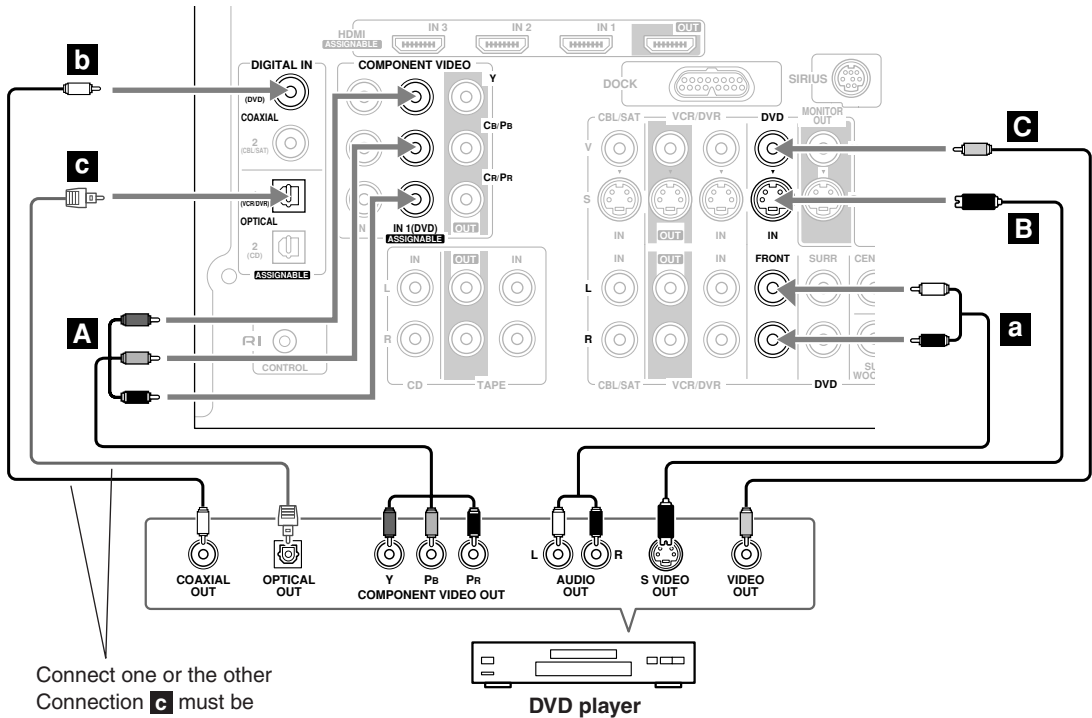

To connect a DVD player or DVD-Audio/SACD-capable player with a multichannel analog audio output, see page 31.

# Connecting Your Components—Continued

## Hooking Up the Multichannel Input

If your DVD player supports multichannel audio formats such as DVD-Audio and SACD, and it has a multichannel analog audio output, you can connect it to the AV receiver's multichannel input.

Use a multichannel analog audio cable, or several normal audio cables, to connect the AV receiver's DVD IN FRONT L/R, CENTER, SURR L/R, SURR BACK L/R, and SUBWOOFER jacks to the 7.1-channel analog audio output on your DVD player. If your DVD player has a 5.1-channel analog audio output, don't connect anything to the AV receiver's SURR BACK L/R jacks.

To select the multichannel input, see "Basic AV Receiver Operation" on page 47. To adjust the subwoofer sensitivity for the multichannel input, see "Using the Audio Adjust Settings" on page 74–75.

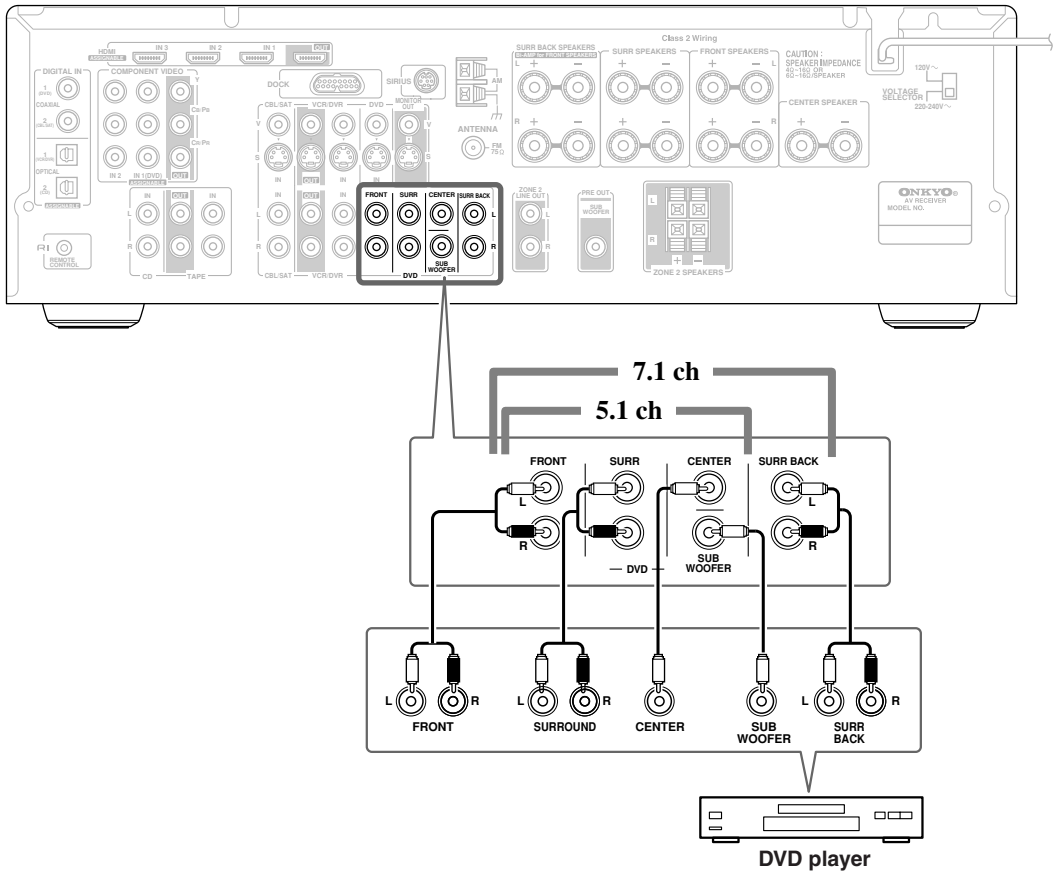

## Connecting a VCR or DVR for Playback



With this hookup, you can use the tuner in your VCR or DVR to listen to your favorite TV programs via the AV receiver, which is useful if your TV has no audio outputs.

### Step 1: Video Connection

Choose a video connection that matches your VCR or DVR (**A**, **B**, or **C**), and then make the connection. You must connect the AV receiver to your TV with the same type of connection.

### Step 2: Audio Connection

Choose an audio connection that matches your VCR or DVR (**a**, **b**, or **c**), and then make the connection.

- To enjoy Dolby Digital and DTS, use connection **b** or **c**.

Connection	AV receiver	Signal flow	VCR or DVR	Picture quality
<b>A</b>	COMPONENT VIDEO IN 2	←	Component video output	Best
<b>B</b>	VCR/DVR IN S	←	S-Video output	Better
<b>C</b>	VCR/DVR IN V	←	Composite video output	Standard
<b>a</b>	VCR/DVR IN L/R	←	Analog audio L/R output	
<b>b</b>	DIGITAL IN COAXIAL 2	←	Digital coaxial output	
<b>c</b>	DIGITAL IN OPTICAL 1	←	Digital optical output	

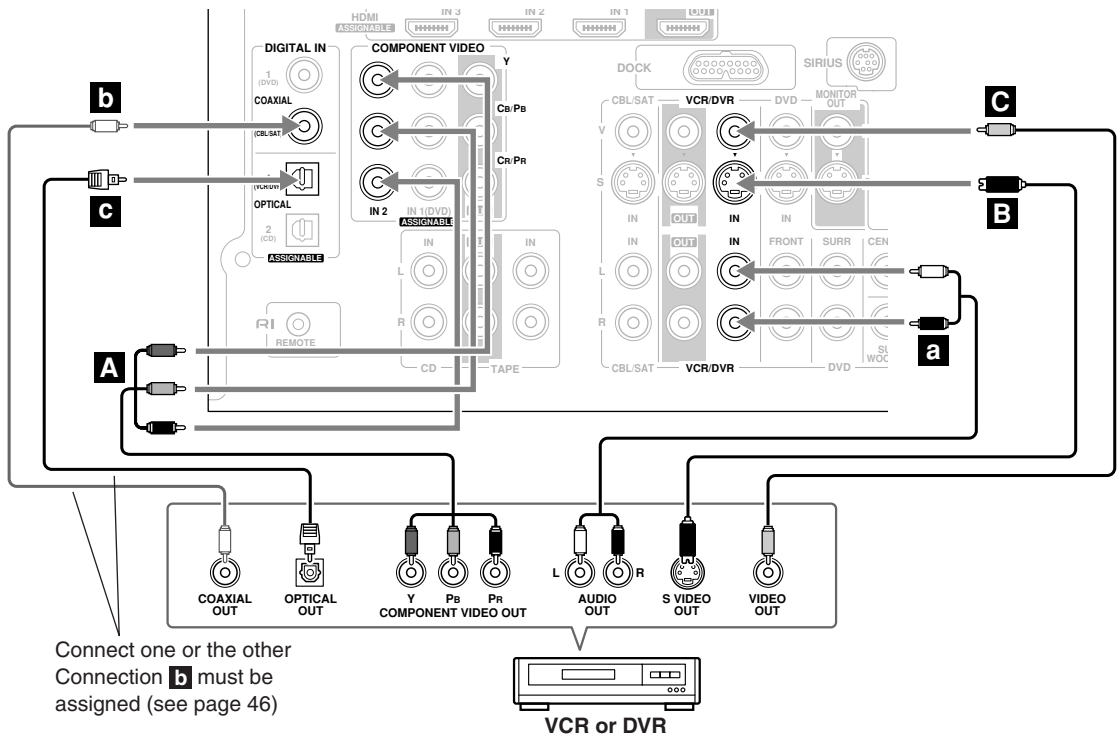



## Connecting Your Components—Continued

### Connecting a VCR or DVR for Recording

#### Step 1: Video Connection

Choose a video connection that matches your VCR or DVR (**A** or **B**), and then make the connection. The video source to be recorded must be connected to the AV receiver via the same type of connection.

#### Step 2: Audio Connection

Make the audio connection **a**.

Connection	AV receiver	Signal flow	VCR or DVD recorder	Picture quality
<b>A</b>	VCR/DVR OUT S	⇒	S-Video input	Better
<b>B</b>	VCR/DVR OUT V	⇒	Composite video input	Standard
<b>a</b>	VCR/DVR OUT L/R	⇒	Audio L/R input	

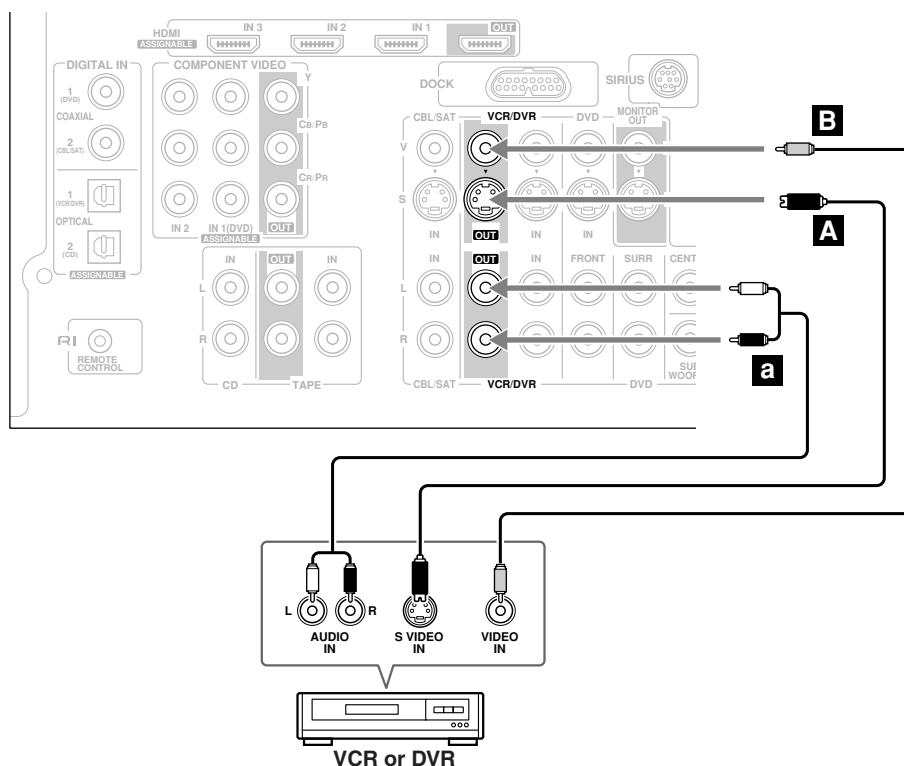

#### Notes:

- The AV receiver must be turned on for recording. Recording is not possible while it's on Standby.
- If you want to record directly from your TV or another video source without going through the AV receiver, connect the audio and video outputs from your TV or other video component directly to the recording VCR/DVR's audio and video inputs. See the manuals supplied with your TV or VCR/DVR for details.
- Video signals connected to composite video inputs can only be recorded via the VCR/DVR OUT V jack. So if your source TV or VCR is connected to a composite video input, the recording VCR/DVR must be connected to the VCR/DVR OUT V jack. Likewise, video signals connected to S-Video inputs can only be recorded via the VCR/DVR OUT S jack. So if your source TV or VCR is connected to an S-Video input, the recording VCR/DVR must be connected to the VCR/DVR OUT S jack.

## Connecting a Satellite, Cable, or Terrestrial Set-top box or Other Video Source



With this hookup, you can use your satellite or cable receiver to listen to your favorite TV programs via the AV receiver, which is useful if your TV has no audio outputs.

### Step 1: Video Connection

Choose a video connection that matches the video source (**A**, **B**, or **C**), and then make the connection. You must connect the AV receiver to your TV with the same type of connection.

### Step 2: Audio Connection

Choose an audio connection that matches the video source (**a**, **b**, or **c**), and then make the connection.

- To enjoy Dolby Digital and DTS, use connection **b** or **c**.

Connection	AV receiver	Signal flow	Video source	Picture quality
<b>A</b>	COMPONENT VIDEO IN 2	←	Component video output	Best
<b>B</b>	CBL/SAT IN S	←	S-Video output	Better
<b>C</b>	CBL/SAT IN V	←	Composite video output	Standard
<b>a</b>	CBL/SAT IN L/R	←	Analog audio L/R output	
<b>b</b>	DIGITAL IN COAXIAL 2	←	Digital coaxial output	
<b>c</b>	DIGITAL IN OPTICAL 1	←	Digital optical output	

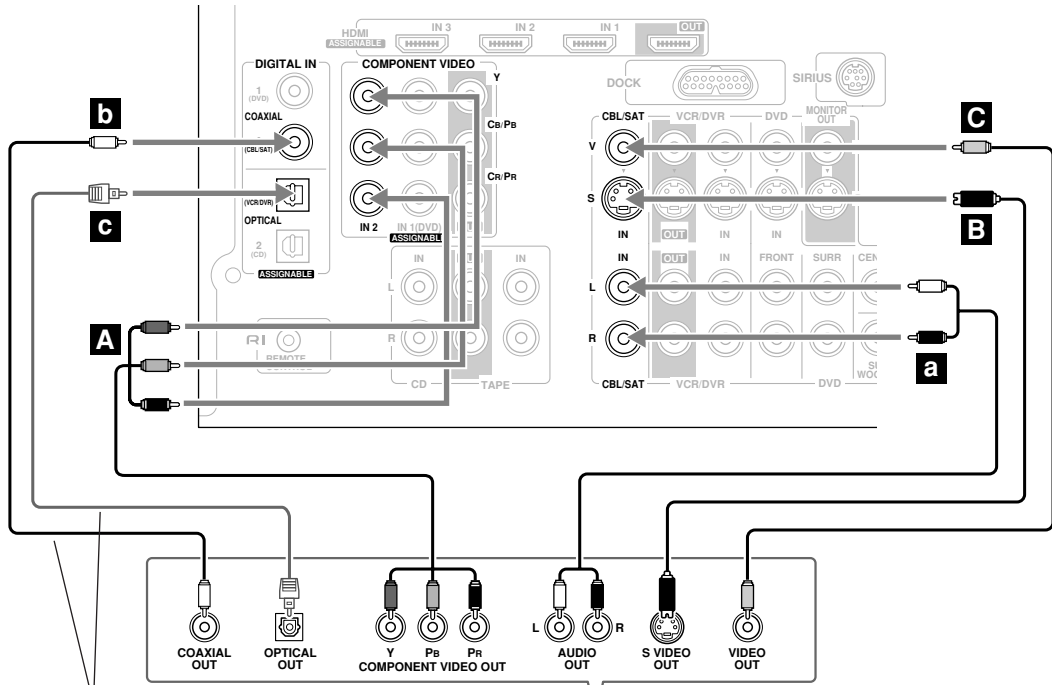

Connect one or the other Connection **c** must be assigned (see page 46)

Satellite, cable, set-top box, etc.

### Connecting Components with HDMI

#### About HDMI

Designed to meet the increased demands of digital TV, HDMI (High Definition Multimedia Interface) is a new digital interface standard for connecting TVs, projectors, DVD players, set-top boxes, and other video components. Until now, several separate video and audio cables have been required to connect AV components. With HDMI, a single cable can carry control signals, digital video, and up to eight channels of digital audio (2-channel PCM, multichannel digital audio, or multichannel PCM).

The HDMI video stream (i.e., video signal) is compatible with DVI (Digital Visual Interface),\*<sup>1</sup> so TVs and displays with a DVI input can be connected by using an HDMI-to-DVI adapter cable. (This may not work with some TVs and displays, resulting in no picture.)

The AV receiver uses HDCP (High-bandwidth Digital Content Protection), so only HDCP-compatible components will display a picture.

The AV receiver's HDMI interface is based on the following standard:

**HT-R560:** Pass-thru

#### About Copyright Protection

The AV receiver supports HDCP (High-bandwidth Digital Content Protection),\*<sup>2</sup> a copy-protection system for digital video signals. Other devices connected to the AV receiver via HDMI must also support HDCP.

Use a commercially available HDMI cable (supplied with some components) to connect the AV receiver's HDMI OUT to the HDMI input on your TV or projector.

\*1 DVI (Digital Visual Interface): The digital display interface standard set by the DDWG\*<sup>3</sup> in 1999.

\*2 HDCP (High-bandwidth Digital Content Protection): The video encryption technology developed by Intel for HDMI/DVI. It's designed to protect video content and requires a HDCP-compatible device to display the encrypted video.

\*3 DDWG (Digital Display Working Group): Led by Intel, Compaq, Fujitsu, Hewlett Packard, IBM, NEC, and Silicon Image, this open industry group's objective is to address the industry's requirements for a digital connectivity specification for high-performance PCs and digital displays.

### Making HDMI Connections

If you have an HDMI-compatible player, you can connect it to the AV receiver with an HDMI cable.

**Step 1: Connect your HDMI-compatible TV to the AV receiver's HDMI OUT jack.**

**Step 2: Connect your HDMI-compatible player to the AV receiver's HDMI IN 1, 2, or 3 jack.**

**Step 3: Connect your HDMI-compatible player to an analog and/or digital audio input on the AV receiver.**

**Step 4: Assign the HDMI IN.**

Turn on the AV receiver, and then assign the HDMI IN (see page 44).

#### ■ Audio Signals

- Audio and video signals received via inputs other than the HDMI IN jacks are not output by the HDMI OUT.
- Audio and video signals received via the HDMI IN jacks are output only by the HDMI OUT.
- To watch an HDMI source that's connected via the AV receiver's HDMI jacks, the AV receiver must be turned on, otherwise no HDMI signal will be output.
- If you want to listen through the speakers connected to the AV receiver, in addition to an HDMI connection, you'll also need to make a separate analog or digital audio connection.

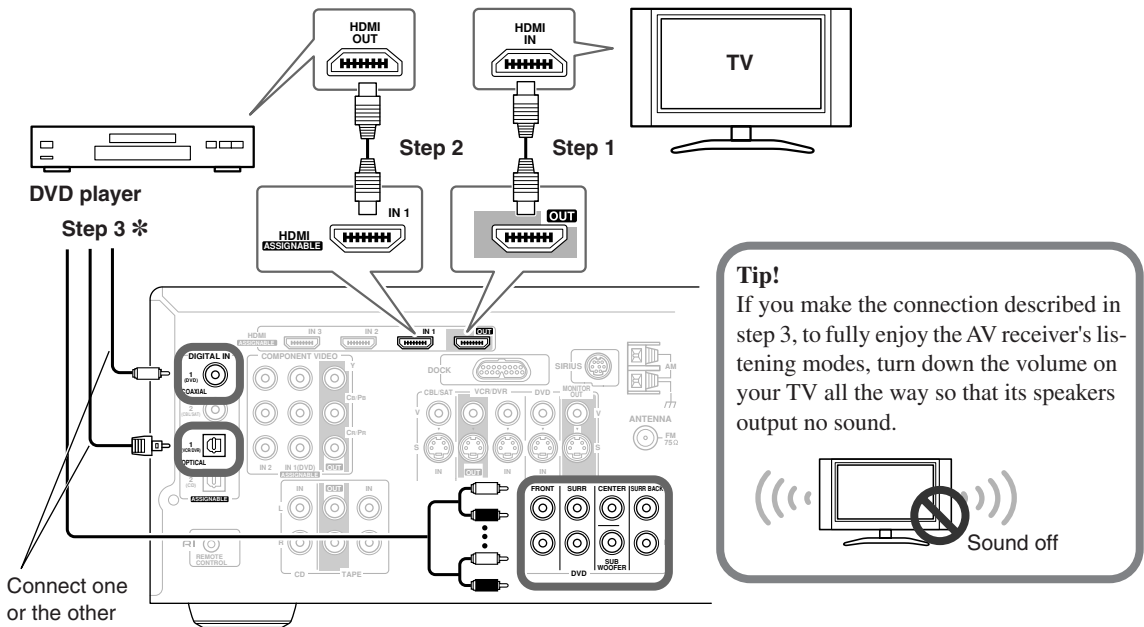

#### Notes:

- The HDMI video stream is compatible with DVI (Digital Visual Interface), so TVs and displays with a DVI input can be connected by using an HDMI-to-DVI adapter cable. (Note that DVI connections only carry video, so you'll need to make a separate connection for audio.) However, reliable operation with such an adapter is not guaranteed. In addition, video signals from a PC are not supported.
- When listening to an HDMI component through the AV receiver, set the HDMI component so that its video can be seen on the TV screen (on the TV, select the input of the HDMI component connected to the AV receiver). If the TV power is off or the TV is set to another input source, this may result in no sound from the AV receiver or the sound may be cut off.
- The HDMI audio signal (sampling rate, bit length, etc.) may be restricted by the connected source component. If the picture is poor or there's no sound from a component connected via HDMI, check its setup. Refer to the connected component's instruction manual for details.

## Connecting Your Components—Continued

### Connecting a Camcorder, Game Console, or Other Device

Step 1: Make the video connection **A**.

Step 2: Make the audio connection **a**.

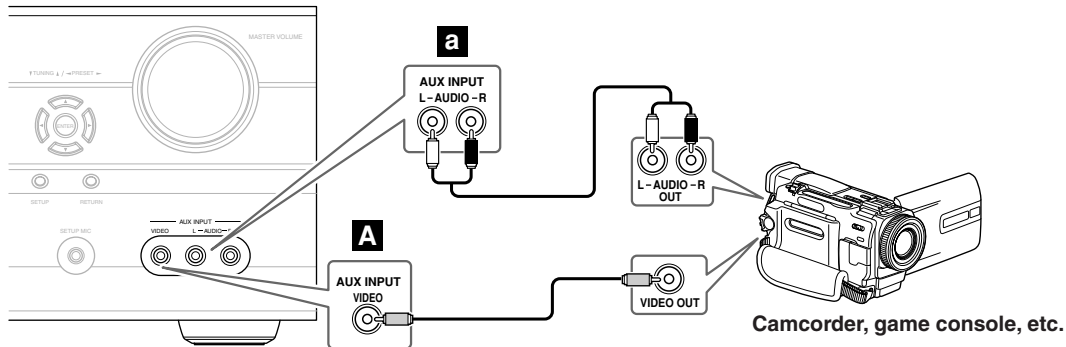

Connection	AV receiver	Signal flow	Camcorder or console
<b>A</b>	AUX INPUT VIDEO	←	Composite video output
<b>a</b>	AUX INPUT L-AUDIO-R	←	Analog audio L/R output

### Connecting the Supplied DS-A1L Dock

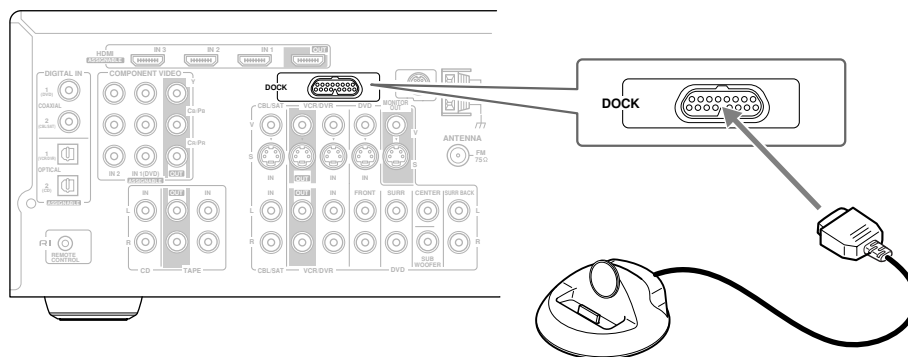

#### Notes:

- To connect an RI dock other than the DS-A1L, refer to its instruction manual.
- While your iPod is seated in the Dock, its battery will be charged when the AV receiver is set to On or Standby.

## Connecting a CD Player or Turntable

### ■ CD Player or Turntable (MM) with Built-in Phono Preamp

#### Step 1:

Choose a connection that matches your CD player (**a**, **b**, or **c**). Use connection **a** for a turntable with a built-in phono preamp.

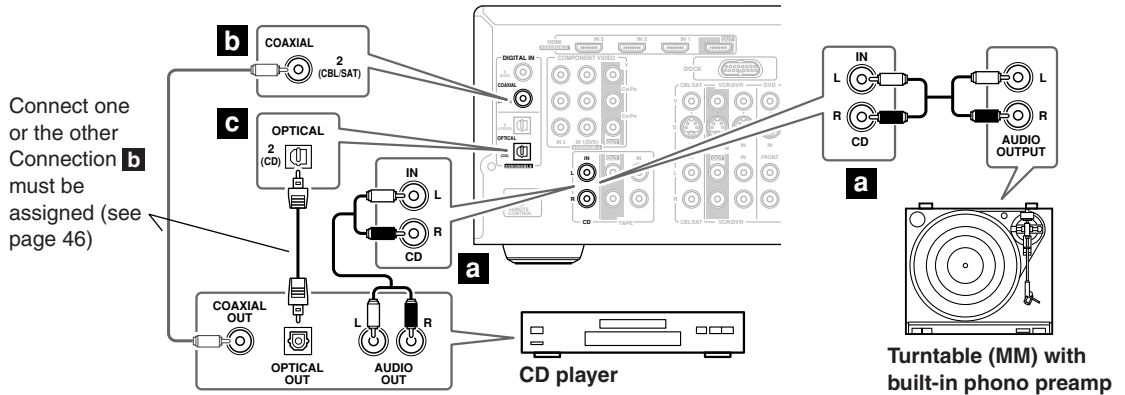

- To connect the CD player digitally, use connection **b** or **c**.

Connection	AV receiver	Signal flow	CD or turntable
<b>a</b>	CD IN L/R	←	Analog audio L/R output
<b>b</b>	DIGITAL IN COAXIAL 2	←	Digital coaxial output
<b>c</b>	DIGITAL IN OPTICAL 2	←	Digital optical output

### ■ Turntable (MM) with no Phono Preamp Built-in

A phono preamp is necessary to connect a turntable that doesn't have a phono preamp built-in.

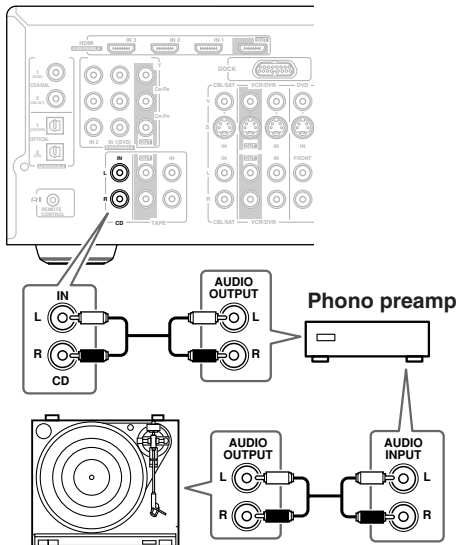

### ■ Turntable with an MC (Moving Coil) Cartridge

An MC head amp and phono preamp are necessary to connect a turntable with an MC (Moving Coil) cartridge.

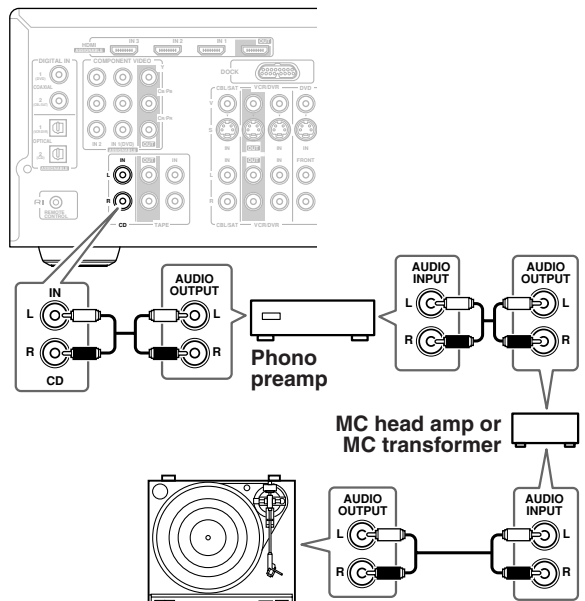

## Connecting a Cassette, CDR, MiniDisc, or DAT Recorder

### Step 1:

Choose a connection that matches your recorder (**a**, **b**, or **c**), and then make the connection.

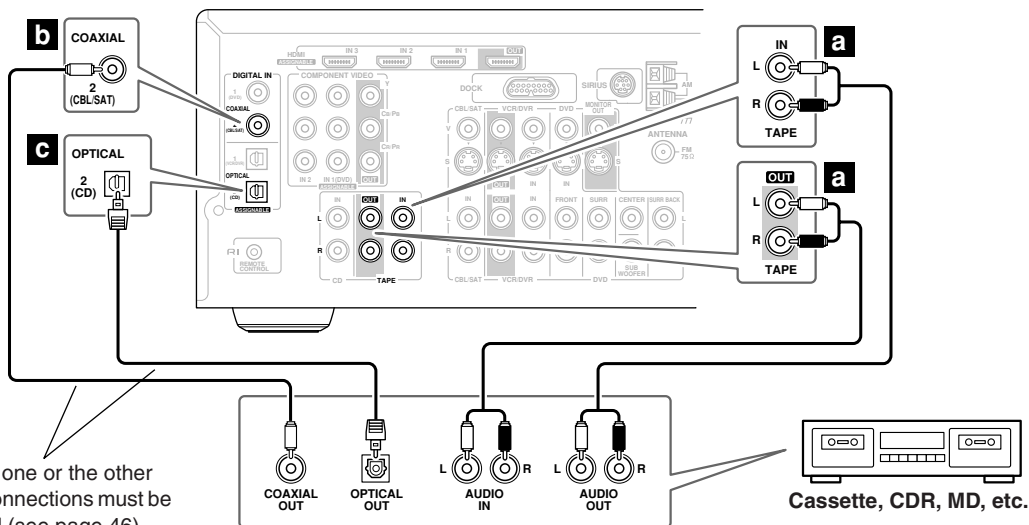

- To connect the recorder digitally for playback, use connections **a** and **b**, or **a** and **c**.

Connection	AV receiver	Signal flow	Cassette, CDR, MD, or DAT recorder
<b>a</b>	TAPE IN L/R TAPE OUT L/R	← ⇒	Analog audio L/R output Analog audio L/R input
<b>b</b>	DIGITAL IN COAXIAL 2	←	Digital coaxial output
<b>c</b>	DIGITAL IN OPTICAL 2	←	Digital optical output

### Connecting Onkyo **RI** Components

**Step 1:** Make sure that each Onkyo component is connected to the AV receiver with an analog audio cable (RCA).

**Step 2:** Make the necessary **RI** connections (see illustration below).

**Step 3:** If you're using an MD or CDR component, change the Input Display (see page 46).

With **RI** (Remote Interactive), you can use the following special functions:

#### Auto Power On/Standby

When you start playback on a component connected via **RI**, if the AV receiver is on Standby, it will automatically turn on and select that component as the input source. Similarly, when the AV receiver is set to Standby, all components connected via **RI** will also go on Standby.

#### Direct Change

When playback is started on a component connected via **RI**, the AV receiver automatically selects that component as the input source. If your DVD player is connected to the AV receiver's DVD IN (multichannel input), you'll need to press the [MULTI CH] button repeatedly and select Multich to hear all channels (see page 47), as the Direct Change **RI** function selects the DVD IN FRONT L/R jacks.

#### Remote Control

You can use the AV receiver's remote controller to control your other **RI**-capable Onkyo components. You must enter the appropriate remote control code first (see page 83). And remember to point the remote controller at the AV receiver and not the other component.

#### Notes:

- Use only **RI** cables for **RI** connections. **RI** cables are supplied with Onkyo players (DVD, CD, etc.).
- Some components have two **RI** jacks. You can connect either one to the AV receiver. The other jack is for connecting additional **RI**-capable components.
- Connect only Onkyo components to **RI** jacks. Connecting other manufacturer's components may cause a malfunction.
- Some components may not support all **RI** functions. Refer to the manuals supplied with your other Onkyo components.

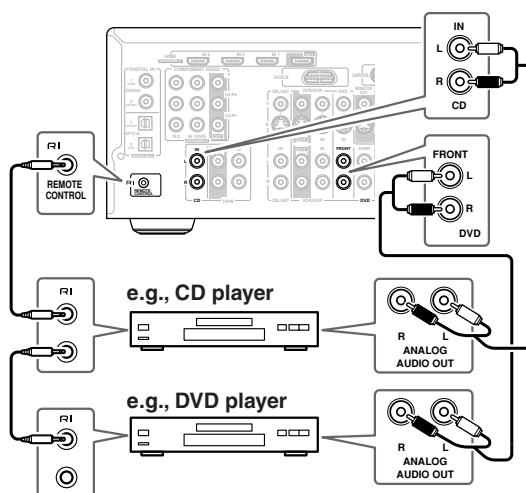

### Connecting the Power Cord

- Before connecting the power cord, connect all your speakers and AV components.
- Plug the end of the power cord into a suitable wall outlet.
- Turning on the AV receiver may cause a momentary power surge that might interfere with other electrical equipment on the same circuit. If this is a problem, plug the AV receiver into a different branch circuit.



# Turning On the AV Receiver

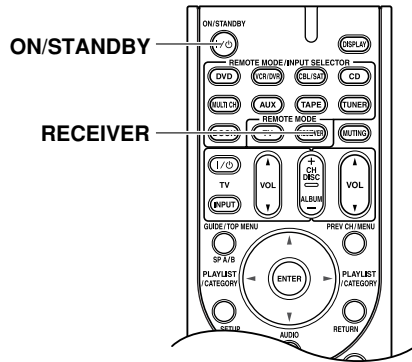
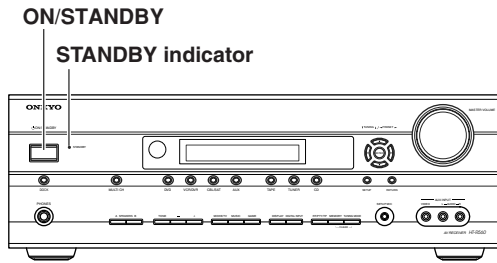

## Turning On and Standby

**AV receiver**

**Remote controller**

or

**On the AV receiver, press the [ON/STANDBY] button.**

**On the remote controller, press the [RECEIVER] REMOTE MODE button, followed by the [ON/STANDBY] button.**

The AV receiver comes on, the display lights up, and the STANDBY indicator goes off.

To turn the AV receiver off, press the [ON/STANDBY] button, or press the remote controller's [ON/STANDBY] button. The AV receiver will enter Standby mode. To prevent any loud surprises the next time you turn on the AV receiver, turn down the volume before you turn it off.

## Up and Running in a Few Easy Steps

To get your system up and running with the minimum of fuss, here's a few pointers to help you configure the AV receiver before you use it for the very first time. These settings only need to be made once.

■ **Do the automatic speaker setup—this is essential!**

See “Automatic Speaker Setup (Audyssey 2EQ)” on page 42.

■ **Did you connect a component to an HDMI input, component video input, or digital audio input?**

If you did, see “HDMI Input Setup” on page 44, “Component Video Input Setup” on page 45, or “Digital Input Setup” on page 46 respectively.

■ **Did you connect an Onkyo MD recorder or CD recorder?**

If you did, see “Changing the Input Display” on page 46.

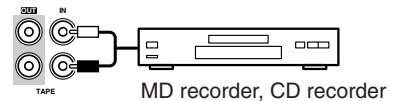
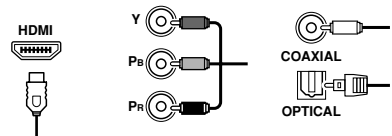

# First Time Setup

This section explains the settings that you need to make before using the AV receiver for the very first time.

## Automatic Speaker Setup (Audyssey 2EQ)

With the supplied calibrated microphone, Audyssey 2EQ automatically determines the number of speakers connected, their size for purposes of bass management, optimum crossover frequencies to the subwoofer (if present), and distances from the primary listening position. Audyssey 2EQ then removes the distortion caused by room acoustics by capturing room acoustical problems over the listening area in both the frequency and time domain. The result is clear, well-balanced sound for everyone. Enabling Audyssey 2EQ allows you to also use Audyssey Dynamic EQ, which maintains the proper octave-to-octave balance at any volume level. (See page 76)

### Measurement Positions

To create a listening environment in which several people can enjoy your home theater simultaneously, Audyssey 2EQ takes measurements at three positions within the listening area.

- ① **First measurement point**  
This is the center point of the listening area, or the listening position.
- ② **Second measurement point**  
The right side of the listening area.
- ③ **Third measurement point**  
The left side of the listening area.

The distances between points ① and ② and points ① and ③ must be at least 1 meter.

From the examples below, choose the listening area that best matches yours and place the microphone accordingly when prompted.

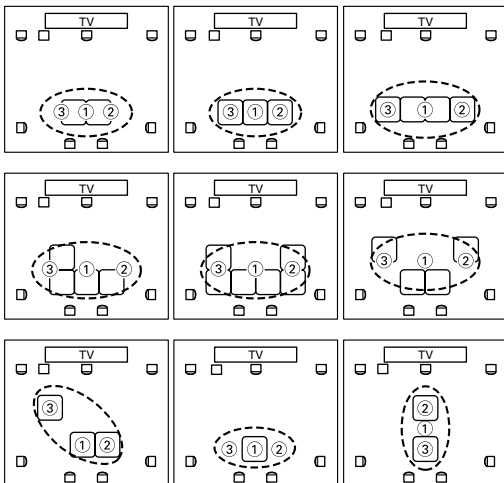

- : Listening area
- : Listening position

## Using Audyssey 2EQ

### Notes:

- If the AV receiver is muted, it will be unmuted automatically when the automatic speaker setup starts.
- Automatic speaker setup cannot be performed while a pair of headphones is connected.
- It takes about 10 minutes to complete the automatic speaker setup for three positions. Total measurement time varies depending on the speakers.
- Do not connect or disconnect any speakers during the automatic speaker setup.

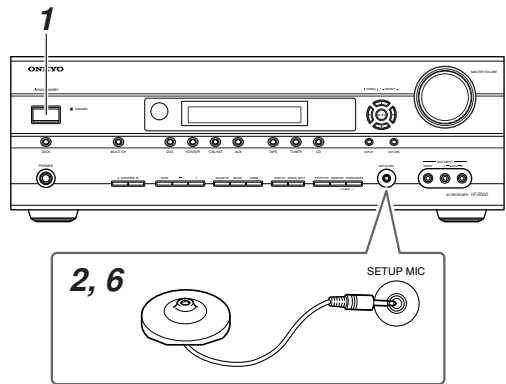

<b>1</b>	<b>Turn on the AV receiver.</b>
<b>2</b>	<b>Put the speaker setup microphone at measurement point ① (see left), and connect it to the SETUP MIC jack.</b>

Set Mic at 1st.

### Notes:

- For all measurements, the microphone capsule should point directly at the ceiling.
- If there's an obstacle between the microphone and any speaker, the automatic setup will not work correctly. Set up the room as you would when enjoying a DVD.
- Positioning the microphone close to where your ears would normally be will provide better results. You can adjust the height of the microphone by using a tripod or level table.
- Do not attempt to hold the microphone in your hand during measurements as this will produce incorrect results.

### 3 Press [ENTER].

The automatic speaker setup starts. You can cancel the automatic speaker setup at any point in this procedure simply by disconnecting the setup microphone.

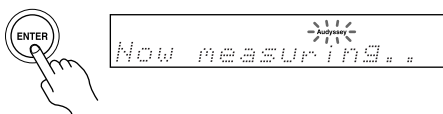

A test tone is output by each speaker in turn, as the Audyssey 2EQ function determines which speakers are connected. This takes a few minutes.

**Note:**

- Quiet the room as much as possible. Background noise can disrupt the room measurements. Close windows, silence cell phones, televisions, radios, air conditioners, fluorescent lights, home appliances, light dimmers, or other devices, and refrain from talking.

### 4 When the following display appears, move the speaker setup microphone to measurement point ② (page 42), and then press [ENTER].

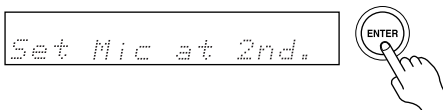

Audyssey 2EQ performs more measurements. This takes a few minutes.

### 5 When the following display appears, move the speaker setup microphone to measurement point ③ (page 42), and then press [ENTER].

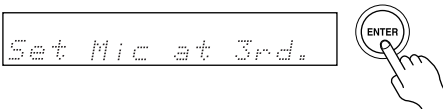

Audyssey 2EQ performs more measurements. This takes a few minutes.

When the measurements are complete, the results are calculated and saved automatically.

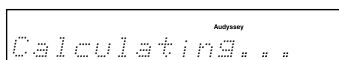

### 6 When the automatic speaker setup is complete, disconnect the speaker setup microphone.

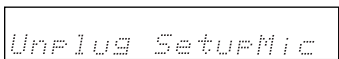

**Note:**

- When the automatic speaker setup is complete, the Equalizer Settings (page 81) will be set to “Audyssey.”

## Error Messages

While the automatic speaker setup is in progress, one of the following error messages may appear:

**Ambient noise is too high**

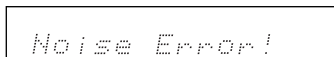

This message appears if there’s too much background noise and the measurements cannot be performed properly. Remove the source of the noise and try again.

**Speaker Detect Errors**

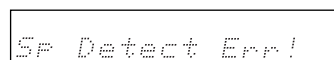

This message appears if one of the speaker-related errors below occurs.

- One of the front speakers has not been detected.
- One of the surround speakers has not been detected.
- The surround back speakers have been detected but the surround speakers haven’t.
- The right surround back speaker has been detected but the left surround back speaker hasn’t.
- The number of speakers detected on the second or third measurement was different to the number detected on the first measurement.

**Write Error**

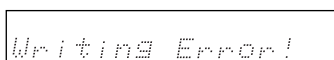

This message appears if saving fails.

**Matching Error**

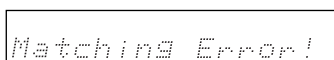

This message appears if a speaker that was detected during the 1st measurement is not detected during the 2nd or 3rd measurements. If this message appears, check your speaker connections, and then try again.

### To Retry the Automatic Speaker Setup

Press the [ENTER] button. Make sure speakers that cannot be detected are connected properly.



## Changing the Speaker Settings Manually

If you wish to make changes to the settings found during the automatic speaker setup, follow the directions on pages 77–81.

**Using a Powered Subwoofer**

If you're using a powered subwoofer, as it outputs very low-frequency sound and its position is usually low down, it may not be detected by the automatic speaker setup. In this case, increase the subwoofer's volume, select its highest crossover frequency, and then try running the automatic speaker setup again. Note that if the volume is set too high and the sound distorts, it may not be detected, so use an appropriate volume level.

**HDMI Input Setup**

If you connect a video component to an HDMI IN, you must assign that input to an input selector. For example, if you connect your DVD player to HDMI IN 1, you must assign HDMI IN 1 to the DVD input selector. By default, none of the HDMI inputs are assigned. The following input selectors can be assigned: DVD, VCR/DVR, CBL/SAT, AUX.

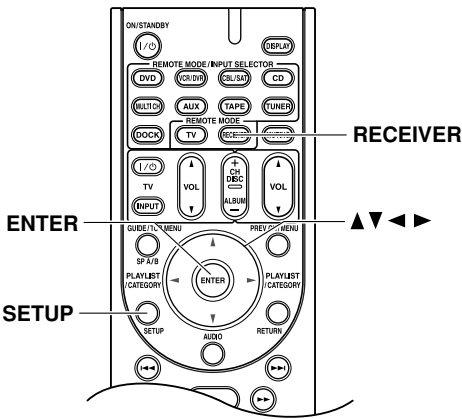

**1** Press the [RECEIVER] button, followed by the [SETUP] button.

**2** Use the Up and Down [▲]/[▼] buttons to select "1.HDMI Input," and then press [ENTER].

**3** Use the Up and Down [▲]/[▼] buttons to select an input selector, and use the Left and Right [◀]/[▶] buttons to select:

- IN1:** Select if the video component is connected to HDMI IN 1.
- IN2:** Select if the video component is connected to HDMI IN 2.
- IN3:** Select if the video component is connected to HDMI IN 3.
- No:** Select if you're not using the HDMI OUT.

**4** Press the [SETUP] button. Setup closes.





**Note:**

- This procedure can also be performed on the AV receiver by using its [SETUP], [ENTER], and arrow buttons.

### Component Video Input Setup

If you connect a video component to a COMPONENT VIDEO IN, you must assign that input to an input selector. For example, if you connect your DVD player to COMPONENT VIDEO IN 2, you must assign COMPONENT VIDEO IN 2 to the DVD input selector.

By default, the DVD input selector is assigned to COMPONENT VIDEO IN 1, and all of the other input selectors (i.e., VCR/DVR, CBL/SAT, AUX) are assigned to the “- -” option.

<p><b>1</b></p> 	<p><b>Press the [RECEIVER] button, followed by the [SETUP] button.</b></p>
<p><b>2</b></p> 	<p><b>Use the Up and Down [▲]/[▼] buttons to select “2.Component,” and then press [ENTER].</b></p>
<p><b>3</b></p> 	<p><b>Use the Up and Down [▲]/[▼] buttons to select an input selector, and use the Left and Right [◀]/[▶] buttons to select:</b></p> <ul style="list-style-type: none"><li><b>IN1:</b> Select if the video component is connected to COMPONENT VIDEO IN 1.</li><li><b>IN2:</b> Select if the video component is connected to COMPONENT VIDEO IN 2.</li><li><b>No:</b> Select if you're not using the COMPONENT VIDEO OUT.</li></ul>
<p><b>4</b></p> 	<p><b>Press the [SETUP] button.</b> Setup closes.</p>

**Note:**

- This procedure can also be performed on the AV receiver by using its [SETUP], [ENTER], and arrow buttons.

### Digital Input Setup

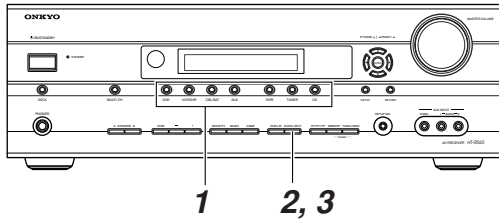

If you connect a component to a digital audio input, you must assign that input to an input selector. For example, if you connect your CD player to OPTICAL IN 1, you must assign OPTICAL IN 1 to the CD input selector.

These are the default assignments.

Input selector	Audio input
DVD	COAX1
VCR/DVR	OPT1
CBL/SAT	COAX2
AUX	---
TAPE	---
CD	OPT2

**1**

**Press the input selector button for the input selector that you want to assign.**

The TUNER and DOCK input selectors cannot be assigned and are fixed at the “---” option.

**2**

**Press the [DIGITAL INPUT] button.**

The current assignment is displayed.

DVD #COAX1

**3**

**Press the [DIGITAL INPUT] button repeatedly to select an option.**

**COAX1:** Select if the component is connected to DIGITAL IN COAXIAL 1.

**COAX2:** Select if the component is connected to DIGITAL IN COAXIAL 2.

**OPT1:** Select if the component is connected to DIGITAL IN OPTICAL 1.

- OPT2:** Select if the component is connected to DIGITAL IN OPTICAL 2.
- : Select if the component is connected to an analog input.

**Note:**

- This procedure can also be performed on the AV receiver by using its [SETUP], [ENTER], and arrow buttons.

### Changing the Input Display

If you connect an **RI**-capable Onkyo MiniDisc recorder or CD recorder to the TAPE IN/OUT jacks, or to the CBL/SAT jacks, for **RI** to work properly, you must change this setting.

This setting can only be changed on the AV receiver.

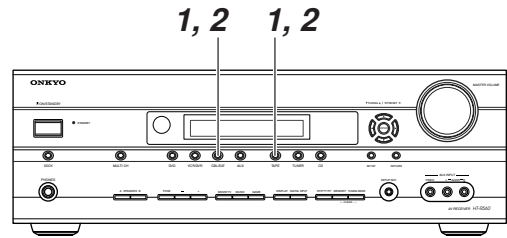

**1**

**Press the [TAPE] or [CBL/SAT] input selector button so that “TAPE” or “CBL/SAT” appears on the display.**

TAPE or CBL/SAT

**2**

**Press and hold down the [TAPE] or [CBL/SAT] input selector button (about 3 seconds) to change the setting.**

Repeat this step to select MD or CDR. For the TAPE input selector, the setting changes in this order:

TAPE → MD → CDR

# Playing Your AV Components

## Basic AV Receiver Operation

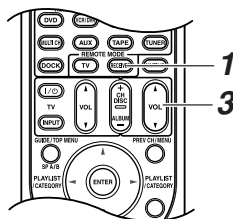
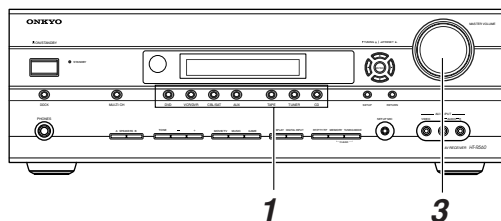

Subwoofer's rear panel

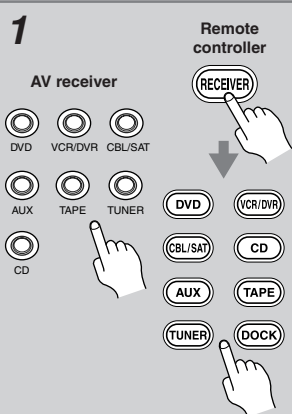
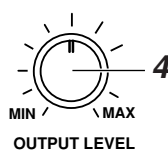

**1 Use the AV receiver's input selector buttons to select an input source.**

**To select an input source with the remote controller, press its INPUT SELECTOR buttons.**

To listen to a DVD player connected to the multichannel DVD input (page 31), press the AV receiver's [MULTI CH] button. The MULTI CH indicator will appear on the display.

**Note:**

- While the multichannel DVD input is selected, the Speaker Configuration settings on page 77 are ignored, and signals from the multichannel input are fed to the speakers as they are.

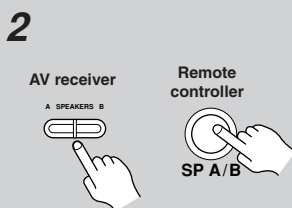

**2 Use the SPEAKERS [A] and [B] buttons on the AV receiver or the [SP A/B] button on the remote controller to select the speaker set that you want to use.**

Pressing the remote controller's [SP A/B] button cycles through the following settings: Speaker Set A → Speaker Set A&B → Speaker Set B → Off.

The A and B speaker indicators show whether each speaker set is on or off.

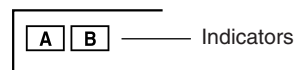

Note that when speaker set B is turned on, speaker set A is reduced to 5.1-channel playback.

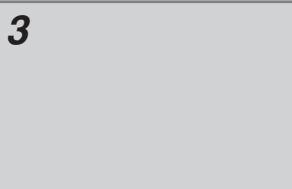

**3 Start playback on the source component.**

To watch a DVD or other video source, on your TV, select the video input that's connected to the AV receiver's COMPONENT VIDEO OUT, HDMI OUT, or MONITOR OUT.

On some DVD players, you may need to change the digital or HDMI audio output settings.

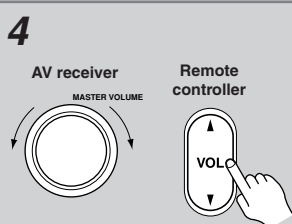

**4 To adjust the volume, use the MASTER VOLUME control or the remote controller's [VOL] button.**

Since the AV receiver is designed for home theaters, it has a wide volume range for precise adjustment. The volume can be set to Min, 1 through 79, or Max.

**Note:** When the subwoofer volume level is set to a positive (+) value, the maximum master volume level is reduced proportionally.

**To set the level of the subwoofer, use the OUTPUT LEVEL control.**

Because our ears are less sensitive to very low bass sounds, there's a temptation to set the level of the subwoofer too high. As a rule of thumb, set the subwoofer level to what you think is the optimal level, and then back it off slightly.

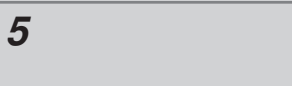

**5 Select a listening mode and enjoy!**

See "Using the Listening Modes" on page 67.

# Common Functions

This section explains functions that can be used with any input source.

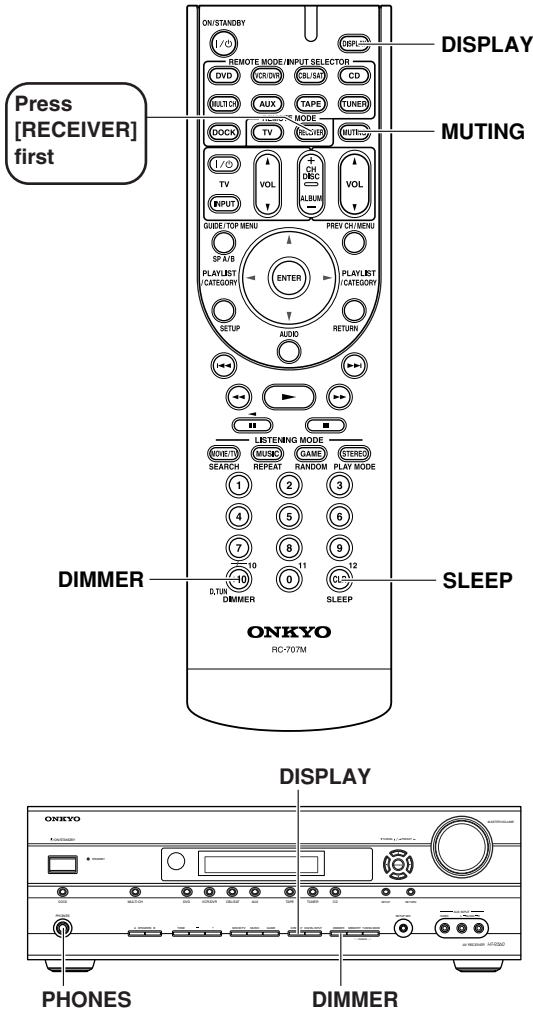

## Setting the Display Brightness

You can adjust the brightness of the display.

**Press the [RECEIVER] REMOTE MODE button, and then press the remote controller's [DIMMER] button repeatedly to select: dim, dimmer, or normal brightness.**

You can also use the AV receiver's [DIMMER] button (not European models).

## Muting the AV Receiver

You can temporarily mute the output of the AV receiver.

**Press the [RECEIVER] REMOTE MODE button, and then press the remote controller's [MUTING] button.**

The output is muted and the MUTING indicator flashes on the display.

**To unmute the AV receiver,** press the remote controller's [MUTING] button again, or adjust the volume. The output is unmuted and the MUTING indicator goes off. Muting is cancelled when the AV receiver is set to Standby.

## Using the Sleep Timer

With the sleep timer, you can set the AV receiver so that it turns off automatically after a specified period.

**Press the [RECEIVER] REMOTE MODE button, and then press the remote controller's [SLEEP] button repeatedly to select the required sleep time.**

You can set the sleep time from 90 to 10 minutes in 10 minute steps.

The SLEEP indicator appears on the display when the sleep timer has been set, as shown. The specified sleep time appears on the display for about 5 seconds, then the previous display reappears.

SLEEP indicator

**To cancel the sleep timer,** press the [SLEEP] button repeatedly until the SLEEP indicator disappears.

**To check the remaining sleep time,** press the [SLEEP] button. Note that if you press the [SLEEP] button while the sleep time is being displayed, you'll shorten the sleep time by 10 minutes.



### Using Headphones

For private listening, you can connect a pair of stereo headphones (1/4-inch phone plug) to the AV receiver's PHONES jack.

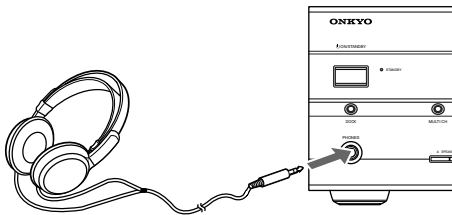

#### Notes:

- Always turn down the volume before connecting your headphones.
- While the headphones plug is inserted in the PHONES jack, the speakers are turned off.
- When you connect a pair of headphones, the listening mode is set to Stereo, unless it was already set to Pure Audio, Mono, Stereo, or Direct, in which case it stays the same.
- When the multichannel DVD input is selected, only the front left and front right channels can be heard in the headphones.

### Displaying Source Information

You can display various information about the current input source as follows.

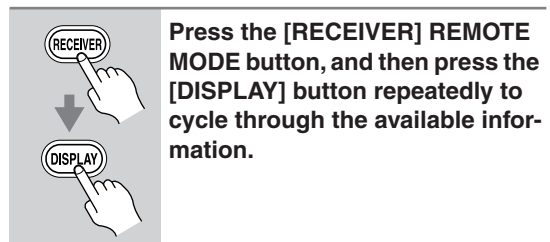

#### Note:

- This procedure can also be performed on the AV receiver by using its [DISPLAY] button.

The following information can typically be displayed:

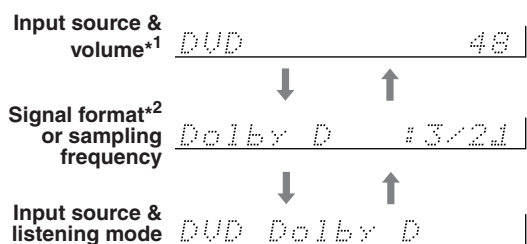

- \*1 When AM or FM radio is used, the band, preset number, and frequency are displayed.
- \*2 If the input signal is analog, or AM or FM radio is selected, no format information is displayed. If the input signal is PCM, the sampling frequency is displayed. If the input signal is digital but not PCM, the signal format is displayed. Information is displayed for about 3 seconds, then the previous display reappears.



### Interpreting Surround Channel Information

3/21  
A B C

- A: The number of front channels (front left, front right, and center).
- B: The number of surround channels (surround left and surround right). If there's surround back channel information, this number will be 3.
- C: LFE channel for subwoofer (1 means yes).

### Specifying the Digital Signal Format

The following table shows the display indicator for each digital signal format.

Format	Display
Dolby Digital	 D
DTS	
PCM	PCM

Normally, the AV receiver detects the format of digital input signals automatically. However, if you experience either of the following issues when playing PCM or DTS sources, you can specify the signal format manually.

- If the beginnings of tracks from a PCM source are cut off, try the PCM setting.
- If noise is produced when fast forwarding or rewinding a DTS CD, try the DTS setting.

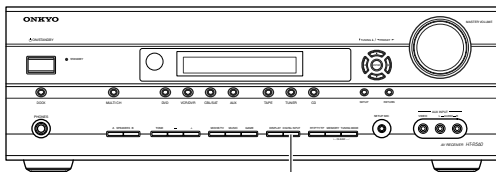

DIGITAL INPUT

1

DIGITAL INPUT



Press and hold the AV receiver's [DIGITAL INPUT] button for about 3 seconds.

2

DIGITAL INPUT

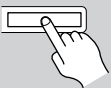

While "Auto" is displayed (about 3 seconds), press the [DIGITAL INPUT] button repeatedly to select: PCM, DTS, or Auto.

**PCM:** Only 2-channel PCM format input signals will be heard. If the input signal is not PCM, the PCM indicator will flash and there will be no sound.

**DTS:** Only DTS (but not DTS-HD) format input signals will be heard. If the input signal is not DTS, the DTS indicator will flash and there will be no sound.

**Auto (default):** The format is detected automatically. If no digital input signal is present, the corresponding analog input is used instead.

# Listening to the Radio

## AM Frequency Step Setup (on some models)

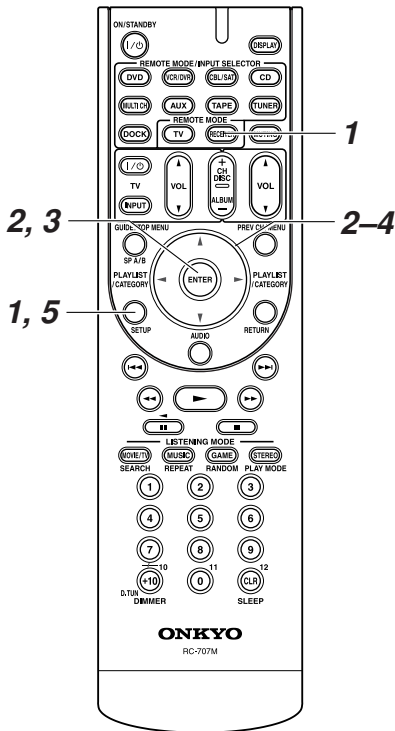

For AM tuning to work properly, you must specify the AM frequency step used in your area. Note that when this setting is changed, all radio presets are deleted.

<p><b>3</b></p>	<p>Use the Up and Down [<b>▲</b>]/[<b>▼</b>] buttons to select “AM Freq.”</p>
<p><b>4</b></p>	<p>Use the Left and Right [<b>◀</b>]/[<b>▶</b>] buttons to select:</p> <p><b>10kHz:</b> Select if 10kHz steps are used in your area.</p> <p><b>9kHz:</b> Select if 9kHz steps are used in your area.</p>
<p><b>5</b></p>	<p>Press the [<b>SETUP</b>] button. Setup closes.</p>

**Note:**

- This procedure can also be performed on the AV receiver by using its [SETUP], [ENTER], and arrow buttons.

<p><b>1</b></p>	<p>Press the [<b>RECEIVER</b>] button, followed by the [<b>SETUP</b>] button.</p>
<p><b>2</b></p>	<p>Use the Up and Down [<b>▲</b>]/[<b>▼</b>] buttons to select “0.Hardware-Setup,” and then press [<b>ENTER</b>].</p>

**Listening to AM/FM Stations**

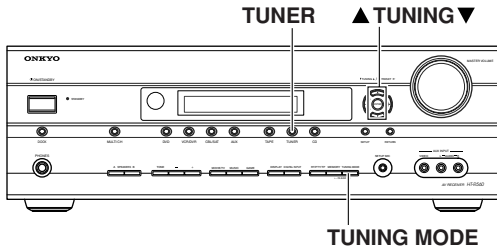

With the built-in tuner, you can enjoy AM and FM radio stations and store your favorite stations as presets for easy selection.



**Use the [TUNER] input selector button to select AM or FM.**

In this example, FM has been selected.

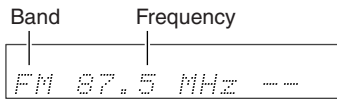

(Actual display depends on country.)

**Tuning into AM/FM Radio Stations**

**Auto Tuning Mode**

1

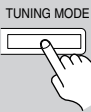

**Press the [TUNING MODE] button so that the AUTO indicator appears on the display.**

2

TUNING ▲

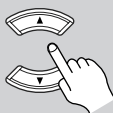

**Press the TUNING Up or Down [▲]/[▼] button.**

Searching stops when a station is found.

When tuned into a station, the TUNED indicator appears. When tuned into a stereo FM station, the FM STEREO indicator also appears.

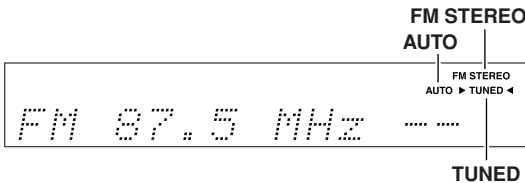

**Manual Tuning Mode**

1

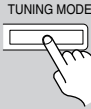

**Press the [TUNING MODE] button so that the AUTO indicator disappears from the display.**

2

TUNING ▲

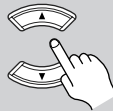

**Press and hold the TUNING Up or Down [▲]/[▼] button.**

The frequency stops changing when you release the button.

Press the button repeatedly to change the frequency one step at a time.

Frequency changes in 0.05MHz steps for FM and 9kHz (or 10kHz) steps for AM.

In Manual Tuning mode, FM stations will be in mono.

**Tuning into Weak FM Stereo Stations**

If the signal from a stereo FM station is weak, it may be impossible to get good reception. In this case, switch to Manual Tuning mode and listen to the station in mono.

**Note:**

- You can also use the remote controller's Up and Down [▲]/[▼] buttons to tune the radio.

# Listening to the Radio—Continued

## ■ Tuning into Stations by Frequency

You can tune into AM and FM stations directly by entering the appropriate frequency.

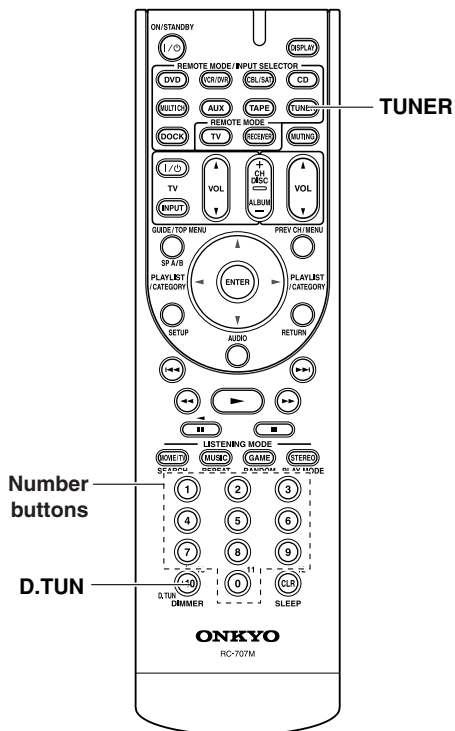

## Displaying AM/FM Radio Information

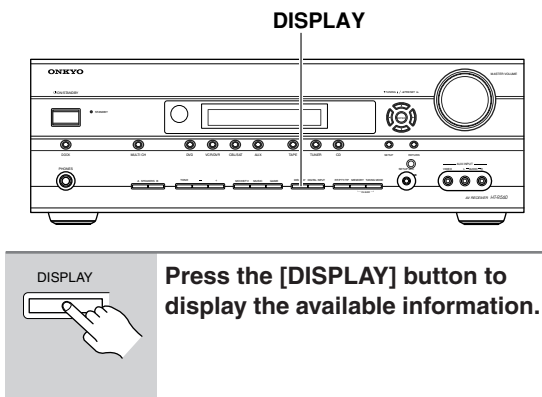

Press the [DISPLAY] button to display the available information.

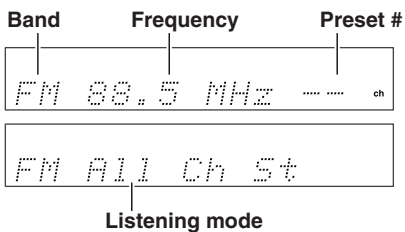

**1**

Press the [TUNER] button repeatedly to select AM or FM, followed by the [D.TUN] button.

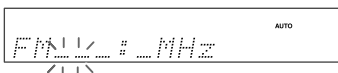
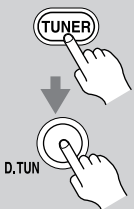

(Actual display depends on country.)

**2**

Within 8 seconds, use the number buttons to enter the frequency of the radio station.

For example, to tune to 87.5 (FM), press 8, 7, 5.

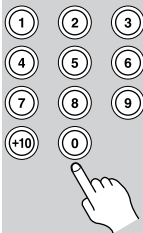

**Presetting AM/FM Stations**

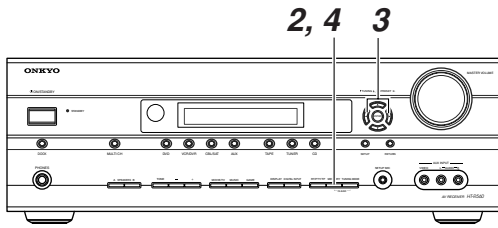

You can store a combination of up to 40 of your favorite AM and FM radio stations.

- |          |                                                                                                                                                                                         |
|----------|-----------------------------------------------------------------------------------------------------------------------------------------------------------------------------------------|
| <b>1</b> | <b>Tune into the AM or FM station you want to store as a preset.</b>                                                                                                                    |
| <b>2</b> | <b>Press the [MEMORY] button.</b><br>The preset number flashes.                                                                                                                         |
| <b>3</b> | <b>While the preset number is flashing (about 8 seconds), use the PRESET [◀/▶] buttons to select a preset from 1 through 40.</b>                                                        |
| <b>4</b> | <b>Press the [MEMORY] button again to store the station.</b><br>The station is stored and the preset number stops flashing.<br>Repeat this procedure for all of your favorite stations. |

**Selecting Presets**

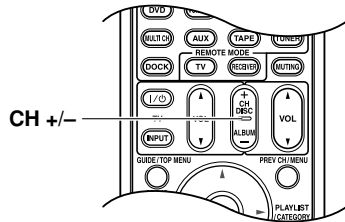
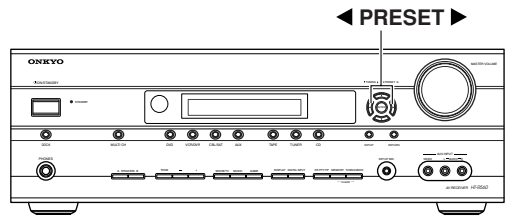

- |  |                                                                                                     |
|--|-----------------------------------------------------------------------------------------------------|
|  | <b>To select a preset, use the PRESET [◀/▶] buttons or the remote controller's CH [+/-] button.</b> |
|  |                                                                                                     |
|  | <b>You can also use the remote controller's number buttons to select a preset directly.</b>         |

**Deleting Presets**

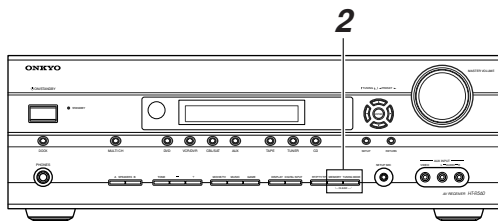

- |          |                                                                                                                                                     |
|----------|-----------------------------------------------------------------------------------------------------------------------------------------------------|
| <b>1</b> | <b>Select the preset that you want to delete.</b><br>See the next section.                                                                          |
| <b>2</b> | <b>While holding down the [MEMORY] button, press the [TUNING MODE] button.</b><br>The preset is deleted and its number disappears from the display. |

# Listening to SIRIUS Satellite Radio

## Listening to SIRIUS Satellite Radio® (Only North American Model)

**Important SIRIUS Satellite Radio Information**  
SIRIUS is available in the US for subscribers with addresses in the continental US and is available in Canada for subscribers with a Canadian address. To get SIRIUS Satellite Radio a subscription and compatible tuner and antenna are required and sold separately. Visit [sirius.com](http://sirius.com) for the most complete and up-to-date channel lineup and information.

### Note:

Hardware and required basic monthly subscription are sold separately. Installation costs and other fees and taxes, including a one-time activation fee may apply. Subscription fee is consumer only. All fees and programming are subject to change.

### What is SIRIUS Satellite Radio?

Simply The Best Radio on Radio™ with all your favorite entertainment including 100% commercial-free music, plus superior sports coverage, uncensored talk and comedy, world-class entertainment, news, weather and more for your car, home or office. For more information visit [sirius.com](http://sirius.com) or [siriuscanada.ca](http://siriuscanada.ca)

### A warning against reverse engineering:

It is prohibited to copy, decompile, disassemble, reverse engineer, or manipulate any technology incorporated in receivers compatible with the SIRIUS Satellite Radio system.

“SIRIUS” and the SIRIUS dog logo are registered trademarks of SIRIUS Satellite Radio Inc.



## Setting Up the SiriusConnect™ Home Tuner

The optional SiriusConnect Home tuner kit includes everything for easy home installation, including the SiriusConnect receiver, indoor/outdoor antenna with 21-foot cable, 8-pin mini DIN connector cable, and an AC power adapter. See the SiriusConnect Home tuner's instructions for more information.

Use the 8-pin mini DIN connector cable to connect the SiriusConnect receiver to the SIRIUS antenna jack on the rear of the AV receiver.

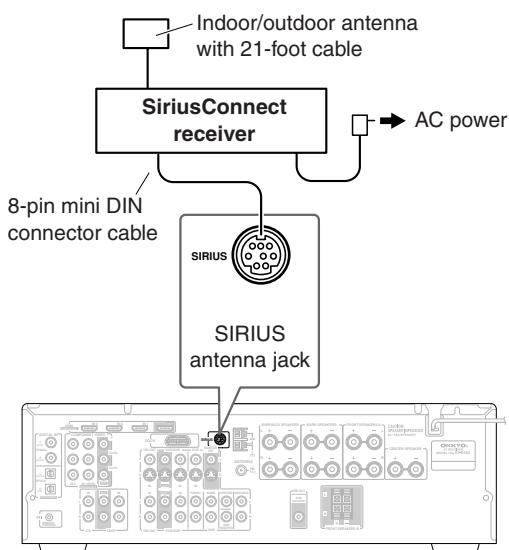

To use the included antenna indoors, you must place it at a north-, west-, or east-facing window, depending on where you live. If this isn't possible, you'll need to install it outside, away from any overhead obstructions.

## Positioning the Antenna

For a consistent satellite signal, the antenna must be positioned correctly. Use the following map to determine which area you are in and position the antenna accordingly.

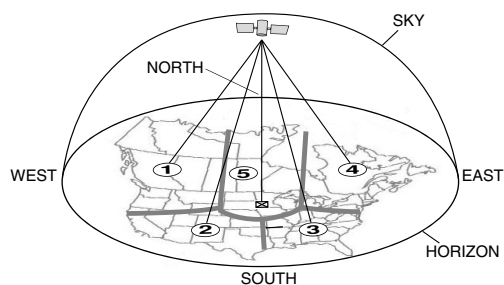

**Area 1:** Point the antenna toward the sky in the **east, northeast, or southeast**, either through a window or outside.

**Area 2:** Point the antenna toward the sky in the **north or northeast**, either through a window or outside.

**Area 3:** Point the antenna toward the sky in the **north or northwest**, either through a window or outside.

**Area 4:** Point the antenna toward the sky in the **west, northwest, or southwest**, either through a window or outside.

**Area 5:** Put the antenna outside and point it **straight up**. The antenna cannot be used indoors.

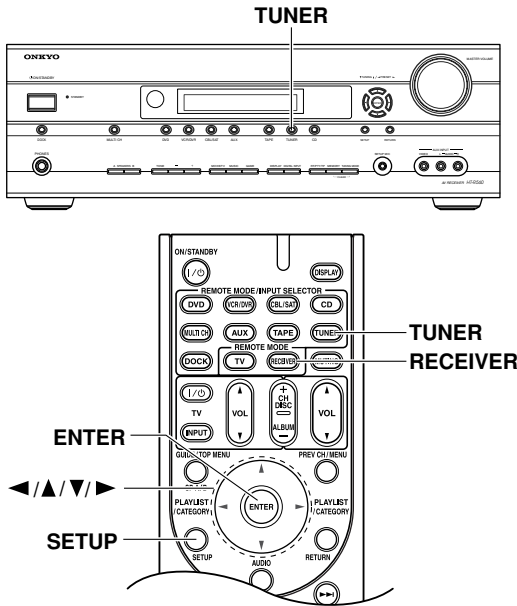

### Selecting SIRIUS Satellite Radio

1



TUNER  
Remote controller

On the AV receiver, press the [TUNER] INPUT SELECTOR button repeatedly to select SIRIUS.



On the remote controller, press the [RECEIVER] REMOTE MODE button, and then press the [TUNER] INPUT SELECTOR button repeatedly to select SIRIUS.

If “CHECK SR TUNER” appears on the display, make sure the SiriusConnect receiver is connected properly. If “ANTENNA ERROR” appears, make sure the antenna is connected properly.

### Setting the Satellite Radio Mode

1

Remote controller



Press the [RECEIVER] button, followed by the [SETUP] button.

2

Remote controller



Use the Up and Down [▲]/[▼] buttons to select “8. SAT Radio-Mode,” and then press [ENTER].

3

Remote controller



Use the Left and Right [◀]/[▶] buttons to select “SIRIUS.”  
If you’ve not using satellite radio, select None.

4

Remote controller



Press the [SETUP] button.

### Signing Up for SIRIUS Satellite Radio

Before you can use SIRIUS Satellite Radio, you must first sign up for an account. You’ll need a major credit card and your *SIRIUS Satellite Radio ID*, which you can get from the AV receiver, as explained below, or from the SiriusConnect Home tuner package.

1

Remote controller



Press the [RECEIVER] button, followed by the [SETUP] button.

2

Remote controller

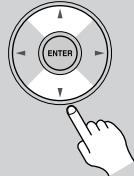

Use the Up and Down [▲]/[▼] buttons to select “11. Sirius ID.”  
Your SIRIUS Satellite Radio ID number is displayed. Write it below.

ID:

3

To sign up, go to:  
<http://activate.siriusradio.com>  
Or call: 1-888-539-SIRIUS (7474)



## Listening to SIRIUS Satellite Radio—Continued

### Note:

- After you've activated your subscription with SIRIUS Satellite Radio, your SIRIUS Satellite Radio ID number will no longer be displayed when you select channel 0. To check your ID, you'll need to; press the [SETUP] button, select "11. SiriusID" with the Up and Down [▲]/[▼] buttons, and then press [ENTER]. Press the [SETUP] button when you've finished.

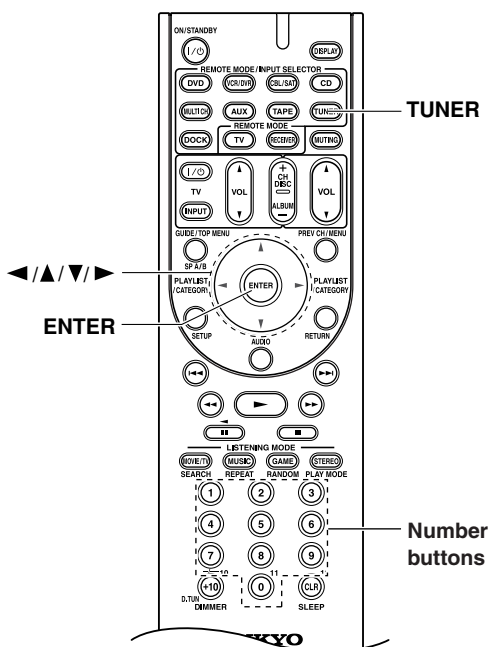
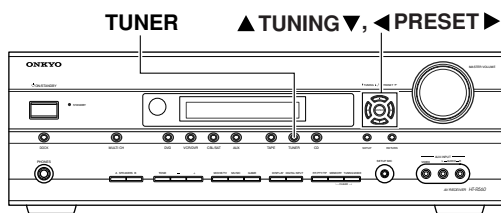

### Selecting SIRIUS Satellite Radio Channels

There are three ways to select SIRIUS Satellite Radio channels:

- Channel Search mode:** select any channel.
- Category Search mode:** select channels by category.
- Direct tuning:** enter channel number.

### Channel Search Mode

1



TUNER  
Remote controller



Press the [TUNER] button to select Channel Search mode.

Channel Search

2

TUNING ▲

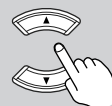

Remote controller

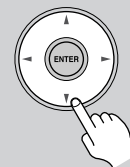

Use the TUNING [▲]/[▼] buttons, or remote controller's Up and Down [▲]/[▼] buttons to select a channel.

050 Hot Janz

Channel number Channel name

You can also use the remote controller's Left and Right Arrow [◀]/[▶] buttons to select a category.

### Category Search Mode

1



TUNER  
Remote controller



Press the [TUNER] button to select Category Search mode.

Category Search

2

TUNING ▲ / ◀ PRESET ▶



Remote controller

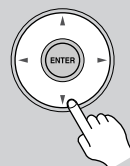

Use the TUNING [▲]/[▼] buttons, or remote controller's Left and Right [◀]/[▶] buttons to select a category, and use the PRESET [◀]/[▶] buttons, or remote controller's Up and Down [▲]/[▼] buttons to select a channel in that category.

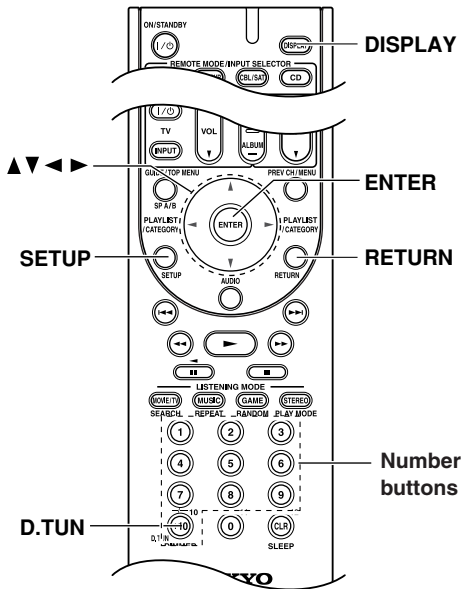
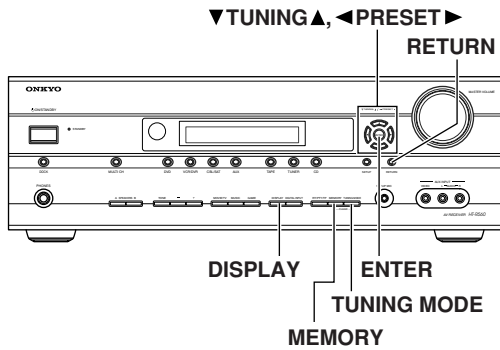

**Notes:**

- If you select an unavailable channel, “INVALID CHANNEL” appears on the display.
- If you select a channel that you are not subscribed to, “CALL SIRIUS” appears on the display.
- Channels that are locked must be unlocked before you can listen to them. See “Parental Lock” on page 61 for more information.

**Selecting Channels on the AV receiver:**

<b>1</b>		<p>Press the [TUNING MODE] button repeatedly to select Channel Search mode or Category Search mode.</p>
<b>2</b>		<p>Press [ENTER] repeatedly to select a category.</p>
<b>3</b>		<p>Use the TUNING Up and Down [▲]/[▼] buttons to select a channel.</p> <p>In Channel Search mode, you can select any channel.</p> <p>In Category Search mode, you can only select channels from the currently selected category.</p>

**Selecting the Previous Channel:**

<p>AV receiver</p>	<p>To listen to the previously selected SIRIUS Satellite Radio channel, press the [RETURN] button.</p>
<p>Remote controller</p>	



**Direct Tuning**

You can select a SIRIUS Satellite Radio channel directly by entering its number with the remote controller.

<b>1</b>	<p>Remote controller</p>	<p>Press the [D.TUN] button.</p> <div style="border: 1px solid black; padding: 5px; width: fit-content; margin: 10px auto;">SR</div>
<b>2</b>	<p>Remote controller</p>	<p>Within 8 seconds, use the number buttons to enter the channel number.</p> <p>For example, to select channel #20, press [0], [2], and [0], or press [2], [0], and [ENTER].</p>

## Presetting SIRIUS Channels

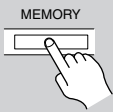
You can store a combination of up to 40 of your favorite SIRIUS Satellite Radio channels and AM/FM radio stations as presets.

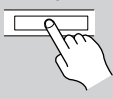
- 1** Tune into the SIRIUS channel that you want to store as a preset.
- 2** Press the [MEMORY] button. The preset number flashes.
 
- 3** While the preset number is flashing (about 8 seconds), use the PRESET [◀]/[▶] buttons to select a preset from 1 through 40.
 
- 4** Press the [MEMORY] button again to store the channel. The channel is stored and the preset number stops flashing. Repeat this procedure for all of your favorite SIRIUS Satellite Radio channels.
 

## ■ Selecting Presets



AV receiver  
← PRESET →



Remote controller

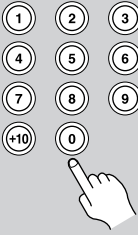

To select a preset, use the PRESET [◀]/[▶] buttons, or the remote controller's CH [+/-] button.

You can also use the remote controller's number buttons to select a preset directly.

## ■ Deleting Presets

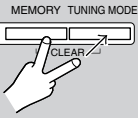
- 1** Select the preset that you want to delete. See the previous section.
- 2** While holding down the [MEMORY] button, press the [TUNING MODE] button. The preset is deleted and its number disappears from the display.
 

## Displaying SIRIUS Satellite Radio Information

Press the [DISPLAY] button repeatedly to cycle through the available information.

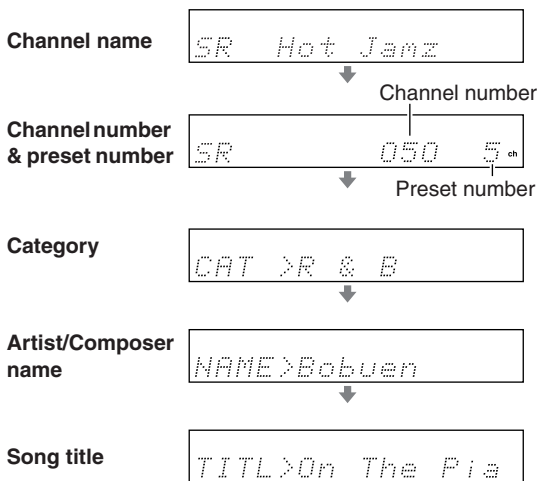

### Note:

If the category, artist, or song title is not available, “- - -” will be displayed instead.

## ■ SIRIUS Satellite Radio Messages

The following messages may appear while using SIRIUS Satellite Radio.

### ACQUIRING

The SiriusConnect receiver is acquiring the signal or no signal is present. Make sure the SiriusConnect Home tuner is connected properly and that there are no obstacles close by.

### ANTENNA ERROR

Make sure the SiriusConnect Home tuner is connected properly.

## Listening to SIRIUS Satellite Radio—Continued

### SUB UPDATED

Displayed while your subscription is being updated. No operations can be performed until this message has cleared.

### UPDATING XXX%

Displayed while the channel map is being updated. Wait until the updating is complete.

### SIRIUS UPDATING

Displayed while the SiriusConnect receiver's firmware is being updated.

### INVALID CHANNEL

Displayed if you select an unavailable channel.

### CALL SIRIUS

Displayed when you select a channel to which you are not subscribed. Call SIRIUS if you want to subscribe.

### CHECK SR TUNER

Displayed if the SiriusConnect receiver is not connected. Make sure the SiriusConnect receiver is connected properly, and make sure its AC adapter is plugged in.

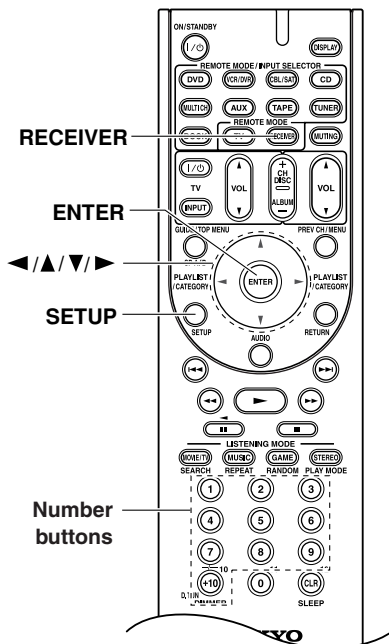

## Positioning the SiriusConnect Home Tuner

You can check the signal strength of the SIRIUS Satellite Radio signal and adjust the position of the SiriusConnect Home antenna accordingly.

**1**

Remote controller



Press the [RECEIVER] button, followed by the [SETUP] button.

**2**

Remote controller



Use the Up and Down [▲]/[▼] buttons to select “8.ANT Aiming,” and then press [ENTER].

8.ANT Aiming

**Note:**

- If the 8. SAT RadioMode is set to None (see page 56), the “ANT Aiming” item is not available.

**3**

Adjust the position of the indoor/outdoor antenna connected to the SiriusConnect receiver so that the satellite (SAT) signal strength bar is as long as possible.

SAT: [ ]

If you cannot receive a satellite signal, press the Down [▼] button to display the terrestrial (TER) signal strength meter and adjust your antenna so that the bar is as long as possible.

Terrestrial signals are only available in certain areas.

TER: [ ]

So long as the signal strength is good, you can enjoy SIRIUS Satellite Radio by using either satellite or terrestrial reception.

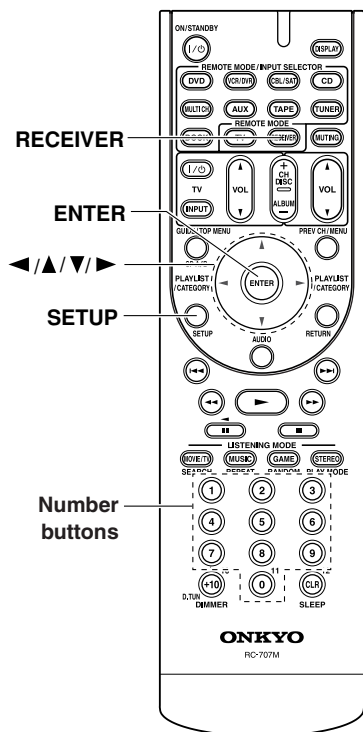

## Parental Lock

You can lock out channels that you do not want to receive.

**1** Press the [RECEIVER] button, followed by the [SETUP] button.

Remote controller

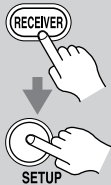

**2** Use the Up and Down [▲]/[▼] buttons to select "10. Parental Lock," and then press [ENTER]. "Lock : <0>" appears on the display.

Remote controller



"Lock : <0>" appears on the display.

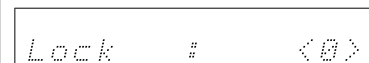

### Note:

- If the SAT Radio Mode is set to None (see page 56), the "ParentalLock" item is not available.

**3** Use the Left and Right [◀]/[▶] buttons to change the number displayed between the angle brackets < >, and then press [ENTER]. Repeat this for each digit in the PIN number.\*



**4** Remote controller Use the Up and Down [▲]/[▼] buttons to select the channel that you want to lock out, for example:

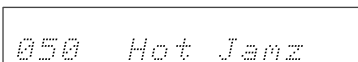

**5** Remote controller Press the Left and Right [◀]/[▶] buttons so that an asterisk appears next to the name, as shown below, and then press [ENTER]:

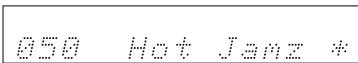

The message "Locked" will appear on the display.

**6** Remote controller Press the [SETUP] button. Setup closes.



\* The default number is "0000." If you want to change the default setting, see "Changing the PIN Number" on page 62.

**To unlock a previously locked channel,** select the locked channel (see step 1–4), press the Left and Right [◀]/[▶] buttons so that the asterisk disappears (see step 5), and then press [ENTER]. The message "Unlocked" will appear on the display.

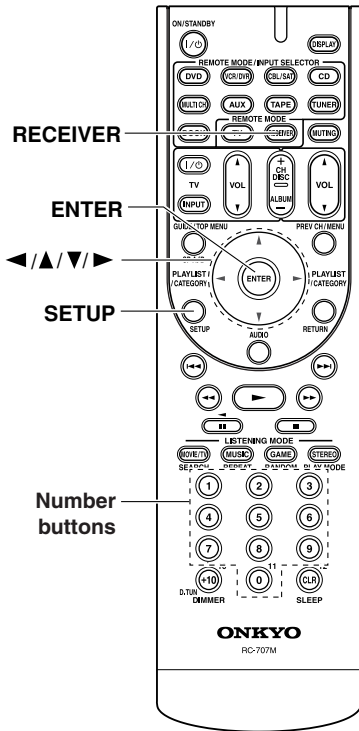

### Changing the PIN Number

<p><b>1</b> Remote controller</p>	<p>Press the [RECEIVER] button, followed by the [SETUP] button.</p>
<p><b>2</b> Remote controller</p>	<p>Use the Up and Down [▲]/[▼] buttons to select “10. Parental Lock,” and then press [ENTER].</p> <p><b>Note:</b></p> <ul style="list-style-type: none"> <li>If the 8. SAT RadioMode is set to None (see page 56), the “Parental-Lock” item is not available.</li> </ul>

<p><b>3</b> Remote controller</p>	<p>Use the Up and Down [▲]/[▼] buttons to select “Edit Code,” and then press [ENTER].</p> <p>“Enter : &lt;0&gt;” appears on the display.</p> <div style="border: 1px solid black; padding: 5px; text-align: center;">             Enter # &lt;0&gt;         </div>
<p><b>4</b> Remote controller</p>	<p>Use the number buttons to enter the old PIN number.</p> <p>If you enter the wrong PIN number, “Wrong Code!” appears on the display. You’ll be returned to step 2, “8. Parental Lock,” and will need to start again. “New : &lt;0&gt;” appears on the display.</p> <div style="border: 1px solid black; padding: 5px; text-align: center;">             New # &lt;0&gt;         </div>
<p><b>5</b> Remote controller</p>	<p>Use the number buttons to enter the new PIN number.</p> <p>“Confirm: &lt;0&gt;” appears on the display.</p> <div style="border: 1px solid black; padding: 5px; text-align: center;">             Confirm# &lt;0&gt;         </div>
<p><b>6</b></p>	<p>Enter the new PIN number again.</p> <p>If you enter the wrong PIN number, “Wrong Code!” appears on the display. You’ll be returned to step 2, “Parental Lock,” and will need to start again.</p>
<p><b>7</b> Remote controller</p>	<p>Press the [SETUP] button.</p> <p>Setup closes.</p>

### Using RDS (European models only)

RDS only works in areas where RDS broadcasts are available. When tuned to an RDS station, the RDS indicator appears.

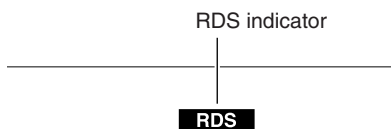

#### ■ What is RDS?

RDS stands for *Radio Data System* and is a method of transmitting data in FM radio signals. It was developed by the European Broadcasting Union (EBU) and is available in most European countries. RDS is approved by the National Radio Systems Committee (NRSC) and is available in North America.

Many FM stations use it these days. In addition to displaying text information, RDS can also help you find radio stations by type (e.g., news, sport, rock, etc.).

The AV receiver supports four types of RDS information:

#### **PS (Program Service)**

When tuned to an RDS station that's broadcasting PS information, the station's name will be displayed. Pressing the [DISPLAY] button will display the frequency for 3 seconds.

#### **RT (Radio Text)**

When tuned to an RDS station that's broadcasting text information, the text will be shown on the display (see page 64).

#### **PTY (Program Type)**

This allows you to search RDS radio stations by type (see page 64).

#### **TP (Traffic Program)**

This allows you to search for RDS radio stations that broadcast traffic information (see page 64).

#### **Notes:**

- In some cases, the characters displayed on the AV receiver may not be identical to those broadcast by the radio station. Also, unexpected characters may be displayed when unsupported characters are received. This is not a malfunction.
- If the signal from an RDS station is weak, RDS data may be displayed intermittently or not at all.

### RDS Program Types (PTY)

Type	Display
None	None
News reports	News
Current affairs	Affairs
Information	Info
Sport	Sport
Education	Educate
Drama	Drama
Culture	Culture
Science and technology	Science
Varied	Varied
Pop music	Pop M
Rock music	Rock M
Middle of the road music	Easy M
Light classics	Light M
Serious classics	Classics
Other music	Other M
Weather	Weather
Finance	Finance
Children's programmes	Children
Social affairs	Social
Religion	Religion
Phone in	Phone In
Travel	Travel
Leisure	Leisure
Jazz music	Jazz
Country music	Country
National music	Nation M
Oldies music	Oldies
Folk music	Folk M
Documentary	Document
Alarm test	TEST
Alarm	Alarm!

## Displaying Radio Text (RT)

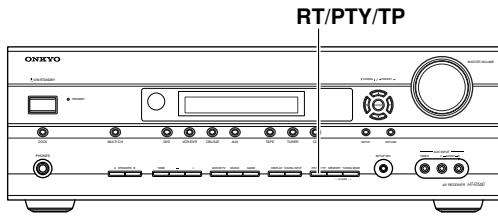

When tuned to an RDS station that's broadcasting text information, the text can be displayed.

**RT/PTY/TP**

**Press the [RT/PTY/TP] button once.**  
The RT information scrolls across the display.

### Notes:

- The message “Waiting” may appear while the AV receiver waits for the RT information.
- If the message “No Text Data” appears on the display, no RT information is available.

## Finding Stations by Type (PTY)

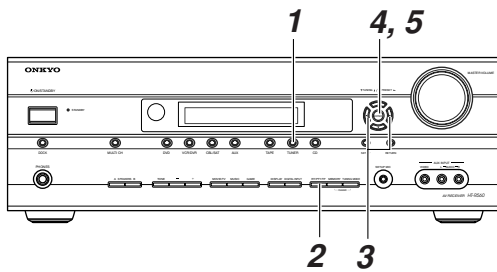

You can search for radio stations by type.

<p><b>1</b></p> <p>TUNER</p>	<p><b>Use the [TUNER] input selector button to select FM.</b></p>
<p><b>2</b></p> <p>RT/PTY/TP</p>	<p><b>Press the [RT/PTY/TP] button twice.</b> The current program type appears on the display.</p>
<p><b>3</b></p> <p>PRESET</p>	<p><b>Use the PRESET [◀]/[▶] buttons to select the type of program you want.</b> See the table on page 63.</p>

<p><b>4</b></p> <p>ENTER</p>	<p><b>To start the search, press [ENTER].</b> The AV receiver searches until it finds a station of the type you specified, at which point it stops briefly before continuing with the search.</p>
<p><b>5</b></p> <p>ENTER</p>	<p><b>When a station you want to listen to is found, press [ENTER].</b> If no stations are found, the message “Not Found” appears.</p>

## Listening to Traffic News (TP)

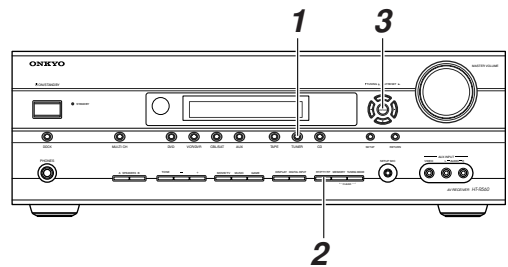

You can search for stations that broadcast traffic news.

<p><b>1</b></p> <p>TUNER</p>	<p><b>Use the [TUNER] input selector button to select FM.</b></p>
<p><b>2</b></p> <p>RT/PTY/TP</p>	<p><b>Press the [RT/PTY/TP] button three times.</b> If the current radio station is broadcasting TP (Traffic Program), “[TP]” will appear on the display and traffic news will be heard as and when it's broadcast. If “TP” without square brackets appears, this means that the station is not broadcasting TP.</p>
<p><b>3</b></p> <p>ENTER</p>	<p><b>To locate a station that is broadcasting TP, press [ENTER].</b> The AV receiver searches until it finds a station that's broadcasting TP. If no stations are found, the message “Not Found” appears.</p>



# DS-A1L Dock for the iPod

## About the DS-A1L Dock

With the supplied DS-A1L Onkyo Dock, you can easily play the music stored on your Apple iPod through the AV receiver and enjoy great sound. You can use the AV receiver's remote controller to operate your iPod.

For the latest information on the Dock, see the Onkyo Web site at: [www.onkyo.com](http://www.onkyo.com)

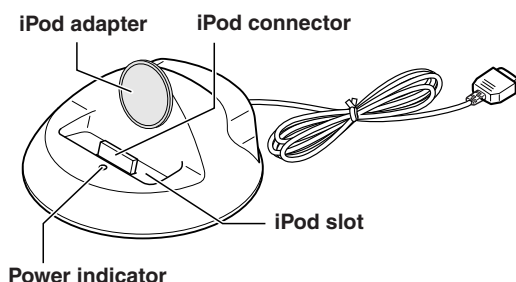

## Compatible iPod models

### ■ Made for:

- 5th Generation iPod (iPod with video)
- iPod photo (iPod with color display)
- 4th Generation iPod
- 2nd Generation iPod nano
- 1st Generation iPod nano
- iPod mini

### Note:

- 3rd generation iPod models are not supported.
- Before using the Dock, update your iPod with the latest software, available from the Apple Web site at: [www.apple.com](http://www.apple.com)

## Putting Your iPod in the Dock

1. Turn on the AV receiver, and select the appropriate inputs on the AV receiver.
2. Align your iPod with the Dock's iPod slot, and carefully place your iPod in the slot, as shown.



## ■ Adjusting the iPod Adapter

The iPod adapter needs to be adjusted to match your particular iPod. If there's a gap between the back of your iPod and the adapter, turn the adapter counterclockwise to close the gap. Turning the adapter counterclockwise moves it forward. Turning it clockwise moves it backward.

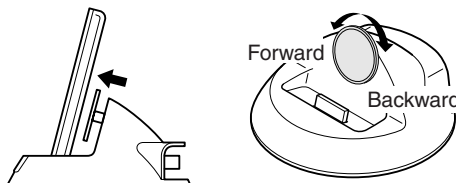

### Notes:

- To prevent iPod connector damage, don't twist your iPod when inserting or removing it, and be careful not to knock over the Dock while your iPod is inserted.
- Don't use the Dock with any other iPod accessories, such as FM transmitters and microphones, as they may cause a malfunction.

## Function Overview

### ■ Basic Operation

#### Note:

- The AV receiver may take several seconds to start-up, so you might not hear the first few seconds of the first song.

- **System On Function:** When you turn on the AV receiver, the iPod turns on as well.
- **System Off Function:** When you turn off the AV receiver, the iPod turns off as well.
- **Auto Power On Function\*:** If you start iPod playback while the AV receiver is on Standby, the AV receiver will automatically turn on and select your iPod as the input source. Then, your iPod will start playback.
- **Direct Change Function\*:** If you start iPod playback while listening to another input source, the AV receiver will automatically select your iPod as the input source.
- **Linked Dimmer Operation:** When you use the AV receiver's Dimmer function to change its display's brightness, the brightness of the Dock's Power indicator will change as well.
- **Using the AV receiver's Remote Controller:** You can use the AV receiver's remote controller to control basic iPod functions.

\* If you use your iPod's controls to start an iPod slideshow or video, this function will not work, so use the remote controller instead.

### Operating Notes:

- Before selecting a different input source, stop iPod playback to prevent the AV receiver from selecting the iPod input source by mistake.
- If any accessories are connected to your iPod, the AV receiver may not be able to select the input source properly.
- While your iPod is in the Dock, its volume control has no effect. If you adjust your iPod's volume control while it's in the Dock, make sure it's not set too high before you reconnect your headphones.

### ■ Using Your iPod's Alarm Clock

You can use your iPod's Alarm Clock function to automatically turn on your iPod and the AV receiver at a specified time. The AV receiver's input source will automatically be set to the input to which your iPod is connected.

#### Notes:

- To use this function, your iPod must be in the Dock, and the Dock must be connected to the AV receiver.
- When you use this function, be sure to set the AV receiver's volume control to a suitable level.
- The AV receiver may take several seconds to start-up, so you might not hear the first few seconds of the first song.

### ■ Charging Your iPod's Battery

The Dock charges your iPod's battery while your iPod is in the Dock and connected to the DOCK jacks on the AV receiver. While your iPod is seated in the Dock, its battery will be charged when the AV receiver is set to On or Standby.

# Using the Listening Modes

## Selecting the Listening Modes

For a description of each listening mode, see “About the Listening Modes” on page 71.

- The Dolby Digital and DTS listening modes can only be selected if your DVD player is connected to the AV receiver with a digital audio connection (coaxial, optical, or HDMI).
- The listening modes you can select depends on the format of the input signal. To check the format, see “Displaying Source Information” on page 49.
- While a pair of headphones is connected, you can only select the Mono, Direct, or Stereo listening mode.
- While speaker B is on, you can select only the Direct or Stereo listening mode.
- The listening modes cannot be selected while speaker set A is off.

## Selecting on the AV Receiver

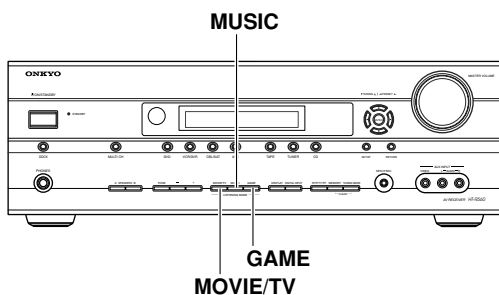

- **[MOVIE/TV] button**  
This button selects the listening modes intended for use with movies and TV.
- **[MUSIC] button**  
This button selects the listening modes intended for use with music.
- **[GAME] button**  
This button selects the listening modes intended for use with video games.

## Selecting with the Remote Controller

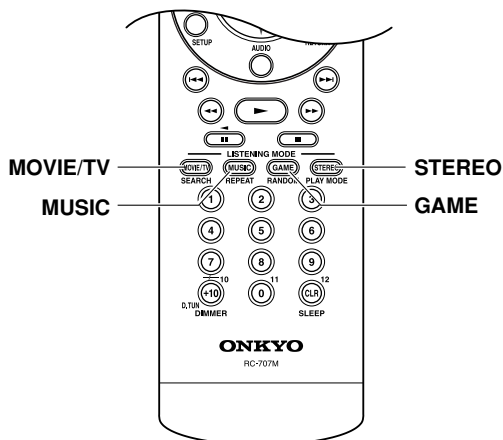

- **[MOVIE/TV] button**  
This button selects the listening modes intended for use with movies and TV.
- **[MUSIC] button**  
This button selects the listening modes intended for use with music.
- **[GAME] button**  
This button selects the listening modes intended for use with video games.
- **[STEREO] button**  
This button selects the Stereo listening mode.

**Listening Modes Available for Each Source Format**

**Analog and PCM Sources**

Button	Source format Media	PCM	Multi channel Analog
		32–96kHz <sup>*1</sup> CD, TV, radio,	DVD
Listening Mode			
[MOVIE/TV]	Mono	✓	
	Dolby PLII Movie/Dolby PLIIx Movie <sup>*2</sup>	✓	
	Neo:6 Cinema	✓	
	MonoMovie <sup>*3 *4</sup>	✓	
	TV Logic <sup>*3 *4</sup>	✓	
	AllChStereo	✓	
	FullMono	✓	
	T-D <sup>*4</sup>	✓	
[MUSIC]	Direct	✓	✓
	Stereo	✓	
	Dolby PLII Music/Dolby PLIIx Music <sup>*2</sup>	✓	
	Neo:6 Music	✓	
	Orchestra <sup>*3 *4</sup>	✓	
	UnPlugged <sup>*3 *4</sup>	✓	
	Studio-Mix <sup>*3 *4</sup>	✓	
	AllChStereo	✓	
FullMono	✓		
[GAME]	Dolby PLII Game/Dolby PLIIx Game <sup>*2</sup>	✓	
	AllChStereo	✓	
	FullMono	✓	
	T-D <sup>*4</sup>	✓	
[STEREO]	Stereo	✓	

\*1. 32/44.1/48/88.2/96kHz

\*2. If there are no surround back speakers, or speaker set B is on, Dolby Pro Logic II is used.

\*3. Available only when using surround speakers.

\*4. PCM of 64kHz, 88.2kHz, and 96kHz are processed at 32kHz, 44.1kHz, and 48kHz respectively.

## Using the Listening Modes—Continued

### Dolby Digital Sources

Button	Source format Media	Dolby Digital		
		Multichannel	2ch	Mono/Multiplex
Listening Mode		DVD, DTV, etc.		
[MOVIE/ V]	Mono	✓	✓	✓
	DolbyDigital	✓		
	Neo:6	✓		
	Dolby PLII Movie/Dolby PLIIx Movie <sup>*1</sup>	✓	✓	
	DolbyEX	✓		
	Neo:6 Cinema		✓	
	MonoMovie <sup>*2</sup>	✓	✓	✓
	TV Logic <sup>*2</sup>	✓	✓	✓
	AllChStereo	✓	✓	✓
	FullMono	✓	✓	✓
	T-D	✓	✓	✓
[MUSIC]	Direct	✓	✓	✓
	Stereo	✓	✓	✓
	DolbyDigital	✓		
	Neo:6	✓		
	Dolby PLII Music/Dolby PLIIx Music <sup>*1</sup>	✓	✓	
	DolbyEX	✓		
	Neo:6 Music		✓	
	Orchestra <sup>*2</sup>	✓	✓	✓
	UnPlugged <sup>*2</sup>	✓	✓	✓
	Studio-Mix <sup>*2</sup>	✓	✓	✓
	AllChStereo	✓	✓	✓
FullMono	✓	✓	✓	
[GAME]	DolbyDigital	✓		
	Neo:6	✓		
	Dolby PLII Game/Dolby PLIIx Game <sup>*1</sup>		✓	
	DolbyEX	✓		
	AllChStereo	✓	✓	✓
	FullMono	✓	✓	✓
	T-D	✓	✓	✓
[STEREO ]	Stereo	✓	✓	✓

\*1. If there are no surround back speakers, or speaker set B is on, Dolby Pro Logic II is used.

\*2. Available only when using surround speakers.

■ Requires 6.1/7.1 speakers. Not available while speaker set B is on.

■ Requires 7.1 speakers. Not available while speaker set B is on.

## Using the Listening Modes—Continued

### DTS Sources

Button	Source format	DTS, DTS 96/24			DTS
		Multichannel	2ch	Mono/Multiplex	Discrete/Matrix
	Media	DVD, CD, etc.			DVD, CD, etc.
[MOVIE/TV]	Mono	✓	✓	✓	✓
	DTS, DTS 96/24	✓			✓
	DTS-ES Discrete/Matrix				✓ <sup>*1</sup>
	Neo:6	✓			
	Dolby PLII Movie/Dolby PLIIx Movie <sup>*2</sup>	✓	✓		
	DolbyEX	✓			
	Neo:6 Cinema		✓		
	MonoMovie <sup>*3 *4</sup>	✓	✓	✓	✓
	TV Logic <sup>*3 *4</sup>	✓	✓	✓	✓
	AllChStereo	✓	✓	✓	✓
	FullMono	✓	✓	✓	✓
T-D <sup>*4</sup>	✓	✓	✓	✓	
[MUSIC]	Direct	✓	✓	✓	✓
	Stereo	✓	✓	✓	✓
	DTS, DTS 96/24	✓			✓
	DTS-ES Discrete/Matrix				✓ <sup>*1</sup>
	Neo:6	✓			
	Dolby PLII Music/Dolby PLIIx Music <sup>*2</sup>	✓	✓		
	DolbyEX	✓			
	Neo:6 Music		✓		
	Orchestra <sup>*3 *4</sup>	✓	✓	✓	✓
	UnPlugged <sup>*3 *4</sup>	✓	✓	✓	✓
	Studio-Mix <sup>*3 *4</sup>	✓	✓	✓	✓
	AllChStereo	✓	✓	✓	✓
FullMono	✓	✓	✓	✓	
[GAME]	DTS, DTS 96/24	✓			✓
	DTS-ES Discrete/Matrix				✓ <sup>*1</sup>
	Neo:6	✓			
	Dolby PLII Game/Dolby PLIIx Game <sup>*2</sup>		✓		
	DolbyEX	✓			
	AllChStereo	✓	✓	✓	✓
	FullMono	✓	✓	✓	✓
	T-D <sup>*4</sup>	✓	✓	✓	✓
[STEREO]	Stereo	✓	✓	✓	✓

\*1. If there are no surround back speakers, or speaker set B is on, DTS is used.

\*2. If there are no surround back speakers, or speaker set B is on, Dolby Pro Logic II is used.

\*3. Available only when using surround speakers.

\*4. DTS 96/24 is processed as DTS.

Requires 6.1/7.1 speakers. Not available while speaker set B is on.

Requires 7.1 speakers. Not available while speaker set B is on.

## About the Listening Modes

The AV receiver's listening modes can transform your listening room into a movie theater or concert hall, with high fidelity and stunning surround sound.

The illustration shows which speakers are active in each listening mode with 7.1 channel speaker system.

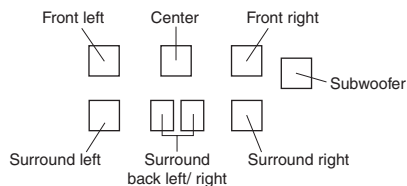

### Direct

In this mode, audio from the input source is output directly with minimal processing, providing high-fidelity reproduction. All of the source's audio channels are output as they are.

### Stereo

Sound is output by the front left and right speakers and subwoofer.

### Mono

Use this mode when watching an old movie with a mono soundtrack, or use it with the foreign language soundtracks recorded in the left and right channels of some movies. It can also be used with DVDs or other sources containing multiplexed audio, such as karaoke DVDs.

### Dolby Pro Logic IIx

### Dolby Pro Logic II

**Dolby Pro Logic IIx** expands any 2-channel source for 7.1-channel playback. It provides a very natural and seamless surround-sound experience that fully envelops the listener. As well as music and movies, video games can also benefit from the dramatic spatial effects and vivid imaging. If you're not using any surround back speakers, **Dolby Pro Logic II** will be used instead of Dolby Pro Logic IIx.

- **Dolby PLIIx Movie**

Use this mode with any stereo or Dolby Surround (Pro Logic) movie (e.g., TV, DVD, VHS).

- **Dolby PLIIx Music**

Use this mode with any stereo or Dolby Surround (Pro Logic) music source (e.g., CD, radio, cassette, TV, VHS, DVD).

- **Dolby PLIIx Game**

Use this mode with video games, especially those that bear the Dolby Pro Logic II logo.

### Dolby Digital

Use this mode with DVDs that bear the Dolby Digital logo, and Dolby Digital TV broadcasts. This is the most common digital surround-sound format, and it'll put you right in the middle of the action, just like being in a movie theater or concert hall.

### 5.1-channel source + Dolby EX

These modes expand 5.1-channel sources for 6.1/7.1-channel playback. They're especially suited to Dolby EX soundtracks that include a matrix-encoded surround back channel. The additional channel adds an extra dimension and provides an enveloping surround sound experience, perfect for rotating and fly-by sound effects.

### 5.1-channel source + Dolby PLIIx Music

These modes use the Dolby Pro Logic IIx Music mode to expand 5.1-channel sources for 6.1/7.1-channel playback.

### 5.1-channel source + Dolby PLIIx Movie

These modes use the Dolby Pro Logic IIx Movie mode to expand 5.1-channel sources for 7.1-channel playback.

### DTS

The DTS digital surround-sound format supports up to 5.1 discrete channels and uses less compression for high-fidelity reproduction. Use it with DVDs and CDs that bear the DTS logo.

### DTS 96/24

This mode is for use with DTS 96/24 sources. This is high-resolution DTS with a 96kHz sampling rate and 24-bit resolution, providing superior fidelity. Use it with DVDs that bear the DTS 96/24 logo.

### DTS-ES Discrete

This mode is for use with DTS-ES Discrete soundtracks, that use a discrete surround back channel for true 6.1/7.1-channel playback. The seven totally separate audio channels provide better spatial imaging and 360-degree sound localization, perfect for sounds that pan across the surround channels. Use it with DVDs that bear the DTS-ES logo, especially those with a DTS-ES Discrete soundtrack.

### DTS-ES Matrix

This mode is for use with DTS-ES Matrix soundtracks, that use a matrix-encoded back-channel for 6.1/7.1-channel playback. Use it with DVDs that bear the DTS-ES logo, especially those with a DTS-ES Matrix soundtrack.

### DTS Neo:6

This mode expands any 2-channel source for 7.1-channel playback. It uses seven full-bandwidth channels of matrix decoding for matrix-encoded material, providing a very natural and seamless surround sound experience that fully envelops the listener.

- **Neo:6 Cinema (NEO:6 Cin)**  
Use this mode with any stereo movie (e.g., TV, DVD, VHS).
- **Neo:6 Music (NEO:6 Mus)**  
Use this mode with any stereo music source (e.g., CD, radio, cassette, TV, VHS, DVD).

### 5.1-channel source + Neo:6

This mode uses Neo:6 to expand 5.1-channel sources for 6.1/7.1-channel playback.

## Onkyo Original DSP Modes

---

### Mono Movie

This mode is suitable for old movies and other mono sources. The center speaker outputs the sound as it is, while reverb is applied to the sound output by the other speakers, giving presence to even mono material.

### Orchestra

Suitable for classical or operatic music, this mode emphasizes the surround channels in order to widen the stereo image and simulates the natural reverberation of a large hall.

### Unplugged

Suitable for acoustic instruments, vocals, and jazz, this mode emphasizes the front stereo image, giving the impression of being right in front of the stage.

### Studio-Mix

Suitable for rock or pop music, listening to music in this mode creates a lively sound field with a powerful acoustic image, like being at a club or rock concert.

### TV Logic

This mode adds realistic acoustics to TV shows produced in a TV studio, surround effects to the entire sound, and clarity to voices.

### All Ch Stereo (AllCh St)

Ideal for background music, this mode fills the entire listening area with stereo sound from the front, surround, and surround back speakers.

### Full Mono

In this mode, all speakers output the same sound in mono, so the sound you hear is the same regardless of where you are within the listening room.

### T-D (Theater-Dimensional) or

With this mode you can enjoy a virtual 5.1 surround sound even with only two or three speakers. This works by controlling how sounds reach the listener's left and right ears. Good results may not be possible if there's too much reverb, so we recommend that you use this mode in an environment with little or no natural reverb.



# Recording

This section explains how to record the input source and how to record audio and video from separate sources.

**Notes:**

- The surround sound and DSP listening modes cannot be recorded.
- Copy-protected DVDs cannot be recorded.
- Sources connected to the analog multichannel input cannot be recorded.
- Sources connected to a digital input cannot be recorded. Only analog inputs can be recorded.
- DTS signals will be recorded as noise, so don't attempt analog recording of DTS CDs or LDs.
- While the Pure Audio listening mode is selected, the VCR/DVR OUT V and S jacks don't output video signals, so select another mode when recording.

## Recording the Input Source

Audio sources can be recorded to a recorder (e.g., cassette deck, CDR, MD) connected to the TAPE OUT jack. Video sources can be recorded to a video recorder (e.g., VCR, DVR) connected to the VCR/DVR OUT jacks. See pages 27 to 40 for hookup information.

**1** Use the input selector buttons to select the source that you want to record.

See "Which Connections Should I Use?" on page 28 to see which signals can be output and recorded.

You can watch the source while recording it. The AV receiver's MASTER VOLUME control has no effect on recording.

**2** On your recorder, start recording.

**3** On the source component, start playback.

**Note:**

- If you select a different input source during recording, that input source will be recorded instead.

## Recording from Different AV Sources

You can overdub audio onto your video recordings by simultaneously recording audio and video from two separate sources. This is possible because only the audio source is switched when an audio-only input source, such as TAPE, TUNER, or CD, is selected, the video source remains the same.

In the following example, audio from the CD player connected to the CD IN and video from the camcorder connected to the AUX INPUT VIDEO jack are recorded by the VCR connected to the VCR/DVR OUT jacks.

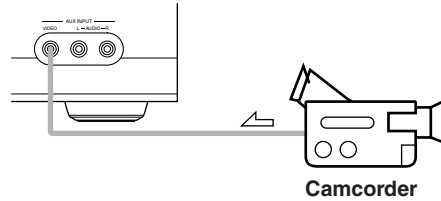

↗ : video signal  
 ↘ : audio signal

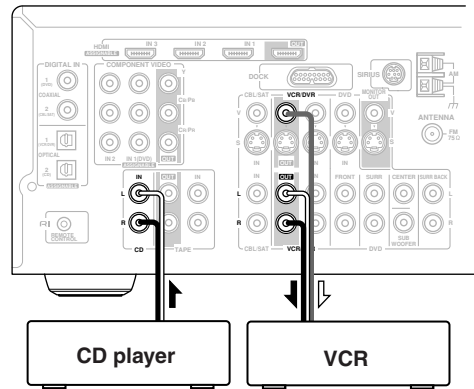





- 1 Prepare the camcorder and CD player for playback.**
- 2 Prepare the VCR for recording.**
- 3 Press the [AUX] input selector button.**
- 4 Press the [CD] input selector button.**  
 This selects the CD player as the audio source but leaves the camcorder as the video source.
- 5 Start recording on the VCR, then start playback on the camcorder and CD player.**  
 Video from the camcorder and audio from the CD player are recorded by the VCR.

# Adjusting the Listening Modes

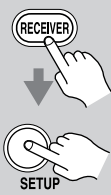
## Using the Audio Adjust Settings

With the Audio Adjust functions and settings, you can adjust the sound and listening modes as you like.

<b>1</b> 	<b>Press the [RECEIVER] button followed by the [SETUP] button.</b>
<b>2</b> 	<b>Use the Up and Down [▲]/[▼] buttons to select “6.Audio Adjust,” and then press [ENTER].</b> 
<b>3</b> 	<b>Use the Left and Right [◀]/[▶] buttons to change the setting. Press the Down [▼] button to select the next setting.</b> Repeat this step for the other settings.
<b>4</b> 	<b>Press the [SETUP] button.</b> Setup closes.

The Audio Adjust settings are explained below.

## Multiplex/Mono Settings

### Multiplex

#### ■ Input (Mux)

This setting determines which channel of a stereo multiplex source is output. Use it to select audio channels or languages with multiplex sources, multilingual TV broadcasts, and so on.

**Main:** The main channel is output (default).

**Sub:** The sub channel is output.

**M/S:** Both the main and sub channels are output.

### Mono

#### ■ Input (Mono)

This setting determines which channel is output when the Mono listening mode is used with a stereo source.

**L+R:** Both the left and right channels are output (default).

**L:** Only the left channel is output.

**R:** Only the right channel is output.

## PLIIx/Neo:6 Settings

### PLIIx Music (2 ch Input)

These settings apply to only 2-channel stereo sources.

If you're not using any surround back speakers, these settings apply to Dolby Pro Logic II, not Dolby Pro Logic Ix.

#### ■ Panorama

With this setting, you can broaden the width of the front stereo image when using the Dolby Pro Logic Ix Music listening mode.

**On:** Panorama function on.

**Off:** Panorama function off (default).

#### ■ Dimension

With this setting, you can move the sound field forward or backward when using the Dolby Pro Logic Ix Music listening mode. It can be adjusted from -3 to +3. The default value is 0. Higher settings move the sound field backward. Lower settings move it forward.

If the stereo image feels too wide, or there's too much surround sound, move the sound field forward to improve the balance. Conversely, if the stereo image feels like it's in mono, or there's not enough surround sound, move it backward.

#### ■ Center Width

With this setting, you can adjust the width of the sound from the center speaker when using the Dolby Pro Logic Ix Music listening mode. Normally, if you're using a center speaker, the center channel sound is output by only the center speaker. (If you're not using a center speaker, the center channel sound will be distributed to the front left and right speakers to create a phantom center). This setting controls the front left, right, and center mix, allowing you to adjust the weight of the center channel sound. It can be adjusted from 0 to 7. The default value is 3.

## Adjusting the Listening Modes—Continued

### Neo:6 Music

#### ■ Center Image

The DTS Neo:6 Music listening mode creates 6-channel surround sound from 2-channel stereo sources. With this setting, you can specify by how much the front left and right channel output is attenuated in order to create the center channel. It can be adjusted from 0 to 5. The default value is 2.

When set to 0, the front left and right channel output is attenuated by half (–6 dB), giving the impression that the sound is located centrally. This setting works well when the listening position is considerably off center. When set to 5, the front left and right channels are not attenuated, maintaining the original stereo balance.

### Dolby Digital Settings

#### ■ Dolby EX

This setting determines how Dolby EX signals are handled.

**Auto:** When the source is Dolby EX, you can select the Dolby EX listening mode.

**Manual:** When the source is Dolby EX, you can select any of the listening modes compatible with this format (e.g., Dolby EX, Dolby Pro Logic IIX, etc.).

### T–D (Theater-Dimensional) Setting

#### ■ LstnAngl (Listening Angle)

With this setting, you can optimize the Theater-Dimensional listening mode by specifying the angle of the front left and right speakers relative to the listening position. Ideally, the front left and right speakers should be equidistant from the listening position and at an angle close to one of the two available settings.

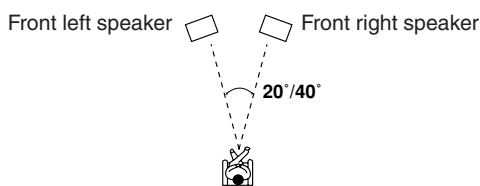

**Narrow:** Select if the listening angle is 20 degrees.

**Wide:** Select if the listening angle is 40 degrees (default).

### Multichannel Subwoofer Setting

#### ■ SW InSens

On some DVD players, the signal from the multichannel subwoofer output is 15 dB higher than normal. You can change the subwoofer sensitivity to match your DVD player. Note that this setting only affects signals con-

nected to the SUBWOOFER input jack of the multichannel DVD input.

You can select 0 dB (default), +5 dB, +10 dB, or +15 dB. If you find that your subwoofer is too loud, try the +10 dB or +15 dB setting.

### Using the Audio Settings

You can change various audio settings by pressing the [AUDIO] button.

<p>1</p> <p>RECEIVER</p> <p>AUDIO</p>	<p>Press the [RECEIVER] button followed by the [AUDIO] button.</p>
<p>2</p> <p>ENTER</p>	<p>Use the Up and Down [▲]/[▼] buttons to select an item.</p>
<p>3</p> <p>ENTER</p>	<p>Use the Left and Right [◀]/[▶] buttons to change the setting. Repeat this step for the other settings.</p>

The Audio Adjust settings are explained below.

### Tone Control Settings

You can adjust the bass and treble for the front speakers, except when the Direct listening mode is selected.

#### ■ Bass

You can boost or cut low-frequency sounds output by the front speakers from –10 dB to +10 dB in 2 dB steps.

#### ■ Treble

You can boost or cut high-frequency sounds output by the front speakers from –10 dB to +10 dB in 2 dB steps.

#### Notes:

- To bypass the bass and treble tone circuits, select the Direct listening mode.
- This procedure can also be performed on the AV receiver by using its [TONE], [–], and [+ ] buttons.

### Late Night Function

---

#### ■ Late Night

With the Late Night function, you can reduce the dynamic range of Dolby Digital material so that you can still hear quiet parts even when listening at low volume levels—ideal for watching movies late at night when you don't want to disturb anyone.

For Dolby Digital sources, the options are:

**Off:** Late Night function off (default).

**Low:** Small reduction in dynamic range.

**High:** Large reduction in dynamic range.

#### Notes:

- The Late Night function can be used only when the input source is Dolby Digital.
- The effect of the Late Night function depends on the material that you are playing and the intention of the original sound designer, and with some material there will be little or no effect when you select the different options.
- The Late Night function is set to Off when the AV receiver is set to Standby.

### CinemaFILTER

---

#### ■ Cinema Fitr

With the CinemaFILTER, you can soften overly bright movie soundtracks, which are typically mixed for reproduction in a movie theater.

CinemaFILTER can be used with the following listening modes: Dolby Digital, Dolby Digital EX, Dolby Pro Logic IIx Movie, Dolby Pro Logic II Movie, DTS, DTS-ES, DTS Neo:6 Cinema, DTS 96/24, and Neo:6.

**Off:** CinemaFILTER off.

**On:** CinemaFILTER on.

#### Note:

- The CinemaFILTER may not work when used with certain input sources.

### Audyssey Dynamic EQ

---

#### ■ DynamicEQ

With Audyssey Dynamic EQ, you can enjoy great sound even when listening at low volume levels.

Audyssey Dynamic EQ solves the problem of deteriorating sound quality as volume is decreased by taking into account human perception and room acoustics. It does so by selecting the correct frequency response and surround volume levels moment-by-moment so that the content sounds the way it was created at any volume level—not just at reference level.

**Off:** Audyssey Dynamic EQ off.

**On:** Audyssey Dynamic EQ on.

#### Note:

- Audyssey Dynamic EQ can be set only when the Equalizer Settings on page 81 are set to Audyssey.

### Music Optimizer

---

#### ■ M.Optimizer

The Music Optimizer function enhances the sound quality of compressed music files. Use it with music files that use “lossy” compression, such as MP3.

**Off:** Music Optimizer off (default).

**On:** Music Optimizer on.

#### Note:

- The Music Optimizer function only works with PCM digital audio input signals with a sampling rate below 48kHz and analog audio input signals. The Music Optimizer is disabled when the Direct listening mode is selected.

### Speaker Levels

---

You can adjust the volume of each speaker while listening to an input source.

These temporary adjustments are cancelled when the AV receiver is set to Standby.

#### ■ Subwoofer

You can adjust the level from -15 dB to +12 dB.

#### ■ Center

You can adjust the level from -12 dB to +12 dB.

#### Notes:

- You cannot use this function while the AV receiver is muted.
- Speakers that are set to No or None in the Speaker Configuration cannot be adjusted (see page 77).

### A/V Sync

---

#### ■ A/V Sync

When using progressive scanning on your DVD player, you may find that the picture and sound are out of sync. With this setting, you can correct this by delaying the audio signals. You can set it from 0 to 100 milliseconds (ms) in 20 millisecond steps.

#### Note:

- This setting is not available when the Direct listening mode is used with an analog input signal.

# Advanced Setup

## Speaker Setup

This section explains how to check the speaker settings and how to set them manually, which is useful if you change a speaker after performing the automatic speaker setup.

Some of the speaker settings are set automatically by the Automatic Speaker Setup function (see page 42).

**Speaker Configuration, Crossover Frequency, and Double Bass settings only need to be changed if you're not using the speakers in this package.**

**These settings cannot be changed while headphones are connected, speaker set B is on, or the multichannel DVD input is being used.**

## Speaker Configuration

These settings are set automatically by the Automatic Speaker Setup function (see page 42).

This section explains how to specify which speakers are connected and their sizes.

For speakers with a cone diameter larger than 6-1/2 inches (16 cm), specify **Large** (full band). For those with a smaller diameter, specify **Small** (default crossover 100Hz).

The crossover frequency can be changed on page 78.

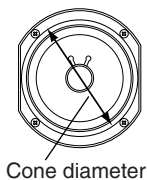

Cone diameter

<p><b>1</b></p>	<p><b>Press the [RECEIVER] button followed by the [SETUP] button.</b></p>
<p><b>2</b></p>	<p><b>Use the Up and Down [▲]/[▼] buttons to select "Sp Config," and then press the [ENTER] button.</b></p>

<p><b>3</b></p>	<p><b>While the "Subwoofer" setting is selected, use the Left and Right [◀]/[▶] buttons to select <b>Yes</b> or <b>No</b>.</b></p> <p><b>Yes:</b> Select if a subwoofer is connected.</p> <p><b>No:</b> Select if no subwoofer is connected.</p>
<p><b>4</b></p>	<p><b>Use the Down [▼] button to select "Front," and then use the Left and Right [◀]/[▶] buttons to select <b>Small</b> or <b>Large</b>.</b></p> <p><b>Small:</b> Select if the front speakers are small.</p> <p><b>Large:</b> Select if the front speakers are large.</p> <p><b>Note:</b></p> <ul style="list-style-type: none"> <li>If the Subwoofer setting in step 3 is set to No, this setting is fixed at Large and does not appear.</li> </ul>
<p><b>5</b></p>	<p><b>Use the Down [▼] button to select "Center," and then use the Left and Right [◀]/[▶] buttons to select <b>Small</b>, <b>Large</b>, or <b>None</b>.</b></p> <p><b>Small:</b> Select if the center speaker is small.</p> <p><b>Large:</b> Select if the center speaker is large.</p> <p><b>None:</b> Select if no center speaker is connected.</p> <p><b>Note:</b></p> <ul style="list-style-type: none"> <li>If the Front setting in step 4 is set to Small, the Large option cannot be selected.</li> </ul>
<p><b>6</b></p>	<p><b>Use the Down [▼] button to select "Surround," and then use the Left and Right [◀]/[▶] buttons to select <b>Small</b>, <b>Large</b>, or <b>None</b>.</b></p> <p><b>Small:</b> Select if the surround speakers are small.</p> <p><b>Large:</b> Select if the surround speakers are large.</p> <p><b>None:</b> Select if no surround speakers are connected.</p> <p><b>Note:</b></p> <ul style="list-style-type: none"> <li>If the Front setting in step 4 is set to Small, the Large option cannot be selected.</li> </ul>

7

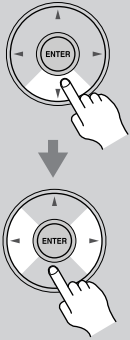

Use the Down [▼] button to select “SurrBack,” and use the Left and Right [◀]/[▶] buttons to select **Small**, **Large**, or **None**.

**Small:** Select if the surround back speakers are small.

**Large:** Select if the surround back speakers are large.

**None:** Select if no surround back speakers are connected.

**Notes:**

- If the Surround setting in step 6 is set to None, or Powered Zone 2 is being used, this setting does not appear.
- If the Surround setting in step 6 is set to Small, the Large option cannot be selected.

8

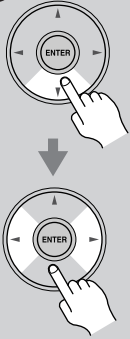

Use the Down [▼] button to select “SurrBack ch,” and use the Left and Right [◀]/[▶] buttons to select **2ch** or **1ch**.

**2ch:** Select if two (left and right) surround back speakers are connected.

**1ch:** Select if one surround back speaker is connected.

**Note:**

- If the Surround or SurrBack settings in steps 6 and 8 are set to None, this setting does not appear.

Continue with step 9 of the “Crossover Frequency” setting.

**Note:**

- These settings cannot be changed while headphones are connected or the multichannel DVD input is being used.

**Crossover Frequency**

This setting is set automatically by the Automatic Speaker Setup function (see page 42).

This setting only applies to the speakers that you specified as *Small* in the “Speaker Configuration” on page 77. To get the best bass performance from your speaker system, you need to set the crossover frequency according to the size and frequency response of your speakers

9

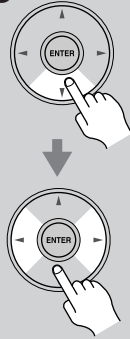

Use the Down [▼] button to select “Crossover,” and then use the Left and Right [◀]/[▶] buttons to select a crossover frequency.

Continue with step 10 of the “Double Bass” setting on the next page.

**Notes:**

- For a more accurate setting, look up the frequency response in the manuals supplied with your speakers and set accordingly.
- Choose a higher crossover frequency if you want more sound from your subwoofer.
- These settings cannot be changed while headphones are connected or the multichannel DVD input is being used.



### Double Bass

This setting is **not** set automatically by the Automatic Speaker Setup function (see page 42).

With the Double Bass function, you can boost bass output by feeding bass sounds from the front left, right, and center channels to the subwoofer. This function can be set only if the Subwoofer setting (step 3) is set to Yes, and the Front setting (step 4) is set to Large in the Speaker Configuration on page 77.

**10**



Use the Down [▼] button to select “Double Bass (D.Bass),” and then use the Left and Right [◀]/[▶] buttons to select:

- On:** Double Bass function on. Bass from the front left and right channels is also fed to the subwoofer (default).
- Off:** Double Bass function off.

**11**



Press the [SETUP] button. Setup closes.

**Note:**

- These settings cannot be changed while headphones are connected, speaker set B is on, or the multichannel DVD input is being used.

### Speaker Distance

These settings are set automatically by the Automatic Speaker Setup function (see page 42).

With these settings, you can specify the distance from each speaker to the listening position.

**1**

Measure and make a note of the distance from each speaker to the listening position.

**2**

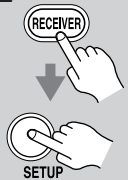

Press the [RECEIVER] REMOTE MODE button, followed by the [SETUP] button.

**3**



Use the Up and Down [▲]/[▼] buttons to select “Sp Distance,” and then press [ENTER].

**4**



While “Unit” is displayed, use the Left and Right [◀]/[▶] buttons to select “feet” or “meters”.

**feet:** Distances can be set in feet. Range: 1 to 30 feet in 1-foot steps.

**meters:** Distances can be set in meters. Range: 0.3 to 9 meters in 0.3-meter steps.

**5**

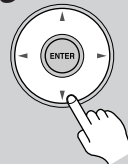

Use the Down [▼] button to select “Front” and use the Left and Right [◀]/[▶] buttons to specify the distance for the front speakers, then press the Down [▼] button to select the next speaker.

**6**

Repeat step 5 for all speakers.

**Note:**

Speakers that you set to No or None in the Speaker Configuration (page 77) cannot be selected.

**7**



Press the [SETUP] button. Setup closes.



**Notes:**

- The Center and Subwoofer distances can be set up to 5 ft. (1.5 m) more or less than the Left distance. For example, if the Left distance is set to 20 ft. (6 m), the Center and Subwoofer distances can be set between 15 and 25 ft. (4.5 and 7.5 m).
- The Surround and Surround Back distances can be set up to 5 ft. (1.5 m) more or 15 ft. (4.5 m) less than the Left distance. For example, if the Left distance is set to 20 ft. (6 m), the SurrRight, Surr Left, Surr Back R, and Surr Back L distances can be set between 5 and 25 ft. (1.5 and 7.5 m).
- The speaker distance cannot be adjusted while a pair of headphones is connected or the multichannel DVD input is being used.

### Speaker Levels

These settings are set automatically by the Automatic Speaker Setup function (see page 42).

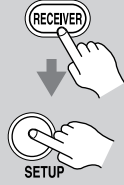
You can set the volume level of each speaker so that all speakers can be heard equally at the listening position.

<p><b>1</b></p> 	<p><b>Press the [RECEIVER] REMOTE MODE button, followed by the [SETUP] button.</b></p>
<p><b>2</b></p> 	<p><b>Use the Up and Down [▲]/[▼] buttons to select “Level Cal,” and then press [ENTER].</b></p> <p>A pink noise test tone is output by the front left speaker.</p>
<p><b>3</b></p>	<p><b>Turn up the volume so that you can hear the test tone sufficiently.</b></p> <p>As each speaker outputs the test tone, its name appears on the display.</p>
<p><b>4</b></p> 	<p><b>Use the Left and Right [◀]/[▶] buttons to adjust the speaker level, and use the Down [▼] button to select the next speaker.</b></p> <p>The levels can be adjusted from -12 to +12 dB in 1 dB steps (-15 to +12 dB for the subwoofer).</p>
<p><b>5</b></p>	<p><b>Repeat step 4 so that the level of the test tone coming from each speaker is the same.</b></p> <p>Speakers that you set to No or None in the Speaker Configuration (page 77) do not output the test tone.</p>

**6**

**Press the [SETUP] button.**

Setup closes.

Don't forget to turn down the volume if you turned it up while setting the levels.



**Note:**





- The speaker levels cannot be adjusted while a pair of headphones is connected or the AV receiver is muted.
- While speaker set B is on, you can adjust the volume of the left and right speakers, from -12 dB to +12 dB.
- While speaker set B is on, you cannot adjust the levels of speaker set A's surround back speakers.



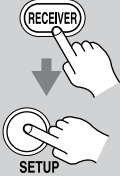

## Equalizer Settings

These settings are set automatically by the Automatic Speaker Setup function (see page 42).

Here you can adjust the tone of individual speakers. To set the volume of individual speakers, see page 80.

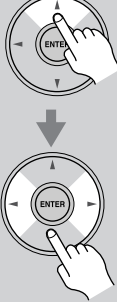
<p><b>1</b></p> 	<p>Press the [RECEIVER] REMOTE MODE button, followed by the [SETUP] button.</p>
<p><b>2</b></p> 	<p>Use the Up and Down [▲]/[▼] buttons to select “Equalizer,” and then press [ENTER].</p>
<p><b>3</b></p> 	<p>Use the Left and Right [◀]/[▶] buttons to select:</p> <p><b>Off:</b> Tone off, response flat.</p> <p><b>Audyssey:</b> The tone for each speaker is set automatically by the Automatic Speaker Setup. Be sure to select this setting after having performed the Automatic Speaker Setup.</p> <p><b>Manual:</b> You can adjust the equalizer for each speaker manually.</p> <p>If you selected Manual, continue with this procedure. If you selected Off or Audyssey, go to step 7.</p>
<p><b>4</b></p> 	<p>Press the Down [▼] button, and then use the Left and Right [◀]/[▶] buttons to select a speaker.</p>

<p><b>5</b></p> 	<p>Use the Up and Down [▲]/[▼] buttons to select a frequency. Use the Left and Right [◀]/[▶] buttons to adjust the level at that frequency.</p> <div style="border: 1px solid black; padding: 5px; width: fit-content; margin: 10px auto;"> <p>F 800Hz 1 +3dB</p> </div> <p>The volume at each frequency can be adjusted from -6 to +6 dB in 1 dB steps.</p> <p><b>Tip:</b> Low frequencies (e.g., 63Hz, 80Hz) affect bass sounds; high frequencies (e.g., 8000Hz, 16000Hz) affect treble sounds.</p>
<p><b>6</b></p> 	<p>Use the Up [▲] button to select “Ch,” and then use the Left and Right [◀]/[▶] buttons to select another speaker.</p> <p>Repeat steps 4 and 5 for each speaker. Speakers that you’ve set to No or None in the Speaker Configuration (page 77) cannot be selected.</p>
<p><b>7</b></p> 	<p>Press the [SETUP] button. The setup menu closes.</p>

### Notes:

- The front, center, surround, and surround back speakers can be adjusted at 80Hz, 250Hz, 800Hz, 2500Hz, and 8000Hz. The subwoofer can be adjusted at 40Hz, 80Hz, and 160Hz.
- While the Direct listening mode is selected, the equalizer settings have no effect.
- This procedure can also be performed on the AV receiver by using its [SETUP], [ENTER], and arrow buttons.

# Controlling Other Components



You can control your DVD player, CD player, and other components with the AV receiver's remote controller. To control another component, you must first enter that component's remote control code to a REMOTE MODE button.

This section explains how to enter remote control codes and how to control your other components.

## Preprogrammed Remote Control Codes

The following REMOTE MODE buttons are preprogrammed with remote control codes for controlling the components listed. You do not need to enter a remote control code to control these components.

For details on controlling these components, see the pages indicated.

-  Onkyo DVD player (page 84)
-  Onkyo CD player (page 87)
-  Onkyo cassette recorder with **RI** (page 88)

## Entering Remote Control Codes

You'll need to enter a code for each component that you want to control.

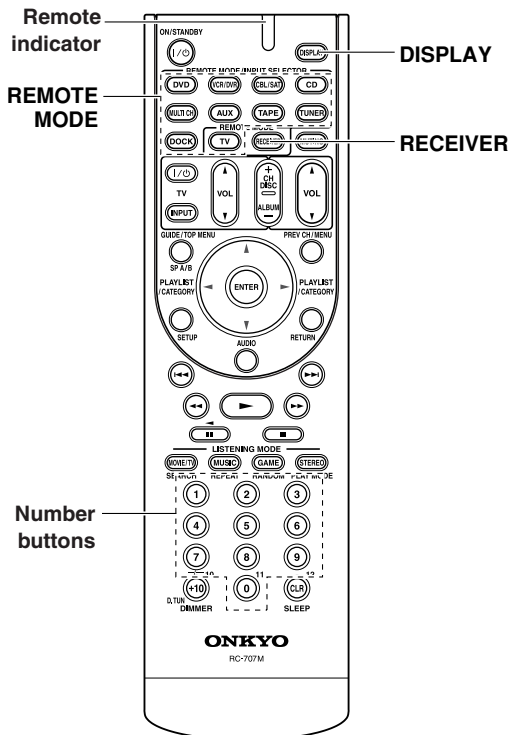

**1**

**Look up the component's remote control code in the separate Remote Control Codes list.**

The codes are organized by category.

**2**

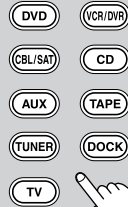

(3 seconds)

**While holding down the REMOTE MODE button to which you want to enter a code, press and hold down the [DISPLAY] button until the Remote indicator lights up (about 3 seconds).**

**Note:**

- Remote control codes cannot be entered for the [RECEIVER] REMOTE MODE button.
- Only TV remote control codes can be entered for the [TV] REMOTE MODE button.
- Apart from the [RECEIVER] and [TV] REMOTE MODE buttons, remote control codes from any category can be entered for the REMOTE MODE buttons. However, these buttons also work as input selector buttons (page 47), so choose a REMOTE MODE button that corresponds with the input to which you connect your component. For example, if you connect your CD player to the CD input, choose the [CD] REMOTE MODE button when entering its remote control code.

**3**

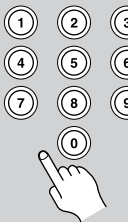

**Within 30 seconds, use the number buttons to enter the 5-digit remote control code.**

The Remote indicator flashes twice.

If the remote control code is not entered successfully, the Remote indicator will flash once slowly.

**Notes:**

- The remote control codes provided are correct at the time of printing but subject to change.
- Only RI Docks with a remote control sensor, such as the DS-A2 and DS-A2X, can be controlled with the AV receiver's remote controller and the appropriate remote control code.

### Remote Control Codes for Onkyo Components Connected via **RI**

Onkyo components that are connected via **RI** are controlled by pointing the remote controller at the AV receiver, not the component. This allows you to control components that are out of view, in a rack, for example.

- 1** Make sure the Onkyo component is connected with an **RI** cable and an analog audio cable (RCA).  
See page 40 for details.
- 2** Enter the appropriate remote control code to the **REMOTE MODE** button.
  - [DVD] **REMOTE MODE** button  
**31612**: Onkyo DVD player with **RI**
  - [CD] **REMOTE MODE** button  
**71327**: Onkyo CD player with **RI**
  - [TAPE] **REMOTE MODE** button  
**42157**: Onkyo cassette recorder with **RI** (default)

See the previous page for how to enter remote control codes.
- 3** Press the **REMOTE MODE** button, point the remote controller at the AV receiver, and operate the component.

If you want to control an Onkyo component by pointing the remote controller directly at it, or you want to control an Onkyo component that's not connected via **RI**, use the following remote control codes:

- [DVD] **REMOTE MODE** button  
**30627**: Onkyo DVD player without **RI** (default)
- [CD] **REMOTE MODE** button  
**71817**: Onkyo CD player without **RI** (default)

### Resetting the **REMOTE MODE** Buttons

You can reset a **REMOTE MODE** button to its default remote control code.

- 1**



While holding down the **REMOTE MODE** button that you want to reset, press and hold down the [AUDIO] button until the Remote indicator lights up (about 3 seconds).
- 2**

Within 30 seconds, press the **REMOTE MODE** button again. The Remote indicator flashes twice, indicating that the button has been reset. Each of the **REMOTE MODE** buttons is preprogrammed with a remote control code. When a button is reset, its preprogrammed code is restored.

### Resetting the Remote Controller

You can reset the remote controller to its default settings.

- 1**

While holding down the [RECEIVER] **REMOTE MODE** button, press and hold down the [AUDIO] button until the Remote indicator lights up (about 3 seconds).
- 2**

Within 30 seconds, press the [RECEIVER] **REMOTE MODE** button again. The Remote indicator flashes twice, indicating that the remote controller has been reset.

## Controlling a DVD Player, or DVD Recorder

By pressing the REMOTE MODE button that's been programmed with the remote control code for your DVD player (HD DVD, Blu-ray, or TV/DVD combination), you can control your player with the following buttons.

The [DVD] REMOTE MODE button is preprogrammed with the remote control code for controlling an Onkyo DVD player.

For details on entering a remote control code for a different component, see page 82.

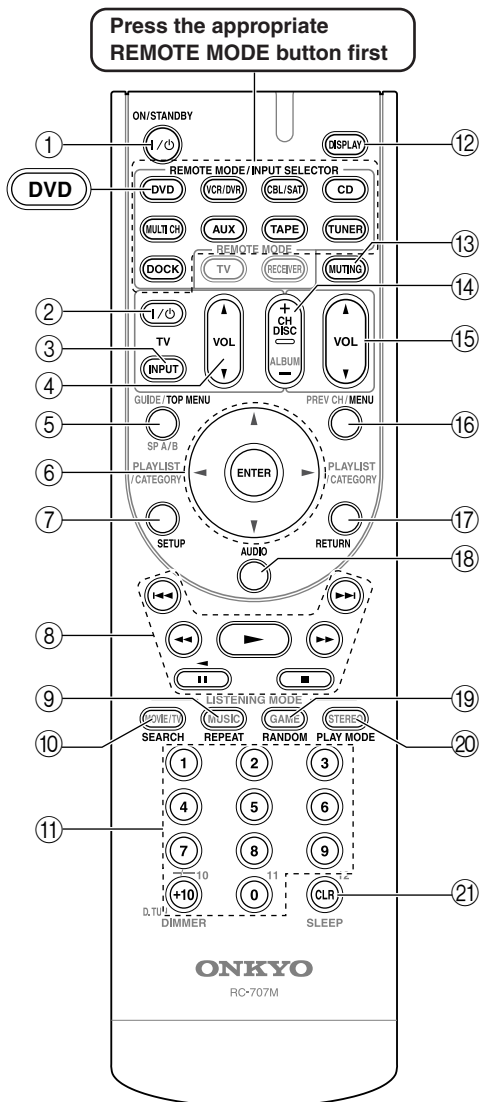

\* With some components, certain buttons may not work as expected, and some may not work at all.

- ① **ON/STANDBY button**  
Sets the DVD player to On or Standby.
- ② **TV [I/O] button**  
Set the TV to On or Standby.
- ③ **TV [INPUT] button**  
Selects the TV's external inputs.
- ④ **TV VOL [▲]/[▼] button**  
Adjust the TV's volume.
- ⑤ **TOP MENU button**  
Displays a DVD's top menu or a DVD's title.
- ⑥ **Arrow [▲]/[▼]/[◀]/[▶] and ENTER buttons**  
Used to navigate menus and select items.
- ⑦ **SETUP button**  
Used to access the DVD player's settings.
- ⑧ **Playback buttons**  
From left to right: Previous, Rewind, Pause, Play, Stop, Fast Forward, and Next.
- ⑨ **REPEAT button**  
Used with the repeat playback function.
- ⑩ **SEARCH buttons**  
Used to search title, chapter, and track numbers, and to search times for locating specific points.
- ⑪ **Number buttons**  
Used to enter title, chapter, and track numbers, and to enter times for locating specific points. The [+10] button works as a +10 button or “-.-” button.
- ⑫ **DISPLAY button**  
Displays information about the current disc, title, chapter, or track, including elapsed time, remaining time, total time, and so on.
- ⑬ **MUTING button (48)**  
Mutes or unmutes the AV receiver.
- ⑭ **DISC +/-, CH +/- button**  
Selects discs on a DVD changer. Selects TV channels on a component with a built-in tuner.
- ⑮ **VOL [▲]/[▼] button (47)**  
Adjusts the volume of the AV receiver.
- ⑯ **MENU button**  
Displays a DVD's menu.
- ⑰ **RETURN button**  
Exits the DVD player's setup menu or return to the previous menu.
- ⑱ **AUDIO button**  
Selects foreign language soundtracks and audio formats (e.g., Dolby Digital or DTS).
- ⑲ **RANDOM button**  
Used with the random playback function.

## Controlling Other Components—Continued

- 20 **PLAY MODE button**  
Selects play modes on components with selectable play modes.
- 21 **CLR button**  
Cancels functions and clears entered numbers.

### Note:

- If you enter the remote control code for a HD DVD or Blu-ray player that has A, B, C, and D or colored buttons, the [SEARCH], [REPEAT], [RANDOM], and [PLAY MODE] buttons will work as colored or A, B, C, D buttons. In this case, these buttons cannot be used to set repeat playback, random playback, or select play modes.

## Controlling a VCR, or PVR

By pressing the REMOTE MODE button that's been programmed with the remote control code for your VCR (TV/VCR, PVR, DBS/PVR combination or cable/PVR combination), you can control your video recorder with the following buttons.

For details on entering a remote control code for a different component, see page 82.

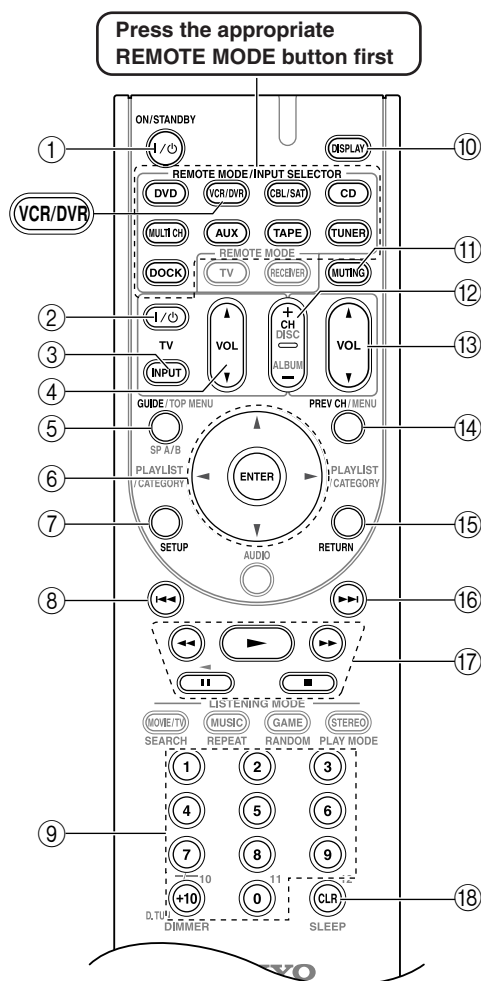

\* With some components, certain buttons may not work as expected, and some may not work at all.

- 1 **ON/STANDBY button**  
Set the video recorder to On or Standby.
- 2 **TV [I/⏻] button**  
Set the TV to On or Standby.
- 3 **TV [INPUT] button**  
Selects the TV's external inputs.
- 4 **TV VOL [▲]/[▼] button**  
Adjust the TV's volume.
- 5 **GUIDE button**  
Displays the program guide or navigation list.
- 6 **Arrow [▲]/[▼]/[◀]/[▶] and ENTER buttons**  
Used to navigate menus and select items.
- 7 **SETUP button**  
Displays the video recorders setup menu.
- 8 **Previous [◀◀] button**  
Previous or instant replay function.
- 9 **Number buttons**  
Enter numbers. The [0] button enters 11 on some components. The [+10] button works as a +10 button or "--" button.
- 10 **DISPLAY button**  
Displays information.
- 11 **MUTING button (48)**  
Mutes or unmutes the AV receiver.
- 12 **CH +/- button**  
Selects TV channels on the video recorder.
- 13 **VOL [▲]/[▼] button (47)**  
Adjusts the volume of the AV receiver.
- 14 **PREV CH button**  
Selects the previous channel.
- 15 **RETURN button**  
Exits the menu or return to the previous menu.
- 16 **Next [▶▶] button**  
Next or advance function.
- 17 **Playback buttons**  
From left to right: Previous, Next, Rewind, Play, Fast Forward, Pause, and Stop.
- 18 **CLR button**  
Cancels functions or enters the number 12.

## Controlling a Satellite Receiver or Cable Receiver

By pressing the REMOTE MODE button that's been programmed with the remote control code for your satellite receiver, cable receiver, or DVD recorder (DBS/PVR combination or cable/PVR combination), you can control your player with the following buttons.

For details on entering a remote control code for a different component, see page 82.

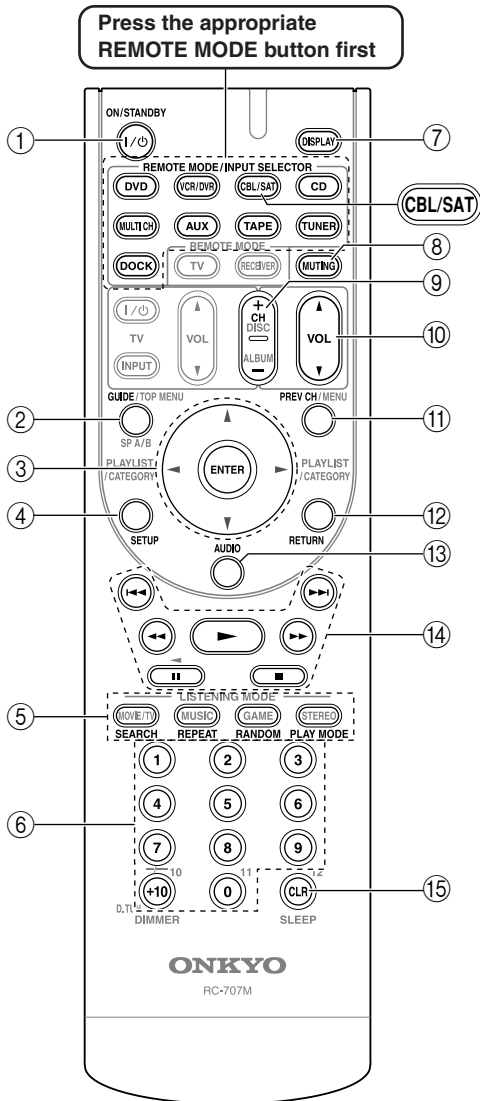

- ① **ON/STANDBY button**  
Set the component to On or Standby.
- ② **GUIDE button**  
Displays the onscreen program guide.
- ③ **Arrow [▲]/[▼]/[◀]/[▶] and ENTER buttons**  
Used to navigate menus and select items.
- ④ **SETUP button**  
Displays the setup menu.
- ⑤ **SEARCH, REPEAT, RANDOM, and PLAY MODE buttons**  
Function as colored buttons or A, B, C, D buttons.
- ⑥ **Number buttons**  
Enter numbers. The [+10] button works as a +10 button or “-.-” button.
- ⑦ **DISPLAY button**  
Displays information.
- ⑧ **MUTING button (48)**  
Mutes or unmutes the AV receiver.
- ⑨ **CH +/- button**  
Selects satellite/cable channels.
- ⑩ **VOL [▲]/[▼] button (47)**  
Adjusts the volume of the AV receiver.
- ⑪ **PREV CH button**  
Selects the previous channel.
- ⑫ **RETURN button**  
Exits the menu.
- ⑬ **AUDIO button**  
Selects foreign language soundtracks and audio formats (e.g., Dolby Digital or DTS).
- ⑭ **Playback buttons**  
From left to right: Previous, Next, Rewind, Play, Fast Forward, Pause, and Stop.
- ⑮ **CLR button**  
Cancels functions and clears entered numbers.

\* With some components, certain buttons may not work as expected, and some may not work at all.

## Controlling a CD Player, CD Recorder, or MD Player

By pressing the REMOTE MODE button that's been programmed with the remote control code for your CD player, CD recorder, or MD player, you can control your player with the following buttons.

The [CD] REMOTE MODE button is preprogrammed with the remote control code for controlling an Onkyo CD player.

For details on entering a remote control code for a different component, see page 82.

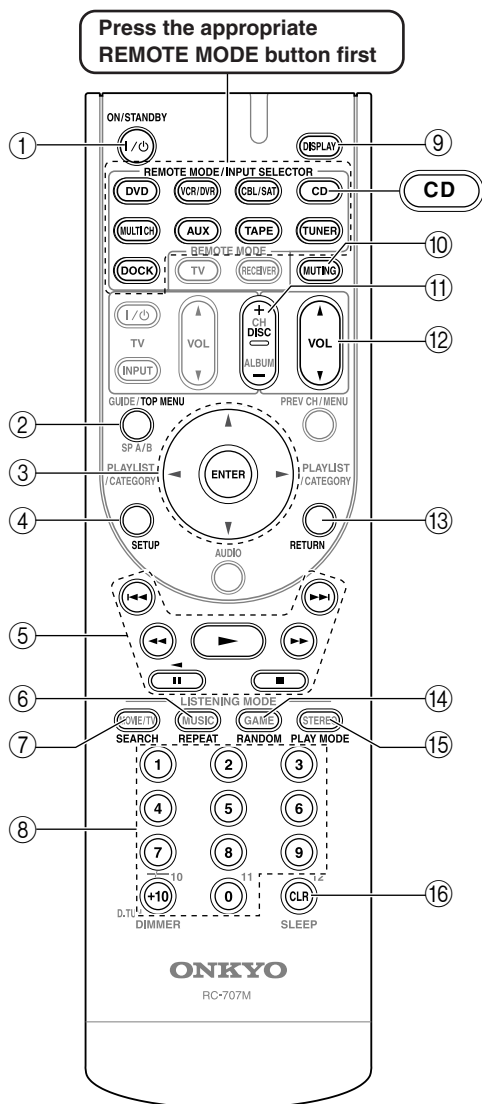

- ① **ON/STANDBY button**  
Set the component to On or Standby.
- ② **TOP MENU button**  
Displays a menu.
- ③ **Arrow [▲]/[▼]/[◀]/[▶] and ENTER buttons**  
Used to navigate menus and select items.
- ④ **SETUP button**  
Used to access the Onkyo CD player's settings.
- ⑤ **Playback buttons**  
From left to right: Previous, Rewind, Pause, Play, Stop, Fast Forward, and Next.
- ⑥ **REPEAT button**  
Used with the repeat playback function.
- ⑦ **SEARCH button**  
Used to locate specific points.
- ⑧ **Number buttons**  
Used to enter track numbers and times for locating specific points. The [+10] button works as a +10 button or "-..." button.
- ⑨ **DISPLAY button**  
Displays information about the current disc or track, including elapsed time, remaining time, total time, and so on.
- ⑩ **DISC +/- button**  
Selects discs on a CD changer.
- ⑪ **RETURN button**  
Exits the CD player's setup menu.
- ⑫ **RANDOM button**  
Used with the random playback function.
- ⑬ **PLAY MODE button**  
Selects play modes on components with selectable play modes.
- ⑭ **CLR button**  
Cancels functions and clears entered numbers.

\* With some components, certain buttons may not work as expected, and some may not work at all.



## Controlling a Cassette Recorder

By pressing the REMOTE MODE button that's been programmed with the remote control code for your cassette recorder, you can control your cassette recorder with the following buttons.

The [TAPE] REMOTE MODE button is preprogrammed with the remote control code for controlling an Onkyo cassette recorder when used with an **RI** connection.

For details on entering a remote control code for a different component, see page 82.

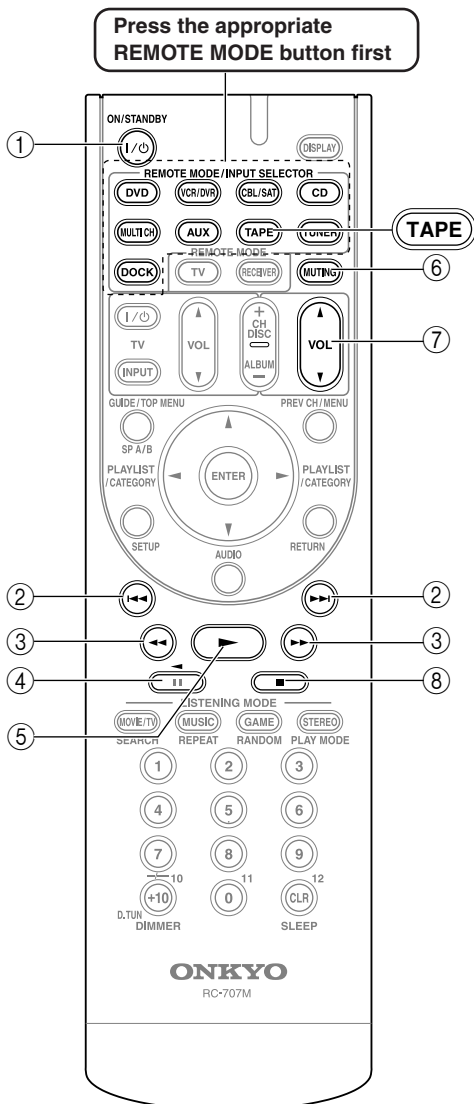

On twin cassette decks, only Deck B can be controlled.

- ① **ON/STANDBY button**  
Turns the cassette recorder on or off.
- ② **Previous and Next [◀◀]/[▶▶] buttons**  
The Previous [◀◀] button selects the previous track. During playback it selects the beginning of the current track. The Next [▶▶] button selects the next track.  
Depending on how they were recorded, the Previous and Next [◀◀]/[▶▶] buttons may not work properly with some cassette tapes.
- ③ **Rewind and Fast Forward [◀◀]/[▶▶] buttons**  
The Rewind [◀◀] button starts rewind. The Fast Forward [▶▶] button starts fast forward.
- ④ **Reverse Play [◀] button**  
Starts reverse playback.
- ⑤ **Play [▶] button**  
Starts playback.
- ⑥ **MUTING button (48)**  
Mutes or unmutes the AV receiver.
- ⑦ **VOL [▲]/[▼] button (47)**  
Adjusts the volume of the AV receiver.
- ⑧ **Stop [■] button**  
Stops playback.

**Note:**

- An Onkyo cassette recorder connected via **RI** can also be controlled in Receiver mode.

\* With some components, certain buttons may not work as expected, and some may not work at all.



## Controlling a TV

By pressing the [TV] REMOTE MODE button that's been programmed with the remote control code for your TV (TV/DVD combination or TV/VCR combination), you can control your TV with the following buttons.

For details on entering a remote control code for a different component, see page 82.

Press [TV] REMOTE MODE button first

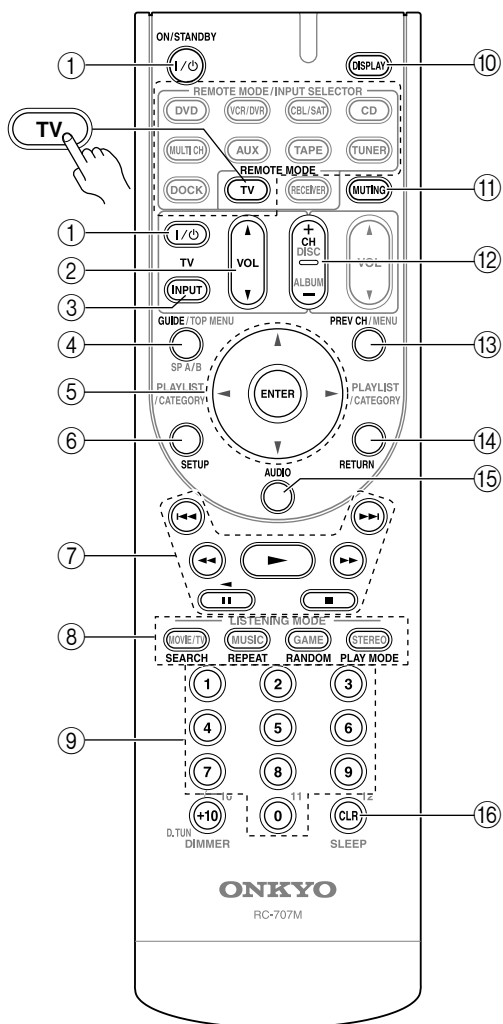

- ① **ON/STANDBY, TV [I/⏻] buttons**  
Set the TV to On or Standby.
- ② **TV VOL [▲]/[▼]\***  
Adjust the TV's volume.
- ③ **TV [INPUT]\* button**  
Selects the TV's external inputs.
- ④ **GUIDE button**  
Displays the program guide.
- ⑤ **Arrow [▲]/[▼]/[◀]/[▶] and ENTER buttons**  
Used to navigate menus and select items.
- ⑥ **SETUP button**  
Displays a menu.
- ⑦ **Playback buttons**  
From left to right: Previous, Rewind, Pause, Play, Stop, Fast Forward, and Next.  
These buttons work for combination devices.
- ⑧ **SEARCH, REPEAT, RANDOM, and PLAY MODE buttons**  
Function as colored buttons or A, B, C, D buttons.
- ⑨ **Number buttons**  
Enter numbers. 0 button enters 11 on some components. +10 button works as "--" button or +10.
- ⑩ **DISPLAY button**  
Displays information.
- ⑪ **MUTING button**  
Mutes the TV.
- ⑫ **CH +/- button**  
Select channels on the TV.
- ⑬ **PREV CH button**  
Selects the previous or last channel.
- ⑭ **RETURN button**  
Exits the TV's setup menu.
- ⑮ **AUDIO button**  
Selects foreign language soundtracks and audio formats (e.g., Dolby Digital or DTS).
- ⑯ **CLR button**  
Cancels functions and clears entered numbers, or enters 12.

\* With some components, certain buttons may not work as expected, and some may not work at all.

# Troubleshooting

If you have any trouble using the AV receiver, look for a solution in this section. If you can't resolve the issue yourself, contact your Onkyo dealer.

If you can't resolve the issue yourself, try resetting the AV receiver before contacting your Onkyo dealer.

**To reset the AV receiver to its factory defaults, turn it on and, while holding down the [VCR/DVR] button, press the [ON/STANDBY] button. "Clear" will appear on the display and the AV receiver will enter Standby mode.**

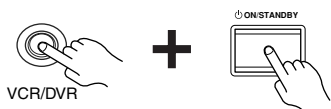

Note that resetting the AV receiver will delete your radio presets and custom settings.

## Power

### Can't turn on the AV receiver

- Make sure that the power cord is plugged into the wall outlet properly.
- Unplug the power cord from the wall outlet, wait 5 seconds or more, then plug it back in again.

### The AV receiver turns off as soon as it's turned on

- The amp protection circuit has been activated. Remove the power cord from the wall outlet immediately. Disconnect all speaker cables and input sources, and leave the AV receiver with its power cord disconnected for 1 hour. After that, reconnect the power cord and set the volume to maximum. If the AV receiver stays on, set the volume to minimum, disconnect the power cord, and reconnect your speakers and input sources. If the AV receiver turns off when you set the volume to maximum, disconnect the power cord, and contact your Onkyo dealer.

## Audio

### There's no sound or it's very quiet

- To listen to an audio source that's connected to an HDMI input, make sure that input is assigned to an input selector (page 44). HDMI audio is passed through the AV receiver and can only be heard from your TV.
- To listen to an audio source that's connected to an OPTICAL or COAXIAL input, make sure that input is assigned to an input selector (page 46).
- Make sure that all audio connecting plugs are pushed in all the way (page 27).
- Make sure that the polarity of the speaker cables is correct, and that the bare wire is in contact with the metal part of each speaker terminal (page 22).
- Make sure that the speaker cables are not shorting.

- Check the volume (page 47). The AV receiver is designed for home theater enjoyment and has a wide volume range for precise adjustment.
- If the MUTING indicator is flashing on the display, press the remote controller's [MUTING] button to unmute the AV receiver (page 48).
- While a pair of headphones is connected to the PHONES jack, no sound is output by the main room speakers (page 49).
- Check the digital audio output settings on the source component. On some game consoles, such as those that can play DVDs, the default setting is off.
- With some DVD-Video discs, you need to select an audio format from a menu or with the AUDIO button on your DVD player's remote controller.
- If your turntable doesn't have a phono preamp built-in, you must connect one between it and the AV receiver.
- If your turntable uses an MC cartridge, you must connect an MC head amp, or an MC transformer and a phono preamp.
- Check the speaker settings (pages 77–81).
- If the digital signal format is set to PCM or DTS, set it to Auto (page 50).
- If there's no sound from a DVD player connected to an HDMI IN, check the DVD player's output settings, and be sure to select a compatible audio format.

### Only the front speakers produce sound

- When the Stereo or Mono listening mode is selected, only the front speakers and subwoofer produce sound.
- Check the Speaker Configuration (page 77).

### Only the center speaker produces sound

- If you use the Dolby Pro Logic IIx Movie or Dolby Pro Logic IIx Music listening mode with a mono source, such as an AM radio station or mono TV program, the sound will be concentrated in the center speaker.
- Check the Speaker Configuration (page 77).

### The center speaker produces no sound

- When the Stereo or Mono listening mode is selected, the center speaker produces no sound (page 71).
- Check the Speaker Configuration (page 77).

### The surround speakers produce no sound

- When the Stereo or Mono listening mode is selected, the surround speakers produce no sound.
- Depending on the source and the current listening mode, not much sound may be produced by the surround speakers. Try another listening mode (page 67).
- Check the Speaker Configuration (page 77).

### The surround back speakers produce no sound

- The surround back speakers are not used with all listening modes. Try another listening mode (page 67).
- Not much sound may be produced by the surround back speakers with some sources.
- Check the Speaker Configuration (page 77).
- While speaker set B is on, playback is reduced to 5.1-channels and the surround back speakers produce no sound (page 7).

### The subwoofer produces no sound

- If the source material contains no audio in the LFE channel, the subwoofer produces no sound.
- Check the Speaker Configuration (page 77).

### There's no sound with a certain signal format

- Check the digital audio output setting on the source component. On some game consoles, such as those that can play DVDs, the default setting is off.
- With some DVD-Video discs, you need to select an audio format from a menu or with the AUDIO button on your DVD player's remote controller.

### Can't get 6.1- or 7.1-channel playback

- While speaker set B is on, playback in the main room is reduced to 5.1-channels and the surround back speakers produce no sound (page 7).

### The volume cannot be set to 79

- After the Automatic Speaker Setup function has been run, or the volume level of each individual speaker has been adjusted (pages 42 and 80), the maximum volume may be reduced.
- When the levels of each speaker have been adjusted (page 80), the maximum possible volume may be reduced.

### Noise can be heard

- Using cable ties to bundle audio cables with power cords, speaker cables, and so on can degrade audio performance, so don't use them.
- An audio cable may be picking up interference. Try repositioning your cables.
- When the Equalizer setting (page 81) is set to Audyssey, the maximum possible volume is reduced by 6 dB.

### The Late Night function doesn't work

- Make sure that the source is Dolby Digital (page 76).

### The analog multichannel input doesn't work

- Check the multichannel input connections (page 31).
- Make sure that the multichannel input is selected (page 47).
- Check the audio output settings on your DVD player.

### About DTS signals

- When playing DTS program material, using the pause, fast forward, or fast reverse function on your player may produce a short audible noise. This is not a malfunction.
- When DTS program material ends and the DTS bitstream stops, the AV receiver remains in DTS listen-

ing mode and the DTS indicator remains on. This is to prevent noise when you use the pause, fast forward, or fast reverse function on your player. If you switch your player from DTS to PCM, as the AV receiver does not switch formats immediately, you may not hear anything, in which case you should stop your player for about 3 seconds, and then resume playback.

- With some CD players, you won't be able to playback DTS material properly even though your player is connected to a digital input on the AV receiver. This is usually because the DTS bitstream has been processed (e.g., output level, sampling rate, or frequency response changed) and the AV receiver doesn't recognize it as a genuine DTS signal. In such cases, you may hear noise.

### The beginning of audio received by an HDMI IN can't be heard

- Since it takes longer to identify the format of an HDMI signal than it does for other digital audio signals, sound may not be output immediately.

## Video

### There's no picture

- Make sure that all video connecting plugs are pushed in all the way (page 27).
- Make sure that each video component is properly connected.
- On your TV, make sure that the video input to which the AV receiver is connected is selected.
- While the Pure Audio listening mode is selected, the video circuitry is turned off and only the HDMI OUT outputs video signals.
- The AV receiver does not convert between formats, so if a video source component is connected to a component video input, your TV must be connected to the component video output (page 28).
- If the video source is connected to an HDMI input, your TV must be connected to the HDMI OUT (page 28).

### There's no picture from a source connected to an HDMI IN

- Reliable operation with an HDMI-to-DVI adapter is not guaranteed. In addition, video signals from a PC are not supported (page 36).
- If the message "Resolution Error" appears on the AV receiver's display, this indicates that your TV does not support the current video resolution and you need to select another resolution on your DVD player.

### Tuner

#### Reception is noisy, stereo FM reception suffers from hiss, or the FM STEREO indicator doesn't light up

- Relocate your antenna.
- Move the AV receiver away from your TV or computer.
- When listening to an AM station, operating the remote controller may cause noise.
- Passing cars and airplanes can cause interference.
- Concrete walls weaken radio signals.
- If nothing improves the reception, install an outdoor antenna.

### Remote Controller

#### The remote controller doesn't work

- Make sure that the batteries are installed with the correct polarity (page 20).
- Make sure that the remote controller is not too far away from the AV receiver and there's no obstruction between the remote controller and the AV receiver's remote control sensor (page 20).
- Make sure you've selected the correct remote controller mode.
- Make sure you've entered the correct remote control code (page 82).

#### Can't control other components

- Make sure you've selected the correct remote controller mode.
- If you've connected an **RI**-capable Onkyo MD recorder or CD recorder to the TAPE IN/OUT jacks, or to the CBL/SAT IN jacks, for the remote controller to work properly, you must set the Input Display to MD or CDR, respectively (see page 46).
- The entered remote control code may not be correct. If more than one code is listed, try each one.
- With some AV components, certain buttons may not work as expected, and some may not work at all.
- To control an Onkyo component that's connected via **RI**, point the remote controller at the AV receiver. Be sure to enter the appropriate remote control code first (page 83).
- To control an Onkyo component that's not connected via **RI**, or another manufacturer's component, point the remote controller at that component. Be sure to enter the appropriate remote control code first (page 82).

### Recording

#### Can't record

- On your recorder, make sure the correct input is selected.
- To prevent signal loops and damage to the AV receiver, input signals are not fed through to outputs

with the same name (e.g., TAPE IN to TAPE OUT or VCR/DVR IN to VCR/DVR OUT).

### Others

#### The sound changes when I connect my headphones

- When a pair of headphones is connected, the listening mode is set to Stereo, unless it's already set to Stereo, Mono, or Direct, in which case it stays the same.

#### How do I change the language of a multiplex source

- On the "Audio Adjust" menu, change the "Input (Mux)" setting to Main or Sub (page 74).

#### The **RI** functions don't work

- To use **RI**, you must make an **RI** connection and an analog audio connection (RCA) between the component and AV receiver, even if they are connected digitally (page 40).

#### The following settings can be made for the S-Video and composite video inputs

You must use the buttons on the unit to make these settings.

1. While holding down the input selector button for the input source that you want to set, press the [SETUP] button.
2. Use the Left and Right [◀]/[▶] buttons to change the setting.
3. Press the [SETUP] button when you've finished.

- **Video Attenuation**

This setting can be made for the DVD, VCR/DVR, CBL/SAT, or AUX input.

If you have a games console connected to the S-Video or composite video input, and the picture isn't very clear, you can attenuate the gain.

**Video ATT:0:** (default).

**Video ATT:2:** Gain is reduced by 2 dB.

The AV receiver contains a microcomputer for signal processing and control functions. In very rare situations, severe interference, noise from an external source, or static electricity may cause it to lockup. In the unlikely event that this happens, unplug the power cord from the wall outlet, wait at least 5 seconds, and then plug it back in again.

Onkyo is not responsible for damages (such as CD rental fees) due to unsuccessful recordings caused by this unit's malfunction. Before you record important data, make sure that the material will be recorded correctly.

Before disconnecting the power cord from the wall outlet, set the AV receiver to Standby.

# Specifications

## HT-R560

### Amplifier Section

Rated Output Power	
North American:	<b>130 watts minimum continuous power per channel, 8 ohm loads, 1 channel driven, with a maximum total harmonic distortion of 1.0% (FTC)</b>
European:	7 ch × 130 W at 8 ohms, 1kHz, 1 ch driven (IEC)
Dynamic Power	210 W (3Ω, Front) (1 ch driven) 190 W (4Ω, Front) (1 ch driven) 130 W (8Ω, Front) (1 ch driven)
THD (Total Harmonic Distortion)	0.08% (1kHz 1W) (Power Rated)
Damping Factor	60 (Front, 1kHz, 8Ω)
Input Sensitivity and Impedance	200 mV/ 47 kΩ (LINE)
Output Level and Impedance	200 mV/ 2.2 kΩ (REC OUT)
Frequency Response	5Hz–100kHz/ +1 dB–3 dB
Tone Control	±10 dB, 50Hz (BASS) ±10 dB, 20kHz (TREBLE)
Signal to Noise Ratio	100 dB (LINE, IHF-A)
Speaker Impedance	8Ω–16Ω

### Video Section

Input Sensitivity/Output Level and Impedance	1 Vp-p /75Ω (Component and S-Video Y) 0.7 Vp-p /75Ω (Component Pb/Cb, Pr/Cr) 0.28 Vp-p /75Ω (S-Video C) 1 Vp-p /75Ω (Composite)
Component Video	
Frequency Response	5Hz – 50MHz, –3 dB

### Tuner Section

#### ■ FM

Tuning Frequency Range	
North American:	87.50MHz–107.90MHz
European:	87.50MHz–108.00MHz

#### ■ AM

Tuning Frequency Range	
North American:	530kHz–1710kHz
European:	522kHz–1611kHz

Preset Channel	40
----------------	----

### General

Power Supply	
North American:	AC 120 V, 60Hz
European:	AC 230 V, 50Hz
Power Consumption	
North American:	4.9 A
European:	480 W
Dimensions (W × H × D)	435 × 150 × 377 mm 17-1/8" × 5-7/8" × 14-13/16"
Weight	
North American:	9.8 kg 21.63 lbs.
European and Asian:	10.6 kg 23.40 lbs.

#### ■ Video Inputs

HDMI (Assignable)	IN 1, IN 2, IN 3
Component	IN 1, IN 2
Composite	DVD, CBL/SAT, VCR/DVR, AUX
S-Video	DVD, VCR/DVR, CBL/SAT

#### ■ Video Outputs

HDMI	OUT
Component	OUT
Composite	MONITOR, VCR/DVR
S-Video	MONITOR, VCR/DVR

#### ■ Audio Inputs

Digital Inputs (Assignable)	1 (VCR/DVR), 2 (CD) (Rear OPT)-(Front OPT) 1 (DVD), 2 (CBL/SAT) (Rear coax)
Analog Inputs	DVD (MULTI CH), VCR/DVR, CBL/SAT, TAPE, CD, AUX, DOCK
Multichannel Inputs	7.1 ch

#### ■ Audio Outputs

Analog Outputs	VCR/DVR, TAPE
Subwoofer Pre Outputs	1
Speaker Outputs	SP-A (L, R), C, SL, SBL, SBR, SP-B (L, R)
Phones	PHONES

#### ■ Control Terminal

MIC	Yes
-----	-----

Specifications and features are subject to change without notice.

## 7.1ch Home Theater Speaker Package

### ■ Subwoofer (SKW-560)

Type:	Bass-reflex
Input sensitivity/Impedance:	140 mV/20 kΩ
Maximum output power:	290 W
Frequency response:	25 Hz–150 Hz
Cabinet capacity:	1.34 cubic feet (38 L)
Dimensions (W × H × D):	283 × 498 × 399 mm (11-1/8" × 19-5/8" × 15-11/16") (incl. grille and projection)
Weight:	11.5 kg (25.4 lbs.)
Drivers unit:	25 cm Cone
Power supply	
North American:	AC 120 V/ 60 Hz
European:	AC 220-230 V/ – 50 Hz
Power consumption	
North American:	163 W
European:	202 W

### ■ Front Speaker (SKF-560F)

Type:	2 Way Bass-reflex
Impedance:	8 Ω
Maximum input power:	130 W
Sensitivity:	85 dB/W/m
Frequency response:	35 Hz–50 kHz
Crossover frequency:	4 kHz
Cabinet capacity:	0.24 cubic feet (6.9 L)
Dimensions (W × H × D):	155 × 371 × 198 mm (6-1/8" × 14-5/8" × 7-13/16") (incl. grille and projection)
Weight:	2.9 kg (6.4 lbs.)
Drivers unit:	12 cm OMF Cone (Woofer) 2.5 cm Balanced dome (Tweeter)
Terminal:	Spring type color coded
Keyhole slot:	1
Grille:	Detachable
Other:	Magnetic shielding

### ■ Center Speaker (SKC-560C)

Type:	2 Way Bass-reflex
Impedance:	8 Ω
Maximum input power:	130 W
Sensitivity:	85 dB/W/m
Frequency response:	60 Hz–50 kHz
Crossover frequency:	4.5 kHz
Cabinet capacity:	0.11 cubic feet (3.2 L)
Dimensions (W × H × D):	436 × 105 × 132 mm (17-3/16" × 4-1/8" × 5-3/16") (incl. grille and projection)
Weight:	2.6 kg (5.7 lbs.)
Drivers unit:	8 cm OMF Cone (Woofer) × 2 2.5 cm Balanced dome (Tweeter)
Terminal:	Spring type color coded
Keyhole slot:	2
Grille:	Detachable
Other:	Magnetic shielding

### ■ Surround/Surround Back Speaker (SKM-560S/SKB-560)

Type:	Full-Range closed box
Impedance:	8 Ω
Maximum input power:	130 W
Sensitivity:	81 dB/W/m
Frequency response:	80 Hz–20 kHz
Cabinet capacity:	0.057 cubic feet (1.6 L)
Dimensions (W × H × D):	151 × 271 × 96 mm (5-15/16" × 10-11/16" × 3-3/4") (incl. grille and projection)
Weight:	1.3 kg (2.86 lbs.)
Drivers unit:	8 cm Cone
Terminal:	Spring type color coded
Keyhole slot:	1
Grille:	Fixed

## Dock DS-A1L

Power supply:	DC 5 V 500 mA
Consumption:	2.5 W Max.
Dimensions (W × H × D):	112 × 60 × 112 mm (4-7/16" × 2-3/8" × 4-7/16")
Weight:	0.3 kg (0.7 lbs.)

Specifications and features are subject to change without notice.

# Memo

---

---



## **ONKYO CORPORATION**

Sales & Product Planning Div. : 2-1, Nisshin-cho, Neyagawa-shi, OSAKA 572-8540, JAPAN  
Tel: 072-831-8023 Fax: 072-831-8163

### **ONKYO U.S.A. CORPORATION**

18 Park Way, Upper Saddle River, N.J. 07458, U.S.A.  
Tel: 201-785-2600 Fax: 201-785-2650 <http://www.us.onkyo.com/>

### **ONKYO EUROPE ELECTRONICS GmbH**

Liegnitzerstrasse 6, 82194 Groebenzell, GERMANY  
Tel: +49-8142-4401-0 Fax: +49-8142-4401-555 <http://www.eu.onkyo.com/>

### **ONKYO EUROPE UK Office**

Suite 1, Gregories Court, Gregories Road, Beaconsfield, Buckinghamshire, HP9 1HQ  
UNITED KINGDOM Tel: +44-(0)1494-681515 Fax: +44(0)-1494-680452

### **ONKYO CHINA LIMITED**

Unit 1&12, 9/F, Ever Gain Plaza Tower 1, 88, Container Port Road, Kwai Chung,  
N.T., HONG KONG Tel: 852-2429-3118 Fax: 852-2428-9039  
<http://www.ch.onkyo.com/>



I0804-2

SN 29344669A

(C) Copyright 2008 ONKYO CORPORATION Japan. All rights reserved.

