

# Panasonic®

Model No.

TH-L42U20K  
TH-L42U20M  
TH-L42U20R  
TH-L42U20T  
TH-L42U20X  
TH-L42U28K  
TH-L42U29K

## Operating Instructions LCD TV

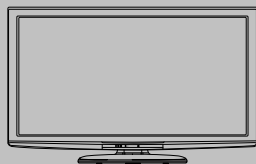

# VIERA

**FULL  
HD**  
1920x1080p

**VIERA**  
Link

**VIERA**  
IMAGE VIEWER

**SD**  
CG

**HDMI**

Thank you for purchasing this Panasonic product. Please read these instructions before operating your set and retain them for future reference. The images shown in this manual are for illustrative purposes only.

English

ZE  
TQB4GC0415-1

# Experience an amazing level of multimedia excitement

Sharp pictures with HDMI terminal  
Create home theatre and DVD recorder link-ups with "VIERA Link" without complicated settings!

## Enjoy rich multimedia

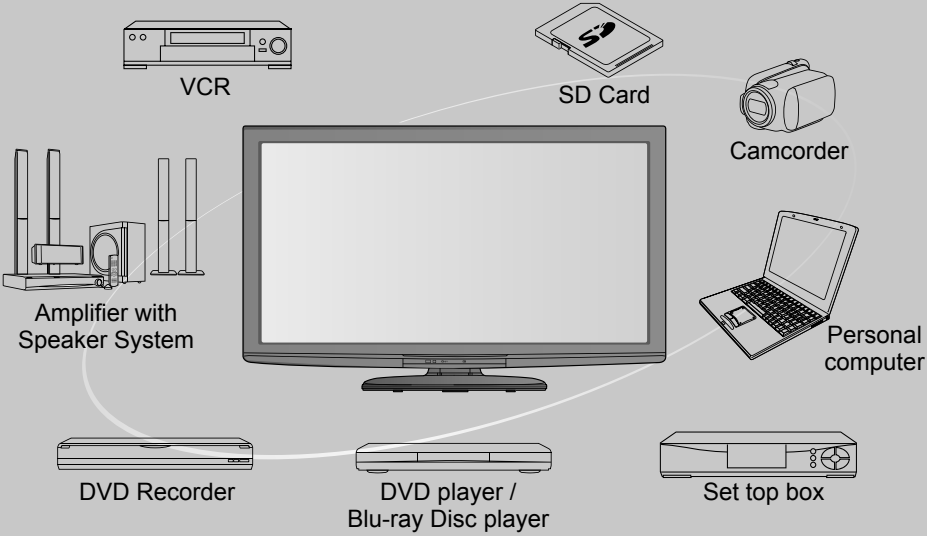

## Standard accessories

Check that you have the accessories and items shown

- Remote Control
- N2QAYB000370  
or  
N2QAYB000399



- Pedestal → p. 6

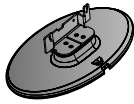

- Batteries for the Remote Control (2)
- R6 (AA)



- Pedestal hole cover sheet (only for TH-L42U20K, TH-L42U20T, TH-L42U20X, TH-L42U28K, TH-L42U29K)

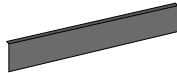

- Operating Instructions

### Caution

- This product contains possibly dangerous parts (such as plastic bags), which can be breathed in or swallowed by young children accidentally. Keep these parts out of reach of young children.

## Inserting and removing remote's batteries

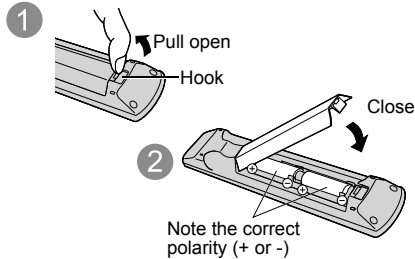

### Caution

- Incorrect installation may cause battery leakage and corrosion, resulting in damage to the remote control.
- Do not mix old and new batteries.
- Do not mix different battery types (such as alkaline and manganese batteries).
- Do not use rechargeable (Ni-Cd) batteries.
- Do not burn or breakup batteries. Batteries must not be exposed to excessive heat such as sunshine, fire or the like.
- Do not disassemble or modify the remote control.

# Contents

## Be sure to Read

- Safety Precautions ..... 4  
(Warning / Caution)

## Quick Start Guide

- Accessories / Options ..... 6
- Basic Connection ..... 8
- Identifying Controls ..... 10
- Auto Tuning ..... 12

Quick Start Guide

## Basic Features

- Watching TV ..... 13
- Viewing Teletext ..... 16
- Watching External inputs ..... 18

Basic

## Advanced Features

- How to Use Menu Functions ..... 20
- Tuning and Editing Channels ..... 26
- Child Lock ..... 28
- Input Labels ..... 29
- Shipping Condition (Reset settings) ..... 30
- How to Use VIERA TOOLS ..... 31
- Viewing from SD Card (VIERA IMAGE VIEWER) ..... 32
- VIERA Link Functions ..... 34
- VIERA Link "HDAVI Control™" ..... 36
- External Equipment ..... 38

Advanced

## Technical

- Technical Information ..... 40
- Maintenance ..... 46
- FAQs ..... 47
- Licence ..... 49
- Specifications ..... 50

Technical

# Safety Precautions

## Warning

### Handling the mains plug and lead

- Insert the mains plug fully into the socket outlet. (If the mains plug is loose, it could generate heat and cause fire.)
- Ensure that the mains plug is easily accessible.
- Do not touch the mains plug with a wet hand. (This may cause electrical shock.)
- Do not damage the mains lead. (A damaged lead may cause fire or electrical shock.)
  - Do not move the TV with the lead plugged in the socket outlet.
  - Do not place a heavy object on the lead or place the lead near a high-temperature object.
  - Do not twist the lead, bend it excessively, or stretch it.
  - Do not pull on the lead. Hold onto the mains plug body when disconnecting lead.
  - Do not use a damaged mains plug or socket outlet.

- TH-L42U20K/T/X, TH-L42U28K, TH-L42U29K:  
AC AUTO 110-240 V, 50 / 60 Hz
- TH-L42U20M : AC 110-240 V, 50 / 60 Hz
- TH-L42U20R : AC Single 220-240 V, 50 / 60 Hz



- Mains plug types vary between countries.



### Power source / Installation

- This TV is designed for :
  - TH-L42U20K/T/X, TH-L42U28K, TH-L42U29K :  
AC AUTO 110-240 V, 50 / 60 Hz
  - TH-L42U20M : AC 110-240 V, 50 / 60 Hz
  - TH-L42U20R :  
AC Single 220-240 V, 50 / 60 Hz
  - Table-top use

### Do not remove covers and NEVER modify the TV yourself

- Do not remove the rear cover as live parts are accessible when it is removed. There are no user serviceable parts inside. (High-voltage components may cause serious electrical shock.)
- Have the TV checked, adjusted, or repaired at your local Panasonic dealer.

### Do not expose to rain or excessive moisture

- To prevent damage which might result in electric shock or fire, do not expose this TV to rain or excessive moisture. This TV must not be exposed to dripping or splashing water and objects filled with liquid, such as vases, must not be placed on top of or above the TV.

### Do not expose to direct sunlight and other sources of heat

- Avoid exposing the TV to direct sunlight and other sources of heat. To prevent fire never place any type of candle or naked flame on top or near the TV.

### Do not insert foreign objects into the TV

- Do not allow any objects to drop into the TV through the air vents. (Fire or electrical shock may result.)

### Do not place the TV on sloped or unstable surfaces

- The TV may fall off or tip over.

### Use only the dedicated pedestals / mounting equipment

- Using an unapproved pedestal or other fixtures may make the TV unstable, risking injury. Be sure to ask your local Panasonic dealer to perform setup.
- Use approved pedestals (p. 6) / wall-hanging brackets (p. 7).

### Do not allow children to handle SD Card

- As with any small object, SD Cards can be swallowed by young children. Please remove SD Card immediately after use and store out of reach of children.

## Caution

- **This appliance is intended for use in tropical climates**
- **When cleaning the TV, remove the mains plug**
  - Cleaning an energized TV may cause electrical shock.
- **When the TV is not going to be used for a long period of time, remove the mains plug**
  - This TV will still consume some power even in the Off mode, as long as the mains plug is still connected to a live socket outlet.
- **Allow sufficient space around the TV for radiated heat**
  - When using the pedestal, keep a space between the bottom of the TV and the surface where the TV is set.
  - In case of using Wall-hanging bracket, follow the manual of it.

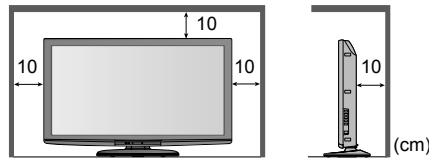

- **Do not block the rear air vents**
  - Blocked ventilation by newspapers, table cloths, curtains, etc. may cause overheating, fire or electrical shock.
- **Do not apply strong force or impact to the display panel**
  - This may cause damage resulting in injury.
- **Do not expose your ears to excessive volume from the headphones**
  - Irreversible damage can be caused.

### Notes

- **Auto power standby function**
  - If no signal is received and no operation is performed for 30 minutes, the TV will automatically go to standby mode.
- **Keep the TV away from these types of equipment**
  - Electronic equipment  
In particular, do not place video equipment near the TV. Electromagnetic interference may distort images / sound.
  - Equipment with an infrared sensor  
This TV also emits infrared rays. This may affect operation of other equipment.
- **Transport only in upright position**

### Adjust the LCD panel to your desired angle

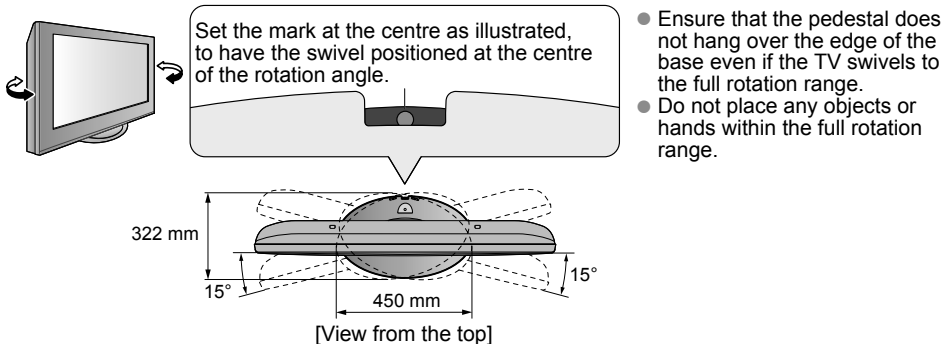

# Accessories / Options

## Attaching the pedestal

### Warning

**Do not disassemble or modify the pedestal.**

- Otherwise the TV may fall over and become damaged, and personal injury may result.

### Caution

**Do not use the pedestal for any other TV or displays.**

- Otherwise the TV or the display may fall over and become damaged, and personal injury may result.

**Do not use the pedestal if it becomes warped or physically damaged.**

- If you use the pedestal while it is physically damaged, personal injury may result. Contact your nearest Panasonic dealer immediately.

**During set-up, make sure that all screws are securely tightened.**

- If insufficient care is taken to ensure screws are properly tightened during assembly, the pedestal will not be strong enough to support the TV, and it might fall over and become damaged, and personal injury may result.

**Ensure that the TV does not fall over.**

- If the TV is knocked or children climb onto the pedestal with the TV installed, the TV may fall over and personal injury may result.

**Two or more people are required to install and remove the TV.**

- If two or more people are not present, the TV may be dropped, and personal injury may result.

Ⓐ Assembly screws (4)

Ⓑ Assembly screws (4)

Ⓒ Bracket (1)

Ⓓ Base (1)

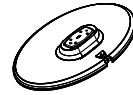

### Assembling the pedestal

Use the assembly screws Ⓐ to fasten the bracket Ⓒ to the base Ⓓ securely.

- Make sure that the screws are securely tightened.

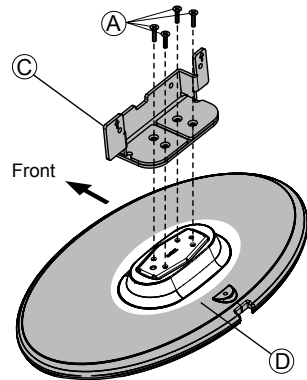

### Securing the TV

Insert the bracket into the TV, and then fasten securely with the assembly screws Ⓑ.

- Make sure that the screws are securely tightened.

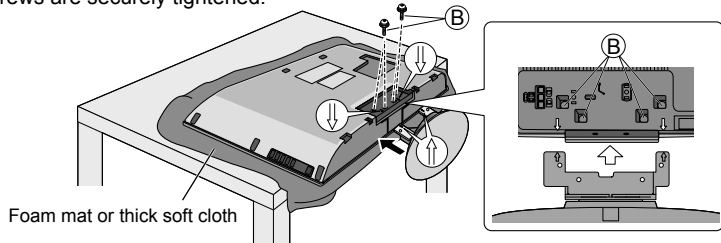

## Optional accessories

Please contact your nearest Panasonic dealer to purchase the recommended wall-hanging bracket. For additional details, please refer to the wall-hanging bracket installation manual.

Wall-hanging bracket

- TY-WK3L2RW

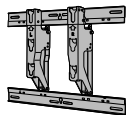

Rear of the TV

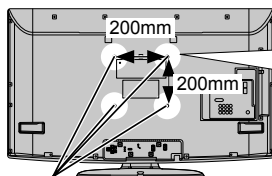

Holes for wall-hanging  
bracket installation

Screw for fixing the TV onto the wall-hanging  
bracket (not supplied with the TV)

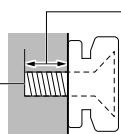

Depth of screw:  
minimum 10 mm,  
maximum 12 mm

[View from the side]

### Warning

- Using other wall-hanging brackets, or installing a wall-hanging bracket by yourself have the risk of personal injury and product damage. In order to maintain the unit's performance and safety, be absolutely sure to ask your dealer or a licenced contractor to secure the wall-hanging brackets. Any damage caused by installing without a qualified installer will void your warranty.
- Do not mount the unit directly below ceiling lights (such as spotlights, floodlights or halogen lights) which typically give off high heat. Doing so may warp or damage plastic cabinet parts.
- Take care when fixing wall brackets to the wall. Always ensure that there are no electrical cables or pipes in the wall before hanging bracket.
- To prevent fall and injury, remove the TV from its fixed wall position when it is no longer in use.

# Basic Connection

External equipment and cables shown are not supplied with this TV.  
Please ensure that the TV is disconnected from the mains socket before attaching or disconnecting any leads.

## Connecting aerial

### TV only

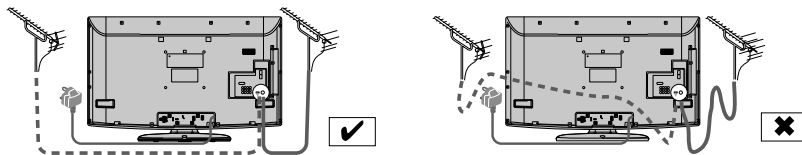
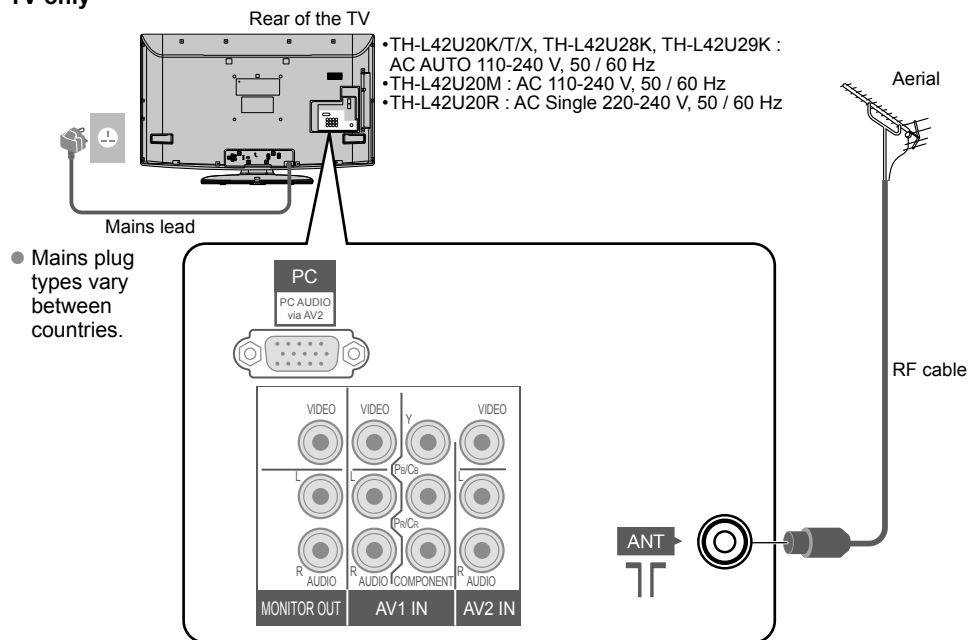

If the antenna is placed in the wrong location, interference might happen.

### Note

- Do not put the RF cable close to the mains lead to avoid noise.
- Do not place the RF cable under the TV.
- To obtain optimum quality picture and sound, an aerial, the correct cable (75  $\Omega$  coaxial) and the correct terminating plug are required.
- If a communal aerial system is used, you may require the correct connection cable and plug between the wall aerial socket and the TV.
- Your local Television Service Centre or dealer may be able to assist you in obtaining the correct aerial system for your particular area and the accessories required.
- Any matters regarding aerial installation, upgrading of existing systems or accessories required, and the costs incurred, are the responsibility of you, the Customer.
- VIERA Link connection  $\Rightarrow$  p. 34
- Read the manual of the equipment, too.
- Another equipments connection  $\Rightarrow$  p. 38, p. 39



## Connecting DVD Recorder / VCR

### TV, DVD Recorder or VCR

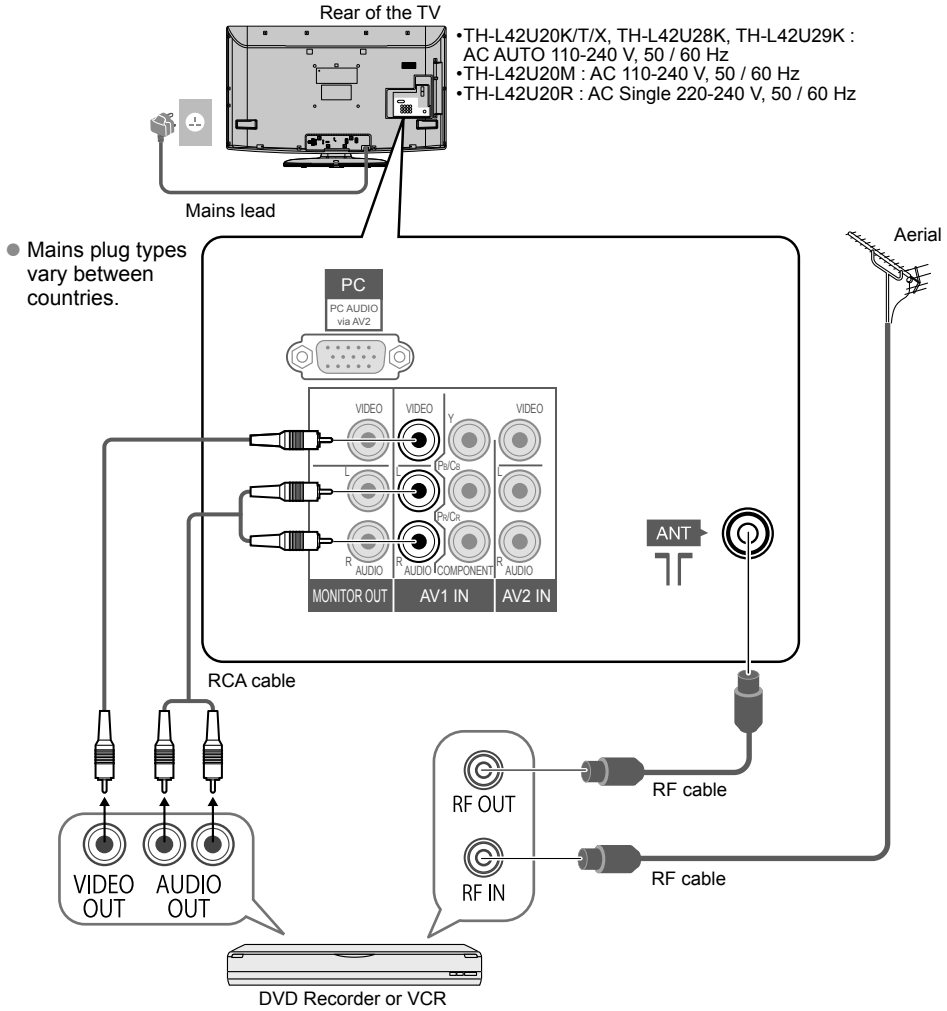

● Mains plug types vary between countries.

# Identifying Controls

## Remote control

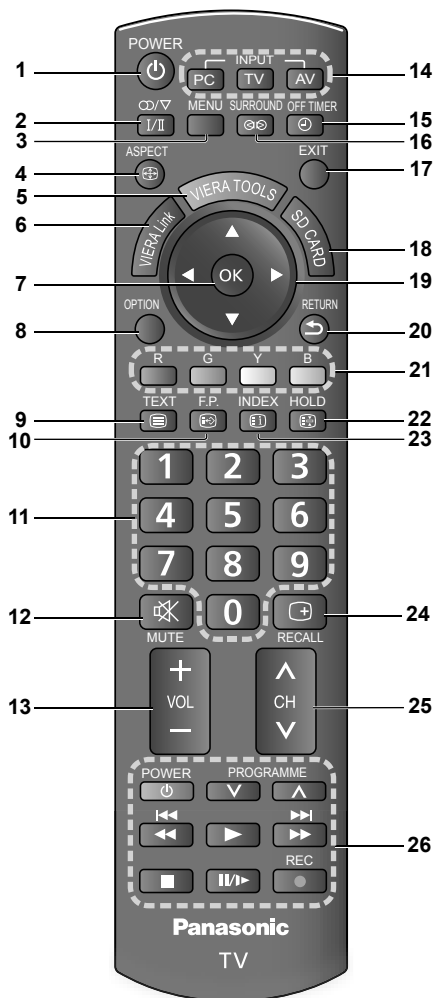

- 1 **Standby On / Off switch**
  - Switches TV On or Off standby
- 2 **Stereo / Bilingual Sound Selection (p. 41)**
- 3 **Main Menu (p. 20)**
  - Press to access Picture, Sound and Setup Menus
- 4 **Aspect (p. 15)**
  - Changes aspect ratio from Aspect Selection list
  - Also possible by pressing this button repeatedly until you reach the desired aspect

- 5 **VIERA TOOLS (p. 31)**
  - Displays some special feature icons and accesses easily
- 6 **VIERA Link (p. 34)**
  - Accesses VIERA Link Menu
- 7 **OK**
  - Confirms selections and choices
  - Press after selecting channel positions to quickly change programme
- 8 **Option Menu (p. 14)**
  - Easy setting for viewing and sound options
- 9 **Teletext (p. 16)**
  - Switches to teletext mode
- 10 **Viewing a favourite teletext channel (p. 16)**
- 11 **Numeric buttons**
  - Changes channel and teletext pages
  - When in Standby mode, switches TV On
- 12 **Sound Mute**
  - Switches sound mute On or Off
- 13 **Volume Up / Down**
- 14 **Input mode selection**
  - PC - switches to PC input mode
  - TV - switches to TV mode (p. 13)
  - AV - switches to AV input mode from Input Selection list (p. 18)
- 15 **Off Timer (p. 13)**
  - Sets the time the TV automatically turns off
- 16 **Surround (p. 23)**
  - Switches surrounding sound setting
- 17 **Exit**
  - Returns to the normal viewing screen
- 18 **SD Card (p. 32)**
  - Switches to SD Card viewing mode
- 19 **Cursor buttons**
  - Makes selections and adjustments
- 20 **Return**
  - Returns to the previous menu / page
- 21 **Coloured buttons**
  - Used for the selection, navigation and operation of various functions
- 22 **Hold**
  - Freeze / unfreeze picture (p. 13)
  - Holds the current teletext page (teletext mode) (p. 16)
- 23 **Index (p. 16)**
  - Returns to the teletext index page (teletext mode)
- 24 **Programme Information (p. 14)**
- 25 **Channel Up / Down**
  - Selects channel in sequence
- 26 **Connected equipment operations (p. 19)**

## TV

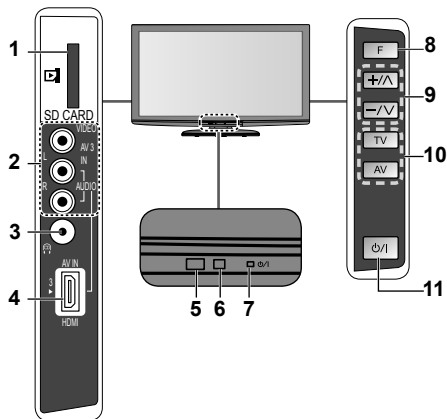

- 1 **SD card slot**
- 2 **AV3 terminals**
- 3 **Headphone jack**
- 4 **HDMI terminal**
- 5 **Remote control signal receiver**
  - Do not place any objects between the TV remote control signal receiver and remote control

### 6 **C.A.T.S. (Contrast Automatic Tracking System) sensor**

- Senses brightness to adjust picture quality when "Eco Mode" in the Picture Menu is set to "On" (p. 22)

### 7 **Power LED**

- Standby: red On: green
- When using the remote control, indicates the TV has received a command.

### 8 **Function Select**

- Volume / Backlight / Contrast / Brightness / Colour / Sharpness / Tint (NTSC mode) / Bass ("Music" or "Speech" mode in the Sound Menu) / Treble ("Music" or "Speech" mode in the Sound Menu) / Balance / "Auto Tuning" (p. 22 - 24)

- 9 Increases or decreases the channel position by one. When a function is already displayed, press to increase or decrease the selected function. When in standby mode, switches TV on.

- 10 Changes the input mode

### 11 **Mains power On / Off switch**

- Switch On to turn on the TV or turn the TV to Standby mode by the remote control

## Using the On Screen Displays

Many features available on this TV can be accessed via the On Screen Display menu.

Example (Sound Menu):

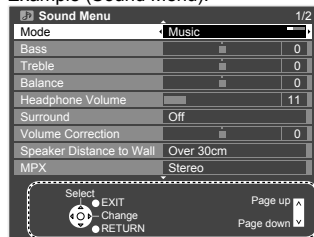

Operation guide will help you.

### How to use remote control



Open the Main Menu



Move the cursor / select the menu item



Move the cursor / adjust levels / select from a range of options



Access the menu / store settings after adjustments have been made or options have been set



Return to the previous menu



Exit the menu system and return to the normal viewing screen

# Auto Tuning

Search and store TV channels automatically.

These steps are not necessary if the setup has been completed by your local dealer.



## 1 Plug the TV into mains socket and switch On



- You can now use the remote control to turn On the TV or switch the TV to standby mode. (Power LED: On)

## 2 Select your language

OSD Language	
English	עברית
中文	Tiếng Việt
العربية	Indonesia
فارسی	Français

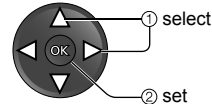

## 3 Select your area

Channel Plan	
Asia/W. Europe	
CIS/E. Europe	
China	
Hong Kong	
NZ/Indonesia	
CATV/Other	

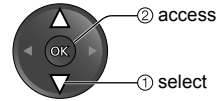

When selecting CATV/Other, press the OK button, and then select the Channel Plan from Indian CATV, South Africa, American System, American CATV or Japan.

Auto Tuning starts

Auto Tuning	
1	CH2
Scan	1   120
<input type="radio"/> EXIT <input type="radio"/> RETURN	

- Auto Tuning will start to search for TV channels and store them. The sorted channel order depends upon the TV signal, the broadcasting system and reception conditions.

## 4 Select "Home"

Please select your viewing environment.*	
Home	Shop

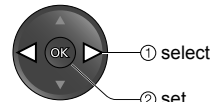

Auto Tuning is complete

### \* Viewing environment mode

Home : Recommended mode for viewing at home. Select "Home" for optimal picture / power consumption. "Viewing Mode" is set as "Normal" (p. 22).

Shop : Demonstration mode to explain main features of this TV (for in-store display). "Viewing Mode" is set as "Dynamic" (p. 22).

### To return to viewing environment selection mode if you selected "Shop"

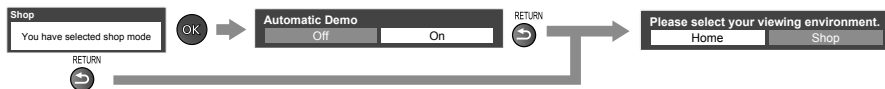

- To change viewing environment mode later on, reset all settings by accessing Shipping Condition. ➔ "Shipping Condition" (p. 30)

# Watching TV

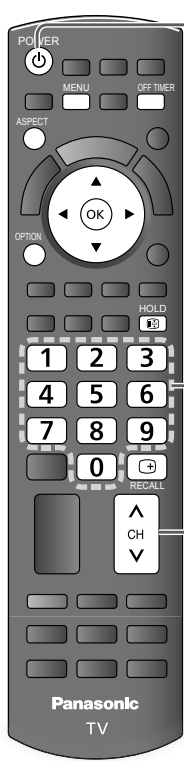

## 1 Turn power on



- Mains power On / Off switch should be On (p. 11).

## 2 Select a channel

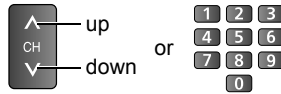

- To select the two-digit channel number, e.g. 39  
 ➔ 3 ➔ 9 (in a short time)
- If one-digit channel number  
 ➔ OK ➔ quickly changes the channel

### Note

- When the TV is switched to standby, there will be a clicking sound after a short delay. This is normal.

## Other useful functions

### Hold

HOLD



**Freeze / unfreeze picture**

### Off Timer

**Turn the TV off automatically after a fixed period of time (0 / 15 / 30 / 45 / 60 / 75 / 90 minutes)**

OFF TIMER



Press repeatedly until desired time appears.

- Also possible to set the time from "Off timer" in the Setup Menu (p. 24)
- To cancel ➔ Set to "0" or turn the TV off.
- To display the remaining time ➔ Information banner (p. 14)
- When the remaining time is within 3 minutes, the remaining time will flash on screen.

# Watching TV

## Other useful functions

### Display information banner



#### Display information banner

- Also appears when changing a channel

**Note**

- Colour system will not be displayed if it is set to "Auto".

Teletext prompt is displayed if Teletext is available

### Display the selectable settings for the current programme

OPTION



#### Check or change the current programme status instantly

- To change

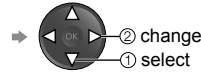

#### Channel Colour Set

Sets colour density → Picture Menu (p. 22)

#### MPX

Selects multiplex sound (if available)  
→ Sound Menu (p. 23)

#### Teletext Character Set

Sets the teletext language → Setup Menu (p. 24)

#### Volume Correction

Adjusts volume of individual programme or input mode → Sound Menu (p. 23)

### Change OSD language

You can change language for on screen displays.

**VIERA Main Menu**

- Picture
- Sound
- Setup

**Setup Menu**

- Off Timer: Off
- Child Lock
- Tuning Menu
- OSD Language: Access
- Display Settings
- VIERA Link Settings
- System Menu
- Other Settings

**OSD Language**

English	عربي
中文	Tiếng Việt
العربية	Indonesia
فارسی	Français

## Other useful functions

### Change aspect ratio

Enjoy viewing the picture at its optimum size and aspect.

ASPECT



#### Display Aspect Selection list

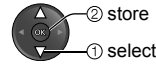
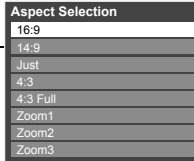

While the list is displayed, select the mode

#### To change the mode using the ASPECT button only

ASPECT



Press repeatedly until you reach the desired mode

16:9



Directly displays the image at "16:9" without distortion (anamorphic).

14:9



Displays the image at the standard "14:9" without distortion.

Just



Displays a "4:3" image full-screen. Stretching is only noticeable at the left and right edges.

4:3



Displays the image at the standard "4:3" without distortion.

4:3 Full



Displays a "4:3" image enlarged horizontally to fit the screen.  
● HD signal only

Zoom1



Displays a "16:9" letterbox or "4:3" image without distortion.

Zoom2



Displays a "16:9" letterbox (anamorphic) image full-screen without distortion.

Zoom3

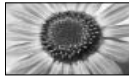

Displays a "2.35:1" letterbox (anamorphic) image full-screen without distortion. At "16:9", displays the image at its maximum (with slight enlargement).

#### Note

- Only "16:9" and "4:3" are available in PC input mode.
- Aspect is fixed to "16:9" when "Viewing Mode" is set to "Game" in the Picture Menu.
- Not available in teletext mode.
- Aspect mode can be memorized separately for each SD (Standard definition) and HD (High definition) signals.
- Aspect mode can be memorized for each input also.

# Viewing Teletext

Teletext services are the text information provided by the broadcasters. The features may vary depending on the broadcasters.

## What is FASTEXT mode?

In FASTEXT mode, four differently coloured subjects are situated at the bottom of the screen. To access more information about one of these subjects, press the appropriately coloured button. This facility enables fast access to information on the subjects shown.

## What is List mode?

In List mode, four differently coloured page numbers are situated at the bottom of the screen. Each of these numbers can be altered and stored in the TV's memory. ("Store frequently viewed pages" → p. 17)

**To change mode** → "Teletext" in Setup Menu (p. 24)

**1 Switch to Teletext**  
 TEXT • Displays Index (content varies depending on the broadcasters)

Current page number — **100** 17:51 28 Feb — Time / date  
 TELETEXT INFORMATION  
 Colour bar  
 Sub page number

( F.P. • Pressing this button while watching TV programme directly accesses to the favourite page stored in "blue". )

**2 Select the page** (up to page 899)  
 or or or (Corresponds to the colour bar)

**To return to TV**



**To adjust contrast**



## Functions (Teletext mode)

<p><b>Hold</b></p> <p> <b>Stop automatic updating</b>                  (If you wish to hold the current page without updating)</p> <p><b>To resume</b> → </p>	<p><b>Reveal hidden data</b></p> <p> →  Reveal hidden words e.g. quiz page answers</p> <p><b>To rehide</b> → </p>
<p><b>INDEX</b></p> <p> <b>Return to the main index page</b></p>	<p><b>Call up a favourite page</b></p> <p> <b>View a favourite page stored</b></p> <ul style="list-style-type: none"> <li>• Call up the page stored on the blue button (List mode).</li> <li>• Factory setting is "P103".</li> </ul>





## Functions (Teletext mode)

### View in multi window

#### Watch TV and Teletext in two windows at once

MENU (press twice) → Select teletext only or picture / teletext



- Operations can be made only in Teletext screen.

### FULL / TOP / BOTTOM

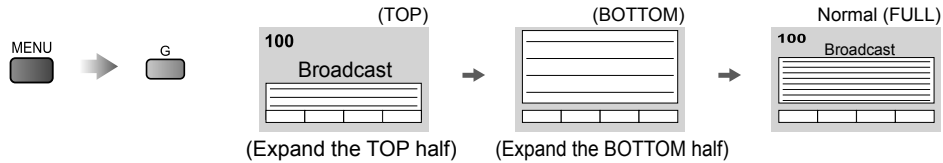

### Store frequently viewed pages

#### Store frequently viewed pages in the colour bar (List mode only)



#### To change stored pages

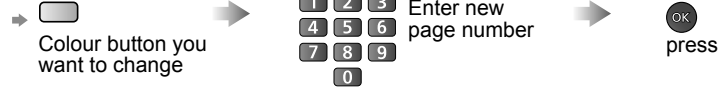

### View sub page

#### View sub page (Only when teletext is more than one page)



#### To view specific sub page

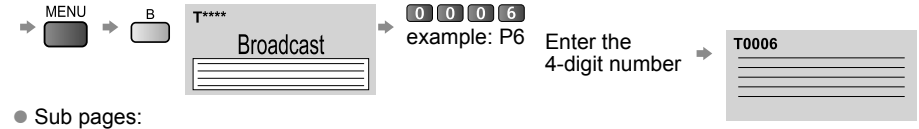

- Sub pages:  
The number of sub pages varies depending on the broadcasters.  
It may take some time for searching, during which time you can watch TV.

### Watch TV while waiting for update

#### View the TV picture while searching for a teletext page

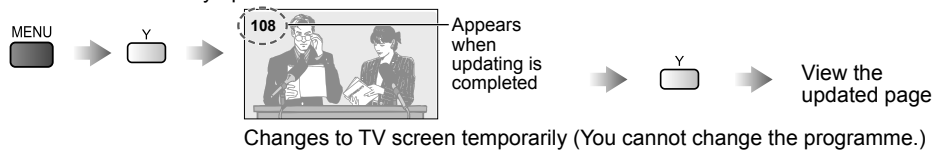

- The news page provides a function that indicates arrival of latest news ("News Flash").



# Watching External inputs

Connect the external equipment (VCRs, DVD equipment, PC, etc.) and you can watch through the input.

- To connect the equipment → p. 38, 39

The Remote Control is capable of operating some functions of selected external equipment. For details, see the manual of the equipment or ask your local dealer.

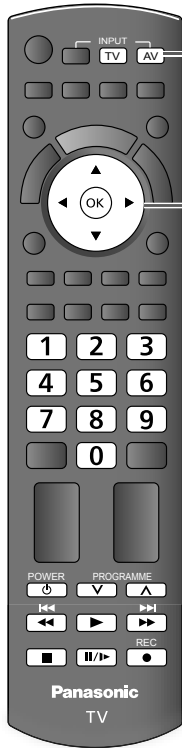

## 1 Display the input selection menu

AV

## 2 Select the input mode of the connected equipment

- You can also select the input using the AV button on the remote control or the side panel of the TV (p. 11). Press the button repeatedly until the desired input is selected.
- You can label or skip each input mode → “Input Labels” (p. 29). Skipped inputs will not be displayed when the AV button is pressed.

### Example (AV2)

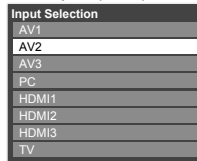

### Example (PC)

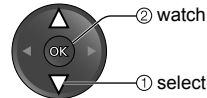
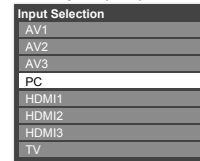

## 3 View

The selected mode is displayed on the screen.

### Example (AV2)

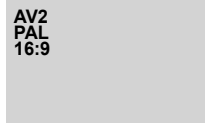

- If the external equipment has an aspect adjustment function, set to “16:9”.

### Example (PC)



- You can also listen to PC sound with the audio cable connected.
- You can setup some functions, Advanced PC Settings (p. 22) in Picture Menu and PC setup (p. 24) in Setup Menu.
- For HDMI-compatible PC (p. 42, 43), possible to connect to HDMI terminals (HDMI1 / HDMI2 / HDMI3) by using HDMI cable.

To return to TV



## Operating the equipment with the TV remote control

The equipment connected to the TV can be directly operated with the below buttons of this TV remote control.

	<b>Standby</b> Set to Standby mode / Turn on
	<b>Play</b> Playback videocassette / DVD
	<b>Stop</b> Stop the operations
	<b>Rewind / Skip / Search</b> VCR: Rewind, view the picture rapidly in reverse DVD: Skip to the previous track or title Press and hold to search backward
	<b>Fast-forward / Skip / Search</b> VCR: Fast-forward, view the picture rapidly forward DVD: Skip to the next track or title Press and hold to search forward
	<b>Pause</b> Pause / Resume DVD: Press and hold to play at slow speed
	<b>Programme Up / Down</b> Select programme
	<b>Record</b> Start recording



### How to change the code for each equipment

Each type of Panasonic equipment has its own remote control code.

Please change the code for each equipment you want to operate.

If you operate the connected equipment in VIERA Link (p. 34), select the code "73".

Press and hold  during the following operations

Enter the appropriate code  → Press 

Type of equipment	Code
DVD Recorder / DVD Player	70 (default)
Player theatre / Blu-ray Disc theatre	71
VCR	72
The equipment using in VIERA Link → "VIERA Link Control" (p. 36)	73

#### Note

- Confirm if the remote control works correctly after changing the code.
- The codes may be reset to default values if batteries are replaced.
- Some operations may not be possible on some equipment models.

# How to Use Menu Functions

Various menus allow you to make settings for the picture, sound, and other functions.

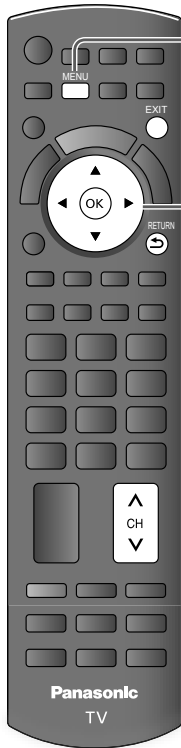

## 1 Display the menu



- Displays the functions that can be set (varies according to the input signal)

## 2 Select the menu

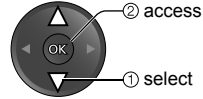

## 3 Select the item

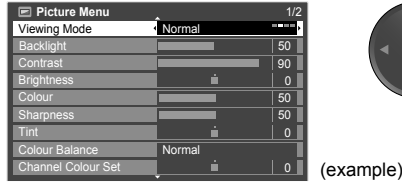

## 4 Adjust or select

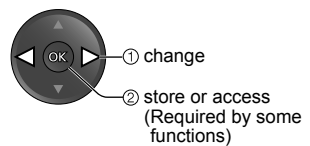
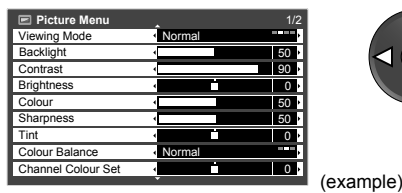

### To return to TV at any time



### To return to the previous screen



### To change menu pages

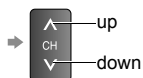

### Choose from among alternatives

Number and positions of alternatives

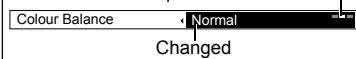

### Adjust using the slide bar

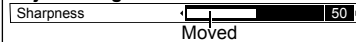

### Go to the next screen

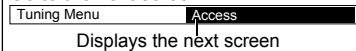

### To reset the settings

- To reset the picture settings only  
➔ "Reset to Defaults" in Picture Menu (p. 22)
- To reset the sound settings only  
➔ "Reset to Defaults" in Sound Menu (p. 23)
- To reset all settings  
➔ "Shipping Condition" (p. 25) in Setup Menu

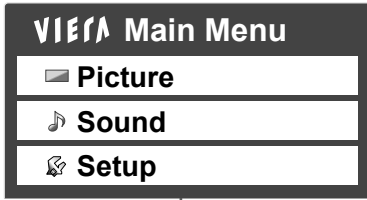

**Picture** (p. 22)

**Picture Menu** 1/2

Viewing Mode	Normal
Backlight	50
Contrast	90
Brightness	0
Colour	50
Sharpness	50
Tint	0
Colour Balance	Normal
Channel Colour Set	0

**Picture Menu** 2/2

Eco Mode	Off
P-NR	Off
3D-COMB	On
Advanced PC Settings	Access
Reset to Defaults	Reset

**Sound** (p. 23)

**Sound Menu** 1/2

Mode	Music
Bass	0
Treble	0
Equalizer	Access
Balance	0
Headphone Volume	11
Surround	Off
Volume Correction	0
Speaker Distance to Wall	Over 30cm
MPX	Stereo

**Sound Menu** 2/2

HDMI1 Input	Digital
Reset to Defaults	Reset

**Setup** (p. 24, 25)

**Setup Menu**

PC Setup	Access
Off Timer	Off
Child Lock	Access
Tuning Menu	Access
OSD Language	Access
Display Settings	Access
VIERA Link Settings	Access
System Menu	Access
Other Settings	Access

**Tuning Menu**

Channel List Edit	Access
Auto Tuning	Access
Manual Tuning	Access

(p. 24)

**OSD Language**

English	ภาษาไทย
中文	Tiếng Việt
العربية	Indonesia
فارسی	Français

(p. 24)

**Display Settings**

Teletext	FASTEXT
Teletext Character Set	English
Input Labels	Access
Playing Time Display	On

(p. 24)

**VIERA Link Settings**

VIERA Link	On
Power on Link	Off
Power off Link	On
Standby Power Save	Off
Intelligent Auto Standby	Off

(p. 24)

**System Menu**

Shipping Condition	Access
Software Licence	Access
System Information	Access

(p. 25)

**Other Settings**

AV Colour System	Auto
Colour Matrix	SD
Auto Standby	Off
Power Save	Off
16:9 Overscan	On

(p. 25)

● Depending on the received signals, available items are varied.



## Menu list

Menu	Item	Adjustments / Configurations (alternatives)	
Picture	Viewing Mode	<p>Basic picture mode (<b>Dynamic / Normal / Cinema / Game</b>)            In each Viewing Mode, Backlight, Contrast, Brightness, Colour, Sharpness, Tint, Colour Balance, Eco Mode and 3D-COMB can be adjusted and stored to suit your particular viewing requirement.</p> <ul style="list-style-type: none"> <li>● Set for each input signal.</li> </ul> <p>Dynamic : Provides enhanced picture contrast and sharpness when viewing in a bright room</p> <p>Normal : Recommended for viewing under normal ambient room lighting conditions.</p> <p>Cinema : For watching movies in a darkened room with improving the performance of contrast, black and colour reproduction</p> <p>Game : Fast response signal specifically to provide suitable images for playing games</p> <ul style="list-style-type: none"> <li>● Not valid on TV mode</li> <li>● A continuous record of time spent using Game mode can be displayed in the top right of the screen.               <ul style="list-style-type: none"> <li>➔ "Playing Time Display" (p. 24)</li> </ul> </li> </ul> <ul style="list-style-type: none"> <li>● When SD Photo input is selected, the picture mode options will be (<b>Dynamic / Normal / Photo</b>)</li> </ul>	
	Backlight, Contrast, Brightness, Colour, Sharpness	Increases or decreases the levels of these options according to your personal preference	
	Tint	<p>With an NTSC signal source connected to the TV, the picture hue can be adjusted to suit your taste.</p> <ul style="list-style-type: none"> <li>● For NTSC or Component / HDMI input signal reception only</li> </ul>	
	Colour Balance	<p>Allows you to set the overall colour tone of the picture (<b>Cool / Normal / Warm</b>)</p>	
	Channel Colour Set	<p>Colour density varying between broadcast channels can be adjusted to three levels for each reception channel</p> <ul style="list-style-type: none"> <li>● Select the channel you want to adjust and set this function.</li> </ul>	
	Eco Mode	<p>Automatically adjusts the screen brightness appropriately as the surrounding light level lowers to reduce the power consumption (<b>Off / On</b>)</p> <ul style="list-style-type: none"> <li>● Not available in Shop mode (Dynamic picture mode)</li> </ul>	
	P-NR	<p>Picture Noise Reduction</p> <p>Automatically reduces unwanted picture noise and flicker noise in the contoured parts of a picture (<b>Off / Min / Mid / Max</b>)</p> <ul style="list-style-type: none"> <li>● Not valid on PC signal</li> </ul>	
	3D-COMB	<p>Makes still or slow moving pictures look more vivid (<b>Off / On</b>)</p> <ul style="list-style-type: none"> <li>● Occasionally, while viewing still or slow moving pictures, colour patterning may be seen. Set to "On" to display sharper and more accurate colours.</li> <li>● For PAL or NTSC signal reception only</li> <li>● Not valid on Component, PC, HDMI and SD Card</li> </ul>	
	Advanced PC Settings	R-Gain, G-Gain, B-Gain	Adjusts each gain
		Gamma	Changes the gamma curve ( <b>2.0 / 2.2 / 2.5</b> )
Reset to Defaults		Press the OK button to reset the present Advanced PC Settings to the default.	
	Reset to Defaults	Press the OK button to reset the present Picture Menu settings to the default.	



Menu	Item	Adjustments / Configurations (alternatives)
Sound	Mode	<p>Basic sound mode (<b>Music / Speech / User</b>)</p> <ul style="list-style-type: none"> <li>● The selected mode affects all input signals.</li> </ul> <p>Music : Improves sound quality for watching music video, etc.</p> <p>Speech : Improves sound quality for watching news, drama, etc.</p> <ul style="list-style-type: none"> <li>● In Music and Speech mode, you can adjust “Bass” and “Treble” settings, and those settings will be stored for each mode.</li> </ul> <p>User : Adjusts the sounds manually by using the equalizer to suit your favourite sound quality.</p> <ul style="list-style-type: none"> <li>● For the User mode, “Equalizer” will appear on the Sound Menu instead of “Bass” and “Treble”. Select the “Equalizer” and adjust the frequency. ➔ “Equalizer” (below)</li> </ul>
	Bass	Increases or decreases level to enhance or minimise lower, deeper sound output
	Treble	Increases or decreases level to enhance or minimise sharper, higher sound output
	Equalizer	<p>Adjusts the frequency level to suit your favourite sound quality</p> <ul style="list-style-type: none"> <li>● Select the frequency and change the frequency level by using the cursor button.</li> <li>● If you want to enhance the bass sound, raise the level of the lower frequency. If you want to enhance the treble sound, raise the level of the higher frequency.</li> <li>● To reset the levels of each frequency to the default settings, select the “Reset to Defaults” by using cursor button, and then press the OK button.</li> </ul>
	Balance	Adjusts the volume level of right and left speakers
	Headphone Volume	Adjusts the volume of the headphones
	Surround	<p>Surround sound settings (<b>Off / V-Audio</b>)</p> <p>V-Audio : Provides a dynamic enhancer of width to simulate improved spatial effects</p> <ul style="list-style-type: none"> <li>● Switching is also possible by the Surround button on the remote control (p. 10).</li> </ul>
	Volume Correction	Adjusts the volume of individual channel or input mode
	Speaker Distance to Wall	<p>Adjusts the low frequency sound (<b>Over 30cm / Up to 30cm</b>)</p> <ul style="list-style-type: none"> <li>● If the back space between the TV and wall is over 30 cm, “Over 30cm” is recommended.</li> <li>● If the back space between the TV and wall is within 30 cm, “Up to 30cm” is recommended.</li> </ul>
	MPX	<p>Selects multiplex sound mode (if available) (p. 41)</p> <ul style="list-style-type: none"> <li>● Normally : Stereo</li> <li>● Stereo signal cannot be received: Mono</li> <li>● M1 / M2 : Available while mono signal is transmitted</li> </ul>
HDMI1 / 2 / 3 Input	<p>Select to fit the input signal (<b>Digital / Analogue</b>) (p. 42).</p> <p>Digital : HDMI cable connection</p> <p>Analogue : HDMI-DVI adapter cable connection</p> <ul style="list-style-type: none"> <li>● HDMI input mode only</li> </ul>	
Reset to Defaults	Press the OK button to reset the present settings of Mode, Balance, Headphone Volume, and Surround in Sound Menu to the default.	



Menu	Item	Adjustments / Configurations (alternatives)	
Setup	PC Setup	<b>Input Resolution</b> Switches to a wide view ● VGA (640 × 400 pixels), VGA (640 × 480 pixels), WVGA (852 × 400 pixels), WVGA (852 × 480 pixels), XGA (1,024 × 768 pixels), WXGA (1,280 × 768 pixels), 1,366 × 768 pixels ● Options change depending on signals	
		<b>Clock</b> Set to the minimum level if noise occurs.	
		<b>H-pos</b> Adjusts horizontal position	
		<b>V-pos</b> Adjusts vertical position	
		<b>Clock Phase</b> Eliminates flicker and distortion ● Adjust after Clock adjustment ● Set to the minimum level if noise occurs	
		<b>Sync</b> PC sync signal type ( <b>H &amp; V / On Green</b> ) H & V : by the horizontal and vertical signals from your PC On Green : by green signal from your PC	
		<b>Reset to Defaults</b> Press the OK button to reset the present PC Setup settings to the default.	
	<b>Off Timer</b> Sets the time the TV automatically goes to Standby mode ( <b>Off / 15 / 30 / 45 / 60 / 75 / 90 minutes</b> ) (p. 13)		
	<b>Child Lock</b> Locks a channel / AV input to prevent access to it (p. 28)		
	Tuning Menu	<b>Channel List Edit</b> Skips the unwanted channels or edits channels (p. 27)	
		<b>Auto Tuning</b> Sets TV channels automatically (p. 27)	
		<b>Manual Tuning</b> Sets the TV channels manually (p. 27)	
	<b>OSD Language</b> Changes language for on screen displays ( <b>English / 中文 / العربية / فارسی / ភាសាខ្មែរ / Tiếng Việt / Indonesia / Français</b> )		
	Display Settings	<b>Teletext</b> Teletext display mode ( <b>FASTEXT / List</b> ) (p. 16)	
		<b>Teletext Character Set</b> Selects teletext language ( <b>English / CIS / E.Europe / Persian</b> )	
		<b>Input Labels</b> Labels or skips each input terminal (p. 29)	
		<b>Playing Time Display</b> Set to "On" to display a continuous record of time spent using Game mode every 30 mins ( <b>Off / On</b> ) ● This function is available when "Game" is selected in "Viewing Mode" (p. 22).	
	VIERA Link Settings	<b>VIERA Link</b> Sets to use VIERA Link functions ( <b>Off / On</b> ) ● VIERA Link functions become available when "VIERA Link" is set to "On" (p. 35).	
		<b>Power on Link</b> Sets to use Power on Link functions ( <b>Off / On</b> ) (p. 35)	
<b>Power off Link</b> Sets to use Power off Link functions ( <b>Off / On</b> ) (p. 35)			
<b>Standby Power Save</b> Controls the power consumption in Standby mode of the connected equipment to reduce the power consumption ( <b>Off / On</b> ) (p. 35) ● This function is available when "VIERA Link" is set to "On" and "Power off Link" is set to "On".			
<b>Intelligent Auto Standby</b> Makes non-watched or non-used connected equipment go into Standby mode to reduce the power consumption ( <b>Off / On (With reminder) / On (No reminder)</b> ) (p. 35) ● This function is available when "VIERA Link" is set to "On".			



Menu	Item	Adjustments / Configurations (alternatives)	
Setup	System Menu	<b>Shipping Condition</b>	Resets all settings to the original condition (p. 30)
		<b>Software Licence</b>	Displays the software licence information
		<b>System Information</b>	Displays the system information of this TV
	Other Settings	<b>AV Colour System</b>	Selects optimum colour system based on video signals in AV mode <b>(Auto / PAL / SECAM / M.NTSC / NTSC)</b>
		<b>Colour Matrix</b>	Available only with 480p or 576p input on video signals in a natural colour from digital equipment connected to AV1 component or HDMI1 / HDMI2 / HDMI3 terminals. Select SD or HD to adjust suitable colour parameters for SD (standard definition) or HD (high definition) <ul style="list-style-type: none"> <li>● SD: Input signal is a normal TV system</li> <li>● HD: Input signal is a high definition system</li> </ul>
		<b>Auto Standby</b>	Sets the time the TV automatically goes to Standby mode when no operation is performed for the selected times <b>(Off / 2 hours / 4 hours)</b> <ul style="list-style-type: none"> <li>● Inserting the SD Card to the card slot does not affect this function.</li> <li>● Automatic input switching with the connected equipment affects this function and time-count will be reset.</li> <li>● The notification message will appear 3 minutes before going to Standby mode.</li> </ul>
		<b>Power Save</b>	Reduces brightness of picture to economise on power consumption <b>(Off / On)</b>
<b>16:9 Overscan</b>	Selects the screen area for displaying the image <b>(Off / On)</b> On: Enlarges the image to hide the edge of the image Off: Displays the image in the original size <ul style="list-style-type: none"> <li>● Set to "On" if noise is generated on the edges of the screen.</li> <li>● This function is available when aspect is set to "16:9".</li> <li>● This function can be memorized separately for SD (Standard Definition) and HD (High Definition) signals.</li> </ul>		

- A different menu will be displayed in the mode of SD Card (p. 32-33).
- Only available items can be selected.

# Tuning and Editing Channels

You can make Auto Tuning, skipping unwanted channels, etc.

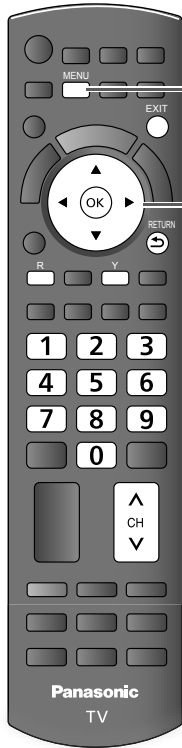

## 1 Display the menu



## 2 Select "Setup"

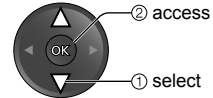
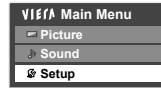

## 3 Select "Tuning Menu"

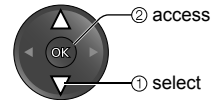
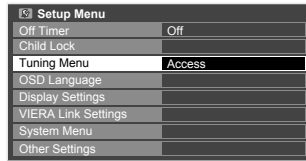

## 4 Select a function

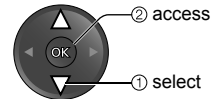
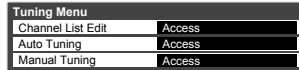

• For details → p. 27

## 5 Set (see next page)

To return to TV



### For Auto Tuning, using the buttons on the side panel of the TV (p. 11)

① Press repeatedly until "Auto Tuning" appears



② Access "Auto Tuning"



③ Start "Auto Tuning"

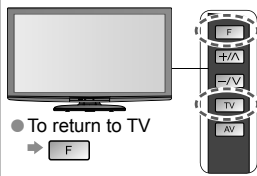

• To return to TV



## Channel List Edit | Skip unwanted channels

### Select a channel and reveal / hide

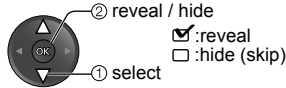
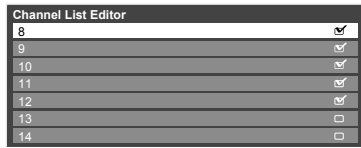

You can hide unwanted channels. The hidden channels cannot be displayed except in this function. Use this function to skip unwanted channels.

- To reveal all channels →  Y
- To retune selected channel (Manual Tuning) →  R

## Auto Tuning | Set all TV channels automatically

### Start Auto Tuning

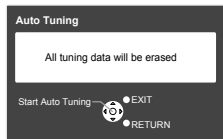

### Settings are made automatically



Automatically retune all TV channels received in the area.

- All the previous tuning settings are erased.
- When the operation is completed, the channel at channel position "1" will be displayed.
- Search begins in the order from the lower channels to the higher channels. Channels received during this process are added to the list (see above).
- If tuning has not been done completely → "Manual Tuning" (see below)

## Manual Tuning | Set TV channel manually

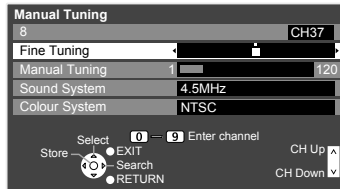

### Fine Tuning

- Use to make small adjustments to the tuning of an individual channel (affected by weather conditions, etc.)

### Manual Tuning

Set channel manually after Auto Tuning.

- Set Sound System and Colour System, and then perform this function. Set Colour System "Auto" normally.
- If a VCR is connected only with the RF cable, select channel position "0".

Select a channel position



Select a channel



Search and store

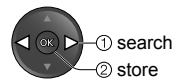

# Child Lock

You can lock specific channels / AV input terminals and control who watches them. When the locked channel / input is selected, a message appears; by entering the PIN number, you can watch it.

- 1 Display the menu**  
MENU
- 2 Select "Setup"**  
VIERA Main Menu  
Picture  
Sound  
Setup
- 3 Select "Child Lock"**  
Setup Menu  
Off Timer Off  
Child Lock Access  
Tuning Menu  
OSD Language  
Display Settings  
VIERA Link Settings  
System Menu  
Other Settings
- 4 Set (see below)**

To return to TV



## Child Lock Control channel audience

### 1 Enter the PIN number (4 digits)



- Enter the PIN number twice at first setting.
- Make a note of the PIN number in case you forget it.

### 2 Select "Child Lock List"



### 3 Select the channel / input to be locked

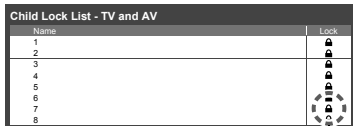

- To cancel  
➔ Select the locked channel / input  
➔ OK
- To lock all ➔ G
- To cancel all locks ➔ Y

Appears when the channel / input is locked

### To change the PIN number

Select "Change PIN" in "Child Lock" and enter a new PIN number twice.

#### Note

- Performing "Shipping Condition" (p. 30) erases the PIN number and all settings.

# Input Labels

For easier identification and selection of the input mode, you can label each input terminals or skip terminal that is not connected to any equipment.

- To select the input mode → p. 18

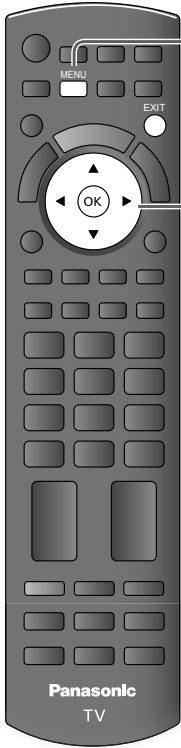

## 1 Display the menu



## 2 Select "Setup"

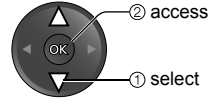
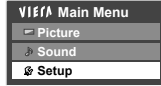

## 3 Select "Display Settings"

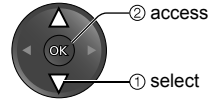
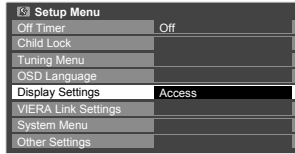

## 4 Select "Input Labels"

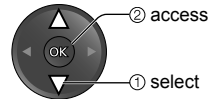

## 5 Select an input terminal and set

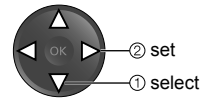
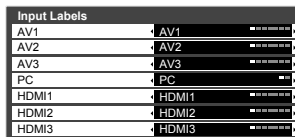

To return to TV  
EXIT  
→

The labels you set will be displayed in "Input Selection" menu (p. 18) or banner.

- If "Skip" is selected, you cannot select the mode.

# Shipping Condition (Reset settings)

Resets the TV to its original condition, i.e. no channels tuned in. All settings are reset (channels, picture, sound settings, etc.).

- 1 **Display the menu**  
MENU
- 2 **Select "Setup"**  

VIERA Main Menu	
Picture	
Sound	
<b>Setup</b>	
- 3 **Select "System Menu"**  

Setup Menu	
Off Timer	Off
Child Lock	
Tuning Menu	
OSD Language	
Display Settings	
VIERA Link Settings	
<b>System Menu</b>	Access
Other Settings	
- 4 **Select "Shipping Condition"**  

System Menu	
<b>Shipping Condition</b>	Access
Software Licence	
System Information	
- 5 **Set (see below)**

To return to TV



### Shipping Condition Reset Settings

- 1 **Check the message and reset**  

Shipping Condition	
All tuning data will be erased	
Are you sure?	
Are you sure?	
Confirm	EXIT
OK	RETURN

  - OK (confirm)
  - OK (confirm)
  - OK (start Shipping Condition)
- 2 **Follow the on screen instructions**  

Reset to Factory Shipping Condition Completed.	
Please switch off TV.	

  - "Auto Tuning" will automatically start when Mains power On / Off switch is next turned On (p. 12).

• To retune TV channels only, e.g. after moving house  
 ➔ "Auto Tuning" in "Tuning and Editing Channels" (p. 27)

# How to Use VIERA TOOLS

You can access some special features easily by using the VIERA TOOLS function.

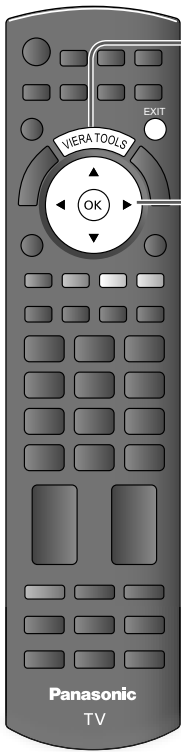

## 1 Display icons of the feature



## 2 Select a feature

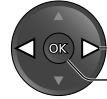

① select  
② access

## 3 Follow the operation of each feature

- VIERA Link Control ➔ “VIERA Link Control” (p. 36)



The connected device can be operated with the VIERA remote control. When multiple devices are connected, an indicator appears below the icon so that one device can be selected.

When two or more compatible equipments are connected, a selection screen will be displayed. Please select the correct description and access.

- Speaker Selection ➔ “Speaker Control” (p. 37)



Theatre speaker can be set.

- Slideshow ➔ “SD card slideshow” (p. 33)



Photo slideshow will start.

- Photos ➔ “SD card photo view” (p. 32)



Photo folders are displayed.

### To return to TV

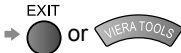

# Viewing from SD Card

## (VIERA IMAGE VIEWER)

Photo View: View still pictures recorded on a digital camera.

- During the operation, no signals are output from any of the AV terminals
- "Date" shows the date on which the recording was made by the digital camera. It is shown with asterisks when the file has no record of the date.
- For details on SD Cards → p. 45

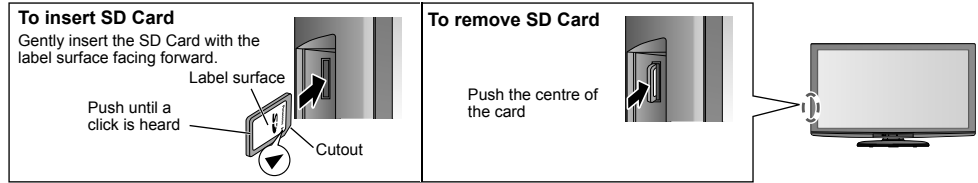

## Photo View



### 1 Insert the SD Card

### 2 Enter SD mode (Photo View)



- All photos in SD Card are displayed by thumbnail.

### 3 Select a folder to display the thumbnail



(Folder view)



① select

② thumbnail

- The files which are not in a folder will be collected to the folder named "M".
- To display all the photos → p. 33

### 4 Select a photo to be viewed

Error display  
(images that could not be loaded, etc.)

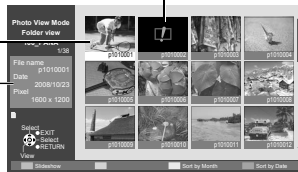

(Thumbnail)

Selected photo

Selected photo information is displayed



① select

② view

- Slide show → p. 33
- To sort by date or month recorded → p. 33



### To return to TV

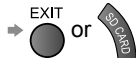

### To return to the previous screen



Operation guide

(Single view)

### Displayed one at a time

- To display / hide the operation guide →



To previous photo

Rotate 90° (anti-clockwise)

To next photo

Rotate 90° (clockwise)

### Start Slideshow

- To return to thumbnail → (List)



## Slideshow

### Start Slideshow (operate in step 4)

Select the photo for the first view



Start Slideshow



- To pause → (press again to resume)
- To return to Single view →

#### Note

- Slideshow is done within the thumbnail.

### Slideshow settings

Display the menu



Select "Viewing Setup"

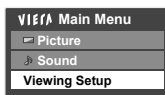

Select the items and set

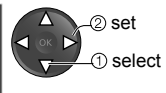
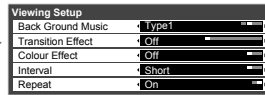

- Other items → p. 22-25

Menu	Item	Adjustments / Configurations (alternatives)
Viewing Setup	Back Ground Music	Selects the background music played during Photo mode (Off / Type1 / Type2 / Type3)
	Transition Effect	Selects the transition effect used when switching between photos during the slideshow (Off / Wipe ↓ / Wipe ↑ / Wipe → / Wipe ← / Comb →← / Dissolve / Checker Wipe / Random / Multi / Collage) ● When you select "Random", all effects are performed randomly except "Multi" and "Collage".
	Colour Effect	Selects the colour effect for slideshow (Off / Sepia / Gray scale)
	Interval	Select slideshow interval (Short / Normal / Long)
	Repeat	Slideshow repeat (Off / On)

### To display all the photos

Display the thumbnail of all the photos in SD Card.



(Folder view)

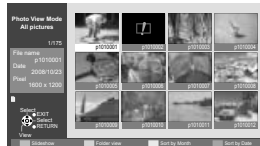

(Thumbnail - All pictures)



### To sort by date or month recorded

Display the list of groups sorted by the same date or the same month.

- The group of the photos without record of the date is shown as "Unknown".

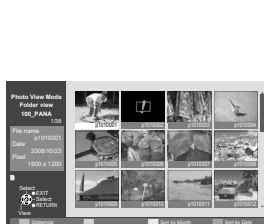

(Thumbnail)



(Sort by Month)

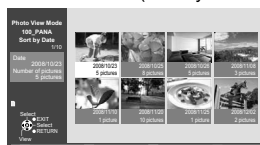
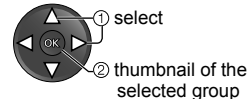

(Sort by Date)

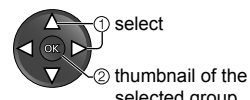

# VIERA Link Functions

## VIERA Link "HDAVI Control™"

Enjoy additional HDMI interoperability with Panasonic products which have "HDAVI Control" function. This TV supports "HDAVI Control 5" function.

Connections to the equipment with HDMI cable such as DIGA Recorder, HD Video Camera, Player theatre, Amplifier, etc., allow you to interface them automatically.

These features are limited to models incorporating "HDAVI Control" and "VIERA Link".

- Some functions are not available depending on the equipment's version of HDAVI Control. Please confirm the connected equipment's version of HDAVI Control.
- VIERA Link "HDAVI Control", based on the control functions provided by HDMI which is an industry standard known as HDMI CEC (Consumer Electronics Control), is a unique function that we have developed and added. As such, its operation with other manufacturers' equipment that supports HDMI CEC cannot be guaranteed.
- Please refer to individual manuals for the equipments. About applicable Panasonic equipment, consult your local Panasonic dealer.

### Summary of features

Features	Connected equipment with VIERA Link function	DIGA Recorder*1	DVD Player / Blu-ray Disc Player*1	HD Video Camera / LUMIX Camera*1	Player theatre*2	Blu-ray Disc theatre*2	Amplifier*2
Easy playback		○	○	○	○*5	○*5	—
Power on link		○	○	○	○	○	—
Power off link		○	○	○	○	○	○
Reduce unnecessary power consumption in standby		○*4	○*4	—	—	○*4	—
Auto standby for unnecessary equipment		○*3	○*3	—	○*3*6	○*3*6	○*3
Control the menu of the connected equipment by VIERA remote control		○*3	○*3	○*3	○*3	○*3	—
Speaker control		—	—	—	○	○	○

\*1: HDMI Connection only

\*2: HDMI and Audio out connections

\*3: available with the equipment which has "HDAVI Control 2 or later" function

\*4: available with the equipment which has "HDAVI Control 4 or later" function

\*5: while playingback a disc

\*6: except for watching a disc

### Connection

- To use DIGA Recorder / DVD Player / Blu-ray Disc Player / HD Video Camera / LUMIX Camera



- To use Player theatre / Blu-ray Disc theatre:

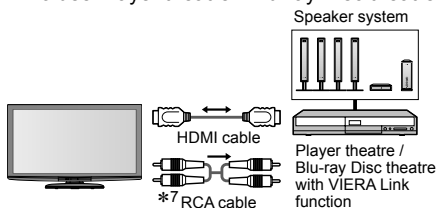

- To use Amplifier:

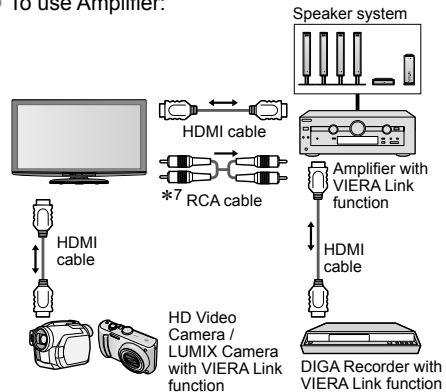

\*7: If the connected equipment has "HDAVI Control 5" function, you do not have to use this audio cable (RCA cable). In this case, connect the equipment to the TV's HDMI2 terminal via an HDMI cable.



### Note

- This function may not work properly depending on the connected equipment.
- For DIGA Recorder / DVD Player / Blu-ray Disc Player / HD Video Camera / LUMIX Camera with VIERA Link function, connect to HDMI1, HDMI2 or HDMI3 terminal via an HDMI cable.
- For Player theatre / Blu-ray Disc theatre / Amplifier, connect to HDMI1, HDMI2 or HDMI3 terminal via an HDMI cable and/or RCA cable for audio output from the TV.
- Use fully wired HDMI compliant cable. Non-HDMI-compliant cables cannot be utilized.  
Recommended Panasonic's HDMI cable part number:
  - RP-CDHS15 (1.5 m)
  - RP-CDHS30 (3.0 m)
  - RP-CDHS50 (5.0 m)

### Preparations

- Connect the equipment supporting VIERA Link.
- Set up the connected equipment. Read the manual of the equipment.
- For optimal recording, the settings of the recorder might be required. For details, read the manual of the recorder.
- Set VIERA Link On in Setup Menu → “VIERA Link” (p. 24)
- Set up the TV → **After connection, turn the equipment on and then switch the TV on. Set the input mode to HDMI1, HDMI2 or HDMI3 (p. 13), and make sure that an image is displayed correctly.**  
This setup should be done each time when the following conditions occur:
  - for the first time • when adding or reconnecting equipment • when changing setup

### Features available

#### Easy playback

Automatic input switching - When the connected equipment is operated, input mode is switched automatically.

#### Power on link

**Set Power on Link “On” in Setup Menu to use this function** → “Power on Link” (p. 24)  
When the connected equipment starts playback or direct navigator / function menu for the equipment are activated, the TV is automatically turned on. (Only when the TV is in Standby mode.)

#### Power off link

**Set Power off Link “On” in Setup Menu to use this function** → “Power off Link” (p. 24)  
When the TV is set to Standby mode, the connected equipment is also automatically set to Standby.  

- This function will work even if the TV enters standby mode automatically by Off Timer function or auto power standby function.

#### Standby Power Save Reduce unnecessary power consumption in standby

**Set Standby Power Save “On” in the Setup Menu to use this function**  
→ “Standby Power Save” (p. 24)  
The power consumption in Standby mode of the connected equipment is controlled higher or lower in synchronization with the TV On / Off state to reduce the consumption.  
When the TV is set to Standby mode, the connected equipment is automatically set to Standby and the power consumption in Standby mode of the connected equipment is automatically minimized.  
When the TV is turned on, the connected equipment is still in Standby mode, but the power consumption is increased to make startup time early.  

- This function is effective if the connected equipment can change the power consumption in Standby mode and is set to higher consumption.
- This function will work when “Power off Link” is set to “On”.

#### Intelligent Auto Standby Auto standby for unnecessary equipment

**Set Intelligent Auto Standby “On (With reminder)” or “On (No reminder)” in the Setup Menu to use this function** → “Intelligent Auto Standby” (p. 24)  
When the TV is On, non-watched or non-used connected equipment goes into Standby mode automatically to reduce the power consumption. For example, when the input mode is switched from HDMI, when Speaker Selection is changed to “TV” (except for watching a disc).  

- If you select “On (With reminder)”, the on screen message will be displayed to be noticed before working this function.
- This function may not work properly depending on the connected equipment. If required, set to “Off”.



# VIERA Link “HDAVI Control™”

Features available (Using VIERA Link Menu)

## VIERA Link Control Operate the connected equipment with VIERA remote control

You can control some functions of the connected equipment with this TV remote control by pointing at the TV's signal receiver.

- If you cannot operate, check the settings and the equipment
  - ➔ “Summary of features”, “Connection”, “Preparations” (p. 34, 35)
- For details of the operations for the connected equipment, read the manual of the equipment.

### Access and operate the menu of the equipment



① Display “VIERA Link Menu”

② Select “VIERA Link Control”



③ Select the equipment you want to access  
The type of the connected equipment is displayed.  
Select the type of the equipment and access.

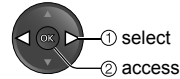
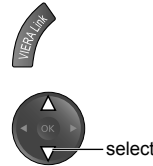

Recorder / Player / Home Cinema / Video Camera / LUMIX / Digital Camera / Other

- You can also access VIERA Link control by using VIERA TOOLS. ➔ p. 31
- The displayed item may vary depending on the connected equipment.
- “Home Cinema” means Player theatre, Blu-ray Disc theatre or Recorder theatre.
- “Other” means Tuner set top box.

**The menu of the accessed equipment**  
(Input mode will be changed automatically)

④ Operate the connected equipment

1. Set the remote control code to “73” (p. 19)
2. Follow the operation guide

To display the operation guide ➔ Store / set / access ➔

Move the cursor / select the menu ➔ Return to the previous menu ➔

Move the cursor / access / adjust ➔ Exit the menu ➔

When the key words are displayed on colour bar ➔

#### Note

- Some operations may not be available depending on the equipment.  
If so, use its own remote control.

#### If multiple recorders or players are connected



**Recorder1-3 / Player1-3**

The number is given from the TV's lower HDMI terminal number connected to the same type of equipment. For example, two recorders to HDMI2 and HDMI3, in this case the recorder connected to HDMI2 is displayed as “Recorder1”, and the recorder connected to HDMI3 is displayed as “Recorder2”.

#### If you access non-VIERA Link equipment

When the equipment with “HDAVI Control” function is connected



**Type of the connected equipment is displayed.**

You can access the menu of the equipment but you cannot operate it.  
Use its own remote control to operate the equipment.

## Speaker Selection Speaker control

You can control the theatre speaker with this TV remote control by pointing at the TV's signal receiver.

- If you cannot operate, check the settings and the equipment  
➔ "Summary of features", "Connection", "Preparations" (p. 34, 35)

### Access and control the speaker volume

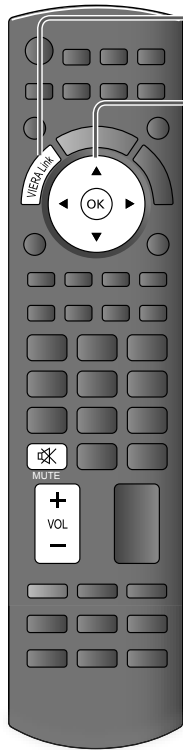

① Display "VIERA Link Menu"

② Select "Speaker Selection"



③ Set to "Home Cinema" or "TV"



#### Home Cinema

Player theatre, Blu-ray Disc theatre or Amplifier will be automatically turned on if it is in Standby mode and the sound is from theatre speakers connected to the equipment.

- Volume up / down

➔  (Volume slide bar will be displayed when adjusting the volume of the equipment.)

- Mute ➔ 

- The sound of TV speakers is mute.
- When the equipment is turned off, TV speakers will be active.

#### TV

TV speakers are active.

#### Note

- If you wish to enjoy the multi-channel sound (e.g. Dolby Digital 5.1ch) via an Amplifier, connect with HDMI cable and RCA cable (p. 34), and then select "Home Cinema". If your Amplifier has "HDAVI Control 5" function, you can connect only with HDMI cable. In this case, connect your Amplifier to the TV's HDMI2 terminal.  
To enjoy the sound from the DIGA Recorder in multi-channel sound, connect an HDMI cable from the DIGA Recorder to the Amplifier (p. 34).

#### Note

- These functions may not work properly depending on the connected equipment.
- Image or sound may not be available for the first few seconds when input mode is switched.
- Easy playback may be available by using the remote control for Player theatre, Blu-ray Disc theatre or Amplifier. Read the manual of the equipment.
- "HDAVI Control 5" is the newest standard (current as of December, 2009) for HDAVI Control compatible equipment. This standard is compatible with conventional HDAVI equipment.
- To confirm this TV's version of HDAVI Control ➔ "System Information" (p. 25)

# External Equipment

These diagrams show our recommendations for how to connect the TV to your various equipment. For other connections, consult the instructions for each piece of equipment, the table below, and the specifications (p. 50).

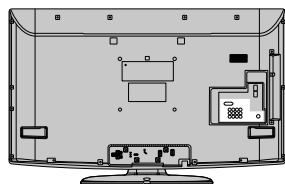

## Camcorder / Game equipment

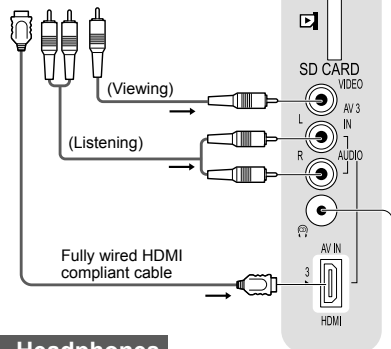

## Headphones

### To adjust volume

→ "Headphone Volume" in the Sound Menu (p. 23)



(M3 stereo mini plug)

## To listen with speakers

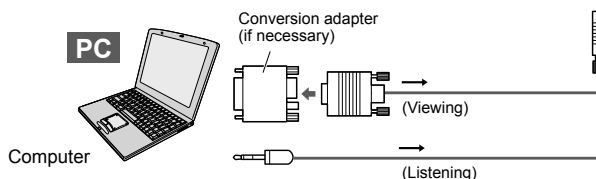
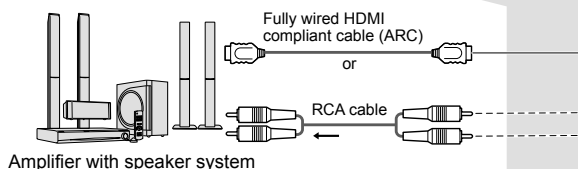

## Types of connectable equipment to each terminal

Terminal	AV1 IN 	AV2 IN 	AV3 IN (Side of TV) 	
Recording / Playback (equipment)				
To record / playback videocassettes / DVDs (VCR / DVD recorder)	○	○	○	
To watch DVDs (DVD player)	○	○	○	
To watch camcorder images (Video camera)	○	○	○	
To watch satellite broadcasts (Set top box)	○	○	○	
To play games (Game equipment)	○	○	○	
To use amplifier with speaker system				
VIERA Link				

○: Recommended Connection

\*1: applicable if your amplifier has ARC (Audio Return Channel) function

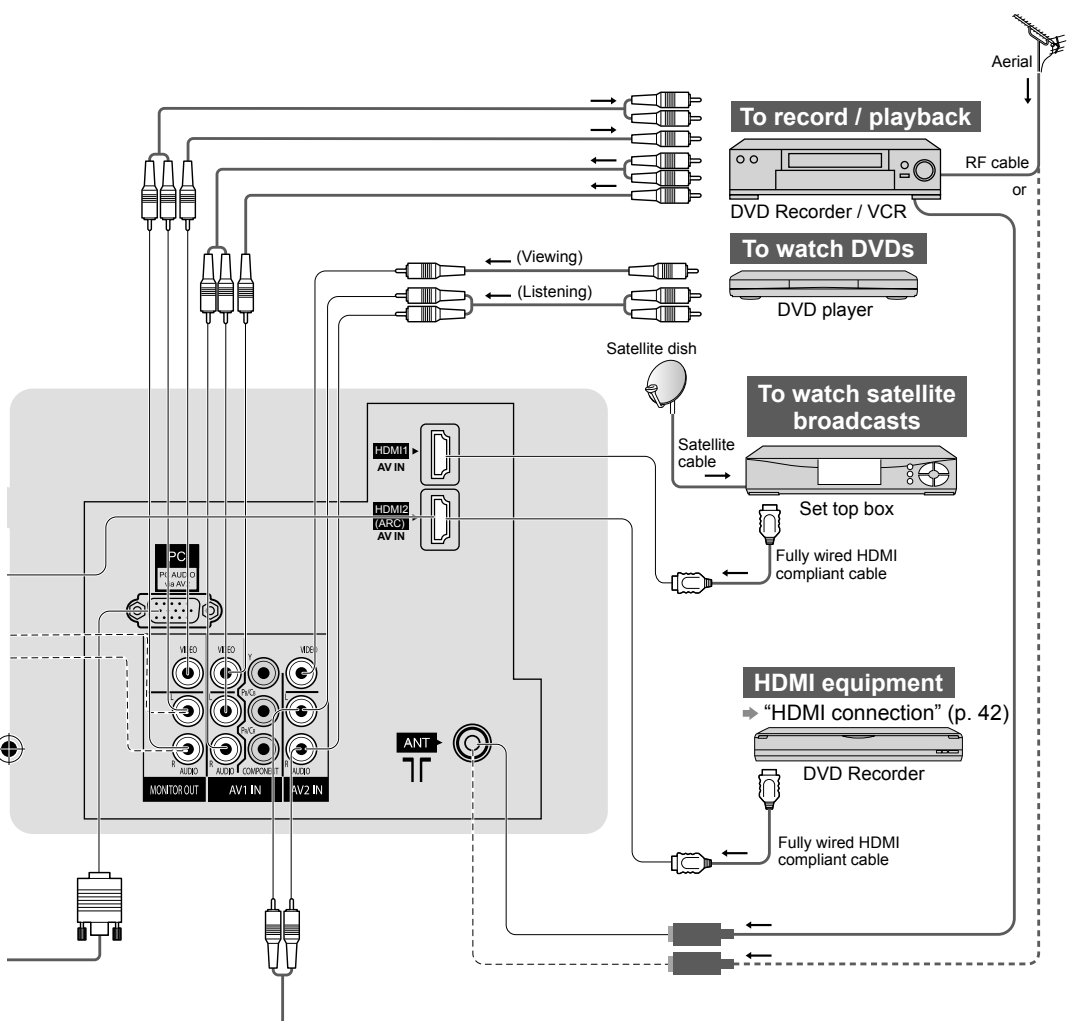

External Equipment

Advanced

	MONITOR OUT VIDEO AUDIO	HDMI		
		1	2	3
	○	○	○	○
		○	○	○
		○	○	○
		○	○	○
		○	○*	○
		○	○	○

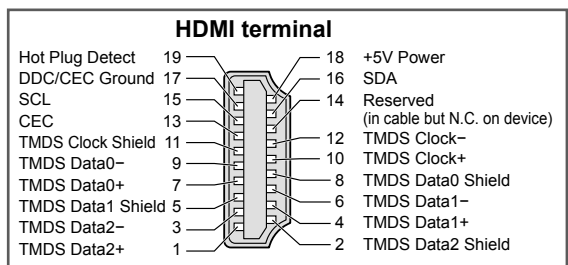

# Technical Information

## Channel Allocation

Channel Plan	Asia/W. Europe	CIS/ E. Europe	China	Hong Kong	NZ/ Indonesia	Indian CATV	South Africa	American System	American CATV	Japan									
CH DISPLAY	Receive channel																		
0	-	-	-	-	-	-	-	-	-	-									
1	-	1	1	-	-	1	1	-	1	1									
2	2	2	2	-	2	2	2	2	2	2									
3	}	}	}	}	}	}	}	}	}	}									
4																			
5																			
6																			
7																			
11	11	11	-	-	11	S1	11	-	-										
12	12	12	12	-	-	S2	12	-	-										
13	-	-	13	-	-	S3	13	13	-										
14	-	-	-	-	-	S4	14	14	-										
15	-	-	-	-	-	}	-	-	-										
16	-	-	-	-	-														
19	-	-	-	-	-														
20	-	-	-	-	-														
	-	-	-	-	-		S10	-	-	-									
	-	-	-	-	-	5	-	-	-										
21	21	21	-	21	21	6	21	-	-	-									
22	}	}	}	}	}	}	}	}	}	}									
23																			
24																			
28																			
57											57	-	-	-	12	-	-	-	
58	-	-	-	-	S11	-	-	-											
59	-	-	-	-	S40	-	-	-											
62	62	62	-	62	62	24	62	62	62										
63	63	63	-	63	63	25	63	63	63										
69	69	69	-	69	69	31	69	69	69										
70	-	-	-	-	-	32	-	-	-	-									
73	-	-	-	-	-	-	-	-	-	-									
74	S'1	S'1	-	S'1	S'1	-	S'1	-	-	-									
75	S'2	-	-	S'2	S'2	-	S'2	-	-	-									
76	S'3	-	-	S'3	S'3	-	S'3	-	-	-									
77	-	-	-	-	-	-	-	-	-	-									
78	-	-	-	-	-	-	-	-	-	-									
79	-	-	-	-	-	41	-	-	-	-									
80	S1	S1	-	S1	S1	42	S1	-	-	-									
81	S2	S2	Z1	S2	S2	-	S2	-	-	-									
89	S10	S10	Z9	S10	S10	51	S10	-	-	-									
90	S11	S11	Z10	S11	S11	52	-	-	-	-									
91	S12	S12	Z11	S12	S12	-	-	-	-	-									
92	S13	S13	Z12	S13	S13	-	-	-	-	-									
93	S14	S14	Z13	S14	S14	-	S14	-	-	-									
94	S15	S15	Z14	S15	S15	-	S15	-	-	-									
95	S16	S16	Z15	S16	S16	-	S16	-	-	-									
96	S17	S17	Z16	S17	S17	-	S17	-	-	-									
97	S18	S18	Z17	S18	S18	-	S18	-	-	-									
98	S19	S19	Z18	S19	S19	-	S19	-	-	-									
99	S20	S20	Z19	S20	S20	61	S20	-	99	C49									
100	S21	S21	Z20	S21	S21	62	S21	-	100	-									
107	}	}	}	}	}	}	}	}	}	}									
117																			
118																			
120											S41	S41	-	S41	S41	-	S41	-	-
125											-	-	-	-	-	-	-	-	125





### Stereo / Bilingual Sound Selection

/▽ When you receive the stereo / bilingual sound system, sound output modes can be selected by pressing the **Stereo / Bilingual Sound Selection** button.

Audio Signal	STEREO	MAIN I	SUB II	MONO
Mode Indicator		I	II	▽

**NICAM** .....Used in New Zealand, Singapore, Hong Kong etc.

Type of broadcast	Regular broadcast (Standard Audio)	Regular + NICAM MONO I (MAIN I)	NICAM STEREO	NICAM DUAL MONO (MAIN I / SUB II)
Mode Indicator	No Indicator ↔ ▽	I ↔ ▽	↔ ▽	I → II ↔ ▽ ↔

**A2 (German)** .....Used in Australia, Malaysia etc.

Type of broadcast	Regular broadcast (Standard Audio)	BILINGUAL or DUAL MONO: MAIN I / SUB II	STEREO
Mode Indicator	No Indicator ↔ ▽	I ↔ II	↔ ▽

- If the stereo signal is poor or the receiving conditions are not optimum or if STEREO:MONO automatic switching occurs, it is recommended you switch from STEREO to MONO.
- Even when the contents of the receiving signal undergo changes, selection mode is kept intact.
- When the receiving conditions deteriorate, listening will be easier if the mode is set to the MONO position, using the stereo / bilingual sound selection button.
- DUAL, also known as DUAL MONO or as BILINGUAL is not currently transmitted in some countries.



# Technical Information

## HDMI connection

HDMI (high-definition multimedia interface) is the world's first complete digital consumer AV interface complying with a non-compression standard.

HDMI allows you to enjoy high-definition digital images and high-quality sound by connecting the TV and the equipment.

HDMI-compatible equipment (\*1) with an HDMI or DVI output terminal, such as a DVD player, a set top box or a game equipment, can be connected to the HDMI terminal using an HDMI compliant (fully wired) cable. About connections, see "External Equipment" (p. 38, 39).

### Applicable HDMI features

- Input audio signal : 2ch Linear PCM (sampling frequencies - 48 kHz, 44.1 kHz, 32 kHz)
- Input video signal : 480i, 480p, 576i, 576p, 720p, 1080i and 1080p
  - ➔ "Input signal that can be displayed" (p. 43)  
Match the output setting of the digital equipment.
- Input PC signal : ➔ "Input signal that can be displayed" (p. 43)  
Match the output setting of the PC.
- VIERA Link (HDAVI Control 5) : ➔ "VIERA Link" (p. 34)
- Audio Return Channel (\*2) (HDMI2 terminal only)

### DVI connection

If the external equipment has only a DVI output, connect to the HDMI terminal via a DVI to HDMI adapter cable (\*3).

When the DVI to HDMI adapter cable is used, connect the audio cable to the audio input terminal (HDMI1 / 2: use COMPONENT-AUDIO terminals / HDMI3: use AV3 audio terminals).

#### Note

- Audio settings can be made on the "HDMI1 / 2 / 3 Input" in the Sound Menu. (p. 23)
- If the connected equipment has an aspect adjustment function, set the aspect ratio to "16:9".
- These HDMI connectors are "type A".
- These HDMI connectors are compatible with HDCP (High-Bandwidth Digital Content Protection) copyright protection.
- An equipment having no digital output terminal may be connected to the input terminal of either "COMPONENT" or "VIDEO" to receive analogue signals.
- This TV incorporates HDMI™ technology.

(\*1): The HDMI logo is displayed on HDMI-compliant equipment.

(\*2): Audio Return Channel (ARC) is a function to be able to send digital sound signals via an HDMI cable.

(\*3): Enquire at your local digital equipment retailer shop.

## Input signal that can be displayed

### COMPONENT (Y, P<sub>B</sub>/C<sub>B</sub>, P<sub>R</sub>/C<sub>R</sub>), HDMI

\* Mark: Applicable input signal

Signal name	COMPONENT	HDMI
525 (480) / 60i	*	*
525 (480) / 60p	*	*
625 (576) / 50i	*	*
625 (576) / 50p	*	*
750 (720) / 60p	*	*
750 (720) / 50p	*	*
1,125 (1,080) / 60i	*	*
1,125 (1,080) / 50i	*	*
1,125 (1,080) / 60p		*
1,125 (1,080) / 50p		*
1,125 (1,080) / 24p		*

### PC (from D-sub 15P)

Applicable input signal for PC is basically compatible to VESA standard timing.

Signal name	Horizontal frequency (kHz)	Vertical frequency (Hz)
640 × 400 @70 Hz	31.47	70.07
640 × 480 @60 Hz	31.47	59.94
640 × 480 @75 Hz	37.50	75.00
800 × 600 @60 Hz	37.88	60.32
800 × 600 @75 Hz	46.88	75.00
800 × 600 @85 Hz	53.67	85.06
852 × 480 @60 Hz	31.44	59.89
1,024 × 768 @60 Hz	48.36	60.00
1,024 × 768 @70 Hz	56.48	70.07
1,024 × 768 @75 Hz	60.02	75.03
1,024 × 768 @85 Hz	68.68	85.00
1,280 × 1,024 @60 Hz	63.98	60.02
1,280 × 768 @60 Hz	47.70	60.00
1,366 × 768 @60 Hz	48.39	60.04
Macintosh13" (640 × 480)	35.00	66.67
Macintosh16" (832 × 624)	49.73	74.55
Macintosh21" (1,152 × 870)	68.68	75.06

### PC (from HDMI terminal)

Applicable input signal for PC is basically compatible to HDMI standard timing

Signal name	Horizontal frequency (kHz)	Vertical frequency (Hz)
640 × 480 @60 Hz	31.47	60.00
750 (720) / 60p	45.00	60.00
1,125 (1,080) / 60p	67.50	60.00

#### Note

- Signals other than above may not be displayed properly.
- The above signals are reformatted for optimal viewing on your display.
- PC signal is magnified or compressed for display, so that it may not be possible to show fine detail with sufficient clarity.

# Technical Information

## PC connection

A PC may be connected to this TV so that the PC screen is displayed and sound is heard from the TV.

- PC signals that can be inputted: Horizontal scanning frequency 31 to 69 kHz; vertical scanning frequency 59 to 86 Hz. More than 1,024 signal lines could result in incorrect display of the image.
- A PC adapter is not necessary for the DOS/V-compliant D-sub 15-pin connector.

### Note

- Some PC models cannot be connected to this TV.
- When using PC, set the colour display quality of PC to the highest position.
- For details of the applicable PC signals, see p. 43.
- Max. display resolution

Aspect	4:3	1,024 × 768 pixels
	16:9	1,366 × 768 pixels

- D-sub 15-pin connector signal

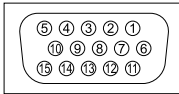

Pin No.	Signal Name	Pin No.	Signal Name	Pin No.	Signal Name
①	R	⑥	GND (Ground)	⑪	NC (not connected)
②	G	⑦	GND (Ground)	⑫	NC (not connected)
③	B	⑧	GND (Ground)	⑬	HD
④	NC (not connected)	⑨	NC (not connected)	⑭	VD
⑤	GND (Ground)	⑩	GND (Ground)	⑮	NC (not connected)

## SD Card

Use an SD Card which meets SD standards.  
If not, it may cause the TV to malfunction.

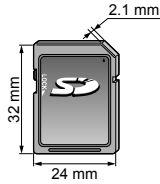

### Cautions in handling SD Card

- Do not remove the card while the TV is accessing data (this can damage card or TV).
- Do not touch the pins on the back of the card.
- Do not subject the card to a high pressure or impact.
- Insert the card in the correct direction (otherwise, card may be damaged).
- Electrical interference, static electricity, or erroneous operation may damage the data or card.
- Back up the recorded data at regular intervals in case of deteriorated or damaged data or erratic operation of the TV. (Panasonic is not liable for any deterioration or damage of recorded data.)

### Data format for Card browsing

- Photo : Still images recorded with digital still cameras compatible with JPEG files of DCF\* and EXIF standards  
Data format - Baseline JPEG (Sub-sampling 4:4:4, 4:2:2 or 4:2:0)  
Image resolution - 160 × 120 to 20,000,000 pixels
- Card format : SDHC Card / SD Card - FAT16 or FAT32
- Compliant card type (maximum capacity): SDHC Card (32 GB), SD Card (2 GB), miniSD Card (2 GB) (requiring miniSD adapter)
- If miniSD Card is used, insert / remove it together with the adapter.
- Check the latest information on the card type at the following website. (English only)  
<http://panasonic.jp/support/global/cs/>

\*DCF (Design rule for camera file system): Unified standard established by Japan Electronics and Information Technology Industries Association (JEITA).

#### Note

- Format the card with the recording equipment.
- The picture may not appear correctly on this TV depending on the recording equipment used.
- Display may take some time when there are many files and folders.
- This function cannot display Motion JPEG and still image not JPEG formatted (i.e. TIFF, BMP).
- A data modified with a PC may not be displayed.
- Images imported from a PC must be compatible with EXIF (Exchangeable Image File) 2.0, 2.1, and 2.2.
- Partly degraded files might be displayed at a reduced resolution.
- The folder and file names may be different depending on the digital camera used.
- Do not use two-byte characters or other special codes.
- The card may become unusable with this TV if the file or folder names are changed.

### On screen messages

Message	Meaning / Action
Cannot read file	<ul style="list-style-type: none"> <li>● The file is broken or unreadable.</li> <li>● The TV does not support the format. (For the applicable formats and data, see above.)</li> </ul>
No SD card inserted	<ul style="list-style-type: none"> <li>● Confirm SD Card is inserted correctly.</li> </ul>
No valid file to play	<ul style="list-style-type: none"> <li>● The card has no data.</li> </ul>
Over 9999 pictures found (max. is 9999)	<ul style="list-style-type: none"> <li>● Maximum valid number of photos is 9,999.</li> </ul>

# Maintenance

**First, remove the mains plug from the socket outlet.**

## Display panel, Cabinet, Pedestal

### **For regular care:**

Gently wipe the surface of the display panel, cabinet, or pedestal by using a soft cloth to clean the dirt or fingerprints.

### **For stubborn dirt:**

Dampen a soft cloth with clean water or diluted neutral detergent (1 part detergent to 100 parts water). Then wring the cloth and wipe the surface. Finally, wipe away all the moisture.

### **Caution**

- Do not use a hard cloth or rub the surface too hard. This may cause scratches on the surface.
- Take care not to subject the TV's surfaces to water or detergent. A liquid inside the TV could lead to product failure.
- Take care not to subject the surfaces to insect repellent, solvent, thinner, or other volatile substances. This may degrade surface quality or cause peeling of the paint.
- The surface of the display panel is specially treated and may be easily damaged. Take care not to tap or scratch the surface with your fingernail or other hard objects.
- Do not allow the cabinet and pedestal to make contact with a rubber or PVC substance for a long time. This may degrade surface quality.

## Mains plug

Wipe the mains plug with a dry cloth at regular intervals. Moisture and dust may lead to fire or electrical shock.

# FAQs

Before requesting service or assistance, please follow these simple guides to resolve the problem. If the problem still persists, please contact your local Panasonic dealer for assistance.

## White spots or shadow images (noise)

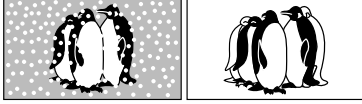

- Check the position, direction, and connection of the aerial.

## Neither image nor sound is produced

- Is the TV in "AV mode"?
- Is the mains lead plugged into the socket outlet?
- Is the TV turned On?
- Check Picture Menu (p. 22) and volume.
- Check all required cables and connections are firmly in place.

## An error message appears

- Follow the message's instructions.
- If the problem persists, contact your local Panasonic dealer.

## "VIERA Link" function does not work and an error message appears

- Confirm the connection.
- Turn the connected equipment on and then switch the TV on. (p. 34)

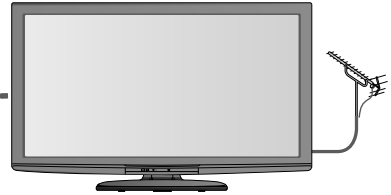

## The LCD panel moves slightly when it is pushed with a finger

### Clattered sound might be heard

- There are some looseness around the panel to prevent the damage to the panel. The panel might move slightly when it is pushed with a finger, and clattered sound might be heard. This is not a malfunction.

## There may be red spots, blue spots, green spots and black spots on the screen

- This is a characteristic of liquid crystal panels and is not a problem. The liquid crystal panel is built with very high precision technology giving you fine picture details. Occasionally, a few non-active pixels may appear on the screen as a fixed point of red, green, blue or black. Please note this does not affect the performance of your LCD, and it is not a quality problem.

# FAQs

	Problem	Actions
Screen	<b>Chaotic image, noisy</b>	<ul style="list-style-type: none"> <li>● Change the setting of "P-NR" in the Picture Menu (to remove noise) (p. 22).</li> <li>● Check nearby electrical products (car, motorcycle, fluorescent lamp).</li> </ul>
	<b>No image can be displayed</b>	<ul style="list-style-type: none"> <li>● Is "Colour" or "Contrast" in the Picture Menu set to the minimum? (p. 22)</li> </ul>
	<b>Blurry or distorted image</b> (no sound or low volume)	<ul style="list-style-type: none"> <li>● Reset channels (p. 30).</li> </ul>
	<b>Unusual image is displayed</b>	<ul style="list-style-type: none"> <li>● Turn off the TV with Mains power On / Off switch, then turn it on again.</li> </ul>
Sound	<b>No sound is produced</b>	<ul style="list-style-type: none"> <li>● Is "Sound Mute" active? (p. 10)</li> <li>● Is the volume set to the minimum?</li> </ul>
	<b>Sound level is low or sound is distorted</b>	<ul style="list-style-type: none"> <li>● Sound signal reception may be deteriorated.</li> <li>● Set "MPX" in the Sound Menu to "Mono" (p. 23).</li> </ul>
HDMI	<b>Sound is unusual</b>	<ul style="list-style-type: none"> <li>● Set the sound setting of the connected equipment to "2ch L.PCM".</li> <li>● Check the "HDMI1 / 2 / 3 Input" setting in the Sound Menu (p. 23).</li> <li>● If digital sound connection has a problem, select analogue sound connection (p. 42).</li> </ul>
	<b>Pictures from external equipment are unusual when the equipment is connected via HDMI</b>	<ul style="list-style-type: none"> <li>● Is the HDMI cable connected properly? (p. 34, 38, 39)</li> <li>● Turn Off the TV and equipment, then turn them On again.</li> <li>● Check an input signal from the equipment (p. 43).</li> <li>● Use an equipment compliant with EIA/CEA-861/861B.</li> </ul>
Other	<b>TV goes into Standby mode</b>	<ul style="list-style-type: none"> <li>● Auto power standby function is activated.</li> <li>● The TV enters Standby mode about 30 minutes after broadcasting ends.</li> </ul>
	<b>The remote control does not work or is intermittent</b>	<ul style="list-style-type: none"> <li>● Are the batteries installed correctly? (p. 3)</li> <li>● Has the TV been switched On?</li> <li>● Point the remote control directly at the front of the TV (within a 30 degree angle of the front of the TV).</li> <li>● Situate the TV away from sunshine or other sources of bright light not to shine on the TV's remote control signal receiver.</li> </ul>



# Licence

Even if no special notation has been made of company or product trademarks, these trademarks have been fully respected.

- VGA is a trademark of International Business Machines Corporation.
- S-VGA is a registered trademark of the Video Electronics Standard Association.
- SDHC Logo is a trademark of SD-3C, LLC.
- HDMI, the HDMI Logo and High-Definition Multimedia Interface are trademarks or registered trademarks of HDMI Licensing LLC in the United States and other countries.
- HDAVI Control™ is a trademark of Panasonic Corporation.
- Macintosh is a trademark of Apple Inc.

## **This product incorporates the following software:**

- (1) software developed independently by or for Panasonic Corporation,
- (2) software owned by a third party and licensed to Panasonic Corporation,
- (3) software licensed under the GNU General Public License, Version 2 (GPL v2),
- (4) software licensed under the GNU LESSER General Public License (LGPL) and/or,
- (5) open source software other than software licensed under the GPL and/or LGPL

For the software categorized as (3) or (4), please refer to the terms and conditions of GPL v2 and LGPL, as the case may be. at <http://www.gnu.org/licenses/old-licenses/gpl-2.0.html> and <http://www.gnu.org/licenses/old-licenses/lgpl-2.1.html>

In addition, software categorized as (3) or (4) is copyrighted by several individuals and/or entities. Please refer to the copyright notice of those individuals at <http://www.am-linux.jp/dl/DTV10AT/>

GPL/LGPL SOFTWARE IS DISTRIBUTED IN THE HOPE THAT IT WILL BE USEFUL, BUT WITHOUT ANY WARRANTY, EXPRESS, IMPLIED OR STATUTORY, INCLUDING THE IMPLIED WARRANTIES OF MERCHANTABILITY OR FITNESS FOR A PARTICULAR PURPOSE.

For at least three (3) years from delivery of products, Panasonic will give to anyone who contacts us at the address provided below, for a charge of no more than our cost of physically performing source code distribution, a complete machine-readable copy of the corresponding source code covered under GPL v2/LGPL.

Contact Information

[cdrequest@am-linux.jp](mailto:cdrequest@am-linux.jp)

Source code is also freely available to you and any other member of the public via our website below.

<http://www.am-linux.jp/dl/DTV10AT/>

# Specifications

		TH-L42U20K/T/X, TH-L42U28K, TH-L42U29K	TH-L42U20M	TH-L42U20R																							
<b>Power Source</b>		AC AUTO 110-240 V, 50 / 60 Hz	AC 110-240 V, 50 / 60 Hz	AC Single 220-240 V, 50 / 60 Hz																							
<b>Power Consumption</b>	<b>Average use</b>	187 W		178 W																							
	<b>Standby condition</b>	0.5 W																									
<b>Display panel</b>	<b>Aspect Ratio</b>	16:9																									
	<b>Visible screen size</b>	106 cm (diagonal) 930 mm (W) × 523 mm (H)																									
	<b>Number of pixels</b>	2,073,600 (1,920 (W) × 1,080 (H))																									
<b>Sound</b>	<b>Speaker</b>	160 mm × 40 mm × 2 pcs, 8 Ω																									
	<b>Audio Output</b>	20 W (10 W + 10 W), 10% THD																									
	<b>Headphones</b>	M3 (3.5 mm) stereo mini Jack × 1																									
<b>PC signals</b>		VGA, SVGA, WVGA, XGA SXGA, WXGA ..... (compressed) Horizontal scanning frequency 31 - 69 kHz Vertical scanning frequency 59 - 86 Hz																									
<b>Receiving Systems / Band name</b>		<table border="1"> <thead> <tr> <th>17 Systems</th> <th>Function</th> </tr> </thead> <tbody> <tr><td>1 PAL B, G, H</td><td rowspan="7">Reception of broadcast transmissions and Playback from Video Cassette Tape Recorders</td></tr> <tr><td>2 PAL I</td></tr> <tr><td>3 PAL D, K</td></tr> <tr><td>4 SECAM B, G</td></tr> <tr><td>5 SECAM D, K</td></tr> <tr><td>6 SECAM K1</td></tr> <tr><td>7 NTSC M (NTSC 3.58/4.5 MHz)</td></tr> </tbody> </table>	17 Systems	Function	1 PAL B, G, H	Reception of broadcast transmissions and Playback from Video Cassette Tape Recorders	2 PAL I	3 PAL D, K	4 SECAM B, G	5 SECAM D, K	6 SECAM K1	7 NTSC M (NTSC 3.58/4.5 MHz)	<table border="1"> <thead> <tr> <th>17 Systems</th> <th>Function</th> </tr> </thead> <tbody> <tr><td>8 NTSC 4.43/5.5 MHz</td><td rowspan="7">Playback from Special VCR's or DVD</td></tr> <tr><td>9 NTSC 4.43/6.0 MHz</td></tr> <tr><td>10 NTSC 4.43/6.5 MHz</td></tr> <tr><td>11 NTSC 3.58/5.5 MHz</td></tr> <tr><td>12 NTSC 3.58/6.0 MHz</td></tr> <tr><td>13 NTSC 3.58/6.5 MHz</td></tr> <tr><td>14 SECAM I</td></tr> <tr><td>15 PAL 60 Hz/5.5 MHz</td><td rowspan="3">Playback from Special Disc Players and Special VCR's or DVD</td></tr> <tr><td>16 PAL 60 Hz/6.0 MHz</td></tr> <tr><td>17 PAL 60 Hz/6.5 MHz</td></tr> </tbody> </table>	17 Systems	Function	8 NTSC 4.43/5.5 MHz	Playback from Special VCR's or DVD	9 NTSC 4.43/6.0 MHz	10 NTSC 4.43/6.5 MHz	11 NTSC 3.58/5.5 MHz	12 NTSC 3.58/6.0 MHz	13 NTSC 3.58/6.5 MHz	14 SECAM I	15 PAL 60 Hz/5.5 MHz	Playback from Special Disc Players and Special VCR's or DVD	16 PAL 60 Hz/6.0 MHz	17 PAL 60 Hz/6.5 MHz
17 Systems	Function																										
1 PAL B, G, H	Reception of broadcast transmissions and Playback from Video Cassette Tape Recorders																										
2 PAL I																											
3 PAL D, K																											
4 SECAM B, G																											
5 SECAM D, K																											
6 SECAM K1																											
7 NTSC M (NTSC 3.58/4.5 MHz)																											
17 Systems	Function																										
8 NTSC 4.43/5.5 MHz	Playback from Special VCR's or DVD																										
9 NTSC 4.43/6.0 MHz																											
10 NTSC 4.43/6.5 MHz																											
11 NTSC 3.58/5.5 MHz																											
12 NTSC 3.58/6.0 MHz																											
13 NTSC 3.58/6.5 MHz																											
14 SECAM I																											
15 PAL 60 Hz/5.5 MHz	Playback from Special Disc Players and Special VCR's or DVD																										
16 PAL 60 Hz/6.0 MHz																											
17 PAL 60 Hz/6.5 MHz																											
<b>Receiving Channels (Regular TV)</b>		<b>PAL B/G</b> 2-12 (PAL/SECAM B, K1) 0-12 (PAL B AUST.) 1-9 (PAL B N.Z.) 1-12 (PAL/SECAM D) 1-12 (NTSC M Japan) 2-13 (NTSC M USA)	<b>UHF BAND</b> 21-69 (PAL G, H, I/SECAM G, K, K1) 28-69 (PAL B AUST.) 13-57 (PAL D, K) 13-62 (NTSC M Japan) 14-69 (NTSC M USA)	<b>CATV</b> S1-S20 (OSCAR) 1-125 (USA CATV) C13-C49 (JAPAN) S21-S41 (HYPER) Z1-Z37 (CHINA) 5A, 9A (AUST.)																							
<b>Aerial - Rear</b>		VHF / UHF																									
<b>Operating Conditions</b>		<b>Temperature</b> : 0 °C - 40 °C <b>Humidity</b> : 20 % - 80 % RH (non-condensing)																									
<b>Connection Terminals</b>	<b>AV1 Input</b>	<b>AUDIO L - R</b>	RCA PIN Type × 2 0.5 V[rms]																								
		<b>VIDEO</b>	RCA PIN Type × 1 1.0 V[p-p] (75 Ω)																								
		<b>COMPONENT</b>	Y P <sub>B</sub> /C <sub>B</sub> , P <sub>R</sub> /C <sub>R</sub> 1.0 V[p-p] (including synchronization) ±0.35 V[p-p]																								
	<b>AV2 Input</b>	<b>AUDIO L - R</b>	RCA PIN Type × 2 0.5 V[rms]																								
		<b>VIDEO</b>	RCA PIN Type × 1 1.0 V[p-p] (75 Ω)																								
	<b>AV3 Input</b>	<b>AUDIO L - R</b>	RCA PIN Type × 2 0.5 V[rms]																								
		<b>VIDEO</b>	RCA PIN Type × 1 1.0 V[p-p] (75 Ω)																								
	<b>Monitor Output</b>	<b>AUDIO L - R</b>	RCA PIN Type × 2 0.5 V[rms] (high impedance)																								
		<b>VIDEO</b>	RCA PIN Type × 1 1.0 V[p-p] (75 Ω)																								
	<b>Others</b>	<b>HDMI 1 - 3 Input</b>	TYPE A Connectors ● This TV supports "HDAVI Control 5" function.																								
<b>PC Input</b>		HIGH-DENSITY R, G, B/0.7 V[p-p] (75 Ω) D-SUB 15PIN HD, VD/TTL Level 2.0 - 5.0 V[p-p] (high impedance)																									
<b>Card slot</b>		SD Card slot × 1																									
<b>Dimensions (W × H × D)</b>		1,021 mm × 680 mm × 310 mm (With Pedestal) 1,021 mm × 637 mm × 115 mm (TV only)																									
<b>Mass</b>		21.0 kg Net (With Pedestal) 18.0 kg Net (TV only)																									

## Note

- Design and Specifications are subject to change without notice. Mass and Dimensions shown are approximate.

# Memo

Specifications

Technical



**Customer's Record**

The model number and serial number of this product may be found on its rear panel. You should note the model number and the serial number in the space provided below and retain this book, plus your purchase receipt, as a permanent record of your purchase to aid in identification in the event of theft or loss, and for Warranty Service purposes.

Model Number \_\_\_\_\_

Serial Number \_\_\_\_\_

**Panasonic Corporation**

**Web Site: <http://panasonic.net>**

© Panasonic Corporation 2010

Printed in Malaysia

