

PENTAX Corporation 2-36-9, Maeno-cho, Itabashi-ku, Tokyo 174-8639, JAPAN
(<http://www.pentax.co.jp/>)

PENTAX Europe GmbH (European Headquarters)
Julius-Vosseler-Strasse, 104, 22527 Hamburg, GERMANY
(HQ - <http://www.pentaxeurope.com>)
(Germany - <http://www.pentax.de>)

PENTAX U.K. Limited PENTAX House, Heron Drive, Langley, Slough, Berks
SL3 8PN, U.K.
(<http://www.pentax.co.uk>)

PENTAX France S.A.S. 112 Quai de Bezons, B.P. 204, 95106 Argenteuil Cedex, FRANCE
(<http://www.pentax.fr>)

PENTAX (Schweiz) AG Widenholzstrasse 1, 8304 Wallisellen, Postfach 367 8305
Dietlikon, SWITZERLAND (<http://www.pentax.ch>)

PENTAX Scandinavia AB P.O. Box 650, 75127 Uppsala, SWEDEN
(<http://www.pentax.se>)

PENTAX Imaging Company
A Division of PENTAX of America, Inc.

(Headquarters)
600 12th Street, Suite 300
Golden, Colorado 80401, U.S.A.
(PENTAX Service Department)
12000 Zuni Street, Suite 100B
Westminster, Colorado 80234, U.S.A
(<http://www.pentaximaging.com>)

PENTAX Canada Inc. 1770 Argenta Road Mississauga, Ontario L5N 3S7,
CANADA
(<http://www.pentax.ca>)

Optio A20

PENTAX™

Digital Camera

Optio A20

Operating Manual



To ensure the best performance from your camera, please read the Operating Manual before using the camera.



for your
precious moments

<http://www.pentax.co.jp/english>

- Specifications and external dimensions are subject to change without notice.

57756

Copyright © PENTAX Corporation 2006
01-200609 Printed in Philippines



Thank you for buying the PENTAX Digital Camera.

Please read this manual before using the camera in order to get the most out of all the features and functions. Keep this manual safe, as it can be a valuable tool in helping you to understand all the camera's capabilities.



Regarding copyrights

Images taken using the PENTAX Digital Camera that are for anything other than personal enjoyment cannot be used without permission according to the rights as specified in the Copyright Act. Please take care, as there are even cases where limitations are placed on taking pictures even for personal enjoyment during demonstrations, performance or of items on display. Images taken with the purpose of obtaining copyrights also cannot be used outside the scope of use of the copyright as laid out in the Copyright Act, and care should be taken here also.

To users of this camera

- There is a possibility that recorded data may be erased or that the camera may not function correctly when used in surroundings such as installations generating strong electromagnetic radiation or magnetic fields.
- The liquid crystal panel used in the LCD display is manufactured using extremely high precision technology. Although the level of functioning pixels is 99.99% or better, you should be aware that 0.01% or fewer of the pixels may not illuminate or may illuminate when they should not. However, this has no effect on the recorded image.

Regarding trademarks

- PENTAX, Optio and smc PENTAX are trademarks of PENTAX Corporation.
- SD logo  and SDHC logo  are trademarks.
- DivX, DivX Certified, and associated logos are trademarks of DivX, Inc. and are used under license.
- All other brands or product names are trademarks or registered trademarks of their respective owners.

This product supports PRINT Image Matching III.

PRINT Image Matching enabled digital still cameras, printers and software help photographers to produce images more faithful to their intentions. Some functions are not available on printers that are not PRINT Image Matching III compliant.

Copyright 2001 Seiko Epson Corporation. All Rights Reserved.

PRINT Image Matching is a trademark of Seiko Epson Corporation. The PRINT Image Matching logo is a trademark of Seiko Epson Corporation.

Red Eye software © 2003-2006 FotoNation Inc. Face Tracker software © 2005-2006 FotoNation Inc. In Camera Red Eye -- covered by U.S. Patent No. 6,407,777 and 7,042,505. Other patents Pending.

Regarding PictBridge

PictBridge allows the user to connect the printer and digital camera directly, using the unified standard for the direct printout of images. You can print images directly from the camera through a few simple operations.

- There is a possibility that the illustrations and the display screen of the LCD monitor in this manual are different from the actual product.
- Both SD memory cards and SDHC memory cards are referred to as SD memory cards in this manual.

For using your camera safely

Sufficient attention has been paid to the safety of this product but please pay particular attention to the warnings indicated by the following symbols during use.



Warning

These symbols indicate that it is possible that the user may experience serious personal injury if the warnings are not heeded.



Caution

These symbols indicate that it is possible that the user may experience minor or medium personal injury, or material loss if the warnings are not heeded.

About the Camera



Warning

- Do not attempt to take the camera apart or remodel the camera. High voltages are present within the camera, and there is therefore a danger of electric shocks if the camera is taken apart.
- If the inside of the camera should become exposed as a result of, for example, the camera being dropped, please do not under any circumstances touch such exposed portions, as there is a danger of receiving an electric shock.
- Wrapping the strap of the camera around your neck is also dangerous. Please take care that small children do not hang the strap around their necks.
- To avoid the risk of it being swallowed by mistake, keep the SD Memory Card out of the reach of small children. Seek medical attention immediately if a memory card is accidentally swallowed.
- Use an AC adapter that is of the power and voltage specified for exclusive use with this product. The use of an AC adapter other than that specified exclusively for use with this product may cause fire or electric shocks.
- If the camera emits smoke or a strange smell, or in the event of any other irregularity, stop using the camera immediately, remove the battery or disconnect the AC adapter and contact your nearest PENTAX service center. Continued use of the camera may result in fire or electric shock.

Caution

- Never try to disassemble or short the battery. Also, do not dispose of the battery in fire, as it may explode.
- Do not charge any batteries other than rechargeable lithium-ion battery D-LI8. The battery could explode or catch fire.
- Do not place your finger on the flash when it is discharging as there is a risk of burns.
- Do not discharge the flash while it is touching your clothing as there is a risk of discoloring.
- If any of the battery leakage should come in contact with your eyes, do not rub them. Flush your eyes with clean water and get medical attention immediately.
- If any of the battery leakage should come in contact with skin or clothes, wash the affected areas thoroughly with water.
- Remove the battery from the camera immediately if it becomes hot or begins to smoke. Be careful not to burn yourself during removal.
- Some portions of the camera heat up during use, so please take care, as there is a risk of low temperature burns if such portions are held for long periods of time.
- Should the LCD be damaged, be careful of glass fragments. Also, be careful not to allow the liquid crystal to get on your skin or in your eyes or mouth.

About the Battery Charger and the AC Adapter

Warning

- Do not use the product at a voltage other than the specified voltage. Use with a power source or voltage other than that designed can cause a fire or electrical shock. The specified voltage is 100-240 V AC.
- Do not disassemble or modify the product. This can cause a fire or electrical shock.
- If the generation of smoke or strange odor from the product or other abnormality occurs, immediately discontinue using and consult a PENTAX Service Center. Continuing to use the product can cause a fire or electrical shock.
- If water should happen to get inside the product, consult a PENTAX Service Center. Continuing to use the product can cause a fire or electrical shock.

- If lightning should be present during use of the battery charger or AC adapter, unplug the power cord and discontinue use. Continuing to use the product can cause damage to the equipment, fire or electrical shock.
- Wipe off the plug of the power cord if it should become covered with dust. This can cause a fire.

 **Caution**

- Do not place heavy objects on the AC plug cord, allow heavy objects to drop onto it or allow the AC plug cord to become damaged due to excessive bending. If the AC plug cord becomes damaged, consult a PENTAX Service Center.
- Do not short or touch the output terminals of the product while it is still plugged in.
- Remove the battery and unplug the AC plug cord when not using the battery charger.
- Do not plug in the AC plug cord with wet hands. This can cause an electrical shock.
- Do not subject the product to strong impacts or allow it to drop onto a hard surface. This can cause a malfunction.
- To reduce the risk of hazards, use only CSA/UL Certified power supply cord set, cord is Type SPT-2 or heavier, minimum NO.18 AWG copper, one end with a molded-on male attachment plug cap (with a specified NEMA configuration), and the other is provided with a molded-on female connector body (with a specified IEC nonindustrial type configuration) or the equivalent.
- Do not use the battery charger to charge batteries other than the ones specified. This can cause overheating or malfunctions.

Care to be Taken During Handling

- Take the Worldwide Service Network listing that is included in the package with you when traveling. This will be useful if you experience problems abroad.
- When the camera has not been used for a long time, confirm that it is still working properly, particularly prior to taking important pictures (such as at a wedding or during travelling). Contents of a recording such as images and sounds cannot be guaranteed if recording, playback or data transfer from your camera to a computer, etc. is not possible due to a malfunction of your camera or recording medium (SD Memory Card), etc.
- The lens on this camera is not exchangeable. The lens is not removable.
- Do not clean the product with organic solvents such as thinner, alcohol or benzene.
- Places of high temperature and humidity should be avoided. Particular care should be taken regarding vehicles, which can become very hot inside.
- Storing the camera where pesticides and chemicals are handled should be avoided. Remove the camera from its case and store in a well-ventilated place to prevent the camera from becoming moldy during storage.
- Do not use the camera where it may come in contact with rain, water or any other liquid, because the camera is not weather, water, or liquid resistant.
- Ensure that the camera is not subjected to substantial vibrations, shocks or pressure. Place the camera on a cushion for protection when the camera is subjected to the vibrations of a motorbike, car, or ship, etc.
- The temperature range in which the camera can be used is 0°C to 40°C (32°F to 104°F).
- The liquid crystal display will become black at high temperature but will return to normal when normal temperatures are returned to.
- The response speed of the liquid crystal display becomes slow at low temperatures. This is due to the properties of the liquid crystal and is not a fault.
- Periodic checks are recommended every 1 to 2 years in order to maintain high-performance.

- If the camera is subjected to rapid temperature changes, condensation may form on the inside and outside of the camera.
Therefore put the camera in a bag or plastic bag, and take the camera out when the difference in temperature has subsided.
- Avoid contact with garbage, dirt, sand, dust, water, toxic gases, salt, etc. as this may cause damage to the camera. If rain or drops of water get onto the camera, please wipe dry.
- Refer to “Precautions When Using an SD Memory Card” (p.22) regarding the SD Memory Card.
- Please note that the formatting an SD Memory Card or built-in memory will delete all data, however it may still be possible to recover that data using off-the-shelf data recovery software. Please manage your camera’s memory at your own risk.
- The AC plug cord supplied with the camera is for exclusive use with the Battery charger D-BC8. Do not use it with any other equipment.
- Please do not press forcefully on the LCD monitor. This could cause breakage or malfunction.
- Be careful not to sit down with the camera in your back pocket as this may damage the exterior of the camera or the LCD monitor.
- When using a tripod with the camera, be careful not to overtighten the screw in the tripod socket on the camera.

LED Safety Standard

This device is a digital still camera that conforms to the safety standard (IEC60825-1) for a Class 1 LED product.

Regarding Product Registration

To serve you better, we request that you complete the product registration, which can be found on the CD-ROM supplied with the camera or the PENTAX website.

Thank you for your cooperation.

Refer to the PC Connection Manual (bottom right of front side) for more information.

Contents

For using your camera safely	1
Care to be Taken During Handling	4
Contents of the Operating Manual	9
Checking the Contents of the Package	10
Names of Parts	11
Names of Operating Parts	12
Getting Started	13
Attaching the Strap	13
Powering the Camera	14
Installing the Battery	14
Removing the Battery	14
Charging the Battery	15
Charging the Battery Abroad	17
Using the AC Adapter (optional)	19
Installing the SD Memory Card	21
Image Size and Quality of Still Pictures	23
Size and Quality of Movies	24
Initial Settings	
(Setting the Display Language and the Date and Time)	26
Setting the Display Language	26
Setting the Date and Time	27
Quick Start	30
Taking Still Pictures	30
Playing Back Still Pictures	32
Playing Back an Image	32
Playing Back the Previous or Next Image	32
Common Operations	34
Turning the Camera On and Off	34
Using the My Album Function	34
Turning the Camera On in Playback Mode	35
Using the Button Functions	36
Capture Mode	36
Playback Mode	37
Voice Recording Mode	39
Setting the Menus	40
How to Set the Menus	40
Menu List	43
Operating the Mode Palette	45
How to operate the Mode Palette	45
Taking Pictures	48
Taking Pictures	48
Changing the Mode	48
Selecting the Capture Mode	48
Displaying Shooting Information in Capture Mode	48
Taking Pictures Using the Shake Reduction Function	51
Taking Pictures in the Basic Mode (Green Mode)	52

Taking Pictures Automatically (Auto Picture Mode)	54
Using the Exposure Mode and Other Functions.....	56
Selecting the Picture Mode According to the Shooting Scene (Picture Mode).....	60
Taking Pictures of People (Portrait Mode/Kids Mode).....	62
Taking Pictures of Dark Scenes (Night Scene Mode)	66
Reducing Camera Shake and Blurring in Pictures (Blur reduction Mode).....	67
Taking Movies (Movie Mode)	68
Taking Pictures in Frame Composite mode	70
Using the Self-timer	72
Continuous Shooting (Continuous Shooting Mode).....	73
Using the Remote Control Unit (optional).....	74
Using the Zoom to Change the Subject Size	76
Setting the Shooting Functions	78
Selecting the Focus Mode	78
Selecting the Flash Mode	81
Selecting the Recorded Pixels of Still Pictures	83
Selecting the Quality Level of Still Pictures	85
Adjusting the White Balance	86
Selecting the Autofocus Settings.....	88
Setting the Light Metering Mode to Determine the Exposure.....	91
Setting the Sensitivity	92
Setting the Exposure (EV Compensation).....	94
Selecting the Settings for Taking Movies	95
Setting the Shake Reduction for Still Pictures	98
Setting the Instant Review Time	99
Setting the Green Button	100
Setting the Image Sharpness	103
Setting the Color Saturation	104
Setting the Image Contrast.....	105
Saving the Settings	106
Saving the Menu Items (Memory)	106
Recording and Playback of Sound	108
<hr/>	
Recording Sound (Voice Recording Mode)	108
Playing Back Sound.....	110
Adding a Voice Memo	111
Recording a Voice Memo	111
Playing Back a Voice Memo	112
Playback/Deleting/Editing	113
<hr/>	
Playing Back Images	113
Playing Back Still Pictures	113
Zoom Display	113
Playing Back Movies	115
Displaying Shooting Information in Playback Mode	116
Nine-Image Display/Calendar Display.....	117
Slideshow	119
Deleting Images, Movies and Sounds	121
Deleting a Single Image, Movie or Sound	121

Deleting All Images	123
Deleting Selected Images and Sound Files (from Nine-Image Display)	124
Protecting Images, Movies and Sounds from Deletion (Protect)	126
Viewing Images on AV Equipment	128
Playing Back an Image Using the Remote Control Unit (optional)	129
Setting the Printing Service (DPOF)	130
Printing Single Images	130
Printing All Images	132
Direct Printing Using PictBridge	133
Connecting the Camera to the Printer	133
Printing Single Images	134
Printing All Images	135
Printing Using the DPOF Settings	136
Disconnecting the Camera from the Printer	136
Editing Images	137
Changing the Image Size and Quality	137
Cropping Images	139
Rotating the Displayed Image	140
Editing Pictures with Color Filters	141
Editing Pictures with the Digital Filter	143
Editing Pictures with Brightness Filter	145
Editing Movies	147
Removing Red-eye	150
Adding a Frame (Frame Composite)	152
Copying Files	154
Settings	156
<hr/>	
Camera Settings	156
Setting Up the Start-up Screen	156
Formatting an SD Memory Card or the Built-in Memory	158
Changing the Sound Settings	159
Changing the Date and Time	162
Setting the World Time	164
Changing the Display Language	166
Changing the Image Folder Name	167
Changing the USB Connection Mode	168
Changing the Video Output Format	169
Adjusting the Brightness of the LCD Monitor	170
Setting Power Saving	171
Setting Auto Power Off	172
Setting the Guide Display	172
Resetting to Default Settings	173
Appendix	174
<hr/>	
List of City	174
Default Settings	175
Optional Accessories	180
Messages	181
Troubleshooting	183
Main Specifications	185
WARRANTY POLICY	188
Index	193

Contents of the Operating Manual

This operating manual contains the following chapters.

1 Getting Started

This chapter explains what you need to do after purchasing the camera before you start taking pictures. Be sure to read it and follow the instructions.

2 Quick Start

This chapter explains the simplest way to take pictures and play back images. Use it if you want to start taking pictures straightaway.

3 Common Operations

This chapter explains common operations such as the functions of the buttons and how to use the menus. For more details, refer to the respective "Taking Pictures", "Recording and Playback of Sound", "Playback/Deleting/Editing" and "Settings" chapters.

4 Taking Pictures

This chapter explains the various way of capturing images and how to set the relevant functions, including how to use the Capture Mode screen to select the capture mode best suited to the situation.

5 Recording and Playback of Sound

This chapter explains how to record sound only or add a voice memo to an image, and how to play back voice memos.

6 Playback/Deleting/Editing

This chapter explains how to play back images on the camera or on a TV, how to delete, resize and crop images, and how to print images directly to the printer.



7 Settings

This chapter explains how to set the camera-related functions.

8 Appendix

This tells you about the messages displayed on the LCD monitor and what to do in the event of trouble.

The meanings of the symbols used in this operating manual are explained below.

	indicates the reference page number for an explanation of the related operation.
	indicates information that is useful to know.
	indicates precautions to be taken when operating the camera.

1

2

3

4

5

6

7

8

Checking the Contents of the Package



Camera
Optio A20

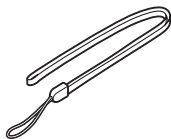

Strap
O-ST20 (*)

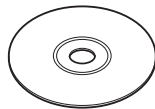

Software (CD-ROM)
S-SW56



AV cable
I-AVC7 (*)

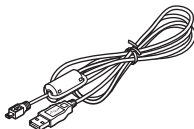

USB cable
I-USB17 (*)



Rechargeable
lithium-ion battery
D-LI8 (*)

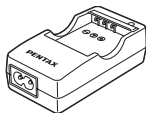

Battery charger D-BC8 (*)



AC plug cord
D-CO2



Operating Manual
(this manual)

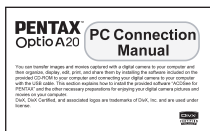

Operating Manual
(PC Connection Manual)

Items marked with an asterisk (*) are also available as optional accessories.
For other optional accessories, refer to "Optional Accessories" (p.180).

Names of Parts

Front

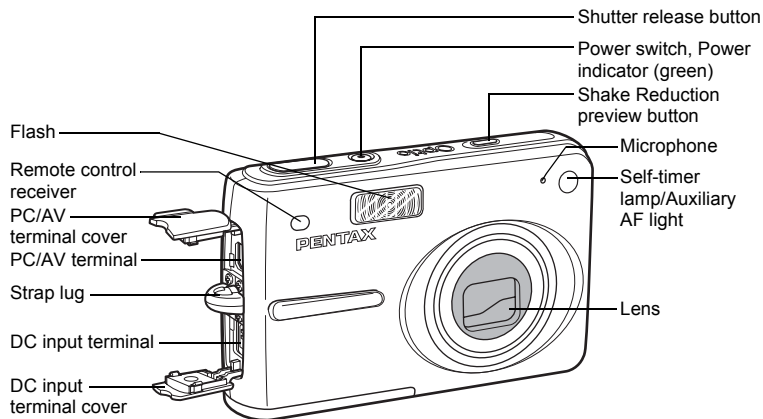

Back

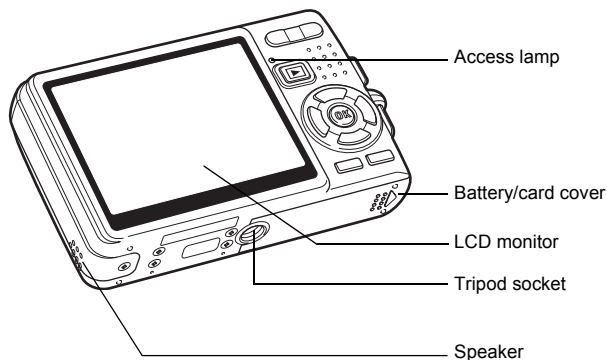

Names of Operating Parts

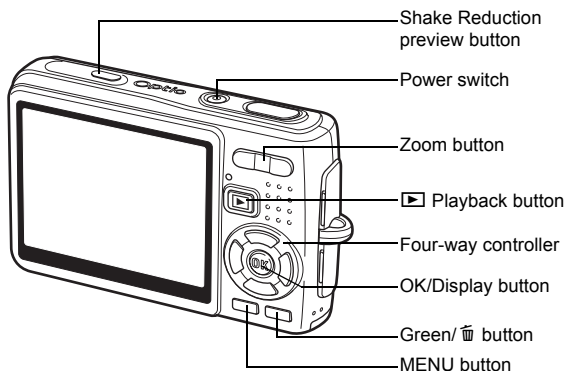

Four-way controller

In this operating manual, the four-way controller is described as shown below.

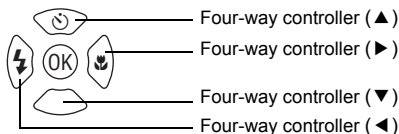

Guide Indications

A guide to available button operations appears on the LCD monitor during operation.

The buttons are indicated as shown below.

Four-way controller (▲)	▲
Four-way controller (▼)	▼
Four-way controller (◀)	◀
Four-way controller (▶)	▶
MENU button	
Shutter release button	
OK button	

Zoom button	
for digital zoom	
for cropping	
Green/🗑️ button	
for operating as the Green button	
for deleting an image	

Attaching the Strap

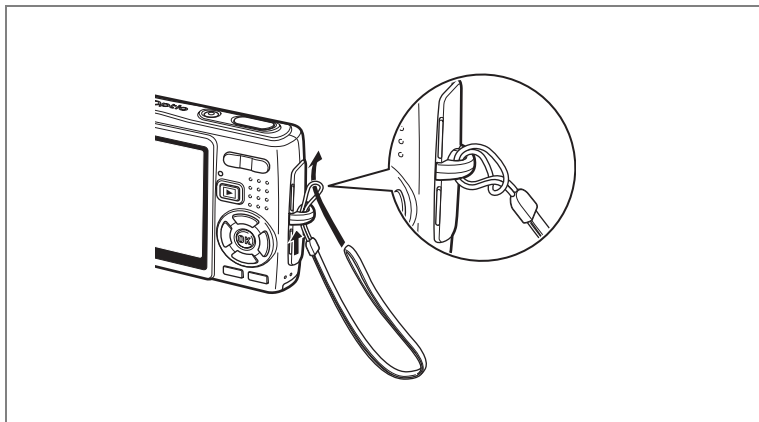

Pass the narrow end of the strap through the strap lug and pass the other end through the loop.

Powering the Camera

1

Getting Started

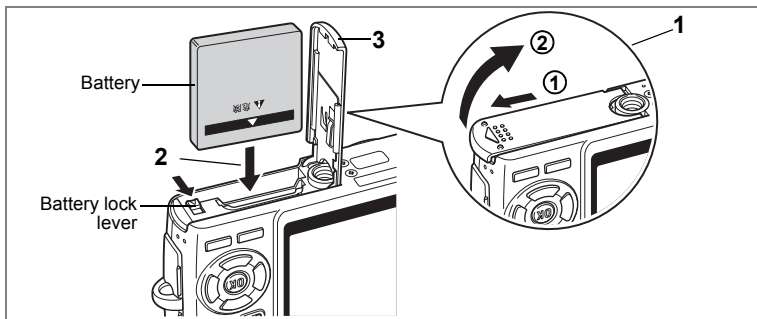

Installing the Battery

Install the battery provided with the camera.

- 1 Open the battery/card cover.**
Slide the battery/card cover in the direction indicated by the arrow ① and flip the cover open ②.
- 2 Insert the battery with the ▲ symbol facing toward the LCD monitor while using the side of the battery to press the battery lock lever in the direction indicated by the arrow.**
- 3 Close the battery/card cover.**

Removing the Battery

- 1 Open the battery/card cover.**
- 2 Release the battery by using your finger to press the battery lock lever in the same direction as when you inserted the battery.**

The battery will be ejected. Pull the battery out of the camera.



If you intend to use the camera continuously for a long period, use of the AC adapter kit K-AC8 (optional) is recommended. (p.19)



- Insert the battery correctly. If the battery is incorrectly oriented, it may cause a malfunction.
- Do not remove the battery when the camera is turned on.
- If you do not intend to use the camera for a long time, remove the battery.
- If the camera is left without the battery for a long time, the date will be reset.

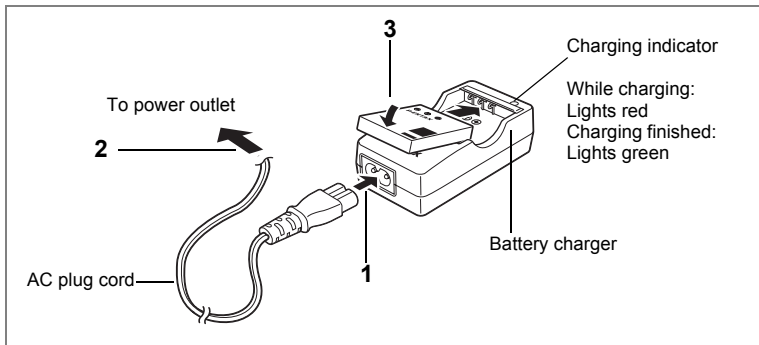

Charging the Battery

Use the battery charger to charge the battery before installing it in the camera for the first time or after a long period of non-use, or when the message [Battery depleted] appears.

- 1** Connect the AC plug cord to the battery charger D-BC8.
- 2** Plug the AC plug cord into the power outlet.
- 3** Place the battery in the charger so that the PENTAX logo is visible.

The charging indicator lights red while the battery is charging. It lights green when charging is finished.

- 4** Remove the battery from the battery charger when charging is finished.



- The time required to fully charge the battery is about 100 minutes (max.). The appropriate ambient temperature for charging the battery is 0°C to 40°C (32°F to 104°F). (The charging time may vary depending on the ambient temperature and charging conditions.)
- The battery has reached the end of its service life if it runs down soon after being charged. Replace with a new battery.



- Do not use the battery charger D-BC8 to charge batteries other than D-LI8 rechargeable lithium-ion batteries, as the charger may overheat or be damaged.
- If the battery is inserted correctly but the charging indicator fails to light, the battery may be faulty. Replace it with a new battery.

• Approximate Operating Time (when the D-LI8 battery is fully charged)

Number of recordable images: Approx. 150 (at 23°C with the LCD monitor on and the flash used for 50% of shots)

Playback time: Approx. 100 min.

Movie recording time: Approx. 50 min.

Sound recording time: Approx. 110 min.

- The number of recordable images are based on CIPA standard measurement and may vary depending on capture mode and shooting conditions.



- In general, battery performance temporarily deteriorates as the temperature decreases. When using the camera in a cold environment, keep it warm by putting it in your pocket or inside your coat. Battery performance that has deteriorated due to low temperature will be restored when the battery is returned to room temperature.
- Be sure to take a spare battery with you when traveling abroad or to a cold region, or if you intend to take a lot of pictures.

• Battery Level Indicator

You can check the battery level by the  symbol on the LCD monitor.



(lit green) : Adequate power remains.



(lit green) : Battery is running low.



(lit yellow) : Battery is running very low.



(lit red) : Battery is exhausted.



[Battery depleted] : The camera will turn off after the message appears.

• Recycling Batteries



This symbol indicates that the battery is recyclable. Cover the terminals with insulating tape and take the battery to a store displaying this symbol.

Li-ion

Charging the Battery Abroad

The battery charger supplied with the camera is designed to switch automatically to the voltage (100-240V) and frequency (50Hz, 60Hz) of the electricity supply in the country or region where used.

However, electrical socket shapes differ depending on the country or region. Before traveling abroad, you are advised to check the socket shape in your destination (see “Main Socket Types in the Major Countries and Regions of the World” (p.18)) and take an appropriately shaped off-the-shelf adapter plug with you. (Electrical socket shapes may vary depending on every region in the country. Check the socket shape used in the region.)

The socket shape does not affect the charging method.

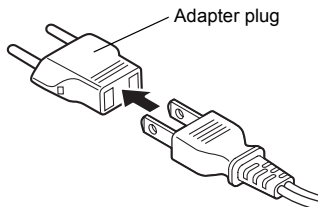

- Use of an off-the-shelf transformer may lead to defective operation.
- Unplug the adapter plug from the power outlet when the battery charger is not in use.

Type	A	B	BF	C	S
Shape					
Adapter plug					

Main Socket Types in the Major Countries and Regions of the World

1

Getting Started

		A	B	BF	C	S
North America	U.S.A., Canada	✓				
Europe, Former Soviet Union	Iceland, Ireland, Italy, Ukraine, Austria, Netherlands, Kazakhstan, Greece, Sweden, Denmark, Germany, Norway, Hungary, Finland, France, Belarus, Belgium, Rumania, Russia				✓	
	U.K.		✓	✓		
	Spain	✓			✓	
	Switzerland, Poland, Portugal		✓		✓	
Asia	Taiwan, Japan	✓				
	Sri Lanka, Maldives		✓			
	Nepal, Bangladesh, Mongolia				✓	
	Vietnam	✓			✓	
	India, Indonesia, Pakistan, Macau		✓		✓	
	Thailand	✓		✓	✓	
	Korea	✓	✓		✓	
	Philippines	✓			✓	✓
	Singapore, Hong Kong		✓	✓		
	China	✓	✓	✓	✓	✓
	Malaysia		✓	✓	✓	
Oceania	Australia, Tonga, New Zealand, Fiji					✓
	Guam	✓				
	Tahiti				✓	
Central and South America	Colombia, Jamaica, Haiti, Panama, Bahamas, Puerto Rico, Venezuela, Mexico	✓				
	Brazil, Peru	✓			✓	
	Chile		✓		✓	
	Argentina			✓	✓	✓
Middle East	Israel, Iran				✓	
	Kuwait		✓		✓	
	Jordan		✓	✓		
Africa	Canary Islands, Guinea, Mozambique, Morocco				✓	
	Kenya, South Africa		✓		✓	
	Algeria	✓	✓	✓		
	Egypt		✓	✓	✓	
	Zambia, Tanzania		✓	✓		

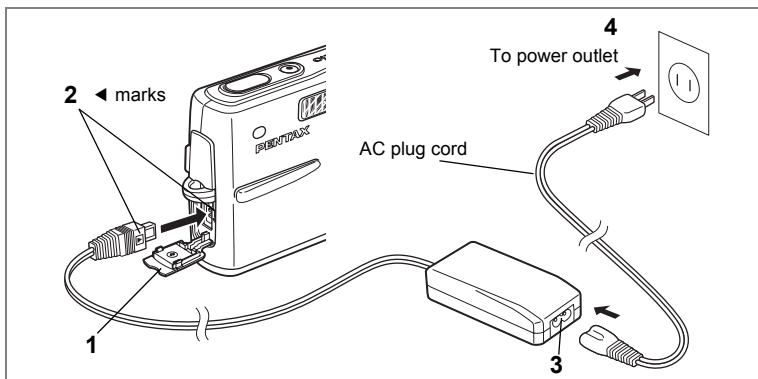

Using the AC Adapter (optional)

If you intend to use the LCD monitor for a long time or connect the camera to a PC, use of the AC adapter kit K-AC8 (optional) is recommended.

- 1** Make sure that the camera is turned off and open the DC input terminal cover.
- 2** Connect the DC terminal on the AC adapter to the DC input terminal on the camera, being sure to match the ◀ marks.
- 3** Connect the AC plug cord to the AC adapter.
- 4** Plug the AC plug cord into the power outlet.



- Make sure that the camera is turned off when connecting or disconnecting the AC adapter.
- Make sure that the AC plug cord and connecting cable are inserted securely. The data may be lost if the cable becomes disconnected while you are taking pictures.
- Be sure to read the operating manual accompanying the AC adapter before using the adapter.
- Be sure to match the ◀ marks when connecting the DC terminals. Inserting the plugs with too much force may damage them.

Precautions When Using the Battery Charger or AC Adapter

To avoid the risk of fire or electric shock when using the battery charger or AC adapter, be sure to read the section on “For using your camera safely” on page 1. Refer to page 187 for the specifications of the battery charger and AC adapter.

Installing the SD Memory Card

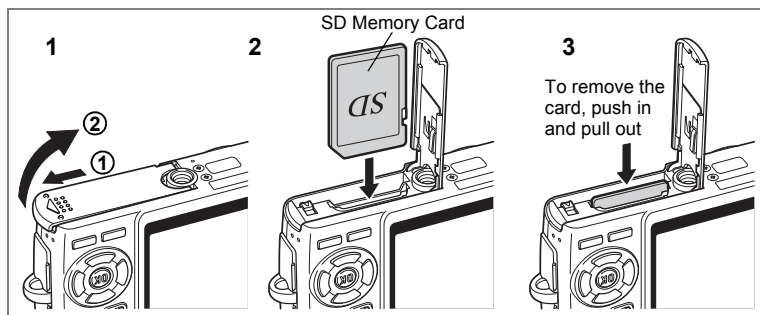

An SD Memory Card can be used with this camera. Captured images are recorded on the SD Memory Card if a card is inserted or in the built-in memory if no card is inserted.



- Make sure that the camera is turned off before inserting or removing the SD Memory Card.
- Be sure to format unused cards or cards that have been used on another camera. Refer to "Formatting an SD Memory Card or the Built-in Memory" (p.158) for instructions on formatting.

1 Open the battery/card cover.

Slide the battery/card cover in the direction indicated by the arrow ① and flip the cover open ②.

2 Insert an SD Memory Card so the label (the side with the ▲ symbol) is facing toward the LCD monitor and push the card in until it clicks.

3 Close the battery/card cover.

To remove the card, eject the card by pressing it in the direction indicated by the arrow and pull it out.



The number of recordable images varies depending on the capacity of the SD Memory Card or built-in memory and the selected image size and quality. (p.23)

Data Backup

Very occasionally, data stored in the built-in memory becomes unreadable. As a backup measure, we recommend that you download important data to a PC or store the data in a medium other than the built-in memory.

Precautions When Using an SD Memory Card

- Make sure that the camera is turned off before opening the battery/card cover.
- The SD Memory Card is equipped with a write-protect switch. Write-protect switch
Setting the switch to [LOCK] protects the existing data by prohibiting recording of new data, deletion of existing data or formatting of the card.
- Care should be taken if you remove the SD Memory Card immediately after using the camera, as the card may be hot.
- Do not remove the SD Memory Card or turn the camera off while data is being recorded on the card, images or sound are being played back, or the camera is connected to a PC with the USB cable as this may cause the data to be lost or the card to be damaged.
- Do not bend the SD Memory Card or subject it to violent impact. Keep it away from water and store away from high temperature.
- Be sure to format unused cards or cards that have been used on another camera. Refer to "Formatting an SD Memory Card or the Built-in Memory" (p.158) for instructions on formatting.
- Do not remove the SD Memory Card during formatting as this may damage the card and render it unusable.
- The data on the SD Memory Card may be deleted in the following circumstances. PENTAX does not accept any liability for data that is deleted
 - (1) when the SD Memory Card is mishandled by the user.
 - (2) when the SD Memory Card is exposed to static electricity or electrical interference.
 - (3) when the card has not been used for a long time.
 - (4) when the card is ejected, the AC adapter is disconnected or the battery is removed while the data on the card is being recorded or accessed.
- The SD Memory Card has a limited service life. If it is not used for a long time, the data on the card may become unreadable. Be sure to regularly make a backup of important data on a PC.
- Avoid using or storing the card where it may be exposed to static electricity or electrical interference.
- Avoid using or storing the card in direct sunlight or where it may be exposed to rapid changes in temperature or to condensation.
- When using an SD Memory Card with a slow recording speed, recording may stop while you are taking movies even when there is adequate space in the memory, or shooting and playback may take a long time.
- When you purchase the SD Memory Card, access the PENTAX website and confirm beforehand if they have compatibility with your camera. Inquiries on the card compatibility can also be answered by your nearest PENTAX service center.
- If you are going to discard, give away or sell your SD Memory Card, you should ensure that the data on the card is completely deleted or the card itself is destroyed if it contains any personal or sensitive information. Please note that formatting the SD Memory Card will not necessarily delete the data so that it cannot be recovered using off-the-shelf data recovery software. There are off-the-shelf secure data deletion software programs available that will completely delete the data. In any case, the data on your SD Memory Card should be managed at your own risk.

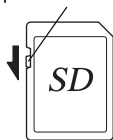

Image Size and Quality of Still Pictures

Select the image size and quality best suited to your purpose. Higher quality levels and numbers of recorded pixels produce clearer images for printing, but the resulting increase in file size reduces the total number of pictures that can be taken.

When you select high image quality as well as a large image size, it may take ten seconds or more for the camera to finish recording after shooting.

Select the appropriate number of recorded pixels and quality level on the [📷 Rec. Mode] menu.

How to Set the Menus 📖p.40

Selecting the Recorded Pixels of Still Pictures 📖p.83

Selecting the Quality Level of Still Pictures 📖p.85

● Appropriate Sizes According to Use

10M (3648×2736)	↑ Clear, Fine	For printing images with high-resolution settings in your printer, printing at A4 size or larger, or editing and processing images
7M (3072×2304)		
5M (2592×1944)		For printing at postcard size For using as images on websites, or attaching images to e-mails
3M (2048×1536)		
2M (1600×1200)		
1024 (1024×768)		
640 (640×480)		

The default setting is 10M (3648×2736).

● Appropriate Quality According to Use

★★★	Best	Lowest compression ratio. Suitable for large A4-size photo prints.
★★	Better	Standard compression ratio. Suitable for photo prints or viewing images on a computer screen.
★	Good	Highest compression ratio. Suitable for attaching to e-mails or creating websites.

The default setting is ★★.

● Approximate Number of Recordable Images by Size and Quality

Quality Level Recorded Pixels	★★★ Best	★★ Better	★ Good	Sound
10M (3648×2736)	74	107	149	4 hr. 19 min. 59 sec.
7M (3072×2304)	104	151	210	
5M (2592×1944)	147	213	296	
3M (2048×1536)	223	323	448	
2M (1600×1200)	313	453	628	
1024 (1024×768)	571	826	1144	
640 (640×480)	1048	1515	2098	

- The table above indicates the approximate number of images and recording time when using a 256MB SD Memory Card.
- The table above is based on standard shooting conditions specified by PENTAX and may vary depending on the subject, shooting conditions, capture mode, SD Memory Card, etc.

Size and Quality of Movies

Select the size and quality best suited to your purpose.

The larger size and the higher quality level ★ are selected, the clearer moving images are produced, but the file size is increased.

Select the appropriate size and quality on the [📷 Rec. Mode] menu.

Selecting the Recorded Pixels of Movies 📷p.95

Selecting the Quality Level of Movies 📷p.96

● Appropriate Sizes (Recorded Pixels) According to Use

640 (640×480)	Viewing high-quality movies at VGA size. The recordable time is shorter.
320 (320×240)	Smaller file size allows a longer time recording.

The default setting is 640 (640×480).

● Approximate Recordable Time by Size (Recorded Pixels) and Quality

Quality Level Recorded Pixels	★★★ Best	★★ Better	★ Good
640 (640×480)	11 min. 35 sec.	14 min. 30 sec.	17 min. 25 sec.
320 (320×240)	44 min. 47 sec.	55 min. 39 sec.	64 min. 10 sec.

The default setting is ★★★.

- The table above indicates the approximate recording times when using a 256 MB SD Memory Card.
- The table above is based on standard shooting conditions specified by PENTAX and may vary depending on the subject, shooting conditions, capture mode, SD Memory Card, etc.

Initial Settings (Setting the Display Language and the Date and Time)

1

Getting Started

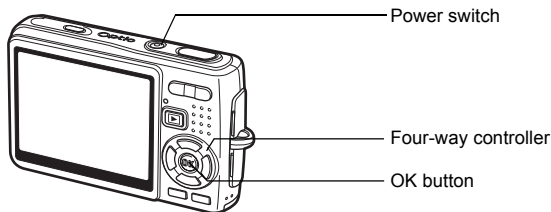

If the Initial Setting screen or Date Adjust screen appears when you turn the camera on, follow the procedure below to set the display language and/or current date and time.

If the Initial Setting screen appears:

☞ p.26 - 27 “Setting the Display Language”, “Setting the Date and Time”

If the Date Adjust screen appears:

☞ p.27 - 28 “Setting the Date and Time”

If you want to change the initial settings, refer to “Changing the Date and Time” (p.162) and “Changing the Display Language” (p.166).

Setting the Display Language

You can select the language in which the menus, error messages, etc. are displayed from the following: [English], [French], [German], [Spanish], [Portuguese], [Italian], [Swedish], [Dutch], [Russian], [Thai], [Korean], [Chinese (traditional and simplified)] and [Japanese].

1 Press the four-way controller (►).

The Language/言語 screen appears.

2 Use the four-way controller (▲▼◀▶) to select a language.

The default setting is English.

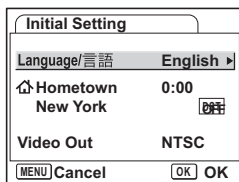

- 3 Press the OK button.**
- 4 Press the four-way controller (▼).**
The frame moves to [↕].
- 5 Use the four-way controller (◀▶) to select the desired city (Hometown).**
- 6 Press the four-way controller (▼).**
The frame moves to [DST] (Daylight Saving Time).
- 7 Use the four-way controller (◀▶) to select [(On) / (Off)].**
- 8 Press the OK button.**
The Date Adjust screen appears.

Setting the Date and Time

Set the current date and time and the display style.

- 1 Press the four-way controller (▶).**
The frame moves to [mm/dd/yy].
- 2 Use the four-way controller (▲▼) to select the date display style.**
- 3 Press the four-way controller (▶).**
The frame moves to [24h].
- 4 Use the four-way controller (▲▼) to select [24h] (24-hour display) or [12h] (12-hour display).**
- 5 Press the four-way controller (▶).**
The frame returns to [Date Style].

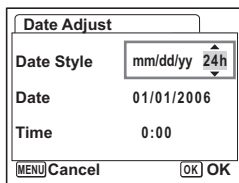
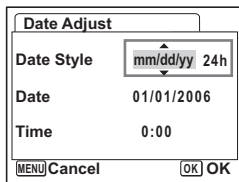

6 Press the four-way controller (▼).

The frame moves to [Date].

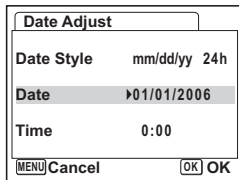
**7 Press the four-way controller (▶).**

The frame moves to the month.

8 Use the four-way controller (▲▼) to change the month.

Change the day and year in the same manner.

Next, change the time.

If you have selected [12h] in Step 4, the setting switches between am and pm corresponding to the time.

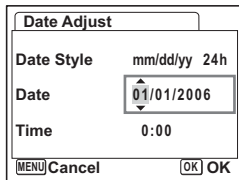

- When you finish the settings and press the OK button, the camera clock is reset to 00 seconds.
- To set the exact time, press the OK button when the time signal (on the TV, radio, etc.) reaches 00 seconds.



- When the Initial Settings screen is displayed, you can cancel the setting operation and switch to Capture mode by pressing the MENU button. In this case, the Initial Setting or Date Adjust screen will appear next time you turn the camera on.
- You can change the settings on the menu. Refer to the pages below for details.

Language: “Changing the Display Language” (p.166)

City, Daylight saving time: “Setting the World Time” (p.164)

Date and Time: “Changing the Date and Time” (p.162)

- The video output format is automatically set in conjunction with the language you have selected as listed below. If the output format is different from the one used in your country or region, change the format following the steps in “Changing the Video Output Format” (p.169).

Language	Video Output Format
English (English)	NTSC
French (Français)	PAL
German (Deutsch)	PAL
Spanish (Español)	PAL
Portuguese (Português)	PAL
Italian (Italiano)	PAL
Sweden (Svenska)	PAL
Netherlands (Nederlands)	PAL
Russian (Русский)	PAL
Thai (ไทย)	PAL
Korean (한국어)	NTSC
Chinese (traditional) (中文繁體)	PAL
Chinese (simplified) (中文简体)	PAL
Japanese	NTSC

Taking Still Pictures

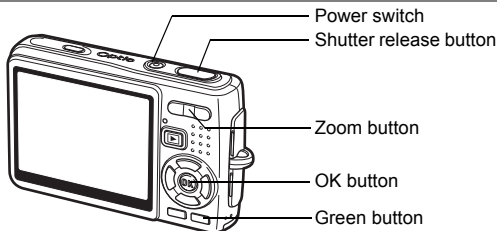

The simplest procedure for taking still pictures is described below. The flash fires automatically depending on the light conditions.

1 Press the power switch.

The camera turns on.

2 Confirm the subject and shooting information on the LCD monitor.

The focus frame in the center of the LCD monitor indicates the zone of automatic focusing. You can change the size of the subject by pressing the zoom button.



Zoom button(♦) : Enlarges the subject.

Zoom button(♦♦♦) : Diminishes the subject.

3 Press the shutter release button halfway.

The focus frame on the LCD monitor will light green when the camera is in focus.

4 Press the shutter release button fully.

The image appears on the LCD monitor for 0.5 seconds (Instant Review) and is recorded on the SD Memory Card or in the built-in memory.

Using the Shutter Release Button

The shutter release button works in a two-step action as follows.

Press halfway

The focus and exposure are locked when the shutter release button is pressed lightly (halfway). The shutter speed and aperture settings only appear on the LCD monitor when the shutter release button is pressed halfway. The focus frame on the LCD monitor will light green when the subject is in focus while the shutter release button is pressed halfway. The frame does not appear if the subject is out of focus.

Press down fully

Press the shutter release button all the way down (fully) to take a picture.

[Poor focusing conditions]

The camera may not be able to focus under the following conditions. In this case, lock the focus on an object the same distance away as the subject (by pressing the shutter release button halfway), then aim the camera at your subject and press the shutter release button fully.

- Objects that lack contrast such as a blue sky or white wall
- Dark places or objects, or conditions that prevent light from being reflected back
- Finely patterned object
- Fast moving objects
- When there is an object in the foreground and an object in the background in the same picture
- Strongly reflected light or strong backlighting (bright background)

Instant Review

The [Instant Review] default setting is 0.5 seconds. During this time, you can delete the image by pressing the Green button, selecting [Delete] when the [Delete] menu appears and pressing the OK button. (p.121)

Setting the Instant Review Time p.99

Playing Back Still Pictures

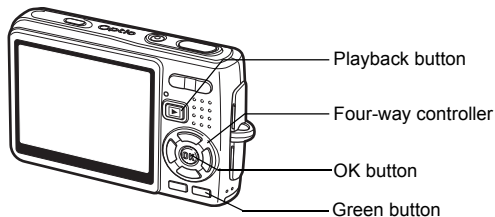

Playing Back an Image

You can display the still picture you have just taken.

- 1 Press the  Playback button after taking a picture.**

The image appears on the LCD monitor.



Zoom Display  p.113

Playing Back the Previous or Next Image

Still pictures can be played back one at a time, proceeding either forward or backward.

- 1 Press the  Playback button after taking a picture.**

The image appears on the LCD monitor.

- 2 Press the four-way controller ( .**

Four-way controller (): Displays the previous image.

Four-way controller (): Displays the next image.

Deleting the Displayed Image

1 Press the Green button when playing back an image.

The screen for deleting the image appears.

2 Press the four-way controller (▲) to select [Delete] and press the OK button.

The image displayed on the LCD monitor is deleted.

3 Press the ▶ Playback button again or press the shutter release button halfway.

The camera is ready for taking pictures.



- The last picture taken appears on the LCD monitor when you switch to the Playback mode.
- You can enlarge the image displayed on the LCD monitor by pressing the zoom button. (If you press the zoom button to enlarge a rotated image, the enlarged image will return to its original position. If you stop enlarging the image, the image will be rotated again.)
- If there is no image stored, the message [No image/sound] appears.

Zoom Display p.113

Deleting a Single Image, Movie or Sound p.121

Turning the Camera On and Off

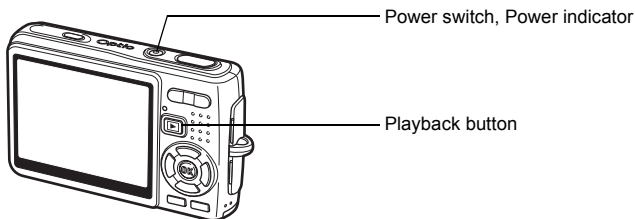



3

1 Press the power switch.

The power indicator lights up in green. The lens extends and the camera turns on in the Capture mode.

The camera is ready for taking pictures by pressing the shutter release button.

- Press the  Playback button to switch to the Playback mode and view pictures while the lens is extended.
- Hold down the  Playback button for two seconds to activate the Playback mode with the lens retracted.
- Hold down the  Playback button for more than four seconds to display the pictures stored in the built-in memory with the SD Memory Card inserted.

2 Press the power switch again.

The camera turns off.

Switching between Capture Mode and Playback Mode
 p.48

Using the My Album Function

This camera has a built-in memory, but the built-in memory becomes hidden when an SD Memory Card is inserted. You can activate the built-in memory using the following procedure. You can save your favorite pictures, movies, and sounds in the built-in memory and use the built-in memory as a private album.

- 1 **Confirm the SD Memory Card is set in the camera.**
- 2 **Hold down the  Playback button for more than four seconds in Capture Mode.**

The lens retracts two seconds after you start holding down the  Playback button, and the contents of the built-in memory are displayed two seconds later.





- When you turn the power off and on or switch from Playback Mode to Capture Mode, the My Album function is canceled and the SD Memory Card becomes activated.
- While using the My Album function, you cannot access the SD Memory Card, so you cannot copy files between the built-in memory and the SD Memory Card. Cancel the My Album function to copy the files.
- While using the My Album function, you cannot perform formatting.

To Copy Files from the SD Memory Card to the Built-in Memory  p.155

Turning the Camera On in Playback Mode

- 1 **Press the power switch while pressing the  Playback button.**

The power indicator lights green and the camera turns on in the Playback mode with the lens retracted.

- **Press the  Playback button to extend the lens and switch to the Capture mode.**
- **Hold down the  Playback button for more than two seconds in the Capture mode or press the  Playback button in the Voice Recording mode to switch to the Playback mode with the lens retracted.**



The power may be turned off when the power switch is held for a while.

Playing Back Still Pictures  p.32

Using the Button Functions

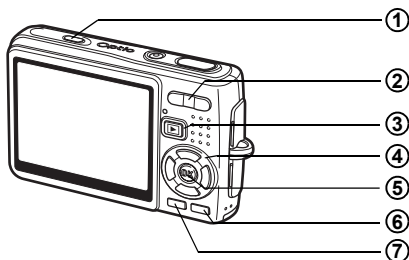

3

Common Operations

Capture Mode

- 1 Shake Reduction preview button**
Enables you to review an image compensated with the shake reduction system on the LCD monitor while taking a still picture. (☞p.51)
- 2 Zoom button**
Changes the size of the subject. (☞p.30)
- 3 Playback button**
Switches to the Playback mode. When pressed again, returns to Capture mode. (☞p.32)
- 4 Four-way controller ()**
() Changes the focus mode. (☞p.78)
() Changes the drive mode. (☞p.72 to p.75)
() Displays the Capture Mode Palette. (☞p.45)
() Changes the flash mode. (☞p.81)
- 5 OK/Display button**
Changes the information displayed on the LCD monitor. (☞p.48)
- 6 Green/ button**
Enters Green Mode. (☞p.52)
You can assign a different function to the Green button by selecting [Green Button] in the [☑ Rec.Mode] menu. (☞p.100)
- 7 MENU button**
Displays the [☑ Rec.Mode] menus. (☞p.40)

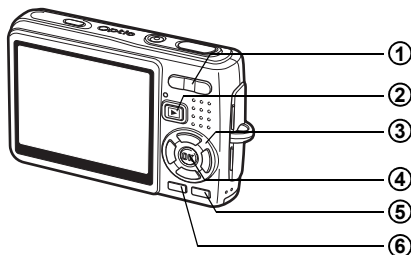

Playback Mode

① ▲▲▲/▲ Zoom button

Press ▲▲▲/☒ in single-image display to switch to nine-image display. Press ▲/Q to return to the previous display. (☞p.117)

Press ▲/Q to enlarge the image in single-image display. Press ▲▲▲/☒ to return to the previous display. (☞p.113)

Press ▲▲▲/☒ in nine-image display to switch to the calendar display. (☞p.117)

② ▶ Playback button

Switches to Capture mode. When switched to the Playback mode by pressing the ▶ Playback button in Voice Recording mode, pressing the ▶ Playback button again switches to the Voice Recording mode.

③ Four-way controller

For playing back still images

(◀▶) : Displays the previous or next image in single-image display. (☞p.32)

When rotating the displayed image, the image is rotated 90 degrees clockwise each time you press the (▶), and 90 degrees counter clockwise each time you press the (◀). (☞p.140)

(▼) : Displays the Playback Mode Palette. (☞p.47)

(▲▼◀▶) : Moves the display area of the enlarged image. (☞p.113)

Selects an image in nine-image display. (☞p.117)

Selects a date in calendar display. (☞p.117)

For playing back movies

(▲) : Plays back and pauses a movie. (☞p.115)

(◀▶) : Frame forwards, frame reverses, fast forwards and reverses a movie during playback. (☞p.115)

(▼) : Stops a movie during playback. (☞p.115)

For playing back voice recording files (☞p.110)

(▲) : Starts playback. When pressed again, pauses playback.

(◀▶) : Selects a recorded file before playback. Performs the following operations during playback.

Files with no recorded indexes:

(◀) Rewinds five seconds.

(▶) Advances five seconds.

Files with recorded indexes:

(◀) Starts playback from the previous index.

(▶) Starts playback from the next index.

④ **OK/Display button**

Changes the information displayed on the LCD monitor. (☞p.116)

Returns to a single-image display in nine-image display. (☞p.117)

Displays the selected image full screen in calendar display. (☞p.117)

⑤ **Green/🗑️ button**

Deletes the image displayed on the LCD monitor. (☞p.121)

⑥ **MENU button**

Displays the [📷 Rec.Mode] menus. (☞p.40)

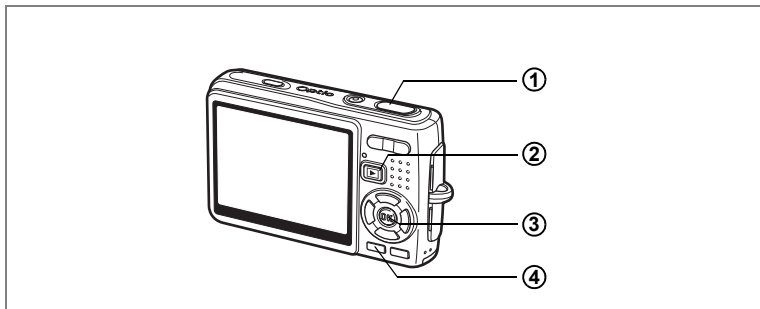

Voice Recording Mode

- ① **Shutter release button**
When pressed, starts recording. When pressed again, stops recording.
When pressed for more than one second, recording continues for as long as the button is held down and stops when the button is released.
- ② **▶ Playback button**
Switches to Playback mode. (☞p.35) When pressed again, returns to Voice Recording mode.
- ③ **OK/Display button**
Turns the LCD monitor on and off.
- ④ **MENU button**
When pressed during recording, an index can be added.
When pressed during standby or before playback, displays the [📷 Rec.Mode] menu. (☞p.40)

Setting the Menu

When you press the MENU button, the menus appear on the LCD monitor. You can set functions, save the settings and change the camera settings on these menus.

How to Set the Menu

When you are making settings from a menu, a guide for operation appears on the LCD monitor.

- 1 Press the MENU button.**
The [📷 Rec.Mode] menu appears.
The selected area is highlighted.
- 2 Press the four-way controller (◀▶).**
Changes the menu screen.
- 3 Use the four-way controller (▲▼) to select an item.**
Moves the highlight up or down.
- 4 Press the four-way controller (▶).**
A pull-down menu or setting screen appears.
The pull-down menu displays only those items that can be selected with the current camera settings.
- 5 Use the four-way controller (▲▼) to change the setting.**
The setting changes each time the four-way controller (▲▼) is pressed.

To Save the Setting and Start Taking Pictures

- 6 Press the shutter release button halfway.**
The setting is saved and the camera is ready for taking pictures.
When the shutter release button is pressed fully, the picture is taken.

To Save the Setting and Begin Playback of Images

6 Press the Playback button.

The setting is saved and the camera returns to playback status.

To Save the Setting and Continue with Menu Operations

6 Press the OK button or the four-way controller (◀).

The setting is saved and the screen returns to Step 3.

To Cancel the Changes and Continue with Menu Operations

6 Press the MENU button.

The changes are canceled and the screen returns to Step 3.

The MENU button functions differ depending on the screen. Refer to the guide indications.

 Exit : Saves the current setting, exit the operation and return to the original screen (Capture or Playback mode).

  : Saves the current setting and return to Step 1.

 Cancel: Cancels the current selection, exit the operation and return to Step 3.

Caution

- If you press the MENU button with the pull-down menu displayed, the setting is canceled.
- If you press the OK button, the MENU button or the four-way controller (◀) with the pull-down menu displayed, the menu returns to the screen used for selecting an item.
- The menu is exited automatically one minute after the last operation.

Example of Menu Operation

1 MENU button



[📷 Rec.Mode] Menu

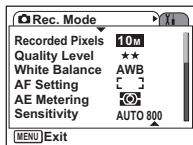

2

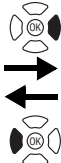

[⚙️ Set-up] Menu

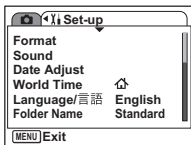

3

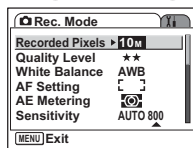

3

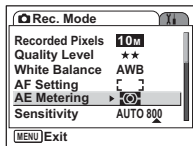

4

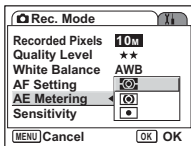
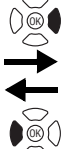

3

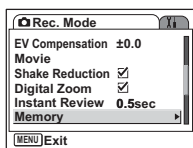

4'

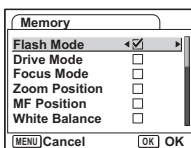
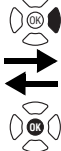

Select Screen

3



To the next screen

Menu List

[📷 Rec.Mode] Menu

Item		Description	Page
Recorded Pixels		For selecting the number of pixels	p.83
Quality Level		For selecting the image compression ratio	p.85
White Balance		For adjusting the color balance according to lighting	p.86
AF Setting	Focusing Area	For changing the area of the autofocus	p.88
	Focus Limiter	For limiting the focusing range of the lens in accordance with the shooting conditions	p.89
	Aux. AF Light	For focusing with auxiliary AF light when the subject is dim and the autofocus does not function properly	p.90
AE Metering		For setting the metering method to determine the exposure	p.91
Sensitivity		For setting the sensitivity	p.92
EV Compensation		For adjusting the exposure between -2.0EV and +2.0EV	p.94
Movie	Recorded Pixels	For selecting the recorded pixels of the movie	p.95
	Quality Level	For selecting the quality level of the movie	p.96
	Movie anti-shake	For compensating for camera shake of the movie automatically	p.97
Shake Reduction		For reducing camera shake while taking still pictures	p.98
Digital Zoom		For taking digital zoom pictures	p.76
Instant Review		For setting the Instant Review time	p.99
Memory		For saving the shooting function settings when the camera is turned off	p.106
Green Button		For registering a function on the Green button	p.100
Sharpness		For setting the sharpness	p.103
Saturation		For setting the saturation	p.104
Contrast		For setting the contrast	p.105

[X] Set-up] Menu

Item	Description	Page
Format	For formatting the SD Memory Card or built-in memory	p.158
Sound	For adjusting the operation sound volume and the playback volume and setting the type and volume of start-up sound, shutter sound, key operation sound, self-timer sound.	p.159
Date Adjust	For adjusting the date, time, and display style	p.162
World Time	For setting the world time	p.164
Language/言語	For changing the language in which menus and messages appear	p.166
Folder Name	For selecting the way of naming image folders	p.167
USB Connection	For changing the USB connection mode	p.168
Video Out	For setting the video output format	p.169
Brightness Level	For changing the brightness of the LCD monitor	p.170
Power Saving	For setting the Power Saving function	p.171
Quick Zoom	For displaying the image at specified magnification by pressing the zoom button once	p.114
Auto Power Off	For turning off the power automatically	p.172
Guide Display	For showing the mode selected on the screen in Capture mode, the status of the four-way controller, and assignment of the Green button. For showing the description for the selected item on the Mode Palette.	p.172
Reset	For returning the camera settings to defaults	p.173

Operating the Mode Palette

Once you press the four-way controller (▼), the Mode Palette appears on the LCD monitor. You can edit an image or change the settings of the camera.

How to operate the Mode Palette

The guide display is indicated while using the Mode Palette.







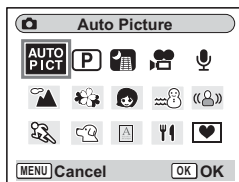





- 1 Press the four-way controller (▼).**
In Capture mode, the Capture Mode Palette appears and in Playback mode, the Playback Mode Palette appears.
- 2 Use the four-way controller (▲▼◀▶) to select an item.**
- 3 Press the OK button.**
The screen for each mode appears.

Mode Palette List



Capture Mode Palette



Icon	Item	Description	Page
	Auto Picture mode	Selects the best capture mode.	p.54
	Program mode	Lets you take clear pictures at the appropriate shutter speed and exposure.	p.56
	Shutter Priority mode	Automatically sets the required aperture value when a shutter speed is manually selected.	
	Manual Exposure mode	Allows you to set shutter speed and aperture value manually.	
	Night Scene mode	Lets you take dark scenes such as night views.	p.66
	Movie mode	Lets you take movies and sounds.	p.68

Icon	Item	Description	Page	
	Voice Recording mode	Records audio, such as voices.	p.108	
	Picture mode	Landscape mode	p.60	
		Flower mode		Lets you take brightly colored flower pictures.
		Portrait mode	Lets you take portraits with spatial effect, by emphasizing the person.	p.62
		Kids mode	Ideal for taking pictures of moving children. Also gives them a healthy look.	
		Surf & Snow mode	Lets you take pictures against dazzling backgrounds like beaches or snow-covered mountains.	p.60
		Sport mode	Lets you take clear pictures of moving subjects with a high shutter speed to prevent motion blur.	
		Pet mode	Lets you take clear pictures of pets to fit the hair color.	p.64
		Text mode	Lets you take clear pictures of text or writing. Also lets you turn colored text black/white or reverse color.	p.65
		Food mode	Lets you take appetizing pictures of prepared food.	p.60
	Blur reduction mode	Lets you set the sensitivity higher to reduce camera shake and blurring.	p.67	
	Frame Composite mode	Lets you take pictures with a decorative frame.	p.70	



- When you select an item on the Mode Palette, waiting for about 3 seconds, the description for the selected mode appears.
- For  /  and **P** / **Tv** / **M**, the currently selected mode icons are displayed on the Mode Palette. If you change the selection, the newly selected icons replace the previous ones.

Playback Mode Palette

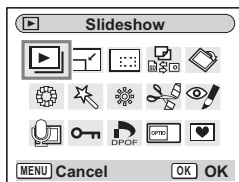

Icon	Item	Description	Page
	Slideshow	For playing recorded images successively	p.119
	Resize	For changing the size and quality level of images	p.137
	Cropping	For cropping images and saving them as separate images	p.139
	Image/ Sound Copy	For copying files from the built-in memory to the SD Memory Card and vice versa	p.154
	Image Rotation	For displaying rotated still pictures	p.140
	Color Filter	For processing images using the color filter	p.141
	Digital Filter	For applying special effects such as the illustration effect or the slim effect to still pictures according to your taste	p.143
	Brightness Filter	For adjusting the brightness of images using a filter	p.145
	Movie Edit	For editing movies	p.147
	Red-eye Compensation	For retouching red-eyes, a phenomenon that can happen when shooting with a flash	p.150
	Voice Memo	For adding a voice memo to an image	p.111
	Protect	For protecting images and sounds to avoid accidental erasure	p.126
	DPOF	For printing images from a DPOF compatible printer or at a printing service	p.130
	Start-up Screen	For setting the Start-up screen	p.156
	Frame Composite	For adding a decorative frame to a still picture	p.152





When you select an item on the Mode Palette, waiting for about 3 seconds, the description for the selected mode appears.

Changing the Mode

Capture mode is for taking pictures and Playback mode is for playing back or deleting images.

Switching between Capture Mode and Playback Mode

- To change from Capture mode to Playback mode, press the  Playback button.
- To change from Playback mode to Capture mode, press the  Playback button or press the shutter release button halfway.

Selecting the Capture Mode

Select the Capture Mode from the Mode Palette. (p.45)

Displaying Shooting Information in Capture Mode



You can display shooting information on the LCD monitor when taking pictures. The display mode can be changed by pressing the OK/Display button.

Normal Display

Shooting information is displayed when the power is turned on.

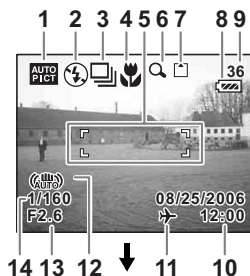
- | | |
|--|------------------------------|
| 1 Capture mode | 2 Flash mode |
| 3 Drive mode | 4 Focus mode |
| 5 Focus frame | 6 Digital zoom |
| 7 Card/Built-in memory | 8 Battery indicator |
| 9 Remaining number of recordable images | 10 Date and time |
| 10 Date and time | 11 World time setting |
| 12 Shake Reduction (On)* | 13 Aperture |
| 14 Shutter speed | |



- * When [Shake Reduction] is set to [Off],  (Shake Reduction Off) is displayed. However, when shutter speed is slower,  (Anti-shake warning) is displayed.

Histogram Display

The brightness distribution of the image is displayed. The horizontal axis shows the brightness (darkest at the left end and brightest at the right end) and the vertical axis shows the number of pixels.

- | | |
|-------------------|-----------------|
| 1 Recorded Pixels | 2 Quality Level |
| 3 White Balance | 4 AE Metering |
| 5 Sensitivity | 6 Histogram |

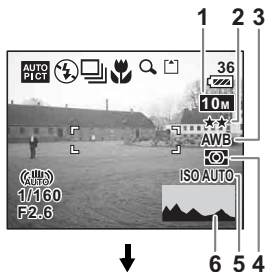

Grid Display

The grids divide the screen into nine parts. These grids will help you to improve composition.

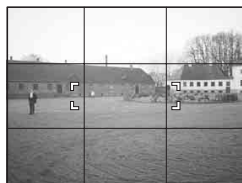

No icons

No shooting information is displayed.

- The focus frame appears in Autofocus mode.
- If any of the settings are changed, the icon of the setting appears for a few seconds.



Backlight Off

The LCD monitor is turned off.

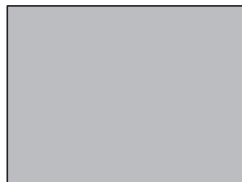

Saving the Display Mode p.106



- Under shooting conditions where camera shake is likely to occur, (Anti-shake warning) will be displayed. Take pictures using the shake reduction function or with the camera secured on a tripod or other stable surface. (p.51)
- All the camera buttons function as normal even when the backlight is off. Press the shutter release button to take pictures as normal.

Using Histogram

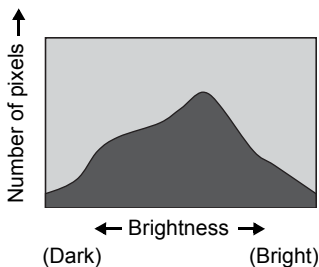

A histogram is a graph showing the brightness of an image on the horizontal axis and the number of pixels on the vertical axis (distribution chart of the brightness). The histogram will help you detect the brightness of the image you have taken. For instance, the graph peak tends to appear on the left side for a darker image, and the graph peak tends to appear on the right side for a brighter image.

In general, when the exposure meter of your image is well-balanced, the graph peaks tend to appear in the middle.

On the contrary, when the exposure meter gets imbalanced tending dark and bright without showing a neutral brightness, the peaks appear not in the middle but on both sides.

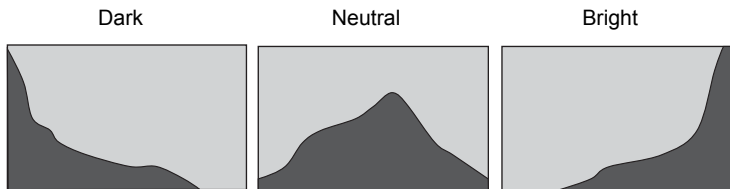

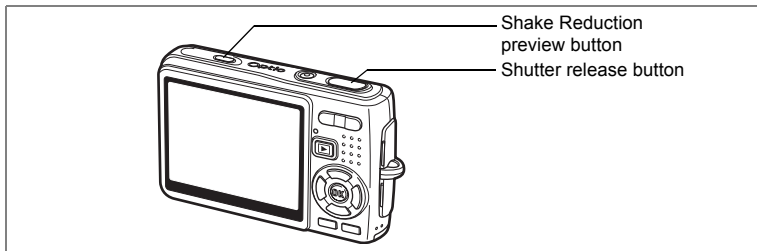

Taking Pictures Using the Shake Reduction Function

This camera has a CCD shifting shake reduction system to compensate for image blur caused by camera shake. The shake reduction function is useful when taking a still image in a dark place, in Macro mode or in Tele mode. To use the anti-shake function for movies, refer to “Compensating for Camera Shake While Taking Movies” (p.97).

1 Press the Shake Reduction preview button.

While holding down the Shake Reduction preview button, you can see the compensated image on the LCD monitor.

2 Press the shutter release button fully.

The picture is taken.



- To activate the Shake Reduction preview button, you need to set Shake Reduction to On on the [📷 Rec.Mode] menu. For instructions for setting, refer to “Setting the Shake Reduction for Still Pictures” (p.98). Shake Reduction is set to On in the default settings.
- If you press the Shake Reduction preview button, while the Shake Reduction is set to On on the [📷 Rec.Mode] menu, the shake reduction function is activated even in Playback mode, in Voice Recording mode, or when the camera is connected to a PC or a printer with the USB cable. To reduce power consumption, do not press the Shake Reduction preview button unless necessary.



Just by pressing the shutter release button fully, you can take a compensated still picture without pressing the Shake Reduction preview button. In this case, the compensated image is not displayed on the LCD monitor.

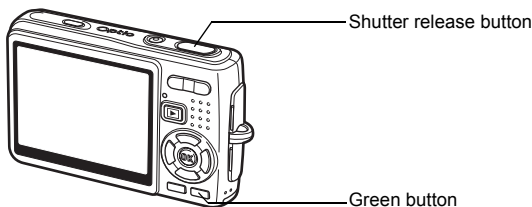

Taking Pictures in the Basic Mode (Green Mode)

In the Green Mode, you can enjoy easy picture taking just by pressing the shutter release button.

4

Taking Pictures

1 Press the Green button in Capture mode.

The camera enters the Green Mode. Press the Green button again to return to the previous status.

2 Press the shutter release button halfway.



The focus frame on the LCD monitor will light green when the camera is in focus.



3 Press the shutter release button fully.

The picture is taken.

Caution

- In the Green Mode, you cannot change the information displayed on the LCD monitor by pressing the OK/Display button.
- In the Green Mode, you cannot display the [Rec. Mode] menu or the Capture Mode Palette. If you try to show them, the message [Green mode must be canceled to use this function.] and  (key lock icon) appear.
- When the camera switches from the Green Mode to Playback Mode, you cannot display the [X↓ Set-up] menu by pressing the MENU button. If you try to show it, the message [Green mode must be canceled to use this function.] and  (key lock icon) appear.
- When the camera is turned off in the Green Mode, it starts up in the Green Mode next time you turn on the camera.



You can assign other functions to the Green button. (p.100)

The list below shows the settings for the Green Mode.

Flash mode	The default is (Auto). (Flash Off) can be selected.
Drive mode	The default is (Standard). (Self-timer) can be selected.
Focus mode	The default is AF (Standard). (Macro mode) can be selected.
Recorded Pixels	10M
Quality level	★★ (Better)
White Balance	AWB (Auto)
Focusing Area	(Multiple)
Focus Limiter	<input checked="" type="checkbox"/> (On)
Aux. AF Light	<input checked="" type="checkbox"/> (On)
AE Metering	(Multi-segment)
Sensitivity	AUTO
EV Compensation	± 0.0
Digital Zoom	<input checked="" type="checkbox"/> (On)
Instant Review	0.5sec
Sharpness	(Standard)
Saturation	(Standard)
Contrast	(Standard)

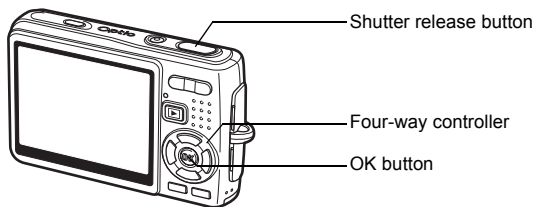

Taking Pictures Automatically (Auto Picture Mode)

In **AUTO PICT** (Auto Picture mode), the camera selects the most appropriate capture mode from ☺ (Normal mode), 🌃 (Night Scene mode), 🏞️ (Landscape mode) and 👤 (Portrait mode) just by pressing the shutter release button.

1 Press the four-way controller (▼) in Capture mode.

The Mode Palette appears.

2 Use the four-way controller (▲▼◀▶) to select **AUTO PICT** (Auto Picture mode).

3 Press the OK button.

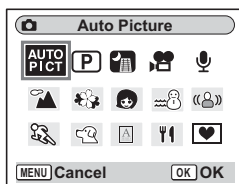

4 Press the shutter release button halfway.

The focus frame on the LCD monitor will light green when the camera is in focus, and the selected mode icon will appear on the top left of the LCD monitor.



5 Press the shutter release button fully.

The picture is taken.

Taking Still Pictures p.30



- In Auto Picture mode, the exposure is fixed to ± 0.0 . (p.94)
- When the camera selects Portrait mode, “Face Recognition AF” and “Face Recognition AE” are activated. When you point the camera at your subject’s face, the camera automatically recognizes it, adjusting focus and exposure to take a high-quality picture. (p.62)

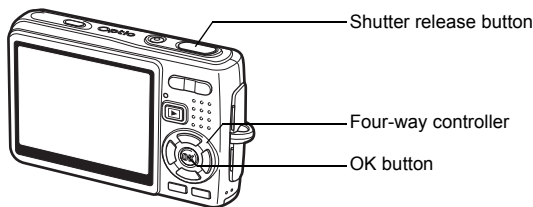

Using the Exposure Mode and Other Functions

P (Program mode), **TV** (Shutter Priority mode) and **M** (Manual Exposure mode) allow you to take pictures with various aperture and shutter speed settings (Exposure modes).

Enjoy a wide variety of shots by using other functions such as Flash mode or Continuous Shooting mode.

P	Program	Sets shutter speed and aperture automatically for proper exposure.
TV	Shutter Priority	Set shutter speed manually. Aperture is set automatically.
M	Manual Exposure	Set both shutter speed and aperture manually.

● Effect of Aperture and Shutter Speed

There are many correct combinations of shutter speed and aperture for a particular subject. Different combinations produce different effects on a picture.

Slower shutter speed	The shutter remains open for a longer time. If the subject is moving, the image will be blurred while the shutter is open, thus enhancing the effect of motion.
Faster shutter speed	The shutter remains open for a shorter time. It allows freezing the action of a moving subject.
Lesser aperture value	Decreases the amount of light which enters through the lens.
Higher aperture value	Increases the amount of light which enters through the lens.

1 Press the four-way controller (▼) in Capture mode.

The Mode Palette appears.

2 Use the four-way controller (▲▼◀▶) to select [P] (Program mode).

If you have selected an exposure mode other than [P] (Program mode), the icon of the selected mode is displayed on the Mode Palette.

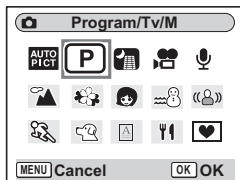

3 Press the OK button.

The screen for selecting one of the three modes appears.



To Select the Program mode

4 Use the four-way controller (▲▼) to select [P] (Program mode), and press the OK button.

The camera is ready for taking pictures.
Set other functions when necessary.

"Setting the Shooting Functions" ESP p.78~p.105

To Select the Shutter Priority mode

4 Use the four-way controller (▲▼) to select [Tv] (Shutter Priority mode), and press the OK button.

5 Press the four-way controller (▼).

The screen for selecting the shutter speed appears.



Shutter speed

6 Use the four-way controller (◀▶) to select a desired shutter speed.

The proper aperture value will be set automatically.

If the camera cannot adjust it appropriately, an exposure warning appears in the bottom center of the LCD monitor.

Adjust the exposure using the warning as a reference.

When ▽ appears : Increase the shutter speed.

When ▲ appears : Decrease the shutter speed.



Compensation value Exposure warning



If you compensate the exposure (p.94) already set in Shutter Priority mode, the compensation value appears below the exposure warning.

7 Press the OK button.

The camera is ready for taking pictures.
Set other functions when necessary.

"Setting the Shooting Functions" p.78~p.105

To Select the Manual Exposure mode

4 Use the four-way controller (▲▼) to select [M] (Manual Exposure mode), and press the OK button.

5 Press the four-way controller (▼).

The screen for selecting the shutter speed and aperture value appears.

6 Use the four-way controller (◀▶) to select a desired shutter speed and (▲) to select a desired aperture value.



Aperture Shutter speed







Depending on the shutter speed and aperture value you set, an exposure warning may appear for your reference.

7 Press the OK button.

The camera is ready for taking pictures.
Set other functions when necessary.

“Setting the Shooting Functions”  p.78~p.105



- Only the icon of the selected exposure mode is displayed on the Mode Palette. When you switch to another exposure mode, the icon of the newly selected mode replaces the previous one.
- You can display the Capture Mode Palette by pressing the four-way controller (▼) while showing the screen for selecting the shutter speed and aperture value.
- In  (Shutter Priority mode), Sensitivity is fixed to AUTO800.
- In  (Shutter Priority mode) and  (Manual Exposure mode), the exposure warning is shown as follows.
 - When the exposure exceeds over +2.0EV to -2.0EV, an icon ( or ) is displayed.
 - When the exposure is between +2.0EV to -2.0EV, an icon ( or ) and the exposure value are displayed.
 - When the exposure is adequate at 0EV, no warning is displayed.

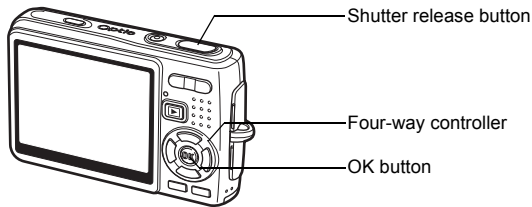

Selecting the Picture Mode According to the Shooting Scene (Picture Mode)

You can select the Picture mode according to the shooting scene. There are nine available modes in Picture mode.

	Landscape	Lets you capture the natural colors of landscape views.
	Flower	Lets you take brightly colored flower pictures.
	Portrait	Lets you take portraits with spatial effect, by emphasizing the person.
	Kids	Ideal for taking pictures of moving children. Also gives them a healthy look.
	Surf & Snow	Lets you take photos against dazzling backgrounds like beaches or snow-covered mountains.
	Sport	Lets you take clear pictures of moving subjects with a high shutter speed.
	Pet	Lets you take clear pictures of pets to fit their hair color.
	Text	Lets you take clear pictures of text or writing. Also lets you turn colored text black/white or reverse color.
	Food	Lets you take appetizing pictures of prepared food.

1 Press the four-way controller (▼) in Capture mode.

The Mode Palette appears.

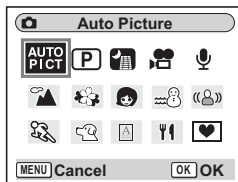

2 Use the four-way controller (▲▼◀▶) to select a desired mode.

For example, select  (Landscape mode).

3 Press the OK button.

4 Press the shutter release button halfway.

The focus frame on the LCD monitor will light green when the camera is in focus.

5 Press the shutter release button fully.

The picture is taken.

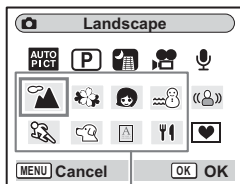

Picture modes



In Picture mode, Saturation, Contrast, Sharpness and White Balance are automatically set to their default settings. You cannot change the settings.

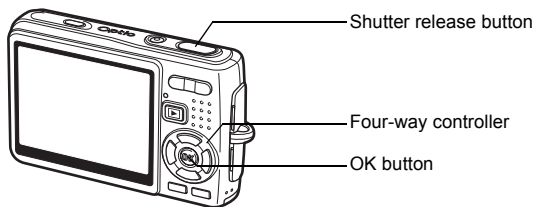

Taking Pictures of People (Portrait Mode/Kids Mode)

4

Taking Pictures

In (Portrait mode) and (Kids mode), “Face Recognition AF” and “Face Recognition AE” are activated. When you point the camera at your subject’s face, the camera automatically recognizes it, adjusting both focus and exposure.

	Portrait	Lets you take portraits with spatial effect, by emphasizing the person.
	Kids	Ideal for taking pictures of moving children. Also gives them a healthy look.

1 Press the four-way controller (▼) in Capture mode.

The Mode Palette appears.

2 Use the four-way controller (▲▼◀▶) to select (Portrait mode).

When (Kids mode) is previously selected, is displayed on the Mode Palette. Select (Portrait mode) then.

3 Press the OK button.

The screen for selecting one of the two modes appears.

4 Press the four-way controller (▲▼) to select (Portrait mode) or (Kids mode).



5 Press the OK button.

The camera is ready for taking pictures in the selected mode.

When the camera recognizes the subject's face, a yellow focus frame appears on it. The position and the size of the frame change while the camera continues to adjust the focus on the moving subject.

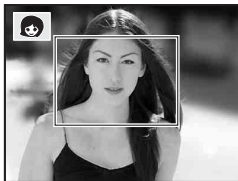

6 Press the shutter release button halfway.

The focus frame on the LCD monitor will light green when the camera is in focus.

7 Press the shutter release button fully.

The picture is taken.



- If the camera cannot recognize the subject's face in Portrait mode, the camera focuses using the Focusing Area (Multiple).
- Only the selected mode icon and the focus frame appear on the LCD monitor. No other shooting information is displayed. You cannot change the display mode by pressing the OK/Display button.
- "Face Recognition AF" and "Face Recognition AE" may not work if the subject's face is partly covered, for example, with sunglasses, or when the subject does not face the camera.
- The AE metering mode is fixed to Multi-segment.
- When you select Auto Picture mode and the camera automatically switches to Portrait mode, "Face Recognition AF" and "Face Recognition AE" are activated.
- In Kids mode, the automatic tracking AF function is activated. The camera continues to adjust the focus on the moving subject even after you press the shutter release button halfway.

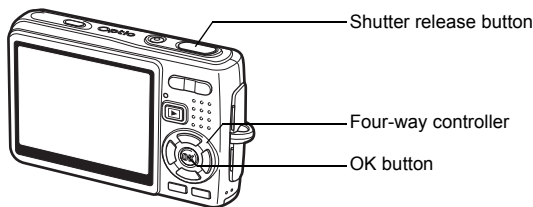

Taking Pictures of Your Pet (Pet Mode)

In  (Pet mode), you can take pictures that show natural hair color of your pet. Select the appropriate icon depending on what color your pet is (closer to black or white or in between).

4

Taking Pictures

1 Press the four-way controller (▼) in Capture mode.

The Mode Palette appears.

2 Use the four-way controller (▲▼◀▶) to select (Pet mode).

3 Press the OK button.

The screen for selecting the pet mode appears.

4 Use the four-way controller (▲▼) to select , , , or .

There are two types of pet icon; dogs' and cats'. Selecting either the cat or dog icon does not affect the resulting picture. Select whichever you prefer.

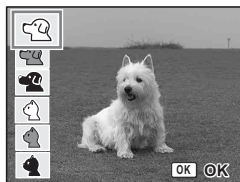

5 Press the OK button.

The desired Pet mode is selected and the camera is ready for taking pictures.

6 Press the shutter release button halfway.

The focus frame turns green when the subject is in focus.



7 Press the shutter release button fully.

The picture is taken.



When you select Pet mode or Sport mode, the automatic tracking AF function is activated and the camera continues to adjust the focus on the moving subject even after the shutter release button is pressed halfway.

Taking Pictures of Text (Text Mode)

This mode allows you to take clear pictures of written text. This is convenient for capturing a digital copy of an important document or enhancing legibility of small print.

1 Press the four-way controller (▼) in Capture mode.

The Mode Palette appears.



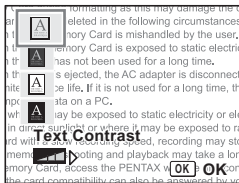

2 Use the four-way controller (▲▼◀▶) to select (Text mode).

3 Press the OK button.

The screen for selecting the Text mode appears.



4 Use the four-way controller (▲▼) to select , , , .

	Color	Maintains original colored text.
	Neg. Color	Reverses colored text.
	B&W	Turns colored text black/white.
	Neg. B&W	Reverses black/white text.

Press the four-way controller (◀▶) to adjust the contrast.

5 Press the OK button.

The desired text mode is selected and the camera is ready for taking pictures.

6 Press the shutter release button halfway.

The focus frame turns green when the subject is in focus.

7 Press the shutter release button fully.

The picture is taken.

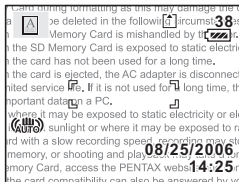

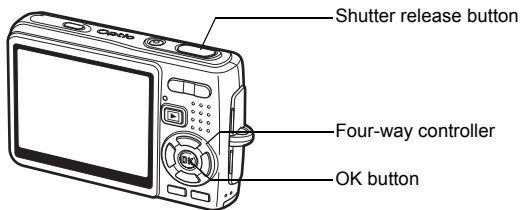

Taking Pictures of Dark Scenes (Night Scene Mode)

You can take pictures of dark scenes, such as nightscapes, with the appropriate settings.

4

- 1 Press the four-way controller (▼) in Capture mode.**

The Mode Palette appears.

- 2 Use the four-way controller (▲▼◀▶) to select  (Night Scene mode).**

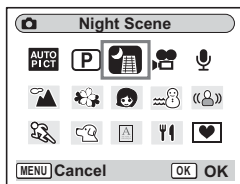

- 3 Press the OK button.**

- 4 Press the shutter release button halfway.**

The focus frame on the LCD monitor will light green when the camera is in focus.

- 5 Press the shutter release button fully.**

The picture is taken.



Total recording time will be longer when the picture is taken at slower shutter speed (approximately 1/4 second or slower), because the noise reduction function is activated to reduce noise.



The shutter speed is slower when taking pictures of dark scenes. To prevent camera shake, shoot using the shake reduction function, or set Shake Reduction to Off in the [📷 Rec.Mode] menu and secure the camera on a tripod or other stable surface. (p.51)

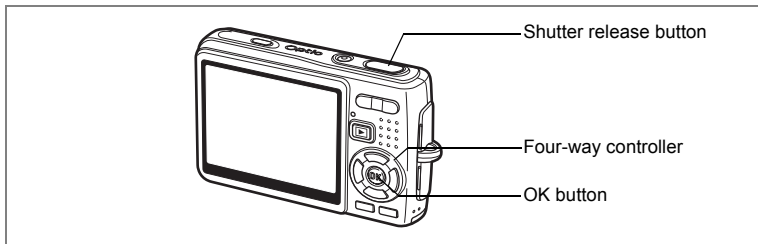

Reducing Camera Shake and Blurring in Pictures (Blur reduction Mode)

Blur reduction mode allows you to set the sensitivity higher than other modes to reduce camera shake and blurring. Shutter speed and aperture are set automatically according to the sensitivity value you set. Use the mode under the shooting conditions that the camera shake or blurring tend to occur.

1 Press the four-way controller (▼) in Capture mode.

The Mode Palette appears.

2 Use the four-way controller (▲▼◀▶) to select (B) (Blur reduction mode).

3 Press the OK button.

4 Press the shutter release button halfway.

The focus frame on the LCD monitor will light green when the camera is in focus.

5 Press the shutter release button fully.

The picture is taken.

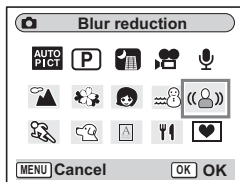

- The recorded pixels are fixed to 5M and cannot be changed.
- When Sensitivity is set to AUTO, the sensitivity will automatically be set to maximum ISO 1600. The ISO Correction range can be set to maximum ISO 64-1600. (p.92)

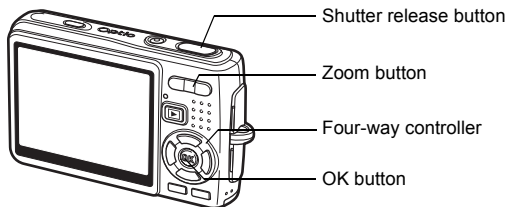

Taking Movies (Movie Mode)

This mode enables you to take movies and sounds.

1 Press the four-way controller (▼) in Capture mode.

The Mode Palette appears.

2 Use the four-way controller (▲▼◀▶) to select (Movie mode).

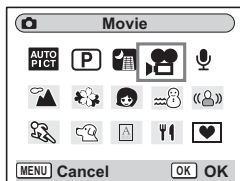

3 Press the OK button.

The following shooting information appears on the LCD monitor and the camera is ready for taking movies.

- 1 Movie mode icon 2 Flash Off icon
- 3 Card/Built-in memory 4 Recordable time
- 5 Movie anti-shake (On)



4 Press the shutter release button.

Shooting starts. You can change the size of the image using the zoom button.

Zoom button (▲): Enlarges the subject.

Zoom button (▶▶▶): Diminishes the subject.

5 Press the shutter release button.

Shooting ends.

Keeping the Shutter Release Button Pressed

If you keep the shutter release button pressed for more than one second, the movie will be taken for as long as you keep the button pressed. Shooting stops when you take your finger off the shutter release button.



- The flash will not discharge in Movie mode.
- Continuous shooting is not possible in Movie mode.
- You cannot use the remote control unit in Movie mode.
- Set the Movie anti-shake to Off to use the digital zoom in Movie mode.
- The optical zoom cannot be used while taking movies in Movie mode.
- The Focusing Area is fixed to Spot, and the Focus Limiter and the auxiliary AF light are set to Off in Movie mode. When Focus Mode is set to Standard (Autofocus), Macro, or Super Macro, the AF operation is performed once right before starting taking a movie.

Playing Back Movies  p.115

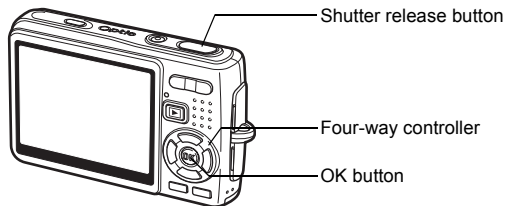

Taking Pictures in Frame Composite mode

You can take pictures with a decorative frame added using the Frame Composite function. There are three frames already stored in the camera.

4

1 Press the four-way controller (▼) in Capture mode.

The Mode Palette appears.

2 Use the four-way controller (▲▼◀▶) to select (Frame Composite).

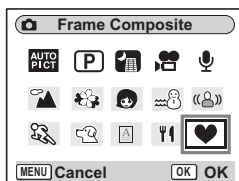

3 Press the OK button.

The frame selection screen appears.

4 Use the four-way controller (◀▶) to select a frame.



5 Press the OK button.

The subject appears in the selected frame.

6 Press the shutter release button halfway.

The focus frame on the LCD monitor will light green when the camera is in focus.



7 Press the shutter release button fully.

The picture is taken.



- The Recorded Pixels is fixed to 3M, and cannot be changed to any other size.
- Continuous Shooting is not possible in Frame Composite mode.

To Register a New Frame

To switch to the screen for registering a frame, press the Green button in Step 3. You can register frames which you have downloaded from the internet, etc. When you register a new frame, it replaces one of the existing frames in the built-in memory. Before you register a new frame, copy it to the SD Memory Card.



When a new frame on the SD Memory Card is registered in the built-in memory, it replaces one of the existing frames in the built-in memory. The replaced frame is deleted from the built-in memory.

1 In the frame selection screen, select the frame you want to remove and press the Green button.

A message appears and the frames on the SD Memory Card that you can register in the built-in memory appear.

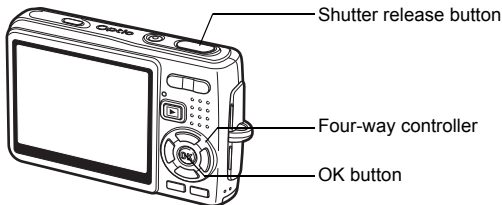

2 Use the four-way controller (◀▶) to select the frame you want to register and press the OK button.

The frame is registered in the built-in memory instead of the frame selected in Step 1.



Using the Self-timer

In self-timer mode, the picture is taken ten seconds or two seconds after the shutter release button is pressed.

- 1 Press the four-way controller (▲) in Capture mode.**
- 2 Press the four-way controller (◀▶) to select  (Self-timer) or  (2 sec. Self-timer).**
- 3 Press the OK button.**

The camera is ready for taking pictures using the Self-timer.





- 4 Press the shutter release button halfway.**

The focus frame on the LCD monitor will light green when the camera is in focus.

- 5 Press the shutter release button fully.**

The self-timer starts running.

-  (Self-timer) : The picture is taken after the self-timer lamp lights for about seven seconds, then blinks for about three seconds.
-  (2 sec. Self-timer) : The picture is taken after the self-timer lamp blinks for about two seconds.



Focusing may be compromised if you move the camera while the self-timer is running.



- The countdown appears on the LCD monitor when you press the shutter release button.
- If you press the shutter release button halfway during a countdown, the countdown stops. Press the shutter release button fully to restart the countdown.

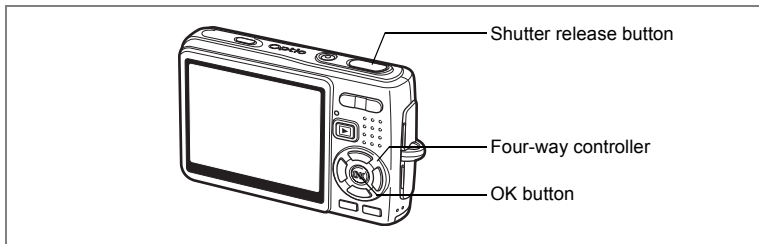

Continuous Shooting (Continuous Shooting Mode)

You can switch the Drive mode to [Continuous Shooting] mode. Pictures are taken continuously while the shutter release button is pressed.

- 1 Press the four-way controller (▲) in Capture mode.**
- 2 Press the four-way controller (◀▶) to select  (Continuous Shooting).**
- 3 Press the OK button.**

The camera is ready for continuous shooting.

- 4 Press the shutter release button halfway.**

The focus frame on the LCD monitor will light green when the camera is in focus.

- 5 Press the shutter release button fully.**

Pictures are taken continuously while pressing the shutter release button. Shooting stops when you release the shutter release button.



- You can continue shooting until the SD Memory Card or the built-in memory is full.
- The interval will vary depending on the Recorded Pixels and Quality Level settings.



- The flash will not discharge in Continuous Shooting mode.
- Continuous shooting is not available in Movie and Frame Composite mode.
- The focus, exposure and white balance are determined in the first frame.

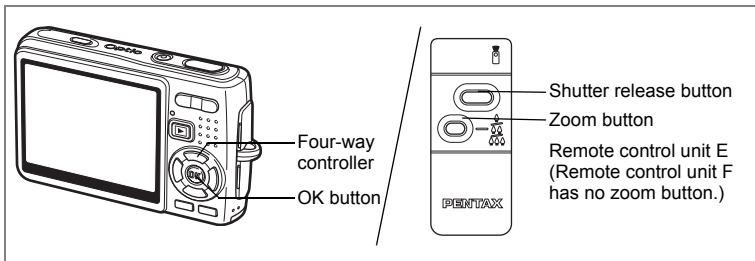

Using the Remote Control Unit (optional)

You can switch the Drive mode to Remote Control mode and take pictures using the remote control unit E or F (optional).

4

Taking Pictures Using the Remote Control

- 1 Press the four-way controller (▲) in Capture mode.
- 2 Press the four-way controller (◀▶) to select (Remote control) or (0 sec remote control).



- 3 Press the OK button.

The self-timer lamp blinks slowly and the camera is ready for taking pictures.

- 4 Press the shutter release button on the remote control unit.



- (Remote control) : The picture is taken after the self-timer lamp blinks quickly for about three seconds.
- (0 sec remote control) : The picture is taken immediately.





- Focusing may be compromised if you move the camera while the self-timer lamp is blinking.
- You cannot use the remote control unit in Movie mode.

Changing the Magnification Using the Remote Control Unit

You can not only shoot images with the shutter button, but also change the zoom magnification with the zoom button using the remote control unit E (optional).

- 1 Press the four-way controller (▲) in Capture mode.**
- 2 Press the four-way controller (◀▶) to select  (Remote control) or .**

The function is same either in  (Remote control) or  (0 sec remote control).

- 3 Press the zoom button on the remote control unit.**

Each time you press the zoom button, the zoom position will change among tele, middle, and wide.



You cannot change the zoom magnification with the remote control unit in Super Macro mode. You can change it in Macro mode.



- The buttons on the camera can be used in the normal way.
- Ensure that the remote control unit is no more than about four meters away from the front of the camera.
- You cannot change the digital zoom range with the remote control unit. you can change only the optical zoom range.

Life of the Battery for the Remote Control Unit

A signal can be sent from the remote control unit to the camera approximately 30,000 times. Contact your nearest PENTAX customer service center if the battery needs changing. (A charge is made for changing the battery.)

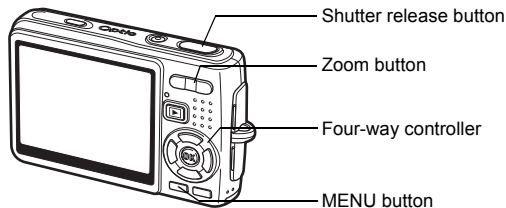

Using the Zoom to Change the Subject Size

You can use the zoom to change the size of the subject and take pictures in Tele or Wide mode.

4

1 Press the zoom button in Capture mode.

Zoom button (↑) : Enlarges the subject.
(Tele)

Zoom button (↓↓) : Diminishes the subject.
(Wide)

When the digital zoom function is disabled, you can take pictures at up to three times magnification using the optical zoom.

When the digital zoom function is enabled, you can further enlarge the subject to a maximum magnification equivalent to 12 times.

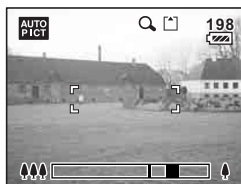
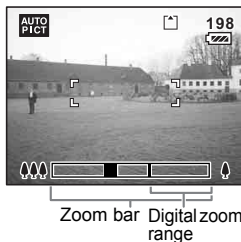

When digital zoom is enabled

Saving the Zoom Position p.106



You cannot use the optical zoom when taking movies.

Setting the Digital Zoom

The digital zoom is set to (On) in the default settings. To take pictures using only the optical zoom, set the digital zoom to (Off).

1 Press the MENU button in Capture mode.

The [📷 Rec.Mode] menu appears.

2 Use the four-way controller (▲▼) to select [Digital Zoom].

3 Use the four-way controller (◀▶) to select [(On)/ (Off)].

4 Press the shutter release button halfway.

The camera is ready for taking pictures.

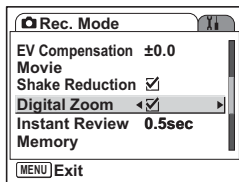

Saving the Digital Zoom Function Setting  p.106

Caution

Set the Movie anti-shake Off to use the digital zoom in Movie mode.

Setting the Shooting Functions

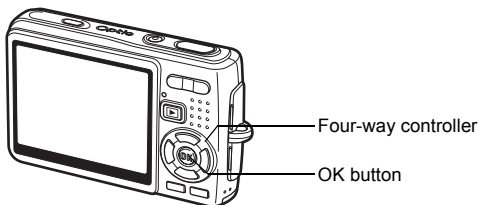





Selecting the Focus Mode

4

Taking Pictures

Focus Mode

AF	Standard (Autofocus mode)	The camera focuses on the object in the autofocus area when the shutter release button is pressed halfway. Use this mode when the distance to the subject is more than approx. 35 cm (16 in.).
	Macro mode	This mode is used when the distance to the subject is approx. 12 cm – 40 cm (4.7 in. – 16 in.). The camera focuses on the object in the autofocus area when the shutter release button is pressed halfway.
	Super Macro mode	This mode is used when the distance to the subject is approx. 6 cm – 15 cm (2.3 in. – 5.9 in.). The camera focuses on the object in the autofocus area when the shutter release button is pressed halfway.
PF	Pan Focus mode	This mode is used when shooting close and distant subjects together or the subject is hard to focus on. You can adjust the focus on a subject in the following ranges. When taking still pictures: approx. 2.3 m (7.55 ft.) – ∞ (full wide-angle), approx. 9.3 m (30.51 ft.) – ∞ (full telephoto) When taking movies: approx. 0.9 m (2.95 ft.) – ∞ (full wide-angle), approx. 3.7 m (12.14 ft.) – ∞ (full telephoto)
	Infinity mode	This mode is used for taking distant objects.
MF	Manual Focus mode	Adjust the focus manually with the four-way controller.

Saving the Focus Mode  p.106

- 1 Press the four-way controller (▶) in Capture mode.
- 2 Press the four-way controller (▲▼) to select the focus mode.
- 3 Press the OK button.

The camera is ready for taking pictures in the selected focus mode.

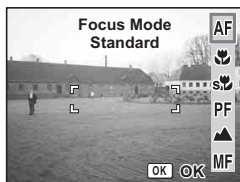

Auxiliary AF light

- The auxiliary AF light may be activated under low lighting in Autofocus mode.
- The auxiliary AF light of this camera conforms to the safety standard (IEC60825-1) for Class 1 LED product. Looking at the light directly will not create safety hazard. However, do not look into the emitter from a very short distance since you may feel dazzled.



- The default setting is Standard (Autofocus).
- The zoom is fixed at the full wide-angle in Super Macro mode.
- When Focus Mode is set to Standard (Autofocus), Macro, or Super Macro in Movie mode, the AF operation is performed once just before starting to take the movie.

Manual Focus

In MF (Manual Focus) mode, press the OK button to enlarge the central portion of the image full screen for focus adjustment. Press the four-way controller (▲▼) to adjust the focus while watching the indicator.

Four-way controller (▲) : Focuses farther.

Four-way controller (▼) : Focuses closer.

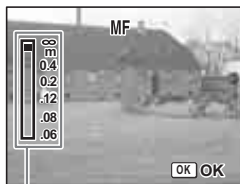

Indicator

After you determine the focus point, press the OK button to set the focus position and return to the normal capture screen. Press the four-way controller(▶) to readjust the focus position.

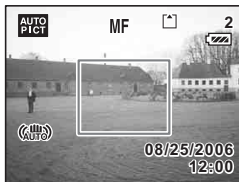

- When focusing, hold down the four-way controller (▲▼) to focus quickly.
- When you use Manual Focus in Movie mode, adjust the focus right before starting taking a movie. You cannot adjust the focus while taking the movie.
- To change Focus Mode from Manual Focus to another one, press the four-way controller(▶) twice while the indicator is displayed on the LCD monitor.

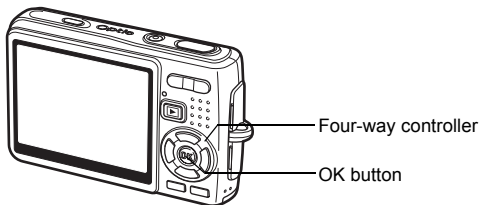

Selecting the Flash Mode

Flash Mode

	Auto	The flash discharges automatically depending on the light conditions.
	Flash Off	The flash will not discharge, regardless of the brightness. Use this mode to take pictures at dusk or in museums etc. where flash photography is prohibited.
	Flash On	The flash discharges regardless of the brightness.
	Auto + Red-eye	This mode reduces the phenomenon of red eyes caused by the light from the flash being reflected in the subject's eyes. The flash discharges automatically.
	Flash On + Red-eye	This mode reduces the phenomenon of red eyes caused by the light from the flash being reflected in the subject's eyes. The flash will discharge regardless of lighting conditions.
	Soft Flash	This mode reduces the intensity of the flash so that the flash is not too bright even when fired at close range. The flash will discharge regardless of the light conditions.



- The Flash Mode is fixed to Flash Off under the following conditions.
 - In Movie mode
 - In Continuous Shooting
 - When Focus Mode is set to Infinity mode
- The picture is taken when the last flash is discharged after the pre-flash. (The interval between the flashes is longer when using the red-eye reduction function.)

- 1 Press the four-way controller (◀) in Capture mode.
- 2 Use the four-way controller (▲▼) to select the flash mode.
- 3 Press the OK button.



The camera is ready for taking pictures in the selected flash mode.

Saving the Flash Mode (p.106)



- Using the flash in Macro mode may cause the image to be overexposed.
- The flash is automatically set to Off in Super Macro mode; however you can still select the desired flash mode.
- Firing the flash in Super Macro mode causes vignetting in the bottom left corner of the image.
- Note that the shutter speed becomes slower when taking pictures with the flash in Night Scene mode.
- Under the shooting conditions that the shutter speed tends to be slower (taking pictures of night scenes, for example), the shake reduction function may not be effective. It is recommended you set Shake Reduction to Off and secure the camera on a tripod or other stable surface to prevent camera shake. (p.98)

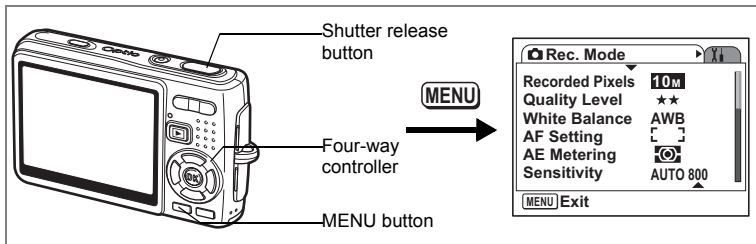

Selecting the Recorded Pixels of Still Pictures

You can select the number of recorded pixels from [10M], [7M], [5M], [3M], [2M], [1024] and [640].

The more pixels there are, the larger the picture and the file size. The file size also varies depending on the quality level setting (p.85).

Number of Recorded Pixels

10M (3648×2736)	↑ Clear, Fine	For printing images with high-resolution settings in your printer, printing at A4 size or larger, or editing and processing images
7M (3072×2304)		
5M (2592×1944)		For printing at postcard size For using as images on websites, or attaching images to e-mails
3M (2048×1536)		
2M (1600×1200)		
1024 (1024×768)		
640 (640×480)		

1 Press the MENU button in Capture mode.

The [Rec.Mode] menu appears.

2 Use the four-way controller (▲▼) to select [Recorded Pixels].

3 Press the four-way controller (▶) to pull down the menu.

The pull-down menu appears.

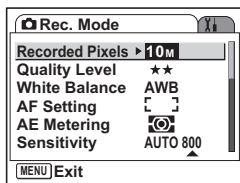

4 Use the four-way controller (▲▼) to change the recording pixels.

The number of shots for the selected recording pixels appears.

5 Press the shutter release button halfway.

The camera is ready for taking pictures.

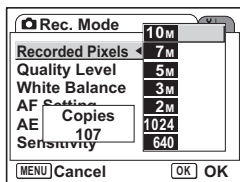

- Selecting a large size produces a clear picture when it is printed out.
- The Recorded Pixels setting is saved when the camera is turned off.

Image Size and Quality of Still Pictures p.23

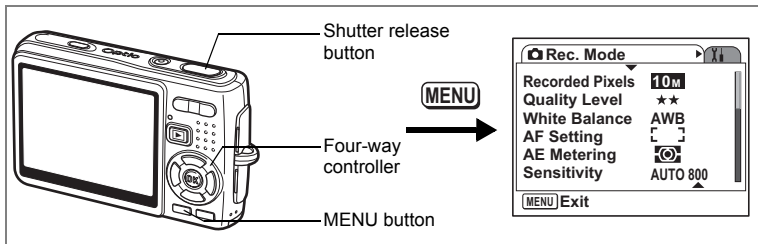

Selecting the Quality Level of Still Pictures

You can select the image compression ratio. The more stars, the clearer the quality and the larger the volume. The Recorded Pixels setting also changes the picture volume (☞ p.83).

Quality Levels

★★★	Best	Lowest compression ratio. Suitable for photo prints.
★★	Better	Standard compression ratio. Suitable for viewing the image on a computer screen.
★	Good	Highest compression ratio. Suitable for attaching to e-mails or creating websites.

1 Press the MENU button in Capture mode.

The [Rec.Mode] menu appears.

2 Use the four-way controller (▲▼) to select [Quality Level].

3 Press the four-way controller (▶). The pull-down menu appears.

4 Use the four-way controller (▲▼) to change the quality level.

The number of shots for the selected quality level appears.

5 Press the shutter release button halfway.

The camera is ready for taking pictures.

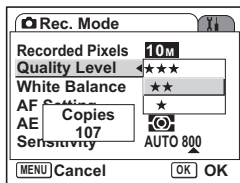
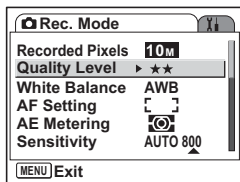

The Quality Level setting is saved when the camera is turned off.

Image Size and Quality of Still Pictures ☞ p.23

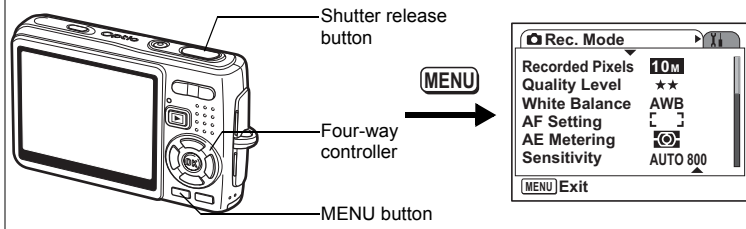

Adjusting the White Balance

The light condition of the shooting location affects the overall color tone of pictures. Adjust the white balance to reproduce the natural color of the subject.

4

White Balance

AWB	Auto	The camera adjusts the white balance automatically.
	Daylight	Use this mode when taking pictures outside in sunlight.
	Shade	Use this mode when taking pictures outside in the shade.
	Tungsten Light	Use this mode when taking pictures under electric or other tungsten light.
	Fluorescent Light	Use this mode when taking pictures under fluorescent light.
	Manual	Adjusts the white balance manually. Use this mode to reproduce colors more accurately or in the shooting locations with mixed light sources.

- 1 Press the MENU button in Capture mode.**
The [Rec.Mode] menu appears.
- 2 Use the four-way controller (▲▼) to select [White Balance].**
- 3 Press the four-way controller (▶).**
The White Balance screen appears.
- 4 Use the four-way controller (▲▼) to change the setting.**
- 5 Press the shutter release button halfway.**

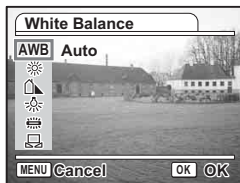

The camera is ready for taking pictures.

Saving the White Balance p.106

Manual Setting

Place a white material such as a piece of white paper in front of your camera to adjust white balance.

- 1 Select  (Manual) on the White Balance screen.**
- 2 Point the camera at the white material so that it fills the screen.**
- 3 Press the Green button.**

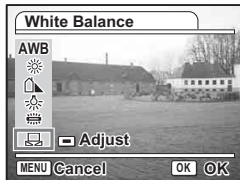

The white balance is automatically adjusted. [Complete] appears on the LCD monitor.

- 4 Press the OK button.**

The setting now adjusted is saved and the screen returns to the [ Rec.Mode] menu.
- 5 Press the shutter release button halfway.**

The camera is ready for taking pictures.

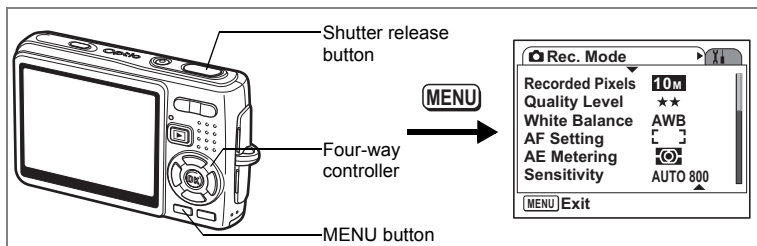

Selecting the Autofocus Settings

You can set the autofocus area and focusing method.

- 1 Press the MENU button in Capture mode.**
The [Rec. Mode] menu appears.
- 2 Use the four-way controller (▲▼) to select [AF Setting].**
- 3 Press the four-way controller (▶).**
The AF Setting screen appears.

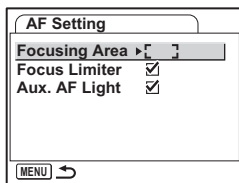

Changing the Focusing Area

You can change the autofocus area (Focusing Area).

Focusing Area

	Multiple	The camera measures a wide range in the center of the monitor (within the focusing area) and focuses on the nearest subject.
	Spot	The camera measures a narrow range in the center of the monitor (the spot focusing area) making easier for you to focus on a specific subject.
	Automatic tracking AF	The camera always continues to focus on a specified subject while the LCD monitor is on.

4 Press the four-way controller (▶).

The pull-down menu appears.

5 Use the four-way controller (▲▼) to change the Focusing Area.

6 Press the shutter release button halfway.

The camera is ready for taking pictures.

Saving the Focusing Area Setting  p.106

Setting the Focus Limiter

You can limit the focusing range of the lens in accordance with the shooting conditions.

When you set the [Focus Limiter] to [On], the moving range of the lens is limited to the long range side for normal shooting, and to the close-up side for macro shooting. You can adjust the focus on the subject quickly.

4 Use the four-way controller (▲▼) to select [Focus Limiter].

5 Use the four-way controller (◀▶) to select [(On)/ (Off)].

6 Press the shutter release button halfway.

The camera is ready for taking pictures.

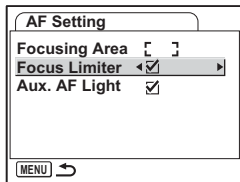

Setting the Auxiliary AF Light

The auxiliary AF light is convenient when you shoot a dark subject. The function helps you to focus on the subject under the conditions that the auto focus does not work properly.

- 4 Use the four-way controller (▲▼) to select [Aux. AF Light].
- 5 Use the four-way controller (◀▶) to select [(On)/ (Off)].
- 6 Press the shutter release button halfway.

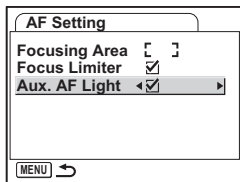

The camera is ready for taking pictures.

4



The auxiliary AF light of this camera conforms to the safety standard (IEC60825-1) for Class 1 LED product. Looking at the light directly will not create safety hazard. However, do not look into the emitter from a very short distance since you may feel dazzled.



The camera does not emit the AF light under the following conditions.

- In Movie mode
- In Landscape mode (The AF light is available if you set Aux. AF Light to On.)
- When Focus Mode is set to Pan Focus, Infinity or Manual Focus.

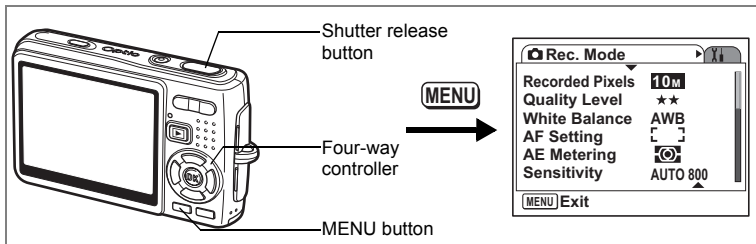

Setting the Light Metering Mode to Determine the Exposure

You can select which part of the screen to use to measure the brightness and determine the exposure.

AE Metering Modes

	Multi-segment	The exposure is determined by the entire screen.
	Center-weighted	The exposure is determined mainly by the center of the screen.
	Spot	The exposure is determined by the small area in the center of the screen only.

1 Press the MENU button in Capture mode.

The [Rec.Mode] menu appears.

2 Use the four-way controller (▲▼) to select [AE Metering].

3 Press the four-way controller (▶). The pull-down menu appears.

The pull-down menu appears.

4 Use the four-way controller (▲▼) to change the AE metering mode.

5 Press the shutter release button halfway.

The camera is ready for taking pictures.

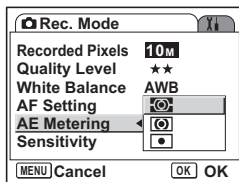
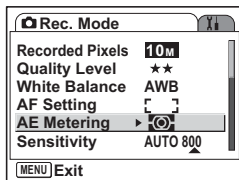

Saving the AE Metering Mode p.106



In Shutter Priority mode and Manual mode, Multi-segment cannot be selected.

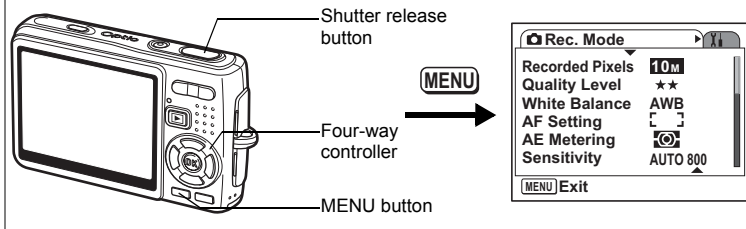

Setting the Sensitivity

Sensitivity (ISO sensitivity) is a value indicating how much the CCD senses light. Low value equals low sensitivity, and high value equals high sensitivity. Sensitivity can be adjusted according to the shooting situations.

Sensitivity

AUTO	The camera automatically selects the sensitivity from 64, 100, 200, 400 and 800. (In Blur reduction mode, 1600 is also selectable.) You can also set ISO Correction in AUTO to 64 - 100, 64 - 200, 64 - 400, or 64 - 800. (In Blur reduction mode, 64 - 1600 is also selectable.)
64	 <p>At lower sensitivity, images are sharper and noise is reduced, but the shutter speed will be slower under dark conditions. At higher sensitivity, the shutter speed can be fastened under dark conditions, but noise will increase. (In Blur reduction mode, 1600 is also selectable.)</p>
100	
200	
400	
800	

1 Press the MENU button in Capture mode.

The [Rec.Mode] menu appears.

2 Use the four-way controller (▲▼) to select [Sensitivity].

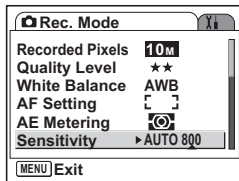

3 Press the four-way controller (▶).

The pull-down menu appears.

4 Use the four-way controller (▲▼) to select the sensitivity.

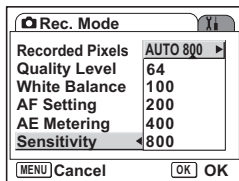

Selecting the Sensitivity

5 Press the shutter release button halfway.

The camera is ready for taking pictures.

Selecting the Sensitivity and ISO Correction Range

5 Select [AUTO] and press the four-way controller (▶).

The ISO Correction in AUTO range selection screen appears.

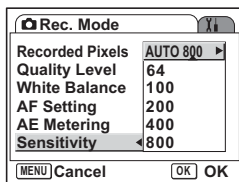

6 Press the four-way controller (▲▼) to select a range.

7 Press the shutter release button halfway.

The camera is ready for taking pictures.

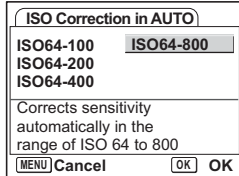

Saving the Sensitivity p.106



- The sensitivity for Movie mode is fixed to AUTO (ISO Correction in AUTO: 64 - 1600). The setting cannot be changed.
- The sensitivity for Shutter Priority mode is fixed to AUTO (ISO Correction in AUTO: 64 - 800). The setting cannot be changed.
- In Manual Exposure mode, AUTO cannot be selected.
- Even if you set Sensitivity to Off in Memory, the selected range for ISO Correction in AUTO is saved when the camera is turned off. The selected sensitivity will be saved only when you set Sensitivity to On in Memory.

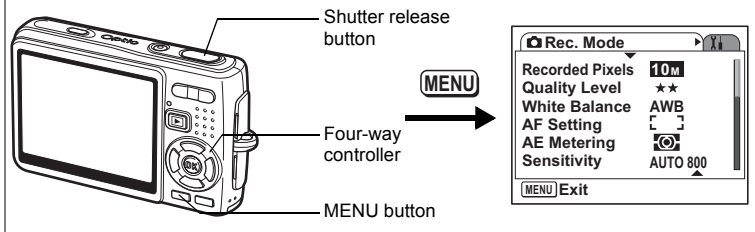

Setting the Exposure (EV Compensation)

The overall brightness of pictures can be changed by adjusting the EV compensation value (amount of light that the CCD receives). This changes the exposure automatically determined by the camera when you want to adjust the brightness of pictures to suite your taste.

4

Taking Pictures

1 Press the MENU button in Capture mode.

The [Rec.Mode] menu appears.

2 Use the four-way controller (▲▼) to select [EV Compensation].

3 Use the four-way controller (◀▶) to change the EV setting.

+ : Brightens the picture (overexposed).

- : Darkens the picture (underexposed).

You can select the EV setting in the range of -2.0 EV to +2.0 EV in 1/3 EV steps.

4 Press the shutter release button halfway.

The camera is ready for taking pictures.

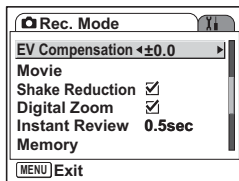

Saving the EV Compensation Value ESP p.106



In Auto Picture mode, the exposure is fixed to ±0.0.

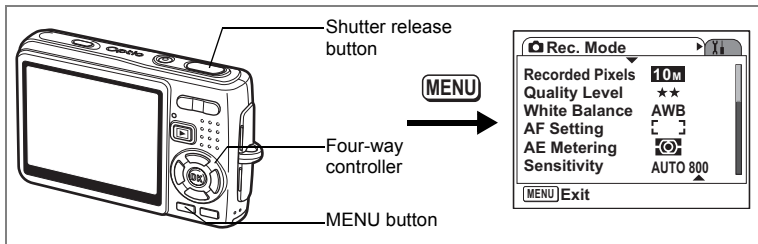

Selecting the Settings for Taking Movies

You can select the recorded pixels and quality level for taking movies.

1 Press the MENU button in Capture mode.

The [Rec. Mode] menu appears.

2 Use the four-way controller (▲▼) to select [Movie].

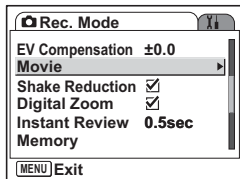

3 Press the four-way controller (▶).

The Movie setting menu appears.

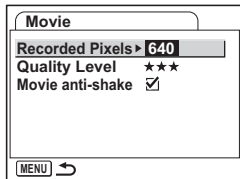

Selecting the Recorded Pixels of Movies

You can select the number of recorded pixels from [640 (640×480)] and [320 (320×240)]. The more pixels are selected, the larger the file size. The file size also varies depending on the quality level setting.

Recorded Pixels

640 (640×480)	You can view high-quality movies at VGA size. The recordable time is shorter.
320 (320×240)	The file size is smaller and the recordable time is longer.

4 Press the four-way controller (▶).

The pull-down menu appears.

5 Use the four-way controller (▲▼) to select [Recorded Pixels].

The recordable time for the selected Recorded Pixels appears.

6 Press the shutter release button halfway.

The camera is ready for taking pictures.

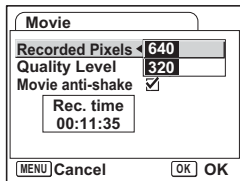

Size and Quality of Movies ⓘ p.24

Selecting the Quality Level of Movies

You can select the quality level from [★★★(Best)], [★★(Better)] and [★(Good)]. The more ★'s, the clearer the movie appears and the larger the file size.

4 Use the four-way controller (▲▼) to select [Quality Level].

5 Press the four-way controller (▶).

The pull-down menu appears.

6 Use the four-way controller (▲▼) to select a desired quality level.

The recordable time for the selected quality level appears.

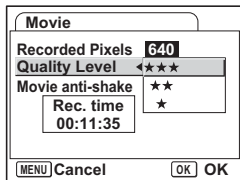
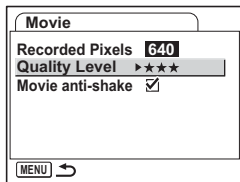

7 Press the shutter release button halfway.

The camera is ready for taking pictures.

Size and Quality of Movies ⓘ p.24

Compensating for Camera Shake While Taking Movies

When you set [Movie anti-shake] to [(On)], you can compensate for camera shake, which is more likely to occur while taking movies. To reduce camera shake while taking still pictures, refer to “Taking Pictures Using the Shake Reduction Function” (p.51).

- 4 Use the four-way controller (▲▼) to select [Movie anti-shake].**
- 5 Use the four-way controller (◀▶) to select [(On)/ (Off)].**

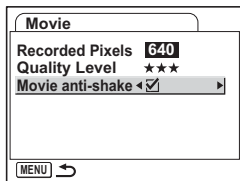

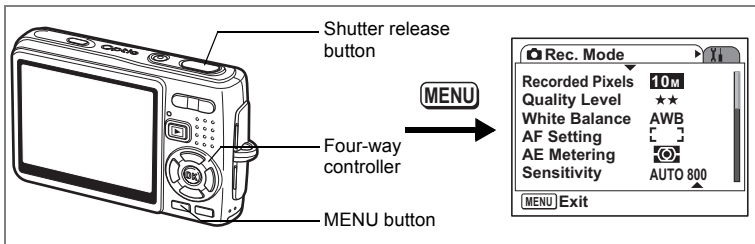

Setting the Shake Reduction for Still Pictures

To use the shake reduction function for still pictures (p.51), you need to set [Shake Reduction] to [✓] (On) in the [Rec. Mode] menu.

4

Taking Pictures

1 Press the MENU button in Capture mode.

The [Rec. Mode] menu appears.

2 Use the four-way controller (▲▼) to select [Shake Reduction].

3 Use the four-way controller (◀▶) to select [✓] (On)/[] (Off).

(On): (Shake Reduction On) is displayed on the capture screen.

(Off): (Shake Reduction Off) is displayed on the capture screen.

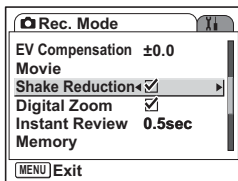

4 Press the shutter release button halfway.

The camera is ready for taking pictures.



You can also select On/Off using the MENU Green button. This function cannot be used when assigning a function other than Shake Reduction to the Green button. (p.100)

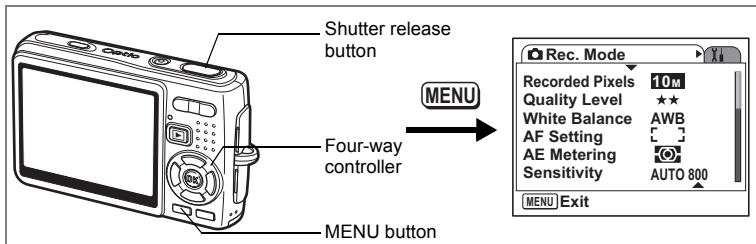

Setting the Instant Review Time

You can select the Instant Review time from [Off (no display)], [0.5 sec.], [1 sec.], [2 sec.], [3 sec.] and [5 sec.].

1 Press the MENU button in Capture mode.

The [Rec.Mode] menu appears.

2 Use the four-way controller (▲▼) to select [Instant Review].

3 Press the four-way controller (▶).

The pull-down menu appears.

4 Use the four-way controller (▲▼) to change the display time.

5 Press the shutter release button halfway.

The camera is ready for taking pictures.

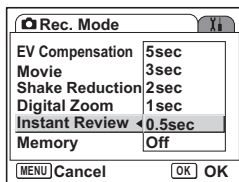
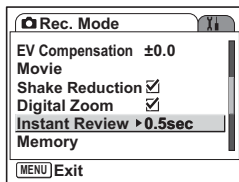

The Instant Review setting is saved when the camera is turned off.

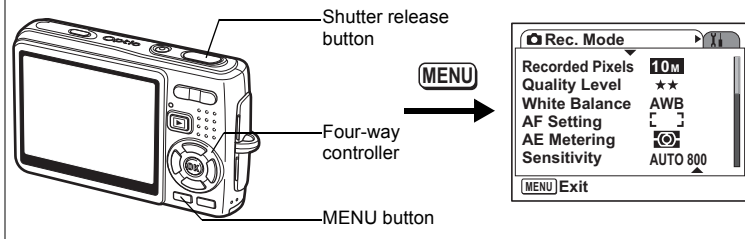

Setting the Green Button

You can assign one of the following functions to the Green button; [Green Mode] (p.52), [Shake Reduction] (p.51), and [Fn Setting] (p.101). You can activate the assigned function just by pressing the Green button.

Assigning a Function (Green Mode/Shake Reduction)

1 Press the MENU button in Capture mode.

The [Rec.Mode] menu appears.

2 Press the four-way controller (▲▼) to select [Green Button].

3 Press the four-way controller (▶).

The Green button setting screen appears.

4 Use the four-way controller (▲▼) to select the function you want to register.

5 Press the shutter release button halfway.

The camera is ready for taking pictures.

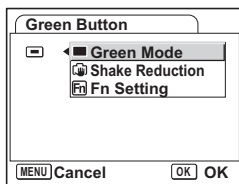
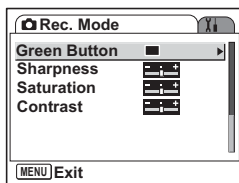

Green Mode is registered as the default setting.

Registering Frequently Used Functions (Fn Setting)

You can register frequently used functions on the four-way controller. Using this function, you can directly set the functions by pressing the four-way controller without displaying the menu in Capture mode.

In [Fn Setting], still picture mode and Movie mode have different settings. To execute [Fn Setting] for Movie mode, press MENU button in Movie mode in Step 1 on page 100.

4 Use the four-way controller (▲▼) to select [Fn Setting].

5 Press the OK button.

The Fn Setting screen appears.

6 Use the four-way controller (▲▼) to select a key you want to assign a function to.

7 Press the four-way controller (▶).

The pull-down menu appears.

8 Use the four-way controller (▲▼) to select a function you want to assign.

9 Press the OK button.

10 Press the shutter release button halfway.

The camera is ready for taking pictures.

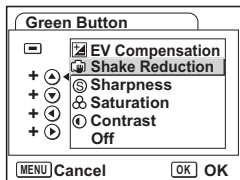
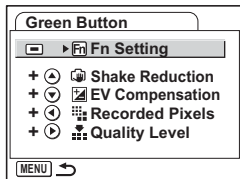
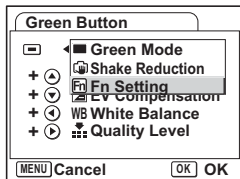

This function is activated only when you assign the Fn Setting to the Green button.



You can assign only one function to each key.

The initial settings for Fn Setting

	still picture mode	Movie mode
Initial settings	(▲) Shake Reduction	(▲) Movie anti-shake
	(▼) EV Compensation	(▼) EV Compensation
	(◀) Recorded Pixels	(◀) Recorded Pixels
	(▶) Quality Level	(▶) Quality Level

Functions that can be registered on Fn Setting

	still picture mode	Movie mode
Setting items	Recorded Pixels	Recorded Pixels
	Quality Level	Quality Level
	White Balance	Movie anti-shake
	Focusing Area	White Balance
	AE Metering	EV Compensation
	Sensitivity	Sharpness
	EV Compensation	Saturation
	Shake Reduction	Contrast
	Sharpness	Off
	Saturation	
	Contrast	
	Off	

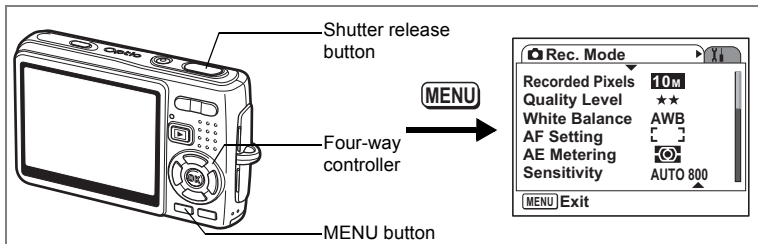

Setting the Image Sharpness

You can select whether you want the image to have sharp or soft outlines.

1 Press the MENU button in Capture mode.

The [Rec.Mode] menu appears.

2 Use the four-way controller (▲▼) to select [Sharpness].

3 Use the four-way controller (◀▶) to adjust sharpness.

- : Softens the contours.
- + : Sharpens the contours.

4 Press the shutter release button halfway.

The camera is ready for taking pictures.

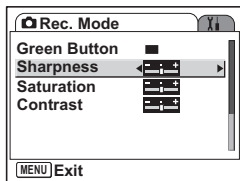

The Sharpness setting is saved when the camera is turned off.

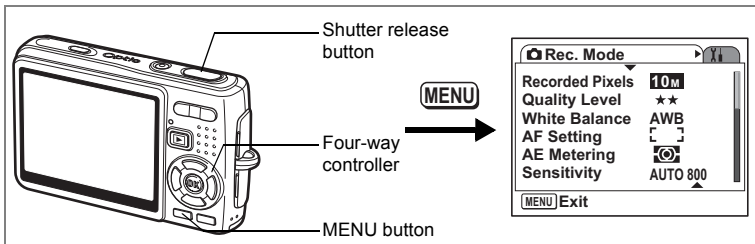

Setting the Color Saturation

You can set the color saturation.

1 Press the MENU button in Capture mode.

The [Rec.Mode] menu appears.

2 Use the four-way controller (▲▼) to select [Saturation].

3 Use the four-way controller (◀▶) to adjust saturation.

- : Reduces the saturation.

+ : Increases the saturation.

4 Press the shutter release button halfway.

The camera is ready for taking pictures.

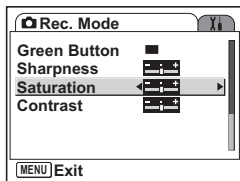

The Saturation setting is saved when the camera is turned off.

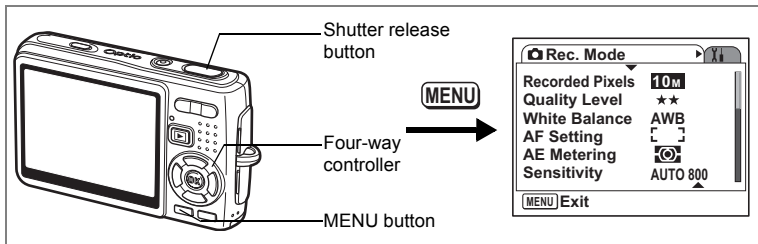

Setting the Image Contrast

You can set the image contrast.

1 Press the MENU button in Capture mode.

The [Rec. Mode] menu appears.

2 Use the four-way controller (▲▼) to select [Contrast].

3 Use the four-way controller (◀▶) to adjust contrast.

– : Reduces the contrast.

+ : Increases the contrast.

4 Press the shutter release button halfway.

The camera is ready for taking pictures.

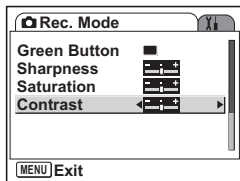

The Contrast setting is saved when the camera is turned off.









Saving the Menu Items (Memory)

You can save the settings for the menus after turning off the camera (Memory function).

Select [On] to save the setting for the menu items after turning off the camera. Select [Off] to reset the setting for the menu items to the default after turning off the camera.

You can set [On] or [Off] to each menu item listed below.

The menu items for Memory

Item	Description	Default Setting
Flash Mode	The flash mode setting on the  button is saved.	<input checked="" type="checkbox"/>
Drive Mode	The drive mode setting ( , etc.) selected using the four-way controller () is saved.	<input type="checkbox"/>
Focus Mode	The focus mode setting on the  button is saved.	<input type="checkbox"/>
Zoom Position	The optical zoom position setting on the zoom button is saved.	<input type="checkbox"/>
MF Position	The manual focus position is saved.	<input type="checkbox"/>
White Balance	The [White Balance] setting on the [ Rec.Mode] menu is saved.	<input type="checkbox"/>
AE Metering	The [AE Metering] setting on the [ Rec.Mode] menu is saved.	<input type="checkbox"/>
Sensitivity	The [Sensitivity] setting on the [ Rec.Mode] menu is saved.	<input type="checkbox"/>
EV Compensation	The [EV Compensation] setting on the [ Rec.Mode] menu is saved.	<input type="checkbox"/>
Digital Zoom	The [Digital Zoom] setting (On/Off) on the [ Rec.Mode] menu is saved.	<input checked="" type="checkbox"/>
DISPLAY	The LCD monitor display mode is saved.	<input type="checkbox"/>
File #	The file number is saved. If a new SD Memory Card is inserted, file numbers are assigned sequentially.	<input checked="" type="checkbox"/>



- The settings you made for the menu items not listed will always be saved after turning off the camera.
- The zoom position setting in the digital zoom range will not be saved even if you set Zoom Position to On in Memory.
- Even if you set Sensitivity to Off in Memory, the selected range for ISO Correction in AUTO is saved when the camera is turned off.

1 Press the MENU button in Capture mode.

The [📷 Rec.Mode] menu appears.

2 Use the four-way controller (▲▼) to select [Memory].

3 Press the four-way controller (▶).

The menu items screen appears.

4 Use the four-way controller (▲▼) to select an item.

5 Use the four-way controller (◀▶) to select [☑ (On)]/☐ (Off)].

6 Press the shutter release button halfway.

The camera is ready for taking pictures.

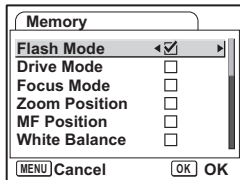
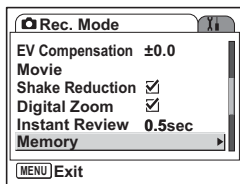

Recording Sound (Voice Recording Mode)

You can record sound. The recordable time appears on the LCD monitor according to how much space is available on the SD Memory Card.

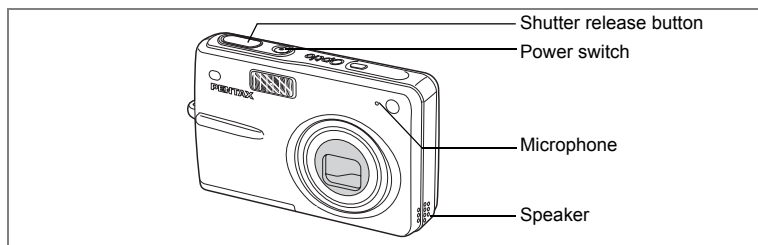

1 Press the four-way controller (▼) in Capture mode.

The Mode Palette appears.

2 Use the four-way controller (▲▼◀▶) to select .

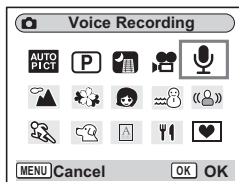

3 Press the OK button.

The recordable time appears on the LCD monitor.

- 1 Remaining recordable time
- 2 Recording time

4 Press the shutter release button.

Recording starts. The access lamp lights during recording.

When the shutter release button is pressed for more than one second, recording continues for as long as the button is held down and stops when the button is released.



5 Press the shutter release button.

Recording stops. The remaining recordable time appears.

6 Press the four-way controller (▼) to display Mode Palette and change to another mode.

You can exit the Voice Recording mode.



- Sound is saved in WAVE monaural files.
- The microphone is located on the front of the camera. Aim the camera to obtain the best sound.
- An index can be added by pressing the MENU button during recording.
- You can record sound for maximum 12 consecutive hours on a high-capacity SD memory card.

Playing Back Sound

You can play back the recording you made in Voice Recording mode.

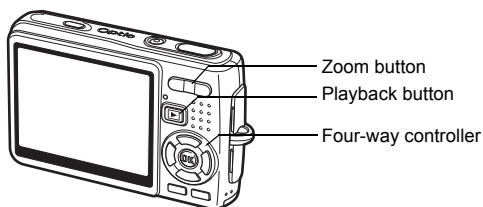

1 Press the  Playback button in the Voice Recording mode.

2 Use the four-way controller ( ) to select the recording to play back.

3 Press the four-way controller ().

Playback starts.

Four-way controller () : Pauses playback.
: Press again to restart playback.

If there are no recorded indexes:

Four-way controller () : Rewinds about five seconds.

Four-way controller () : Advances about five seconds.

If there are recorded indexes:

Four-way controller () : Plays back starting from the previous index.

Four-way controller () : Plays back starting from the next index.

Zoom button () : Increases the volume.

Zoom button () : Reduces the volume.

4 Press the four-way controller ().

Playback stops.



Length of recording

Adding a Voice Memo

You can add a voice memo to a captured image.

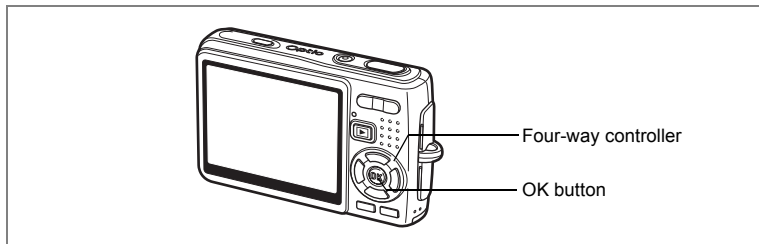

Recording a Voice Memo

- 1 Enter the Playback mode and use the four-way controller (◀▶) to select the image to which you want to add a voice memo.**
- 2 Press the four-way controller (▼).**
The Mode Palette appears.
- 3 Use the four-way controller (▲▼◀▶) to select  (Voice Memo).**
- 4 Press the OK button.**
Recording starts. You can record for up to 30 seconds.
- 5 Press the OK button.**
Recording stops.

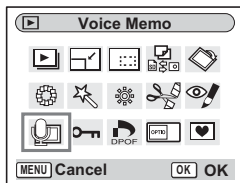

-  appears on the screen when a voice memo is added.
- A voice memo cannot be added to an image which already has a voice memo. Delete the old voice memo and record a new one. (p.122)



A voice memo cannot be added to protected () images.

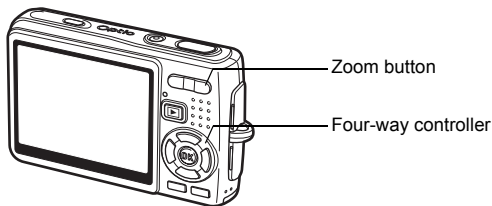

Playing Back a Voice Memo

- 1 Enter the Playback mode and use the four-way controller (◀▶) to select the still picture with the voice memo that you want to play back.**

If  appears on the displayed image, a voice memo has been recorded.



- 2 Press the four-way controller (▲).**
Playback starts.

The following operations can be performed during playback.

Zoom button (▲) : Increases the volume.

Zoom button (▲▲) : Reduces the volume.

- 3 Press the four-way controller (▼).**
Playback stops.

Deleting Voice Memos Only  p.122

Playing Back Images

You can play back images recorded on the SD Memory Card when a card is inserted in the camera, or in the built-in memory when no card is inserted.

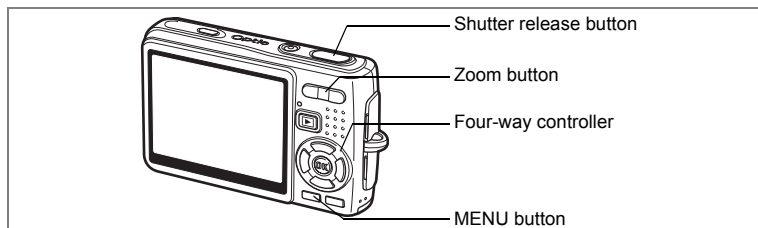

Playing Back Still Pictures

Press the  Playback button.

Refer to “Playing Back an Image” (p.32), or “Playing Back the Previous or Next Image” (p.32) for instructions on playing back images.

Zoom Display

You can display images magnified up to eight times.

1 Enter the Playback mode and use the four-way controller (◀▶) to select the image to magnify.

2 Press ▲/Q on the zoom button.

Each time you press the button, the zoom scaling changes as follows: 1.3x, 2.0x, 2.6x, 4.0x, 5.3x, 8.0x. You can use the guide at the bottom left of the screen to check which portion of the image is magnified.



Guide

Four-way controller (▲▼◀▶): Moves the position for magnification.

Zoom button (▲) : Enlarges the image.

Zoom button (◆◆◆) : Diminishes the image.

3 Press the MENU button.

Zoom playback ends.

Setting the Quick Zoom Function

You can display the image at maximum magnification simply by pressing \blacktriangle/Q on the zoom button once during zoom playback.

1 Press the MENU button.

The [ Rec.Mode] menu appears.

2 Press the four-way controller (▶).

3 Use the four-way controller (▲▼) to select [Quick Zoom].

4 Use the four-way controller (◀▶) to select [(On)/ (Off)].

5 Press the shutter release button halfway.

The camera is ready for taking pictures.

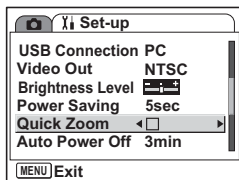

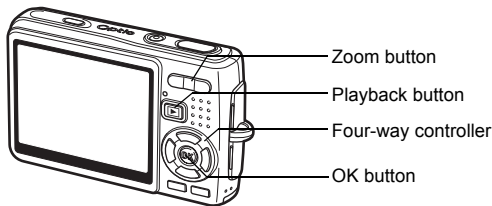

Playing Back Movies

You can play back movies. A guide to operation appears on the LCD monitor during playback. Operations include playback, frame by frame playback (forward or reverse), pause and volume adjustment.

1 Enter the Playback mode and use the four-way controller (◀▶) to select the movie to play back.

2 Press the four-way controller (▲).

Playback starts.

• **The following operations can be performed during playback.**

Four-way controller (◀) : Plays back in fast rewind.

Four-way controller (▶) : Plays back in fast forward.

Four-way controller (▲) : Pauses the movie.

OK button : Changes the display mode. (p.116)

Zoom button (⏏/⏏) : Adjusts the volume.

• **The following operations can be performed during pause.**

Four-way controller (◀) : Reverses the movie frame by frame.

Four-way controller (▶) : Advances the movie frame by frame.

Four-way controller (▲) : Restarts playback.

OK button : Changes the display mode. (p.116)



3 Press the four-way controller (▼).

Playback stops and the screen returns to the first frame.

4 Press the [▶] Playback button.

The camera returns to Capture mode.



No sound is output during fast-rewind and fast-forward playback.

Displaying Shooting Information in Playback Mode

Shooting information can be displayed on the LCD monitor in Playback mode. Pressing the OK button changes the display mode. The Histogram is not displayed while playing back movies.

Normal Display

Shooting information is displayed.

- 1 Voice Memo icon
- 2 Card/Built-in memory icon
- 3 Folder name
- 4 File name
- 5 Protect icon
- 6 Battery indicator
- 7 Shooting date and time
- 8 Four-way controller operation guide



Histogram Display

The brightness distribution of the image is displayed. The horizontal axis shows the brightness (darkest at the left end and brightest at the right end) and the vertical axis shows the number of pixels.

- 1 Recorded pixels
- 2 Quality level
- 3 White balance
- 4 AE metering
- 5 Sensitivity
- 6 Histogram
- 7 Aperture
- 8 Shutter speed

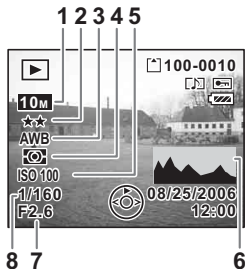

No icons

No shooting information is displayed.



Normal Display

Saving the Display Mode p. 106

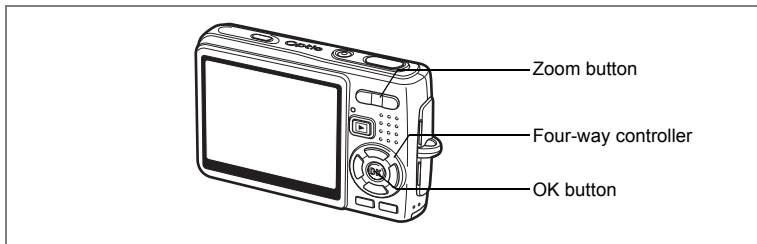

Nine-Image Display/Calendar Display

Nine-Image Display

You can display nine images at the same time.

1 Enter the Playback mode and use the four-way controller (◀▶) to select an image.

2 Press ▲▲▲/☒ on the zoom button.

Nine thumbnails of images are displayed at a time. The thumbnails change nine at a time, page by page.

Four-way controller : Moves the frame.

Four-way controller (◀) : Displays the previous page when the frame is on the upper-left image. (Available only when ten or more files are saved.)

Four-way controller (▶) : Displays the next page when the frame is on the lower-right image. (Available only when ten or more files are saved.)

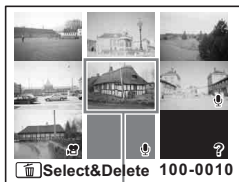

Selected image

The icons that appear on the images indicate the following:

No icon : Still picture without voice memo

🎤 (with image) : Still picture with voice memo

🎬 : Movie (The first frame of the movie is shown.)

🎤 (without image) : Sound file only

❓ : Undisplayable image

3 Press the OK button.

The selected image is displayed full screen.



You can also display the selected image full screen by pressing the MENU button or ▲/☒ on the zoom button.

Calendar Display

In calendar display, the recorded images and sound files are displayed by date in calendar format. You can select images by date of shooting/recording.

1 In Playback mode, press / on the zoom button.

Nine thumbnails of images appear.





2 Press / on the zoom button.

The nine-image display changes to the calendar display.

3 Use the four-way controller () to select a desired date on the calendar.

SUN	MON	TUE	WED	THU	FRI	SAT
		1	2	3	4	5
6	7	8	9	10	11	12
13	14	15	16	17	18	19
20	21	22	23	24	25	26
	28	29		31		

2006.08

Four-way controller (   ) : Moves the frame on the calendar. Selected date

Four-way controller () : When the frame is on the first day of the month, goes back to the previous month.

Four-way controller () : When the frame is on the last day of the month, goes to the next month.

4 Press the OK button or / on the zoom button.

OK button : Displays on full screen the first image recorded on the selected date.

Zoom button (/ ) : Displays the images recorded on the selected date in nine-image display.



-  appears on the date on which a sound file (without image) was first recorded. The first frame of the movie appears on the date on which movie was first recorded.
- Press the MENU button in calendar display to return to the previous nine-image display.

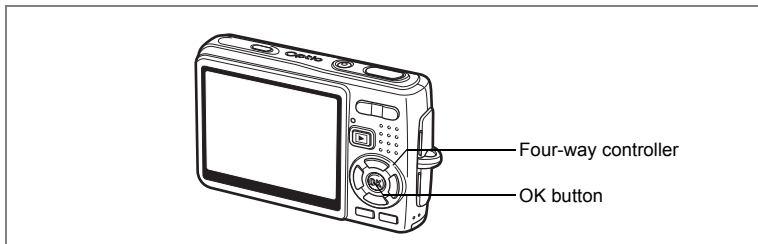

Slideshow

You can play back all the images on the SD Memory Card or in the built-in memory continuously.

- 1** Enter the Playback mode and use the four-way controller (◀▶) to select the image with which to start the slideshow.
- 2** Press the four-way controller (▼).
The Mode Palette appears.
- 3** Use the four-way controller (▲▼◀▶) to select  (Slideshow).
- 4** Press the OK button.
- 5** Use the four-way controller (◀▶) to change the playback interval.
Select from the following: [3 sec], [5 sec], [10 sec], [20 sec], [30 sec].
- 6** Use the four-way controller (▼) to select [Screen Effect].

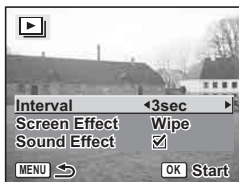
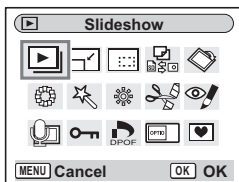

7 Use the four-way controller (◀▶) to select the effect.

Wipe	The effect is like a slide show that slides the displayed images one by one to the left.
Fade	The current image gradually disappears and the next image appears under it.
Shrink	The current image shrinks towards the center.
Off	No screen effect.

8 Use the four-way controller (▼) to select [Sound Effect].

9 Use the four-way controller (◀▶) to select [(On)/ (Off)].

10 Press the OK button.

[Start] appears on the LCD monitor and playback starts at the set interval.

OK button : Pauses the slideshow. Press again to restart the slideshow.

A button other than OK button: Stops the slideshow.



- The slideshow will continue until you press any button.
- Movies and pictures with a voice memo will be played through to the end before the next picture is played back, regardless of the set playback interval.
- Recordings made in Voice Recording mode are not played back.

Deleting Images, Movies and Sounds

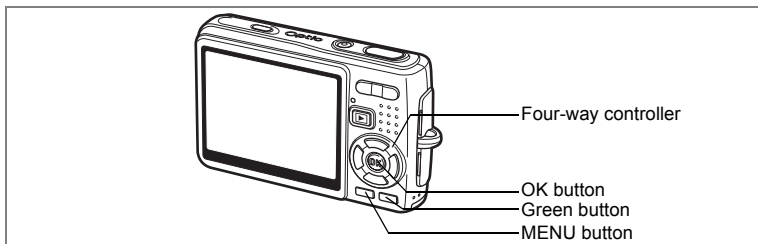

Deleting a Single Image, Movie or Sound

You can delete a single image, movie or sound.



Once deleted, images, movies or sounds cannot be restored.

- 1 Enter the Playback mode and use the four-way controller (◀▶) to select the image, movie or sound to delete.**
- 2 Press the Green button.**
The Delete screen appears.
- 3 Use the four-way controller (▲) to select [Delete].**
- 4 Press the OK button.**
The image, movie or sound is deleted.



- You can also delete images from Instant Review. (p.99)
- You cannot delete protected images, movies or sounds. (p.126)

Deleting a Voice Memo only

If an image has a voice memo, you can delete the voice memo without deleting the image.

1 Enter the Playback mode and use the four-way controller (◀▶) to select an image with a voice memo to delete.

2 Press the Green button.

The Delete screen appears.

3 Use the four-way controller (▲) to select [Delete sound].

4 Press the OK button.

The voice memo is deleted.

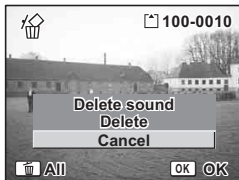

Select Delete in Step 3 above to delete both the image and the voice memo.

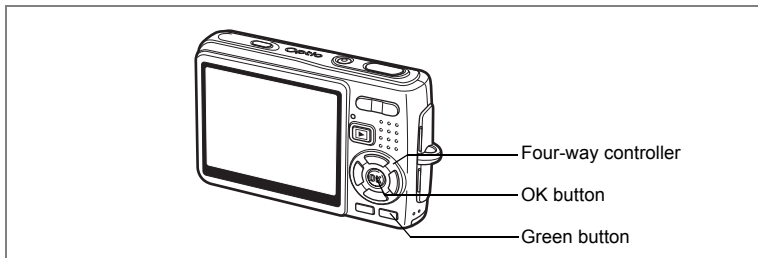

Deleting All Images

You can delete all the images, movies and sounds at once.



Once deleted, images, movies or sounds cannot be restored.

- 1 Enter the Playback mode and press the Green button twice.**
The Delete All screen appears.
- 2 Use the four-way controller (▲) to select [Delete All].**
- 3 Press the OK button.**

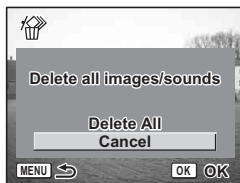

All the images and sounds will be deleted.



You cannot delete protected images, movies or sounds. (p.126)

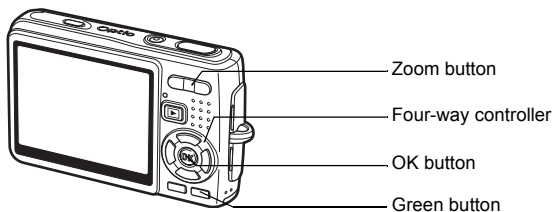

Deleting Selected Images and Sound Files (from Nine-Image Display)

You can delete several images/sound files selected from the nine-image display at once.

- 1 Enter the Playback mode and press $\uparrow\uparrow\uparrow/\square$ on the zoom button.**

Nine thumbnail images appear.

- 2 Press the Green button.**

[□] appears on the images and sound files.

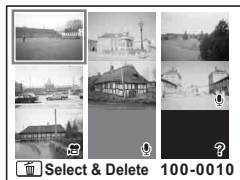

- 3 Use the four-way controller ($\uparrow\downarrow\leftarrow\rightarrow$) to move the frame to an image or sound file you want to delete, and press the OK button.**

[✓] appears on the selected images and sound files.

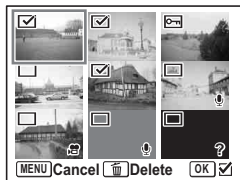

To check the image before deleting, place the frame on the image and press \uparrow/Q on the zoom button to show it in single-image display. (You cannot show a protected image in single-image display.)

Press the MENU button to return to the nine-image display.

4 Press the Green button.

A confirmation dialog appears.

5 Use the four-way controller (▲▼) to select [Select & Delete].

6 Press the OK button.

The selected images and sound files are deleted.



You cannot delete protected images, movies or sounds. (p.126)

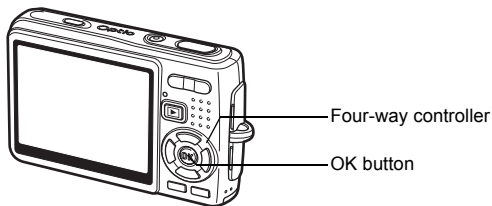

Protecting Images, Movies and Sounds from Deletion (Protect)

You can protect images, movies and sounds from being accidentally deleted.

- 1 Enter the Playback mode and use the four-way controller (◀▶) to select the image, movie or sound to protect.**
- 2 Press the four-way controller (▼).**
The Mode Palette appears.
- 3 Use the four-way controller (▲▼◀▶) to select  (Protect).**
- 4 Press the OK button.**
The Protect screen appears.

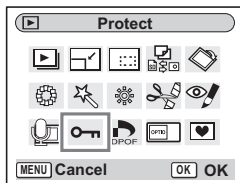



Protecting Images, Movies and Sounds

- 5 Use the four-way controller (▲▼) to select [Select image/sound].**
- 6 Press the OK button.**

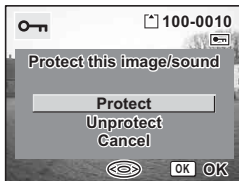

- 7 Use the four-way controller (▲▼) to select [Protect].
- 8 Press the OK button.



- Select Unprotect in Step 7 to cancel the Protect setting.
- If the image, movie or sound is protected, the  icon appears when it is played back.

Protecting All Images, Movies and Sounds

You can protect all the images, movies and sounds.

- 5 Use the four-way controller (▲▼) to select [All Images/Sounds].
- 6 Press the OK button.
The [Protect all images/sounds] message appears.
- 7 Use the four-way controller (▲▼) to select [Protect].
- 8 Press the OK button.

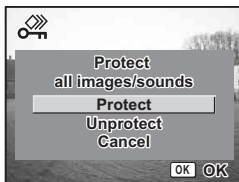
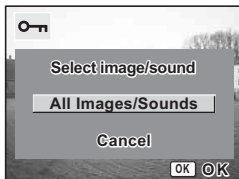

Select Unprotect in Step 7 to cancel the Protect setting on all the images, movies and sounds.



Even protected images, movies and sounds will be deleted by formatting the SD Memory Card or built-in memory.

Viewing Images on AV Equipment

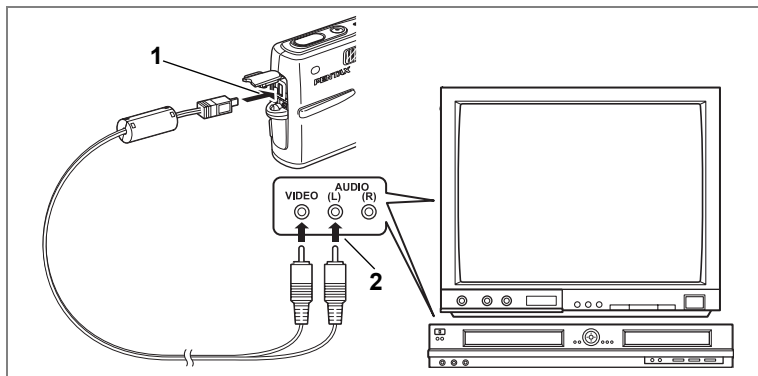

By using the AV cable, you can capture, play back and dub images on a TV or other equipment with a video IN jack. Make sure that both the AV equipment and the camera are turned off before connecting the cable.

6

Playback/Deleting/Editing

- 1 Open the PC/AV terminal cover and connect the AV cable supplied with the AV terminal.**
- 2 Connect the other end of the AV cable to the AV equipment.**
Yellow (video) → video input terminal
White (audio) → sound input terminal
When using stereo sound equipment, insert the sound jack into the L (white) terminal.
- 3 Turn the AV equipment on.**
When the AV equipment connected to the camera and the AV equipment used to view images are separate, turn both pieces of equipment on.
To view images on a TV with several video inputs, switch the video inputs to the one connected to the camera, referring to the operating manual for the TV.
- 4 Turn the camera on.**

Changing the Video Output Format  p.169



- If you intend to use the camera for a long time, use of the AC adapter kit K-AC8 (optional) is recommended. Refer to the operating manual for the TV or equipment to which the camera is connected.
- Images may not be displayed properly depending on the countries or areas when the Video Out setting is the default. In this situation, change the Video Out setting.
- While the camera is connected to the TV, the LCD monitor of the camera is turned off.

Playing Back an Image Using the Remote Control Unit (optional)

When the AV cable is connected to the camera, the image can be displayed using the remote control unit E or F (optional).

- 1 Press the  Playback button.**
- 2 Press the Shutter button or the zoom button of the remote control unit.**

Shutter button : Displays the next image.
Zoom button : Displays the previous image.



- As there is no zoom button on the remote control unit F, only an operation using the shutter button (displaying the next image) is available.
- You cannot play back movies, images with a voice memo, and sound files recorded in Voice Recording mode, using the remote control unit.

Setting the Printing Service (DPOF)

You can print the images on the SD Memory Card using a DPOF (Digital Print Order Format) compatible printer or at a printing service.

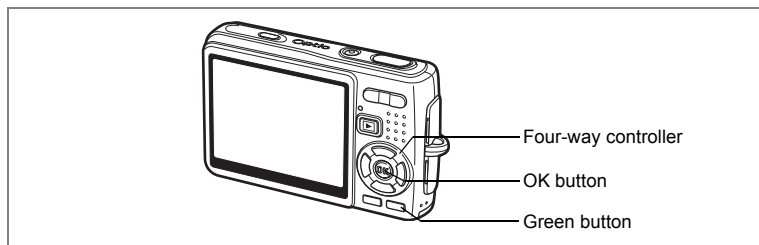

Printing Single Images

Set the following items for each image.

[Copies] : Select the number of copies up to a maximum of 99.

[Date] : Specify whether you want the date imprinted on the print or not.

- 1 Enter the Playback mode and use the four-way controller (◀▶) to select the image to print.**
- 2 Press the four-way controller (▼).**
The Mode Palette appears.
- 3 Use the four-way controller (▲▼◀▶) to select  (DPOF).**
- 4 Press the OK button.**
The DPOF screen appears.
- 5 Press the OK button.**

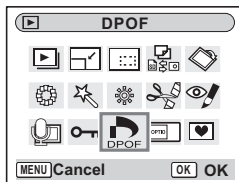

- 6 Use the four-way controller (▲▼) to select the number of copies.**



- 7 Use the Green button to select [(On)/ (Off)] of [Date].**

- (On): The date will be imprinted.
- (Off): The date will not be imprinted.

- 8 Press the OK button.**

Prints can be made according to the settings.



- If DPOF settings have already been made for an image, the previous number of copies and date setting will be displayed.
- To cancel DPOF settings, set the number of copies to 0 and press the OK button.



- You cannot set the printing service for movies or sound-only files.
- Depending on the printer or printing equipment at the photo processing lab., the date may not be imprinted on the pictures even if the DPOF settings were made.

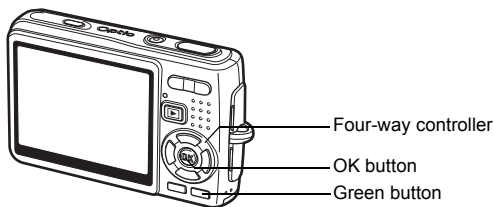

Printing All Images

- 1 Enter the Playback mode and press the four-way controller (▼).**

The Mode Palette appears.

- 2 Use the four-way controller (▲▼◀▶) to select  (DPOF).**

- 3 Press the OK button.**

- 4 Use the four-way controller (▼) to select [All Images].**

- 5 Press the OK button.**

- 6 Use the four-way controller (▲▼) to select the number of copies.**

You can print up to 99 copies.

- 7 Use the Green button to select whether to insert the date or not.**

(On): The date will be imprinted.

(Off): The date will not be imprinted.

- 8 Press the OK button.**

Prints can be made according to the settings.



The number of copies specified in the DPOF settings applies to all the images. Before printing, check that the number is correct.



- Settings for single images are cancelled when settings are made for all images.
- DPOF settings are not possible for movies.

Direct Printing Using PictBridge

By connecting the camera to a printer that supports PictBridge using the USB cable (I-USB17) supplied with the camera, you can print images directly from the camera without using a PC. Select the images you want to print and the number of copies on the camera after it has been connected to the printer.



- We recommend the use of the AC adapter kit K-AC8 (optional) while the camera is connected to the printer. The printer may not work properly or the image data may be damaged if the battery runs out of power while the camera is connected to the printer.
- The access lamp blinks slowly while data is being transferred from the camera to the printer.
- Do not disconnect the USB cable during data transfer.
- Depending on the type of printer, not all the settings made on the camera (such as DPOF settings) may be valid.
- [USB Connection] is set to [PC] by default. Do not connect the camera to a printer when [PC] is selected.

Connecting the Camera to the Printer

- 1 Select [PictBridge] for [USB Connection] on the [X] Set-up] menu.**

Changing the USB Connection Mode p.169

- 2 Connect the camera to the printer using the USB cable supplied with the camera.**

The PictBridge menu appears.

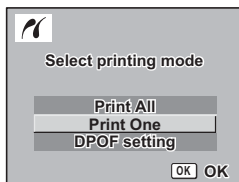

Printing Single Images

1 Use the four-way controller (▲▼) to select [Print One].

2 Press the OK button.

The Print this image screen appears.

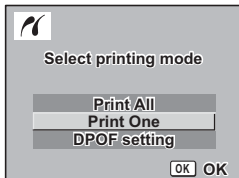

3 Use the four-way controller (◀▶) to select the image to print.

4 Use the four-way controller (▲▼) to select the number of copies.

You can print up to 99 copies.



5 Use the Green button to select whether to insert the date or not.

(On): The date will be imprinted.

(Off): The date will not be imprinted.

6 Press the OK button.

The print settings confirmation screen appears.

To print the image according to the print settings on the printer, press the OK button.

To change the print settings, go to Step 7.

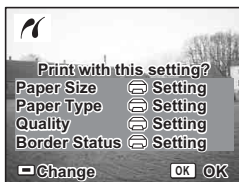

7 Press the Green button.

The Change setting screen appears.

8 Select [Paper Size] and press the four-way controller (▶).

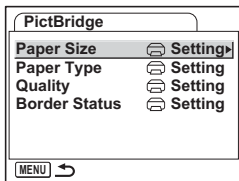

9 Use the four-way controller (▲▼◀▶) to select the paper size.

You can select only the paper sizes available with the printer you are using.

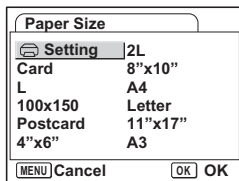

10 Press the OK button.

11 Repeat Step 8 to 10 to set [Paper Type] [Quality] and [Border Status].

When the Paper Size is set to [Setting], images are printed according to the printer settings.

Paper Type with more ★'s supports higher quality paper. Quality with more ★'s indicates higher print quality.

12 Press the OK button twice.

The image is printed according to the settings. Press the MENU button to cancel printing.

Printing All Images

1 Use the four-way controller (▲▼) to select [Print All].

2 Press the OK button.

The Print All screen appears.

Use the four-way controller (◀▶) to check the images and make sure you want to print them all.

3 Confirm the number of copies, the setting of the date, and the print setting, and then start printing.

To set these items and print the images, refer to Steps 4 to 11 on "Printing Single Images" (pages 134 to 135).



Printing Using the DPOF Settings

1 Use the four-way controller (▲▼) to select [DPOF setting].

2 Press the OK button.

The DPOF setting screen appears.

Use the four-way controller (◀▶) to check the images and the print settings.

3 Confirm the number of copies, the setting of the date, and the print setting, and then start printing.

To set the number of copies and the date imprint, refer to “Setting the Printing Service (DPOF)” (p.130). To print the images, refer to Steps 4 to 11 on “Printing Single Images” (pages 134 to 135).



Disconnecting the Camera from the Printer

Disconnect the camera from the printer when you have finished printing.

1 Turn the camera off.

2 Disconnect the USB cable from the camera.

3 Disconnect the USB cable from the printer.



If you disconnect the USB cable from the camera before you turn the camera off, the camera returns to Playback mode.

Editing Images

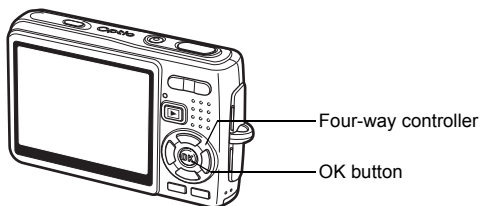

Changing the Image Size and Quality

By changing the size and quality of a selected image, you can make the file smaller than the original. You can use this function to continue taking pictures when the card or memory is full, by making the images smaller and overwriting the original images to make more space available in the memory.

Resizing Single Images

After changing the size and quality, the image can be saved as a new image or written over the original image.

- 1 Use the four-way controller (◀▶) in Playback mode to select an image to resize.**
- 2 Press the four-way controller (▼).**
The Mode Palette appears.
- 3 Use the four-way controller (▲▼◀▶) to select  (Resize).**
- 4 Press the OK button.**
The Resize screen appears.

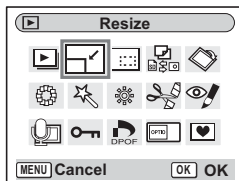

- 5 Use the four-way controller (◀▶) to change the size.**
- 6 Press the four-way controller (▼).**
The frame moves to [Quality Level].
- 7 Use the four-way controller (◀▶) to change the quality.**
- 8 Press the OK button.**
- 9 Use the four-way controller (▲▼) to select [Overwrite] or [Save as].**
- 10 Press the OK button.**
The resized image is saved.



- Movies cannot be resized.
- You cannot select a larger size than that of the original image.
- You can resize the data to 9M, 8M, 6M or 4M.
- Protected images cannot be overwritten.
- You can resize only still pictures taken with this camera.

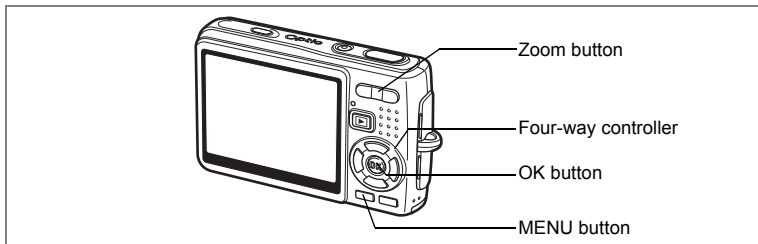

Cropping Images

You can crop a part of a picture and save it as a separate image.

1 Use the four-way controller (◀▶) in Playback mode to select an image to crop.

2 Press the four-way controller (▼).

The Mode Palette appears.

3 Use the four-way controller (▲▼◀▶) to select  (Cropping).

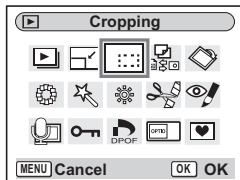

4 Press the OK button.

The Cropping screen appears.

5 Crop the image.

Zoom button (▲) : Enlarges the area to be cropped.

Zoom button (▼) : Reduces the area to be cropped.

Four-way controller (▲▼◀▶) : Moves the cropping frame.

MENU button : Returns to the Mode Palette.

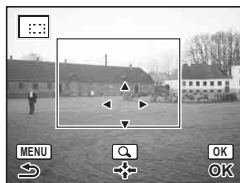

6 Press the OK button.

The cropped image is saved as a separate image.



- Movies cannot be cropped.
- The image size is changed and saved.
- You can only crop still pictures taken with this camera.

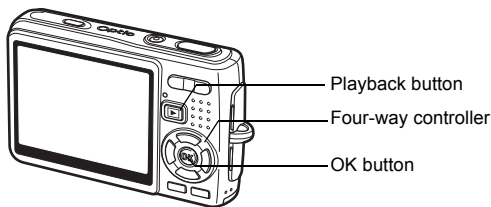

Rotating the Displayed Image

You can rotate a displayed image on the LCD monitor.

1 In Playback mode, use the four-way controller (◀▶) to select the image to be rotated.

2 Press the four-way controller (▼) in Playback mode.

The Mode Palette appears.

3 Use the four-way controller (▲▼◀▶) to select  (Image Rotation).

4 Press the OK button.

The Image Rotation screen appears.

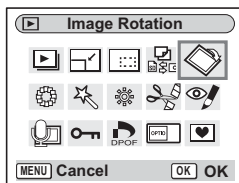

5 Press the four-way controller (▶) or the four-way controller (◀).

Four-way controller (▶) : Rotates the image 90 degrees clockwise each time you press the button.

Four-way controller (◀) : Rotates the image 90 degrees counter clockwise each time you press the button.

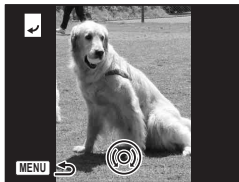

6 Press the  button.

The camera saves the rotated image and returns to Playback mode.



- You can rotate protected (🔒) images, but the rotated image will not be saved.
- You cannot rotate movies.

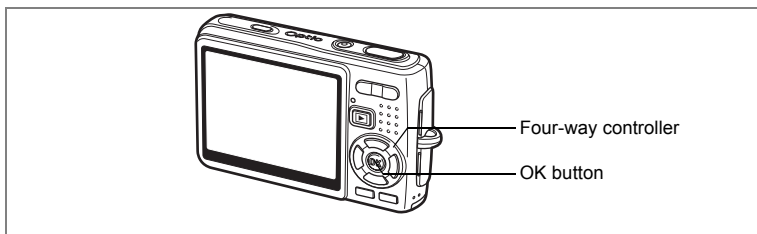

Editing Pictures with Color Filters

This function enables you to edit still pictures with color filters. You can select from thirteen filters: [B&W], [Sepia], [Eight colors], [B&W + Red], [B&W + Green], and [B&W + Blue].

- 1 Use the four-way controller (◀▶) in Playback mode to select an image to edit.**
- 2 Press the four-way controller (▼).**
The Mode Palette appears.
- 3 Use the four-way controller (▲▼◀▶) to select  (Color Filter).**
- 4 Press the OK button.**
The color filter screen appears.
- 5 Use the four-way controller (▲▼) to select a desired filter.**
- 6 Press the OK button.**
The overwrite confirmation screen appears.
- 7 Use the four-way controller (▲▼) to select [Overwrite] or [Save as].**
- 8 Press the OK button.**
The edited image is saved with the same number of recorded pixels and quality level as the original.

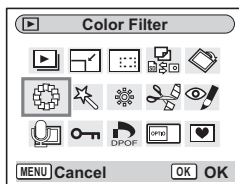

Selecting the Color Filter (Eight Colors)

- 5** Use the four-way controller (▲▼) to select  (Eight colors).

The color bar appears.

- 6** Use the four-way controller (◀▶) to select a desired color.

- 7** Press the OK button.

The Overwrite confirmation screen appears.

- 8** Use the four-way controller (▲▼) to select [Overwrite] or [Save as].

- 9** Press the OK button.

The edited image is saved with the same number of recorded pixels and quality level as the original.

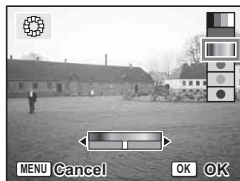

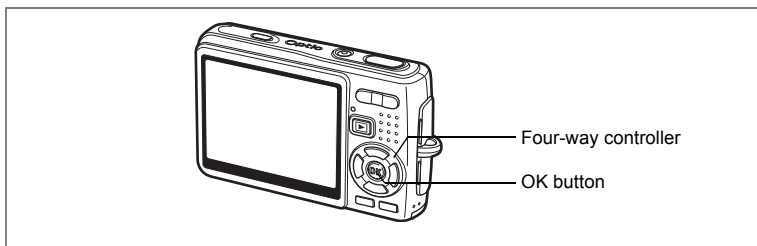

Editing Pictures with the Digital Filter

This function enables you to apply special effects to still pictures with the digital filter. You can select from five filters: [Soft], [Illustration], [Special Effect 1], [Special Effect 2] and [Slim].

- 1 Use the four-way controller (◀▶) in Playback mode to select an image to edit.**
- 2 Press the four-way controller (▼).**
The Mode Palette appears.
- 3 Use the four-way controller (▲▼◀▶) to select  (Digital Filter).**
- 4 Press the OK button.**
The Digital Filter screen appears.
- 5 Press the four-way controller (▲▼) to select a desired filter.**
- 6 Press the OK button.**
The overwrite confirmation screen appears.

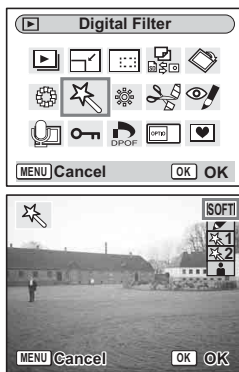

7 Use the four-way controller (▲▼) to select [Overwrite] or [Save as].

8 Press the OK button.

The edited image is saved with the same number of recorded pixels and quality level as the original.

Selecting the Slim Filter

5 Press the four-way controller (▲▼) to select  (Slim Filter).

6 Press the four-way controller (◀▶) to adjust the strength of the slim effect.

7 Press the OK button.

The overwrite confirmation screen appears.

8 Use the four-way controller (▲▼) to select [Overwrite] or [Save as].

9 Press the OK button.

The edited image is saved with the same number of recorded pixels and quality level as the original.

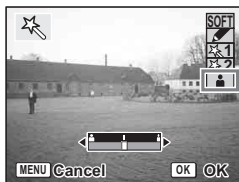

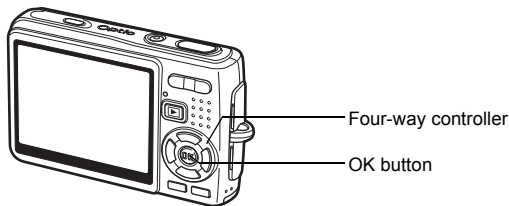

Editing Pictures with Brightness Filter

This function enables you to adjust the brightness of still pictures with the brightness filter.

1 Use the four-way controller (◀▶) in Playback mode to select an image to edit.

2 Press the four-way controller (▼).

The Mode Palette appears.

3 Use the four-way controller (▲▼◀▶) to select * (Brightness Filter).

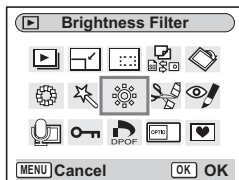

4 Press the OK button.

The brightness filter screen appears.

5 Use the four-way controller (◀▶) to adjust the brightness.

Four-way controller (▶) : Brightens the image.

Four-way controller (◀) : Darkens the image.

The brightness is selected between -2.0EV and +2.0EV by 1/3EV step.

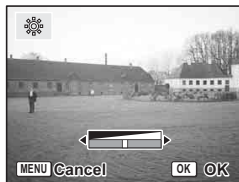

6 Press the OK button.

The overwrite confirmation screen appears.

7 Use the four-way controller (▲▼) to select [Overwrite] or [Save as].

8 Press the OK button.

The edited image is saved with the same number of recorded pixels and quality level as the original.

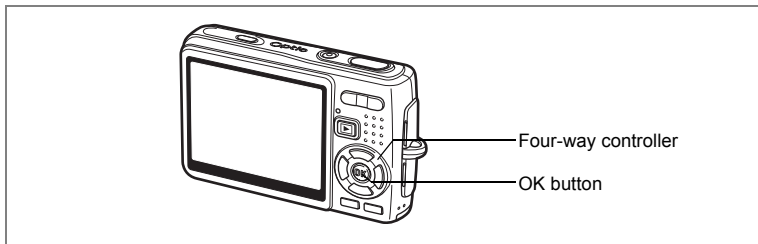

Editing Movies

You can select a frame from a recorded movie to save as a still picture or divide a movie into two.

- 1 Use the four-way controller (◀▶) in Playback mode to select a movie to edit.**
- 2 Press the four-way controller (▼).**
The Mode Palette appears.
- 3 Use the four-way controller (▲▼◀▶) to select  (Movie Edit).**
- 4 Press the OK button.**
The Movie Edit screen appears. Select the editing function that you want to use.

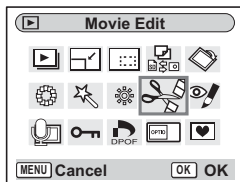

Saving a Frame from a Movie as a Still Picture

- 5 Use the four-way controller (▲▼) to select [Save as Still Image].**
- 6 Press the OK button.**
The screen for choosing a frame appears.

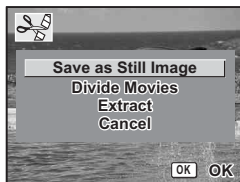

- 7 Press the four-way controller (▲) to play back a movie. Press (▲) again to pause the movie at the point you want to save.**

The following operations are available during pause.

Four-way controller (◀): Reverses the movie frame by frame.

Four-way controller (▶): Advances the movie frame by frame.

- 8 Press the OK button.**

The selected frame is saved as a still picture.



Dividing a Movie

- 5 Select [Divide Movies] on the Movie Edit screen.**

- 6 Press the OK button.**

The screen for choosing the dividing position appears.

- 7 Press the four-way controller (▲) to play back a movie. Press (▲) again to pause the movie at the desired dividing position.**

The following operations are available during pause.

Four-way controller (◀): Reverses the movie frame by frame.

Four-way controller (▶): Advances the movie frame by frame.

- 8 Press the OK button.**

The confirmation screen appears.

- 9 Use the four-way controller (▲▼) to select [Divide].**

- 10 Press the OK button.**

The movie is divided at the specified position and the two portions are saved as separate files.

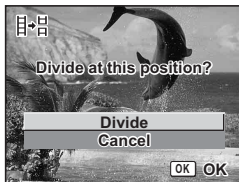

Extracting Movies

5 Select [Extract] on the Movie Edit screen.

6 Press the OK button.

The Extract screen appears.

7 Press the four-way controller (▲) to play back the movie and press it again to select the desired start point.

The movie is paused.

The following operations are available during pause.

Four-way controller (▶) : Advances the movie frame by frame.

Four-way controller (◀) : Reverses the movie frame by frame.

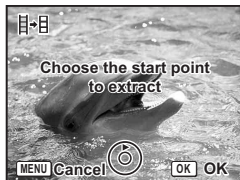

8 Press the OK button.

9 Press the four-way controller (▲) to play back the movie and press it again to select the desired end point.

The movie is paused.

The following operations are available during pause.

Four-way controller (▶) : Advances the movie frame by frame.

Four-way controller (◀) : Reverses the movie frame by frame.

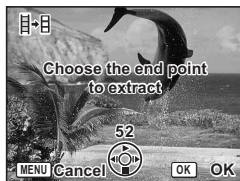

10 Press the OK button.

The extracted movie is saved.

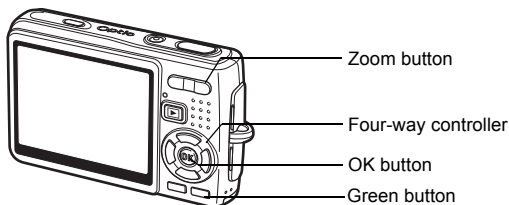

Removing Red-eye

You can remove red-eye (a phenomenon that occurs when the flash reflects from the subject's eyes) from your pictures.

1 In Playback mode, press the four-way controller (◀▶) to select the image you want to correct.

2 Press the four-way controller (▼).

The Mode Palette appears.

3 Use the four-way controller (▲▼◀▶) to select  (Red-eye Compensation).

4 Press the OK button.

A confirmation dialog for overwriting the image appears.

If the error message [Cannot process correctly] appears, go to the step 5 in "Removing Red-eye Manually" (page 151).

5 Use the four-way controller (▲▼) to select [Overwrite] or [Save as].

When the image is protected, [Save as] will be selected automatically.

6 Press the OK button.

The edited image is saved with the same number of recorded pixels and quality level as the original.

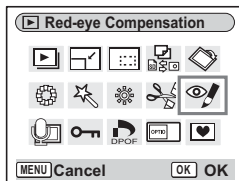

Caution

- Red-eye compensation function cannot be used for movies. If you try to do so, the error message will appear as described in step 4.
- Red-eye compensation function can only be used for still pictures taken with this camera.

Removing Red-eye Manually

If the camera does not detect the red-eye, remove it manually.

5 Press the OK button.

The message [Select the area to compensate] and the screen for specifying the area for compensation appears.

6 Specify the area for compensation.

Four-way controller : Moves the area.

(▲▼◀▶)

Zoom button (▲) : Enlarges the area.

Zoom button (▼) : Reduces the area.

7 Press the Green button.

Compensation starts.

When no error message appears, the compensation was successfully done. Go to the step 8.

If the error message [Cannot process correctly] appears, repeat the steps 5, 6 and 7.

8 Press the OK button.

A confirmation dialog for overwriting the image appears.

9 Use the four-way controller (▲▼) to select [Overwrite] or [Save as].

When the image is protected, [Save as] will be selected automatically.

10 Press the OK button.

The corrected image is saved with the same number of recorded pixels and quality level as the original.

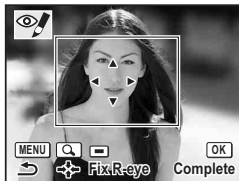

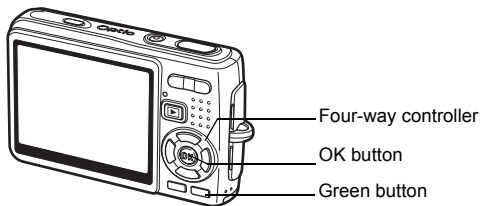

Adding a Frame (Frame Composite)

This function lets you add a decorative frame to still pictures. There are three frames already stored in the camera.

1 Use the four-way controller (◀▶) in Playback mode to select the image to which you want to add a frame.

2 Press the four-way controller (▼).

The Mode Palette appears.

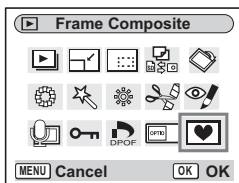

3 Use the four-way controller (▲▼◀▶) to select  (Frame Composite).

4 Press the OK button.

The frame selection screen appears.

5 Use the four-way controller (◀▶) to select a frame.

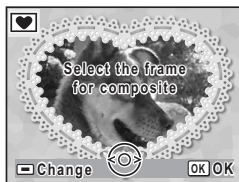

6 Press the OK button.

A confirmation dialog for overwriting the image appears.

7 Use the four-way controller (▲▼) to select [Overwrite] or [Save as].

[Save as] is the only option available for protected images.



8 Press the OK button.

The edited image is saved with the recorded pixels of 3M.



The frame composite function cannot be used on movies or images with a size of 2M or smaller. An error message appears in Step 4.

To Register a New Frame

To switch to the screen for registering a frame, press the Green button in Step 5. You can register frames which you have downloaded from the internet, etc. When you register a new frame, it replaces one of the existing frames in the built-in memory. Before you can register a new frame, copy it first to the SD Memory Card.



When a new frame on the SD Memory Card is registered in the built-in memory, it replaces one of the existing frames in the built-in memory. The replaced frame is deleted from the built-in memory.

1 In the frame selection screen, select the frame you want to remove and press the Green button.

A message appears and the frames on the SD Memory Card that you can register in the built-in memory appear.

2 Use the four-way controller (◀▶) to select the frame you want to register and press the OK button.

The frame is registered in the built-in memory and replaces the frame selected in Step 1.

Visit the PENTAX website at the URL below to download new frames.

http://www.pentax.co.jp/english/support/digital/frame_02.html

Copying Files

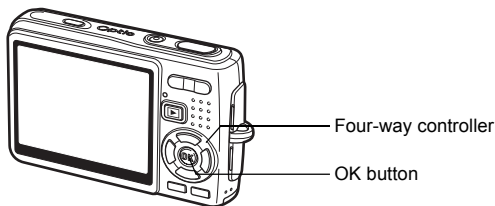

You can copy image and sound files from the built-in memory to the SD Memory Card and vice versa. This function can only be selected when a card has been inserted in the camera.

When files are copied from the built-in memory to the SD Memory Card, all the files are copied at once. When files are copied from the SD Memory Card to the built-in memory, the files are copied one at a time.

1 Press the four-way controller (▼) in Playback mode.

The Mode Palette appears.

2 Use the four-way controller (▲▼◀▶) to select (Image/Sound Copy).

The Image/Sound Copy screen appears. Select the copying method you want to use.

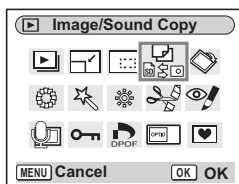

3 Press the OK button.



Be sure to turn the camera off before inserting or removing the SD Memory Card.

To Copy Files from the Built-in Memory to the SD Memory Card

- 4** Use the four-way controller (▲▼) to select [📷 → SD] and press the OK button.

All the files are copied to the SD Memory Card.

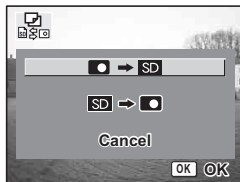

To Copy Files from the SD Memory Card to the Built-in Memory

- 4** Use the four-way controller (▲▼) to select [SD → 📷] and press the OK button.
- 5** Use the four-way controller (◀▶) to select the file to copy.
- 6** Press the OK button.

The selected file is copied to the built-in memory.



- If the image has a voice memo, the sound file will be copied at the same time as the image.
- When a file is copied from the SD Memory Card to the built-in memory, it is assigned a new file name.

Camera Settings

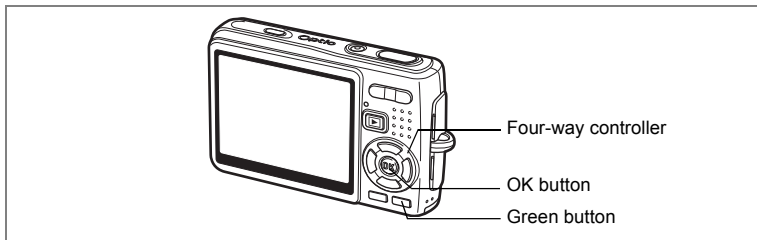

Setting Up the Start-up Screen

You can display an image recorded with the camera as the start-up screen when the camera is turned on.

1 Press the four-way controller (▼) in Playback mode.

The Mode Palette appears.

2 Press the four-way controller (▲▼◀▶) to select  (Start-up Screen).

3 Press the OK button.

The screen for setting start-up screen appears. You can select from five different types of start-up screens, including [USER] and [Off].

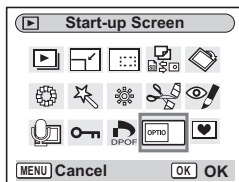

Setting Up the Start-up Screen Using a Captured Image (Go to Step 5 to select a start-up screen other than USER)

- 4 Press the Green button, while displaying [USER] in the upper-right corner of the screen, and use the four-way controller (◀▶) to select an image for the start-up screen, and press the OK button.**

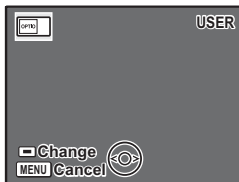

To change a captured image set as a start-up screen to another image, press the Green button once to delete the image and press it again to show the screen for selecting a captured image.

- 5 Press the OK button.**

The camera is ready for playing back images.



- Once the start-up screen has been set, it will not be deleted even if the original image is deleted or the SD Memory Card or built-in memory is formatted.
- You cannot set up the start-up screen while playing back images on a TV or other equipment.

How to recall the [X↓ Set-up] menu

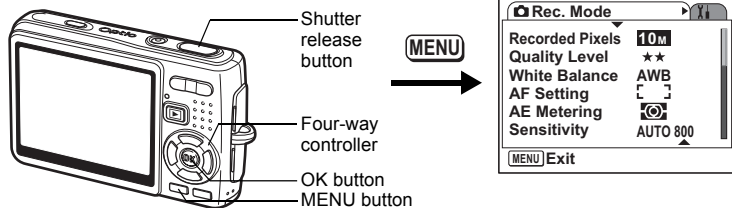

Formatting an SD Memory Card or the Built-in Memory

Formatting will delete all the files on the SD Memory Card if you are using a card, and all the files in the built-in memory if there is no SD Memory Card inserted.



- Do not remove the SD Memory Card while the card is being formatted as this may damage the card and render it unusable.
- SD Memory Cards formatted on a PC or device other than the camera cannot be used. Be sure to format the card with the camera.
- Note that formatting will also delete protected files.

7

Settings

- 1 Select [Format] on the [X↓ Set-up] menu.**
- 2 Press the four-way controller (▶).**
The Format screen appears.
- 3 Use the four-way controller (▲) to select [Format].**
- 4 Press the OK button.**

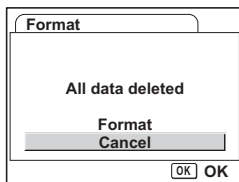

Formatting starts. When formatting is completed, the camera is ready for taking pictures.



If formatting was performed in Playback mode, the camera returns to Playback mode after it was completed, then the [No image/sound] message appears.

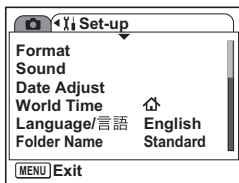

Changing the Sound Settings

You can adjust the playback volume and the volume of operation sounds, such as the start-up sound, shutter sound and operation sound. You can also change the operation sounds.

- 1 Select [Sound] on the [Set-up] menu.**
- 2 Press the four-way controller (▶).**

The screen for setting sounds appears.
[Operation Volume] is highlighted.

Changing the Volume

- 3 Use the four-way controller (◀▶) to change the operation volume.**
- 4 Use the four-way controller (▼) to select [Playback Volume].**
- 5 Use the four-way controller (◀▶) to change the volume of playback sounds.**
- 6 Press the shutter release button halfway.**
The camera is ready for taking pictures.

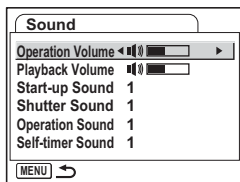

How to recall the [X] Set-up] menu

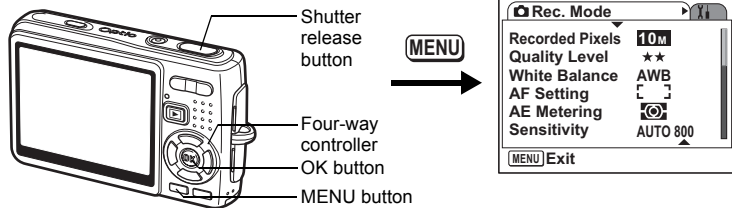

Changing the Sound

- Use the four-way controller (▲▼) to select [Start-up Sound].
- Press the four-way controller (▶).
The pull-down menu appears.
- Use the four-way controller (▲▼) to select [1], [2], [3] or [Off].
- Press the OK button.
- Change [Shutter Sound], [Operation Sound] and [Self-timer Sound] in the same manner.
- Press the shutter release button halfway.
The camera is ready for taking pictures.

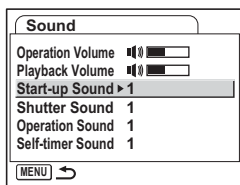

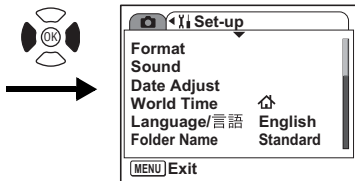

Changing the Sound (Using a Recorded Sound File)

You can use the sound recorded on the camera for sound settings. The first two seconds of the selected sound file will be played as [USER] sound.

1 Select [USER] in Step 5 in “Changing the Sound”.

2 Press the OK button.

The playback screen for the recorded sound files appears.

3 Use the four-way controller (◀▶) to select a sound file.

Play back the selected file to confirm.

Four-way controller (▲) : Plays back the first two seconds of the sound file.

Four-way controller (▼) : Stops playback.

4 Press the OK button.

The selected sound is set as the [USER] sound.

5 Set [Shutter sound], [Operation Sound] and [Self-timer Sound] in the same manner.

6 Press the shutter release button halfway.

The camera is ready for taking pictures.



The Sound settings are saved when the camera is turned off.

How to recall the [X/Set-up] menu

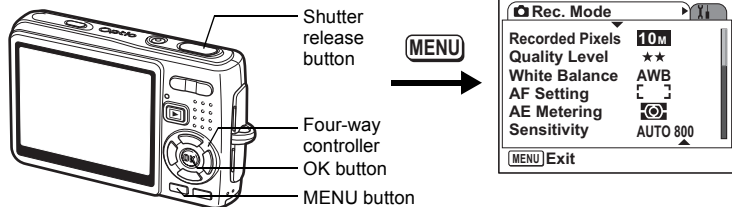

Changing the Date and Time

You can change the initial date and time settings. You can also set the style in which the date appears on the camera. Select [mm/dd/yy], [dd/mm/yy] or [yy/mm/dd].

1 Select [Date Adjust] on the [X/Set-up] menu.

2 Press the four-way controller (▶).

The Date Adjust screen appears.

3 Press the four-way controller (▶).

The frame moves to [mm/dd/yy].

4 Use the four-way controller (▲▼) to select the date display style.

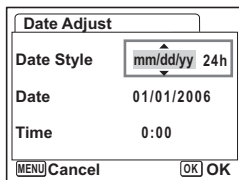

5 Press the four-way controller (▶).

The frame moves to [24h].

6 Use the four-way controller (▲▼) to select [24h] (24-hour display) or [12h] (12-hour display).

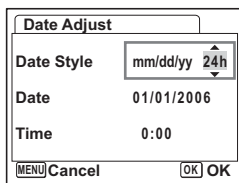

7 Press the four-way controller (▶).

The frame moves to [Date Style].

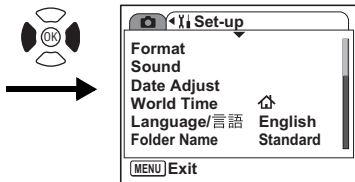

8 Press the four-way controller (▼).

The frame moves to [Date].

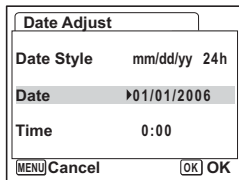

9 Press the four-way controller (▶).

The frame moves to month.

10 Use the four-way controller (▲▼) to change the month.

Change the day and year in the same manner.

Next, change the time.

If you select [12h] in Step 6, the setting switches between “am” and “pm” corresponding to the time.

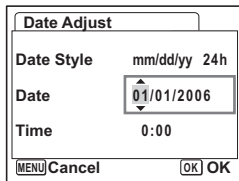

11 Press the OK button.

The settings are made.

12 Press the shutter release button halfway.

The camera is ready for taking pictures.

How to recall the [X] Set-up menu

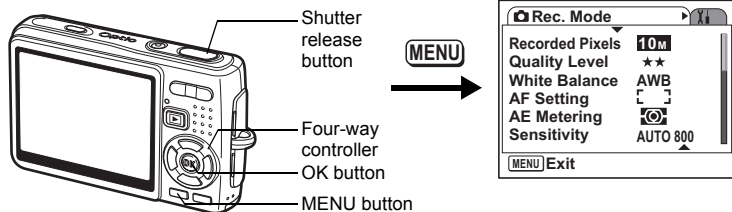

Setting the World Time

The date and time selected in “Initial Settings (Setting the Display Language and the Date and Time)” (p.26) serve as the Home Time setting. You can display the time in a city other than the Home Time city (World Time). This is useful when taking pictures abroad.

1 Select [World Time] on the [X] Set-up menu.

2 Press the four-way controller (▶).

The World Time screen appears.

3 Use the four-way controller (◀▶) to select [→ (Destination)] or [⌄ (Hometown)].

→ (Destination) : Displays the time in the city selected as the Destination city.

⌄ (Hometown) : Displays the time in the city selected as the Hometown city.



4 Press the four-way controller (▼) to select [→ (Destination)].

5 Press the four-way controller (▶).

The Destination screen appears. The city that is currently selected blinks on the map.

6 Use the four-way controller (◀▶) to change the Destination city.

The location of the destination and the time difference between the hometown and the destination appear.



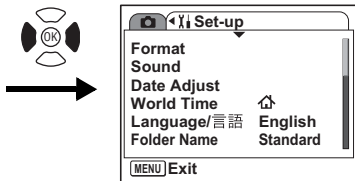

- 7 Use the four-way controller (▼) to select [DST].**
- 8 Use the four-way controller (◀▶) to select [(On) / (Off)].**
Select [(On)] if the Destination city uses daylight saving time.
- 9 Press the OK button.**
The World Time setting is saved.
- 10 Press the four-way controller (▼) to select [(Hometown)].**
Set the location and the current time in the same manner as Steps 5 to 9.
- 11 Press the shutter release button halfway.**
The camera is ready for taking pictures.

How to recall the [X] Set-up] menu

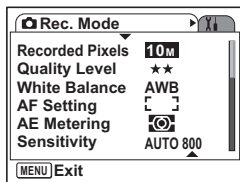
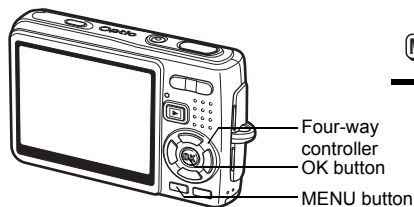

Changing the Display Language

You can change the language in which the menus, error messages, etc. are displayed.

You can select from [English], [French], [German], [Spanish], [Portuguese], [Italian], [Swedish], [Dutch], [Russian], [Thai], [Korean], [Chinese (traditional and simplified)], and [Japanese].

- 1 Select [Language/言語] on the [X] Set-up] menu.
- 2 Press the four-way controller (▶).
- 3 Use the four-way controller (▲ ▼ ◀ ▶) to select the language.
- 4 Press the OK button.
- 5 Press the MENU button.

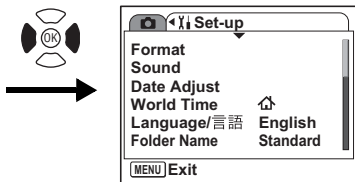

Changing the Image Folder Name

You can select the folder name style from [Standard] or [Date]. When you select [Date], pictures and sound files are saved in separate folders of the shooting/recording date.

Folder Name

Standard	xxxPENTX (xxx is 3-digit folder number.)
Date	xxx_mmdd (3-digit folder number_month day)

Example:

When [Standard] selected (Shooting date: August 25) When you change to [Date] (Shooting date: August 25) When you take pictures next time (Shooting date: September 15)

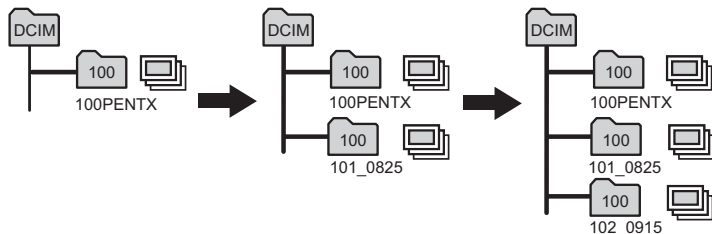

- 1** Select [Folder Name] on the [X↓ Set-up] menu.
 - 2** Press the four-way controller (▶).
- The pull-down menu appears.
- 3** Use the four-way controller (▲ ▼) to select [Standard] or [Date].
 - 4** Press the OK button.



- If you set [Date Style] to [dd/mm/yy], the folder name appears as "xxx_ddmm" (3-digit folder number_day month).
- The capacity of an image folder is 500 files maximum. When the number of files reaches 500, a new folder will be automatically created.

How to recall the [X↓ Set-up] menu

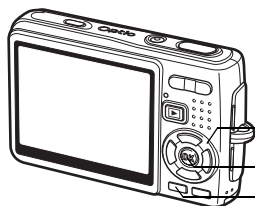

Four-way controller
OK button
MENU button

MENU

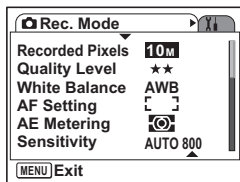

Changing the USB Connection Mode

You can change the USB Connection mode depending on whether the USB cable is to be connected to a printer (PictBridge) or a computer.

- 1 Select [USB Connection] on the [X↓ Set-up] menu.**
- 2 Press the four-way controller (▶).**
The pull-down menu appears.
- 3 Use the four-way controller (▲▼) to select [PC] or [PictBridge].**
- 4 Press the [▶] Playback button.**

The camera is ready for playing back images.

7

Settings



For details on connecting the camera to a computer, see "PC Connection Manual" (a separate volume).



- Do not connect the camera to a computer when [Pictbridge] is selected.
- Do not connect the camera to a printer when [PC] is selected.

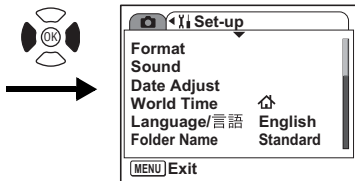

Changing the Video Output Format

You can select the output format (NTSC or PAL) for taking or playing back images on a TV.

- 1 Select [Video Out] on the [X Set-up] menu.**
- 2 Press the four-way controller (▶).**

The pull-down menu appears.
- 3 Use the four-way controller (▲ ▼) to select [NTSC] or [PAL].**

Select the video output format to match the output format of the TV.
- 4 Press the  Playback button.**

The camera is ready for playing back images.

How to recall the [X] Set-up] menu

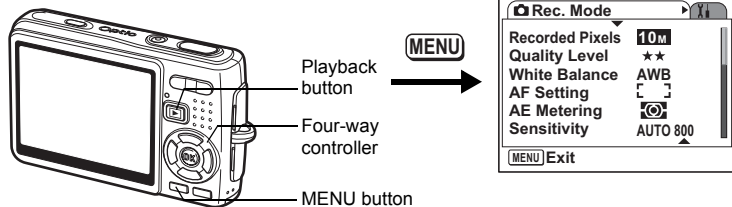

Adjusting the Brightness of the LCD Monitor

You can adjust the brightness of the LCD monitor by seven levels.

- 1 Select [Brightness Level] on the [X] Set-up] menu.**
- 2 Use the four-way controller (◀▶) to adjust the brightness.**

Slide leftwards : Darkens the LCD monitor.
Slide rightwards : Brightens the LCD monitor.
- 3 Press the ▶ Playback button.**

The camera is ready for playing back images.

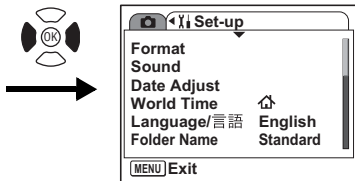

Setting Power Saving

By setting the LCD monitor to dim automatically when you leave the camera without performing any operations for a certain period, you can lessen battery drain. When Power Saving takes effect and the LCD monitor dims, press any button to return to the ordinary brightness.

- 1 Select [Power Saving] on the [X↓ Set-up] menu.**
- 2 Press the four-way controller (▶).**
The pull-down menu appears.
- 3 Use the four-way controller (▲▼) to select [2 min], [1 min], [30 sec], [15 sec], [5 sec] or [Off].**
- 4 Press the [▶] Playback button.**
The camera is ready for playing back images.



The Power Saving function will not work in the following conditions.

- In Playback mode
- When the USB cable is connected
- While taking movies

How to recall the [X↓ Set-up] menu

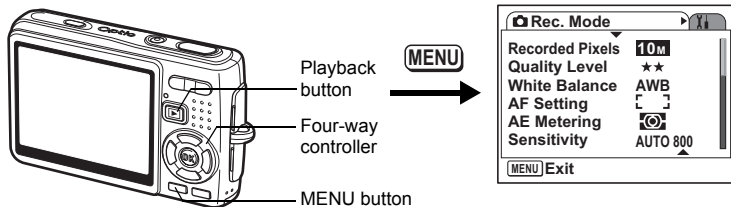

Setting Auto Power Off

You can set the camera to turn off automatically when no operation is performed after a fixed time.

- 1 Select [Auto Power Off] on the [X↓ Set-up] menu.**
- 2 Press the four-way controller (▶).**
The pull-down menu appears.
- 3 Use the four-way controller (▲▼) to select [5 min], [3 min] or [Off].**
- 4 Press the  Playback button.**
The camera is ready for playing back images.



The Auto Power Off function will not work when the USB cable is connected.

Setting the Guide Display

You can show the information on the current mode and the functions currently assigned to the Green button when you start up the camera in Capture mode or switch from other modes to Capture mode.

You can also show the description for the selected mode on the Mode Palette.

- 1 Select [Guide Display] on the [X↓ Set-up] menu.**
- 2 Use the four-way controller (◀▶) to select [(On)]/ (Off)].**
- 3 Press the  Playback button.**
The camera is ready for playing back images.

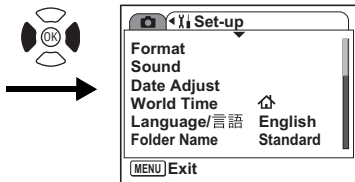

Resetting to Default Settings

You can return all the settings other than the date and time, world time, Language/言語, and video out to the default settings.

- 1 Select [Reset] on the [X Set-up] menu.**
- 2 Press the four-way controller (▶).**
The Reset screen appears.
- 3 Use the four-way controller (▲) to select [Reset].**
- 4 Press the OK button.**

The settings return to the defaults and the camera is ready for taking or playing back images.

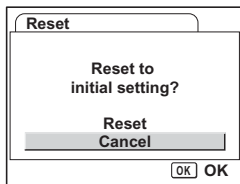

List of City

This is a list of cities which you can select for the World Time.

Region	City	Region	City	
North America	Honolulu	Africa/West Asia	Nairobi	
	Anchorage		Jeddah	
	Vancouver		Tehran	
	San Francisco		Dubai	
	Los Angeles		Karachi	
	Calgary		Kabul	
	Denver		Male	
	Chicago		Delhi	
	Miami		Colombo	
	Toronto		Kathmandu	
	New York		Dacca	
	Halifax	East Asia	Yangon	
Central and South America	Mexico City		Bangkok	
	Lima		Kuala Lumpur	
	Santiago		Vientiane	
	Caracas		Singapore	
	Buenos Aires		Phnom Penh	
	Sao Paulo		Ho chi Minh	
	Rio de Janeiro		Jakarta	
Europe	Lisbon		Hong Kong	
	Madrid		Beijing	
	London		Shanghai	
	Paris	Manila		
	Amsterdam	Taipei		
	Milan	Seoul		
	Rome	Tokyo		
	Berlin	Guam		
	Stockholm	Oceania	Perth	
	Athens		Adelaide	
	Helsinki		Sydney	
Moscow	Noumea			
Africa/West Asia	Dakar		Wellington	
	Algiers		Auckland	
	Johannesburg		Pago Pago	
	Istanbul			
	Cairo			
	Jerusalem			

Default Settings

The table below lists the factory default settings.

Last Memory Setting

- Yes : The current setting (last memory) is saved when the camera is turned off.
- No : The setting returns to the default setting when the camera is turned off.
- * : The setting depends on the Memory setting (p.106).

Reset Setting

- Yes : The setting returns to the default setting with the Reset function (p.173).
- No : The setting is saved even after reset.

● [Rec. Mode] Menu Items

Item	Default Setting	Last Memory Setting	Reset Setting	Page	
Recorded Pixels	10M	Yes	Yes	p.83	
Quality Level	★★ (Better)	Yes	Yes	p.85	
White Balance	AWB (Auto)	*	Yes	p.86	
AF Setting	Focusing Area	[] (Multiple)	Yes	Yes	p.88
	Focus Limiter	On	Yes	Yes	p.89
	Aux. AF Light	On	Yes	Yes	p.90
AE Metering	 (Multi-segment)	*	Yes	p.91	
Sensitivity	AUTO800	*	Yes	p.92	
EV Compensation	±0.0	*	Yes	p.94	
Movie	Recorded Pixels	640 (640×480)	Yes	Yes	p.95
	Quality Level	★★★ (Best)	Yes	Yes	p.96
	Movie anti-shake	On	Yes	Yes	p.97
Shake Reduction	On	Yes	Yes	p.98	
Digital Zoom	On	*	Yes	p.77	
Instant Review	0.5 sec	Yes	Yes	p.99	















Item		Default Setting	Last Memory Setting	Reset Setting	Page
Memory	Flash Mode	On	-	Yes	p.81
	Drive Mode	Off	-	Yes	p.72 to p.75
	Focus Mode	Off	-	Yes	p.78
	Zoom Position	Off	-	Yes	p.76
	MF Position	Off	-	Yes	p.79
	White Balance	Off	-	Yes	p.86
	AE Metering	Off	-	Yes	p.91
	Sensitivity	Off	-	Yes	p.92
	EV Compensation	Off	-	Yes	p.94
	Digital Zoom	On	-	Yes	p.77
	DISPLAY	Off	-	Yes	p.48
File #	On	-	Yes	-	
Green Button		Green Mode	Yes	Yes	p.100
Sharpness		Standard	Yes	Yes	p.103
Saturation		Standard	Yes	Yes	p.104
Contrast		Standard	Yes	Yes	p.105

● [X] Set-up] Menu

Item		Default Setting	Last Memory Setting	Reset Setting	Page
Format		-	-	-	p.158
Sound	Operation Volume	3	Yes	Yes	p.159
	Playback Volume	3	Yes	Yes	
	Start-up Sound	1	Yes	Yes	
	Shutter Sound	1	Yes	Yes	
	Operation Sound	1	Yes	Yes	
	Self-timer Sound	1	Yes	Yes	
Date Adjust	Date Style	According to initial setting	Yes	No	p.162
World Time	Select time	Hometown	Yes	No	p.164
	Destination (City)	Same as Hometown	Yes	No	
	Destination (DST)	Same as Hometown	Yes	No	
	Hometown (City)	According to initial setting	Yes	No	
	Hometown (DST)	According to initial setting	Yes	No	























Item	Default Setting	Last Memory Setting	Reset Setting	Page
Language/言語	According to initial setting	Yes	No	p.26
Folder Name	Standard	Yes	Yes	p.167
USB Connection	PC	Yes	Yes	p.168
Video Out	According to initial setting	Yes	No	p.169
Brightness Level	4	Yes	Yes	p.170
Power Saving	5 sec	Yes	Yes	p.171
Quick Zoom	Off	Yes	Yes	p.114
Auto Power Off	3 min	Yes	Yes	p.172
Guide Display	On	Yes	Yes	p.172
Reset	Cancel	No	Yes	p.173

● Playback Mode Palette Items

Item		Default Setting	Last Memory Setting	Reset Setting	Page
	Slideshow	Interval	3 sec	Yes	p.119
		Screen Effect	Wipe	Yes	
		Sound Effect	On	Yes	
	Resize	According to the taken picture	No	-	p.137
	Cropping	-	No	-	p.139
	Image/Sound Copy	Cancel	No	-	p.154
	Image Rotation	Normal	No	No	p.140
	Color Filter	B&W	No	-	p.141
	Digital Filter	SOFT	No	-	p.143
	Brightness Filter	0	No	-	p.145
	Movie Edit	Save as Still Image	No	-	p.147
	Red-eye Compensation	-	-	-	p.150
	Voice Memo	-	-	-	p.111
	Protect	Select image/sound	Yes	No	p.126
	DPOF	Select image	Yes	No	p.130
	Start-up Screen	According to the taken picture	Yes	Yes	p.156
	Frame Composite	-	Yes	Yes	p.152

● Capture Mode and Functions

Yes: Available No: Not available

		Flash	Manual Focus Infinity, Macro, Pan Focus,	Self-timer	Continuous Shooting	Remote Control	Digital Zoom	LCD Off	
Capture Mode	 Auto Picture	Yes	Yes	Yes	Yes	Yes	Yes	Yes	
	 Program								
	 Shutter Priority								
	 Manual Exposure								
	 Night Scene								
	 Landscape								
	 Flower								
	 Portrait	Yes	Yes	Yes	Yes	Yes	Yes	Yes	No
	 Kids								
	 Surf & Snow	Yes	Yes	Yes	Yes	Yes	Yes	Yes	Yes
	 Blur reduction								
	 Sport								
	 Pet								
	 Text								
 Food									
 Frame Composite (*1)	Yes	Yes	Yes	No	Yes	Yes	Yes	No	
 Movie	No (*2)	Yes	Yes	No	No	No (*3)	Yes		
 Voice Recording	-	-	-	-	-	-	-	Yes	
Others	 Digital Zoom	Yes	Yes	Yes	Yes	Yes	-	No (*4)	
	 Macro Mode	Yes	-	Yes	Yes	Yes	Yes	Yes	
	 Infinity Mode	No (*2)	-	Yes	Yes	Yes	Yes	Yes	
	MF Manual Focus	Yes	-	Yes	Yes	Yes	Yes	No	
	 Continuous Shooting	No (*2)	Yes	-	-	-	Yes	Yes	

*1: If you enter this mode when LCD is set to Off, the LCD monitor returns to normal display.

*2: Flash is fixed to off.

*3: Available only when Movie anti-shake is set to Off.

*4: The digital zoom is canceled when the LCD monitor is set to Off.

For Green Mode setting, see p.52.

● Capture Mode and Default Setting of Each Function

		Flash Mode	Recorded Pixels	White Balance	Focusing Area	Focus Limiter	Aux. AF light	AE Metering	Sensitivity	Sharpness	Saturation	Contrast
	Auto Picture			⑤				⑩		⑬	⑬	⑬
	Program											
	Shutter Priority							*2	*3			
	Manual Exposure	*1						*2	*4			
	Night Scene											
	Movie	①			⑥	⑧	⑧	⑪	⑫			
	Voice Recording											
	Landscape			⑤			⑨	⑩		⑬	⑬	⑬
	Flower			⑤		⑨		⑩		⑬	⑬	⑬
	Portrait			⑤				⑩		⑬	⑬	⑬
	Kids			⑤	⑦			⑩		⑬	⑬	⑬
	Surf & Snow			⑤				⑩		⑬	⑬	⑬
	Blur reduction		③									
	Sport	②		⑤	⑦	⑨		⑩		⑬	⑬	⑬
	Pet	②		⑤	⑦	⑨		⑩		⑬	⑬	⑬
	Text			⑤		⑨		⑩		⑬	⑬	⑬
	Food			⑤		⑨		⑩		⑬	⑬	⑬
	Frame Composite		④									

Blank means no changes of settings.

- ①: Fixed to Flash Off
- ②: Set to Flash Off (changeable)
- ③: Fixed to 5M (2592x1944)
- ④: Fixed to 3M (2048x1536)
- ⑤: Fixed to AWB
- ⑥: Fixed to Spot
- ⑦: Set to the automatic tracking AF (changeable)

- ⑧: Fixed to Off
- ⑨: Set to Off (changeable)
- ⑩: Fixed to Multi-segment
- ⑪: Fixed to center-weighted
- ⑫: Fixed to AUTO
- ⑬: Fixed to Standard

*1: Auto and Auto + Red-eye cannot be selected.

*2: Multi-segment cannot be selected.

*3: Sensitivity is fixed to AUTO800.

*4: AUTO cannot be selected.

For Green Mode setting, see p.52.

Optional Accessories

A number of dedicated accessories are available for this camera.

USB cable I-USB17 (*)

AV cable I-AVC7 (*)

Camera case O-CC42

Strap O-ST8

Strap O-ST20 (*)

Leather Strap O-ST24

Sports Strap O-ST30

Remote control unit E (zoom function)

Remote control unit F

Rechargeable lithium-ion battery D-LI8 (*)

Battery charger kit D-BC8 (*)

Battery charger kit K-BC8

AC adapter kit K-AC8

Battery charger K-BC8 and AC adapter kit K-AC8 include AC plug cord D-CO2 (*). The ending of the AC plug cord name differs depending on the country.

Products marked with an asterisk (*) are the same as those supplied with the camera.

Messages

Messages such as the following may appear on the LCD monitor during camera operation.

Shake Reduction is OFF	The Shake Reduction preview button is pressed when [Shake Reduction] is set to Off on the [ Rec.Mode] menu. Set it to On. (p.98)
Compression error	Compression of the image you captured has failed. Change the quality/size and try again.
No image/sound	There are no images/sounds on the SD Memory Card or in the built-in memory.
Memory card full	The SD Memory Card or the built-in memory is full and no more images can be saved.
Built-in memory full	Insert a new SD Memory Card or delete unwanted images. (p.21, 121) Change the quality/size and try again. (p.137)
Image/sound cannot be created	You can only record up to 10000 files due to the specifications of the camera, even when using a large volume SD Memory Card. Delete unwanted files to continue recording.
Memory card error	Shooting and playback are impossible due to a problem with the SD Memory Card. You may be able to play back the images or sounds on a PC.
Card not formatted	The SD Memory Card you have inserted is unformatted or has been formatted on a PC or other device and is not compatible with this camera. (p.158)
Card locked	The SD Memory Card is write-protected. Only menu operation and mode change are possible.
Data being recorded	This is displayed when you switch to Playback mode while the image is being saved or protect setting or DPOF settings are being saved. The message disappears when saving of an image or setting is completed.
Data being processed	The image is being recorded on the SD Memory Card or in the built-in memory.
	The protect setting or DPOF settings is being changed.
	The movie is being recorded.
	The image is being processed with digital filter.
	The movie is being edited.
	The SD Memory Card or built-in memory is being formatted.
Deleting	The image or sound is being deleted.













Camera cannot play this image and sound	You are trying to play back an image or sound in a format not supported by this camera. You may be able to play it back on another brand of camera or PC.
Battery depleted	The battery is exhausted. Recharge the battery or replace with charged battery. (p.14)
Image folder cannot be created	The largest folder number has been used and the largest file number has been assigned to an image and no more images can be saved. Insert a new SD Memory Card or format the SD Memory Card or built-in memory. (p. 21, 158)
Protected	The image or sound you are trying to delete is protected.
This image/sound cannot be processed	You are trying to resize, crop, protect an image, or you are trying to set an image for DPOF, or you are trying to edit an image with a digital filter or edit a movie while the image or movie cannot be processed with these functions.
No image to be processed	There is no file that can be processed with the Playback Mode Palette.

Messages such as the following may appear on the LCD monitor when using the PictBridge function.

No paper in the printer	There is no paper in the printer.
No ink in the printer	There is no ink in the printer.
Printer error	An error message has been sent from the printer.
Data error	A data error message has been sent from the printer.
Paper stuck in the printer	The paper in the printer has jammed.

Troubleshooting

Problem	Cause	Remedy
Camera will not turn on	Battery is not installed	Check if a battery is installed. If not, install a battery. (p.14)
	Battery is installed incorrectly	Check orientation of the battery and reinsert it. (p.14)
	The battery is exhausted	Charge the battery. (p.15)
	The battery performance has temporarily deteriorated because it is too cold	Warm up the battery by putting it in a pocket where it can come in contact with body heat.
No image on the LCD monitor	LCD monitor is set to Off	Press OK/Display button to turn LCD monitor on.
	Image is displayed but is hard to see	Image on LCD monitor may be hard to see when taking pictures outside in sunlight.
Shutter will not release	Flash is charging	When flash icon blinks red on the LCD monitor, flash is charging and no pictures can be taken. Flash icon lights red when charging is completed.
	No available space on SD Memory Card or in built-in memory	Insert SD Memory Card with available space or delete unwanted images. (p.21, 121)
	Recording	Wait until recording is finished.
	The number of image, movie, and sound files recorded on the SD Memory Card has reached 10000.	Change SD Memory Cards or delete unwanted files.
Picture is dark	Subject is too far away in a dark environment, such as a night scene	Picture becomes dark if subject is too far away. Take picture within range of flash.
	Background is dark	When taking a picture of a person against a dark background, such as a night scene, the background may appear dark if the flash does not reach it, even with the correct exposure. Set to  (Night Scene mode) to ensure both person and background are clear. (p.48, 66)

Problem	Cause	Remedy
Subject is not in focus	Subject difficult to focus on	Subjects difficult to focus on using autofocus: objects with little contrast (blue sky, white walls, etc.), dark objects, finely patterned objects, fast-moving objects, scenery through window or net, etc. Lock focus on another object located at same distance (press shutter release button halfway), then aim at target and press shutter release button fully, or use Manual Focus mode.
	Subject is not in focusing area	Position subject in focus frame [] (focusing area) in middle of LCD monitor. If the subject is outside the focusing area, aim the camera at the subject and lock the focus (press shutter release button halfway), then compose picture and press the shutter release button fully.
	Subject is too close	Set focus mode on  (Macro) or  (Super Macro). (p.78)
	Focus mode is set on  (Macro) or  (Super Macro)	Normal pictures will be out of focus if taken with focus mode set on  (Macro) or  (Super Macro).
Flash does not discharge	Flash mode is set to Off	Set to Auto or  . (p.81)
	The Capture mode is set to  (Movie) mode, Continuous Shooting, Infinity,  (Sport) mode, or  (Pet) mode	Flash will not discharge in these modes. You can cancel the non-flash setting in  (Sport) mode and  (Pet) mode.
The USB Connection with a personal computer does not function properly.	The USB Connection setting of the camera is set to PictBridge.	Set the USB Connection setting to PC. (p.168)
The USB Connection with a printer does not function properly.	The USB Connection setting of the camera is set to PC.	Set the USB Connection setting to PictBridge. (p.168)

Very occasionally, static electricity may cause malfunction of the camera. In this case, remove the battery and install it again. If the camera works properly, the camera is in its normal condition and you can continue to use it.

Main Specifications

Camera

Type	Fully automatic compact digital still camera with built-in zoom lens	
Effective Pixels	10.0 megapixels	
Sensor	10.37 megapixels (total pixels), 1/1.8-inch interline transfer CCD with a primary color filter	
Recorded Pixels	Still Picture	10M (3648×2736), 7M (3072×2304), 5M (2592×1944), 3M (2048×1536), 2M (1600×1200), 1024 (1024×768), 640 (640×480)
	Movie	640 (640×480), 320 (320×240)
Sensitivity	AUTO, Manual (64/100/200/400/800 (/1600 Blur reduction mode): Standard Output Sensitivity)	
File Format	Still Picture	JPEG (Exif2.2), DCF, DPOF, PRINT Image Matching III
	Movie	AVI (MPEG-4 DivX), approx. 30 fps with sound, Movie anti-shake (25 fps image signals recorded at 30 fps)
	Sound	WAV (PCM system), monaural, max. recording time approx. 4 hours 19 min. 59 sec. (when using a 256 MB SD Memory Card)
Quality Level	"Best", "Better", "Good"	
Storage Medium	Built-in memory (approx. 22 MB), SD Memory Card	

Image Storage Capacity and Recording Time (When using a 256 MB SD Memory Card) Still Pictures

Recorded Pixels \ Quality Level	Best ★★★	Better ★★	Good ★	Sound
	10M	74	107	
7M	104	151	210	
5M	147	213	296	
3M	223	323	448	
2M	313	453	628	
1024	571	826	1144	
640	1048	1515	2098	

Movie

Recorded Pixels \ Quality Level	★★★ Best	★★ Better	★ Good
	640 (640×480)	11 min. 35 sec.	14 min. 30 sec.
320 (320×240)	44 min. 47 sec.	55 min. 39 sec.	64 min. 10 sec.

* The above table indicates the approximate number of images and recording time. The number of images and recording time may vary depending on a SD Memory Card and subject.

White Balance	Auto, Daylight, Shade, Tungsten Light, Fluorescent Light, Manual	
Lens	Focal Length	7.9 mm - 23.7 mm (equivalent to 38 mm - 114 mm in 35 mm format)
	Maximum Aperture	f/2.8 - f/5.4
	Lens Composition	7 elements in 5 groups (two dual-sided aspherical elements, one single-sided aspherical element)
	Zoom Type	Electrically driven
	Picture Range	Approx. 65.6 mm × 48.6 mm (screen is filled) (Super Macro mode)
	Lens Cover	Electrically driven
Digital Zoom	Capture Mode	Max 4× (combines with 3× optical zoom to give zoom magnification equivalent to 12×)
LCD Monitor	2.5-inch TFT color LCD with approx. 232 kilopixels monitor (with backlight), Beau-Reflective type, frame coverage approx. 100%	
Playback Functions	Single-frame, 9 frame index, calendar, enlargement (max. 8×, scrollable), movie playback, sound playback, histogram display, Select & Delete Playback Mode Palette (Slideshow, Resize, Cropping, Image/Sound Copy, Image Rotation display, Color Filter, Digital Filter, Brightness Filter, Movie Edit, Red-eye Compensation, Voice Memo, Protect, DPOF, Start-up Screen, Frame Composite)	
Color filter	B&W, Sepia, Color filter (Bar display, Eight colors), B&W + Red, B&W + Green and B&W + Blue.	
Digital filter	Soft, Illustration, Special Effect 1, Special Effect 2, Slim	
Brightness filter	Brightness filter	
Focusing System	Type	TTL contrast detection system by sensor, 5-point multiple/spot selection, auxiliary AF light, Focus Lock (by half-pressing shutter release button), Automatic tracking AF is possible
	Still Picture Focusing Range (from lens front)	Normal: Approx. 0.35 m - ∞ (full zoom range) Macro: Approx. 0.12 m - Approx. 0.4 m (full wide-angle) Super Macro: Approx. 0.06 m - Approx. 0.15 m (full wide-angle) Infinity: ∞ (full zoom range) Pan focus: Approx. 2.3 m - ∞ (full wide-angle), Approx. 9.3 m - ∞ (full telephoto) Manual Focus: Approx. 0.06 m - ∞ (full wide-angle), Approx. 0.35 m - ∞ (full telephoto)
	Movie Focusing Range (from lens front)	Normal: Approx. 0.12 m - ∞ (full wide-angle), Approx. 0.35 m - ∞ (full telephoto) Macro: Approx. 0.12 m - 0.4 m (full wide-angle) Super Macro: Approx. 0.06 m - Approx. 0.15 m (full wide-angle) Infinity: ∞ (full zoom range) Pan focus: Approx. 0.9 m - ∞ (full wide-angle), Approx. 3.7 m - ∞ (full telephoto) Manual Focus: Approx. 0.06 m - ∞ (full wide-angle), Approx. 0.35 m - ∞ (full telephoto)

Exposure Mechanism	AE Metering	TTL metering by sensor (multi-segment, center-weighted, spot)
	Capture Modes	Green, Mode Palette (Auto Picture, Program (Tv, M selectable), Night Scene, Movie, Voice Recording, Landscape, Flower, Portrait (Kids selectable), Sport, Surf & Snow, Blur reduction, Food, Pet, Text, Frame Composite)
	EV Compensation	±2 EV (can be set in 1/3 EV steps)
	Movie	Recording time approx. 1 sec. until memory card is full
Shutter	Type	Electronic/mechanical shutter
	Speed	Approx. 1/2000 sec. - 4 sec.
Flash	Type	Auto flash with red-eye reduction function
	Flash Modes	Auto, Flash Off, Flash On, Auto + Red-eye, Flash On + Red-eye, Soft Flash
	Effective Range	Wide: Approx. 0.06 m - Approx. 7.1 m (at the standard output sensitivity of AUTO) Tele: Approx. 0.35 m - Approx. 3.5 m (at the standard output sensitivity of AUTO)
Drive Modes	Single-frame, Continuous, 10-sec. Self-timer. 2-sec. Self-timer, 3-sec. Remote Control, Instant Remote Control	
Self-timer	Electronic control type, delay time: approx. 10 sec., 2 sec.	
Time Function	World Time setting for 71 cities (28 time zones)	
Power Supply	Rechargeable lithium-ion battery D-LI8, AC adapter (optional)	
Battery Life	Approx. 150 images	(at 23°C with LCD monitor on, flash fired for 50% of shots and using a rechargeable lithium ion battery D-LI8) * The battery life is based on the CIPA standard measurement, but it may vary with the conditions under which the camera is used.
In/Out Port	USB/AV terminal (PC communication type USB 2.0, high-speed-compatible), external power supply terminal	
Video Output Format	NTSC, PAL	
Size	88.5 (W) × 54.5 (H) × 23 (D) mm (excluding operating members and projections)	
Weight	125 g (excluding battery and SD Memory Card)	
Weight When Shooting	145 g (including battery and SD Memory Card)	
Accessories	Rechargeable lithium-ion battery, battery charger, AC plug cord, USB cable, software (CD-ROM), AV cable, strap, operating manual	

Power Supply

	Battery Charger D-BC8	AC Adapter D-AC8 (optional)
Rated input	AC100-240V (50Hz/60Hz)	AC100-240V (50Hz/60Hz)
Rated output	DC 4.2 V / 630 mA	DC 4.5 V/2 A
External dimensions	88 × 46 × 26.5 (mm)	90 × 43.5 × 26.5 (mm)
Weight	61 g	122 g

WARRANTY POLICY

All PENTAX cameras purchased through authorized bona fide photographic distribution channels are guaranteed against defects of material or workmanship for a period of twelve months from date of purchase. Service will be rendered, and defective parts will be replaced without cost to you within that period, provided the equipment does not show evidence of impact, sand or liquid damage, mishandling, tampering, battery or chemical corrosion, operation contrary to operating instructions, or modification by an unauthorized repair shop. The manufacturer or its authorized representatives shall not be liable for any repair or alterations except those made with its written consent and shall not be liable for damages from delay or loss of use or from other indirect or consequential damages of any kind, whether caused by defective material or workmanship or otherwise; and it is expressly agreed that the liability of the manufacturer or its representatives under all guarantees or warranties, whether expressed or implied, is strictly limited to the replacement of parts as hereinbefore provided. No refunds will be made on repairs by non-authorized PENTAX service facilities.

Procedure During 12-month Warranty Period

Any PENTAX which proves defective during the 12-month warranty period should be returned to the dealer from whom you purchased the equipment or to the manufacturer. If there is no representative of the manufacturer in your country, send the equipment to the manufacturer, with postage prepaid. In this case, it will take a considerable length of time before the equipment can be returned to you owing to the complicated customs procedures required. If the equipment is covered by warranty, repairs will be made and parts replaced free of charge, and the equipment will be returned to you upon completion of servicing. If the equipment is not covered by warranty, regular charges of the manufacturer or of its representatives will apply. Shipping charges are to be borne by the owner. If your PENTAX was purchased outside of the country where you wish to have it serviced during the warranty period, regular handling and servicing fees may be charged by the manufacturer's representatives in that country. Notwithstanding this, your PENTAX returned to the manufacturer will be serviced free of charge according to this procedure and warranty policy. In any case, however, shipping charges and customs clearance fees to be borne by the sender. To prove the date of your purchase when required, please keep the receipt or bills covering the purchase of your equipment for at least a year. Before sending your equipment for servicing, please make sure that you are sending it to the manufacturer's authorized representatives or their approved repair shops, unless you are sending it directly to the manufacturer. Always obtain a quotation for the service charge, and only after you accept the quoted service charge, instruct the service station to proceed with the servicing.

- This warranty policy does not affect the customer's statutory rights.
- The local warranty policies available from PENTAX distributors in some countries can supersede this warranty policy. Therefore, we recommend that you review the warranty card supplied with your product at the time of purchase, or contact the PENTAX distributor in your country for more information and to receive a copy of the warranty policy.



The CE Mark is a Directive conformity mark of the European Union.

For customers in USA

STATEMENT OF FCC COMPLIANCE

This device complies with Part 15 of the FCC Rules. Operation is subject to the following two conditions: (1) This device may not cause harmful interference, and (2) this device must accept any interference received, including interference that may cause undesired operation.

Changes or modifications not approved by the party responsible for compliance could void the user's authority to operate the equipment.

This equipment has been tested and found to comply with the limits for a Class B digital device, pursuant to part 15 of the FCC Rules.

These limits are designed to provide reasonable protection against harmful interference in a residential installation. This equipment generates, uses and can radiate frequency energy and, if not installed and used in accordance with the instructions, may cause harmful interference to radio communications. However, there is no guarantee that interference will not occur in a particular installation.

If this equipment does cause harmful interference to radio or television reception, which can be determined by turning the equipment off and on, the user is encouraged to try to correct the interference by one or more of the following measures:

- Reorient or relocate the receiving antenna.
 - Increase the separation between the equipment and receiver.
 - Connect the equipment into an outlet on a circuit different from that to which the receiver is connected.
- * Consult the dealer or an experienced radio/TV technician for help.

For customers in Canada

This Class B digital apparatus meets all requirements of the Canadian Interference - Causing Equipment Regulations.

Pour les utilisateurs au Canada

Cet appareil numérique de la classe B respecte toutes les exigences du Règlement sur le matériel brouilleur du Canada.

Declaration of Conformity
According to 47CFR, Parts 2 and 15 for
Class B Personal Computers and Peripherals

We: PENTAX IMAGING COMPANY
A Division of PENTAX of America, Inc.

Located at: 600 12th Street, Suite 300
Golden, Colorado 80401 U.S.A.
Phone: 303-799-8000 FAX: 303-790-1131

Declare under sole responsibility that the product identified herein, complies with 47CFR Parts 2 and 15 of the FCC rules as a Class B digital device. Each product marketed is identical to the representative unit tested and found to be compliant with the standards. Records maintained continue to reflect the equipment being produced can be expected to be within the variation accepted, due to quantity production and testing on the statistical basis as required by 47CFR §2.909. Operation is subject to the following two conditions: (1) This device may not cause harmful interference, and (2) This device must accept any interference received, including interference that may cause undesired operation. The above named party is responsible for ensuring that the equipment complies with the standards of 47CFR §15.101 to §15.109.

Product Name: PENTAX Digital Still Camera

Model Number: Optio A20

Contact person: Customer Service Manager

Date and Place: September, 2006, Colorado

Information on disposal for users



1. In the European Union

If your product is marked with this symbol, it means that used electrical/electronic products should not be mixed with general household waste. There exists a separate collection system for these products.

Used electric/electronic equipment must be treated separately and in accordance with legislation that requires proper treatment, recovery and recycling of these products. Following the implementation by member states, private households within the EU states may return their used electrical/electronic equipments to designated collection facilities free of charge*. In some countries your local retailer may also take back your old product free of charge if you purchase a similar new one.

* Please contact your local authority for further details.

By disposing of this product correctly you will help ensure that the waste undergoes the necessary treatment, recovery and recycling and thus prevent potential negative effects on the environment and human health which could otherwise arise due to inappropriate waste handling.

2. In other countries outside the EU

If you wish to discard this product, please contact your local authorities and ask for the correct method of disposal.

For Switzerland: Used electrical/electronic equipment can be returned free of charge to the dealer, even when you don't purchase a new product. Further collection facilities are listed on the home page of www.swico.ch or www.sens.ch.

- A**
- AC Adapter 19
 - AC plug cord 15
 - Access lamp 11
 - Auto Picture Mode 54
 - Auto Power Off 172
 - Autofocus mode 78
 - Autofocus Settings 88
 - Auxiliary AF light 90
 - AV cable 128
- B**
- Battery 14
 - Battery Level Indicator 16
 - Battery/card cover 11, 14
 - Best 23
 - Better 23
 - Blur reduction Mode 67
 - Brightness Filter 145
 - Brightness Level 170
- C**
- Calendar Display 117
 - Capture Mode 36
 - Capture Mode Palette 45
 - Color Filters 141
 - Color Saturation 104
 - Continuous Shooting 73
 - Copying image and
 sound files 154
 - Cropping 139
- D**
- Date and Time 162
 - DC input terminal 19
 - Delete All Images 123
 - Delete Images 121
 - Digital Filter 143
 - Display Language 166
 - DPOF 130
- E**
- Exposure 94
- F**
- Face recognition 62
 - Flash 11
 - Flash Mode 81
 - Fn Setting 101
 - Focus frame 30
 - Focus Limiter 89
 - Focus Mode 78
 - Focusing Area 88
 - Folder Name 167
 - Format 158
 - Four-way controller 12, 36, 37
 - Frame Composite 70, 152
- G**
- Good 23
 - Green button 12, 36, 38, 100
 - Green Mode 52
 - Guide Display 172
- H**
- Histogram 49, 50
 - Home Time 164
- I**
- Image Contrast 105
 - Image quality of movies 24, 96
 - Image quality of still
 pictures 23, 85
 - Image Sharpness 103
 - Image Size of movies 24, 95
 - Image Size of still pictures ... 23, 83
 - Infinity mode 78
 - Initial Settings 26
 - Instant Review 31, 99
- K**
- Kids Mode 62

L		
Lens	11	
Light Metering mode	91	
M		
Macro mode	78	
Manual Exposure mode	56	
Manual Focus mode	78	
Memory	106	
MENU button	12, 36, 38	
Menu List	43	
Messages	181	
Microphone	11	
Movie anti-shake	97	
Movie Edit	147	
My Album	34	
N		
Night Scene Mode	66	
Nine-Image Display	117	
NTSC	29, 169	
Number of recordable images	16	
O		
OK button	12, 36, 39	
Operating Time	16	
Optional Accessories	180	
P		
PAL	29, 169	
Pan Focus mode	78	
PC/AV terminal	128	
Pet Mode	64	
PictBridge	133	
Picture Mode	60	
Play back Movies	115	
Play back Sound	110	
Play back Still Pictures	32	
Play back the Previous or Next Image	32	
Playback button	12, 36, 37	
Playback Mode	37	
Playback Mode Palette	47	
Portrait Mode	62	
Power indicator	11	
Power Saving	171	
Power switch	11	
Press down fully	31	
Press halfway	31	
Printer	133	
Program Mode	56	
Protect	126	
Q		
Quick Zoom	114	
R		
Rec. Mode Menu	43	
Recording Sound	108	
Red-eye Compensation	150	
Remote Control	74, 129	
Remote control receiver	11	
Reset	173	
Resize images	137	
Rotate images	140	
S		
SD Memory Card	21, 22	
Self-timer	72	
Self-timer lamp	11	
Sensitivity	92	
Set the Menus	40	
Set-up Menu	44	
Shake Reduction for Still Pictures	51, 98	
Shake Reduction preview button	11, 36	
Shutter Priority Mode	56	
Shutter release button	11, 30	
Shutter Sound	160	
Slideshow	119	
Sound Settings	159	
Speaker	11	
Start-up Screen	156	
Start-up Sound	160	
Strap	13	
Super Macro mode	78	

Symbols	9
T	
Take Movies	68
Take Still Pictures	30
Tele	76
Text	65
Tripod socket	11
TV	128
U	
USB cable	133
USB Connection	168
V	
Video Output Format	169
Voice Memo	111
Voice Recording Mode	39, 108
W	
White Balance	86
Wide	76
World Time	164
Write-protect switch	22
Z	
Zoom	76
Zoom button	12, 36, 37
Zoom Display	113

Memo

Memo