

RCA

RTD258

Home Theater User's Guide

Système de cinéma maison Guide de l'utilisateur

Teatro en Casa Guía del Usuario

A **THOMSON** BRAND



FCC Information

EN

This device complies with Part 15 of the FCC Rules. Operation is subject to the following two : (1) This device may not cause harmful interference, and (2) this device must accept any interference received, including interference that may cause undesired operation.

This equipment has been tested and found to comply with the limits for a Class B digital device, pursuant to Part 15 of the FCC Rules. These limits are designed to provide reasonable protection against harmful interference in a residential installation. This equipment generates, uses and radiates radio frequency energy and, if not installed and used in accordance with the instruction, may cause harmful interference to radio communications. However, there is no guarantee that interference will not occur in a particular installation.

In accordance with FCC requirements, changes or modifications not expressly approved by Thomson multimedia Inc. could void the user's authority to operate this product.

This device generates and uses radio frequency (RF) energy, and if not installed and used properly, this equipment may cause interference to radio and television reception. If this equipment does cause interference to radio or television reception (which you can determine by unplugging the unit), try to correct the interference by one or more of the following measures:

- Re-orient the receiving antenna (that is, the antenna for the radio or television that is "receiving" the interference).
- Move the unit away from the equipment that is receiving interference.
- Plug the unit into a different wall outlet so that the unit and the equipment receiving interference are on different branch circuits.

If these measures do not eliminate the interference, please consult your dealer or an experienced radio/television technician for additional suggestions.

Also, the Federal Communications Commission has prepared a helpful booklet, "How to Identify and Resolve Radio TV Interference Problems." This booklet is available from the U.S. Government Printing Office, Washington, DC 20402. Please specify stock number 004-000-00345-4 when ordering copies.

This product complies with DHHS Rules 21 CFR Subchapter J. Applicable at the date of manufacture.

For Your Safety

The AC power plug is polarized (one blade is wider than the other) and only fits into AC power outlets one way. If the plug won't go into the outlet completely, turn the plug over and try to insert it the other way. If it still won't fit, contact a qualified electrician to change the outlet, or use a different one. Do not attempt to bypass this safety feature.

CAUTION: TO PREVENT ELECTRIC SHOCK, MATCH WIDE BLADE OF PLUG TO WIDE SLOT, FULLY INSERT.

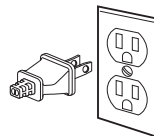

CAUTION – To reduce the risk of fire, use only No. 26 AWG or larger telecommunication line cord.

ATTENTION – Pour réduire les risques d'incendie, utiliser uniquement des conducteurs de télécommunications 26 AWG au de section supérieure.

Note:

This DVD player is designed and manufactured to respond to the Region Management Information. If the Region number of a DVD disc does not correspond to the Region number of this DVD player, this player cannot play the disc. The Region number for this DVD player is Region No. 1.

SERVICE INFORMATION

This product should be serviced only by those specially trained in appropriate servicing techniques. For instructions on how to obtain service, refer to the warranty included in this Guide.

CAUTION

THIS PRODUCT UTILIZES A LASER. USE OF CONTROLS OR ADJUSTMENTS OR PERFORMANCE OF PROCEDURES OTHER THAN THOSE SPECIFIED HEREIN MAY RESULT IN HAZARDOUS RADIATION EXPOSURE. DO NOT OPEN COVERS AND DO NOT REPAIR YOURSELF. REFER SERVICING TO QUALIFIED PERSONNEL.

This Class B digital apparatus complies with Canadian ICES-003.
Cet appareil numérique de la class B est conforme à la norme du NMB-003 du Canada

RFC: CTM-9800723-KS5

	CAUTION RISK OF ELECTRIC SHOCK DO NOT OPEN	
THE LIGHTNING FLASH AND ARROW HEAD WITHIN THE TRIANGLE IS A WARNING SIGN ALERTING YOU OF "DANGEROUS VOLTAGE" INSIDE THE PRODUCT.	CAUTION: TO REDUCE THE RISK OF ELECTRIC SHOCK, DO NOT REMOVE COVER (OR BACK). NO USER-SERVICEABLE PARTS INSIDE. REFER SERVICING TO QUALIFIED SERVICE PERSONNEL.	THE EXCLAMATION POINT WITHIN THE TRIANGLE IS A WARNING SIGN ALERTING YOU OF IMPORTANT INSTRUCTIONS ACCOMPANYING THE PRODUCT.
SEE MARKING ON BOTTOM / BACK OF PRODUCT		

WARNING: TO PREVENT FIRE OR ELECTRICAL SHOCK HAZARD, DO NOT EXPOSE THIS PRODUCT TO RAIN OR MOISTURE.

WARNING

To reduce the risk of fire or electric shock, do not expose this product to rain or moisture. No objects filled with liquids, such as vases, should be placed on the apparatus.

Table of Contents

EN

Connections and Setup

Things to consider before you connect	2
Accessories provided	2
Front panel controls.....	3
Connecting to audiovisual equipment	4
Connecting the speakers	5
Positioning speakers	6
Front speaker placement.....	6
Preferred surround placement	7
Front Surround Mode Speaker Placement	8
Setting up the speakers.....	8
Mounting the Speakers.....	8
Adjusting the angle of the speakers.....	9
Disconnecting the speakers.....	10
Setting up the setup menu.....	11
Test tone/Channel balance	11

The Remote Control

Remote control functions in DVD/CD mode	12
Remote control functions in TUNER mode	13
Using the remote to Navigate through On Screen Menus.....	13
Inserting batteries in the remote control	13

Playing Discs – Basic Functions

Compatible discs	14
Compatible formats	14
Regional coding	14
Operating the DVD receiver	14
Loading discs.....	14
Playing discs	14
Types of Menus	15
Basic Playback Operations	15
Playback	15
Accelerated play	16
Pause	16
Frame advance	16
Variable slow motion	16
Changing chapter/track	16
Zoom	16

The Info Menu

Using the Info menu	17
Title/chapter (DVD)/track (audio CD and VCD)	17
Search Menu.....	18
Audio (DVD,VCD)	18
Subtitles (DVD)	18
Angle (DVD)	18
Play mode	19
Creating a Program list for Play Mode.....	19
Clear a Program list for Program Playback mode..	19
Sleep	20
PBC.....	20
Speaker Level Adjustment.....	20

Mp3/WMA Files and JPEG Files

Playing mp3/WMA Files or displaying JPEG files.....	21
--	----

Radio

Manual Tuning.....	22
Storing radio stations.....	22

USB Device

Connecting/Disconnecting USB devices to the Main Unit.....	23
USB Device Playback Features.....	23

The Setup Menu

Language.....	24
OSD Language.....	24
Subtitles.....	24
Audio.....	24
DVD menu.....	24
Video.....	24
TV Image.....	24
Video.....	25
Black Level.....	25
HDMI Resolution.....	25
Audio.....	26
Test Tone.....	26
Distance.....	26
Night Mode.....	26
Front Surround.....	26
Rating.....	26
Selecting Rating Limit.....	27
Change Password.....	27
Misc.....	27

Additional Information

Troubleshooting.....	28
Precautions.....	29
Disc Formats you can play.....	30
Sound Enhancement Systems.....	31
Limited Warranty.....	32

"HDMI", the HDMI logo and High-Definition Multimedia Interface are trademarks or registered trademarks of HDMI Licensing LLC.

Connections and Setup

EN

Things to consider before you connect

- Ensure that the mains supply in your house complies with that indicated on the identification sticker located on the back of your unit.
- Install your unit horizontally, away from any source of heat (fireplace) or appliances creating strong magnetic or electric fields. The components of this unit are sensitive to heat. The maximum ambient temperature should not exceed 95° Fahrenheit.
- Leave enough space around the unit to allow adequate ventilation: 10 cm on either side and above the top, and 5 cm at the rear.
- The humidity of the room should not exceed 75%. If you have to use the unit outdoors, do not expose it to rain or splashing water. The apparatus should not be exposed to dripping or splashing and no objects filled with liquids, such as vases, should be placed on the apparatus.
- Moving the unit from a cold place to a warm one can cause condensation on some components inside the unit. Let the condensation disappear on its own before turning the unit on again.
- Before moving the player, make sure the disc tray is empty.
- Where the mains plug or an appliance coupler is used as a disconnect device, the disconnect device shall remain readily operable.

Other important use and cleaning information at the end of the booklet.

Accessories provided



Remote control and 2 non-rechargeable AAA batteries

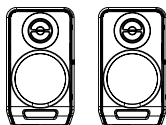

Left and right front speakers

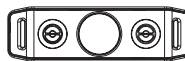

Center speaker

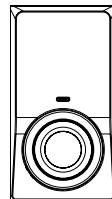

Subwoofer



One Pig-Tail antenna wire



One external AM loop antenna

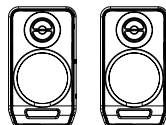

Left and right rear speakers

Caution!

Invisible laser radiation when open. Avoid exposure to beam. Class 1 laser product. This system must be opened only by qualified technicians to prevent accidents caused by the laser beam.

DVD copy protection

In accordance with the DVD standard, your DVD player is equipped with a Copy Protection system, which can be switched on and off by the DVD disc itself, in order to make any recording of the relevant DVD disc onto a videotape of very poor picture quality, or even impossible. This product incorporates copyright protection technology that is protected by method claims of certain U.S. patents and other intellectual property rights owned by Macrovision Corporation and other rights owners. Use of this copyright protection technology must be authorized by Macrovision Corporation, and is intended for home use only unless otherwise authorized by Macrovision Corporation. Reverse engineering or disassembly is prohibited.

Connections and Setup

Front panel controls

EN



ON/STANDBY - Switches the unit on and off.

SUBWOOFER - Toggles between different subwoofer output levels (soft/balance/strong/powerful).

VOLUME - Adjusts the volume.

DISC SKIP - Goes to the next slot in the disc tray.

OPEN/CLOSE DISC 1/2/3/4/5 - Opens and closes the disc tray according to the disc tray number.

SOURCE - Selects the input source.

STOP - Stops disc playback.

PLAY/PAUSE - Starts playing a disc. Pause.

SKIP BWD/FWD - Skips to the previous and the next track or file.

HEADPHONE JACK - Inserts headphone here

MUSIC/PHOTOLINK - Connects USB devices for playing music and photos.

IR - Connects infra-red devices for remote control.

△ / ▽ - Navigate buttons which move through on-screen menus.

SURROUND - Changes the Surround sound setting and DSP mode setting.

DISPLAY - Accesses the INFO menu.

USB light indicator - Indicates USB mode is activated.

DSP light indicator - Indicates DSP mode is activated.

HDMI light indicator - Indicates HDMI mode is activated.

Connecting the Antennas

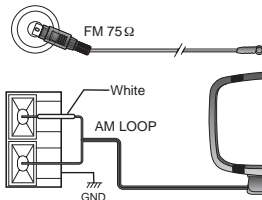

The AM and FM antennas connect to the AM and FM terminals on the system's back panel. They must be hooked up in order to receive clear reception.

AM Loop Antenna and FM Indoor Antenna

1. Uncoil the AM Antenna wire.
 2. Press down on the Antenna tab to open the terminal
- Note: Make sure the white wire on the AM lop antenna is inserted into the left terminal.*

Connections and Setup

EN

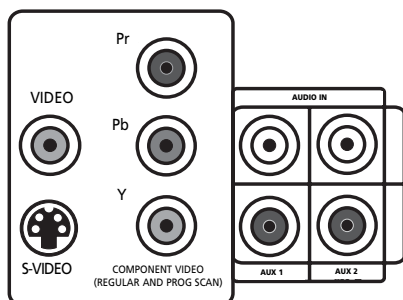

Connecting to audiovisual equipment

Explanation of jacks and cables

The jacks on the back of your receiver (pictured left) and the cables shown below are used to connect to other components.

The video jacks are OUT jacks, which need to be connected to IN jacks on the TV or monitor you're connecting to (so the video content goes from the receiver to the screen). The audio jacks are IN jacks, which need to be connected to OUT jacks on the component you're connecting to, so the sound from the component comes into the receiver (and out through the speakers).

Video cables

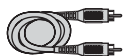

Composite video cable

Composite video cable (included)

The basic Video jack (usually color-coded yellow) is also referred to as composite video.



S-VIDEO cable

S-VIDEO cable (not included)

The S-VIDEO (separate video) jack provides better picture quality than composite video (the VIDEO jack) because the color is kept separate from the brightness and chroma part of the video signal.

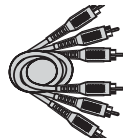

Component video cable

Component video cables (Pr, Pb, Y) (not included)

The Y, Pb, Pr jacks provide optimum picture quality by separating the video signal into three parts. To ensure maximum picture quality, use three video-grade cables for the connection. You can also buy bundled component video cables that are color-coded to match the Y, Pb, Pr inputs (green, blue and red).

Note: If your television is a high definition television, use the DVD player's progressive scan output to get the highest possible video resolution. Set the Progressive Scan option in the Video menu to On

Note: If one of the devices is not working, check that all the cables have been inserted properly into the jacks.

Audio cables (not included)



Audio cables (red and white)

AUDIO IN L (left) and AUDIO IN R (right)

These jacks and cables are often color-coded (red for right audio, and white for left audio).

Note: If your component has only one input for audio (mono), connect it to the left (white L/Mono) audio jack on the TV and don't connect the right audio part of the cable.

HDMI connector and cable (not included)



HDMI (High-Definition Multimedia Interface) provides optimum digital video and audio quality. Use an HDMI cable to connect to a HDMI-supported monitor to allow transfer of the digital images of DVD video and the stereo sound. If your television is a high definition television, use the DVD player's HDMI output to get the highest possible video resolution. Set the HDMI option in the Video menu to switch on. (See page 25 and 26) The HDMI indicator will light up on the front panel.

Connections and Setup

Connecting the speakers

Six speakers are provided with the unit (2 front, 1 center, 2 rear, 1 subwoofer). To achieve good surround effects, all six speakers need to be connected to the receiver.

EN

One speaker wire is provided with each speaker. Speaker wires are color-coded to match the terminals.

Note: When connecting the speakers, make sure the polarities ("+" speaker wire to "+" on the receiver. For example, red wire to red terminal on the receiver) of speaker wires and terminals match. If the cords are reversed, the sound will be distorted. Do not ground the output line, it will damage the speaker.

Note: When connecting subwoofer, connect subwoofer control cable to the unit's rear panel first, then press the power switch on the subwoofer speaker to switch it on.

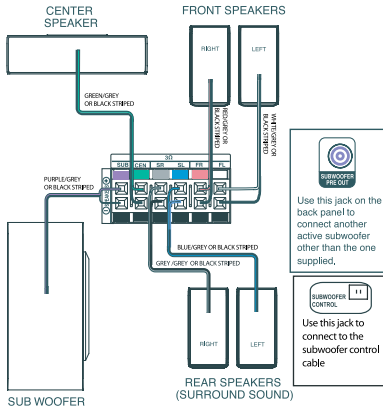

Connections and Setup

EN

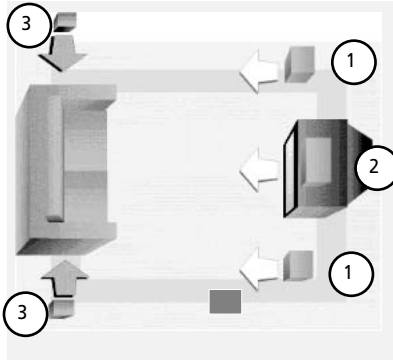

Courtesy Dolby Laboratories

Positioning speakers

① Left, Right (Front Speakers)

Front speakers carry primarily music and sound effects.

② Center

In surround mode, the center speaker carries most of the dialog as well as music and effects. It should be set between the left and right speakers.

③ Surround (Rear Speakers)

The rear speakers' overall sound balance should be as close as possible to the front speakers. Proper placement is vital to establish an evenly distributed sound field.

Subwoofer

A subwoofer is designed to reproduce powerful low bass effects (explosions, the rumble of spaceships, etc.) which dramatically heighten the action on the screen.

Magnetic shielding

Speakers placed less than two feet from the TV set must be magnetically shielded in order to prevent picture distortion. Front, Center and Rear speakers provided with this unit are magnetically shielded to protect your TV set.

*Note: Place the subwoofer a feet or more away from TV when using the Front Surround sound Effect. (FSSE)
(See page 9)*

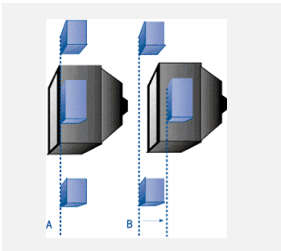

Courtesy Dolby Laboratories

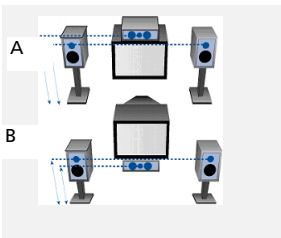

Courtesy Dolby Laboratories

Front speaker placement

Follow the suggestions for speaker placement below to get the best results.

Alignment

Align the center speaker evenly with (A) or slightly behind (B) (the left and right speakers), but not ahead of them.

Angle

Place the left and right speakers to form a 45-degree angle with your favorite viewing position to duplicate the soundtrack mixer's perspective.

Height

The mid- and high-frequency drivers of the three front speakers should be as close as possible to the same height. This often requires placing the center speaker directly on top (A) or beneath (B) the TV set.

Connections and Setup

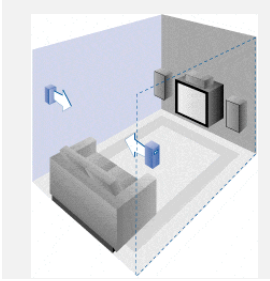

Courtesy Dolby Laboratories

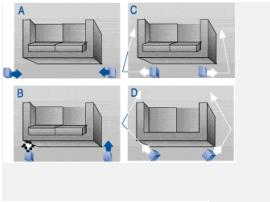

Courtesy Dolby Laboratories

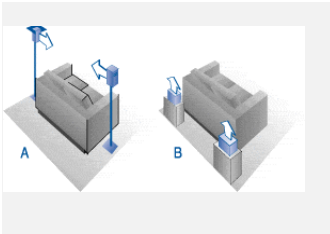

Courtesy Dolby Laboratories

Preferred surround placement

Location

If possible, place surround speakers to either side of the listening area, not behind it.

Height

If space permits, install surround speakers 2-3 feet above viewers. This helps to minimize localization effects.

Aiming

Aim surround speakers straight across the room, not down at viewers, to help create a more open, spacious surround sound field.

Alternative Surround Placement

Rear wall

If rear wall mounting is the only choice, aim the speakers at each other (A), towards the front (B) or towards the sidewalls (C, D). Experiment with placement until sounds seem to surround you, rather than come from behind you.

No adjacent walls

Surround speakers can go on stands facing each other to approximate sidewall mounting (A), or to the sides or rear of the viewing area, aimed upwards; they can go right on the floor, or preferably, a few feet off the floor such as on end tables (B).

EN

Connections and Setup

Front Surround Mode Speaker Placement

EN

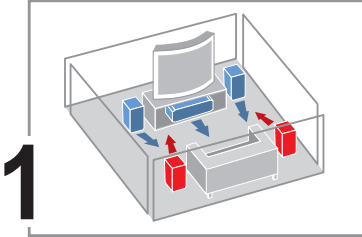

Configuration 1

Configuration 1

Follow the suggestion for speaker placement on page 6 and 7.

Configuration 2

If placing the rear speakers (surround speakers) at the back is not a good choice for you, you can use the Front Surround sound Effect(FSsE). Follow the following instruction for setting the speakers and the setup menu of the Player.

1. Setting the Speakers

Mounting the Speakers

Note: Match the front left and rear left speakers together and match the front right and rear right speakers together.

1. Place the front speaker upside down.
2. Slide in the hinge to the bottom of the front speaker until the 'click' sound is heard.
3. Slide in the rear speaker to the hinge until the 'click' sound is heard.
4. Attach the four rubber feet provided to the top of the front speaker.

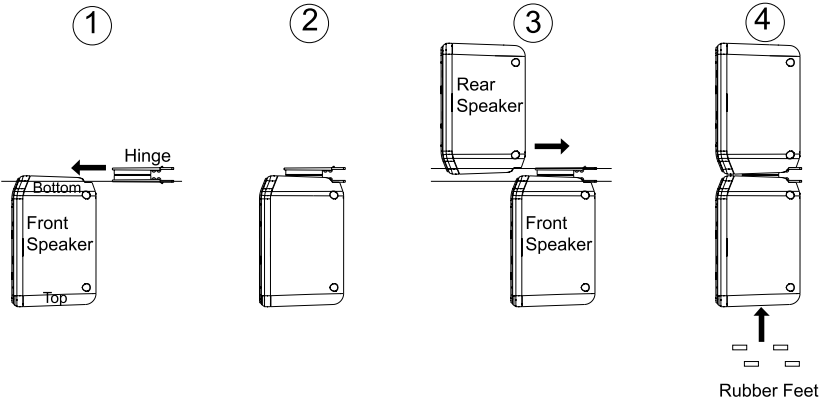

Connections and Setup

Adjusting the Angle of the Speakers

To achieve the best Front Surround sound Effect (FSsE), adjust the mounted front left and the rear left speakers to the left for an angle of 25° - 45° from the center.

Adjust the mounted front right and rear right speakers to the right in the same way.

EN

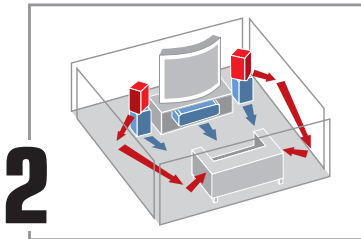
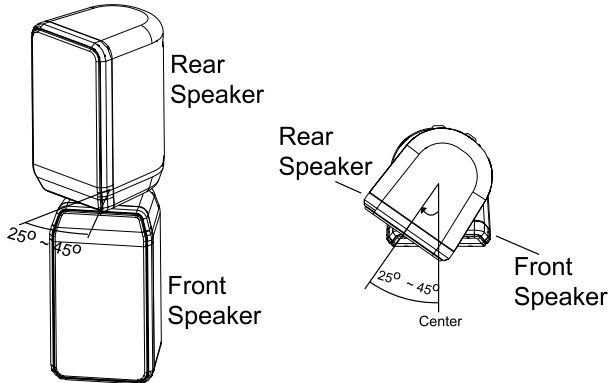

Configuration 2

After adjusting the angle, the speaker should look like the illustration on the left.

Note: Place the rear speakers and subwoofer a feet or more away from TV when using the Front Surround sound Effect. (FSsE).

Connections and Setup

Disconnecting the Speakers

1. To unlock the speakers, press and hold the hinge spring as illustrated below.
2. Slide out the rear speaker from the hinge.
3. Press and hold the two hinge springs.
4. Slide out the hinge from the front speaker.

EN

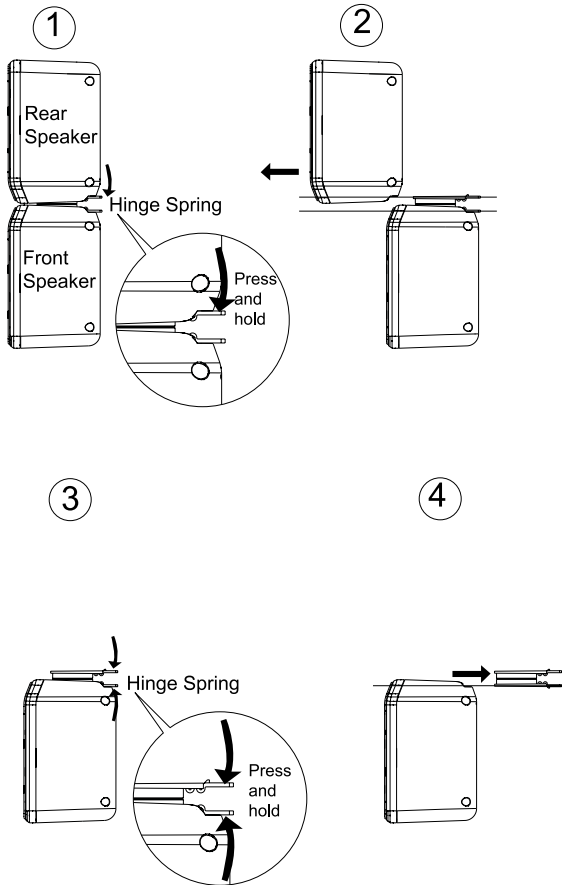

Connections and Setup

2. Setting the Setup Menu

To optimize the front surround sound effect, you can control different levels of surround sound according to your room size. See page 25 section "Front Surround" for setting the setup menu of the Player.

EN

Test tone/Channel balance

Channel balance

Your receiver is equipped with a test signal generator for balancing the channels. As the signal "travels" from channel to channel, adjust the level controls until each channel plays at the same loudness level (see page 25).

Level adjustment and surround channel level expectation

Even though you adjust the surround channel to be as loud as the others on the test signal, on actual program material the surround channel is usually much lower than the front. Don't re-adjust the surround level; program producers use surround for subtle atmospherics and ambience, and only rarely for special effects.

The Remote Control

The remote control

Navigating through menus

Use the direction buttons to navigate through the menus. Press the OK button on the remote control to confirm your selection.

EN

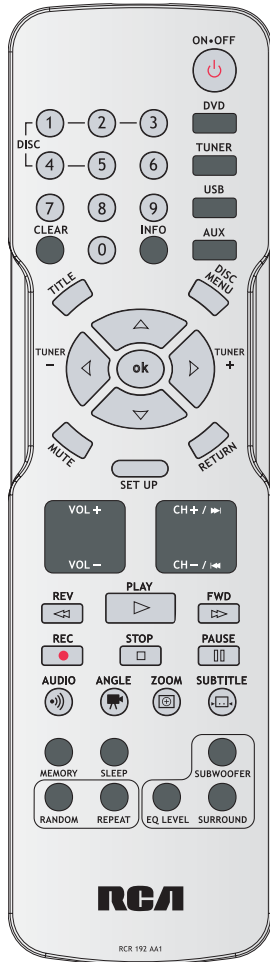

Remote control functions in DVD/CD mode

ON•OFF - Switches the unit on and off.

DVD - Selects the DVD mode.

TUNER - Selects the TUNER and switch between FM/AM.

USB - Selects the USB.

AUX - Selects the AUX1 and AUX2.

0-9 - Number entry. Press 1 through 5 to directly access a disc in the disc tray. You must press STOP before pressing a number to access a disc in the disc tray when in playback mode.

CLEAR - Quit the current setting manual from the TV screen without saving change.

INFO - Accesses the Info menu.

TITLE - Accesses the disc menu.

DISC MENU - Accesses the disc menu during playback. Turn PBC on/off for VCD disc.

OK - Confirm your selection.

MUTE - Mutes and restores the sound.

SETUP - Enter Setup menu.

RETURN - In DVD/CD mode, returns to the previous menu.

VOL +/- - Adjusts the sound volume.

CH +/- - Directly accesses the next or previous chapter (DVD) or track (CD). Selects programmed stations in TUNER mode.

REV - Starts reverse accelerated play or reverse slow motion.

PLAY - Starts playing a disc.

FWD - Starts forward accelerated play or forward slow motion.

STOP - Stops playback.

PAUSE - Freeze frame, frame advance or slow motion.

AUDIO - Accesses the audio function. Switch between FM stereo and mono mode for TUNER mode.

ANGLE - Accesses the camera angle function for DVD disc. Accesses Wipe Down/Wipe Up/Center In/Center Out/Blind Up/Blind Down/Random transition function for JPEG (Slide Show).

ZOOM - Accesses the Zoom function.

SUBTITLE - Selects the subtitle languages or turns subtitle off (if available).

MEMORY - Stores station in tuner mode.

SLEEP - Enters sleep mode and selects sleep time.

SUBWOOFER - Selects among subwoofer output levels (soft/balance/strong/powerful).

RANDOM - Turns on/off random playback on CDDA discs.

REPEAT - Accesses the repeat function.

EQ LEVEL - Selects among EQ/BASS/TREBLE mode. Adjusts BASS/TREBLE using the left/right buttons.

SURROUND - Changes the Surround sound setting and DSP mode setting.

Note: Record function is not available in this model.

The Remote Control

Remote control functions in Tuner mode

TUNER - Selects the TUNER and switch between FM/AM.

VOL+/- - Adjusts the sound volume.

MUTE - Mutes and Resotres the sound.

TUNER +/- - Tunes down and up the radio frequencies.

MEMORY - Stores a station.

CH+/- - Selects programmed stations.

EN

Using the remote to Navigate through On-Screen Menus

No matter what on-screen display you're using (the DVD player's menu, the Info Display that appears during playback, or a disc's menu), you'll use the same buttons on the remote control to navigate through the on-screen display; the four arrow buttons and the OK button.

Use the arrow buttons on the remote to move through on-screen menus in the direction of the arrow button (to move right, press the right arrow button, etc.). The arrow buttons are used to highlight an option. Once highlighted, press the OK button to select the option that is highlighted.

Inserting batteries in the remote control

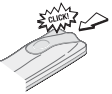

- Do not mix different types of batteries or new and old batteries. Do not use rechargeable batteries.
- In order to avoid any risk of explosion, observe the polarities indicated inside the battery compartment. Replace only with the type of batteries specified. Do not dispose of them in a fire or recharge them.
- If you are not using the remote control for a long period of time, remove the batteries.



Please respect the environment and prevailing regulations. Before you dispose of batteries or accumulators, ask your dealer whether they are subject to special recycling and if they will accept them for disposal.

Playing Discs - Basic Functions

EN

Compatible discs

- DVD
- DVD-R, DVD-RW, DVD+R, DVD+RW
- CD
- CD-R, CD-RW

Compatible formats

- DVD, VCD (Video Compact Disc), SVCD (Super Video Compact Disc), JPEG
- CD, mp3, WMA

See page 30 and 31 for more information about discs and compatible formats.

Regional coding

Your DVD player has been designed to process regional management information stored on DVD discs. The regional code for your player is 1. Discs that have a different regional code will not play.

Operating the DVD receiver

1. Turn on your television set.
2. Press the ON•OFF button on the remote or the ON/STANDBY button located on the DVD player's front panel. Press the DVD•CD button on the remote control.

Loading discs

You can load up to 5 discs into your DVD player, but you do not have to fill all the slots in the disc tray for the player to work. You can load any kind of compatible disc in any combination (DVDs, CDs, VCDs). The player will read the data on the disc and play it accordingly.

1. Press OPEN•CLOSE DISC 1/2/3/4/5 to open the desired disc tray. (For example, press OPEN•CLOSE DISC 1 to open disc tray 1)
2. Insert a compatible disc into the disc slot, making sure it is fully in place.
3. When you're finished loading discs, press OPEN•CLOSE DISC 1/2/3/4/5 to close the disc tray. (For example, to close tray 1, press OPEN•CLOSE DISC 1)
4. Repeat steps 1-3 to load discs in all the disc trays.

Playing discs

Load a disc or discs as shown above and press the OPEN/CLOSE button. The disc tray closes. The DVD Player reads the first disc's table of contents, and then one of three things happens depending on how the disc was programmed:

- The disc starts playing.
- The disc menu appears (for DVDs and VCDs). One of the options will be to start playing the disc. Highlight that option and press OK.

Playing Discs - Basic Functions

Types of Menus

- Disc menu – The appearance and contents of this menu varies according to the type of disc you have inserted. It is separate from the Setup menu.
- Info menu – The player's Info menu appears at the bottom of the screen while the disc is playing. Press the INFO button on the remote to toggle the Info menu on or off.

EN

DVD Video		00:00:16	00:00:23
Title	5/5	Chapter	-/-
Audio	1/1 ∞ 2 Ch		
Subtitle	Off		
Angle	1/1	Bitrate	6.400Mbps

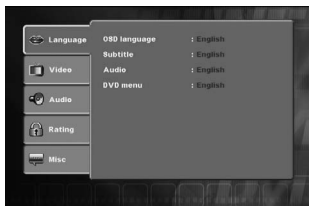

- Setup menu – Press the SETUP button to access this menu.

Basic Playback Operations

Playback

Switch the DVD player and the TV set on.

1. Press the OPEN•CLOSE DISC 1/2/3/4/5 button on the front of the player to open the desired disc tray.
2. Put the disc in with the printed side up (in the case of a single-sided disc).
3. Press again to close the disc tray. Play starts automatically, or the disc menu appears. If the disc menu appears, select the Play option to begin playback.
4. To skip to the next disc, press DISC SKIP on the front panel. To directly access a disc by number, press STOP first and press the corresponding number on the remote (for example, to go to disc 3, press 3 on the remote).
5. Press STOP to stop playback.

Note: If PBC is switched off during VCD disc playback or DVD disc playback, the player stores the point where playback was interrupted when you press STOP. If you press PLAY again, playback resumes from this point. To stop playback completely or to start again from the beginning, press STOP twice. If the player is left in STOP mode for more than five minutes without any user interaction, a screen saver is activated. At the end of 30 minutes without any user interaction, the player switches off automatically.

Playing Discs - Basic Functions

Accelerated play

While the disc is playing, press the REVERSE or FORWARD button one or more times to vary the speed and direction of the accelerated play. Press PLAY to resume normal playback.

Note: REV or FWD function is not available for WMA disc.

EN

Pause

While the disc is playing, press PAUSE once for freeze frame. Press PLAY/PAUSE to resume normal playback.

Frame advance

1. Press PAUSE twice. STEP is displayed.
2. Press PAUSE to move forward one frame at a time.
3. Press PLAY to resume normal playback.

Variable slow motion

1. While the disc is playing, press the PAUSE button once. PAUSE is displayed.
2. Press REV or FWD a number of times to vary the speed.
3. Press PLAY to resume normal playback.

Changing chapter/track

While the disc is playing, press the CH+/- button to go immediately to the next or previous chapter, or to the next or previous track.

Zoom

1. While a disc is playing, press the ZOOM button until you reach the zoom size you want. The ZOOM button toggles through 1x, 2x and 3x, then returns to normal playback.
2. Move from one area to another (pan) using the arrow buttons.

The Info Menu

Using the Info menu

Press the INFO button on the remote while a disc is playing to display the Info menu. To show title, audio, subtitle, angle, bitrate and time display information.

EN

DVD Info Display

DVD Video		00:00:16	00:00:23
Title	5/5	Chapter	-/-
Audio	1/1  2 Ch		
Subtitle	Off		
Angle	1/1	Bitrate	6.400Mbps

DVD Video		00:15:55	01:12:16
Title	1/5	Chapter	4/17
Audio	1/2  6 Ch Eng		
Subtitle	1/2 Eng		
Angle	1/1	Bitrate	6.912Mbps

VCD Info Display

VCD2.0		00:00:14	00:00:58
PBC On			

Chapter (DVD)/track (audio CD and VCD)

To directly access a chapter (DVD) or a track (audio CD and VCD), press the CH+/- buttons, or press the numeric buttons then press OK.

Note: Many discs only have one title.

Title (DVD)

To access title, press the TITLE button. Press the CH+/- buttons to skip to the next or the previous title.

The Info Menu

EN



Search Menu

To access the Search Menu, press the numeric buttons on the remote.

To directly access a location on the disc which does not correspond to the start of a Title or Chapter in DVD or a Track in CD, press the numeric buttons to activate the search menu. Press the numeric buttons to enter the desired track,

time and disc time and press OK.

Note: This function may not be available on all discs.

DVD:

- To access chapter elapsed time and chapter total time, press the INFO button while playing a chapter.

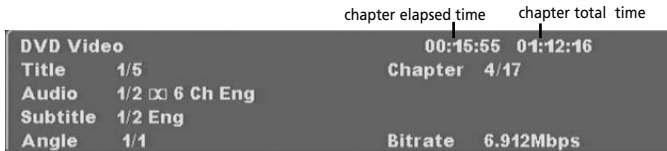

VCD:

- To access disc elapsed time and disc total time, press the INFO button while playing a VCD disc.

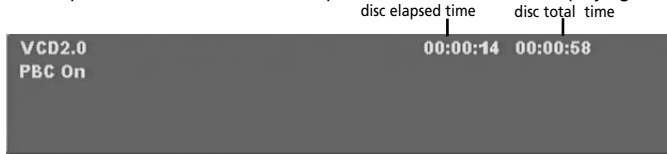

Audio (DVD, VCD)

Some discs have several audio tracks used for different languages or different audio formats. To change the language or audio format during playback:

1. Press the AUDIO button on the remote control repeatedly to choose a desired language.

Notes:

This option is only available if the disc offers dialog languages or audio formats.

When you change the dialog language using the Info menu, it only changes the dialog language of the disc being played. When you eject the disc or switch off the player, the language will revert to the one you selected in the Language Setup menu (see page 24).

Subtitles (DVD)

Subtitles are turned off by default. Turn on Subtitles by pressing the SUBTITLE button on the remote.

1. Press repeatedly to select a desired language.
2. To turn subtitles off, select the Off option.

Notes:

When you change the language of the subtitles using the Info menu, it only applies to the disc currently being played. When you eject the disc and switch off the player, the subtitles will default to the subtitle language you selected in the Languages menu (see page 24).

This function may not be available on all discs.

Angle (DVD)

Some discs offer different camera angles for specific scenes.

1. To change the camera angle, press the ANGLE button on the remote repeatedly to select the camera angle.

Note: If the disc was recorded using a single camera angle, this function is not available.

Play mode

1. While the disc is playing, press the repeat button repeatedly.
2. • DVD play modes: repeat chapter, repeat title, repeat A-B and repeat off (normal).
 - Notes:
 - Repeat mode is only available with discs that display elapsed time and remaining time.
 - To repeat a sequence between points A and B, choose the A-B repeat option, and then follow the instructions for entering the two points. If, during a fast forward or reverse, point B is reached, the player continues playback at normal speed from point A. If, during a fast search, point A is reached, the player starts playback from point A at normal speed.
- VCD and SVCD play modes: standard, repeat single(track), repeat all and repeat A-B while PBC is off.
- Audio CD play modes: Normal (standard), program, random (one disc), repeat single (track), repeat all and repeat A-B.
3. Press the RANDOM button to select random (one disc). Rnadam function is not available for DVD/VCD disc.
4. To stop repeat playback, press repeat to select the Off option.

Creating a Program List for Program Play Mode (Audio CDs and mp3 CDs)

To use program play mode, you must first create a program list.

1. To create a program list, use the navigation arrow button to highlight the Edit Mode option on the right and press OK.
2. Select the tracks you want to add to the Program List and press OK.
3. Select Add to Program option and press OK.
4. Select Program View and press PLAY to start playback.



Clear a Program List for Program Play Mode (Audio and mp3 CDs)

1. To clear a program list, select Edit Mode option and press OK.
2. Press STOP button first and use the navigation arrow button to select tracks you want to delete from the program list and press OK.
3. Select Clear Program option and press OK.
4. Select Edit Mode option and press OK to quit Edit Mode.
5. Select Browser view option to quit program.

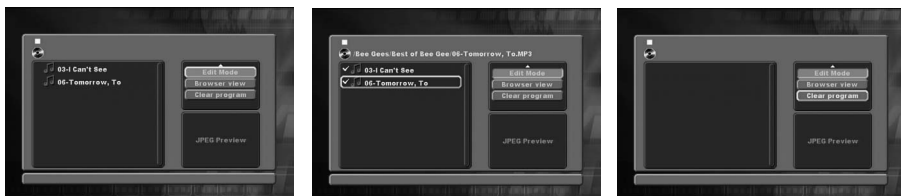

The Info Menu

Sleep

Press the SLEEP button on the remote control to select among Off, 30 mins, 60 mins, 90 mins and 120 mins.

EN

PBC (Playback Control – VCD)

When playing a VCD, PBC gives you access to scenes and information that can be selected through a menu. PBC also lets you display high-resolution pictures, if the disc contains any. Press the DISC MENU button on the remote to switch on/off PBC.

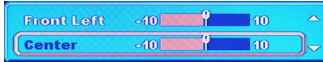

Speaker Level Adjustment

You can adjust the speaker level during playback by pressing VOL+/- . Press up/down arrow buttons to select among Front Left, Center, Front Right, Right Surr., Left Surr. and Subwoofer speaker. Then press left/right arrow buttons to adjust the volume.

Mp3/WMA Files and JPEG Files

Playing mp3/WMA Files or displaying JPEG Files

Mp3/WMA is an audio file format which compresses recorded music. The main advantage of the Mp3/WMA format is that CD-quality music tracks can be stored on a personal computer in user friendly compressed files.

JPEG files are image files. Make sure that they have a resolution of less than 2 megapixels.

Note: The time taken for the contents of the disc to be displayed varies according to the size and number of JPEG files on the disc. If nothing is displayed after a few minutes, the file sizes may be too large. Reduce the files' resolution and write another disc. Before inserting a disc, make sure it is compatible with the player.

1. Open the disc tray.
2. Place the disc with the printed side facing up and close the disc tray.
The folders on the disc will be listed in numerical order on the left side of the screen. When you highlight a folder and press OK, the list of songs or pictures in the folder are listed in numerical order on the screen.
3. Select a folder using the up/down arrow buttons on the remote.

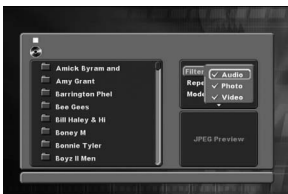

4. Use the navigation arrow button to select Filter and press OK. Select Audio/Photo/Video mode to select music, picture or video mode respectively and press OK. Press left arrow to return to the previous menu.

5. Use the up/down arrow buttons to select a file. Press OK or PLAY to start playback.
Note: If there are mp3/JPEG/Video (MPEG) files in current disc, all files will be displayed after you select Audio/Photo/Video. But if you do not select Photo (mp3/Video), empty folder is displayed for JPEG (mp3/Video) files.

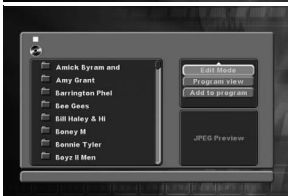

- **Mp3/WMA file:** the player begins playing the selected file, then all the files and subfolders contained in the same folder. The player then plays the contents of the folders at the same level as the folder containing the file selected at the start.

Note: While listening, you can use the CH- button on the remote control or BWD SKIP on the front panel to go back to the previous track or the CH+ button on the remote control or FWD SKIP on the front panel to go on to the next one. To play all the tracks in a specific folder, use the navigation arrow buttons to select the folder and press OK. Then press PLAY to start playback.

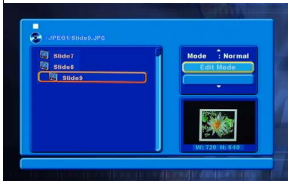

- **JPEG file:** the player starts the slide show with the JPEG file you have selected, then displays all the JPEG files in the same folder, then all the JPEG files in the subfolders located in the same folder.

Note: During the slide show you can use the ZOOM button to magnify the picture, move from one area to another (pan) using the arrow buttons. Press the left/right/up/down arrow buttons to rotate the picture. Press CH+- on the remote control or the BWD/FWD SKIP buttons on the front panel to go to previous or next track. Press the ANGLE button on the remote control to select Wipe/Down/Wipe/Up/Center In/Center Out/Blind Up/Blind Down/Random Transition mode. Press

the STOP button to interrupt the slide show and display the disc's contents.

• Repeat:

- Press the navigation arrow buttons to select the Repeat option.
- Press OK to select a play mode (All: repeat one folder, Single: repeat track, Off: normal playback) or press the Repeat button on the remote.

6. Mp3 tag is displayed at the bottom of the screen.
7. When the player has played all the files, the music or slide show stops and the disc's contents are displayed again.
8. Press STOP to end playback.

Note: Mp3/WMA/JPEG files cannot playback simultaneously.

EN

Radio

The player has a built-in tuner that allows for FM radio function. The AM loop antenna allows for AM radio function.

EN

Manual Tuning

1. Connect the FM aerial and the AM loop antenna at the back of the unit. Rotate the AM loop for better reception.
2. Press TUNER.
3. When the FM station broadcasts Stereo sound, **ST** is displayed. Press the AUDIO button to toggle between stereo and mono in FM mode.
4. Tune a station by pressing and holding the TUNER +/- arrow buttons for two seconds to activate the automatic search function. In this mode the player will automatically tune frequencies until it finds a station.
5. Repeat step 4 to tune to another radio station.
6. Press the TUNER button to toggle between FM and AM.

Note: If there is any interference, change the aerial's position until ideal sound reception is obtained. TV and other electronic devices could be the cause of interference, so try to position the aerial away from them.

Storing radio stations

The player can store up to 40 radio stations (FM and AM each 20 preset stations) in its memory. You can enter every single radio station yourself or the player can store all available radio stations automatically in ascending order.

Automatic preset programming

1. Press TUNER to enter the Tuner mode.
2. Press and hold the MEMORY button for 3 seconds to start automatic preset programming.
Note: A weak signal can affect the "Automatic preset programming" function's efficiency. Adjust the aerial for better reception and a more efficient search.
3. Radio frequencies will be browsed and radio stations stored automatically. When all the available radio stations are stored or all 40 (FM and AM each 20 preset stations) memory locations are full, the auto preset programming function will stop.

Manual preset

1. Tune to a radio station (see "Manual tuning" for details).
2. Press MEMORY. **PRESET** will appear on the display.
3. While the icon **PRESET** is still flashing, input your desired preset number using the numeric buttons or press the CH +/- buttons, then press MEMORY to store it.

Retrieving preset stations

1. Press TUNER to enter the Tuner mode.
2. Press CH +/- to search up or down for the preset stations or directly press the numeric buttons.

USB Device

This player allows you to connect your own USB storage devices such as mp3 players and USB flash memory. Connect the USB device first then you can start playback.

Connecting/Disconnecting USB device to the Main Unit

Insert the USB port of the USB device you want to connect into the USB socket of the player. The USB light indicator on the front panel lights. Unplug the device to disconnect.

EN

USB Device Playback Features

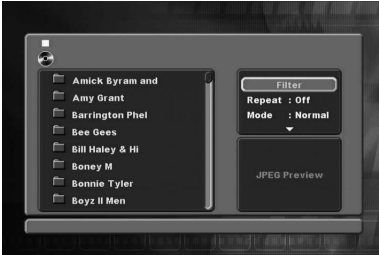

1. Press USB to select USB mode.
2. Press PLAY to start playback or press PAUSE to pause playback.
3. Press STOP to end playback.
4. Press CH+/- buttons on the remote control or BWD/FWD SKIP buttons on the front panel to skip to the previous or next file.
5. You may also follow the playback instruction steps 3-7 on playing mp3/WMA files and JPEG files on P.21.

Note: The player does not support DVD audio/Video on USB device.

The Setup Menu

There are five options in the main setup menu: Language, Video, Audio, Rating and Misc.

Press the SETUP button to bring up the main menu. Press the up/down button to select menu and press the right arrow button to move to the option's choices on the right..

EN

Language

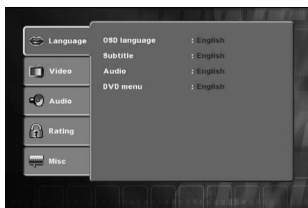

With this menu, you can set the language for OSD, dialog, subtitles audio and DVD menu.

If you chose "English" during initial set-up, any menus generated by the disc are in English, and so is the language of the dialogs (if this language is available on the disc).

1. Select the Language Setup icon in the main menu using the up/down arrow buttons and press right arrow button and press OK.
2. Select one of the options using the up/down arrow buttons.
3. Use the up/down arrow buttons to highlight the language of your choice and press OK.

OSD Language

Select the language of player menus and press OK.

Subtitles

Select the subtitle language using up/down arrow buttons and press OK.

To change the language of the subtitles during playback, press the SUBTITLE button to select a subtitle language. Select the Off option to turn off subtitles.

Note: If the language chosen is available, it is automatically selected when you display the subtitles. Otherwise, the subtitle language indicated on the disc is selected.

Audio

Select the dialog language using up/down arrow buttons and press OK.

To change the language during playback, press the AUDIO button on the remote.

Note: If the selected language is not available on a disc, the disc's language will be used instead.

DVD Menu

To change the language of the DVD menus, select the language using the up/down arrow buttons and press OK.

Note: the language you select will only be displayed if the disc is programmed with that language.

Video



1. Select Video in the main menu using the navigation arrow buttons
2. Select a menu option using the up/down arrow buttons and press OK.

TV Image

Depending on the format of the DVD disc, you can choose the picture format (aspect ratio) best suited to the format of your TV screen:

4x3 Letter Box: gives best reproduction of pictures recorded in this format (i.e. with horizontal bands at the top and bottom of the screen) or in 16x9.

4x3 Standard: reproduces a 4x3 picture without distortion.

16x9 Widescreen: reproduces 16x9 format films in full on a 16x9 screen.

The Setup Menu

Video

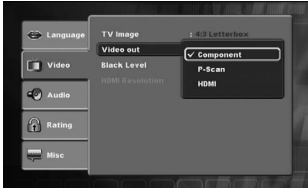

This option lets you select the video output of your appliance

- **Component:** if your TV is connected to the component video socket of the player.
- **P-scan:** if your TV is connected to the components socket of the player.

EN

Note:

- Consult your TV User's Manual to find out if your TV supports Progressive Scan. If Progressive Scan is supported, follow the TV User's Manual regarding Progressive Scan settings in the TV's menu system.
- If Video Output is set incorrectly, the screen may be distorted or you will have a blue screen.

- **HDMI:** if your TV is connected to the HDMI socket of the player.

Note:

- If HDMI Video Output is selected in Setup Menu, C-video (Composite) and S-Video Outputs do not work.
- The HDMI output of this unit can be connected to a DVI jack on a TV or other device using a conversion adapter. In this case, it is necessary to use a TV or display with an HDCP-compatible DVI input.
- There may be no image output if the DVD player is connected to a TV or display that is not compatible with the above format.
- Refer to the TV's instruction manual for detailed information regarding the HDMI/DVI terminal.

Black level

This option lets you adjust the video brightness level on a scale of 1 to 16, with 16 being the brightest.

HDMI Resolution

When HDMI mode is activated, HDMI resolution items will be highlighted. You can select among HDMI AUTO, 480P, 576P, 720P and 1080i.

Note:

- The resolutions available for HDMI output depend on the connected TV or projector. For details, see the user's manual of your TV or projector.
- When the resolution is changed during playback, it may take a few seconds for a normal image to appear.
- If you set the HDMI output resolution 720p or 1080i, HDMI output provides better picture quality.
- If 720P or 1080i is selected, C-VIDEO, S-VIDEO and component video will not output video signal. Press and hold the SUBWOOFER button on the front panel to reset the HDMI Resolution setting.

The Setup Menu

EN

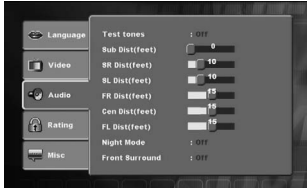

Audio

You can adapt your player to other equipment and access specific functions with the Audio menu.

1. Select Audio in the main menu using the left/right arrow buttons.
2. Select an option using the up/down arrow buttons and press OK.

Test Tone

This function is used to test the speaker setting. A short noise comes from the respective speaker.



Distance

Basic settings have been preset for the speakers included with your unit. However, to suit the acoustic conditions in your listening room and to make the sound more effective, you may need to delay the signal coming from some of the speakers. Channel delay compensates for center or surround speakers that are closer to the listening position than the front speakers.

1. Highlight a distance option using the up/down arrow buttons.

- Subwoofer (Sub Dist.)
- Rear (SR Dist.)
- Rear (SL Dist.)
- Front (FR Dist.)
- Center (Cen Dist.)
- Front (FL Dist.)

2. Press the left/right arrow buttons to adjust the distance.

Note: The receiver speaker distance default settings are as follows:

Subwoofer (Sub Dist.): 0ft; Rear (SR Dist.): 10ft; Rear (SL Dist.): 10ft; Front (FR Dist.): 15ft; Center (Cen Dist.): 15 ft; Front (FL Dist.): 15ft.

Night Mode

You can use this function to control the different sound levels via dynamic compression. It improves the quality of the sound track at a low volume, and quiets the loudest sounds. You can choose between Quiet, Moderate or Off.

Note: This function is available only on DVD discs recorded in Dolby Digital.

Front Surround Sound Effect (FSSE)

You can use this function if placing the rear speakers (surround speakers) at the back is not a good choice for you. See page 8-10 for speaker configuration.

You can use this function to control different levels of surround sound. You can select among

SMALL, MID, LARGE and OFF according to your room size:

SMALL: room size below 12ft x 12ft (3.6m x 3.6m)

MID: room size between 12ft x 12ft - 16ft x 16ft (5m x 5m)

LARGE: room size over 16ft x 16ft



Rating

The disc publisher is responsible for coding scenes according to the rating limits. Below is an explanation of Ratings.

You can control access to the player and the type of discs your family can watch with the lock function. Locking the player prevents playback of DVDs that may not be suitable for all audiences by using the rating level encoded on the disc (not all discs are rated). If the rating level of the disc is higher than the preset level, playback is prohibited unless a password is entered.

The Setup Menu

EN

Rating Explanations

- 1 KID SAF – Kid safe; viewing safe even for kids.
- 2 G – General Audience; recommended as acceptable for viewers of all ages.
- 3 PG – Parental Guidance suggested.
- 4 PG13 – Material is unsuitable for children under age 13.
- 5 PGR – Parental Guidance-restricted; recommended that parents restrict children under age 17 from viewing or allow children to view only when supervised by a parent or adult guardian.
- 6 R – Restricted, under 17 requires accompanying parent or adult guardian.
- 7 NC17 – NO children under age 17; viewing not recommended for children under age 17.
- 8 ADULT – Mature material; should be viewed only by adults, due to graphic sexual material, violence, or language.



Select Rating Limit

- To select the rating limit, you have to unlock the player first.
1. Press the navigation arrow buttons to select Parental Control and press OK.
 2. Enter the super password 9688 and press OK.
 3. 'Correct Password' is displayed.
 4. Press the right arrow button to enter rating limit sub-menu.
 5. To change the rating limit, highlight the RATING option and press the right arrow button. Select the rating limit using the up/down arrow buttons and press OK.
 6. Rating limits take affect only when the player is locked.



Change Password

1. Select the Set Password option and press OK.
2. Enter your current password or super password 9688 and press OK.
3. 'Correct Password' is displayed. Press OK. "Enter New Password" is displayed.
4. Enter your new password and press OK. Password is changed.



Misc

With this menu, you can restore the default settings.

Note: This option allows you to restore the player's setting to the original factory settings. Any changes you have made to the player's settings will be reverted back to the original settings, except the password.

1. Select the Misc option in the main menu using the up/down arrow buttons and press the right arrow button to highlight 'Use Default Settings'.
2. Press OK and press the left/right arrow buttons to select Yes and press OK.
3. Default settings are restored.



Additional Information

Troubleshooting

The unit does not switch on.

- Make sure it is plugged in.
- Press the ON/OFF button on the remote control or the ON/STANDBY button on the front of the unit.

EN

The device switches off spontaneously.

- The device switches off automatically when it is in STOP mode for more than 30 minutes without any user intervention. Switch it on again.
- It might be impossible to read the disc.
- Insert the disc with the printed side facing up.
- Check that the disc can actually be played by this device (see page 26).
- Check that the disc's regional code matches the player's regional code. This player's regional code is 1.
- Clean the disc.

There is no picture.

- Check you have switched on the TV set.
- Check the connections (see pages 4, 24 and 26 and Quick Start Guide).
- Select the AV input assigned to the player on the TV.

The picture is of poor quality (with snow or lines).

- Check the connections (see pages 4, 24 and 26 and Quick Start Guide).

There is no sound or the sound is of poor quality.

- Check the connections (see pages 5).
- Make sure the speakers are connected.
- Make sure the MUTE function is not on.

No surround sound.

- Check the speaker configuration in the Setup menu (see Audio on page 25).

I can't find my file in the WMA/MP3/JPG listing.

- Make sure the filename is valid (see page 30 and 31).

The remote control does not work or works only intermittently.

- Check that batteries are inserted or change them.
- Aim the remote control at the unit. The infrared beam must not be blocked or interrupted.
- Check that the remote control is configured to control the device you are trying to operate with it. Press the DVD•CD button if you want to operate a DVD player.

The subtitles do not appear.

- Check that the DVD disc provides subtitles.
- Refer to the section on how to display subtitles (see page 18 and 24).

The disc menu language is not the correct one.

- The disc menu language has not been set up (see page 24).
- The language of your choice is not available on the disc (see page 24).

You have forgotten your password (Parental control).

- Use the super password: 9688.

Additional Information

EN

Precautions

Use

- If your unit has been stored in a cool place for any length of time, during a journey for example, wait for about 2 hours before using it.
- The openings located on the top and bottom are for ventilation and must not be obstructed.
- During thunderstorms, we recommend that you isolate the unit from the electrical supply so that it is not damaged by electrical or electromagnetic surges.
- This unit is designed for continuous use. Switching off the DVD player to standby mode does not disconnect it from the mains supply. To completely isolate the equipment, remove the plug from the mains jack as some components remain connected to the electrical supply.
- If you notice any burning or smoke, disconnect the unit immediately to avoid any risk of electrocution.
- Do not attempt to look inside the unit through the disk tray opening or any other opening. You may be electrocuted or exposed to laser radiation.
- This unit is for domestic use only and must not be used for industrial purposes.
- Total or partial copying of recordings protected by copyright legislation, without the explicit permission of the holder of the rights, contravenes current legislation. Copying or downloading music files for sale or any other business purpose constitutes or could constitute a violation of copyright law.

Cleaning

- Use a soft, dry, clean cloth. Regularly dust the vents at the back or sides.
- Using solvents, abrasive or alcohol-based products risks damaging the unit.
- If an object or liquid enters inside the unit, unplug it immediately and have it checked by an authorized servicer or service center.

Handling and caring for discs

- Handle your discs with care. Hold the disc with your fingers at the edges or through the hole.
- Insert the disc with the label facing up (for a single-sided disc).
- Place the disc properly into the tray in the allotted holder.
- Use a soft cloth to clean discs if necessary, always wiping from the centre to the edge.
- Always put discs back in their cases after use and store in a vertical position.
- Do not close the tray with two discs in it or with a disc not sitting correctly in the holder.
- Do not play cracked, chipped or warped discs nor try to repair them with adhesive tape or glue.
- Do not write on a disc.
- Do not move the player when a disc is being played.
- Do not scratch discs or store them in places exposed to direct sunlight, high humidity or high temperatures.
- Do not use aerosol cleaners, benzene, anti-static liquids or any other solvent for cleaning discs. When cleaning, wipe gently with a soft damp (water only) cloth from the centre to the edge, avoiding circular motions, which could cause scratches and interference during playback.

Additional Information

EN

Disc Formats you can play

In order to ensure playback, discs must conform with DVD, CD, VCD or SVCD standards. This unit may not play some recordings or files due to differences in recording formats, software used & Disc types.



DVD-Video

Digital video discs - 12 cm, single or double sided, single or dual layer. DVDs are highdensity optical discs on which high quality picture and audio are recorded by means of digital signals.



DVD-R, DVD-RW, DVD+R, DVD+RW



Most DVD-R and DVD+R (one recording only), DVD-RW and DVD+RW discs (rewritable), depending on the DVD writer and discs used. Recordings using DVD-R and DVD-RW discs must be made in Video DVD mode. Recordings using DVD+RW discs must be made in accordance with the specifications for DVD+RW discs with a 4.7 GB capacity.



VCD - Video Compact Disc

CD on which you can record up to 74 min. of VHS quality video associated with still images, audio tracks and interactive menus.



SVCD - Super Video Compact Disc

Most SVCDs comply with the IEC62107 standard. SVCDs can be used to record up to 70 minutes of digital sound and images in accordance with MPEG-2 standards for video and MPEG-1 standards for audio.



Audio CDs

Audio CDs (12 cm). Only Tray 5 can play 8cm disc.



CD-R, CD-RW

Most CD-R (one recording only) and CD-RW discs (rewritable).

CD-Rs written during a multisession recording can be played, provided that the session has ended before the disc is played (depending on the write software). However, depending on the condition of the CD-writer, computer and the disc used, you may find that not all discs will play. When playing a CD-R disc, it is normal for the unit to take up to 20 seconds to recognize the disc before starting to play.

If the disc is not recognized after a period of 20 seconds, remove the disc, and insert it again.

- Do not use its full capacity.
- CD-Rs should be preferably used instead of CD-RWs (rewritable CDs) as, in certain cases, CD-RW playback may be faulty.
- Use reliable, good-quality CD write software.
- Close all other applications on the computer to ensure reliable CD-R disc recording.

mp3 files

CD-R and CD-RW discs containing audio files in mp3 format. For CD-R mp3 discs, please follow all the recommendations for CD-R, along with the comments below:

- Your mp3 files should be ISO 9660 or JOLIET format. ISO 9660 format and Joliet mp3 files are compatible with Microsoft's DOS and Windows, as well as with Apple Mac.
- Mp3 filenames should not exceed 8 characters, and should end with the ".mp3" extension. General name format: Title.mp3. When composing your title, use 10 characters or less, no spaces, and avoid the use of special characters including (. , / , \ , = , +).
- The total number of files on a disc should be less than 400.
- Use a decompression transfer rate of at least 128 kB/sec (kilobytes/second) when recording mp3 files. Sound quality with mp3 files basically depends on the rate of compression/ decompression you choose. Obtaining audio CD quality sound requires an analog/digital sampling rate, that is conversion to mp3 format, of at least 128 kB/sec and up to 160 kB/sec. Choosing higher rates, such as 192 kB/sec or more, only rarely produces even better sound quality. Conversely, files with sampling rates below 128 kB/sec will not play properly.
- Do not record copyright-protected mp3 files. "Securized" files are encrypted and code protected to prevent illegal copying.

Important: The above recommendations do not guarantee that the DVD player will play mp3 recordings, or as an assurance of sound quality. Certain technologies and methods for mp3 file recording on CD-Rs prevent optimal playback of these files on your DVD player (i.e. degraded sound quality and in some cases, inability of the player to read the file).

Additional Information

JPEG files

CD-R and CD-RW with JPEG files. Certain JPEG files, including progressive JPEG files, cannot be read by this player.

The total number of files and folders on the disc should be less than 650. Make sure that files have the “.jpg” extension. Files without the “.jpg” extension will not be able to be read by the player - even though the files are shown as JPEG images on your computer.

EN



WMA files

CD-R and CD-RW discs containing audio files in WMA (Windows Media Audio) format. Please follow all the recommendations for CD-R above.

Sound Enhancement Systems

This receiver is equipped with several built-in sound enhancement systems.

Dolby Digital

The Dolby Digital mode lets you enjoy full digital surround from software processed in the Dolby Digital format. Dolby Digital provides better sound quality and a more powerful presence than conventional Dolby Surround. This unit is equipped with Dolby Digital 5.1-channel so that you can enjoy enhanced full digital surround sound.

Dolby Prologic II

The Pro Logic II mode uses the built-in circuit to steer the Left, Center, Right and Surround left and right channel audio signals and uses all five speakers to play both stereo and Dolby Pro Logic program source, such as TV and VCR. Dolby Pro Logic II includes Dolby Pro Logic II Movie, Dolby Pro Logic II Music and Dolby Pro Logic Emulation.

You can use this mode with any stereo program source (such as VCR/TV) to enjoy multi-channel sound experience.

Additional Information

Limited Warranty

What your warranty covers:

- Defects in materials or workmanship.

EN

For how long after your purchase:

- One year from date of purchase - Unit exchange, which includes parts and labor.
- The warranty for rental units begins with the first rental or 45 days from date of shipment to the rental firm, whichever comes first.

What we will do:

- Exchange the defective unit for a new, or at our option, refurbished unit.

How you get service:

- Call 1-580-634-0366 and have your unit's date of purchase and model/serial number ready. The model/serial number information is on the back of your unit.
- A representative will troubleshoot your problem over the phone.
- If the representative determines that you should receive a replacement unit you will be provided with a Service Request (SR) number. No returns will be accepted without the SR number.
- Proof of purchase in the form of a bill of sale or receipted invoice which is evidence that the product is within the warranty period must be presented to obtain warranty service. For rental firms, proof of first rental is also required.

Option I:

1. Provide your Discover, MasterCard or Visa account number and expiration date to your phone representative. This is for security purposes only and your account will not be charged at this time.
2. We will send you a replacement unit.
3. If you return the defective unit to us within 14 days from the date you were provided a SR number, only items not covered by warranty will be charged to your account. If your unit is not received within 14 days, the suggested retail value of the unit will be charged to your credit card. This amount will be credited, less a handling fee, if the unit is subsequently received.
4. Ship your defective unit back to us, less accessories, using the replacement unit's carton. Shipping instructions will be included in the carton along with your SR number which will allow you to easily ship the unit back to us. Make sure you insure your shipment in case of damage or loss. Include with the shipment:
 - Evidence of purchase date such as a bill of sale.
 - A brief note describing your unit's problem.
 - Your name, address and phone number.

Option II:

1. For a fee, we will send a replacement unit to our exchange point.
2. The exchange location will notify you of its arrival.
3. Take your unit and evidence of purchase date, such as a bill of sale, to the exchange location and you will be provided the new or refurbished unit. Please retain all accessories such as the remote control hand unit.
4. If the repairs are covered by your warranty, you will not be billed. Thomson assumes no responsibility for warranty shipments from the customer to the factory if not shipped in the manner prescribed by Thomson.

To receive a replacement unit after we have received your unit:

- Write the SR number on the outside of the carton used to return the unit. Make sure you insure your shipment in case of damage or loss.
- Carefully pack the unit using the original box and packing material if possible. Please retain all accessories that were included with your unit such as the remote control hand unit.
- Include with the shipment:
 1. Evidence of purchase date such as a bill of sale.
 2. A brief note describing your unit's problem.
 3. Your name, address and phone number.

Additional Information

- The representative will advise the address to mail a cashier's check or money order for payment if there are any out of warranty labor or parts charges, and you elect not to use your credit card.
- After we receive your product, a new or refurbished unit will be shipped to you.

What your warranty does not cover:

- Acts of nature, such as but not limited to lightning damage.
- Adjustment of customer controls.
- Damage from misuse or neglect.
- A unit that has been modified or incorporated into other products or is used for institutional or other commercial purposes.
- Batteries.
- Units purchased, serviced or operated outside the U.S.A.
- Loss of programming. It is recommended that you retain all original CD software that was loaded in the unit.
- Installation.
- Shipping damage if the unit was not packed and shipped in the manner prescribed by Thomson.
- Storage fees may be charged by the exchange point if you fail to pick up the replacement unit in a timely manner.

Product Registration:

- Please complete the online Product Registration on RCA.com/productregistration or complete and mail the Product Registration Card packed with your product. This will make it easier to contact you should it ever be necessary. The return of the card is not required for warranty coverage.

Limitation of Warranty:

- THE WARRANTY STATED ABOVE IS THE ONLY WARRANTY APPLICABLE TO THIS PRODUCT. ALL OTHER WARRANTIES, EXPRESS OR IMPLIED (INCLUDING ALL IMPLIED WARRANTIES OF MERCHANTABILITY OR FITNESS FOR A PARTICULAR PURPOSE) ARE HEREBY DISCLAIMED. NO VERBAL OR WRITTEN INFORMATION GIVEN BY THOMSON, ITS AGENTS OR EMPLOYEES SHALL CREATE A GUARANTY OR IN ANY WAY INCREASE THE SCOPE OF THIS WARRANTY.
- REPAIR OR REPLACEMENT AS PROVIDED UNDER THIS WARRANTY IS THE EXCLUSIVE REMEDY OF THE CONSUMER. THOMSON SHALL NOT BE LIABLE FOR INCIDENTAL OR CONSEQUENTIAL DAMAGES RESULTING FROM THE USE OF THIS PRODUCT OR ARISING OUT OF ANY BREACH OF ANY EXPRESS OR IMPLIED WARRANTY ON THIS PRODUCT. THIS DISCLAIMER OF WARRANTIES AND LIMITED WARRANTY ARE GOVERNED BY THE LAWS OF THE STATE OF INDIANA. EXCEPT TO THE EXTENT PROHIBITED BY APPLICABLE LAW, ANY IMPLIED WARRANTY OF MERCHANTABILITY OR FITNESS FOR A PARTICULAR PURPOSE ON THIS PRODUCT IS LIMITED TO THE APPLICABLE WARRANTY PERIOD SET FORTH ABOVE.

How state law relates to warranty:

- Some states do not allow the exclusion nor limitation of incidental or consequential damages, or limitations on how long an implied warranty lasts, so the above limitations or exclusions may not apply to you.
- This warranty gives you specific legal rights, and you also may have other rights that vary from state to state.

If you purchased your product outside the United States:

- This warranty does not apply. See your dealer for warranty information.

EN

Visit the RCA website at www.rca.com
Visitez le site Internet de RCA à l'adresse www.rca.com
Visite el sitio web de RCA en www.rca.com

Please do not send any products to the Indianapolis address listed in this manual or on the carton. This will only add delays in service for your product.

Prière de ne pas envoyer de produits à l'adresse de Indianapolis mentionnée dans ce guide ou sur la boîte. Cela ne fera qu'ajouter des délais à la réparation de votre appareil.

Por favor no envíe ningún producto a la dirección de Indianápolis listada en este manual o en la caja. Esto sólo agregará demoras en el servicio para su producto.

Thomson Inc.

**10330 North Meridian Street
Indianapolis, IN 46290**

©2006 Thomson Inc.

Trademark(s)® Registered
Marque (s)® de commerce enregistrée (s).
Marca(s) Registrada(s)

Printed in China
Imprimé en Chine
Impreso en China

TOCOM 56336040

THOMSON