

**SAMSUNG**

# User Manual



# NX100

This user manual includes detailed usage instructions for your camera.  
Please read this manual thoroughly.

ENG

# Copyright information

---

- Microsoft Windows and the Windows logo are registered trademarks of the Microsoft Corporation.
- Mac is a registered trademark of the Apple Corporation.
- HDMI, the HDMI logo, and the term “High Definition Multimedia Interface” are trademarks or registered trademarks of HDMI Licensing LLC.
- Trademarks and trade names used in this manual are the property of their respective owners.



PlanetFirst represents Samsung Electronics' commitment to the sustainable development and social responsibility through eco-driven business and management activities.

- Camera specifications or contents of this manual may be changed without prior notice due to upgrade of camera functions.
- You are not allowed to reuse or distribute any part of this manual without prior permission.
- For Open Source License information, refer to the “OpenSourceInfo.pdf” in the provided CD-ROM.

# Health and safety information

---

Always comply with the following precautions and usage tips to avoid dangerous situations and ensure peak performance of your camera.



## Safety warnings

### Do not use your camera near flammable or explosive gases and liquids

Do not use your camera near fuels, combustibles, or flammable chemicals. Do not store or carry flammable liquids, gases, or explosive materials in the same compartment as the camera or its accessories.

### Keep your camera away from small children and pets

Keep your camera and all accessories out of the reach of small children and animals. Small parts may cause choking or serious injury if swallowed. Moving parts and accessories may present physical dangers as well.

### Prevent damage to subjects' eyesight

Do not use the flash in close proximity (closer than 1 m/3 ft) to people or animals. Using the flash too close to your subject's eyes can cause temporary or permanent damage.

### Handle and dispose of batteries and chargers with care

- Use only Samsung-approved batteries and chargers. Incompatible batteries and chargers can cause serious injuries or damage to your camera.
- Never dispose of batteries in a fire. Follow all local regulations when disposing of used batteries.
- Never place batteries or cameras on or in heating devices, such as microwave ovens, stoves, or radiators. Batteries may explode when overheated.
- Do not use a damaged power supply cord, plug, or loose outlet when charging batteries. This may cause fire or electric shock.



## Safety precautions

### Handle and store your camera carefully and sensibly

- Do not allow your camera to get wet—liquids can cause serious damage. Do not handle your camera with wet hands. Water damage to your camera can void your manufacturer's warranty.
- Do not expose the camera to direct sunlight or high temperatures for an extended period of time. Prolonged exposure to sunlight or extreme temperatures can cause permanent damage to your camera's internal components.

- Avoid using or storing your camera in dusty, dirty, humid, or poorly-ventilated areas to prevent damage to moving parts and internal components.
- Remove the batteries from your camera when storing it for an extended period of time. Installed batteries may leak or corrode over time and cause serious damage to your camera.
- Prolonged usage of the camera may overheat the battery and raise the internal temperature of the camera. If the camera stops operating, remove the battery and allow it to cool down.
- Protect your camera from sand and dirt when using it on beaches or in other similar areas.
- Protect your camera from impact, rough handling, and excessive vibration to avoid serious damage.
- Exercise caution when connecting cables or adapters and installing batteries and memory cards. Forcing the connectors, improperly connecting cables, or improperly installing batteries and memory cards can damage ports, connectors, and accessories.
- Do not insert foreign objects into any of your camera's compartments, slots, or access points. Damage due to improper use may not be covered by your warranty.
- Do not swing your camera by the strap. This may cause injury to yourself or others.
- Do not paint your camera, as paint can clog moving parts and prevent proper operation.
- Paint or metal on the outside of the camera may cause allergic reactions, itchy skin, eczema, or swelling for people with sensitive skin. If you experience any of these symptoms, stop using the camera immediately and consult a doctor.

## **Protect batteries, chargers, and memory cards from damage**

- Avoid exposing batteries or memory cards to very cold or very hot temperatures (below 0 °C/32 °F or above 40 °C/104 °F). Extreme temperatures can reduce the charging capacity of your batteries and can cause memory cards to malfunction.
- Prevent batteries from making contact with metal objects, as this can create a connection between the + and – terminals of your battery and lead to temporary or permanent battery damage. Also, this may cause fire or electric shock.
- Prevent memory cards from making contact with liquids, dirt, or foreign substances. If dirty, wipe the memory card clean with a soft cloth before inserting in your camera.
- Do not allow liquids, dirt, or foreign substances to come in contact with the memory card slot. Doing so may cause the camera to malfunction.
- Insert the memory card in the correct direction. Inserting a memory card in the wrong direction may damage your camera and memory card.
- Turn off the camera when inserting or removing the memory card.
- Do not bend, drop, or subject memory cards to heavy impact or pressure.
- Do not use memory cards that have been formatted by other cameras or by a computer. Format the memory card with your camera.
- Never use a damaged charger, battery, or memory card.

### **Use only Samsung-approved accessories**

Using incompatible accessories may damage your camera, cause injury, or void your warranty.

### **Protect your camera's lens**

- Do not expose the lens to direct sunlight, as this may discolor the image sensor or cause it to malfunction.
- Protect your lens from fingerprints and scratches. Clean your lens with a soft, clean, debris-free lens cloth.

## Important usage information

### **Allow only qualified personnel to service your camera**

Do not allow unqualified personnel to service the camera or attempt to service the camera yourself. Any damage that results from unqualified service is not covered by your warranty.

### **Ensure maximum battery and charger life**

- Overcharging batteries may shorten battery life. After charging is finished, disconnect the cable from your camera.
- Over time, unused batteries will discharge and must be recharged before use.
- Disconnect chargers from power sources when not in use.
- Use batteries only for their intended purpose.

### **Exercise caution when using the camera in humid environments**





When transferring the camera from a cold environment to a warm and humid one, condensation may form on the delicate electronic circuitry and memory card. In this situation, wait for at least 1 hour until all moisture has evaporated before using the camera.

### **Check that the camera is operating properly before use**



The manufacturer takes no responsibility for any loss of files or damage that may result from camera malfunction or improper use.

# Indications used in this manual

## Icons used in this manual

Icon	Function
	Additional information
	Safety warnings and precautions
[ ]	Camera buttons. For example, [Shutter] represents the shutter button.
( )	Page number of related information
▶	The order of options or menus you must select to perform a step; for example: Select  ▶ <b>Quality</b> (represents select  , and then <b>Quality</b> ).
*	Annotation

## Shooting mode indications

Shooting mode	Indication
Smart Auto	
Program	<b>P</b>
Aperture Priority	<b>A</b>
Shutter Priority	<b>S</b>
Manual	<b>M</b>
Lens Priority	
Scene	<b>SCENE</b>
Movie	

## Abbreviations used in this manual

Abbreviation	Definition
AE	Auto Exposure
AF	Auto Focus
BKT	Bracketing
DPOF	Digital Print Order Format
EV	Exposure Value
FA	Focus Aid
MF	Manual Focus
OIS	Optical Image Stabilization
ISO	International Organization for Standardization's measure for light sensitivity
WB	White Balance

# Contents

---

## Tips

### Concepts in Photography



<b>Shooting postures</b> .....	<b>10</b>
Holding the camera.....	10
Standing photography.....	10
Crouching photography .....	11
<b>Aperture</b> .....	<b>11</b>
Aperture value and the depth of field .....	12
<b>Shutter speed</b> .....	<b>13</b>
<b>ISO sensitivity</b> .....	<b>14</b>
<b>How the aperture setting, shutter speed, and ISO sensitivity control exposure</b> .....	<b>15</b>
<b>Correlation between focal length, angle, and perspective</b> .....	<b>16</b>
<b>Depth of field</b> .....	<b>17</b>
What controls out-of-focus effects? .....	17
DOF preview .....	19
<b>Composition</b> .....	<b>19</b>
Rule of Thirds.....	19
Photos with two subjects .....	20
<b>Flash</b> .....	<b>21</b>
Flash guide number.....	21
Bounce Photography .....	22

## Chapter 1

### My Camera

<b>Get started</b> .....	<b>24</b>
Unpack .....	24
<b>Camera layout</b> .....	<b>25</b>
<b>Display icons</b> .....	<b>28</b>
In Shooting mode.....	28
Capture photos.....	28
Record videos.....	29
In Playback mode.....	30
View photos.....	30
Play videos.....	30
<b>Lenses</b> .....	<b>31</b>
Lens layout.....	31
Lock or unlock the lens .....	32
Lens markings.....	34
<b>Optional accessories</b> .....	<b>35</b>
Flash layout .....	35
Connect the flash .....	35
GPS module layout.....	36
Attach the GPS module.....	37
Attach the electronic viewfinder .....	38

**Shooting modes** ..... 39

-  Smart Auto mode ..... 39
- P** Program mode ..... 40
  - Program Shift ..... 40
- A** Aperture Priority mode ..... 41
- S** Shutter Priority mode ..... 41
- M** Manual mode ..... 42
  - Framing Mode ..... 42
  - Use a bulb ..... 42
-  Lens Priority mode ..... 42
  - Use i-Scene mode ..... 42
  - Use i-Function in **PASM** modes ..... 43
  - Available options ..... 44
- SCENE** Scene mode ..... 45
-  Movie mode ..... 47
- Available functions by shooting mode ..... 48

Chapter 2

**Shooting Functions**

**Size** ..... 50

- Photo size options ..... 50
- Video size options ..... 50

**Quality** ..... 51

- Photo quality options ..... 51
- Video quality options ..... 51

**ISO sensitivity** ..... 52

- Expand ISO value ..... 52

**White Balance (light source)** ..... 53

- White balance options ..... 53
- Customize preset options ..... 54

**Picture Wizard (photo styles)** ..... 56

**Color Space** ..... 57

**AF Mode** ..... 58

- Single AF ..... 58
- Continuous AF ..... 59
- Manual Focus ..... 59

**AF Area** ..... 60

- Selection AF ..... 60
- Multi AF ..... 61
- Face Detection AF ..... 61
- Self-Portrait AF ..... 62

**AF Priority** ..... 63

**MF Assist** ..... 64

**Drive (shooting method)** ..... 65

- Single ..... 65
- Continuous ..... 65
- Burst ..... 66
- Timer ..... 66
- AE BKT ..... 67
- WB BKT ..... 67
- P Wiz BKT ..... 68
- BKT Set ..... 68

**Flash** ..... 69

- Flash options ..... 69
- Correct the red-eye effect ..... 70
- Adjust the flash intensity ..... 70



<b>Metering</b> .....	<b>71</b>
Spot .....	71
Link AE to AF Point .....	71
Center-weighted .....	72
Multi .....	72
<b>Smart Range</b> .....	<b>73</b>
<b>OIS</b> .....	<b>74</b>
OIS options .....	74
<b>Exposure Compensation</b> .....	<b>75</b>
<b>Exposure/Focus Lock</b> .....	<b>76</b>
<b>Video functions</b> .....	<b>77</b>
Movie AE Mode .....	77
Fader.....	77
Wind Cut.....	78
Auto Focus.....	78
Voice .....	78

### Chapter 3

## Playback/Editing

<b>Search and manage files</b> .....	<b>80</b>
View photos .....	80
View image thumbnails.....	80
View files by category in Smart Album .....	81
Protect files .....	81
Delete files.....	81
Delete a single file .....	81
Delete multiple files.....	82
Delete all files .....	82

<b>View photos</b> .....	<b>83</b>
Enlarge a photo .....	83
Start a slide show .....	83
Highlight .....	84
Auto Rotate.....	84
<b>Play a video</b> .....	<b>85</b>
Video viewing controls.....	85
Trim a video during playback .....	85
Capture an image during playback .....	86
<b>Edit a photo</b> .....	<b>87</b>
Options .....	87

### Chapter 4

## Camera settings menu

<b>User settings</b> .....	<b>90</b>
ISO Step .....	90
Auto ISO Range .....	90
Noise Reduction.....	90
AF Lamp .....	90
User Display .....	91
Key Mapping .....	92
<b>Setting 1</b> .....	<b>93</b>
<b>Setting 2</b> .....	<b>94</b>
<b>Setting 3</b> .....	<b>95</b>
<b>Setting 4</b> .....	<b>97</b>
<b>Setting 5</b> .....	<b>98</b>

## Chapter 5

**Connect to external devices**

<b>View files on a TV or HDTV .....</b>	<b>100</b>
View files on a TV .....	100
View files on an HDTV .....	101
<b>Print photos .....</b>	<b>102</b>
Print photos with a photo printer (PictBridge).....	102
Configure print settings .....	103
Set printer info using DPOF .....	103
DPOF options .....	104
<b>Transfer files to your computer .....</b>	<b>105</b>
Transfer files to your computer (for Windows) .....	105
Transfer files by connecting the camera as a removable disk.....	105
Disconnect the camera (Windows XP).....	106
Transfer files to your computer (for Mac) .....	106
<b>Edit photos on a PC .....</b>	<b>107</b>
Install software .....	107
Programs contained on the CD .....	107
Use Intelli-studio .....	107
System Requirements .....	108
Use the Intelli-studio Interface .....	108
Transfer files using Intelli-studio .....	109
Use Samsung RAW Converter.....	110
System Requirements for Windows.....	110
System Requirements for Mac .....	110
Use the Samsung RAW Converter Interface .....	111
Edit RAW format files .....	111

## Chapter 6

**Appendix**

<b>Error messages .....</b>	<b>115</b>
<b>Maintain the camera .....</b>	<b>116</b>
Clean the camera .....	116
Camera lens and display .....	116
About the image sensor .....	116
Camera body .....	116
About memory card.....	117
Supported memory card .....	117
Memory card capacity.....	117
<b>About the battery .....</b>	<b>119</b>
Battery specifications .....	119
Battery life .....	119
Notes about charging the battery .....	120
<b>Before contacting a service center .....</b>	<b>122</b>
<b>Camera specifications .....</b>	<b>125</b>
<b>Lens specifications .....</b>	<b>129</b>
<b>Accessories (optional).....</b>	<b>131</b>
<b>Index .....</b>	<b>132</b>
<b>FCC notice.....</b>	<b>135</b>

# Concepts in Photography

## Shooting postures

A correct posture for stabilizing the camera is necessary for taking a good photo. Even if you hold a camera correctly, the wrong posture can cause the camera to shake. Stand up straight and remain still to maintain a steady base for your camera. When shooting with a low shutter speed, hold your breath to minimize body movement.

### Holding the camera

Hold the camera with your right hand and place your right index finger on the shutter button. Place your left hand under the lens for support.

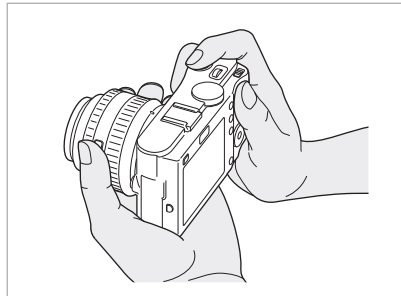
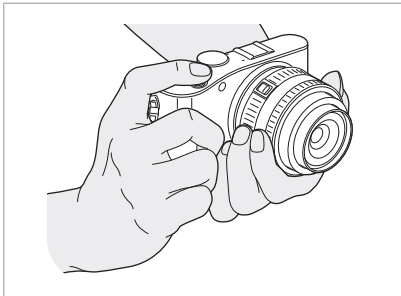

### Standing photography

Compose your shot; stand up straight with your feet shoulder-length apart, and keep your elbows pointed down.

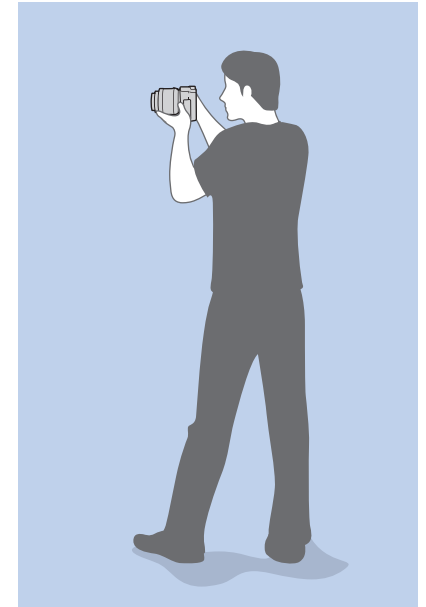

## Crouching photography

Compose your shot, crouch with one knee touching the ground, and keep a straight posture.

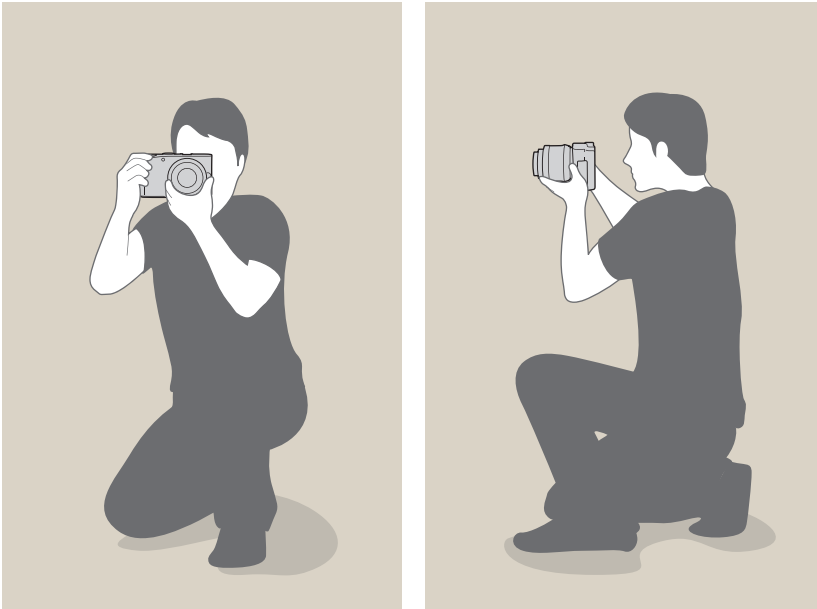

## Aperture

The aperture, a hole that controls the amount of light that enters the camera, is one of the three factors that determine the exposure. The aperture housing contains thin, metal plates that open and close to let light through the aperture and into the camera. The size of the aperture is closely related to the brightness of a photo: the larger the aperture, the brighter the photo; the smaller the aperture, the darker the photo.

### Aperture sizes

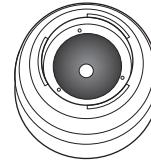

Minimum aperture

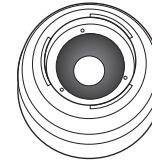

Medium aperture

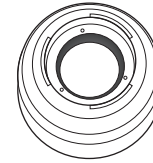

Maximum aperture



Darker photo  
(aperture opened slightly)



Brighter photo  
(aperture opened wide)

The size of the aperture is represented by a value known as an “F-number.” The f-number represents the focal length divided by the diameter of the lens. For example, if a lens with a 50 mm focal length has an f-number of F2, the diameter of the aperture is 25 mm. ( $50 \text{ mm}/25 \text{ mm}=F2$ ) The smaller the f-number, the greater the size of the aperture.

The opening in the aperture is described as the Exposure Value (EV). Increasing the Exposure Value (+1 EV) means the amount of light doubles. Decreasing the Exposure Value (-1 EV) means the amount of light halves. You can also use the exposure compensation feature to fine-tune the amount of light by subdividing exposure values into 1/2, 1/3 EV, and so on.

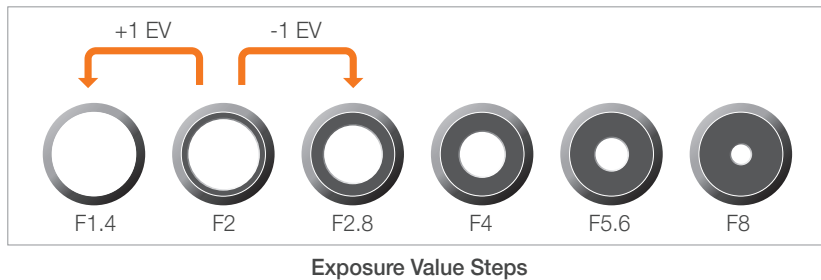

## Aperture value and the depth of field

You can blur or sharpen the background of a photo by controlling the aperture. It is closely related to the depth of field (DOF), which can be expressed as small or large.



A photo with a large DOF



A photo with a small DOF



The aperture housing contains several blades. These blades move together and control the amount of light passing through the center of the aperture. The number of blades also affects the shape of light when shooting night scenes. If an aperture has an even number of blades, light divides into an equal number of sections. If the number of blades is odd, the number of sections is double the number of blades.

For example, an aperture with 8 blades divides light into 8 sections and an aperture with 7 blades into 14 sections.

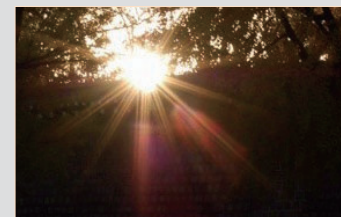

7 blades

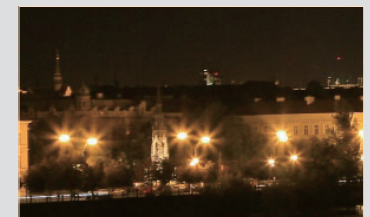

8 blades

## Shutter speed

Shutter speed refers to the amount of time it takes to open and close the shutter, and it is an important factor in the brightness of a photo, as it controls the amount of light which passes through the aperture before it reaches the image sensor.

Usually, the shutter speed is manually adjustable. The measurement of the shutter speed is known as the “Exposure Value” (EV), which is marked in intervals of 1 s, 1/2 s, 1/4 s, 1/8 s, 1/15 s, 1/1000 s, 1/2000 s, and so on.

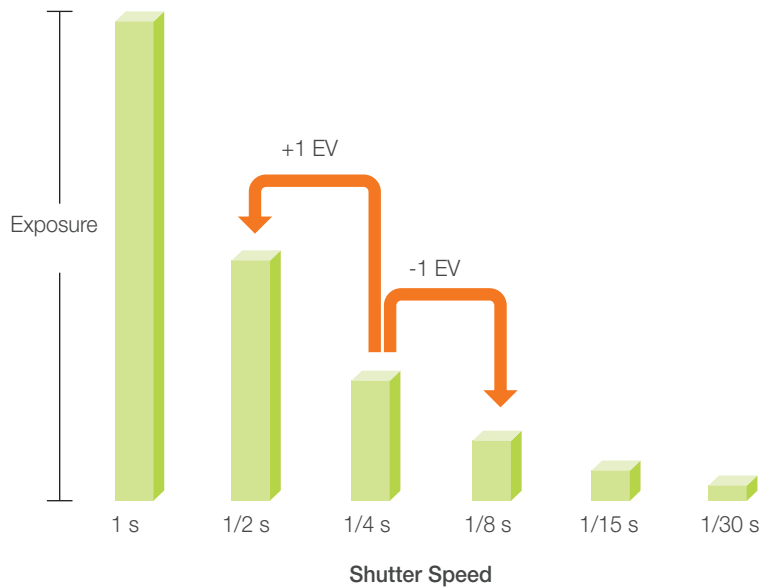

The numbers indicated on the camera are the denominators of exposure values, which means that the higher the number, the less light will be let in. Likewise, the smaller the EV number, the more light will be let in.

As the photos below illustrate, a slow shutter speed allows more time to let light in, so the photo becomes brighter. On the other hand, a fast shutter speed allows less time to let light in and the photo becomes darker and more easily freezes subjects in motion.

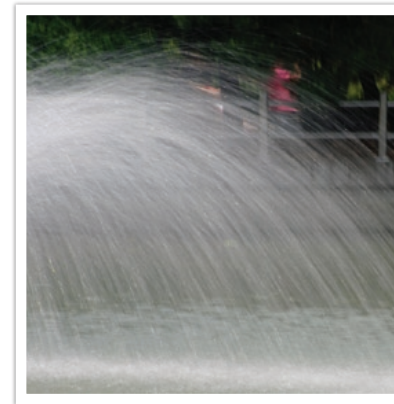

0.8 s



0.004 s

## ISO sensitivity

The exposure of an image is determined by the sensitivity of the camera. This sensitivity is based on international film standards, known as ISO standards. On digital cameras, this sensitivity rating is used to represent the sensitivity of the digital mechanism that captures the image.

ISO sensitivity doubles as the number doubles. For example, an ISO 200 setting is capable of capturing images at twice the speed of an ISO 100 setting. However, higher ISO settings can result in “noise”—small specks, spots, and other phenomena in a photo that give the shot a noisy or dirty appearance. As a general rule, it is best to use a low ISO setting to prevent noise in your photos, unless you are shooting in darkened environments or at night.

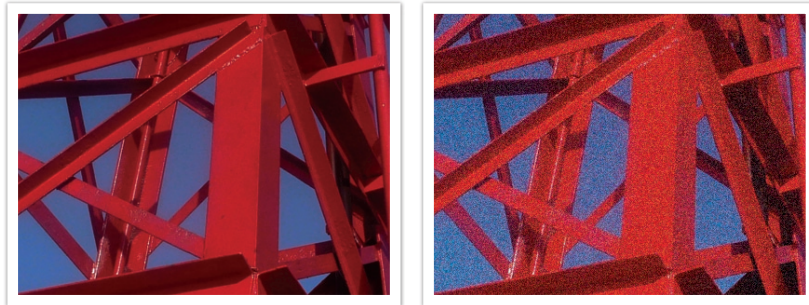

Changes in the quality and brightness according to ISO sensitivity

Because a low ISO sensitivity means the camera will be less sensitive to light, you need more light to have an optimal exposure. When using a low ISO sensitivity, open the aperture more or reduce the shutter speed to allow more light to enter the camera. For example, on a sunny day when light is abundant, a low ISO sensitivity does not require a low shutter speed. However, in a dark place or at night, a low ISO sensitivity and a fast shutter speed will result in a blurry photo.



A photo taken with a tripod and high sensitivity





A blurred photo with a low ISO sensitivity

## How the aperture setting, shutter speed, and ISO sensitivity control exposure

The aperture setting, shutter speed, and ISO sensitivity are closely interconnected in photography. The aperture setting controls the opening that regulates the light that enters the camera, while the shutter speed determines the length of time that light is allowed to enter. ISO sensitivity determines the speed at which the film reacts to light. Together, these three aspects are described as the triangle of exposure.

A change in shutter speed, aperture value, or ISO sensitivity can be offset by adjustments to the others to maintain the amount of light. The results, however, change according to the settings. For example, shutter speed is useful in expressing movement, aperture can control the depth of field, and ISO sensitivity can control the graininess of a photo.

	Settings	Results
Shutter speed	Fast speed = less light Slow speed = more light	 Fast = still Slow = blurry

	Settings	Results
Aperture	Wide aperture = more light Narrow aperture = less light	 Wide = small depth of field Narrow = large depth of field
ISO sensitivity	High sensitivity = more sensitive to light Low sensitivity = less sensitive to light	 High = more grainy Low = less grainy



## Correlation between focal length, angle, and perspective

Focal length, which is measured in millimeters, is the distance between the middle of the lens to its focal point. It affects the angle and perspective of captured images. A short focal length translates into a wide angle, which allows you to capture a wide shot. A long focal length translates into a narrow angle, which allows you to capture telephoto shots.

### Short focal length

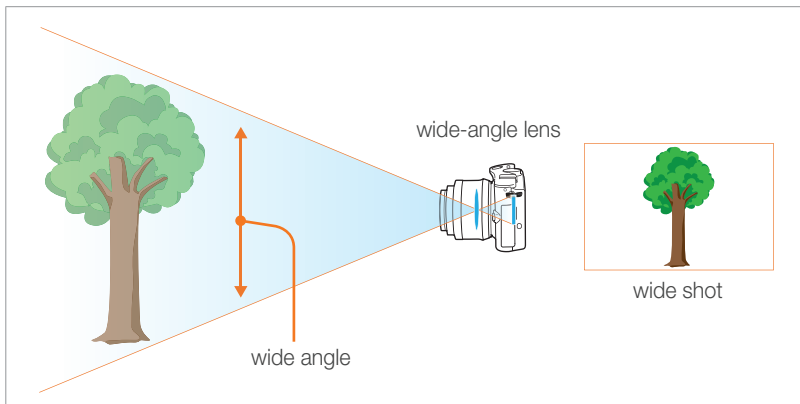

### Long focal length

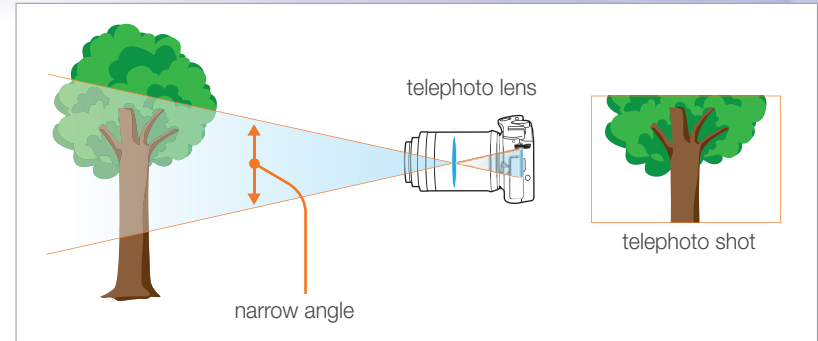

Look at these photos below and compare the changes.



20 mm angle



50 mm angle

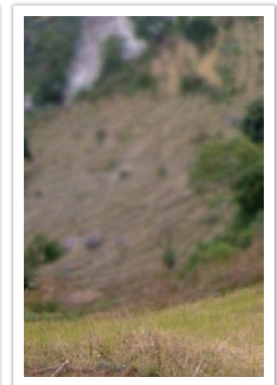

200 mm angle



Normally, a lens with a wide angle is suitable for shooting landscapes and a lens with a narrow angle is recommended for shooting sports events or portraits.

## Depth of field

Portraits or still-life photos mostly acclaimed by people are the ones on which the background is out of focus so the subject looks pronounced. Depending on the focused areas, a photo can be blurred or sharpened. This is called 'a low DOF' or 'a high DOF'.

The depth of field is the focused area around the subject. Therefore, a small DOF signifies that the focused area is narrow and a large DOF means the focused area is wide.

A photo with a small DOF, which stresses the subject and makes the rest of it blurred, can be obtained by using a telescope lens or selecting a low aperture value. Conversely, a photo with a large DOF which shows all the elements on the photo sharply focused can be achieved by using a wide angle lens or selecting a high aperture value.



Small Depth of Field

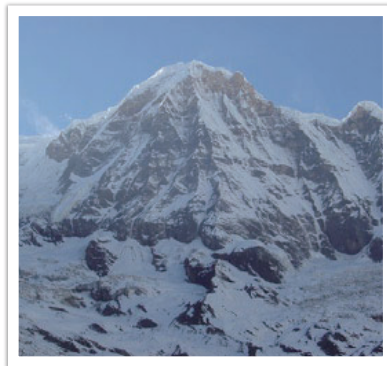

Large Depth of Field

### What controls out-of-focus effects?

#### DOF depends on aperture value

The wider the aperture is (namely the lower the aperture value), the lower the DOF becomes. Under the condition where the other values including shutter speed and ISO sensitivity are equal, a low aperture value leads to a photo with a low DOF.



50 mm F5.7



50 mm F22

## DOF depends on focal length

The longer the focal length is, the lower the DOF gets. A telescope lens with a longer focal length than a telescope lens with a short focal length is better to take a photo of a low DOF.

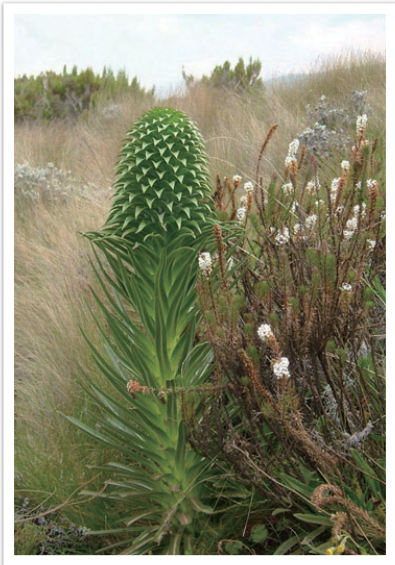

A photo taken with a 18 mm telescope lens



A photo taken with a 100 mm telescope lens

## DOF depends on the distance between the subject and the camera

The shorter the distance between the subject and the camera is, the lower the DOF gets. Therefore, taking a photo close to a subject can result in a photo of low DOF.

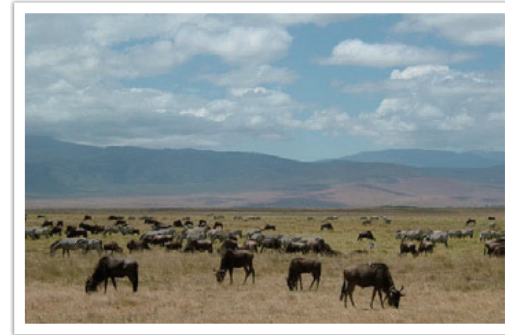

A photo taken with a 100 mm telescope lens

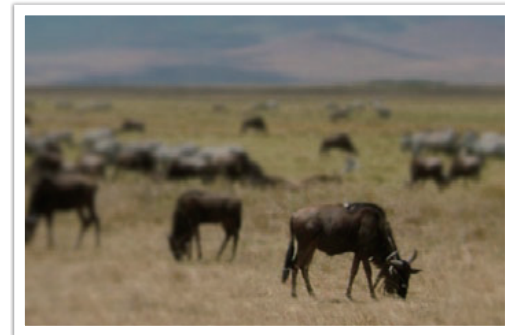

A photo taken close to the subject

## DOF preview

You can use the Depth preview button to get an idea of what your shot will look like before shooting. When you press the button, the camera adjusts the aperture to the predefined settings and shows the results on the screen.

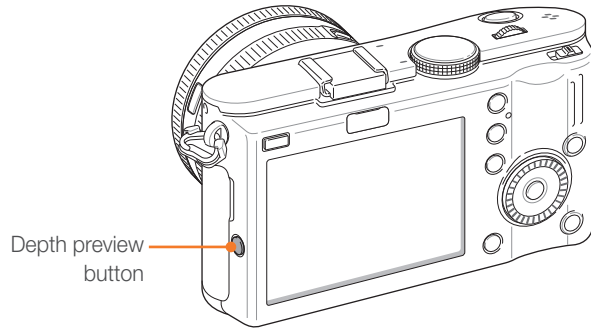

## Composition

It is fun to take a photo of the beauty of world with a camera. No matter how the world is beautiful, however, a poor composition cannot capture the beauty of it.

When it comes to composition, it is very important to prioritize subjects.

Composition in photography means arranging objects in a photo. Usually, abiding by the rule of thirds leads to a good composition.

### Rule of Thirds

To use the rule of thirds, divide the image into a 3x3 pattern of equal rectangles.

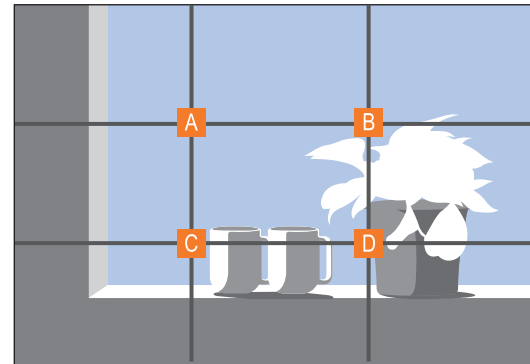

To compose photos that best emphasize the subject, make sure the subject is located at one of the corners of the center rectangle.

Using the rule of thirds will create photos with stable and compelling compositions. Below are a few examples.

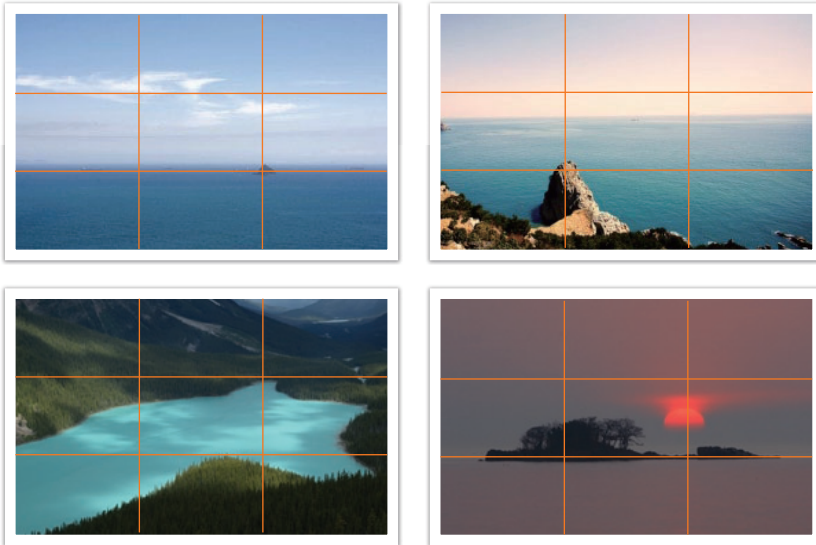

### Photos with two subjects

If your subject is in one corner of the photo, it creates an unbalanced composition. You can stabilize the photo by capturing a second subject in the opposite corner to balance the weight of the photo.

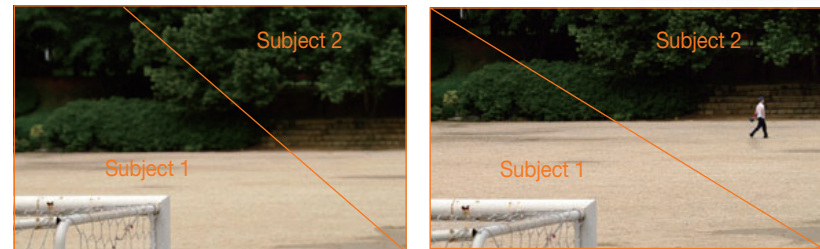

Unstable

Stable

When taking landscape photos, centering the horizon will create an unbalanced effect. Give more weight to the photo by moving the horizon up or down.



Unstable

Stable

## Flash

Light is one of the most important components in photography. It's not easy, however, to have an enough amount of light anytime and anywhere. Making use of a flash allows you to optimize light settings and create a variety of effects.

Flash, also known as strobe or speed light, helps to create adequate exposure in low-light conditions. It is also useful in light-abundant situations. For example, flash can be used in compensating the exposure of a subject's shadow or capturing clearly both the subject and the background in backlit conditions.



Before correction



After correction

### Flash guide number

The model number of a flash refers to the flash's power, and the maximum amount of light created is represented by a value known as a "guide number." The bigger the guide number, the more light is emitted from the flash. The guide number is achieved by multiplying the distance from the flash to the subject and the aperture value when the ISO sensitivity is set to 100.

**Guide number = Flash to Subject Distance X Aperture value**

**Aperture value = Guide number / Flash to Subject Distance**

**Flash to Subject Distance = Guide number / Aperture value**

Therefore, if you know the guide number of a flash, you can estimate an optimum flash to subject distance when setting the flash manually. For example, if a flash has a guide number of GN 20 and is 4 meters away from the subject, the optimal aperture value is F 5.0.

## Bounce Photography

Bounce photography refers to the method of photography which redirects the light from the subject to the ceiling or walls so that the light spreads evenly. Normally, photos taken with flash may appear unnatural and cast shadows. Subjects in photos taken with bounce photography cast no shadows and look smooth due to evenly spread light.





# Chapter 1

# My Camera

---

Learn about your camera's layout, display icons, basic functions, supplied lens, and optional accessories.



# Get started

## Unpack

Check your product box for the following items.

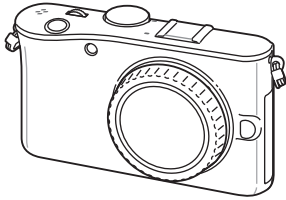

Camera  
(including the body cap, accessory shoe cover, and smart shoe cover)

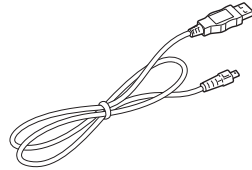

USB cable

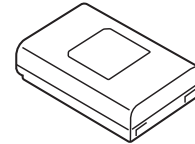

Rechargeable battery

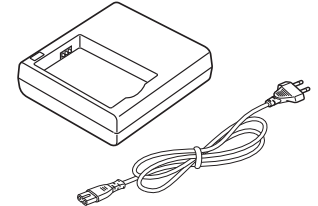

Battery cradle/AC power cable

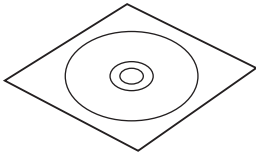

Software CD-ROM  
(User manual included)

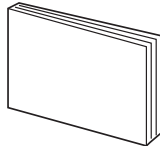

User manual Basic Operation

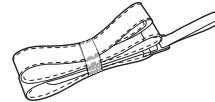

Strap



The illustrations may differ from your actual items. For information about accessories, refer to page 131.

# Camera layout

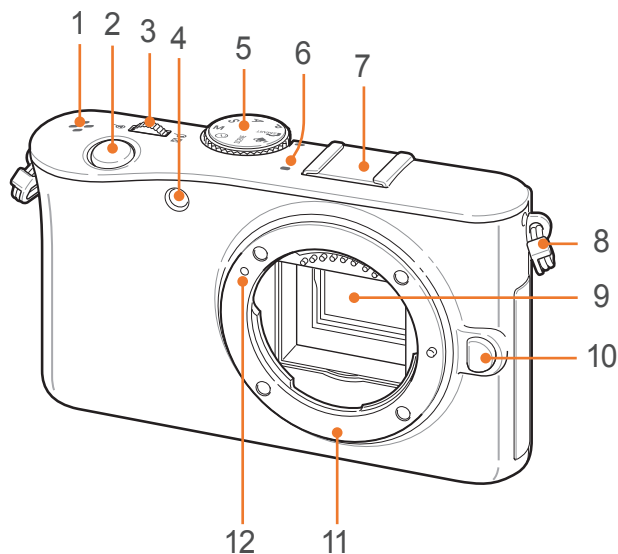

No.	Name
1	Speaker
2	Shutter button
3	Jog dial <ul style="list-style-type: none"> <li>• <b>In Shooting mode:</b> change the setting values of menus, adjust shutter speed in some shooting modes, and change the size of a focus area.</li> <li>• <b>In Playback mode:</b> enlarge or reduce a photo.</li> </ul>
4	AF-assist light/Timer lamp
5	Mode dial <ul style="list-style-type: none"> <li>• <b>SMART</b>: Smart Auto mode (p. 39)</li> <li>• <b>P</b>: Program mode (p. 40)</li> <li>• <b>A</b>: Aperture Priority mode (p. 41)</li> <li>• <b>S</b>: Shutter Priority mode (p. 41)</li> <li>• <b>M</b>: Manual mode (p. 42)</li> <li>• <b>i</b>: Lens Priority mode (p. 42)</li> <li>• <b>SCENE</b>: Scene mode (p. 45)</li> <li>• <b>MOVIE</b>: Movie mode (p. 47)</li> </ul>

No.	Name
6	Microphone
7	Accessory shoe
8	Eyelet for camera strap
9	Image sensor
10	Lens removal button
11	Lens mount
12	Lens mount index

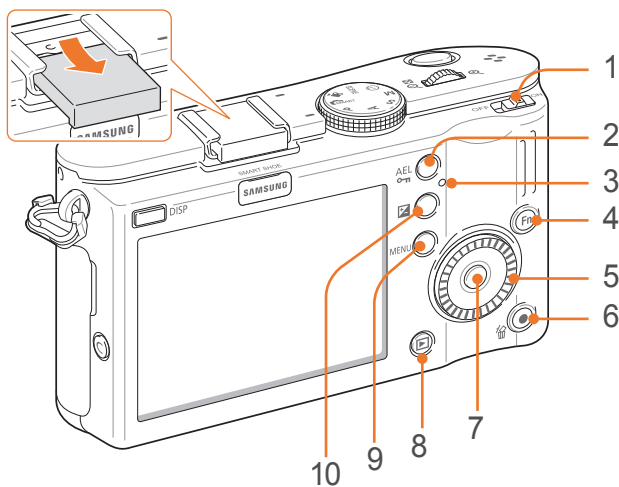

No.	Name
1	Power switch
2	<b>AEL</b> button (p. 92) <ul style="list-style-type: none"> <li>• <b>In Shooting mode:</b> Lock the adjusted exposure value or focus.</li> <li>• <b>In Playback mode:</b> Protect the displayed file.</li> </ul>

No.	Name
3	<b>Status lamp</b> <ul style="list-style-type: none"> <li>• <b>Blinking:</b> When saving a photo, shooting a video, sending data to a computer or printer.</li> <li>• <b>Steady:</b> When there is no data transfer or when data transfer to a computer or printer is complete.</li> </ul>
4	<b>Fn</b> button Access major functions and fine-tune some settings.
5	<b>Navigation</b> button <ul style="list-style-type: none"> <li>• <b>In Shooting mode</b> <ul style="list-style-type: none"> <li>- <b>AF·MF</b> : Select an AF Mode</li> <li>- <b>ISO</b> : Select an ISO value</li> <li>- <b>DRIVE</b> : Select a Drive mode</li> <li>- <b>WB</b> : Select a White Balance</li> </ul> </li> <li>• <b>In other situations</b>                              Move up, down, left, right, respectively. (You can also rotate the navigation wheel.)                             <p><b>When rotating:</b></p> <ul style="list-style-type: none"> <li>• Scroll to an option or menu.</li> <li>• Adjust aperture value in Shooting mode.</li> <li>• Scroll through files in Playback mode.</li> <li>• Adjust the frame location when selecting a focus manually.</li> </ul> </li> </ul>

No.	Name
6	<b>Green/Delete</b> button <ul style="list-style-type: none"> <li>• <b>In Shooting mode:</b> Reset the value of Picture Wizard, White Balance, Color Temperature, Display Color, Timer, Flash EV, Selection AF (a repositioned focus area is moved back to the center), or exposure compensation, or exposure value for each mode.</li> <li>• <b>In Playback mode:</b> Delete a file or files.</li> </ul>
7	<b>OK</b> button <ul style="list-style-type: none"> <li>• <b>In Shooting mode</b>                              Change the size and position of the AF area.</li> <li>• <b>In other situations</b>                              Confirm the highlighted option or menu.</li> </ul>
8	<b>Playback</b> button Enter Playback mode.
9	<b>MENU</b> button Access options or menus.
10	<b>EV</b> button Press and hold [FZ], and then rotate the jog dial to adjust the exposure value. (p. 75)

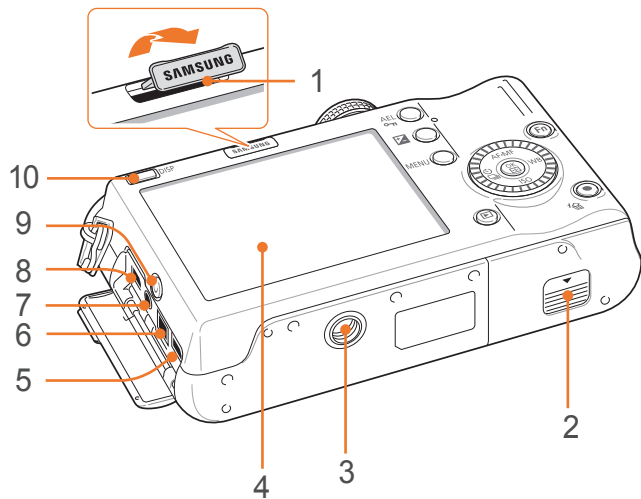

No.	Name
1	<b>Smart shoe</b> Connect an optional electronic viewfinder.
2	<b>Battery chamber cover</b> Insert a memory card and battery.
3	<b>Tripod mount</b>
4	<b>Display</b>
5	<b>HDMI port</b>
6	<b>Power adapter port</b>
7	<b>Shutter release port</b> Use a shutter release cable with a tripod to minimize camera movement.

No.	Name
8	<b>USB and AV port</b> Connect the camera to other devices via a USB A/V cable.
9	<b>Depth preview button (p. 19)</b>
10	<b>DISP button</b> <ul style="list-style-type: none"> <li>• <b>In Shooting mode:</b> View camera settings and change options.</li> <li>• <b>In Playback mode:</b> View photo information.</li> </ul>

# Display icons

## In Shooting mode

### Capture photos

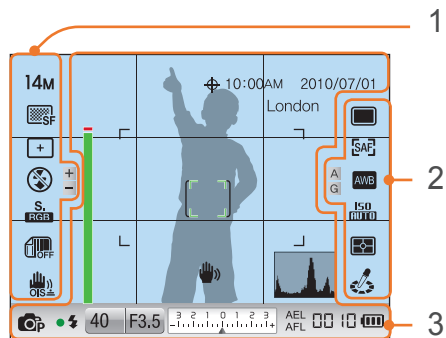

### 1. Shooting options (left)

Icon	Description
	Photo size
	Photo quality
	Focus area option
	Face detection
	Flash option*
	Flash intensity*
	Color space
	Smart range (p. 73)
	Optical Image Stabilization (OIS) (p. 74)

\* These icons appear when you attach an optional flash.

### 2. Shooting options (right)

Icon	Description
	Drive mode
	AF mode (p. 58)
	White balance (p. 53)
	White balance micro adjustment
	ISO sensitivity (p. 52)
	Metering (p. 71)
	Picture wizard (p. 56)
	Face tone
	Face retouch

### 3. Shooting information

Icon	Description
	GPS activated*
10:00AM	Time
2010/07/01	Date
London	Location information*
	Focus aid bar (p. 64)
	Auto focus frame
	Spot metering area
	Camera shake

Icon	Description
	Histogram (p. 91)
	Shooting mode
	Focus
	Flash indicator**
40	Shutter speed
F3.5	Aperture value
	Exposure value
AEL	Auto exposure lock (p. 92)
AFL	Auto focus lock (p. 92)
	No external memory card
	Number of available shots
	: Fully charged : Partially charged (Red) : Empty (recharge the battery)

\* These icons appear when you attach an optional GPS module.

\*\* This icon appears when you attach an optional flash.



The icons displayed will change according to the mode you select or the options you set.

## Record videos

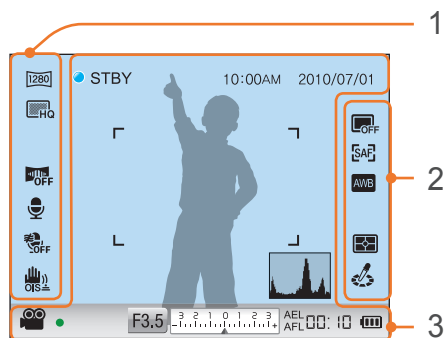

### 1. Shooting options (left)

Icon	Description
	Video size
	Video quality
	Fader (p. 77)
	Recording voice on (p. 78)
	Cut wind sound (p. 78)
	Optical Image Stabilization (OIS) (p. 74)

### 2. Shooting options (right)

Icon	Description
	Drive mode
	AF mode (p. 58)
	White balance (p. 53)
	Metering (p. 71)
	Picture wizard (p. 56)

### 3. Shooting information

Icon	Description
<b>10:00AM</b>	Time
<b>2010/07/01</b>	Date
	Histogram (p. 91)
	Shooting mode
	Focus
<b>F3.5</b>	Aperture value
	Exposure value
<b>AEL</b>	Auto exposure lock (p. 92)
<b>AFL</b>	Auto focus lock (p. 92)
	No external memory card
<b>00:10</b>	Available recording time
	: Fully charged : Partially charged (Red) : Empty (recharge the battery)



The icons displayed will change according to the mode you select or the options you set.

## In Playback mode

### View photos

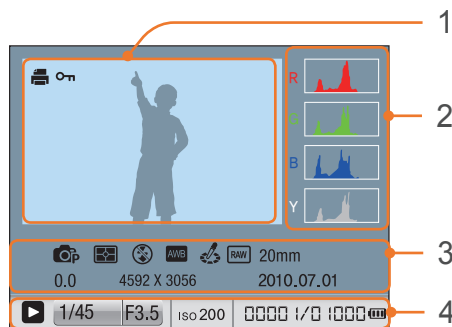
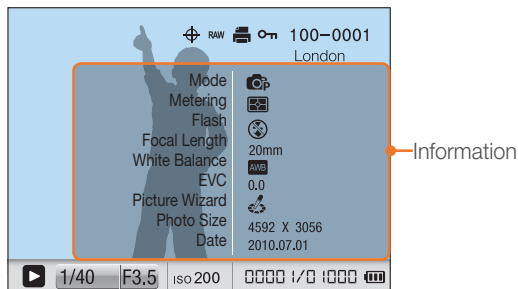

### Play videos

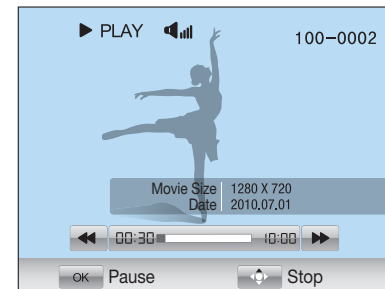

Icon	Description
	Location information
	Volume
	RAW file
	Print information added to file (p. 103)
	Sound Picture file (p. 45)
	Protected file
100-0001	Folder number - File number
London	Location information
1/40	Shutter speed
F3.5	Aperture value
200	ISO value
0000 1/0 1000	Current file/the total number of files

No.	Description
1	Captured photo
2	RGB histogram (p. 91)
3	Shooting mode, Metering, Flash, White balance, Picture wizard, RAW file, Focus range, Exposure value, Photo size, Date
4	Shutter speed, Aperture value, ISO value, Current file/the total number of files

Icon	Description
	Volume
100-0002	Folder number - File number
00:30	Current playback time
10:00	Total playback time

# Lenses

You can purchase optional lenses made exclusively for your NX series camera. Learn about the functions of each lens and select one that suits your needs and preferences.

## Lens layout

**SAMSUNG 20-50 mm F3.5-5.6 ED lens (example)**

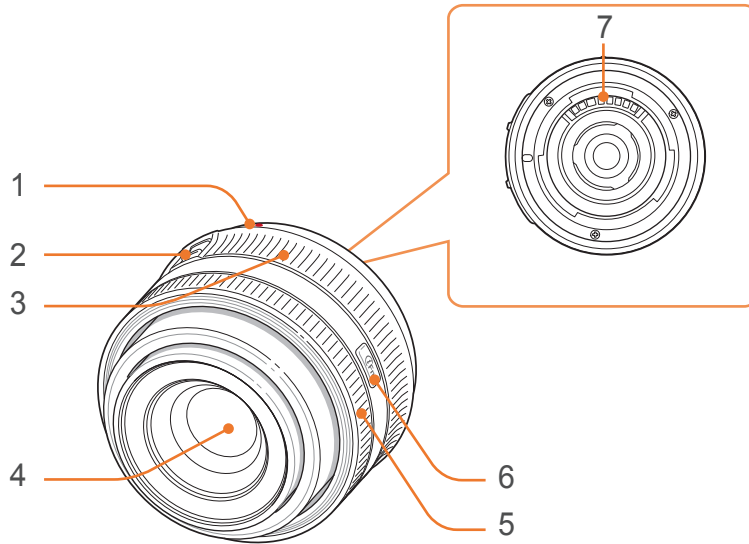

No.	Description
1	Lens mount index
2	Zoom lock switch
3	Zoom ring
4	Lens
5	Focus ring (p. 64)
6	iFn button (p. 43)
7	Lens contacts



### Lock or unlock the lens

To lock the lens, pull and hold the zoom lock switch away from the camera body and rotate the zoom ring clockwise.

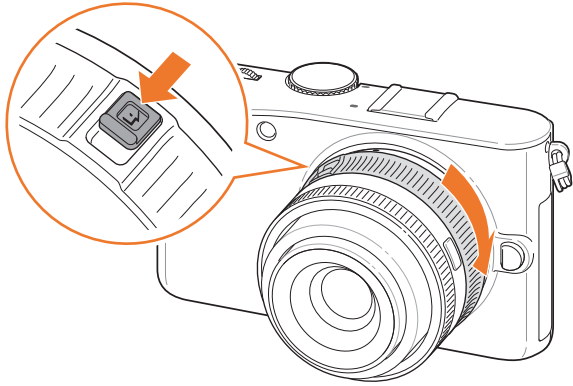

To unlock the lens, rotate the zoom ring counter-clockwise until you hear the click.

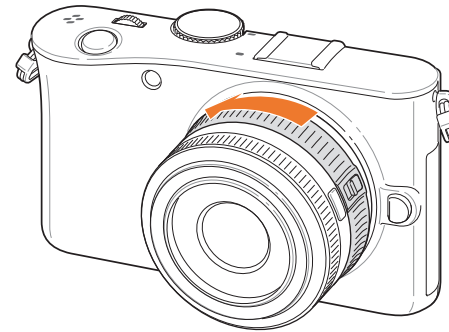

You cannot take a shot when the lens is locked.

SAMSUNG 18-55 mm F3.5-5.6 OIS lens (example)

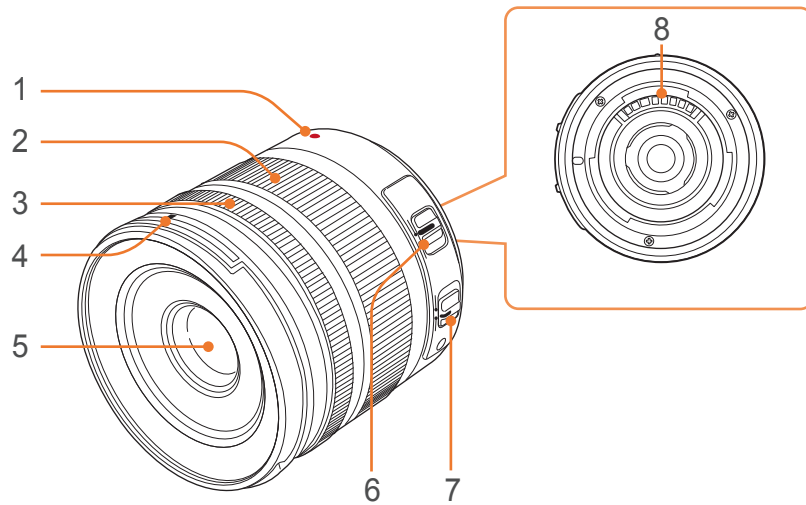

No.	Description
1	Lens mount index
2	Zoom ring
3	Focus ring (p. 64)
4	Lens hood mount index
5	Lens
6	OIS switch (p. 74)
7	AF/MF switch (p. 58)
8	Lens contacts

SAMSUNG 20 mm F2.8 lens (example)

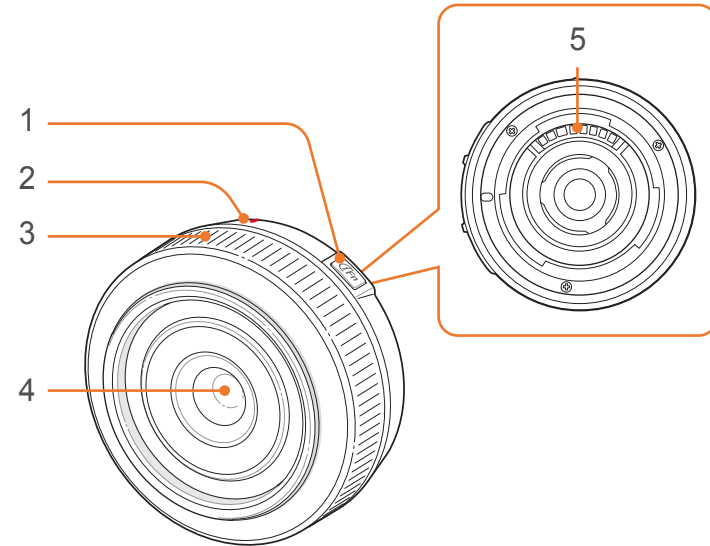

No.	Description
1	iFn button (p. 43)
2	Lens mount index
3	Focus ring (p. 64)
4	Lens
5	Lens contacts

## Lens markings

Find out what the numbers on the lens signify.

### SAMSUNG 50-200 mm F4-5.6 ED OIS lens (example)

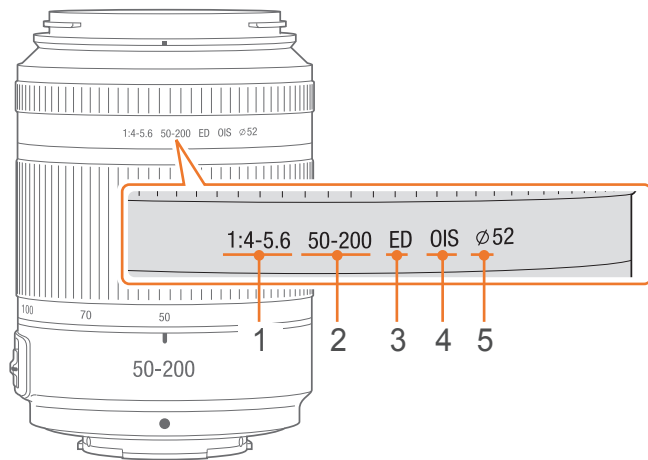

No.	Description
1	<p><b>Aperture value</b></p> <p>A range of supported aperture values. For example, F 1:4-5.6 means the maximum aperture value range from 4 to 5.6.</p>
2	<p><b>Focal length</b></p> <p>The distance from the middle of the lens to its focal point (in millimeters). This figure is expressed in a range: minimum focal length to maximum focal length of the lens.</p> <p>Longer focal lengths result in narrower angles of view and the subject is magnified. Shorter focal lengths result in wider angles of view.</p>
3	<p><b>ED</b></p> <p>ED stands for Extra-low Dispersion. Extra-low dispersion glass is effective in minimizing chromatic aberration (a distortion that occurs when a lens fails to focus all colors to the same convergence point).</p>
4	<p><b>OIS (p. 74)</b></p> <p>Optical Image Stabilization. Lenses with this feature can detect camera shake and effectively cancel out the movement inside the camera.</p>
5	<p><b><math>\phi</math></b></p> <p>The lens diameter. When you attach a filter to the lens, make sure that the diameters of the lens and the filter are the same.</p>

# Optional accessories

You can purchase additional accessories including flash, GPS module, and an electronic viewfinder that can help you take better and more convenient shots.

For more information, refer to the manual for each accessory.



The illustrations below may differ from the actual items.

## Flash layout

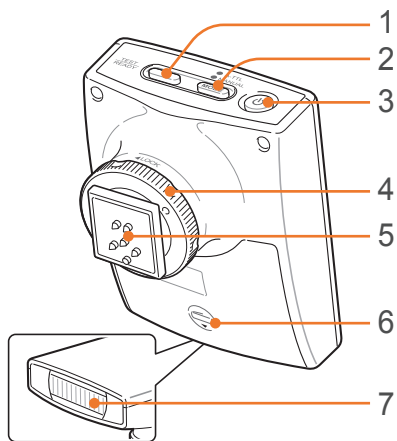

No.	Description
1	READY lamp/Test button
2	[MODE] button
3	Power button
4	Accessory shoe fastening dial
5	Accessory shoe connection
6	Battery cover
7	Bulb

## Connect the flash

- 1 Remove the accessory shoe cover from the camera.

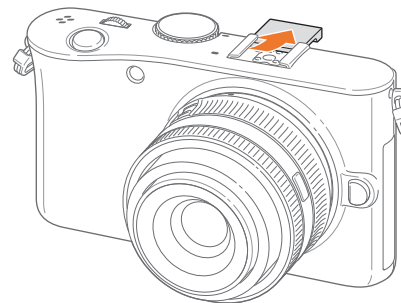

2 Connect the flash by sliding it into the accessory shoe.

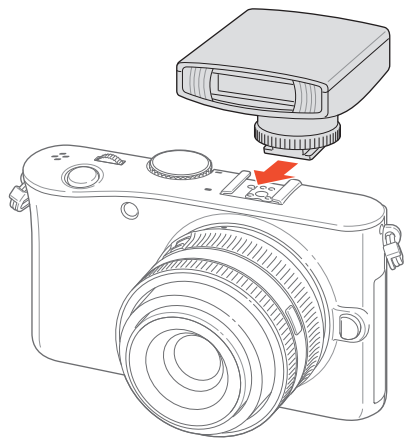

3 Lock the flash into place by turning the accessory shoe fastening dial clockwise towards LOCK.

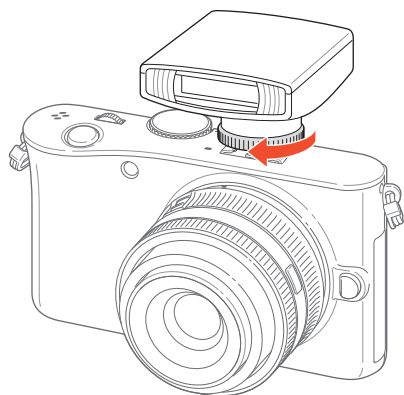

4 Press the power button on the flash.

## GPS module layout

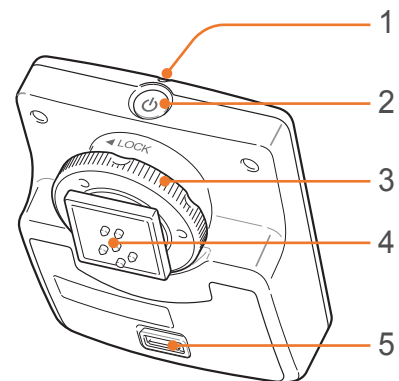

No.	Description
1	Status lamp
2	Power button
3	Accessory shoe fastening dial
4	Accessory shoe connection
5	Battery cover

## Attach the GPS module

- 1 Remove the accessory shoe cover from the camera.

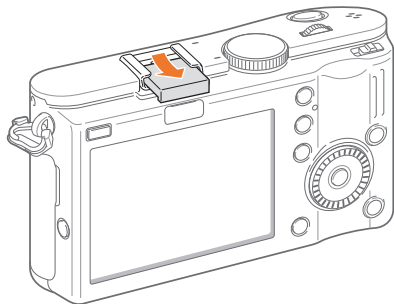

- 2 Mount the GPS module by sliding in into the accessory shoe.

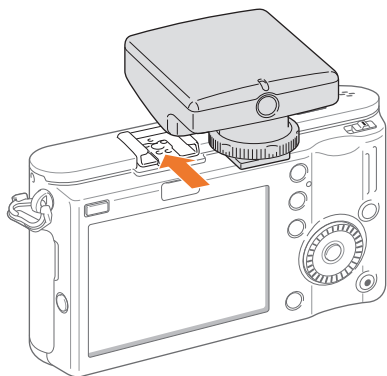

- 3 Lock the GPS module into place by turning the accessory shoe fastening dial clockwise towards LOCK.

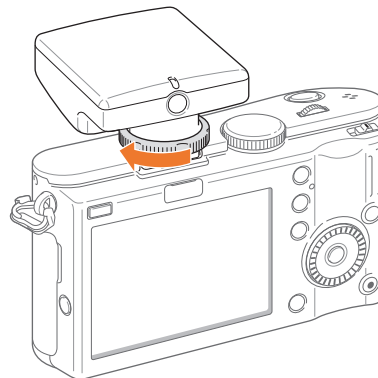

- 4 Press the power button of the GPS module.

## Attach the electronic viewfinder

- 1 Remove the accessory shoe cover and the smart shoe cover on the camera.

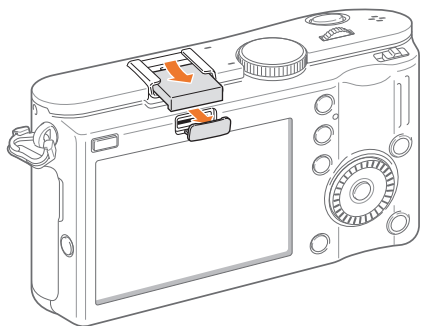

- 2 Mount the electronic viewfinder on the accessory shoe (1) and smart shoe (2) of the camera.

- Take caution not to damage the connector (3).

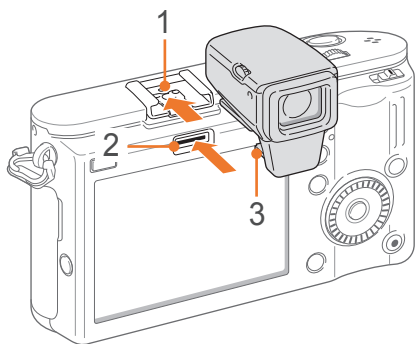

- 3 Press [Power] (1) on the viewfinder and rotate the [Diopter adjustment dial] (2) to adjust the diopter to fit your eyesight.

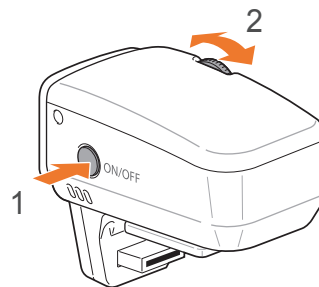

# Shooting modes

Two simple shooting modes—Smart Auto and Scene mode—help you take photos with numerous automatic settings. Additional modes allow for greater customization of settings.



Icon	Description
	Smart Auto mode (p. 39)
<b>P</b>	Program mode (p. 40)
<b>A</b>	Aperture Priority mode (p. 41)
<b>S</b>	Shutter Priority mode (p. 41)
<b>M</b>	Manual mode (p. 42)
	Lens Priority mode (p. 42)
<b>SCENE</b>	Scene mode (p. 45)
	Movie mode (p. 47)

## Smart Auto mode

In Smart Auto mode, the camera recognizes surrounding conditions and automatically adjusts factors that contribute to exposure, including shutter speed, aperture value, metering, white balance, and exposure compensation. As the camera controls most of the functions, some shooting functions are limited. This mode is useful for capturing quick snapshots with the least amount of adjustment.





## P Program mode

The camera automatically adjusts shutter speed and aperture value so that an optimal exposure value can be achieved.

This mode is useful when you want to take shots of constant exposure while being able to adjust other settings.



### Program Shift

Program Shift function lets you adjust the shutter speed and aperture value while the camera maintains the same exposure. When you rotate the jog dial to the left, the shutter speed decreases and the aperture value increases. When you rotate the jog dial to the right, the shutter speed increases and the aperture value decreases.

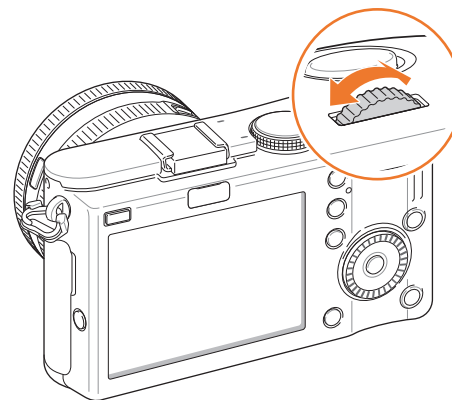

## A Aperture Priority mode

In Aperture Priority mode, the camera automatically calculates shutter speed according to the aperture value you choose. You can adjust the depth of field (DOF) by changing the aperture value. This mode is useful for taking portraits and landscape shots.

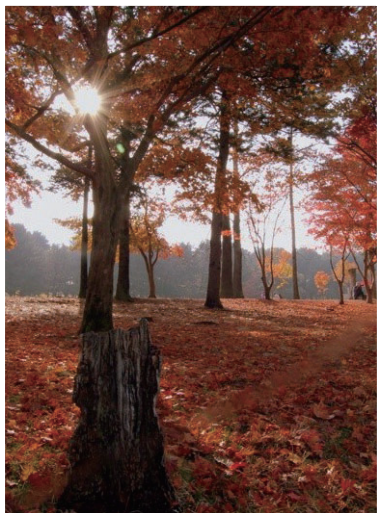

Large Depth of Field

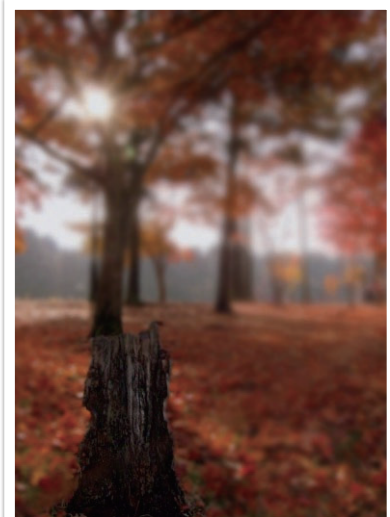

Small Depth of Field



In low-light settings, you may need to increase the ISO sensitivity to prevent blurred photos.

## S Shutter Priority mode

In Shutter Priority mode, the camera automatically adjusts the aperture value according to the shutter speed you choose. This mode is useful for capturing photos of fast-moving subjects or for creating tracer effects in a photo.

For example, set the shutter speed to over 1/500 s to freeze the subject. To make the subject appear blurred set the shutter speed to below 1/30 s.

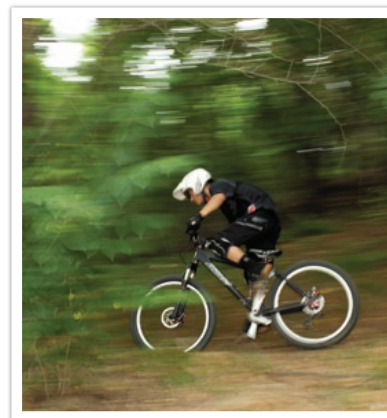

Slow shutter speed

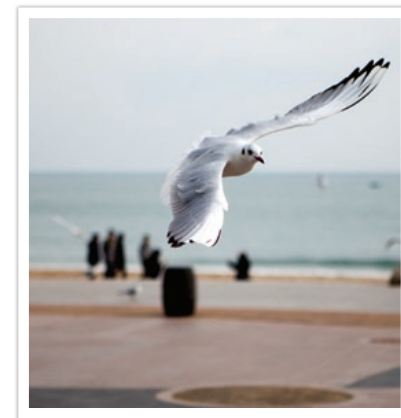

Fast shutter speed



In order to compensate for the reduced amount of light allowed by fast shutter speeds, open the aperture and let in more light. If your photos are still too dark, increase the ISO value.

## M Manual mode

Manual mode lets you adjust the shutter speed and aperture value manually. In this mode, you can fully control the exposure of your photos.

This mode is useful in controlled shooting environments, such as a studio, or when it is necessary to fine-tune camera settings. The Manual mode is also recommended for shooting night scenes or fireworks.

### Framing Mode

When you adjust the aperture value or shutter speed, the exposure changes according to the settings, so the display may darken. With this function on, the brightness of the display is constant regardless of the settings, so you can better frame your shot.

To use Framing Mode,

In Shooting mode, press **[MENU]** ►  ► **Framing Mode** ► **Off** or **On**.

### Use a bulb

Use a bulb to shoot night scenes or the night sky. While you are pressing the shutter button, the shutter is left open so you can create moving light effects.

To use a bulb,

Completely scroll the jog dial to the left to **Bulb**. ► Press and hold **[Shutter]** for the desired time.

## Lens Priority mode

### Use i-Scene mode

You can select an appropriate scene (i-Scene) to the lens you attached. Available scenes may differ depending on the lens you are using.

- 1 Attach an iFn lens.
- 2 Rotate the mode dial to .
- 3 Press **[iFn]**.
  - You can use this function by pressing **[Fn]**.

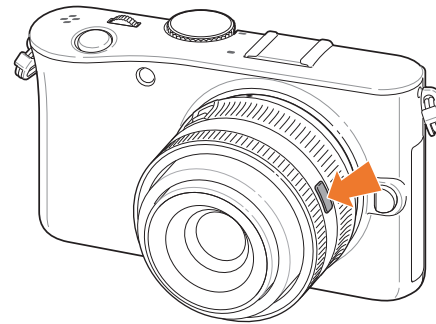

#### 4 Adjust the focus ring to select a scene.

- You can also rotate the navigation button to select a scene.

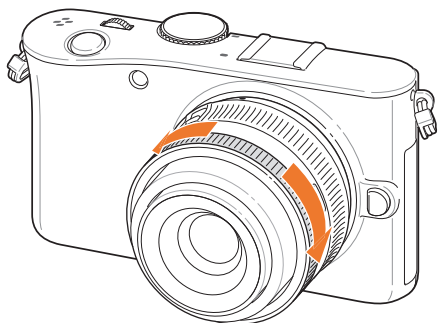

#### 5 Half-press [Shutter] or press [OK] to save.

#### 6 Fully press [Shutter] to take the photo.



Available scene modes (for 20-50 lens) : Beauty Shot, Portrait, Children, Backlight, Landscape, Sunset, Dawn, Beach & Snow, Night

#### Use i-Function in PASM modes

When you use the iFn button on an iFn lens, you can manually select and adjust shutter speed, aperture value, exposure value, ISO sensitivity, and white balance on the lens.

#### 1 Press [iFn] on the lens to select a setting.

- You can also scroll the jog dial to select a setting.

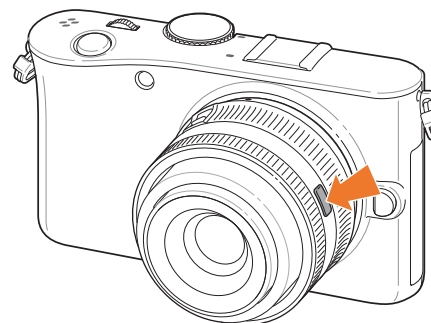

2 Adjust the focus ring to select an option.

- You can also rotate the navigation button to select an option.

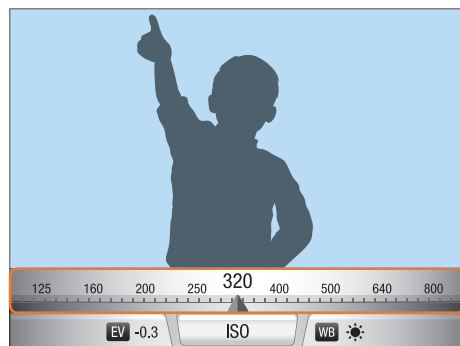
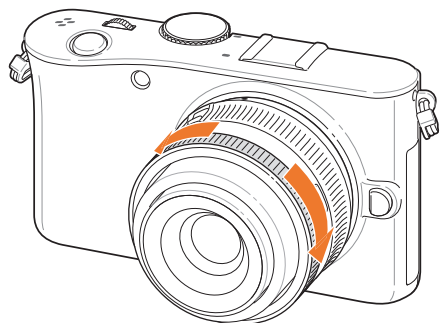

3 Half-press [Shutter] or press [OK] to save.

4 Fully press [Shutter] to take a photo.

Available options

Shooting mode	P	A	S	M
Shutter speed	-	-	○	○
Aperture value	-	○	-	○
Exposure value	○	○	○	-
White balance	○	○	○	○
ISO	○	○	○	○











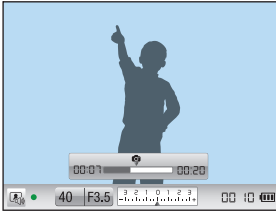



To select items to appear when you press [iFn] on the lens in Shooting mode, press [MENU] ► ► **Lens i-Function** ► an option ► **Off** or **On**.







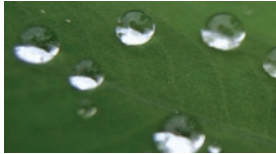

## SCENE Scene mode

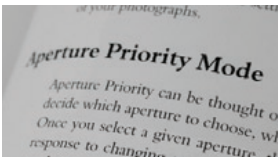



In Scene mode, the camera selects the best settings for each type of scene.

You can select a desired scene by pressing **[Fn]** in Shooting mode.

Option	Description
	<p><b>Sound picture:</b> Add voice memos before and after taking photos.</p> 
	<p><b>Beauty Shot:</b> Hide facial imperfections</p> 
	<p><b>Portrait:</b> Automatically detect and focus on human faces so that you can achieve clear, soft portraits</p> 

Option	Description
	<p><b>Children:</b> Make children appear more noticeable by capturing their clothes and the background vividly</p> 
	<p><b>Sports:</b> Capture fast moving subjects.</p> 
	<p><b>Backlight:</b> Capture backlit subjects</p> 
	<p><b>Close Up:</b> Capture detailed parts of a subject or small subjects, such as flowers or insects</p> 

Option	Description
	<p><b>Text:</b> Clearly capture text from printed or electronic documents</p> 
	<p><b>Landscape:</b> Capture still-life scenes and landscapes</p> 
	<p><b>Sunset:</b> Capture scenes at sunset, with natural-looking reds and yellows</p> 
	<p><b>Dawn:</b> Capture scenes at sunrise</p> 
	<p><b>Beach &amp; Snow:</b> Reduce underexposed photos due to sunlight reflected from sand or snow</p> 

Option	Description
	<p><b>Night:</b> Capture scenes at night or in low lighting</p> 
	<p><b>Fireworks:</b> Capture colorful fireworks at night</p> 

## Movie mode

In Movie mode, you can shoot videos in High Definition (1280x720) and capture sound via the camera's microphone.

In order to adjust the exposure level, you can select **Program** in the **Movie AE Mode** options menu so that the aperture value can be automatically set or select **Aperture Priority** to manually set the aperture value. While shooting a video, press [**Depth Preview**] once to activate the AF function.

Select **Fader** in the **Movie AE Mode** options menu to fade in or out a scene. You can also select **Wind Cut** to prevent some surrounding noise from being recorded and select **Voice** to mute or un-mute voice.

The camera lets you capture video files up to 25 minutes in length and saves the files in MP4(H.264) format.





















- H.264 (MPEG-4 part10/AVC) is the latest video coding format established in 2003 collaboratively by ISO-IEC and ITU-T. Since this format uses a high compression rate, more data can be saved in less memory space.
- If you have the image stabilizer option on when shooting a movie, the camera may record the image stabilizer sound.
- The zoom sound may be recorded if you use the zoom while recording a video.
- If you remove the camera lens while recording a movie, the recording will be interrupted. Do not change the lens while recording.
- If you change the shooting angle of the camera suddenly while shooting a movie, the camera may not be able to record images accurately. Use a tripod to minimize camera shake.
- In Movie mode, the camera supports only the Multi AF function. You cannot use any other focus area setting functions, such as Face Detection AF.
- When the size of a movie file exceeds 4GB, the camera automatically stops recording. If this occurs, continue shooting by starting a new movie file.
- If you use a slow writing memory card, the recording of your movie can be interrupted because the card cannot process data at the rate the video is being shot. If this occurs, replace the card with a faster memory card or reduce the image size (for example, from 1280x720 to 640x480).
- When formatting a memory card, always format using the camera. If you format on another camera or a PC, you can lose files on the card or cause a change in the capacity of the card.



## Available functions by shooting mode

For details about shooting functions, see Chapter 2.

Function	Available in
Size (p. 50)	<b>P/A/S/M/i/SCENE/</b>  */  SMART
Quality (p. 51)	<b>P/A/S/M/i/SCENE*/</b> 
ISO (p. 52)	<b>P/A/S/M</b>
White Balance (p. 53)	<b>P/A/S/M/</b> 
Picture Wizard (p. 56)	<b>P/A/S/M/</b> 
Color Space (p. 57)	<b>P/A/S/M/i/SCENE/</b> 
AF Mode (p. 58)	<b>P/A/S/M/i/SCENE/</b>  *
AF Area (p. 60)	<b>P/A/S/M/i/SCENE*</b>
AF Priority (p. 63)	<b>P/A/S/M</b>
MF Assist (p. 64)	<b>P/A/S/M/i/SCENE/</b>  /  SMART
Drive (Continuous/Burst/Timer/BKT) (p. 65)	<b>P/A/S/M/i*/SCENE*/</b>  */  SMART*
Flash (p. 69)	<b>P/A/S/M/i/SCENE*/</b> 
Smart Range (p. 73)	<b>P/A/S/M</b>
Metering (p. 71)	<b>P/A/S/M/</b> 
OIS (p. 74)	<b>P/A/S/M/</b> 
AF Lamp (p. 90)	<b>P/A/S/M/i/SCENE/</b>  / 
Exposure compensation (p. 75)	<b>P/A/S/i/SCENE/</b> 

Function	Available in
Exposure/focus lock (p. 76)	<b>P/A/S/</b> 
Noise Reduction (p. 90)	<b>P/A/S/M</b>

\* Some functions are limited in these modes.





## Chapter 2

# Shooting Functions

---

Learn about the functions you can set in Shooting mode.  
You can enjoy more customized photos and videos by using the shooting functions.

# Size

As you increase the resolution, your photo or video will include more pixels, so it can be printed on larger paper or displayed on a larger screen. When you use a high resolution, the file size will also increase. Select a low resolution for photos that will be displayed in a digital picture frame or uploaded to the web.



To set the size,

In Shooting mode, press **[Fn]** ► **Photo Size** or **Movie Size** ► an option.

## Photo size options

Icon	Size	Recommended for
14M	14M 4592X3056 (3:2)	Printing on A1 paper.
10M	10M 3872X2592 (3:2)	Printing on A2 paper.
6M	6M 3008X2000 (3:2)	Printing on A3 paper.
2M	2M 1920X1280 (3:2)	Printing on A5 paper.

Icon	Size	Recommended for
12M	12M 4592X2584 (16:9)	Printing on A1 paper or viewing on an HDTV.
8M	8M 3872X2176 (16:9)	Printing on A3 paper or viewing on an HDTV.
5M	5M 3008X1688 (16:9)	Printing on A4 paper or viewing on an HDTV.
2M	2M 1920X1080 (16:9)	Printing on A5 paper or viewing on an HDTV.
9M <sub>(1:1)</sub>	9M 3056X3056 (1:1)	Printing a square photo on A2 paper.
6.7M <sub>(1:1)</sub>	6.7M 2592X2592 (1:1)	Printing a square photo on A3 paper.
4M <sub>(1:1)</sub>	4M 2000X2000 (1:1)	Printing a square photo on A4 paper.
1.6M <sub>(1:1)</sub>	1.6M 1280X1280 (1:1)	Printing a square photo on A5 paper.

## Video size options

Icon	Size	Recommended for
1280	1280 (16:9)	Viewing on an HDTV.
640	640 (4:3)	Viewing on a TV.
320	320 (4:3)	Uploading on the web.

# Quality

The camera saves photos in either the JPEG or RAW format.

Photos captured by a camera are often transformed to the JPEG format and stored in the memory according to the settings of the camera at the time of shooting. RAW files are not transformed to the JPEG format and are stored in the memory without any changes.





RAW files have the file extension “SRW”. To adjust and calibrate exposures, white balances, tones, contrasts, and colors of the RAW files, or to convert them into JPEG or TIFF format, use the Samsung RAW Converter program found on the supplied CD-ROM. Ensure you have enough available memory to save photos in the RAW format.

To set the quality,



In Shooting mode, press [Fn] ► **Quality** ► an option.

## Photo quality options

Option	Format	Description
	JPEG	<b>Super Fine:</b> <ul style="list-style-type: none"> <li>Compressed for the best quality.</li> <li>Recommended for printing in large size.</li> </ul>
	JPEG	<b>Fine:</b> <ul style="list-style-type: none"> <li>Compressed for better quality.</li> <li>Recommended for printing in normal size.</li> </ul>

Option	Format	Description
	JPEG	<b>Normal:</b> <ul style="list-style-type: none"> <li>Compressed for normal quality.</li> <li>Recommended for printing in small size or uploading to the web.</li> </ul>
	RAW	<b>RAW:</b> <ul style="list-style-type: none"> <li>Save a photo without data loss.</li> <li>Recommended for editing after shooting.</li> </ul>
	RAW+JPEG	<b>RAW + S.Fine:</b> Save a photo in both the JPEG (S.Fine quality) and RAW format .
	RAW+JPEG	<b>RAW + Fine:</b> Save a photo in both the JPEG (Fine quality) and RAW format.
	RAW+JPEG	<b>RAW + Normal:</b> Save a photo in both the JPEG (Normal quality) and RAW format.

## Video quality options

Option	Extension	Description
	MP4(H.264)	<b>Normal:</b> Record videos in normal quality.
	MP4(H.264)	<b>HQ:</b> Record videos in high quality.

# ISO sensitivity

The ISO sensitivity value represents the sensitivity of camera to light.

The larger the ISO value, the more sensitive the camera is to light. Consequently, by selecting a higher ISO sensitivity value, you can take photos in dim or dark places at faster shutter speeds. However, this may increase electronic noise and result in a grainy photo.

To set ISO sensitivity,

In Shooting mode, press **[ISO]** ► an option.

## Expand ISO value

You can select higher ISO values up to ISO 6400.

To expand ISO value,

In Shooting mode, press **[MENU]** ►  ► ISO Expansion ► On.

## Examples

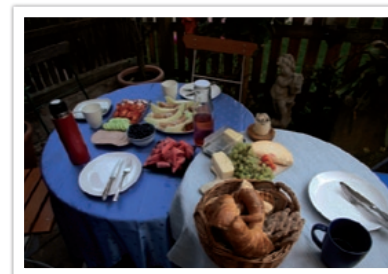

ISO 100

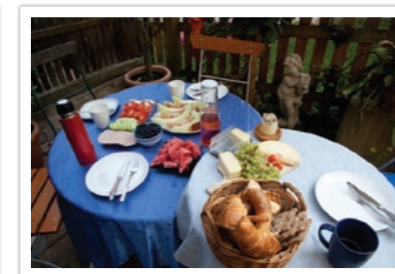

ISO 400



ISO 800



ISO 3200



- Increase the ISO value in places where flash use is prohibited. You can take a clear photo by setting a high ISO value without having to secure more light.
- Use the Noise Reduction function in order to reduce the visual noise that can appear on photos of a high ISO value over 3200. (p. 90)





# White Balance (light source)





The color of a photo depends on the type and quality of the light source. If you want the color of your photo to be realistic, select an appropriate lighting condition to calibrate the white balance, such as **Auto WB**, **Daylight**, **Cloudy**, or **Tungsten**, or adjust color temperature manually. You can also adjust color for the preset light sources so that the colors of the photo match the actual scene under mixed lighting conditions.

To set the white balance,

In Shooting mode, press **[WB]** ► an option.

## White balance options

Option	Description
	<b>Auto WB</b> *: Use automatic settings depending on the lighting conditions.
	<b>Daylight</b> *: Select when taking outdoor photos on a sunny day. This option results in photos closest to the natural colors of the scene.
	<b>Cloudy</b> *: Select when taking outdoor photos on a cloudy day or in shadows. Photos taken on cloudy days tend to be more bluish than on sunny days. This option offsets that effect.
	<b>Fluorescent White</b> *: Select when shooting under a daylight fluorescent lamp. Especially for white fluorescent light with a color temperature of about 4200K.

Option	Description
	<b>Fluorescent NW</b> *: Select when shooting under a daylight fluorescent lamp. Especially for white fluorescent light of very white hues with a temperature of about 5000K.
	<b>Fluorescent Daylight</b> *: Select when shooting under a daylight fluorescent lamp. Especially for white fluorescent light of slightly bluish hue with a temperature of about 6500K.
	<b>Tungsten</b> *: Select when taking indoor photos under incandescent bulbs or halogen lamps. Incandescent tungsten bulbs tend to have a reddish hue. This option offsets that effect.
	<b>Flash WB</b> *: Select when using an optional flash.
	<b>Custom Set:</b> Use your pre-defined settings. You can manually set the white balance by shooting a white sheet of paper. Fill the spot metering circle with the paper and set the white balance.

\* These options can be customized.

Option	Description
<b>K</b>	<p><b>Color Temp.:</b>                      Manually adjust the color temperature of the light source. Color temperature is a measurement in degrees Kelvin that indicates the specific type of light source. As the color temperature increases, the color distribution becomes cooler. Alternatively, as the color temperature decreases, the color distribution becomes warmer.</p>
	<p>10,000 K — Clear sky</p>
	<p>8,000 K — Fluorescent_H</p>
	<p>6,000 K — Cloudy</p>
	<p>5,000 K — Daylight</p>
	<p>4,000 K — Fluorescent_L</p>
	<p>3,000 K — Halogen lamp</p>
	<p>          — Tungsten</p>
	<p>2,000 K — Candle light</p>

### Customize preset options

You can also customize preset white balance options. In Shooting mode, press [MENU] ► or ► **White Balance** ► an option, and then press [Fn].

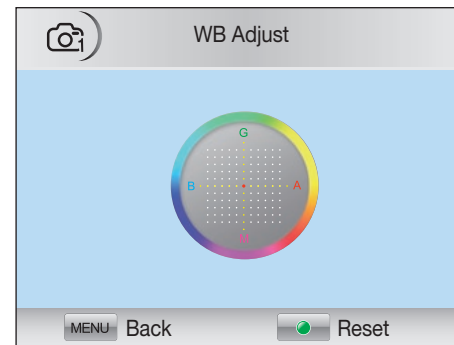

## Examples



Auto WB



Daylight



Fluorescent Daylight

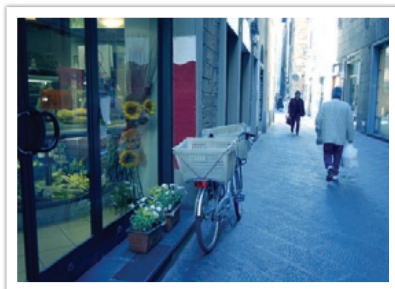

Tungsten





# Picture Wizard (photo styles)

Picture Wizard lets you apply different photo styles to your photo to create various looks and emotional moods. You can also create and save your own photo styles by adjusting color, saturation, sharpness, and contrast for each style.

There is no rule for which style is suitable in which conditions. Experiment with different styles and find your own settings.

To set a photo style,

In Shooting mode, press **[Fn]** ► **Picture Wizard** ► an option.

## Examples



Standard



Vivid



Portrait



Landscape



Forest



Retro



Cool



Calm



Classic



You can also adjust the value of the preset style settings. Select a Picture Wizard option, press **[AF-MF]** and adjust color, saturation, sharpness, or contrast.

# Color Space

Digital imaging devices such as digital cameras, monitors, and printers have their own methods for representing colors, which are called color spaces.

Your camera lets you select two color spaces: **sRGB** or **Adobe RGB**.

sRGB is widely used for creating colors on PC monitors and is also the standard color space for Exif. sRGB is recommended for regular images and images you intend to publish on the Internet.

Adobe RGB is used for commercial printing and has a larger color range than sRGB. Its wider range of colors helps you to easily edit photos on a computer. Note that individual programs are generally compatible with a limited number of color spaces. If you open an image in a program that is not compatible with the image's color space, the colors will appear lighter.

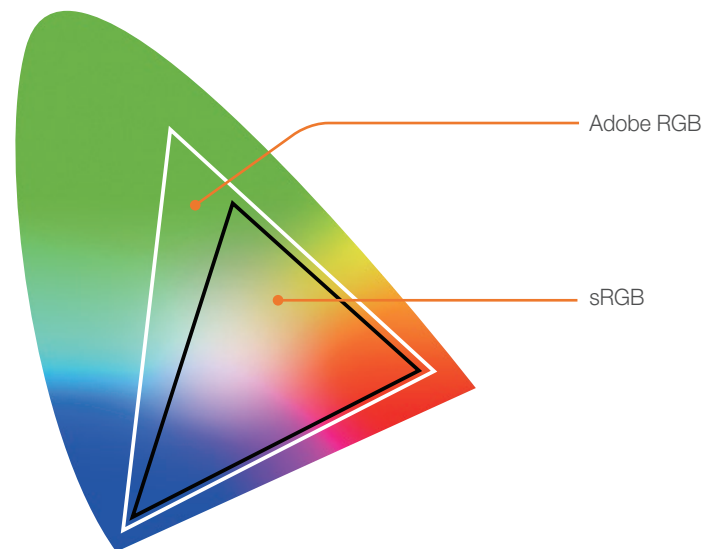

To set the color space,

In Shooting mode, press [MENU] ►  ► Color Space ► an option.

# AF Mode

Learn how to adjust the camera's focus according to the subjects.

You can select a focusing mode appropriate to the subject among Single Auto Focus, Continuous Auto Focus, and Manual Focus. The AF function is activated when you press **[Shutter]** halfway. In the MF mode, you have to rotate the focus ring on the lens to focus manually.

In most cases, you can have a focus by selecting **Single AF**. Fast moving subjects or subjects of a color similar to the background are difficult to focus. Select an appropriate focusing mode for such instances.

If your lens has an AF/MF switch, set the switch to MF to adjust the focus manually. When your lens has no AF/MF switch, press **[AF·MF]** to select a desired AF mode.

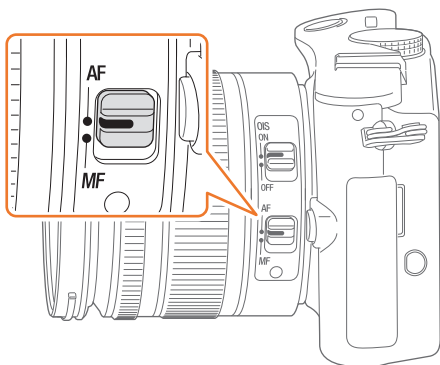

To set the auto focus mode,

In Shooting mode, press **[AF·MF]** ► an option.

## Single AF

Single AF is appropriate for shooting a still subject. When you press **[Shutter]** halfway, the focus fixes in the focus area. The area turns green when the focus is achieved.



## Continuous AF

While you are pressing [**Shutter**] halfway, the camera continues to automatic focusing. Once the focus area is fixed on the subject, the subject is always in focus even when moving. This mode is recommended for shooting a person on a bicycle, a running dog, or a car racing scene.

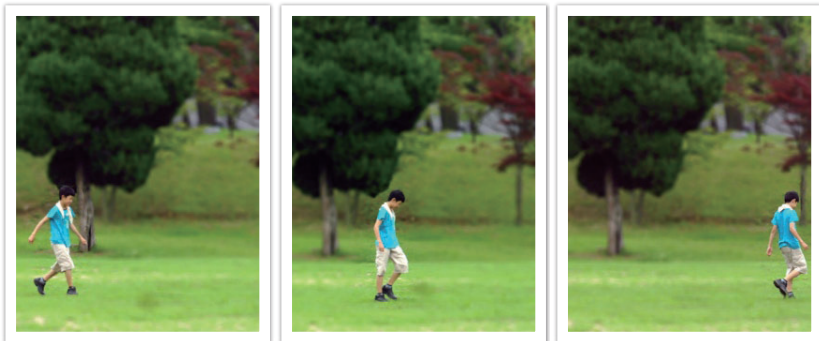

## Manual Focus

You can manually focus on a subject by rotating the focus ring on the lens. The MF Assist function lets you easily achieve a focus. While you are rotating the focus ring, the focus area is magnified or the focus aid bar appears to help you achieve a clear focus. This mode is recommended for shooting an object similar in color to the background, a night scene, or fireworks.



# AF Area

The AF area function changes the positions of the focus area.

Generally, cameras focus on the nearest subject. When there are a lot of subjects, however, unwanted subjects can be in focus. In order to prevent unwanted subjects from being in focus, change the focus area so that a desired subject is in focus. You can get a clearer and sharper photo by selecting an appropriate focus area.

To set the auto focus area,

In Shooting mode, press **[Fn]** ► **AF Area** ► an option.

## Selection AF

You can set the focus on an area you want. Apply an out-of-focus effect to make the subject more distinguishable.

The focus on the photo below was repositioned and resized so that it fits the subject's face.

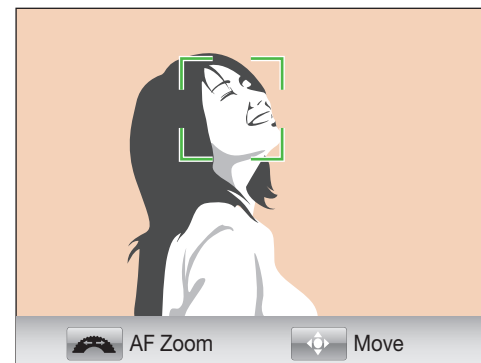

To resize or move the focus area, in Shooting mode, press **[OK]**.

## Multi AF

The camera displays a green rectangle in places where focus is set correctly. The photo is divided into two or more areas, and the camera obtains focus points of each area. It is recommended for scenery photos.

When you press [**Shutter**], the camera displays the focus areas in green as shown in the photo below.

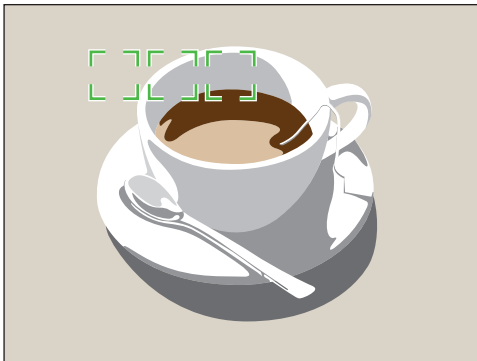

## Face Detection AF

The camera focuses on human faces preferentially. Faces of up to 10 people can be detected. This setting is recommended for shooting a group of people.

When you press [**Shutter**] halfway, the camera focuses on faces as shown in the photo below. In cases of shooting a group of people, the camera displays the focus on the nearest person's face in white and the rest of the people's faces in gray.

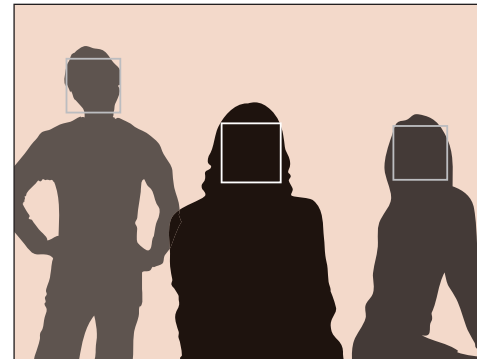

## Self-Portrait AF

It can be difficult to check whether your face is in focus when you are taking a self-portrait. When this function is on, the focus distance is set to close-up and the beep from the camera gets faster when in focus.

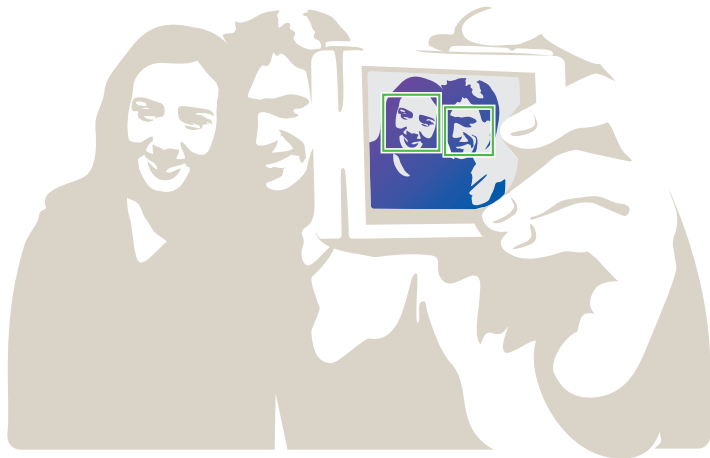

# AF Priority

The camera takes a shot only if the focus is set correctly when you press **[Shutter]**.

Turn on this function to always get a properly focused photo. Turn it off to take a photo regardless of focus.

To set the focus priority,

In Shooting mode, press **[MENU]** ►  ► **AF Priority** ► an option.





# MF Assist

In the manual focus (MF) mode, you have to rotate the focus ring on the lens to focus manually. When you set the MF Assist function, you can achieve a clearer focus. This function is only available on a lens that supports manual focus.

To set the manual focus assist,

In Shooting mode, press [MENU] ►  or  ► MF Assist ► an option.

\* Default

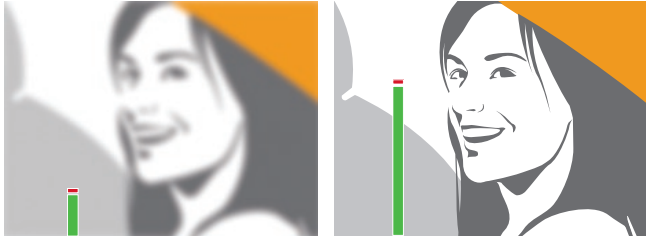
Option	Description
Off	Do not use the function.
Enlarge*	<p>The focus area is magnified when you rotate the focus ring.</p> 
FA	<p>The focus aid bar rises as the focus improves, when you rotate the focus ring.</p> 

# Drive (shooting method)

You can set the shooting method such as **Continuous**, **Burst**, **Timer** and so on.

Select **Single** to capture one photo at a time. Select **Continuous** or **Burst** to shoot fast moving subjects. Select **AE BKT**, **WB BKT** or **P Wiz BKT** to adjust exposure, white balance, or apply **Picture Wizard** effects. You can also select **Timer** to take a photo of yourself.

To set the shooting method,

In Shooting mode, press  ► an option.

## Single

Capture one photo whenever you press [**Shutter**]. Recommended for general conditions.

## Continuous

Continuously capture photos while you are pressing [**Shutter**]. You can take up to 3 shots per second.



## Burst

Consecutively capture up to 10 shots per second (3 seconds), 15 shots per second (2 seconds), or 30 shots per second (1 second) when you press [**Shutter**] once. Recommended for shooting the rapid motion of fast moving subjects such as racing cars.



To set the number of shots, press [**MENU**] ►  ► Drive ► **Burst**, and then press [**Fn**].

## Timer

Capture a photo with a delay of 2 to 30 seconds. The delay is adjustable in increments of 1 second.

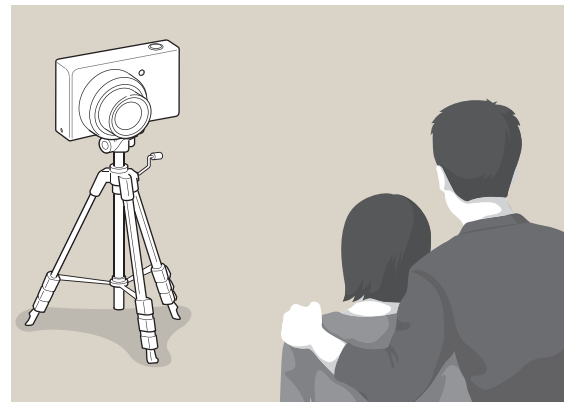

To set the delay, press [**MENU**] ►  ► Drive ► **Timer**, and then press [**Fn**].

## AE BKT

When you press [**Shutter**], the camera takes 3 consecutive shots: the original, one a step darker, and one a step lighter. Use a tripod to prevent blurry photos as the camera takes three shots continuously. You can adjust the settings in **BKT Set** menu.



## WB BKT

When you press [**Shutter**], the camera takes 3 consecutive shots: the original and two more with different white balance settings. The original photo is taken when you press [**Shutter**]. The other two are automatically adjusted according to the white balance you have set. You can adjust the settings in **BKT Set** menu.



## P Wiz BKT

When you press [**Shutter**], the camera takes three consecutive shots, each with a different Picture Wizard setting. The camera takes a shot and applies the three Picture Wizard options you have set to the image taken. You can select three different settings in **BKT Set** menu.

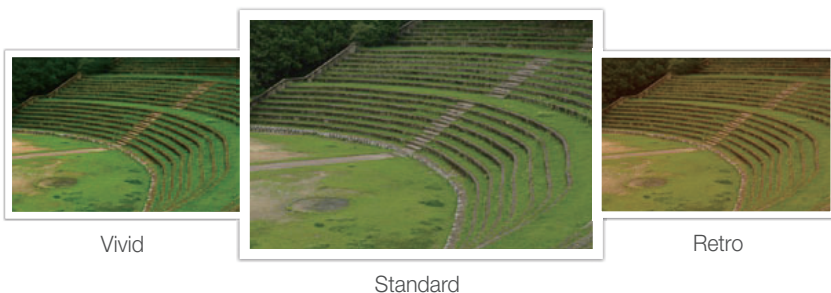

## BKT Set

You can set up the options for **AE BKT**, **WB BKT**, **P Wiz BKT**.

To set a bracketing option,

In Shooting mode, press [**MENU**] ► ► **BKT Set** ► an option.

Option	Description
AE BKT Set	Set the order and the area of bracket. <ul style="list-style-type: none"> <li>• <b>BKT Order:</b> Set the order in which the camera takes the original, lighter, and darker shot (represented by 0, +, and -).</li> <li>• <b>BKT Area:</b> Set the exposure range of the 3 AE BKT shots.</li> </ul>
WB BKT Set	Adjust the white balance interval range of the 3 WB BKT shots. For example, AB-/ +3 adjusts the Amber value plus or minus three steps. MG-/ +3 adjusts the Magenta value the same amount.
P Wiz BKT Set	Select 3 Picture Wizard settings the camera uses to take the 3 P Wiz BKT shots.







# Flash



In order to take a realistic photo of a subject, the amount of light should be constant. When the light source varies, you can use an optional flash and supply a constant amount of light. Select appropriate settings according to a light source and a subject.

To set flash options,

In Shooting mode, press [MENU] ►  ► Flash ► an option.

## Flash options

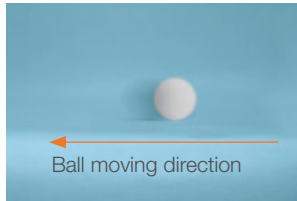
Option	Description
	<b>Off:</b> Do not use the flash.
	<b>Smart Flash:</b> The camera automatically adjusts the brightness of the flash according to the amount of light in the surrounding environment.
	<b>Auto:</b> The flash automatically fires in dark places.
	<b>Auto + Red:</b> The flash automatically fires and prevents red-eyes.
	<b>Fill in:</b> The flash fires whenever you take a photo.
	<b>Fill-in Red:</b> The flash fires whenever you take a photo and prevents red-eyes.

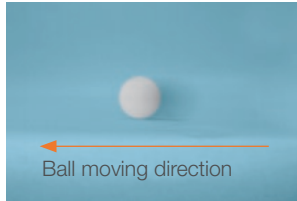
Option	Description
	<p><b>1st Curtain:</b> The flash fires immediately after the shutter opens. The camera captures a photo of a subject earlier in an action sequence clearly.</p> 
	<p><b>2nd Curtain:</b> The flash fires just before the shutter closes. The camera captures a photo of a subject later in an action sequence clearly.</p> 



- The options may differ depending on the shooting mode.
- There is an interval between two bursts of the flash. Do not move until the flash fires a second time.
- You can use the flash and adjust the amount of light only when you use the NX exclusive external flash.



Use only Samsung-approved flashes. Using incompatible flashes may damage your camera.

## Correct the red-eye effect

If the flash fires when you take a photo of a person in the dark, a red glow may appear in the eyes. To prevent this, select **Fill-in Red**.



Without red-eye correction



With red-eye correction

## Adjust the flash intensity

Adjust the flash intensity to avoid overexposure or underexposure. You can adjust it by  $\pm 2$  levels. Press **[Fn]** to set the intensity.

To set the flash intensity,

In Shooting mode, press **[MENU]** ►  ► **Flash** ► an option ► **[Fn]**.

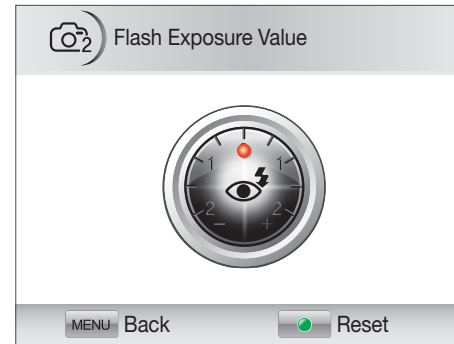

# Metering

The metering mode refers to the way in which a camera measures the quantity of light.

The camera measures the amount of light in a scene, and in many of its modes, uses the measurement to adjust various settings. For example, if a subject looks darker than its actual color, the camera takes an overexposed photo of it. If a subject looks lighter than its actual color, the camera takes an underexposed photo of it.

The brightness and overall mood of the photo can also be affected by how the camera measures the amount of light. Select an appropriate setting for a shooting condition.

To set a metering option,

In Shooting mode, press **[Fn]** ► **Metering** ► an option.

## Spot

The Spot mode calculates the amount of light in the center. When you take a photo in conditions where there is a strong backlight behind a subject, the camera adjusts the exposure so as to shoot a subject correctly. For example, when you select the Multi mode in a strong backlight condition, the camera calculates that the overall amount of light is abundant, which results in a darker photo. The Spot mode can prevent this situation as it calculates the amount of light in a designated area.

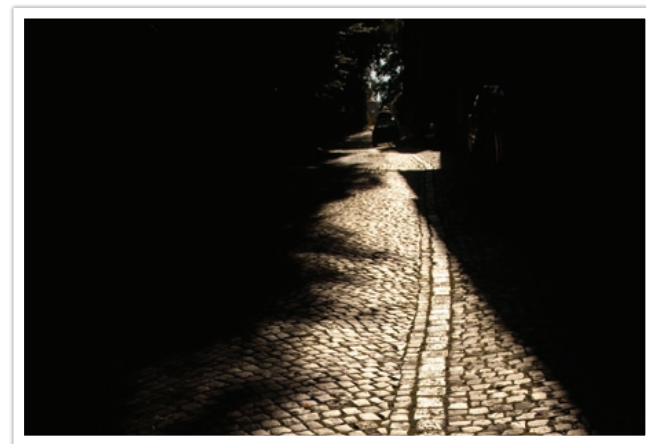

The subject is in bright color while the background is dark. The Spot mode is recommended for a situation like this where a huge difference in the exposure exists between a subject and a background.

### Link AE to AF Point

When this function is turned on, the camera automatically sets an optimal exposure by calculating the brightness of the focus area. This function is only available when you select either Spot metering or Multi metering, and Selection AF.

To set this function,

In Shooting mode, press **[MENU]** ► ► **Link AE to AF Point** ► an option.



## Center-weighted

The Center-weighted mode calculates a broader area than the Spot mode does. It sums up the amount of light in the center portion of the shot (60 ~ 80%) and that of the rest of the shot (20 ~ 40%). It is recommended for situations where there is a slight difference in brightness between a subject and a background or an area of the subject is large compared to the overall composition of the photo.



## Multi

The Multi mode calculates the amount of light in multiple areas. When light is sufficient or insufficient, the camera adjusts the exposure by averaging the overall brightness of the scene. This mode is suitable for general photos.



# Smart Range

This function automatically corrects the loss of bright detail that can occur due to shading differences in the photo.



Without Smart Range effect



With Smart Range effect

To set Smart Range options,

In Shooting mode, press **[Fn]** ► **Smart Range** ► an option.



# OIS

Use the Optical Image Stabilization (OIS) function to minimize camera shake. OIS may not be available with some lenses.

Camera shake tends to occur in dark places or when shooting indoors. In such cases, the camera uses slower shutter speeds in order to increase the amount of light taken in, which can result in a blurry photo. You can prevent this situation by turning on the OIS switch.

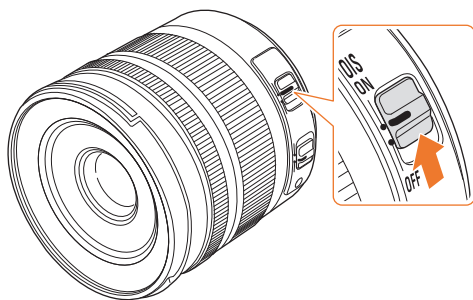

This function is only available when your lens has an OIS switch and you have turned the switch.



To set OIS options,

In Shooting mode, press [Fn] ► OIS ► an option.

## OIS options

Option	Description
	<b>Mode 1:</b> The OIS function is applied only when you press the shutter in full or half.
	<b>Mode 2:</b> The OIS function is always on.

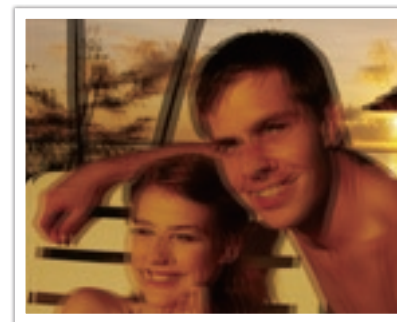

Without OIS correction

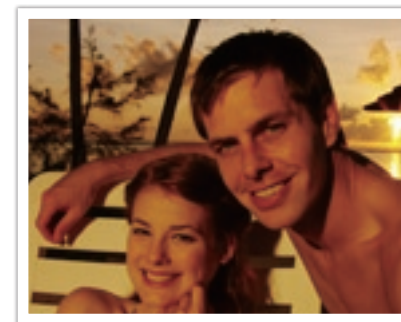

With OIS correction

# Exposure Compensation

The camera automatically sets the exposure by measuring the levels of light from the photo's composition and the position of a subject. If the exposure set by the camera is higher or lower than you expected, you can adjust the exposure value manually. The exposure value is adjustable in  $\pm 3$  increments. The camera displays the exposure warning in red for each step beyond  $\pm 3$  range.

To adjust the exposure value, hold down  $\left[ \begin{array}{|c|} \hline + \\ \hline \end{array} \right]$  and scroll left or right on the jog dial.

You can check the exposure value by the position of the exposure level indicator.

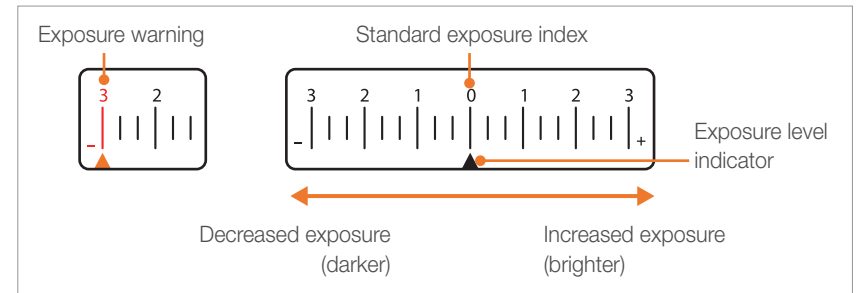

# Exposure/Focus Lock

When you cannot achieve an appropriate exposure because of a strong color contrast or you want to take a photo on which the subject is out of the auto focus area, lock the focus or exposure and then take a photo.

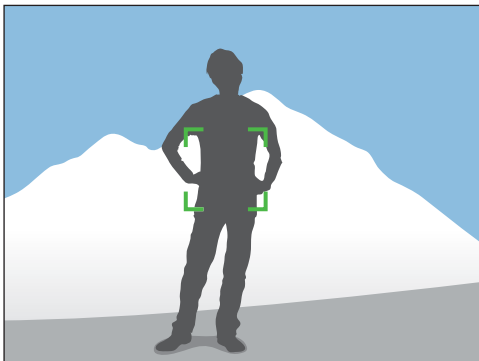

To lock the exposure or focus, adjust the photo's composition on which you want to focus or calculate the exposure, and then press **[AEL]**.

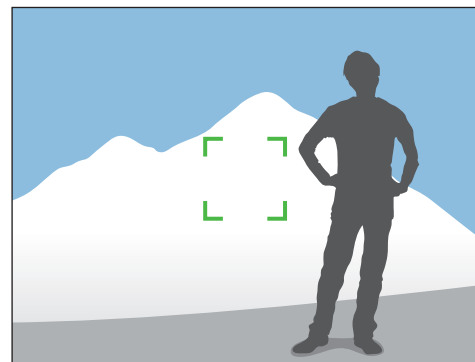

After locking the exposure or focus, aim the lens where you desire, and press **[Shutter]**.



You can change the function assigned to the button to focus lock, or both of them. A function executed by half-pressing **[Shutter]** varies according to the function assigned to **[AEL]**. (p. 92)

# Video functions

The functions available for video are explained below.

## Movie AE Mode

Set the aperture value for shooting a movie.

To set movie aperture options,

In Shooting mode, press **[Fn]** ► **Movie AE Mode** ► an option.





Option	Description
<b>P</b>	<b>Program:</b> The aperture value is adjusted automatically.
<b>A</b>	<b>Aperture Priority:</b> Set the aperture value manually before recording a video. Rotate the navigation button to adjust the aperture value.

## Fader

You can fade in or fade out a scene using the fader function on the camera without having to do it on a PC. Use the function appropriately and add dramatic effects on your videos.

To set fader options,

In Shooting mode, press **[Fn]** ► **Fader** ► an option.

Option	Description
	<b>Off:</b> Fader function not used.
	<b>In:</b> Scene gradually fades in.
	<b>Out:</b> Scene gradually fades out.
	<b>In-out:</b> The fader function is applied at the start and end of the scene.

## Wind Cut

When you record videos in noisy environments, unintended sounds can be recorded in videos. In particular, severe wind noise recorded in videos distracts you from enjoying your videos. Use the Wind Cut function to remove some surrounding noise in addition to wind noise.

To set Wind Cut options,

In Shooting mode, press [MENU] ►  ► Wind Cut ► an option.

## Auto Focus

While recording a movie, press [Depth Preview] once to activate the AF function and once again to cancel the function. This function may not work depending on the lens you are using.

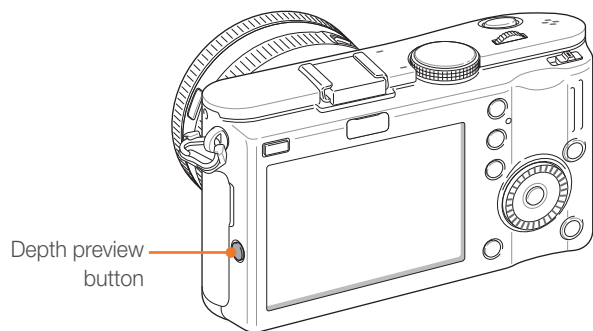

## Voice

Sometimes, a muted video is more appealing than the one with sound. Turn the voice off to record a muted video.

To set voice options,

In Shooting mode, press [Fn] ► Voice ► an option.





## Chapter 3

# Playback/Editing

---

Learn about how to play back and edit photos and videos.  
Refer to chapter 5 for editing files on a PC.



# Search and manage files

Learn how to search photos and videos quickly through the thumbnail view and to protect and delete files.

## View photos

- 1 Press [▶].
  - The most recent file you captured will be displayed.
- 2 Rotate the navigation button or press [📁/WB] to scroll through files.

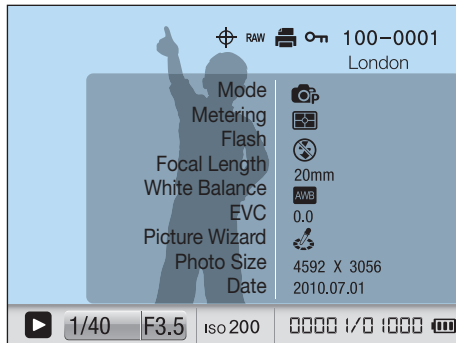

## View image thumbnails

In order to search for photos and videos you want, convert to the thumbnail view. The thumbnail view displays up to 20 images at a time so that you can easily look through items you wish to find. You can also classify and display files by their type, day recorded, and week recorded.

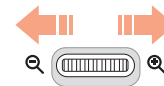
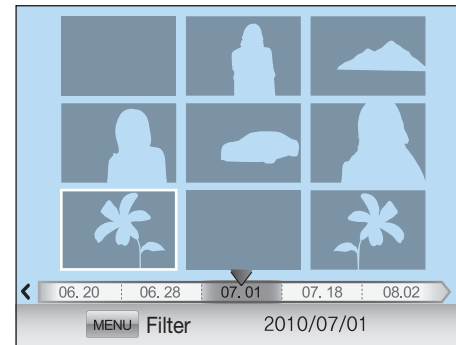

**Scroll the jog dial left to display 9 or 20 thumbnails.**  
 Scroll the jog dial right to return to the previous mode.

## View files by category in Smart Album

- 1 In the thumbnail view, press [MENU].
- 2 Select a category and press [OK].

Option	Description
Type	View files by the file type such as photo, video, or photo with a voice memo.
Date	View files by the date they were saved.
Week	View files by the week they were saved.
Location	View file by the place they were saved. (Only the photos captured with a GPS module have the location information.)

## Protect files

Protect your files from accidental deletion.

In Playback mode, select a file and press [Fn].

- To unprotect the file, press [Fn] again.

## Delete files

Delete files in Playback mode and secure more space on your memory card. Protected files are not deleted.







### Delete a single file

You can select a single file and delete it.

- 1 In playback mode, select a file and press [Delete].
- 2 Select Yes.

### Delete multiple files

You can select multiple files and delete them.

- 1 In Playback mode, press [] ▶ **Multiple Delete**.
  - Alternatively, in Playback mode, press [MENU] ▶  ▶ **Delete** ▶ **Select**.
- 2 Rotate the navigation button or press [/WB], select files you want to delete and press [].
  - Press [] again to cancel your selection.
- 3 Press [].
- 4 Select **Yes**.

### Delete all files

You can delete all files on the memory card at once.

- 1 In Playback mode, press [MENU].
- 2 Select  ▶ **Delete** ▶ **All**.
- 3 Select **Yes**.

# View photos

## Enlarge a photo

You can enlarge photos when viewing them in Playback mode. You can also use the Trim function to extract the portion of the image displayed on the screen and save it as a new file.

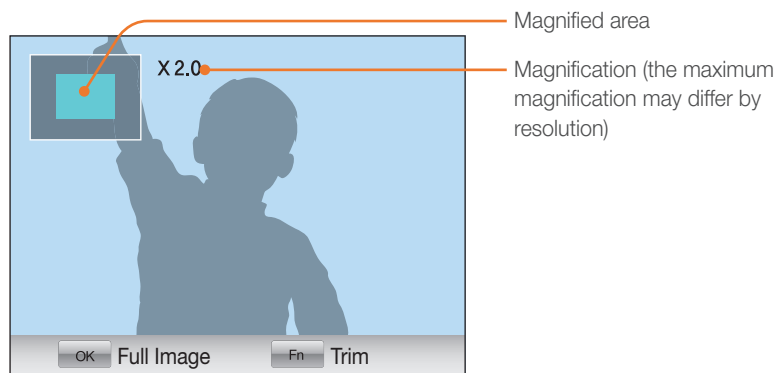

**In Playback mode, turn the jog dial right to enlarge a photo.**

Turn the jog dial left to reduce a photo.

To	Do this
Move magnified area	Press [ <b>AF·MF</b> , <b>ISO</b> , <b>WB</b> ].
Trim the enlarged image	Press [ <b>Fn</b> ]. (saved as a new file)
Return to the original image	Press [ <b>OK</b> ].



You can scroll through files by rotating the navigation button, even when a photo is enlarged.

## Start a slide show

You can view photos in a slide show, apply various effects to the slide show, and play background music.

**1** In Playback mode, press [**MENU**].

**2** Select .

**3** Select a slide show effect option.

- Skip to step 4 to start a slide show with no effects.

Option	Description
Images	Set the photos you want to view as a slide show. <ul style="list-style-type: none"> <li>• <b>All</b>: View all photos in a slide show.</li> <li>• <b>Date</b>: View photos captured on a specific date in a slide show.</li> <li>• <b>Select</b>: View selected photos in a slide show.</li> <li>• <b>Sound picture</b>: View voice recorded photos in a slide show.</li> </ul>
Effect	<ul style="list-style-type: none"> <li>• Select a transition effect.</li> <li>• Select <b>Off</b> for no effects.</li> </ul>
Interval	Select the amount of time each photo is displayed.
Music	Play background music.

**4** Select **Slide Show ▶ Play**.

- Slide show begins right away.

## Highlight

This function identifies the parts of a photo that are excessively bright. When you view a photo with highlight on, the excessively bright areas of the photo blink in blue.

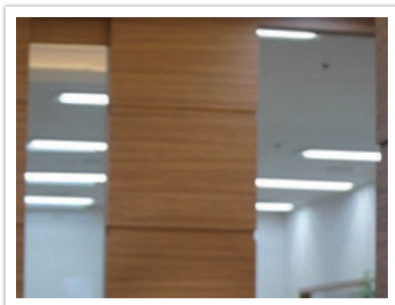

Original

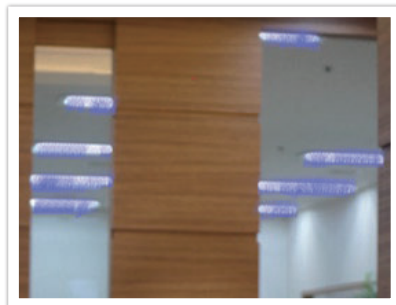

Highlighted

To set highlight options,

In Playback mode, press [MENU] ►  ► Highlight ►

## Auto Rotate

With Auto Rotate on, the camera automatically rotates photos you have taken vertically so they fit the screen horizontally.

To set auto rotate options,

In Playback mode, press [MENU] ►  ► Auto Rotate ►



# Play a video

You can play a video, capture an image from a video, or crop a video.



## Video viewing controls

To	Do this
Rewind	Press []. Scan backward in 2X, 4X, and 8X increments each time you press [].
Pause/Play	Press [].
Fast forward	Press [ <b>WB</b> ]. Scan forward in 2X, 4X, and 8X increments each time you press [ <b>WB</b> ].
Volume control	Scroll the jog dial left or right.
Stop	Press [ <b>AF·MF</b> ].

## Trim a video during playback

- 1 Press [] at the point where you want the new video to begin.
- 2 When paused, press [].
- 3 Press [] at the point where you want the new video to end.
- 4 When paused, press [].
- 5 Select **Yes**.



The cut file is saved as a separate file under a new name.

## Capture an image during playback

- 1 Press **[OK]** at the point where you want to save a still image.
- 2 Press **[ISO]**.



- The resolution of the captured image is the same as the video resolution.
- The captured file is saved as a separate file under a new name.



# Edit a photo



Perform photo editing tasks, such as resizing, rotating, eliminating red-eye effects, and adjusting brightness, contrast, or saturation. Edited photos are saved as new files under different file names.

To set Image Edit options,







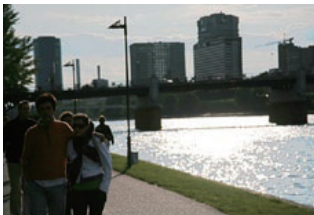





In Playback mode, press [MENU] ►  ► Image Edit ► an option.

## Options

\* Default











Option	Description
	<b>Red-eye Fix:</b> Remove red-eyes on a photo. (Off*, On)
	<p><b>Backlight:</b> Correct the brightness of an underexposed photo. (Off*, On)</p> <div style="display: flex; justify-content: space-around;">   </div> <p style="display: flex; justify-content: space-around;"> <span>Before correction</span> <span>After correction</span> </p>

\* Default

Option	Description
	<p><b>Photo Style Selector:</b> Apply various photo styles to photos.</p> <div style="display: flex; justify-content: space-around;">    </div> <p style="display: flex; justify-content: space-around;"> <span>Off*</span> <span>Soft</span> <span>Vivid</span> </p> <div style="display: flex; justify-content: space-around;">    </div> <p style="display: flex; justify-content: space-around;"> <span>Forest</span> <span>Autumn</span> <span>Misty</span> </p> <div style="display: flex; justify-content: space-around;">   </div> <p style="display: flex; justify-content: space-around;"> <span>Gloomy</span> <span>Classic</span> </p>
	<p><b>Resize:</b> Resize the size of a photo. (Off*, 10M, 6M, 2M)</p> <div style="background-color: #f0f0f0; padding: 5px;">  Available resolutions may differ depending on the size of the selected photo.         </div>
	<p><b>Rotate:</b> Rotate a photo. (Off*, Right 90°, Left 90°, 180°, Horizontal, Vertical)</p> <div style="background-color: #f0f0f0; padding: 5px;">  The new file may be smaller than the original.         </div>



\* Default

Option	Description
	<p><b>Face Retouch:</b> Hide facial imperfections. (Off*, Level 1, Level 2, Level 3)</p>
	<p><b>Smart Filter:</b> Apply various filter effects to photos and create unique images.</p> <div style="display: flex; justify-content: space-around; align-items: flex-start;"> <div style="text-align: center;">  <p>Off*</p> </div> <div style="text-align: center;">  <p>Vignetting</p> </div> <div style="text-align: center;">  <p>Miniature</p> </div> </div> <div style="display: flex; justify-content: space-around; align-items: flex-start; margin-top: 10px;"> <div style="text-align: center;">  <p>Fish-Eye</p> </div> <div style="text-align: center;">  <p>Sketch</p> </div> <div style="text-align: center;">  <p>Defog</p> </div> </div> <div style="display: flex; justify-content: space-around; align-items: flex-start; margin-top: 10px;"> <div style="text-align: center;">  <p>Halftone Dots</p> </div> <div style="text-align: center;">  <p>Soft Focus</p> </div> </div>
 The new file may be smaller than the original.	





## Chapter 4

# Camera settings menu

---

Learn about the user settings and general settings menu.  
You can adjust the settings to better suit your needs and preferences.

# User settings

You can set the user environment with these settings.

To set user options,

In Shooting mode, press [MENU] ►  ► an option.

## ISO Step

You can set the size of the exposure adjustment in fractions of steps. 1/3 step is more subtle than 1 step.

## Auto ISO Range

You can set the maximum ISO value under which each EV step is chosen when you set the ISO Auto.

\* Default

Option	Value
1 Step	ISO 200, ISO 400, ISO 800*, ISO 1600
1/3 Step	ISO 125, ISO 160, ISO 200, ISO 250, ISO 320, ISO 400, ISO 500, ISO 640, ISO 800*, ISO 1000, ISO 1250, ISO 1600

## Noise Reduction

Use the Noise Reduction to reduce the visual noise in photos.

\* Default

Option	Description
High ISO NR	This function reduces noise that may occur when you set a high ISO sensitivity of more than 3200. (Off, On*)
Long Term NR	This function reduces noise when you set the camera for a long exposure (over 1 second). (Off, On*)

## AF Lamp

When shooting in dark places, turn the AF assist light on in order to have a better auto focus. The Auto Focus functions more accurately in dark places when the AF assist light is on.

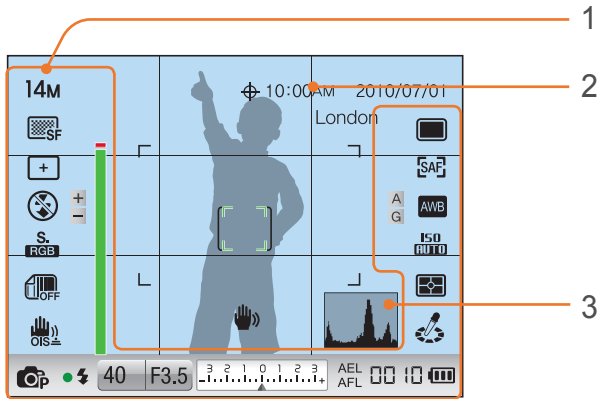

## User Display

You can add or remove shooting information from the display.

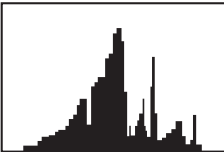

\* Default

No.	Description
1	<b>Icons</b> Set the shooting options icons on the display on or off.
2	<b>Grid Line</b> Set the grid on the display on or off. ( <b>Off*</b> , 2 X 2, 3 X 3, +, X)
3	<b>Histogram</b> Set the histogram on the display on or off.  About histogram A histogram is a graph that shows the brightness distribution of a photo. A histogram inclined to the left indicates a dark photo. A histogram inclined to the right indicates a bright photo. The height of the graph is related to color information. The graph gets higher if a specific color is more common.

Insufficient exposure

Balanced exposure

Excessive exposure

## Key Mapping

You can change the function assigned to the AEL and Preview buttons.

\* Default

Button	Function
<b>AEL</b>	<p>You can set the AEL button's function. The AEL and AFL functions save the exposure value or focus area respectively when a photo is taken.</p> <p>You can choose among three settings for the [<b>AEL</b>] button:</p> <ul style="list-style-type: none"> <li>• <b>AEL*</b>, which executes the auto exposure lock function. When AEL is on, half-pressing the shutter button executes the auto focus lock function.</li> <li>• <b>AFL</b>, which executes the auto focus lock function. When AFL is on, half-pressing the shutter button executes the auto exposure lock function.</li> <li>• <b>AEL + AFL</b>, which executes the auto exposure and focus lock functions together.</li> </ul>
<b>Preview</b>	<p>You can assign one of the following functions to the Depth Preview button:</p> <ul style="list-style-type: none"> <li>• <b>One Touch WB</b> (White Balance), which executes the Custom White Balance function.</li> <li>• <b>Optical Preview*</b>, which executes the Depth of Field Preview function for the current aperture value. (p. 19)</li> <li>• <b>One Touch RAW+</b>, which activates or deactivates the RAW+JPEG feature.</li> </ul>



# Setting 1

Learn about the menu items of the Setting 1.

To set Setting 1 options,

In Shooting mode, press [MENU] ►  ► an option.

\* Default

Item	Description
Format	<p>Format the memory card. Formatting prepares a memory card for use in the camera and deletes all existing files including protected files. <b>(No, Yes)</b></p> <div style="background-color: #f0f0f0; padding: 5px;">  Errors can occur if you use a memory card formatted by another brand of camera, a memory card reader, or a computer. Please format memory cards in the camera before using them to capture photos.         </div>
Reset	<p>Reset the setup menu and shooting options to the factory defaults. (Date, time, language, and video output settings do not change.) <b>(No, Yes)</b></p>
File Name	<p>Set the method of creating file names.</p> <ul style="list-style-type: none"> <li>• <b>Standard*</b>: SAM_XXXX.JPG(sRGB)/_SAMXXXX.JPG(Adobe RGB)</li> <li>• <b>Date:</b> <ul style="list-style-type: none"> <li>- sRGB files - MMDDxxxx.JPG. For example, for a photo taken on Jan. 01, the file name would be 0101xxxx.jpg.</li> <li>- AdobeRGB files - MDDxxxx.JPG for the months Jan through Sept. For the months Oct through Dec, the month number is replaced by the letters A (Oct.), B (Nov.) and C (Dec.).</li> </ul> </li> </ul> <p>For example, for a photo taken on Feb. 03, the file name would be 203xxxx.jpg. For a photo taken on Oct. 05, the file name would be A05xxxx.jpg.</p>

\* Default

Item	Description
File Number	<p>Set the method of numbering files and folders.</p> <ul style="list-style-type: none"> <li>• <b>Series*</b>: New file numbers continue the existing number sequence, even if you have installed a new memory card, formatted the card, or deleted all photos.</li> <li>• <b>Reset</b>: After using the reset function, the next file name is started at 0001.</li> </ul> <div style="background-color: #f0f0f0; padding: 5px;">  <ul style="list-style-type: none"> <li>• The first folder name is 100PHOTO, if you have selected the sRGB color space and Standard file naming, the first file name is SAM_0001.</li> <li>• File name numbers are increased by 1 from SAM_0001 to SAM_9999.</li> <li>• Folder numbers are increased by 1 from 100PHOTO to 999PHOTO.</li> <li>• The maximum number of files that can be saved in one folder is 9999.</li> <li>• File numbers are assigned according to DCF (Design rule for Camera File system) specifications.</li> <li>• If you change a file name (for example, on a computer), the camera will not be able to play the file.</li> </ul> </div>
Folder Type	<p>Set the type of folder.</p> <ul style="list-style-type: none"> <li>• <b>Standard*</b>: XXXPHOTO</li> <li>• <b>Date</b>: XXX_MMDD</li> </ul>
Language	<p>Select the language the camera shows on the display.</p>

# Setting 2

Learn about the menu items of the Setting 2.



To set Setting 2 options,

In Shooting mode, press [MENU] ►  ► an option.

\* Default

Item	Description
Quickview	Set the Quick View time length – the amount of time the camera displays a photo immediately after you take it. <b>(Off, 1 sec*, 3 sec, 5 sec, Hold)</b>
Display Adjust	Adjust the display brightness, auto brightness setting, or display color. <ul style="list-style-type: none"> <li>• <b>Display Brightness:</b> You can adjust the display brightness by rotating the navigation button or using [AF·MF/ISO].</li> <li>• <b>Auto Brightness:</b> Turn auto brightness on or off. <b>(Off, On*)</b></li> <li>• <b>Display Color:</b> You can adjust the display color by rotating the navigation button and using [AF·MF/ISO//WB].</li> </ul>
Display Save	Set the display off time. The display turns off if you do not use the camera for the time you set. <b>(Off, 0.5 min*, 1 min, 3 min, 5 min, 10 min)</b>

\* Default

Item	Description
Power Save	Set power shut off time. The camera shuts off if you do not use it for the time you set. <b>(0.5 min, 1 min*, 3 min, 5 min, 10 min, 30 min)</b> <div style="background-color: #f0f0f0; padding: 10px; margin-top: 10px;">  <ul style="list-style-type: none"> <li>• The camera retains the power-off time setting even if you replace the battery.</li> <li>• Power save may not work if the camera is connected to a computer, TV, or printer, playing a slide show or movie.</li> </ul> </div>
Date & Time	Set date, time, date format, time zone and whether to imprint the date on photos. <b>(Type, Date, Time Zone, Time, Imprint)</b> <div style="background-color: #f0f0f0; padding: 10px; margin-top: 10px;">  <ul style="list-style-type: none"> <li>• The date and time are displayed either in 12h or 24h format.</li> <li>• The date appears on the lower right side of the photo.</li> <li>• When you print a photo, some printers may not print the date appropriately.</li> </ul> </div>
Sound	<ul style="list-style-type: none"> <li>• <b>System Volume:</b> Set the sound volume or turn all sound off entirely. <b>(Off, Low, Medium*, High)</b></li> <li>• <b>AF Sound:</b> Set the sound the camera makes in AF mode on or off. <b>(Off, On*)</b></li> <li>• <b>Button Sound:</b> Set the sound the camera makes when you press buttons on or off. <b>(Off, On*)</b></li> </ul>

# Setting 3

Learn about the menu items of the Setting 3.

To set Setting 3 options,

In Shooting mode, press [MENU] ►  ► an option.

\* Default

Item	Description
Sensor Cleaning	<ul style="list-style-type: none"> <li>• <b>Sensor Cleaning:</b> Remove dust from the sensor.</li> <li>• <b>Start-Up Action:</b> When on, the camera performs sensor cleaning each time you turn it on. (<b>Off*</b>, <b>On</b>)</li> </ul> <div style="border: 1px solid #ccc; padding: 5px; margin-top: 10px;">  As this product uses interchangeable lenses, the sensor can get dust on it when you change lenses. This can lead to dust particles appearing in the photos you take. It is recommended not to change lenses when you are in a particularly dusty area. Also, make sure to attach the lens cap to the lens when not using it.         </div>
Video Out	<p>Select the video output signal appropriate for your country when connecting the camera to an external video device such as a monitor or TV.</p> <ul style="list-style-type: none"> <li>• <b>NTSC*</b>: US, Canada, Japan, Korea, Taiwan, Mexico</li> <li>• <b>PAL</b> (Supports only PAL B, D, G, H, or I): Australia, Austria, Belgium, China, Holland, Finland, Germany, England, Italy, Kuwait, Malaysia, New Zealand, Singapore, Spain, Sweden, Switzerland, Thailand, Norway</li> </ul>

\* Default

Item	Description
Anynet+ (HDMI-CEC)	<p>When you connect the camera to an HDTV that supports Anynet+ (HDMI-CEC), you can control the play function of the camera with the TV remote control.</p> <ul style="list-style-type: none"> <li>• <b>Off:</b> You cannot control the play function of camera with the TV remote control.</li> <li>• <b>On*</b>: You can control the play function of camera with the TV remote control.</li> </ul>
HDMI Size	<p>When you connect the camera to an HDTV with an HDMI cable, you can change the resolution of the image.</p> <ul style="list-style-type: none"> <li>• <b>NTSC: Auto*</b>, <b>1080i</b>, <b>720p</b>, <b>480p</b></li> <li>• <b>PAL: Auto*</b>, <b>1080i</b>, <b>720p</b>, <b>576p</b></li> </ul> <div style="border: 1px solid #ccc; padding: 5px; margin-top: 10px;">  If the connected HDTV does not support the resolution you select, the camera sets the resolution one level lower.         </div>



\* Default

Item	Description
Firmware Update	<p>Display the firmware version of the camera body and lens, and update the firmware.</p> <ul style="list-style-type: none"> <li>• <b>Body Firmware:</b> Update the firmware of the camera body.</li> <li>• <b>Lens Firmware:</b> Update the firmware of the lens.</li> </ul> <div style="background-color: #f0f0f0; padding: 10px; border: 1px solid #ccc;">  <ul style="list-style-type: none"> <li>• You can download firmware upgrades from <a href="http://www.samsungimaging.com">www.samsungimaging.com</a> or <a href="http://www.samsung.com">www.samsung.com</a>.</li> <li>• You cannot run a firmware upgrade without a fully charged the battery. Recharge the battery fully before running a firmware upgrade or attach the adapter to provide power (optional).</li> <li>• If you update the firmware, user settings values will be reset. (Date, time, language, video out will not change.)</li> <li>• Do not turn the camera off while the update is in progress.</li> </ul> </div>



# Setting 4

Learn about the menu items of the Setting 4. You should purchase an optional GPS accessory in order to use the GPS function.

To set Setting 4 options,

In Shooting mode, press [MENU] ►  ► an option.

\* Default

Item	Description
GeoTagging	Set to take photos with location information using the Global Positioning System (GPS). Location information is added to the Exif data associated with the photo. <b>(Off, On*)</b>
GPS Valid Time Settings	Set the time to use the last location information when the camera fails to receive GPS signals. <b>(15 sec*, 30 sec, 1 min, 3 min, 10 min, 30 min)</b>
Location Display	Set to display the location information on the top right screen of Shooting mode. The location information will appear in Korean only when you are in Korea and the display language is set to Korean. When another language is set, the location information will appear in English. <b>(Off, On*)</b>
GPS Reset	Set to search for GPS satellites closest to your current position. <b>(No, Yes)</b>



# Setting 5

Learn about the menu items of the Setting 5.

To set Setting 5 options,

In Shooting mode, press [MENU] ►  ► an option.

\* Default

Item	Description
Distortion Correct	Correct lens distortion that might occur from lenses. This feature may not be available with some lenses. (Off*, On)
Lens i-Function	Set the functions to be displayed when you press [iFn] on an iFn lens. • WB: Off, On* • ISO: Off, On*



## Chapter 5

# Connect to external devices

---

Make full use of the camera by connecting it to external devices such as a computer, TV, or photo printer.

# View files on a TV or HDTV

Play back photos or videos by connecting your camera to a TV using the A/V cable.

## View files on a TV

- 1 In Shooting mode or Playback mode, press **[MENU]** ►  ► **Video Out**.
- 2 Select a video signal output according to your country or region. (p. 95)
- 3 Connect the TV and the camera using the A/V cable.

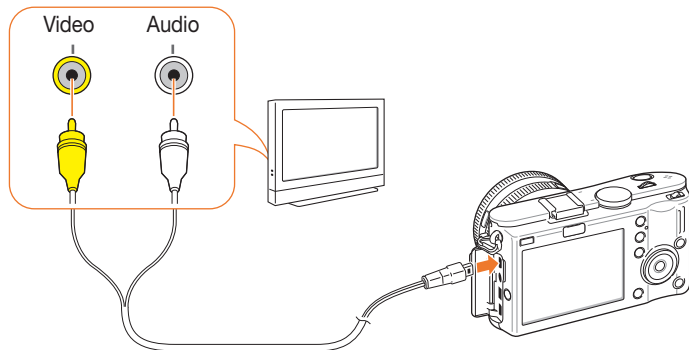

- 4 Make sure the TV and the camera are turned on and then select the video input mode or source (AV or AV1 for example) of the TV.
- 5 View the videos and photos using the buttons on the camera.



- On some TVs, digital noise may occur or part of an image may not appear.
- Images may not appear centered on the TV screen depending on your TV settings.
- You cannot capture photos or videos while the camera is connected to a TV.

## View files on an HDTV

1 In Shooting or Playback mode, press [MENU] ►  ► HDMI Size ► an option.

2 Connect the HDTV and the camera using the HDMI cable.



If both A/V and HDMI cables are connected at the same time, the HDMI cable has the priority. Disconnect the A/V cable for better playback.

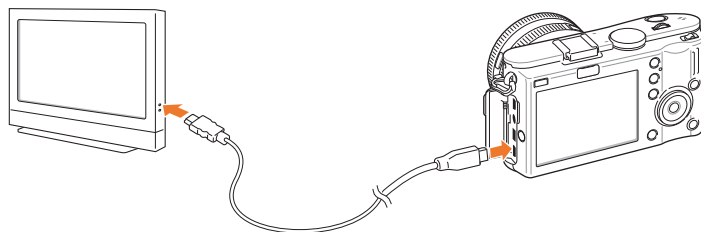

3 Make sure that the HDTV and camera are turned on, and then select the HDMI mode.

- The HDTV screen mirrors the camera's display.

4 View the videos and photos using the buttons on the camera.



- When using the HDMI cable, you can connect the camera to an HDTV using the Anynet+(CEC) method.
- The Anynet+(CEC) functions allow you to control connected devices using the TV remote control.
- If the HDTV supports Anynet+(CEC), the TV turns on automatically when used in conjunction with the camera. This feature may not be available on some HDTVs.
- When connected to an HDTV by an HDMI cable, the camera cannot take a photo or video.
- When connected to an HDTV, some of the camera's playback functions may not be available.
- The length of time after which the camera and an HDTV are connected may vary depending on the SD card that you are using.
- As the main feature of an SD card is to increase the transfer speed, it is not necessarily true to say that an SD card with a faster transfer speed is also fast in using the HDMI function.

# Print photos

Print photos on your camera by connecting to printers directly or saving Digital Print Order Format (DPOF) information on a memory card.

## Print photos with a photo printer (PictBridge)

You can print photos with a PictBridge-compatible printer by connecting your camera directly to the printer.

- 1 With the printer on, connect your camera to the printer with the USB cable.

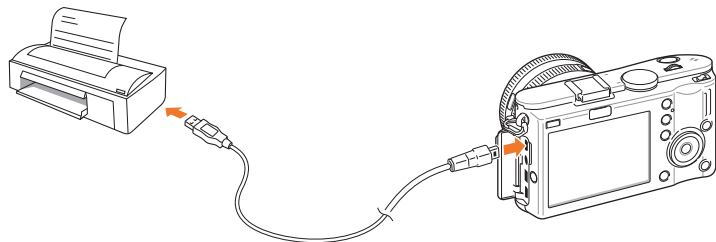

- 2 Turn on your camera.

- Select **Printer** in the pop-up window.



If your printer has the mass storage feature, you must first set the USB mode to **Printer** in the settings menu.

- 3 Press [/WB] to select a photo.

- Press [**MENU**] to set printing options.

- 4 Press [] to print.

### Configure print settings

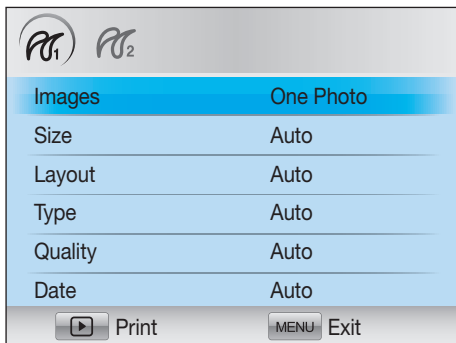

Option	Description
Images	Select whether to print the current photo or all photos.
Size	Specify the size of the print.
Layout	Create thumbnail prints.
Type	Select the type of paper.
Quality	Set the printing quality.
Date	Set to print the date.
File Name	Set to print the name of the file.
Reset	Reset the print options.



Some options are not supported by some printers.

### Set printer info using DPOF



DPOF (Digital Print Order Format) lets you set the print size of a photo and the number of copies to be printed. The camera saves the DPOF information in the MISC folder of your memory card. Your camera displays a DPOF indicator when it displays an image with DPOF information. If you have set DPOF information for your images, you can take the memory card to a digital printing shop for printing.

To set DPOF options,

In Playback mode, press [MENU] ► ► DPOF ► select an item.



## DPOF options

Option	Description
Standard	<p>You can select photos to print and the number of copies for photos.</p> <ul style="list-style-type: none"> <li>• <b>Select:</b> Select the number of copies for photos you select. (Select photos you want to print ► Select the number of copies by scrolling the jog dial left or right and then pressing [Fn])</li> <li>• <b>All:</b> Select the number of copies for all photos. (Select the number of copies by pressing [AF-MF/ISO] and then, press )</li> <li>• <b>Reset:</b> Cancel all DPOF printing quantity selections.</li> </ul>
Index	<p>This option lets you print all photos set to be printed as thumbnails in a single paper.</p>
Size	<p>You can specify the size of the print.</p> <ul style="list-style-type: none"> <li>• <b>Select:</b> Select the print size for photos you choose. (Select photos you want to print ► Select the print size by scrolling the jog dial left or right and then pressing [Fn])</li> <li>• <b>All:</b> Select the print size of all the photos saved in the memory card. (Select the print size by pressing [AF-MF/ISO] and then, press )</li> <li>• <b>Reset:</b> Cancel the DPOF print size for all photos.</li> </ul>



# Transfer files to your computer

Transfer files on a memory card to your computer by connecting the camera to the PC.

## Transfer files to your computer (for Windows)

### Transfer files by connecting the camera as a removable disk

You can connect the camera to your computer as a removable disk.

- 1 Turn off the camera.
- 2 Connect the camera to your computer with the USB cable.



- You must plug the end of the cable with the correct connection plug into your camera. If the cable is reversed, it may damage your files. The manufacturer is not responsible for any loss of data.
- If you try to plug the USB cable into the HDMI port, the camera may not work properly. If it occurs, restart the camera.

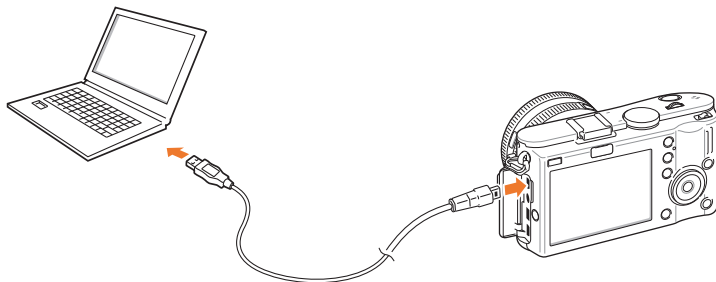

- 3 Turn on the camera.
  - In the pop-up window, select **Computer**.
- 4 On your computer, select **My Computer** ► **Removable Disk** ► **DCIM** ► **XXXPHOTO** or **XXX\_MMDD**.
- 5 Select the files you want, and then drag or save them to your computer.



If the **Folder Type** is set to **Date**, the folder name appears as "XXX\_MMDD." For example, if you capture a photo on January 1, the folder name will be "101\_0101".

### Disconnect the camera (Windows XP)

The way to disconnect the USB cable for Windows Vista and 7 is similar.

- 1 Ensure that no data is being transferred between the camera and the PC.
  - If the status lamp on your camera is blinking, it means the data transfer is in progress. Please wait until the status lamp stops blinking.

- 2 Click  on the tool bar at the bottom right of your PC screen.



- 3 Click the pop-up message.
- 4 Click the message box indicating safely removed.
- 5 Remove the USB cable.

### Transfer files to your computer (for Mac)

- 1 Turn off the camera.
- 2 Connect your camera to a Macintosh computer with the USB cable.



Mac OS 10.4 or later is supported.



- You must plug the end of the cable with the correct connection plug into your camera. If the cable is reversed, it may damage your files. The manufacturer is not responsible for any loss of data.
- If you try to plug the USB cable into the HDMI port, the camera may not work properly. If it occurs, restart the camera.

- 3 Turn on the camera.
  - In the pop-up window, select **Computer**.
- 4 Double-click the removable disk icon.
- 5 Transfer photos or videos to the computer.

# Edit photos on a PC

Digital photos can be edited in a variety of ways through image editing programs. Learn to edit photos using the provided editing programs.

## Install software

Use the included software to transfer files from the camera to your PC. You can also edit photos and upload them on web.

- 1 Insert the CD-ROM into your PC.
- 2 When the setting wizard appears, click **Samsung Digital Camera Installer**.
- 3 Select a program you want to install and click **Install**.
- 4 Follow the on-screen instructions.
- 5 When the installation is complete click **Exit**.

### Programs contained on the CD

Program	Purpose
Intelli-studio	Edit photos and videos.
Samsung RAW Converter	Convert RAW files into the desired file format.



- If your computer does not meet the requirements, videos may not play correctly or it may take longer to edit videos.
- Install DirectX 9.0c or above before you use the program.
- You must use Windows XP/Vista/7 or Mac OS 10.4 or later to connect the camera as a removable disk.



Using a self-assembled PC or a PC and OS that are not supported may void your warranty.

## Use Intelli-studio

Intelli-studio is a built-in program that allows you to play back and edit files. You can also upload files to your favorite websites. For details, select **Help ► Help** in the program.

## System Requirements

Item	Requirements
OS*	Windows XP SP2/Vista/7
CPU	Intel® Pentium® 4, 3.2GHz or higher/AMD Athlon™ FX, 2.6GHz or higher
RAM	Minimum 512MB RAM (1GB and above recommended)
Hard disk capacity	250MB or more (1GB or more recommended)
Others	<ul style="list-style-type: none"> <li>• CD-ROM drive</li> <li>• 1024x768 pixels, 16-bit color display compatible monitor (1280x1024 pixels, 32-bit color display recommended)</li> <li>• USB 2.0, Microsoft DirectX 9.0c or later</li> <li>• nVIDIA Geforce 7600GT or higher/ATI X1600 series or higher</li> </ul>

\* 64-bit editions of Windows XP, Vista, and 7 are not supported.



- Intelli-studio may not perform correctly on some computers, even when the computer meets the requirements.
- Intelli-studio is compatible only with Windows.
- You cannot edit files directly on the camera. Transfer files to a folder on your computer before editing.
- You cannot copy files in your computer to the camera.
- Intelli-studio supports the following formats:
  - **Videos:** MP4 (Video: H.264, Audio: AAC), WMV (WMV 7/8/9), AVI (MJPEG)
  - **Photos:** JPG, GIF, BMP, PNG, TIFF
- You cannot open the RAW format files with the Intelli-studio program.

## Use the Intelli-studio Interface

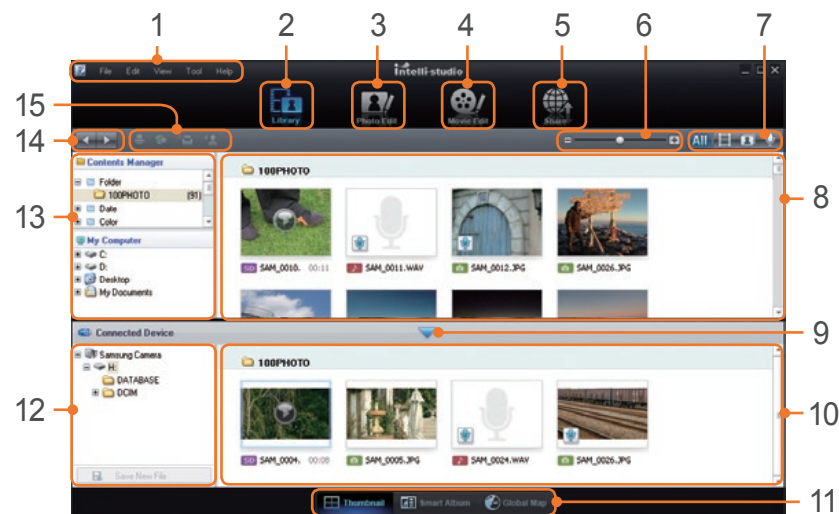

No.	Description
1	Open menus.
2	Display files in the selected folder.
3	Change to the Photo edit mode.
4	Change to the Video edit mode.
5	Change to the Sharing mode. (You can send files by email or upload files to websites, such as Flickr or YouTube.)
6	Enlarge or reduce the thumbnails in the list.
7	Select a file type.

No.	Description
8	View files of the selected folder on your computer.
9	Show or hide files of the connected camera.
10	View files of the selected folder on the camera.
11	View files as thumbnails, in Smart Album, or on a map.
12	Browse folders in the connected device.
13	Browse folders in your computer.
14	Move to the previous or next folder.
15	Print files, view files on a map, store files in My Folder, or register faces.

### Transfer files using Intelli-studio

You can easily transfer files on your camera to your computer by using Intelli-studio.

#### 1 Turn off the camera.

#### 2 Connect the camera to your computer with the USB cable.

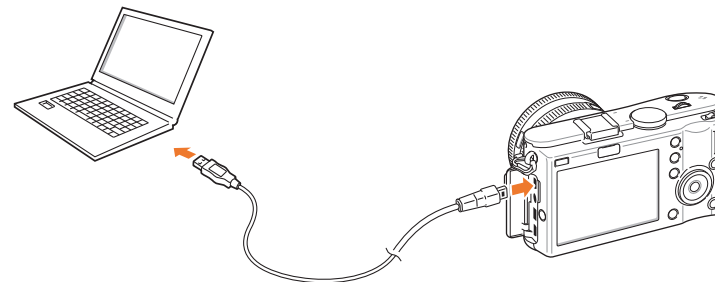

- You must plug the end of the cable with the correct connection plug into your camera. If the cable is reversed, it may damage your files. The manufacturer is not responsible for any loss of data.
- If you try to plug the USB cable into the HDMI port, the camera may not work properly. If it occurs, restart the camera.

#### 3 Run Intelli-studio on your computer.

#### 4 Turn on the camera.

- In the pop-up window, select **Computer**.

#### 5 Select a folder on your computer to save new files and select **Yes**.

- New files will be transferred to the computer.
- If your camera has no new files, the pop-up window for saving new files will not appear.

## Use Samsung RAW Converter

Photos captured by a camera are often transformed to JPEG formats and stored in the memory according to the settings of the camera at the time of shooting. RAW files are not transformed to JPEG formats and are stored in the memory without any changes. With Samsung RAW Converter, you can calibrate exposures, white balances, tones, contrasts, and colors of photos.

### System Requirements for Windows

Item	Requirements
OS	Microsoft® Windows® XP / Vista / 7 * Administrator rights are needed for installation. * The program runs as a 32-bit application under the 64-bit OS.
CPU	Intel Pentium®, AMD Athlon processor-based PC or compatible computer (Pentium4, Athlon XP or later recommended) * Multi-core processor ready (Intel Core i7, Core 2 Quad, Core 2 Duo, AMD Phenom IIX4, Phenom X4, etc.)
RAM	1GB or more recommended
Hard disk capacity	Please reserve at least 100MB of space. Please allocate sufficient disk space for image storage. (One image may use more than 10MB of disk space.)
Others	<ul style="list-style-type: none"> <li>XGA (1024x768), Full Color (24 bit or higher)</li> <li>Keyboard, mouse, or equivalent devices</li> </ul>

### System Requirements for Mac

Item	Requirements
OS	Apple® Mac® OS X v10.4 / v10.5 / v10.6
CPU	Intel processor-based or compatible computer (Core 2 Quad or later recommended) / PowerPC
RAM	1GB or more recommended
Hard disk capacity	Please reserve at least 100MB of space. Please allocate sufficient disk space for image storage. (One image may use more than 10MB of disk space.)
Others	<ul style="list-style-type: none"> <li>XGA (1024x768), Full Color (24 bit or higher)</li> <li>Keyboard, mouse, or equivalent devices</li> </ul>



- Samsung RAW Converter may not perform correctly on some computers, even when the computer meets the requirements.
- The Mac installation program will not autorun. Please manually run the setup file on the provided CD-ROM.

### Use the Samsung RAW Converter Interface

For details about using Samsung RAW Converter, click **Help** ► **Open software manual**.

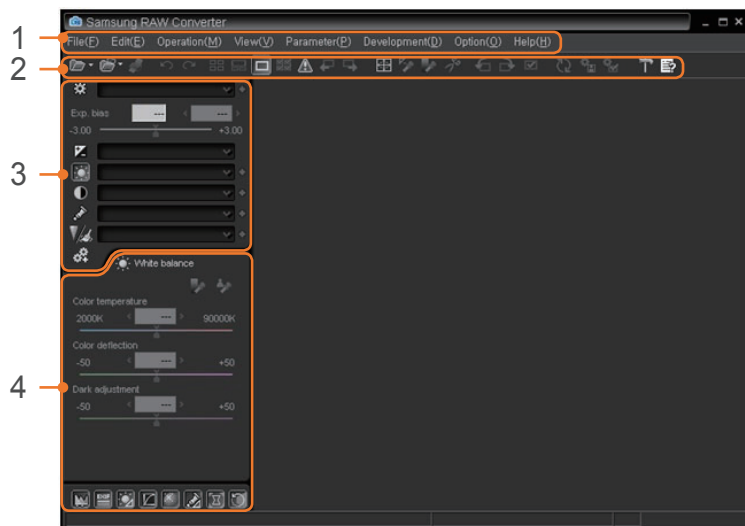

No.	Description
1	Menu
2	Toolbar
3	Editing tools
4	Open/Close the fine adjustment window for the editing tools.

### Edit RAW format files

If you edit the RAW format files with the Samsung RAW Converter, you can maintain high image quality. You can also edit JPEG and TIFF format files.

#### To adjust the exposure of an image

- 1 Select **File** ► **Open file** and open a file.
- 2 From the editing tools, select .



### 3 Adjust the exposure with the scroll bar.



Original image

Edited image

P Mode, Aperture: f=8,  
Shutter Speed: 1/15 sec, ISO=100

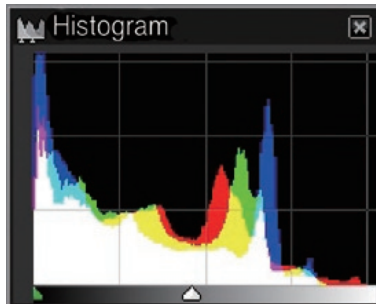

Original image

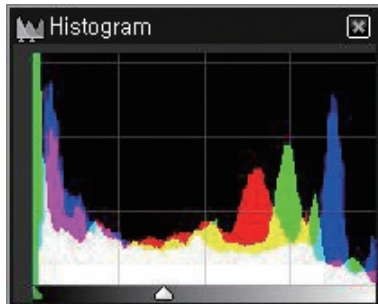

Edited image

### To adjust the contrast of an image

- 1 Select File ► Open file and open a file.
- 2 From the editing tools, select .
- 3 Adjust the tone with the scroll bar.

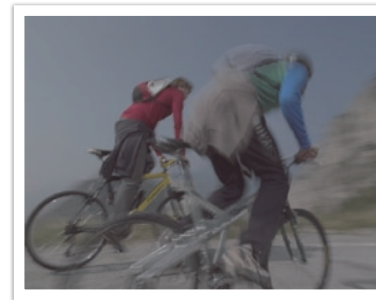

Original image



Edited image

### To save RAW files in JPEG or TIFF formats

- 1 Select **File** ► **Open file** and open a file.
- 2 Select **File** ► **Development**.
- 3 Select a file format (JPEG or TIFF) and select **Save**.





Chapter 6

# Appendix

---

# Error messages

When the following error messages appear, try these remedies.

Error messages	Suggested remedies
Lens is locked	The lens is locked. Rotate the lens counter-clockwise until you hear a click. (p. 32)
Card Error	<ul style="list-style-type: none"> <li>• Turn off your camera and then turn it on again.</li> <li>• Remove your memory card and insert it again.</li> <li>• Format your memory card.</li> </ul>
Low Battery	Insert a charged battery or recharge the battery.
No Image File	Take photos or insert a memory card that contains photos.
File Error	Delete the damaged file or contact a service center.
Memory Full	Delete unnecessary files or insert a new memory card.
Card Locked	You can lock SD or SDHC card to prevent files from being deleted. Unlock the card when shooting. (p. 117)
DCF Full Error	File names do not match the DCF standard. Transfer the files on the memory card to your computer and format the card. (p. 93)
Error 00	Turn off your camera and remount the lens. If the message still appears, contact a service center.
Error 01/02	Turn off your camera, remove the battery and insert again. If the message still appears, contact a service center.



# Maintain the camera

## Clean the camera

### Camera lens and display

Use a brush to remove dust and wipe the lens gently with a soft cloth. If any dust remains, apply lens cleaning liquid to a piece of cleaning paper and wipe gently.

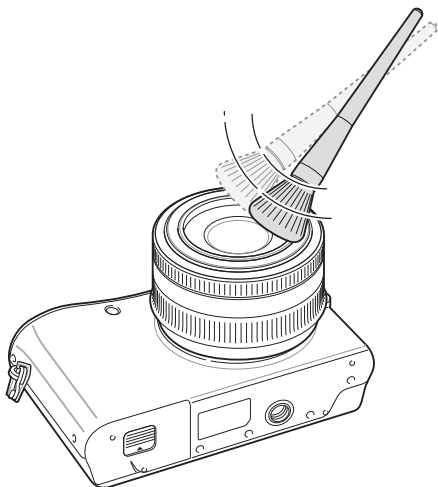

### About the image sensor

Depending on different shooting conditions, dust may appear in photos because the image sensor is exposed to the external environment. This problem is normal, and the exposure to dust occurs in everyday use of the camera. You can remove dust from the sensor by operating the sensor cleaning function. (p. 95) If dust remains after cleaning the sensor, contact a service center. Do not insert the blower into the mounting opening of the lens.

### Camera body

Wipe gently with a soft and dry cloth.



Never use benzene, thinners or alcohol to clean the device. These solutions can damage the camera or cause it to malfunction.

## About memory card

### Supported memory card

You can use SD or SDHC memory cards.

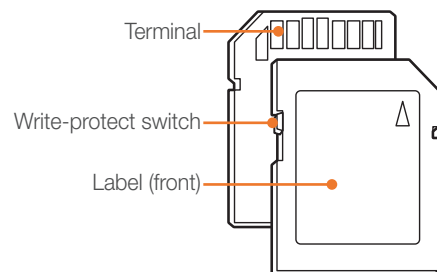

You can prevent files from being deleted by using the write-protect switch on an SD or SDHC card. Slide the switch down to lock or slide it up to unlock. Unlock the card when capturing photos and videos.

### Memory card capacity

The memory capacity may differ depending on shooting scenes or shooting conditions. These capacities are based on a 1 GB SD card.

Size		Fine	Normal
*Videos (30 per sec)	1280 (16:9)	Approx. 15 min	Approx. 22 min
	640 (4:3)	Approx. 44 min	Approx. 66 min
	320 (4:3)	Approx. 145 min	Approx. 210 min

\* The recordable time may vary if you use the zoom. Several videos were recorded in succession to determine the total recording time.

	Size	Super Fine	Fine	Normal	RAW	RAW + S.Fine	RAW + Fine	RAW + Normal
Photo	14M 4592X3056 (3:2)	141	282	423	34	25	30	32
	10M 3872X2592 (3:2)	195	391	587	-	28	34	35
	6M 3008X2000 (3:2)	320	640	961	-	31	37	38
	2M 1920X1280 (3:2)	732	1,465	2,198	-	35	42	42
	Burst	1,161	2,322	3,484	-	-	-	-
	12M 4592X2584 (16:9)	166	332	499	-	26	32	33
	8M 3872X2176 (16:9)	232	464	696	-	29	35	36
	5M 3008X1688 (16:9)	376	752	1,129	-	32	38	39
	2M 1920X1080 (16:9)	850	1,703	2,550	-	36	42	42
	9M 3056X3056 (1:1)	210	420	630	-	32	34	35
	6.7M 2592X2592 (1:1)	288	576	864	-	34	37	37
	4M 2000X2000 (1:1)	470	940	1,411	-	38	40	40
	1.6M 1280X1280 (1:1)	1,041	2,083	3,121	-	42	43	43

# About the battery

Use only Samsung-approved batteries.

## Battery specifications

Model	BP1310
Type	Lithium-ion battery
Cell capacity	1,300 mAh
Voltage	7.4 V
Charging time (when the camera is switched off)	Approx. 150 min

## Battery life

Shooting mode	Average time / Number of photos
Photos	Approx. 210 min/Approx. 420 photos
Videos	Approx. 130 min

- The figures above are based on Samsung's test standards. Your results may differ depending on your actual usage.
- Available shooting time differs depending on background, shooting interval, and use conditions.
- Several videos were recorded in succession to determine the total recording time.



### Notes about charging the battery

- If the indicator light is off, make sure that the battery is inserted correctly.
- When the battery is completely discharged, charge it at least 10 minutes before using it with your camera.
- Using the flash or recording videos depletes the battery more quickly. Charge the battery until the indicator light turns green.
- If the indicator light blinks orange or does not illuminate, reconnect the cable, or remove the battery and insert it again.
- If you charge the battery when the cable is overheated or the temperature is too high, the indicator light may turn orange. Charging will start when the battery cools down.
- Do not pull on the power supply cord to disconnect the plug from the power outlet. This may cause a fire or electric shock.
- Do not bend or place heavy objects on the AC cable. Doing so may damage the cable.



**Personal injury or death can occur if the battery is handled carelessly or improperly. For your safety, follow these instructions for proper battery handling:**

- The battery can ignite or explode if not handled properly. If you notice any deformities, cracks, or other abnormalities in the battery, immediately discontinue use of the battery and contact your manufacturer.
- Use only authentic, manufacturer-recommended battery chargers and adapters and charge the battery only by the method described in this user manual.
- Do not place the battery near heating devices or expose to excessively warm environments, such as the inside of an enclosed car in the summertime.
- Do not place the battery in a microwave oven.
- Avoid storing or using the battery in hot, humid places, such as spas or shower enclosures.
- Do not rest the device on flammable surfaces, such as bedding, carpets, or electric blankets for a prolonged period.
- When the device is switched on, do not leave it in any confined space for a prolonged period.
- Do not allow battery terminals to come in contact with metallic objects, such as necklaces, coins, keys, or watches.

- Use only authentic, manufacturer-recommended, Lithium-ion replacement batteries.
- Do not disassemble the battery or puncture the battery with any sharp object.
- Avoid exposing the battery to high pressure or crushing forces.
- Avoid exposing the battery to major impacts, such as dropping it from high places.
- Do not expose the battery to temperatures of 60 °C (140 °F) or above.
- Do not allow the battery to come in contact with moisture or liquids.
- Battery shall not be exposed to excessive heat such as sunshine, fire or the like.

#### **Disposal guidelines**

- Dispose of the battery with care.
- Do not dispose of the battery in a fire.
- Disposal regulations may differ by country or region. Dispose of the battery in accordance with all local and federal regulations.

#### **Guidelines for charging the battery**

Charge the battery only by the method described in this user manual. The battery can ignite or explode if not charged properly.



# Before contacting a service center

If you are having trouble with your device, try these troubleshooting solutions before contacting a service professional.



Give other accessories, such as memory card and battery when requesting a warranty service.

Situation	Suggested remedies
<b>Cannot turn on the camera</b>	<ul style="list-style-type: none"> <li>• Make sure that the battery is inserted.</li> <li>• Make sure that the battery is inserted correctly.</li> <li>• Charge the battery.</li> </ul>
<b>The power turns off suddenly</b>	<ul style="list-style-type: none"> <li>• Charge the battery.</li> <li>• Your camera may be in Power save mode. (p. 94)</li> <li>• The camera may be turned off automatically to prevent the memory card from being damaged due to excessive heat. Turn on your camera again.</li> </ul>
<b>The camera is losing battery power quickly</b>	<ul style="list-style-type: none"> <li>• The battery may lose power more quickly in low temperatures (below 0° C). Keep the battery warm by putting it into your pocket.</li> <li>• Using the flash or recording videos depletes the battery quickly. Recharge if needed.</li> <li>• Batteries are consumable parts that must be replaced over time. Get a new battery if the battery life is diminishing quickly.</li> </ul>

Situation	Suggested remedies
<b>Cannot take photos</b>	<ul style="list-style-type: none"> <li>• There is no space on the memory card. Delete unnecessary files or insert a new card.</li> <li>• When the <b>AF Priority</b> function is turned on, you cannot take a photo unless the focus is set correctly. Set <b>AF Priority</b> to <b>Off</b> or focus on the subject correctly. (p. 63)</li> <li>• Format the memory card.</li> <li>• The memory card is defective. Get a new memory card.</li> <li>• The memory card is locked. Unlock the card. (p. 117)</li> <li>• Make sure that the camera is switched on.</li> <li>• Charge the battery.</li> <li>• Make sure that the battery is inserted correctly.</li> </ul>
<b>The camera freezes</b>	Remove the battery and insert it again.
<b>The camera heats up</b>	While using the camera, it may heat up. This is normal and should not affect your camera's lifespan or performance.
<b>The date and time are incorrect</b>	Set the date and time in the display settings menu.
<b>The display or buttons do not work</b>	Remove the battery and insert it again.
<b>The memory card has an error</b>	The memory card has not been formatted or has become corrupt. Format the card.

Situation	Suggested remedies
<b>Cannot display files</b>	If you change the name of a file, your camera may not play the file (the name of the file should meet the DCF standard). If you encounter this situation, display files on your computer.
<b>The photo is blurry</b>	<ul style="list-style-type: none"> <li>• Make sure that the focus option you set is suitable for the kind of shot you are taking.</li> <li>• Use a tripod to prevent your camera from shaking.</li> <li>• Make sure that the lens is clean. If not, clean the lens. (p. 116)</li> </ul>
<b>The colors in the photo do not match the actual scene</b>	An incorrect white balance can create unrealistic color. Select the proper white balance option to suit the light source. (p. 53)
<b>The photo is too bright</b>	<p>Your photo is overexposed.</p> <ul style="list-style-type: none"> <li>• Adjust the aperture value or the shutter speed.</li> <li>• Adjust the exposure value. (p. 75)</li> </ul>
<b>The photo is too dark</b>	<p>Your photo is underexposed.</p> <ul style="list-style-type: none"> <li>• Adjust the aperture value or the shutter speed.</li> <li>• Adjust the exposure value. (p. 75)</li> <li>• Turn on the flash. (p. 35)</li> </ul>

Situation	Suggested remedies
<b>Photos are distorted</b>	This camera can have minute distortion when using a wide-angle lens that enables shooting with a wide angle of view. This is normal, and does not cause malfunction.
<b>Playback screen does not appear on the connected external device</b>	<ul style="list-style-type: none"> <li>• Make sure that A/V or HDMI cable is properly connected to the external monitor.</li> <li>• Make sure that the memory card is properly recorded.</li> </ul>
<b>Your computer does not recognize your camera</b>	<ul style="list-style-type: none"> <li>• Make sure that the USB cable is connected correctly.</li> <li>• Make sure that your camera is switched on.</li> <li>• Make sure that you are using a supported operating system.</li> </ul>
<b>Your computer disconnects the camera while transferring files</b>	The file transfer may be interrupted by static electricity. Disconnect the USB cable and connect it again.
<b>Your computer cannot play videos</b>	Depending on the software you use, video files may not play. To play video files captured with your camera, install and use the Intelli-studio program on your computer.
<b>Cannot set the DPOF for RAW files</b>	You cannot set the DPOF for RAW files.

Situation	Suggested remedies
<p><b>Auto Focus does not work</b></p>	<ul style="list-style-type: none"> <li>• Subject is not in focus. When the subject is outside the AF area, shoot by moving the subject inside the AF area and half pressing the shutter.</li> <li>• Subject is too close. Step back from the subject and shoot.</li> <li>• The focus mode is set to MF. Switch the mode to AF.</li> </ul>
<p><b>AEL feature does not work</b></p>	<p>AEL feature does not work in <b>M</b>, <b>i</b>, <b>SCENE</b>, and <b>SMART</b> modes. Select another mode to use this feature.</p>
<p><b>A built-in lens does not work</b></p>	<p>Make sure the lens is properly mounted. Remove the lens from the camera and re-mount it.</p>
<p><b>External flash, GPS, electronic viewfinder does not work</b></p>	<p>Make sure that the external device is properly mounted and turned on.</p>
<p><b>The date &amp; time settings screen appears when you power on the camera</b></p>	<ul style="list-style-type: none"> <li>• Set the date and time again.</li> <li>• This screen appears when the camera's internal power source is completely discharged. Insert a fully charged battery and wait at least 72 hours in power off status for the internal power source to be recharged.</li> </ul>



# Camera specifications

Image Sensor	
Type	CMOS
Sensor size	23.4 × 15.6 mm
Effective pixels	Approx. 14.6 mega-pixels
Total pixels	Approx. 15.1 mega-pixels
Color filter	RGB primary color filter
Lens Mount	
Type	Samsung NX Mount
Available lens	Samsung lenses
Image Stabilization	
Type	Lens shift (depends on lens)
Mode	OIS mode1 / mode2
Distortion Correct	
Lens Distortion Correct on/off (depends on lens)	
Dust Reduction	
Type	Super sonic drive
Display	
Type	AMOLED
Size	3.0"
Resolution	VGA (640x480) 614 k dots (PenTile)
Field of view	Approx. 100 %
User display	Icon, Grid, Histogram

Viewfinder	
Type	EVF (Electronic Viewfinder) (optional)
Resolution	QVGA Approx. 201 k dots (300X224)
Field of view	Approx. 98 %
Magnification	Approx. 0.83X (APS-C, 50 mm, -1 m <sup>-1</sup> )
Eye point	Approx. 17 mm
Diopter adjustment	Approx. -4.0 ~ +1.0 m <sup>-1</sup>
Focusing	
Type	Contrast AF
Focusing point	<ul style="list-style-type: none"> <li>• Selection: 1 point (free selection)</li> <li>• Multi: Normal 15 points, Close up 35 points</li> <li>• Face detection: Max. 10 faces</li> </ul>
Mode	Single Auto Focus, Continuous Auto Focus, Manual Focus
AF Assist Lamp	Green LED
Shutter	
Type	Electronically controlled vertical-run focal plane shutter
Speed	<ul style="list-style-type: none"> <li>• Auto: 1/4000 s ~ 30 s</li> <li>• Manual: 1/4000 s ~ 30 s (1/3 EV step)</li> <li>• Bulb (time limit: 8 min)</li> </ul>

Exposure	
Metering system	TTL 247 (19x13) Block segment
	Metering: Multi, Center-weighted, Spot
	Metering range: EV 0 ~ 18 (ISO100-30 mm, F2)
Compensation	±3 EV (1/3 EV step)
AE lock	AEL button
ISO equivalent	<ul style="list-style-type: none"> <li>• Auto, ISO 100, ISO 200, ISO 400, ISO 800, ISO 1600, ISO 3200 (1 or 1/3 step)</li> <li>• ISO expansion: up to ISO 6400</li> </ul>
Drive Mode	
Mode	Single, Continuous, Burst, Timer, Bracket (auto exposure, white balance, picture wizard)
Continuous shooting	<ul style="list-style-type: none"> <li>• JPEG: 3 shots per second (Max. 6 shots-LDC on, Max. 10 shots-LDC off)</li> <li>• RAW: 3 shots per second</li> </ul>
Burst shooting	<ul style="list-style-type: none"> <li>• 10, 15, or 30 frames per second</li> <li>• 30 shots per shutter-press</li> </ul>
Bracket shooting	Auto exposure bracket (±3EV), White Balance Bracket, Picture Wizard Bracket
Self-timer	2 ~ 30 s (1 second interval)
Shutter release	SR9NX01 (optional)

Flash	
External flash	Optional Samsung external flashes: SEF15A, SEF20A, SEF42A
Syncro	Accessory shoe (Hot shoe)
White Balance	
Mode	Auto WB, Daylight, Cloudy, Fluorescent White, Fluorescent NW, Fluorescent Daylight, Tungsten, Flash WB, Custom Set, Color Temp. (Manual)
Micro adjustment	Amber/Blue/Green/Magenta 7 steps respectively
Dynamic Range Expansion	
Smart range on/off	
Picture Wizard	
Mode	Standard, Vivid, Portrait, Landscape, Forest, Retro, Cool, Calm, Classic, Custom1, Custom2, Custom3
Parameter	Contrast, Sharpness, Saturation, Color
Shooting	
Mode	Smart Auto, Lens Priority, Program, Shutter Priority, Aperture Priority, Manual, Scene, Movie
Scene mode	Beauty Shot, Children, Sports, Close Up, Text, Sunset, Dawn, Backlight, Fireworks, Beach & Snow, Night, Portrait, Landscape, Sound picture

Sound picture	JPEG only
	Recordable time (before and after shooting, 5 or 10 seconds respectively)
Size	<ul style="list-style-type: none"> <li>• JPEG (3:2): 14M (4592x3056), 10M (3872x2592), 6M (3008x2000), 2M (1920x1280), 1.4M (1472x976, Burst mode only)</li> <li>• JPEG (16:9): 12M (4592x2584), 8M (3872x2176), 5M (3008x1688), 2M (1920x1080)</li> <li>• JPEG (1:1): 9M (3056x3056), 6.7M (2592x2592), 4M (2000x2000), 1.6M (1280x1280)</li> <li>• RAW: 14M (4592x3056)</li> </ul>
Quality	Super Fine, Fine, Normal
RAW standard	SRW
Color space	sRGB, Adobe RGB
<b>Video</b>	
Type	MP4 (H.264)
Format	Movie: H.264, Sound: AAC
Movie AE mode	Program, Aperture Priority
Movie clip	Audio on/off (Shooting time: up to 25 min)
Size	1280x720, 640x480, 320x240
Frame rate	30 frames per second

Sound	Mono
Edit	Still image capture, Time trimming
<b>Playback</b>	
Type	Single image, Thumbnails (3/9/20), Slide show, Movie
Highlight warning	Available
Edit	Red-eye Fix, Backlight, Photo Style Selector, Resize, Rotate, Face Retouch, Smart Filter
Smart filter	Vignetting, Miniature, Fish-Eye, Sketch, Defog, Halftone Dots, Soft Focus
Smart filter size	<ul style="list-style-type: none"> <li>• JPEG (3:2): 6M (3008x2000), 2M (1920x1280), VGA (640x424)</li> <li>• JPEG (16:9): 5M (3008x1688), 2M (1920x1080), VGA (640x360)</li> <li>• JPEG (4:3): 6M (3008x2256), 2M (1920x1440), VGA (640x480)</li> <li>• JPEG (1:1): 4M (2000x2000), 1.6M (1280x1280), VGA (480x480)</li> </ul>
Photo style selector	Soft, Vivid, Forest, Autumn, Misty, Gloomy, Classic
<b>Storage</b>	
Media	External memory (optional): SD card (up to 4 GB guaranteed), SDHC card (up to 32 GB guaranteed)
File format	RAW (SRW), JPEG (EXIF 2.21), DCF, DPOF 1.1, PictBridge 1.0



Direct Printing	
PictBridge	
GPS	
Type	Geo-tagging with optional GPS Module (WGS 84)
Feature	<ul style="list-style-type: none"> <li>• Location name (English and Korean only)</li> <li>• Google Map link (with Intelli-studio)</li> </ul>
Interface	
Digital output	USB 2.0 (HI-SPEED)
Video output	NTSC, PAL (selectable) HDMI 1.3: (1080i, 720p, 576p/480p)
External release	Included
DC power input	DC 9.0 V, 1.5 A (100 ~ 240 V)
Power Source	
Type	<ul style="list-style-type: none"> <li>• Rechargeable battery: BP1310 (1300 mAh)</li> <li>• Charger: BC1310</li> <li>• AC adapter: AD9NX01 (optional)</li> </ul> <p>* The power source may differ depending on your region.</p>

Dimensions (WxHxD)
120.5 × 71 × 34.5 mm (without protrusions)
Weight
282 g (without battery and memory card)
Operating Temperature
0 ~ 40 °C
Operating Humidity
5 ~ 85 %
Software
Intelli-studio, Samsung RAW Converter

\* This specifications can change without notice to upgrade a performance.  
 \* Other brands and products names are trademarks of respective owners.

# Lens specifications



Lens Name	SAMSUNG 20-50 mm F3.5-5.6 ED	SAMSUNG 20 mm F2.8
Focus Length	20 ~ 50 mm (equivalent to 30.8 ~ 77 mm in 35 mm format)	20 mm (equivalent to 30.8 mm in 35 mm format)
Elements in Group	9 elements in 8 groups (1 aspheric lens, 1 low dispersive lens included)	6 elements in 4 groups (1 aspheric lens included)
Angle of View	70.2° ~ 31.4°	70.2°
Aperture	F3.5 ~ 5.6 (minimum: F22), (Number of Blades: 7, Circular Aperture Diaphragm)	F2.8 (minimum: F22), (Number of Blades: 7, Circular Aperture Diaphragm)
Mount Type	Samsung NX mount	Samsung NX mount
Optical Image Stabilizer	Not included	Not included
Minimum Focus Distance	0.28 m ~ infinity	0.17 m ~ infinity
Maximum Magnification	Approx. 0.22X	Approx. 0.18X
i-Scene Mode	Supported(Beauty, Portrait, Children, Backlight, Landscape, Sunset, Dawn, Beach&Snow, Night)	Supported (Backlight, Landscape, Sunset, Dawn, Beach&Snow, Night)
Filter Size	40.5 mm	43 mm
Max. Diameter x Length	64 x 39.8 mm	62.2 x 24.5 mm
Weight	Approx. 119 g	Approx. 89 g
Operating Temperature	0 ~ 40 °C	0 ~ 40 °C
Operating Humidity	5 ~ 85 %	5 ~ 85 %

Lens Name	SAMSUNG 30 mm F2	SAMSUNG 18-55 mm F3.5-5.6 OIS	SAMSUNG 50-200 mm F4-5.6 ED OIS
Focus Length	30 mm (equivalent to 46.2 mm in 35 mm format)	18 ~ 55 mm (equivalent to 27.7 ~ 84.7 mm in 35 mm format)	50 ~ 200 mm (equivalent to 77 ~ 308 mm in 35 mm format)
Elements in Group	5 elements in 5 groups (1 aspheric lens included)	12 elements in 9 groups (1 aspheric lens included)	17 elements in 13 groups (2 low dispersive lenses included)
Angle of View	50.2°	75.9° ~ 28.7°	31.4° ~ 8.0°
Aperture	F2 (minimum: F22), (Number of Blades: 7, Circular Aperture Diaphragm)	F3.5 ~ 5.6 (minimum: F22), (Number of Blades: 7, Circular Aperture Diaphragm)	F4 ~ 5.6 (minimum: F22), (Number of Blades: 7, Circular Aperture Diaphragm)
Mount Type	Samsung NX mount	Samsung NX mount	Samsung NX mount
Optical Image Stabilizer	Not Included	Included	Included
Minimum Focus Distance	0.25 m ~ infinity	0.28 m ~ infinity	0.98 m ~ infinity
Maximum Magnification	Approx. 0.16X	Approx. 0.22X	Approx. 0.2X
Lens Hood	Optional	Included	Included
Filter Size	43 mm	58 mm	52 mm
Max. Diameter x Length	61.5 x 21.5 mm	63 x 65.1 mm	70 x 100.5 mm
Weight	Approx. 85 g (without hood)	Approx. 198 g (without hood)	Approx. 417 g (without hood)
Operating Temperature	0 ~ 40 °C	0 ~ 40 °C	0 ~ 40 °C
Operating Humidity	5 ~ 85 %	5 ~ 85 %	5 ~ 85 %

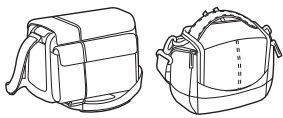
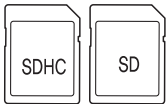
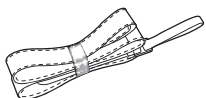
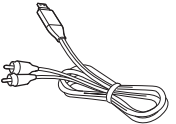

Lens may differ from your actual items.

# Accessories (optional)

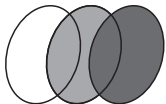
	<p><b>Camera bag</b> You can purchase the camera bag separately.</p>
	<p><b>Memory card</b> This camera accepts SD (Secure Digital) and SDHC (Secure Digital High Capacity) memory card.</p>
	<p><b>Strap</b> You can additionally purchase the straps.</p>
	<p><b>A/V cable</b> You can connect to other devices by using the A/V cable.</p>
	<p><b>Shutter release</b> Shutter release reduces shakiness when used with a tripod.</p>
	<p><b>Filter</b> You can create different colored effects by attaching filters to your lens.</p>

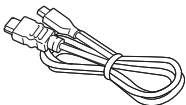
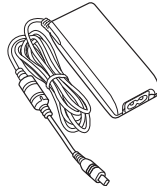
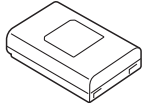
	<p><b>HDMI cable</b> You can view high-definition photos and videos by connecting the camera to an HDMI-compatible monitor with the HDMI (HDMI type D) cable.</p>
	<p><b>Adapter</b> You can charge the battery by connecting the adapter to the power outlet.</p>
	<p><b>Battery pack</b> You can purchase additional battery packs.</p>



- These illustrations may differ from your actual items. Refer to the user manuals of these optional accessories for details.
- Use only Samsung-approved accessories. Samsung is not responsible for damage caused by using another manufacturer's accessories.

# Index

## A

Aperture 11, 15  
Auto focus 58

## B

Battery  
  life 119  
  specifications 119  
Bracketing 65, 67

## C

Camera  
  connecting as removable disk 105  
  connecting to PC 105  
  disconnecting (Windows) 106  
  layout 25  
Color space 57

## D

Depth of Field (DOF) 12, 17  
Digital Print Order Format (DPOF) 103  
Drive (see Shooting method) 65

## E

Exposure Value (EV) 12, 75

## F

Fader 77

### Files

  deleting 81  
  editing RAW format 111  
  photo format 51  
  protecting 81  
  transferring to Mac 106  
  transferring to PC 105  
  video format 51

Flash 69

  bounce photography 22  
  guide number 21

F-number 12

Focal length 16

## I

i-Function 43  
Intelli-Studio 107  
ISO sensitivity 14, 15, 52

## L

### Lenses

  layout 31  
  locking 32  
  markings 34  
  specifications 129  
  unlocking 32

## M

Maintenance 116  
Memory card 117  
Metering 71  
MF assist 64

## O

Optical Image Stabilization (OIS) 74  
Optional accessories  
  attach the electronic viewfinder 38  
  attach the GPS module 37  
  connect the flash 35  
  flash layout 35  
  GPS module layout 36

## P

### Photos

  adjusting tone 112  
  editing 87  
  enlarging 83  
  shooting options 50  
  viewing on camera 80  
  viewing on HDTV 101  
  viewing on TV 100

Photo styles 56

PictBridge 102

Picture Wizard 56

Posture 10

## R

Red-eye effect 70

Rule of thirds 19

## S

Samsung RAW Converter 110

Shooting method 65

Shooting modes

Aperture Priority 41

Auto focus (AF) 58

Lens Priority 42

Manual 42

Movie 47

Program 40

Scene 45

Shutter Priority 41

Smart Auto 39

Shutter speed 13, 15

Slide show 83

Smart Album 81

## T

Timer 66

## V

Videos

options 77

viewing 85



**Correct Disposal of This Product  
(Waste Electrical & Electronic Equipment)**

(Applicable in the European Union and other European countries with separate collection systems)

This marking on the product, accessories or literature indicates that the product and its electronic accessories (e.g. charger, headset, USB cable) should not be disposed of with other household waste at the end of their working life. To prevent possible harm to the environment or human health from uncontrolled waste disposal, please separate these items from other types of waste and recycle them responsibly to promote the sustainable reuse of material resources. Household users should contact either the retailer where they purchased this product, or their local government office, for details of where and how they can take these items for environmentally safe recycling. Business users should contact their supplier and check the terms and conditions of the purchase contract. This product and its electronic accessories should not be mixed with other commercial wastes for disposal.



**Correct disposal of batteries in this product**

(Applicable in the European Union and other European countries with separate battery return systems)

This marking on the battery, manual or packaging indicates that the batteries in this product should not be disposed of with other household waste at the end of their working life. Where marked, the chemical symbols Hg, Cd or Pb indicate that the battery contains mercury, cadmium or lead above the reference levels in EC Directive 2006/66. If batteries are not properly disposed of, these substances can cause harm to human health or the environment.

To protect natural resources and to promote material reuse, please separate batteries from other types of waste and recycle them through your local, free battery return system.

This Class [B] digital apparatus complies with Canadian ICES-003.

# FCC notice

**NOTE:**

This equipment has been tested and found to comply with the limits for a Class B digital device, pursuant to part 15 of the FCC Rules. These limits are designed to provide reasonable protection against harmful interference in a residential installation. This equipment generates, uses and can radiate radio frequency energy and, if not installed and used in accordance with the instructions, may cause harmful interference to radio communications. However, there is no guarantee that interference will not occur in a particular installation. If this equipment does cause harmful interference to radio or television reception, which can be determined by turning the equipment off and on, the user is encouraged to try to correct the interference by one or more of the following measures:

- Reorient, or relocate, the receiving antenna.
- Increase the distance between the equipment and receiver.
- Connect the equipment into an outlet on a circuit different from that to which the receiver is connected.
- Consult the dealer or an experienced radio / TV technician for help.

**CAUTION:**

Changes or modifications not expressly approved by the manufacturer responsible for compliance could void the user's authority to operate the equipment.

**Declaration of Conformity**

Trade Name : Samsung Electronics America, Inc.

Model No. : Samsung NX100

Responsible Party : Samsung Electronics America, Inc.

Address : 85 Challenger Road, Ridgely Park, NJ 07660

Telephone No. : 1-800-SAMSUNG (726-7864)

This device complies with Part 15 of the FCC Rules.

Operation is subject to the following two conditions:

(1) This device may not cause harmful interference, and (2) this device must accept any interference received, including interference that may cause undesired operation.





Please refer to the warranty that came with your product or visit our website <http://www.samsungimaging.com/> or <http://www.samsung.com/> for after-sales service or inquiries.

