

User's Guide

CLX-330x/330xW Series
CLX-330xFN/330xFW Series

BASIC

This guide provides information concerning installation, basic operation and troubleshooting on windows.

ADVANCED

This guide provides information about installation, advanced configuration, operation and troubleshooting on various OS environments.

Some features may not be available depending on models or countries.



1. Introduction

Key benefits	5
Features by models	7
Useful to know	12
About this user's guide	13
Safety information	14
Machine overview	20
Control panel overview	24
Turning on the machine	30
Installing the driver locally	31
Reinstalling the driver	33



2. Menu Overview and Basic Setup

Menu overview	35
Machine's basic settings	41
Media and tray	43
Basic printing	55
Basic copying	61
Basic scanning	65
Basic faxing	66

Using USB memory device	70
-------------------------	----



3. Maintenance

Ordering supplies and accessories	76
Available supplies	77
Available maintenance parts	78
Storing the toner cartridge	79
Redistributing toner	81
Replacing the toner cartridge	83
Replacing the waste toner container	85
Replacing the imaging unit	87
Monitoring the supplies life	89
Setting the toner low alert	90
Cleaning the machine	91
Tips for moving & storing your machine	96



4. Troubleshooting

Tips for avoiding paper jams	98
Clearing original document jams	99
Clearing paper jams	104
Understanding the status LED	110

Understanding display messages 112



5. Appendix

Specifications 119

Regulatory information 128

Copyright 141



1. Introduction

This chapter provides information you need to know before using the machine.

- **Key benefits** 5
- **Features by models** 7
- **Useful to know** 12
- **About this user's guide** 13
- **Safety information** 14
- **Machine overview** 20
- **Control panel overview** 24
- **Turning on the machine** 30
- **Installing the driver locally** 31
- **Reinstalling the driver** 33

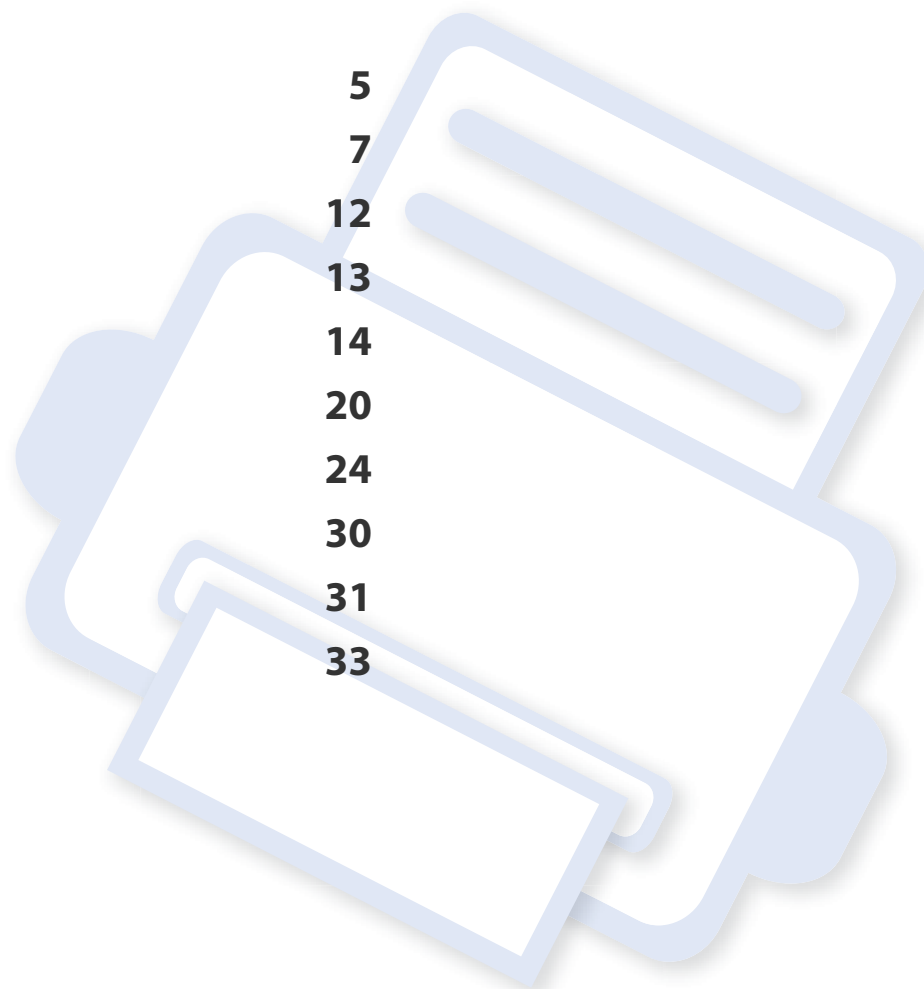

Key benefits

Environmentally friendly



- To save toner and paper, this machine supports Eco feature (see "Eco printing" on page 59).
- To save paper, you can print multiple pages on one single sheet of paper (see "Using advanced print features" on page 220).
- To save paper, you can print on both sides of the paper (double-sided printing) (Manual) (see "Using advanced print features" on page 220).
- To save electricity, this machine automatically conserves electricity by substantially reducing power consumption when not in use.
- We recommend using recycled paper for saving energy.

Fast high resolution printing



- You can print in a full range of colors using cyan, magenta, yellow, and black.
- You can print with a resolution of up to 2,400 x 600 dpi effective output (600 x 600 x 2 bit).

- Fast, on-demand printing.
 - For single-side black and white printing, 18 ppm (A4) or 19 ppm (Letter).
 - For single-side color printing, 4 ppm (A4 or Letter).

Convenience



- You can print on the go from your smartphone or computer using Google Cloud Print enabled apps (see "Google Cloud Print" on page 190).
- Easy Capture Manager allows you to easily edit and print whatever you captured using the Print Screen key on the keyboard (see "Easy Capture Manager" on page 250).
- Samsung Easy Printer Manager and Printing Status is a program that monitors and informs you of the machine's status and allows you to customize the machine's settings (see "Using Samsung Easy Printer Manager" on page 257 or "Using Samsung Printer Status" on page 265).
- Samsung Easy Document Creator is an application to help users compile and share large documents or other scanned or faxed information digitally. (see "Using Samsung Easy Document Creator" on page 260).
- AnyWeb Print helps you screen-capture, preview, scrap, and print the screen of Windows Internet Explorer more easily, than when you use the ordinary program (see "Samsung AnyWeb Print" on page 252).
- Smart Update allows you to check for the latest software and install the latest version during the printer driver installation process. This is available only for Windows.

Key benefits

- If you have Internet access, you can get help, support application, machine drivers, manuals, and order information from the Samsung website, www.samsung.com > find your product > Support or Downloads.

Wide range of functionality and application support



- Supports various paper sizes (see "Print media specifications" on page 121).
- Print watermark: You can customize your documents with words, such as "**CONFIDENTIAL**" (see "Using advanced print features" on page 220).
- Print posters: The text and pictures of each page of your document are magnified and printed across the multiple sheets of paper and can then be taped together to form a poster (see "Using advanced print features" on page 220).
- You can print in various operating systems (see "System requirements" on page 123).
- Your machine is equipped with a USB interface and/or a network interface.

Supports various wireless network setting method



- Using the WPS (Wi-Fi Protected Setup™) button
 - You can easily connect to a wireless network using the WPS button on the machine and the access point (a wireless router).
- Using the USB cable or a network cable
 - You can connect and set various wireless network settings using a USB cable or a network cable.
- Using the Wi-Fi Direct
 - You can conveniently print from your mobile device using the Wi-Fi or Wi-Fi Direct feature.



See "Introducing wireless set up methods" on page 165.

Features by models

Some features and optional goods may not be available depending on model or country.

Operating System

Operating System	CLX-330x Series CLX-330xW Series	CLX-330xFN Series CLX-330xFW Series
Windows	•	•
Mac	•	•
Linux	•	•

(•: Included, Blank: Not available)

Features by models

Software



You can install the printer driver and software when you insert the software CD into your CD-ROM drive.

For windows, select the printer driver and software in the **Select Software to Install** window.

Software		CLX-330x Series CLX-330xW Series	CLX-330xFN Series CLX-330xFW Series
SPL printer driver		•	•
PCL printer driver		•	•
PS printer driver		•	•
XPS printer driver ^a		•	•
Samsung Easy Printer Manager	Scan to PC settings	•	•
	Fax to PC settings		•
	Device Settings	•	•
Samsung Easy Document Creator		•	•
Samsung Easy Color Manager ^b		•	•
Samsung Printer Status		•	•
AnyWeb Print ^b		•	•

Features by models

Software		CLX-330x Series CLX-330xW Series	CLX-330xFN Series CLX-330xFW Series
SyncThru™ Web Service		● (CLX-330xW Series only)	●
SyncThru Admin Web Service		● (CLX-330xW Series only)	●
Easy Eco Driver		●	●
Fax	Samsung Network PC Fax		●
Scan	Twain scan driver	●	●
	WIA scan driver	●	●
	Samsung Scan Assistant^b	●	●

a. For XPS/PS driver, You can install the XPS/PS printer driver in the **Custom Installation** window (Refer to Software CD that was provided with your machine).

b. Download the software from the Samsung website and install it: (<http://www.samsung.com> > find your product > Support or Downloads). Before installing, check whether your computer's OS support the software.

(●: Included, Blank: Not available)

Features by models

Variety feature

Features	CLX-330x Series CLX-330xW Series	CLX-330xFN Series CLX-330xFW Series
Hi-Speed USB 2.0	●	●
Network Interface Ethernet 10/100 Base TX wired LAN	● (CLX-330xW Series only)	●
Network Interface 802.11b/g/n wireless LAN ^a	● (CLX-330xW Series only)	● (CLX-330xFW Series only)
Google Cloud Print™	●	●
Eco printing (Control panel)	●	●
Duplex (2-sided) printing (Manual) ^b	●	●
USB memory interface	●	●
Automatic Document Feeder (ADF)		●

a. Depending on your country, wireless LAN card may not be available. For some countries, only 802.11 b/g can be applied. Contact your local Samsung dealer or the retailer where you bought your machine.

b. Windows only.

(●: Included, Blank: Not available)

Features by models

Features		CLX-330x Series CLX-330xW Series	CLX-330xFN Series CLX-330xFW Series
Fax	Multi-send		•
	Delay send		•
	Priority send		•
	Secure receive		•
	Send/ Receive forward - fax		•
Scan	Scan to PC	•	•
Copy	ID card copying	•	•
	Reduced or enlarged copying	•	•
	Collation	•	•
	2-up/4-up	•	•
	Adjust background	•	•

(•: Included, Blank: Not available)

Useful to know



The machine does not print.

- Open the print queue list and remove the document from the list (see "Canceling a print job" on page 56).
- Remove the driver and install it again (see "Installing the driver locally" on page 31).
- Select your machine as your default machine in your Windows (see "Setting your machine as a default machine" on page 219).



Where can I purchase accessories or supplies?

- Inquire at a Samsung distributor or your retailer.
- Visit www.samsung.com/supplies. Select your country/region to view product service information.



The status LED flashes or remains constantly on.

- Turn the product off and on again.
- Check the meanings of LED indications in this manual and troubleshoot accordingly (see "Understanding the status LED" on page 110).



A paper jam has occurred.

- Open and close the scan unit (see "Front view" on page 21).
- Check the instructions on removing jammed paper in this manual and troubleshoot accordingly (see "Clearing paper jams" on page 104).



Printouts are blurry.

- The toner level might be low or uneven. Shake the toner cartridge (see "Redistributing toner" on page 81).
- Try a different print resolution setting (see "Opening printing preferences" on page 57).
- Replace the toner cartridge (see "Replacing the toner cartridge" on page 83).



Where can I download the machine's driver?

- You can get help, support application, machine drivers, manuals, and order information from the Samsung website, www.samsung.com > find your product > Support or Downloads.

About this user's guide

This user's guide provides information for your basic understanding of the machine as well as detailed steps to explain machine usage.



- Read the safety information before using the machine.
- If you have a problem using the machine, refer to the troubleshooting chapter.
- Terms used in this user's guide are explained in the glossary chapter.
- All illustrations in this user's guide may differ from your machine depending on its options or model you purchased.
- The screenshots in this administrator's guide may differ from your machine depending on the machine's firmware/driver version.
- The procedures in this user's guide are mainly based on Windows 7.

Conventions

Some terms in this guide are used interchangeably, as below:

- Document is synonymous with original.
- Paper is synonymous with media, or print media.
- Machine refers to printer or MFP.

General icons



Icon	Text	Description
	Caution	Gives users information to protect the machine from possible mechanical damage or malfunction.
	Note	Provides additional information or detailed specification of the machine function and feature.

Safety information

These warnings and precautions are included to prevent injury to you and others, and to prevent any potential damage to your machine. Be sure to read and understand all of these instructions before using the machine. After reading this section, keep it in a safe place for future reference.

Important safety symbols

Explanation of all icons and signs used in this chapter

	Warning	Hazards or unsafe practices that may result in severe personal injury or death.
	Caution	Hazards or unsafe practices that may result in minor personal injury or property damage.
		Do not attempt.

Operating environment

Warning



Do not use if the power cord is damaged or if the electrical outlet is not grounded.

This could result in electric shock or fire.



Do not place anything on top of the machine (water, small metal or heavy objects, candles, lit cigarettes, etc.).

This could result in electric shock or fire.

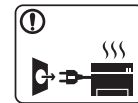

- If the machine gets overheated, it releases smoke, makes strange noises, or generates an odd odor, immediately turn off the power switch and unplug the machine.

- The user should be able to access the power outlet in case of emergencies that might require the user to pull the plug out.

This could result in electric shock or fire.



Do not bend, or place heavy objects on the power cord.

Stepping on or allowing the power cord to be crushed by a heavy object could result in electric shock or fire.







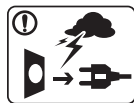

Do not remove the plug by pulling on the cord; do not handle the plug with wet hands.

This could result in electric shock or fire.







Safety information

Caution

	<p>During an electrical storm or for a period of non-operation, remove the power plug from the electrical outlet.</p> <p>This could result in electric shock or fire.</p>
	<p>Be careful, the paper output area is hot.</p> <p>Burns could occur.</p>
	<p>If the machine has been dropped, or if the cabinet appears damaged, unplug the machine from all interface connections and request assistance from qualified service personnel.</p> <p>Otherwise, this could result in electric shock or fire.</p>
	<p>If the machine does not operate properly after these instructions have been followed, unplug the machine from all interface connections and request assistance from qualified service personnel.</p> <p>Otherwise, this could result in electric shock or fire.</p>
	<p>If the plug does not easily enter the electrical outlet, do not attempt to force it in.</p> <p>Call an electrician to change the electrical outlet, or this could result in electric shock.</p>
	<p>Do not allow pets to chew on the AC power, telephone or PC interface cords.</p> <p>This could result in electric shock or fire and/or injury to your pet.</p>

Operating method

Caution

	<p>Do not forcefully pull the paper out during printing.</p> <p>It can cause damage to the machine.</p>
	<p>Be careful not to put your hand between the machine and paper tray.</p> <p>You may get injured.</p>
	<p>Be care when replacing paper or removing jammed paper.</p> <p>New paper has sharp edges and can cause painful cuts.</p>
	<p>When printing large quantities, the bottom part of the paper output area may get hot. Do not allow children to touch.</p> <p>Burns can occur.</p>
	<p>When removing jammed paper, do not use tweezers or sharp metal objects.</p> <p>It can damage the machine.</p>
	<p>Do not allow too many papers to stack up in the paper output tray.</p> <p>It can damage the machine.</p>

Safety information



Do not block or push objects into the ventilation opening.
This could result in elevated component temperatures which can cause damage or fire.



Use of controls or adjustments or performance of procedures other than those specified herein may result in hazardous radiation exposure.



This machine's power reception device is the power cord.
To switch off the power supply, remove the power cord from the electrical outlet.

Installation / Moving

Warning



Do not place the machine in an area with dust, humidity, or water leaks.
This could result in electric shock or fire.



Caution



Before moving the machine, turn the power off and disconnect all cords. The information below are only suggestions based on the units weight.

If you have a medical condition that prevents you from lifting, do not lift the machine. Ask for help, and always use the appropriate amount of people to lift the device safely.

Then lift the machine:

- If the machine weighs under 20 kg (44.09 lbs), lift with 1 person.
- If the machine weighs 20 kg (44.09 lbs) - 40 kg (88.18 lbs), lift with 2 people.
- If the machine weighs more than 40 kg (88.18 lbs), lift with 4 or more people.

The machine could fall, causing injury or machine damage.

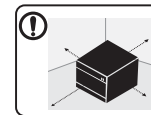







Choose a flat surface with enough space for ventilation to place the machine. Also consider the space required to open the cover and trays.

The place should be well-ventilated and be far from direct light, heat, and humidity.



When using the machine for a long period of time or printing a large number of pages in a non-ventilated space, it could pollute the air and be harmful to your health. Place the machine in a well-ventilated space or open a window to circulate the air periodically.





Safety information

	Do not place the machine on an unstable surface. The machine could fall, causing injury or machine damage.
	Use only No.26 AWG ^a or larger, telephone line cord, if necessary. Otherwise, it can cause damage to the machine.
	Make sure you plug the power cord into a grounded electrical outlet. Otherwise, this could result in electric shock or fire.
	Use the power cord supplied with your machine for safe operation. If you are using a cord which is longer than 2 meters (6 feet) with a 110V machine, then the gauge should be 16 AWG or larger. Otherwise, it can cause damage to the machine, and could result in electric shock or fire.
	Do not put a cover over the machine or place it in an airtight location, such as a closet. If the machine is not well-ventilated, this could result in fire.
	Do not overload wall outlets and extension cords. This can diminish performance, and could result in electric shock or fire.
	The machine should be connected to the power level which is specified on the label. If you are unsure and want to check the power level you are using, contact the electrical utility company.



a. AWG: American Wire Gauge

Maintenance / Checking

Caution

	Unplug this product from the wall outlet before cleaning the inside of the machine. Do not clean the machine with benzene, paint thinner or alcohol; do not spray water directly into the machine. This could result in electric shock or fire.
	When you are working inside the machine replacing supplies or cleaning the inside, do not operate the machine. You could get injured.
	Keep cleaning supplies away from children. Children could get hurt.
	Do not disassemble, repair or rebuild the machine by yourself. It can damage the machine. Call a certified technician when the machine needs repairing.





Safety information

	<p>To clean and operate the machine, strictly follow the user's guide provided with the machine.</p> <p>Otherwise, you could damage the machine.</p>
	<p>Keep the power cable and the contact surface of the plug clean from dust or water.</p> <p>Otherwise, this could result in electric shock or fire.</p>
	<ul style="list-style-type: none">• Do not remove any covers or guards that are fastened with screws.• Fuser units should only be repaired by a certified service technician. Repair by non-certified technicians could result in fire or electric shock.• The machine should only be repaired by a Samsung service technician.

Supply usage

Caution

	<p>Do not disassemble the toner cartridge.</p> <p>Toner dust can be dangerous if inhaled or ingested.</p>
--	---

	<p>Do not burn any of the supplies such as toner cartridge or fuser unit.</p> <p>This could cause an explosion or uncontrollable fire.</p>
	<p>When storing supplies such as toner cartridges, keep them away from children.</p> <p>Toner dust can be dangerous if inhaled or ingested.</p>
	<p>For supplies that contain toner dust (toner cartridge, waste toner bottle, imaging unit, etc.) follow the instructions below.</p> <ul style="list-style-type: none">• When disposing of the supplies, follow the instructions for disposal. Refer to the reseller for disposal instructions.• Do not wash the supplies.• For a waste toner bottle, do not reuse it after emptying the bottle. <p>If you do not follow the instructions above, it may cause machine malfunction and environmental pollution. The warranty does not cover damages caused by a user's carelessness.</p>
	<p>Using recycled supplies, such as toner, can cause damage to the machine.</p> <p>In case of damage due to the use of recycled supplies, a service fee will be charged.</p>
	<p>When toner gets on your clothing, do not use hot water to wash it.</p> <p>Hot water sets toner into fabric. Use cold water.</p>

Safety information



When changing the toner cartridge or removing jammed paper, be careful not to let toner dust touch your body or clothes.

Toner dust can be dangerous if inhaled or ingested.

Machine overview

Accessories

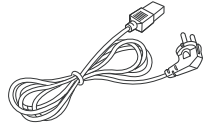

Power cord

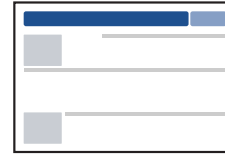

Quick installation guide

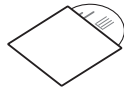

Software CD^a

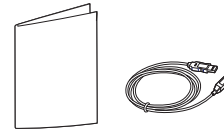

Misc. accessories^b

a. The software CD contains the print drivers, user's guide, and software applications.

b. Miscellaneous accessories included with your machine may vary by country of purchase and specific model.

Machine overview

Front view



- This illustration may differ from your machine depending on your model. There are various types of machine.
- Some features and optional goods may not be available depending on model or country (see "Features by models" on page 7).

4	Front door	10	Scan unit ^{a b}
5	Output support	11	USB port
6	Control panel	12	Scanner glass

- a. Close the scanner lid before opening the scan unit.
b. Be careful not to pinch your fingers.

CLX-330x Series / CLX-330xW Series

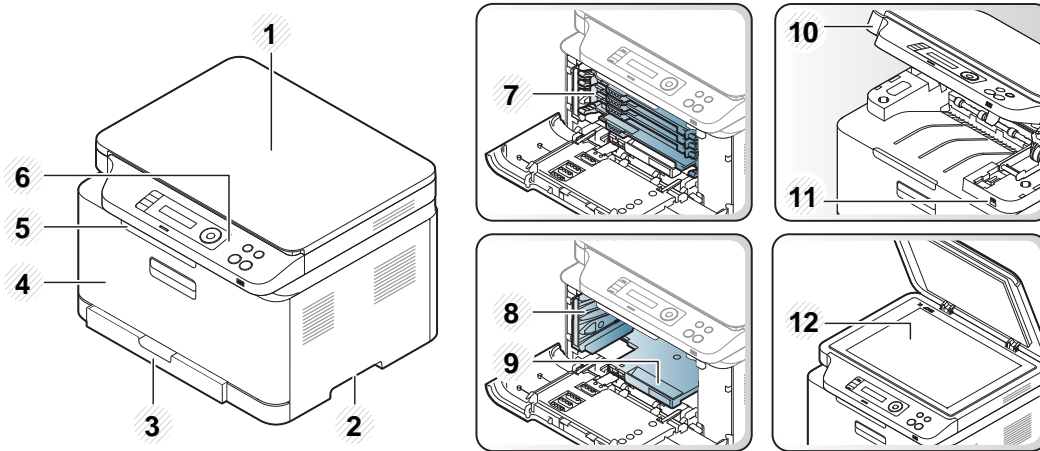

1	Scanner lid	7	Toner cartridges
2	Handle	8	Waste toner container
3	Tray	9	Imaging unit

Machine overview

CLX-330xFN Series / CLX-330xFW Series

b. Be careful not to pinch your fingers.

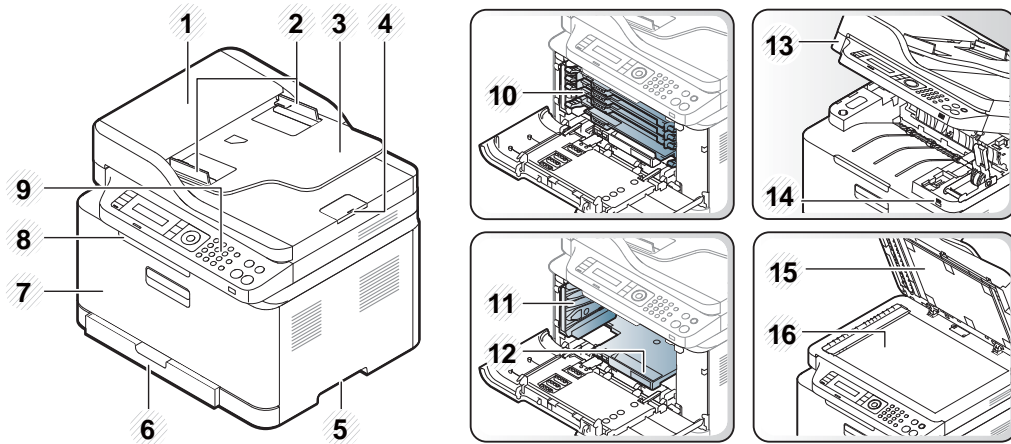

1	Document feeder cover	9	Control panel
2	Document feeder width guide	10	Toner cartridge
3	Document feeder input tray	11	Waste toner container
4	Document feeder output support	12	Imaging unit
5	Handle	13	Scan unit ^{a b}
6	Tray	14	USB port
7	Front cover	15	Scanner lid
8	Document output tray	16	Scanner glass

a. Close the scanner lid before opening the scan unit.

Machine overview

Rear view



- This illustration may differ from your machine depending on your model. There are various types of machine.
- Some features and optional goods may not be available depending on model or country (see "Features by models" on page 7).

CLX-330x Series / CLX-330xW Series

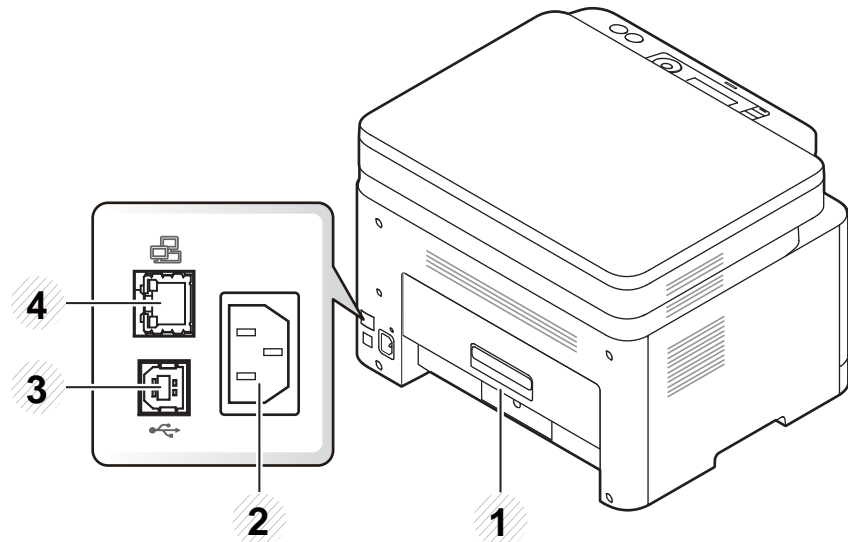

1	Rear cover	3	USB port
---	------------	---	----------

2	Power receptacle	4	Network port ^a
---	------------------	---	---------------------------

a. CLX-330xW Series only.

CLX-330xFN Series / CLX-330xFW Series

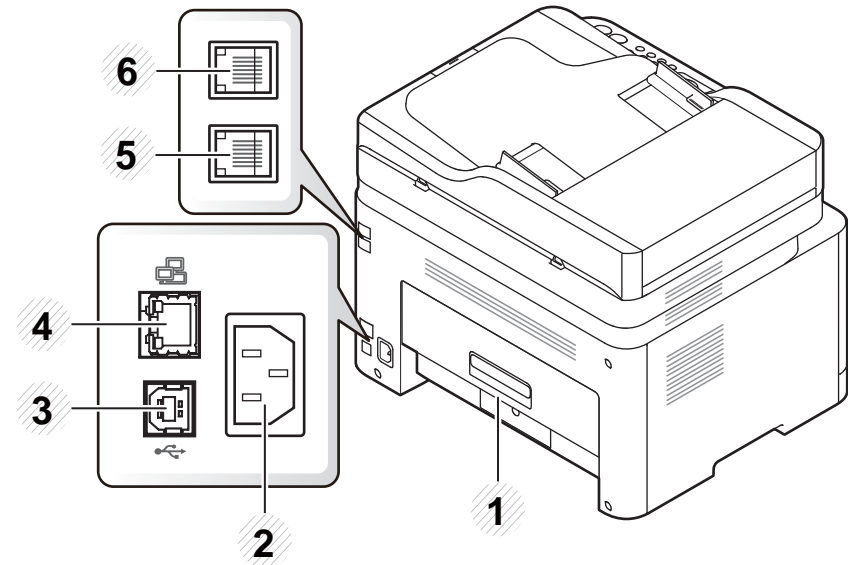

1	Rear cover	5	Telephone line socket (LINE)
2	Power receptacle	6	Extension telephone socket (EXT.)
3	USB port		
4	Network port		

Control panel overview





- This control panel may differ from your machine depending on its model. There are various types of control panels.
- Some features and optional goods may not be available depending on model or country (see "Features by models" on page 7).

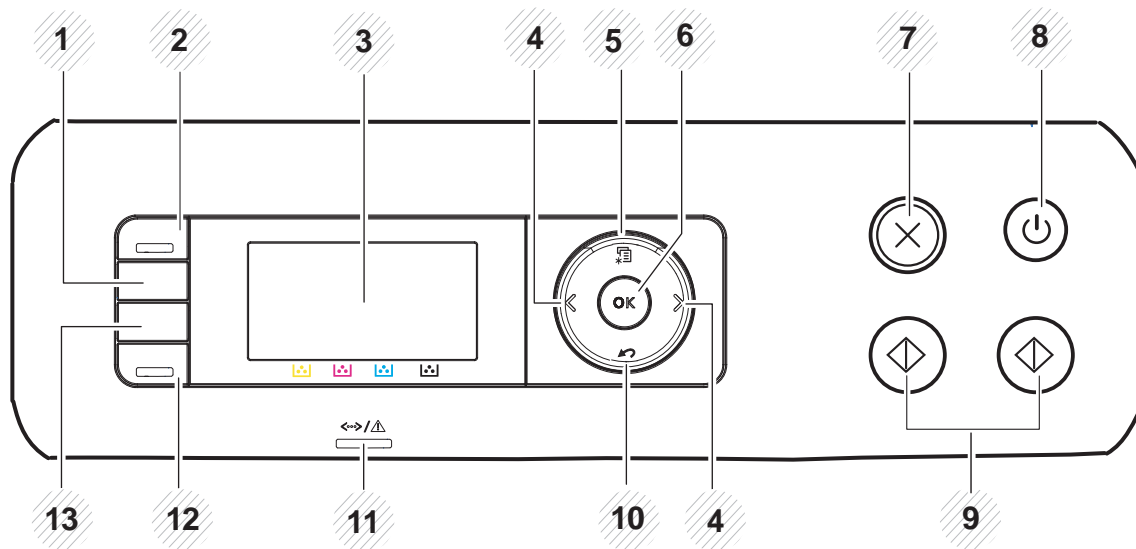

CLX-330x Series / CLX-330xW Series



Control panel overview

1	WPS^a		Configures the wireless network connection easily without a computer (see "Using the WPS button" on page 166).
	Print Screen^b		<p>Press this button and the display will Print Screen? on the display screen. If you want to print only the active screen, select the Active. If you want to print the whole screen, select Full.</p> <div><ul style="list-style-type: none">• Print Screen can only be used in the Windows and Mac operating systems.• You can only use this function with USB-connected machine.• When printing the active window/whole monitor screen using the print screen button, the machine may use more toner depending on what is being printed.• You can only use this function if the machine's Samsung Easy Printer Manager program is installed. If you are a Mac OS user, you need to enable Screen Print Settings from the Samsung Easy Printer Manager to use the Print Screen feature.</div>
2	Scan to		Switches between scan and copy mode. The Scan to LED turns on on scan mode and turns off on copy mode.
3	Display screen		Shows the current status and displays prompts during an operation.
4	Arrows		Scrolls through the options available in the selected menu and increases or decreases values.
5	Menu		Opens Menu mode and scrolls through the available menus (see "Menu overview" on page 35).
6	OK		Confirms the selection on the screen.
7	Stop/Clear		Stops an operations at any time.

Control panel overview

8	Power/ Wakeup		Turns the power on or off, or wakes up the machine from the power save mode. If you need to turn the machine off, press this button for more than three seconds when the machine is in ready mode.
9	Start		Starts a job.
10	Back		Sends you back to the upper menu level.
11	Status LED		Indicates the status of your machine (see "Understanding the status LED" on page 110).
12	Eco		Turn into eco mode to reduce toner consumption and paper usage when pc-printing and copying only (see "Eco printing" on page 59).
13	Direct USB		Allows you to directly print files stored on a USB memory device when it is inserted into the USB port on the front of your machine.

a. CLX-330xW Series only.

b. CLX-330x Series only.





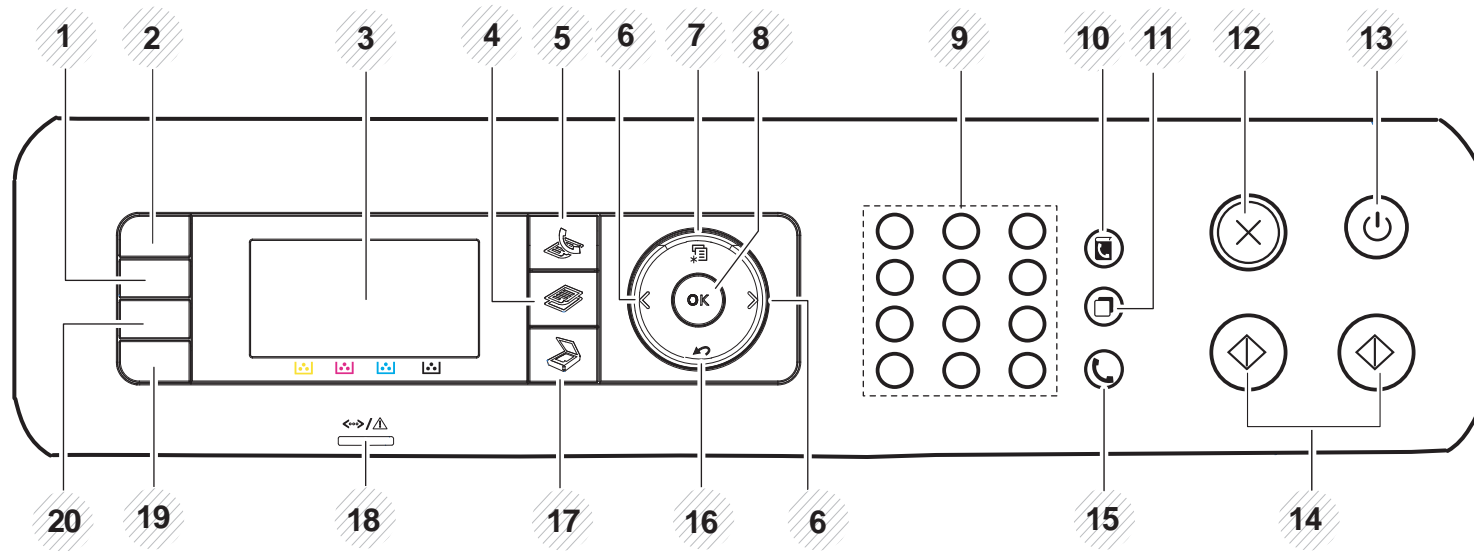



Control panel overview

CLX-330xFN Series / CLX-330xFW Series



1	WPS^a	Configures the wireless network connection easily without a computer (see "Using the WPS button" on page 166).
	Darkness^b	Adjusts the brightness level to make a copy for easier reading, when the original contains faint markings and dark images.
2	ID Copy	Allows you to copy both sides of an ID card like a driver's license on a single side of paper (see "ID card copying" on page 63).
3	Display screen	Shows the current status and displays prompts during an operation.
4	Copy	Switches to Copy mode.
5	Fax	Switches to Fax mode.

Control panel overview

6	Arrows		Scrolls through the options available in the selected menu and increases or decreases values.
7	Menu		Opens Menu mode and scrolls through the available menus (see "Menu overview" on page 35).
8	OK		Confirms the selection on the screen.
9	Numeric keypad		Dials a number or enters alphanumeric characters (see "Keypad letters and numbers" on page 215).
10	Address Book		Allows you to store frequently used fax numbers or search for stored fax numbers (see "Setting up the fax address book" on page 216).
11	Redial/ Pause		Redials the recently sent fax number or received caller ID in ready mode, or inserts a pause(-) into a fax number in edit mode (see "Redialing the fax number" on page 240).
12	Stop/ Clear		Stops an operations at any time.
13	Power/ Wakeup		Turns the power on or off, or wakes up the machine from the power save mode. If you need to turn the machine off, press this button for more than three seconds when the machine is in ready mode.
14	Start		Starts a job.
15	On Hook Dial		When you press this button, you can hear a dial tone. Then enter a fax number. It is similar to making a call using speaker phone (see "Receiving manually in Tel mode" on page 246).
16	Back		Sends you back to the upper menu level.
17	Scan		Switches to Scan mode.
18	Status LED		Indicates the status of your machine (see "Understanding the status LED" on page 110).

Control panel overview

19	Eco	Turn into eco mode to reduce toner consumption and paper usage when pc-printing and copying only (see "Eco printing" on page 59).
20	Direct USB	Allows you to directly print files stored on a USB memory device when it is inserted into the USB port on the front of your machine.

a. CLX-330xFW Series only.

b. CLX-330xFN Series only.

Turning on the machine

- 1 Connect the machine to the electricity supply first.
Turn the switch on if the machine has a power switch.

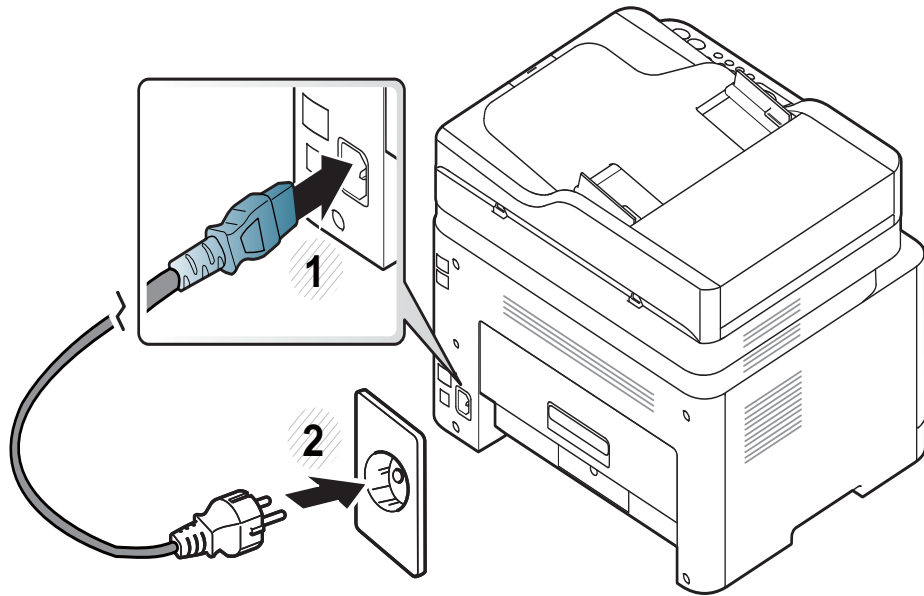

 Illustrations on this user's guide may differ from your machine depending on its options or models. Check your machine type (see "Front view" on page 21).

- 2 Power is turned on automatically.
For CLX-330x/330xW Series, press  (**Power/Wakeup**) button on the control panel.



If you want to turn the power off, press and hold  (**Power/Wakeup**) button for about 3 seconds.

Installing the driver locally

A locally connected machine is a machine directly attached to your computer using the cable. If your machine is attached to a network, skip the following steps below and go on to installing a network connected machine's driver (see "Installing driver over the network" on page 155).



- If you are a Mac or Linux operating systems user, refer to the "Installation for Mac" on page 146 or "Installation for Linux" on page 148.
- The installation window in this User's Guide may differ depending on the machine and interface in use.
- Only use a USB cable no longer than 3 meters (118 inches).

Windows

- 1 Insert the supplied software CD into your CD-ROM drive.
If the installation window does not appear, click **Start > All programs > Accessories > Run**.
X:\Setup.exe replacing "X" with the letter, which represents your CD-ROM drive and click **OK**.
- 2 Read and check **The software End User License Agreement** and **Using Enhanced Features and Participating in Printer Usage Information Collection Program** (optional). Then, click **Next**.

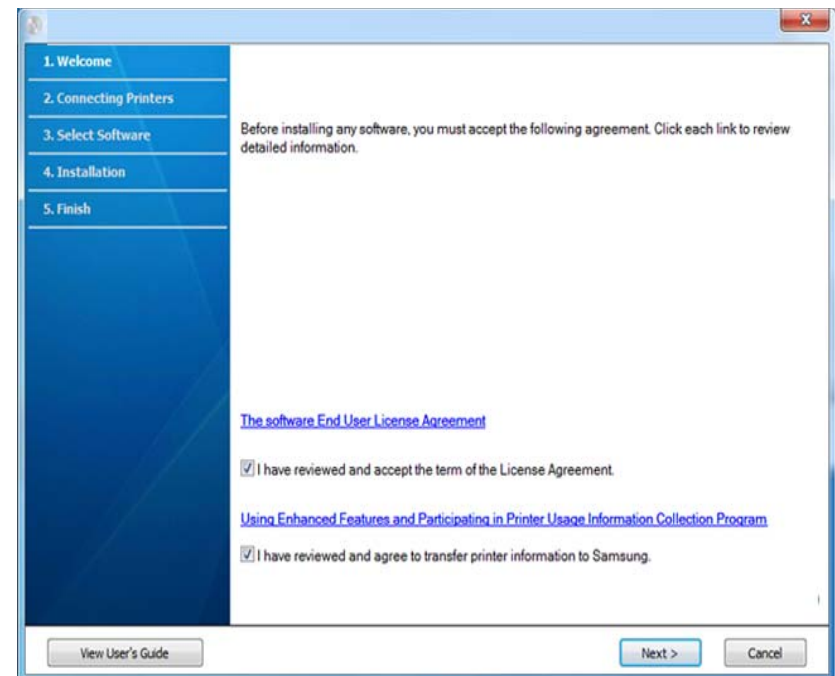

Installing the driver locally

3 Follow the instructions in the installation window.



You can select the software applications in the **Select Software to Install** Window.

Reinstalling the driver

If the printer driver does not work properly, follow the steps below to reinstall the driver.

Windows

- 1** From the **Start** menu, select **Programs** or **All Programs** > **Samsung Printers** > **your printer driver name** > **Uninstall**.
- 2** Follow the instructions in the installation window.
- 3** Insert the software CD into your CD-ROM drive and install the driver again (see "Installing the driver locally" on page 31).



2. Menu Overview and Basic Setup

This chapter provides information about the overall menu structure and the basic setup options.

- **Menu overview** 35
- **Machine's basic settings** 41
- **Media and tray** 43
- **Basic printing** 55
- **Basic copying** 61
- **Basic scanning** 65
- **Basic faxing** 66
- **Using USB memory device** 70





Menu overview

The control panel provides access to various menus to set up the machine or use the machine's functions.



- Some menus may not appear on the display depending on options or models. If so, it is not applicable to your machine.
- Some menu names may differ from your machine depending on its options or the models.
- The menus are described in the Advanced Guide (see "Useful Setting Menus" on page 193).

Accessing the menu

- 1 Select the Fax, Copy, or Scan button on the control panel depending on the feature to be used.
- 2 Select  (**Menu**) until the menu you want appears on the bottom line of the display and press **OK**.
- 3 Press the arrows until the needed menu item appears and press **OK**.
- 4 If the setting item has sub menus, repeat step 3.
- 5 Press **OK** to save the selection.
- 6 Press  (**Stop/Clear**) to return to the ready mode.

Menu overview

Fax Feature ^a		Fax Setup ^a	
Darkness	Send Forward	Sending	Change Default
Normal	Forward to Fax	Redial Times	Resolution
Dark+1- Dark+5	Rcv. Forward	Redial Term	Darkness
Light+5- Light+1	Forward to Fax	Prefix Dial	Original Size
Resolution	Forward to PC	ECM Mode	Auto Report
Standard	Forward&Print	Fax Confirm.	On
Fine	Secure Receive	Image TCR	Off
Super Fine	Off	Dial Mode^b	Manual TX/RX
Photo Fax	On	Receiving	On
Original Size	Print	Receive Mode	Off
Multi Send	Add Page	Ring To Answer	
Delay Send	Cancel Job	Stamp RCV Name	
Priority Send		RCV Start Code	
		Auto Reduction	
		Discard Size	
		Junk Fax Setup	
		DRPD Mode^b	

a. CLX-330xFN Series/ CLX-330xFW Series only.

b. This option may not be available depending on your country.

Menu overview

Copy Feature		Copy Setup
Original Size	Adjust Bkgd.	Change Default
Reduce/Enlarge	Off	Original Size
Darkness	Auto	Copies
Normal	Enhance Lev.1	Copy Collation
Dark+1- Dark+5	Enhance Lev.2	Reduce/Enlarge
Light+5- Light+1	Erase Lev.1- Erase Lev.4	Darkness
Original Type		Original Type
Text/Photo		Adjust Bkgd.
Photo		
Magazine		
Text		
Layout		
Normal		
2-Up		
4-Up		
ID Copy		

Menu overview

Scan Feature	Scan Setup	Print Setup	
USB Feature	Change Default	Orientation	Screen
Original Size	USB Default	Portrait	Enhance
Original Type		Landscape	Detailed
Resolution		Copies	Normal
Color Mode		[1 - 999]	Clear Text
File Format		Resolution	Off
Darkness		Normal	Minimum
		Best	Normal
		Trapping	Maximum
		Off	Auto CR
		Normal	LF
		Maximum	LF+CR
		Document Type	Emulation
		Standard	Emulation Type
		Photo	Setup
		Biz Graphic	
		CAD	
		Web Page	

Menu overview

System Setup			
Machine Setup Machine ID ^a Fax Number ^a Date & Time ^a Clock Mode ^a Language Power Save Auto Power Off ^b Wakeup Event System Timeout Job Timeout Altitude Adj. Humidity Auto Continue Paper Substit. PrintBlankPage Eco Settings	Paper Setup Paper Size Paper Type Margin Sound/Volume ^a Key Sound Alarm Sound Speaker Ringer	Report Configuration Supplies Info. Demo Page Address Book ^a Fax Confirm. ^a Fax Sent ^a Fax Received ^a Schedule Jobs ^a Junk Fax ^a Network Conf. ^c Usage Counter Fax Options ^a	Maintenance CLR Empty Msg. ^d Supplies Life Image Mgr. Custom Color Tone Adjust. Serial Number TonerLow Alert

a. CLX-330xFN Series/ CLX-330xFW Series only.

b. CLX-330x Series/CLX-330xW Seriesonly

c. CLX-330xW Series/ CLX-330xFN Series/ CLX-330xFW Seriesonly.

d. This option only appears when small amount of toner is left in the cartridge.

Menu overview

Network ^a	
TCP/IP (IPv4)	Wireless
DHCP	Wi-Fi ON/OFF^b
BOOTP	Wi-Fi Direct^b
Static	WPS Setting^b
TCP/IP (IPv6)	WLAN Setting^c
IPv6 Activate	WLAN Default^b
DHCPv6 Config	WLAN Signal^b
Ethernet Speed	Clear Setting
Automatic	Network Conf.
10Mbps Half	Protocol Mgr.
10Mbps Full	Net. Activate
100Mbps Half	Http Activate
100Mbps Full	WINS
	SNMP V1/V2
	UPnP(SSDP)
	MDNS
	SetIP
	SLP

a. CLX-330xW Series/ CLX-330xFN Series/ CLX-330xFW Series only.

b. CLX-330xW Series/ CLX-330xFW Series only.

c. CLX-330xFW Series only.

Machine's basic settings



- You can set the machine's settings by using the **Device Settings** in Samsung Easy Printer Manager program.
 - For Windows and Mac users, you set from **Samsung Easy Printer Manager** > **(Switch to advanced mode)** > **Device Settings**, see "Device Settings" on page 259.
- It may be necessary to press **OK** to navigate to lower-level menus for some models.

After installation is complete, you may want to set the machine's default settings.

To change the machine's default settings, follow these steps:



It may be necessary to press **OK** to navigate to lower-level menus for some models.

- 1 Select **(Menu)** button on the control panel.
- 2 Press **System Setup** > **Machine Setup**.

3

Select the option you want, then press **OK**.

- **Language:** change the language that is displayed on the control panel.
- **Date & Time:** When you set the time and date, they are used in delay fax and delay print. They are printed on reports. If, however, they are not correct, you need to change it for the correct time being.



Enter the correct time and date using arrows or numeric keypad (see "Keypad letters and numbers" on page 215).

- Month = 01 to 12
- Day = 01 to 31
- Year = requires four digits
- Hour = 01 to 12
- Minute = 00 to 59

- **Clock Mode:** You can set your machine to display the current time using either a 12-hour or 24-hour format.
- **Power Save:** When you are not using the machine for a while, use this feature to save power.

Machine's basic settings



- When you press the **Power/Wakeup** button, start printing, or a fax is received, the product will wake up from the power saving mode.
- Press  (**Menu**) > **System Setup** > **Machine Setup** > **Wakeup Event** > **On** on the control panel. When you press any button except **Power/Wakeup** button, the machine wake up from the power save mode.

- **Altitude Adjust:** Print quality is affected by atmospheric pressure, which atmospheric pressure is determined by the height of the machine above sea level. Before you set the altitude value, determine the altitude where you are (see "Altitude adjustment" on page 214).

4 Select the option you want, then press **OK**.

5 Press **OK** to save the selection.

6 Press  (**Stop/Clear**) to return to ready mode.



Refer to below links to set other settings useful for using the machine.

- See "Entering various characters" on page 215.
- See "Keypad letters and numbers" on page 215.
- See "Setting the paper size and type" on page 49.
- See "Setting up the fax address book" on page 216.

Media and tray

This chapter provides information on how to load print media into your machine.



- Using print media that does not meet these specifications may cause problems or require repairs. Such repairs are not covered by Samsung's warranty or service agreements.
- Make sure not to use the inkjet photo paper with this machine. It could cause damage to the machine.
- Using inflammable print media can cause a fire.
- Use designated print media (see "Print media specifications" on page 121).



The use of inflammable media or foreign materials left in the printer may lead to overheating of the unit and, in rare cases may cause a fire.

Tray overview

To change the size, you need to adjust the paper guides.

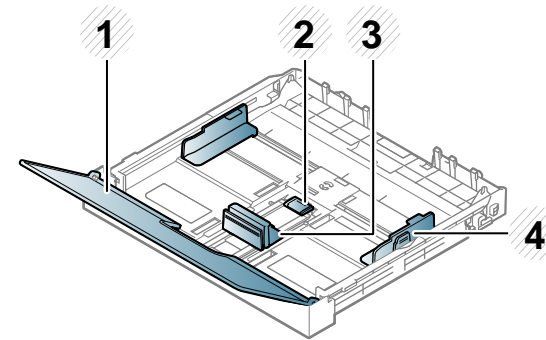

- 1 Paper cover
- 2 Guide lock
- 3 Paper length guide
- 4 Paper width guide



If you do not adjust the guide, it may cause paper registration, image skew, or jamming of the paper.

Media and tray

Loading paper in the tray



Illustrations on this user's guide may differ from your machine depending on its options or models. Check your machine type (see "Front view" on page 21).

- 1 Pull out the paper tray (see "Tray overview" on page 43).

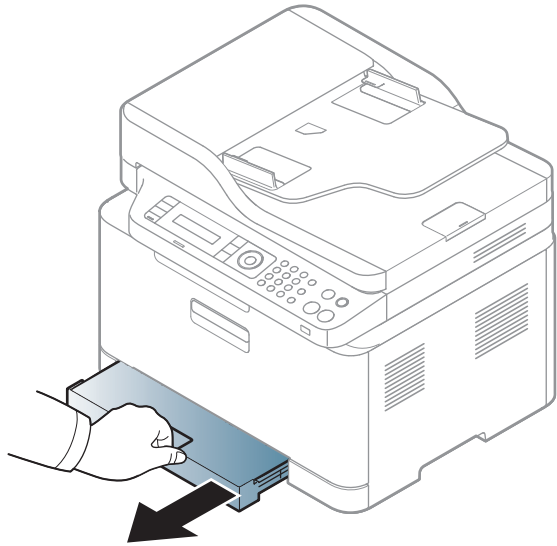

- 2 Open the paper cover.

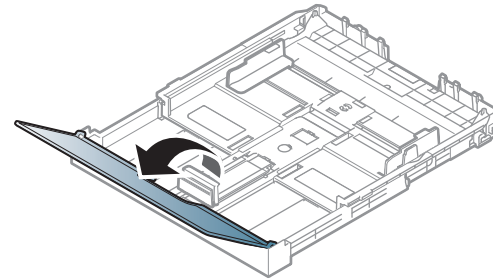

- 3 Press and unlatch the guide lock in the tray, pull the tray out manually. Then adjust the paper length guide and paper width guide.

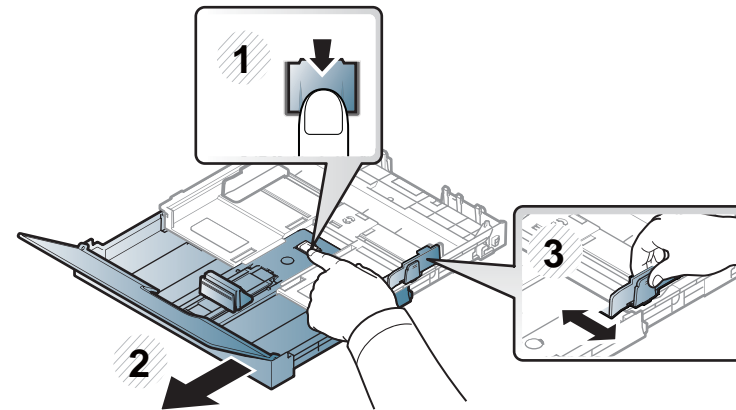

- 4 Flex or fan the edge of the paper stack to separate the pages before loading papers.

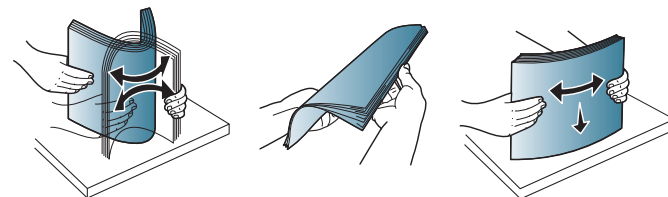

Media and tray

- 5 Place the paper with the side you want to print facing up.

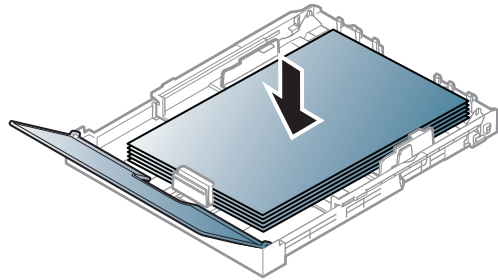

For paper smaller than Letter-sized, press and unlatch the guide lock in the tray, push the tray in manually. Then adjust the paper length guide and paper width guide.

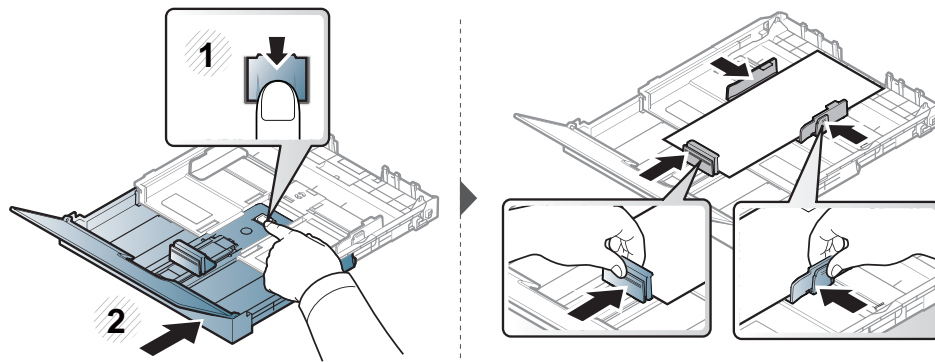

For paper longer than Legal-sized, press and unlatch the guide lock in the tray, pull the tray out manually. Then adjust the paper length guide and paper width guide.

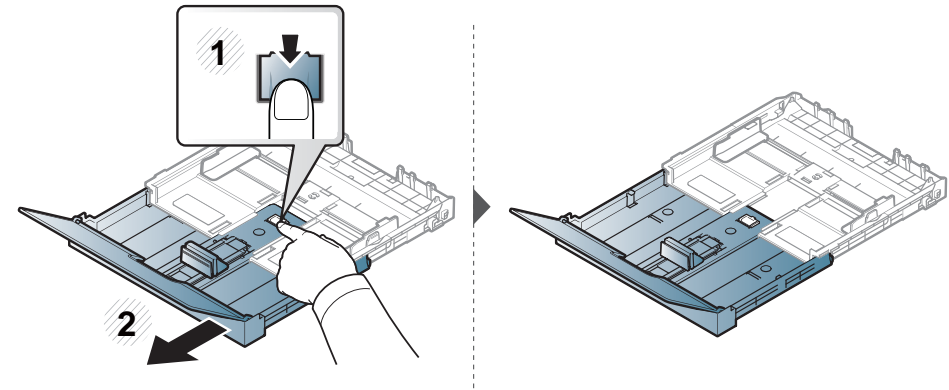

- Do not push the paper width guide too far causing the media to warp.
- Do not use a paper with a leading-edge curl, it may cause a paper jam or the paper can be wrinkled.
- If you do not adjust the paper width guide, it may cause paper jams.

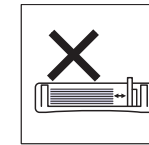
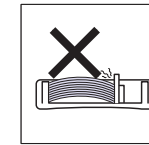
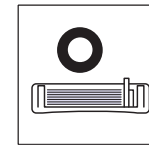

Media and tray

- 6 Squeeze the paper width guide and slide it to the edge of the paper stack without causing it to bend.

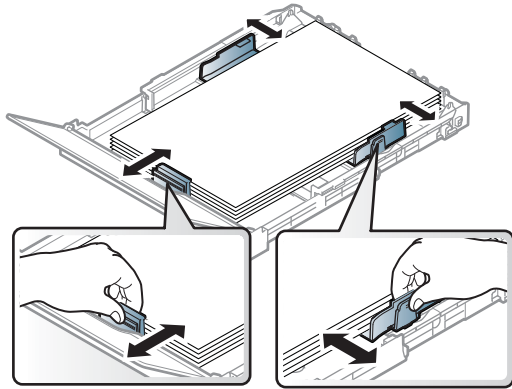

- 7 Close the paper cover.

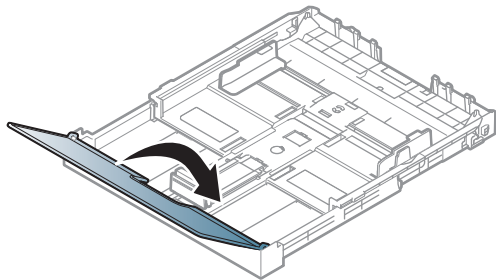

- 8 Insert the paper tray.

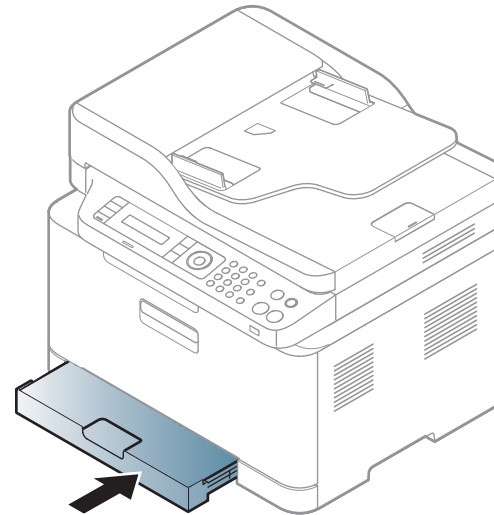

- 9 When you print a document, set the paper type and size for the tray (see "Setting the paper size and type" on page 49).



The settings made from the machine driver override the settings on the control panel.

- a To print in application, open an application and start the print menu.
- b Open **Printing Preferences** (see "Opening printing preferences" on page 57).
- c Press the **Paper** tab in **Printing Preferences**, and select an appropriate paper type.
For example, if you want to use a label, set the paper type to **Label**.
- d Select **Auto Select** (or **Manual Feeder**) in paper source, then press **OK**.
- e Start printing in application.

Media and tray

Printing on special media

The table below shows the special media usable in tray.

The media is also shown in the **Printing Preferences**. To get the highest printing quality, select the proper media type from the **Printing preferences** window > **Paper** tab > **Paper Type** (see "Opening printing preferences" on page 57).

For example, if you want to print on labels, select **Labels** for **Paper Type**.



- When using special media, we recommend you feed one sheet at a time (see "Print media specifications" on page 121).
- Illustrations on this user's guide may differ from your machine depending on its options or models. Check your machine type (see "Front view" on page 21).

To see for paper weights for each sheet, refer to "Print media specifications" on page 121.

Types	Tray ^a
Plain	•
Thick	•
Thin	•

Types	Tray ^a
Bond	•
Color	•
CardStock	•
Labels	•
Preprinted	•
Cotton	•
Recycled	•
Archive	•
Glossy Photo	•
Matte Photo	•

a. The paper types available manual feeding in tray.

(●: Supported, Blank: Not supported)

Media and tray

Labels

To avoid damaging the machine, use only labels designed for use in laser printers.

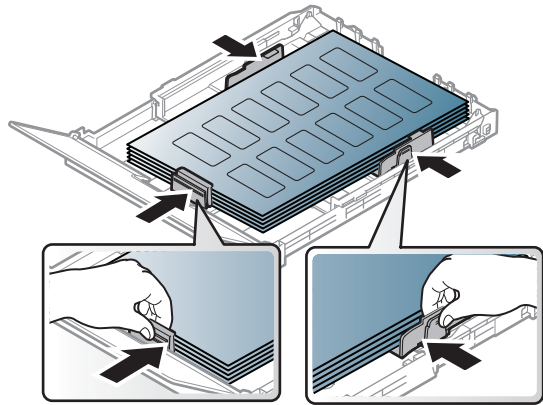

- When selecting labels, consider the following factors:
 - **Adhesives:** Should be stable at your machine's fusing temperature about 170°C (338°F).
 - **Arrangement:** Only use labels with no exposed backing between them. Labels can peel off sheets that have spaces between the labels, causing serious jams.
 - **Curl:** Must lie flat with no more than 13 mm of curl in any direction.
 - **Condition:** Do not use labels with wrinkles, bubbles, or other indications of separation.
- Make sure that there is no exposed adhesive material between labels. Exposed areas can cause labels to peel off during printing, which can cause paper jams. Exposed adhesive can also cause damage to machine components.

- Do not run a sheet of labels through the machine more than once. The adhesive backing is designed for only a single pass through the machine.
- Do not use labels that are separating from the backing sheet or are wrinkled, bubbled, or otherwise damaged.

Card stock/ Custom-sized paper

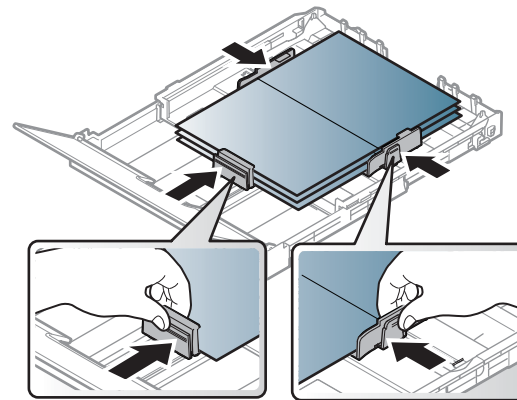

- In the software application, set the margins to at least 6.4 mm (0.25 inches) away from the edges of the material.

Media and tray

Preprinted paper

When loading preprinted paper, the printed side should be facing up with an uncurled edge at the front. If you experience problems with paper feeding, turn the paper around. Note that print quality is not guaranteed.

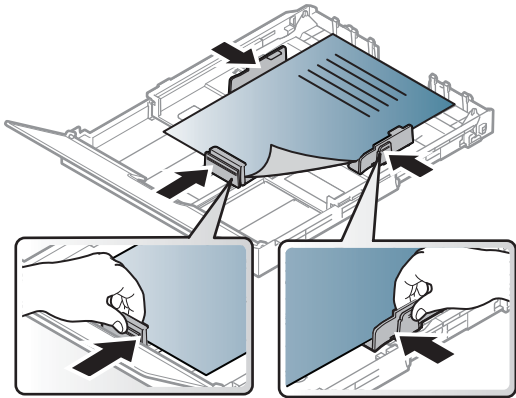

- Must be printed with heat-resistant ink that will not melt, vaporize, or release hazardous emissions when subjected to the machine's fusing temperature for 0.1 second (about 170°C (338°F)).
- Preprinted paper ink must be non-flammable and should not adversely affect machine rollers.
- Before you load preprinted paper, verify that the ink on the paper is dry. During the fusing process, wet ink can come off preprinted paper, reducing print quality.

Setting the paper size and type

After loading paper in the paper tray, set the paper size and type using the control panel buttons.



- You can set the machine's settings by using the **Device Settings** in Samsung Easy Printer Manager program.
 - For Windows and Mac users, you set from **Samsung Easy Printer Manager** >  **(Switch to advanced mode)** > **Device Settings**, see "Device Settings" on page 259.
- It may be necessary to press **OK** to navigate to lower-level menus for some models.



It may be necessary to press **OK** to navigate to lower-level menus for some models.

- 1 Select  (**Menu**) button on the control panel.
- 2 Press **System Setup** > **Paper Setup** > **Paper Size** or **Paper Type**.
- 3 Select the tray and the option you want.
- 4 Press **OK** to save the selection.

Media and tray

5 Press  (**Stop/Clear**) to return to ready mode.



- The settings set from the machine driver override the settings on the control panel.
 - a To print from an application, open an application and start the print menu.
 - b Open **Printing Preferences** (see "Opening printing preferences" on page 57).
 - c Press the **Paper** tab and select an appropriate paper.
- If you want to use special-sized paper such as billing paper, select the **Paper** tab > **Size** > **Edit...** and set **Custom Paper Size Settings** in the **Printing Preferences** (see "Opening printing preferences" on page 57).

Using the output support



The surface of the output tray may become hot if you print a large number of pages at once. Make sure that you do not touch the surface, and do not allow children near it.

The printed pages stack on the output support, and the output support will help the printed pages to align. The printer sends output to the output tray by default.

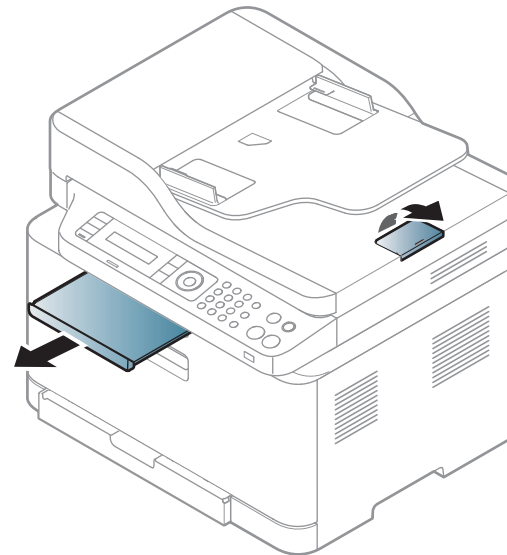

Media and tray



Illustrations on this user's guide may differ from your machine depending on its options or models. Check your machine type (see "Front view" on page 21).

Preparing originals

- Do not load paper smaller than 142 x 148 mm (5.6 x 5.8 inches) or larger than 216 x 356 mm (8.5 x 14 inches).
- Do not attempt to load the following s of paper, in order to prevent paper jam, low print quality and machine damage.
 - Carbon-paper or carbon-backed paper
 - Coated paper
 - Onion skin or thin paper
 - Wrinkled or creased paper
 - Curled or rolled paper
 - Torn paper
- Remove all staples and paper clips before loading.
- Make sure any glue, ink, or correction fluid on the paper is completely dry before loading.
- Do not load originals that include different sizes or weights of paper.

- Do not load booklets, pamphlets, transparencies, or documents with other unusual characteristics.

Loading originals

You can use the scanner glass or the document feeder to load an original for copying, scanning, and sending a fax.



Illustrations on this user's guide may differ from your machine depending on its options or models. Check your machine type (see "Front view" on page 21).

On the scanner glass

Using the scanner glass, you can copy or scan originals. You can get the best scan quality, especially for colored or gray-scaled images. Make sure that no originals are in the document feeder. If an original is detected in the document feeder, the machine gives it priority over the original on the scanner glass.

Media and tray

- 1 Lift and open the scanner lid.

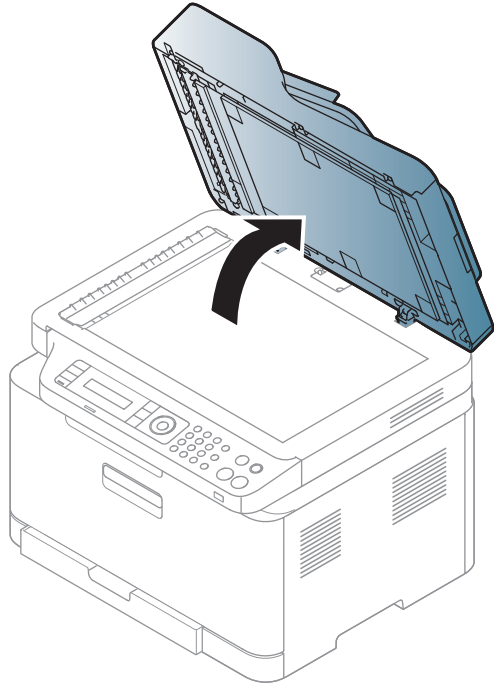

- 2 Place the original face down on the scanner glass. Align it with the registration guide at the top left corner of the glass.

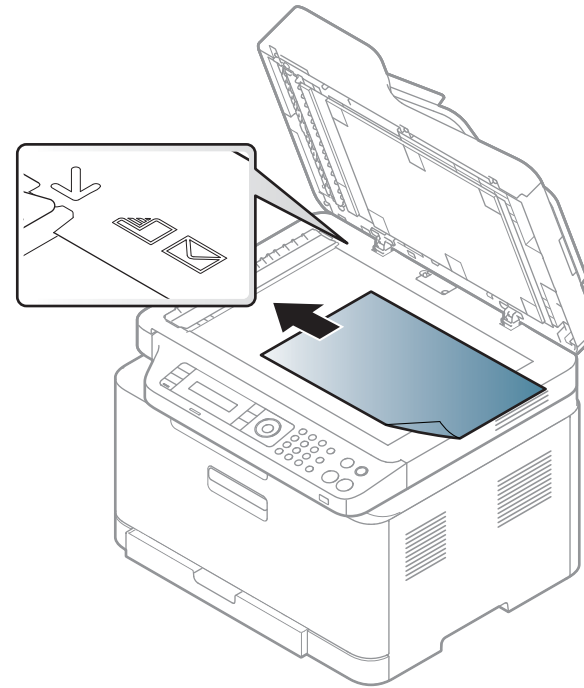

- 3 Close the scanner lid.

Media and tray



- Leaving the scanner lid open while copying may affect copy quality and toner consumption.
- Dust on the scanner glass may cause black spots on the printout. Always keep it clean (see "Cleaning the machine" on page 91).
- If you are copying a page from a book or magazine, lift the scanner lid until its hinges are caught by the stopper and then close the lid. If the book or magazine is thicker than 30 mm, start copying with the scanner lid open.



- Be careful not to break the scanner glass. You may get hurt.
- Do not put hands while closing the scanner lid. The scanner lid may fall on your hands and get hurt.
- Do not look the light from inside of the scanner while copying or scanning. It is harmful to eyes.

In the document feeder

- 1 Flex or fan the edge of the paper stack to separate the pages before loading originals.

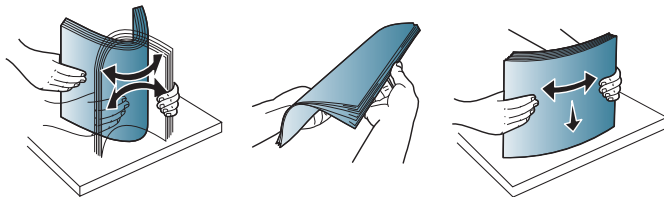

2

- 2 Load the original face up into the document feeder input tray. Make sure that the bottom of the original stack matches the paper size marked on the document input tray.

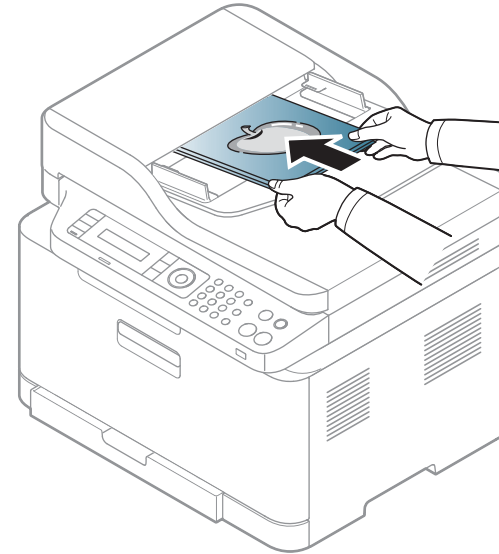

Media and tray

- 3 Adjust the document feeder width guides to the paper size.

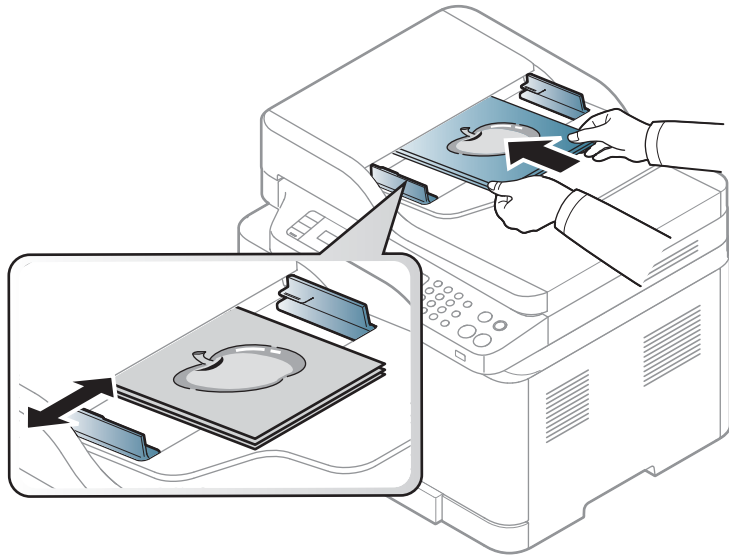

Dust on the document feeder glass may cause black lines on the printout. Always keep the glass clean (see "Cleaning the machine" on page 91).

Basic printing



For special printing features, refer to the Advanced Guide (see "Using advanced print features" on page 220).

Printing



If you are a Mac or Linux operating systems user, refer to the Advanced Guide (see "Mac printing" on page 226 or "Linux printing" on page 228).

The following **Printing Preferences** window is for Notepad in Windows 7.

- 1 Open the document you want to print.
- 2 Select **Print** from the **File** menu.

- 3 Select your machine from the **Select Printer** list.

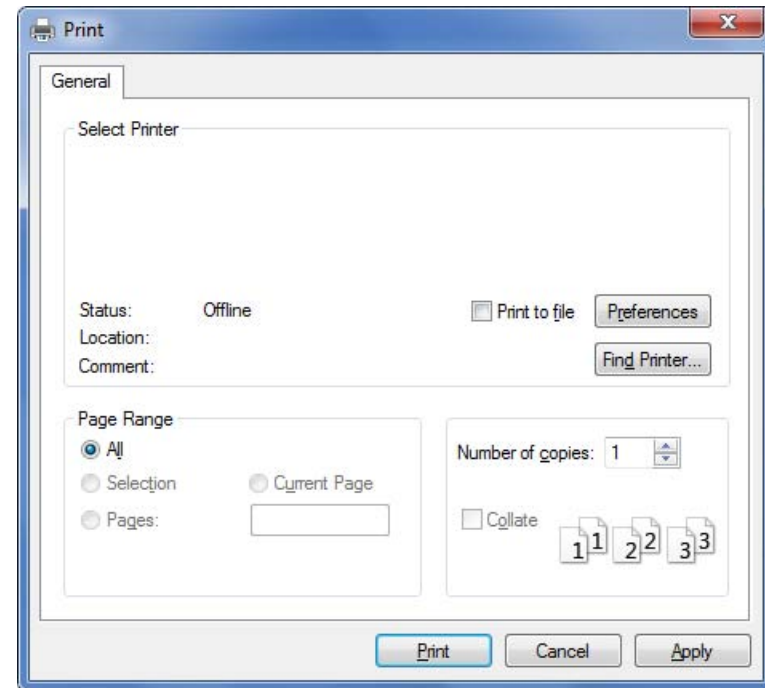

- 4 The basic print settings including the number of copies and print range are selected within the **Print** window.





To take advantage of the advanced printing features, click **Properties** or **Preferences** from the **Print** window (see "Opening printing preferences" on page 57).

- 5 To start the print job, click **OK** or **Print** in the **Print** window.

Basic printing

Canceling a print job





If the print job is waiting in the print queue or print spooler, cancel the job as follows:

- You can access this window by simply double-clicking the machine icon () in the Windows task bar.
- You can also cancel the current job by pressing  (**Stop/Clear**) on the control panel.

Basic printing

Opening printing preferences



- The **Printing Preferences** window that appears in this user's guide may differ depending on the machine in use.
- When you select an option in **Printing Preferences**, you may see a warning mark  or . An  mark means you can select that certain option but it is not recommended, and an  mark means you cannot select that option due to the machine's setting or environment.

- 1 Open the document you want to print.
- 2 Select **Print** from the file menu. The **Print** window appears.
- 3 Select your machine from the **Select Printer**.

4 Click **Properties** or **Preferences**.

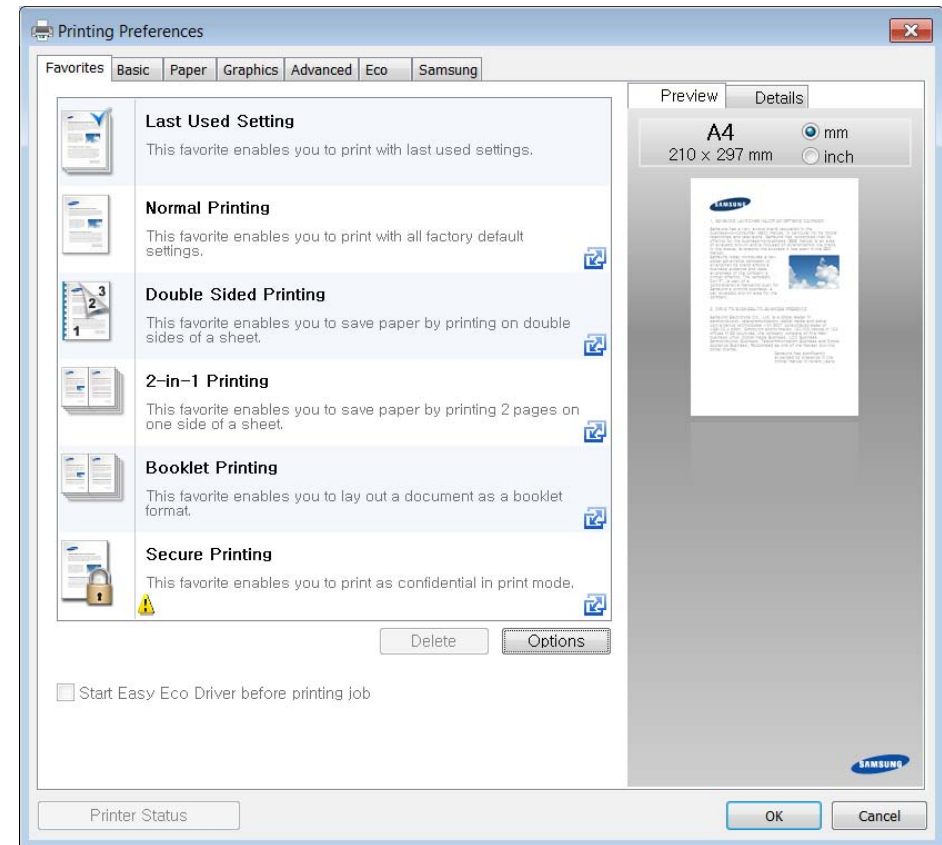

- You can apply **Eco** features to save paper and toner before printing (see "Easy Eco Driver" on page 253).
- You can check the machine's current status pressing the **Printer Status** button (see "Using Samsung Printer Status" on page 265).

Basic printing

Using a favorite setting

The **Favorites** option, which is visible on each preferences tab except for the **Samsung** tab, allows you to save the current preferences for future use.

To save a **Favorites** item, follow these steps:

- 1 Change the settings as needed on each tab.
- 2 Enter a name for the item in the **Favorites** input box.

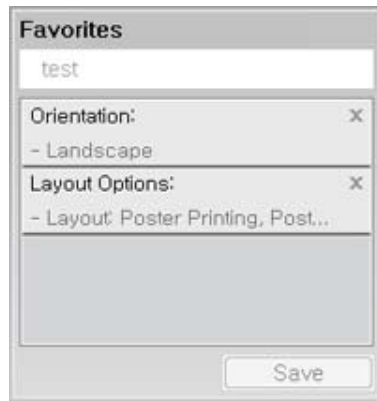

- 3 Click **Save**.
- 4 Enter name and description, and then select the desired icon.
- 5 Click **OK**. When you save **Favorites**, all current driver settings are saved.



To use a saved setting, select it in the **Favorites** tab. The machine is now set to print according to the settings you have selected.

To delete saved settings, select it in the **Favorites** tab and click **Delete**.

Using help

Click the option you want to know on the **Printing Preferences** window and press **F1** on your keyboard.

Basic printing

Eco printing

The **Eco** function cuts toner consumption and paper usage. The **Eco** function allows you to save print resources and lead you to eco-friendly printing.

If you press the **Eco** button from the control panel, eco mode is enabled. The default setting of Eco mode is **Multiple Pages per Side (2)** and **Toner Save**.

Setting Eco mode on the control panel



- You can set the machine's settings by using the **Device Settings** in Samsung Easy Printer Manager program.
 - For Windows and Mac users, you set from **Samsung Easy Printer Manager** >  **(Switch to advanced mode)** > **Device Settings**, see "Device Settings" on page 259.
- It may be necessary to press **OK** to navigate to lower-level menus for some models.



- The settings set from the machine's driver override the settings on the control panel.
- It may be necessary to press **OK** to navigate to lower-level menus for some models.

1 Select  (**Menu**) > **System Setup** > **Machine Setup** > **Eco Settings** on the control panel.

2 Select the option you want and press **OK**.

- **Default Mode:** Select this to turn on or off the eco mode.
 - **Off:** Set the eco mode off.
 - **On:** Set the eco mode on.



If you set the eco mode on with a password from the SyncThru™ Web Service (**Settings** tab > **Machine Settings** > **System** > **Eco** > **Settings**) or Samsung Easy Printer Manager (**Device Settings** > **Eco**), the **On force** message appears. You have to enter the password to change the eco mode status.

- **Select Temp.:** Follow the settings from SyncThru™ Web Service or Samsung Easy Printer Manager. Before you select this item, you must set the eco function in SyncThru™ Web Service (**Settings** tab > **Machine Settings** > **System** > **Eco** > **Settings**) or Samsung Easy Printer Manager (**Device Settings** > **Eco**).
 - **Default Eco:** The machine is set to **Default Eco** mode.
 - **Custom Eco:** Change any necessary values.

3 Press **OK** to save the selection.

Basic printing

Setting eco mode on the driver

Open the Eco tab to set Eco mode. When you see the eco image (), that means the eco mode is currently enabled.

Eco options

- **Printer Default:** Follows the settings from the machine's control panel.
- **None:** Disables Eco mode.
- **Eco Printing:** Enables eco mode. Activate the various Eco items you want to use.
- **Password:** If the administrator fixed to enable the Eco mode, you have to enter the password to change the status.

Result simulator

Result Simulator shows the results of reduced emission of carbon dioxide, used electricity, and the amount of saved paper in accordance with the settings you selected.

- The results are calculated on the basis that the total number of printed paper is one hundred without a blank page when the Eco mode is disabled.
- Refers to the calculation coefficient about CO₂, energy, and paper from **IEA**, the index of Ministry of Internal Affairs and Communication of Japan and www.remanufacturing.org.uk. Each model has a different index.
- The power consumption in printing mode refers to the average printing power consumption of this machine.

- The actual amount displayed is only an estimate as the actual amount may differ depending on the operating system used, computing performance, application software, connection method, media type [thickness], media size, job complexity, etc.

Basic copying





For special printing features, refer to the Advanced Guide (see "Copy" on page 196).



If you need to cancel the copying job during the operation, press  (**Stop/Clear**) and the copying will stop.

Basic copy

- 1 CLX-330x Series/CLX-330xW Series: Make sure that the **Scan to** button's LED is off.

CLX-330xFN Series/CLX-330xFW Series: Select  (copy) on the control panel.
- 2 Place a single document face down on the document glass, or load the documents face up into the document feeder (see "Loading originals" on page 51).
- 3 If you want to customize the copy settings including **Reduce/Enlarge**, **Darkness**, **Contrast**, **Original Type**, and more by using the control panel buttons (see "Changing the settings for each copy" on page 61).
- 4 Enter the number of copies using the arrow or number keypad, if necessary.
- 5 Press  (**Start**).

Changing the settings for each copy

Your machine provides default settings for copying so that you can quickly and easily make a copy.



- If you press the  (**Stop/Clear**) button twice while setting the copy options, all of the options you have set for the current copy job will be canceled and returned to their default status. Or, they will automatically return to their default status after the machine completes the copy in progress.
- Accessing menus may differ from model to model (see "Accessing the menu" on page 35).
- It may be necessary to press **OK** to navigate to lower-level menus for some models.

Darkness

If you have an original containing faint marking and dark images, you can adjust the brightness to make a copy that is easier to read.

Basic copying

- 1 CLX-330x Series/CLX-330xW Series: Make sure that the **Scan to** button's LED is off.

CLX-330xFN Series/CLX-330xFW Series: Select  (copy) on the control panel.

- 2 Select  (**Menu**) > **Copy Feature** > **Darkness** on the control panel.

- 3 Select the option you want and press **OK**.

For example, the **Light+5** being the lightest, and the **Dark+5** being the darkest.

- 4 Press  (**Stop/Clear**) to return to ready mode.

Darkness

The **Darkness** menu lets you increase or decrease the difference between the bright and dark areas of an image.

- 1 CLX-330x Series/CLX-330xW Series: Make sure that the **Scan to** button's LED is off.

CLX-330xFN Series/CLX-330xFW Series: Select  (copy) on the control panel.

- 2 Select  (**Menu**) > **Copy Feature** > **Darkness** on the control panel.

- 3 Select the option you want and press **OK**.

- 4 Press  (**Stop/Clear**) to return to ready mode.

Original

The original setting is used to improve the copy quality by selecting the document for the current copy job.

- 1 CLX-330x Series/CLX-330xW Series: Make sure that the **Scan to** button's LED is off.

CLX-330xFN Series/CLX-330xFW Series: Select  (copy) on the control panel.

- 2 Select  (**Menu**) > **Copy Feature** > **Original Type** on the control panel.

- 3 Select the option you want and press **OK**.

- **Text:** Use for originals containing mostly text.
- **Text/Photo:** Use for originals with mixed text and photographs.



If texts in the printout is blurry, select **Text** to get the clear texts.

- **Photo:** Use when the originals are photographs.
- **Magazine:** Use when the originals are magazine.

- 4 Press  (**Stop/Clear**) to return to ready mode.

Basic copying

Reduced or enlarged copy



You can reduce or enlarge the size of a copied image from 25% to 400% from the document feeder or scanner glass.



- This feature may not be available depending on model or optional goods (see "Variety feature" on page 10).
- If the machine set to Eco mode, reduce and enlarge features are not available.



To select from the predefined copy sizes

- 1** CLX-330x Series/CLX-330xW Series: Make sure that the **Scan to** button's LED is off.

CLX-330xFN Series/CLX-330xFW Series: Select  (copy) on the control panel.
- 2** Select  (**Menu**) > **Copy Feature** > **Reduce/Enlarge** on the control panel.
- 3** Select the option you want and press **OK**.
- 4** Press  (**Stop/Clear**) to return to ready mode.

To scale the copy by directly entering the scale rate

- 1** CLX-330x Series/CLX-330xW Series: Make sure that the **Scan to** button's LED is off.

CLX-330xFN Series/CLX-330xFW Series: Select  (copy) on the control panel.
- 2** Select  (**Menu**) > **Copy Feature** > **Reduce/Enlarge** > **Custom** on the control panel.
- 3** Enter the copy size you want using the numeric keypad.
- 4** Press **OK** to save the selection.
- 5** Press  (**Stop/Clear**) to return to ready mode.



When you make a reduced copy, black lines may appear at the bottom of your copy.

ID card copying

Your machine can print 2-sided originals on one sheet.

The machine prints one side of the original on the upper half of the paper and the other side on the lower half without reducing the size of the original. This feature is helpful for copying a small-sized item such as business card.

Basic copying



- The original must be placed on the scanner glass to use this feature.
- If the machine set to Eco mode, this feature is not available.

Depending on the model, the operating procedure may differ.

- 1 Press **ID Copy** on the control panel.
- 2 Place the front side of an original facing down on the scanner glass where arrows indicate as shown. Then, close the scanner lid.

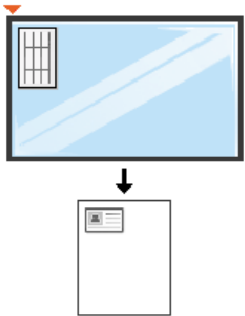

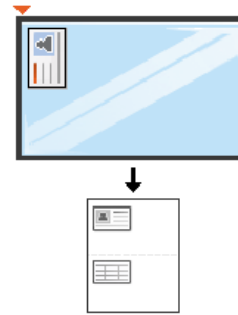

- 3 **Place Front Side and Press [Start]** appears on the display.
- 4 Press  (**Start**).
Your machine begins scanning the front side and shows **Place Back Side and Press [Start]**.

- 5 Turn the original over and place it on the scanner glass where arrows indicate as shown. Then, close the scanner lid.

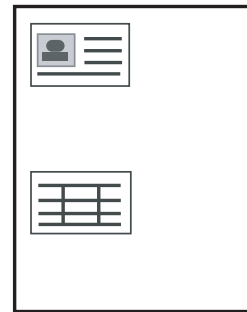

- 6 Press  (**Start**) button.



- If you do not press the  (**Start**) button, only the front side will be copied.
- If the original is larger than the printable area, some portions may not be printed.

Basic scanning



For special scanning features, refer to the Advanced Guide (see "Scan features" on page 231).

Basic Scanning

This is the normal and usual procedure for scanning originals.

This is a basic scanning method for USB-connected machine.



- It may be necessary to press **OK** to navigate to lower-level menus for some models.
- If you want to scan using the network, refer to the Advanced Guide (see "Scanning from network connected machine" on page 232).

1 Place a single document face down on the document glass, or load the documents face up into the document feeder (see "Loading originals" on page 51).

2 CLX-330xFN Series/CLX-330xFW Series: Select  (scan) > **Scan to PC** > **Local PC** on the control panel.

OR

CLX-330x Series/CLX-330xW Series: Press **Scan to** > **Scan to PC** > **Local PC** on the control panel.



If you see **Not Available** message, check the port connection, or select **Enable Scan from Device Panel** in **Samsung Easy Printer Manager** >



Switch to advanced mode > **Scan to PC Settings**.

3 Select the scan destination you want and press **OK**.
Default setting is **My Documents**.



- You can create and save the frequently used settings as a profile list. Also you can add and delete the profile and save each profile to a different path.
- To change the **Samsung Easy Printer Manager** >  Switch to advanced mode > **Scan to PC Settings**.

4 Select the option you want and press **OK**.

5 Scanning begins.



Scanned image is saved in computer's **C:\Users\users name\My Documents**. The saved folder may differ, depending on your operating system or the application you are using.

Basic faxing



- For special faxing features, refer to the Advanced Guide (see "Fax features" on page 240).



- You cannot use this machine as a fax via the internet phone. For more information ask your internet service provider.
- We recommend using traditional analog phone services (PSTN: Public Switched Telephone Network) when connecting telephone lines to use a fax machine. If you use other Internet services (DSL, ISDN, VoIP), you can improve the connection quality by using the Micro-filter. The Micro-filter eliminates unnecessary noise signals and improves connection quality or Internet quality. Since the DSL Micro-filter is not provided with the machine, contact your Internet service provider for use on DSL Micro-filter.

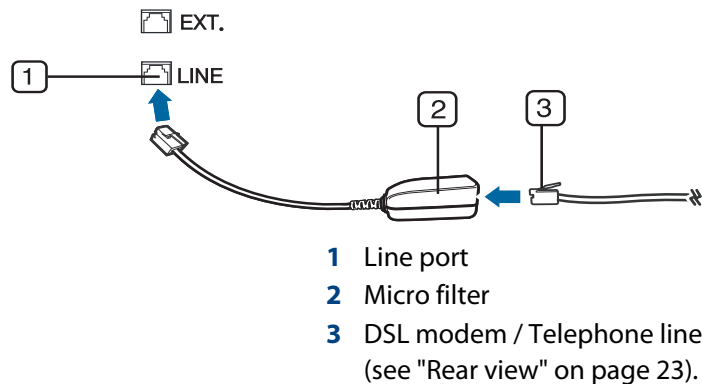

Preparing to fax

Before you send or receive a fax, you need to connect the supplied line cord to your telephone wall jack (see "Rear view" on page 23). Refer to the Quick Installation Guide how to make a connection. The method of making a telephone connection is different from one country to another.

Sending a fax



When you place the originals, you can use either the document feeder or the scanner glass. If the originals are placed on both the document feeder and the scanner glass, the machine will read the originals on the document feeder first, which has higher priority in scanning.

- Place a single document face down on the document glass, or load the documents face up into the document feeder (see "Loading originals" on page 51).
- Select  (fax) on the control panel.
- Adjust the resolution and the darkness to suit your fax needs (see "Adjusting the document settings" on page 68).

Basic faxing

- 4 Enter the destination fax number (see "Keypad letters and numbers" on page 215).
- 5 Press  (**Start**) on the control panel. The machine starts to scan and send the fax to the destinations.





- If you want to send a fax directly from your computer, use Samsung Network PC Fax (see "Sending a fax in the computer" on page 241).
- When you want to cancel a fax job, press  (**Stop/Clear**) before the machine starts transmission.
- If you used the scanner glass, the machine shows the message asking to place another page.

Sending a fax manually

Perform the following to send a fax using  (**On Hook Dial**) on the control panel.



- If your machine is a handset model, you can send a fax using the handset (see "Variety feature" on page 10).

- 1 Place a single document face down on the document glass, or load the documents face up into the document feeder (see "Loading originals" on page 51).
- 2 Select  (fax) on the control panel.
- 3 Adjust the resolution and the darkness to suit your fax needs (see "Adjusting the document settings" on page 68).
- 4 Press  (**On Hook Dial**) on the control panel or lift the handset.
- 5 Enter a fax number using the number keypad on the control panel.
- 6 Press  (**Start**) on the control panel when you hear a high-pitched fax signal from the remote fax machine.



Sending a fax to multiple destinations

You can use the multiple send feature, which allows you to send a fax to multiple locations. Originals are automatically stored in memory and sent to a remote station. After transmission, the originals are automatically erased from memory.



- You cannot send faxes with this feature if you chosen super fine as an option or if the fax is in color.

Basic faxing

- 1 Place a single document face down on the document glass, or load the documents face up into the document feeder (see "Loading originals" on page 51).
- 2 Select  (fax) on the control panel.
- 3 Adjust the resolution and the darkness to suit your fax needs (see "Adjusting the document settings" on page 68).
- 4 Select  (**Menu**) > **Fax Feature** > **Multi Send** on the control panel.
- 5 Enter the number of the first receiving fax machine and press **OK**.
You can press speed dial numbers or select a group dial number using the  (**Address book**) button.
- 6 Enter the second fax number and press **OK**.
The display asks you to enter another fax number to send the document.
- 7 To enter more fax numbers, press **OK** when **Yes** appears and repeat steps 5 and 6.



- You can add up to 10 destinations.
- Once you have entered a group dial number, you cannot enter another group dial number.

- 8 When you have finished entering fax numbers, select **No** at the **Another No.?** prompt and press **OK**.

The machine begins sending the fax to the numbers you entered in the order in which you entered them.

Multi send report is printed after sending faxes.

Receiving a fax

Your machine is preset Fax mode at the factory. When you receive a fax, the machine answers the call on a specified number of rings and automatically receives the fax.

Adjusting the document settings

Before starting a fax, change the following settings according to your original's status to get the best quality.





- It may be necessary to press **OK** to navigate to lower-level menus for some models.

Basic faxing

Resolution

The default document settings produce good results when using typical text-based originals. However, if you send originals that are of poor quality, or contain photographs, you can adjust the resolution to produce a higher quality fax.

- 1 Select  (fax) >  (**Menu**) > **Fax Feature** > **Resolution** on the control panel.
- 2 Select the option you want and press **OK**.
 - **Standard**: Originals with normal sized characters.
 - **Fine**: Originals containing small characters or thin lines or originals printed using a dot-matrix printer.
 - **Super Fine**: Originals containing extremely fine detail. **Super Fine** mode is enabled only if the machine with which you are communicating also supports the Super Fine resolution.



- For memory transmission, **Super Fine** mode is not available. The resolution setting is automatically changed to **Fine**.
- When your machine is set to **Super Fine** resolution and the fax machine with which you are communicating does not support **Super Fine** resolution, the machine transmits using the highest resolution mode supported by the other fax machine.

- **Photo Fax**: Originals containing shades of gray or photographs.



- 3 Press  (**Stop/Clear**) to return to ready mode.

Darkness

You can select the degree of darkness of the original document.



The darkness setting is applied to the current fax job. To change the default setting (see "Fax" on page 199).

- 1 Select  (fax) >  (**Menu**) > **Fax Feature** > **Darkness** on the control panel.
- 2 Select a darkness level you want.
- 3 Press  (**Stop/Clear**) to return to ready mode.

Using USB memory device

This chapter explains how to use a USB memory device with your machine.

About USB memory

USB memory devices are available with a variety of memory capacities to give you more room for storing documents, presentations, downloaded music and videos, high resolution photographs or whatever other files you want to store or move.

You can do the following tasks on your machine by using a USB memory device.

- Scan documents and save them on a USB memory device
- Print data stored on a USB memory device
- Restore backup files to the machine's memory
- Format the USB memory device
- Check the available memory space

Plugging in a USB memory device

Lift the scanner lid slightly and insert your USB memory device into the USB memory port. Close the scanner lid again before using the device.

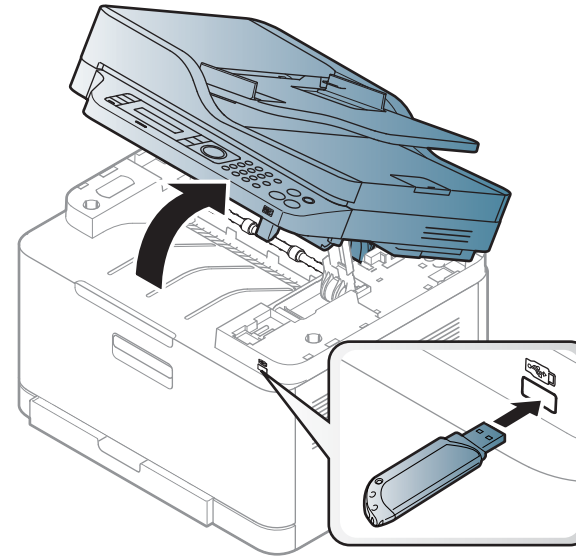

The USB memory port on the front of your machine is designed for USB V1.1 and USB V2.0 memory devices. Your machine supports USB memory devices with FAT16/FAT32 and a sector size of 512 bytes.

Check your USB memory device's file system from your dealer.

Using USB memory device

You must use only an authorized USB memory device with an A plug connector.

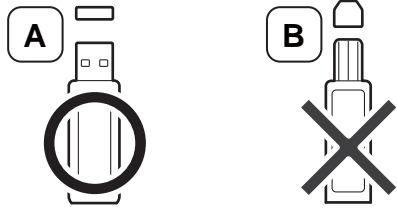

Use only a metal-shielded USB memory device.

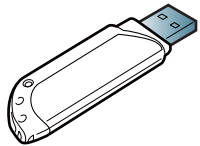

Only use a USB memory device that has obtained compatibility certification; otherwise, the machine might not recognize it.



- Do not remove the USB memory device while the machine is in operation or writing to or reading from USB memory. The machine warranty does not cover damage caused by user's misuse.
- If your USB memory device has certain features such as security settings and password settings, your machine may not automatically detect it. For details about these features, see the user's guide of the USB memory device.

Scanning to a USB memory device



- Accessing menus may differ from model to model (see "Accessing the menu" on page 35)
- It may be necessary to press **OK** to navigate to lower-level menus for some models.

You can scan a document and save the scanned image onto a USB memory device.

Scanning



- 1 Insert a USB memory device into the USB memory port on your machine.
- 2 Place a single document face down on the document glass, or load the documents face up into the document feeder (see "Loading originals" on page 51).
- 3 Select  (scan) > **Scan To USB** > **OK** on the control panel.
The machine begins scanning.

To scan multiple pages, select **Yes** while **Another Page? Yes/No** appears. After scanning is complete, you can remove the USB memory device from the machine.

Using USB memory device

Customizing Scan to USB

You can specify image size, file format, or color mode for each scanning to USB job.

- 1 Select  (scan) >  (**Menu**) > **Scan Feature** > **USB Feature** on the control panel.
- 2 Select the setting option you want appears.
 - **Original Size:** Sets the image size.
 - **Original Type:** Sets the original document's .
 - **Resolution:** Sets the image resolution.
 - **Color Mode:** Sets the color mode. If you select **Mono** in this option, you cannot select JPEG in **File Format**.
 - **File Format:** Sets the file format in which the image is to be saved. If you select **JPEG** in this option, you cannot select **Mono** in **Color Mode**.
 - **Darkness:** Sets the brightness level to scan an original.
- 3 Select the desired status you want and press **OK**.
- 4 Repeat steps 2 and 3 to set other setting options.
- 5 Press  (**Stop/Clear**) to return to ready mode.

You can change the default scan settings. Refer to the Advanced Guide.

Printing from a USB memory device

You can directly print files stored on a USB memory device.

Files supported by Direct Print option.

- **PRN:** Only files created by provided driver with your machine are compatible.



If you print PRN files created from other machine, the printout would be different.

- **TIFF:** TIFF 6.0 Baseline
- **JPEG:** JPEG Baseline
- **PDF:** PDF 1.7 or lower version

To print a document from a USB memory device

- 1 Insert a USB memory device into the USB memory port on your machine, and then press **Direct USB**.
- 2 Select **USB Print**.

Using USB memory device

- 3 Select the folder or file you want and press **OK**.
If you see [+] or [D] in the front of a folder name, there are one or more files or folders in the selected folder.
- 4 Select the number of copies to be printed or enter the number.
- 5 Press **OK**, **Start** or **Print** to start printing the selected file.
After printing the file, the display asks if you want to print another job.
- 6 Press **OK** when **Yes** appears to print another job, and repeat from step 2.
Otherwise, press the left/right arrow to select **No** and press **OK**.
- 7 Press  (**Stop/Clear**) to return to ready mode.

Managing USB memory

You can delete image files stored on a USB memory device one by one or all at once by reformatting the device.



If you see [+] or [D] in the front of a folder name, there are one or more files or folders in the selected folder.



After deleting files or reformatting a USB memory device, files cannot be restored. Therefore, confirm that you no longer need the data before deleting it.

Deleting an image file

- 1 Insert a USB memory device into the USB memory port on your machine, and then press **Direct USB**.
- 2 Select **File Manage** > **Delete** and press **OK**.
- 3 Select the file you want to delete and press **OK**.
- 4 Select **Yes**.
- 5 Press  (**Stop/Clear**) to return to ready mode.

Formatting a USB memory device

- 1 Insert a USB memory device into the USB memory port on your machine, and then press **Direct USB**.
- 2 Select **File Manage** > **Format** and press **OK**.
- 3 Select **Yes**.

Using USB memory device

- 4 Press  (**Stop/Clear**) to return to ready mode.

Viewing the USB memory status

You can check the amount of memory space available for scanning and saving documents.

- 1 Insert a USB memory device into the USB memory port on your machine, and then press **Direct USB**.
- 2 Select **Check Space** .
- 3 The available memory space appears on the display.
- 4 Press  (**Stop/Clear**) to return to ready mode.



3. Maintenance

This chapter provides information about purchasing supplies, accessories and maintenance parts available for your machine.

- **Ordering supplies and accessories** 76
- **Available supplies** 77
- **Available maintenance parts** 78
- **Storing the toner cartridge** 79
- **Redistributing toner** 81
- **Replacing the toner cartridge** 83
- **Replacing the waste toner container** 85
- **Monitoring the supplies life** 89
- **Setting the toner low alert** 90
- **Cleaning the machine** 91
- **Tips for moving & storing your machine** 96

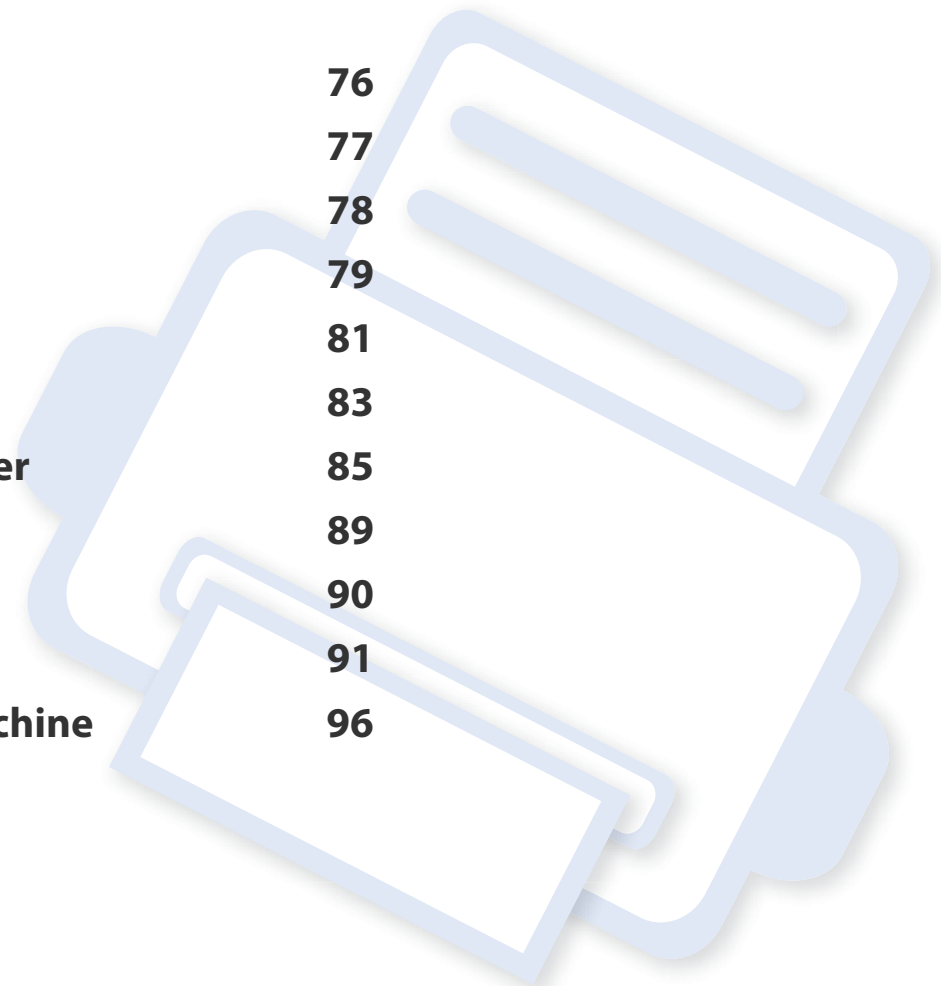

Ordering supplies and accessories



Available accessories may differ from country to country. Contact your sales representatives to obtain the list of available supplies, and maintenance parts.

To order Samsung-authorized supplies, accessories, and maintenance parts, contact your local Samsung dealer or the retailer where you purchased your machine. You can also visit www.samsung.com/supplies, and then select your country/region to obtain the contact information for service.

Available supplies

When supplies reach the end of their life spans, you can order the followings of supplies for your machine:

Type	Average yield ^a	Part name
Toner cartridge	<ul style="list-style-type: none">• Average continuous black cartridge yield: Approx. 1,500 standard pages (Black)• Average continuous color cartridge yield: Approx. 1,000 standard pages (Yellow/Magenta/Cyan)	<ul style="list-style-type: none">• K406 (CLT-K406S): Black• C406 (CLT-C406S): Cyan• M406 (CLT-M406S): Magenta• Y406 (CLT-Y406S): Yellow
Imaging unit	Approx. 16,000 images ^b	CLT-R406
Waste toner container	Approx. 7,000 images ^b	CLT-W406

a. Declared yield value in accordance with ISO/IEC 19798. The number of pages may be affected by operating environment, printing interval, graphics, media type and media size.

b. Image counts based on one color on each page. If you print documents in full color (Cyan, Magenta, Yellow, Black), the life of this item will be reduced by 25%.



Depending on the options, percentage of image area and job mode used, the toner cartridge's lifespan may differ.



When purchasing new toner cartridges or other supplies, these must be purchased in the same country as the machine you are using. Otherwise, new toner cartridges or other supplies will be incompatible with your machine due to different configurations of toner cartridges and other supplies according to the specific country conditions.



Samsung does not recommend using non-genuine Samsung toner cartridge such as refilled or remanufactured toner. Samsung cannot guarantee non-genuine Samsung toner cartridge's quality. Service or repair required as a result of using non-genuine Samsung toner cartridges will not be covered under the machine's warranty.

Available maintenance parts

To purchase maintenance parts, contact the source where you bought the machine. Replacing maintenance parts can be performed only by an authorized service provider, dealer, or the retailer where you bought the machine. The warranty does not cover the replacement of any maintenance parts once it has reached its "Average yield".

Maintenance parts are replaced at specific intervals to avoid print quality and paper feed problems resulting from worn parts, see table below. The purpose of which is to maintain your machine in top working condition. The maintenance parts below should be replaced when the life span of each item has been met.

Parts	Average yield^a
Fuser unit	Approx. 20,000 black pages or 5,000 color pages
Transfer roller	Approx. 20,000 pages
Feed roller	Approx. 20,000 pages
Pickup roller	Approx. 20,000 pages
Intermediate Transfer Belt (ITB)	Approx. 20,000 pages for black and white mode or 5,000 pages for color mode
ADF Feed roller^b	Approx. 20,000 pages
ADF Rubber Pad^b	Approx. 20,000 pages

a. It will be affected by the operating system used, computing performance, application software, connecting method, media type, media size and job complexity.

b. CLX-330xFN Series/ CLX-330xFW Series only

Storing the toner cartridge

Toner cartridges contain components that are sensitive to light, temperature and humidity. Samsung suggests users follow these recommendations to ensure optimal performance, highest quality, and longest life from your new Samsung toner cartridge.

Store this cartridge in the same environment in which the printer will be used. This should be in controlled temperature and humidity conditions. The toner cartridge should remain in its original and unopened package until installation – if original packaging is not available, cover the top opening of the cartridge with paper and store in a dark cabinet.

Opening the cartridge package prior to use dramatically shortens its useful shelf and operating life. Do not store on the floor. If the toner cartridge is removed from the printer, follow the instructions below to store the toner cartridge properly.

- Store the cartridge inside the protective bag from the original package.
- Store lying flat (not standing on end) with the same side facing up as if it were installed in the machine.
- Do not store consumables in any of the following conditions:
 - Temperature greater than 40°C (104°F).
 - Humidity range less than 20% or greater than 80%.
 - An environment with extreme changes in humidity or temperature.
 - Direct sunlight or room light.
 - Dusty places.
 - A car for a long period of time.
 - An environment where corrosive gases are present.

- An environment with salty air.

Handling instructions

- Do not expose the cartridge to unnecessary vibrations or shock.

Toner cartridge usage

Samsung Electronics does not recommend or approve the use of non-Samsung brand toner cartridges in your printer including generic, store brand, refilled, or remanufactured toner cartridges.



Samsung's printer warranty does not cover damage to the machine caused by the use of a refilled, remanufactured, or non-Samsung brand toner cartridges.

Storing the toner cartridge

Estimated cartridge life

Estimated cartridge life (the life of the toner cartridge yield) depends on the amount of toner that print jobs require. The actual print yield may vary depending on the print density of the pages you print on, operating environment, percentage of image area, printing interval, media type and/or media size. For example, if you print a lot of graphics, the consumption of the toner is higher and you may need to change the cartridge more often.

Redistributing toner

When the toner cartridge is near the end of its life:

- White streaks or light printing occurs and/or density variation side to side.
- The **Status** LED blinks red. The toner-related message saying that the toner is low may appear on the display.
- The computers's Samsung Printing Status program window appears on the computer telling you which color cartridge is low on toner (see "Using Samsung Printer Status" on page 265).

If this happens, you can temporarily improve print quality by redistributing the remaining toner in the cartridge. In some cases, white streaks or light printing will still occur even after you have redistributed the toner.



Illustrations on this user's guide may differ from your machine depending on its options or models. Check your machine type (see "Front view" on page 21).



- Do not use sharp objects such as a knife or scissors to open the toner cartridge package. They might scratch the drum of the cartridge.
- If toner gets on your clothing, wipe it off with a dry cloth and wash clothing in cold water. Hot water sets toner into fabric.

- When opening a scan unit, hold the document feeder and scan unit together.
- Printing even after the toner empty status can cause serious damage to your machine.

Redistributing toner

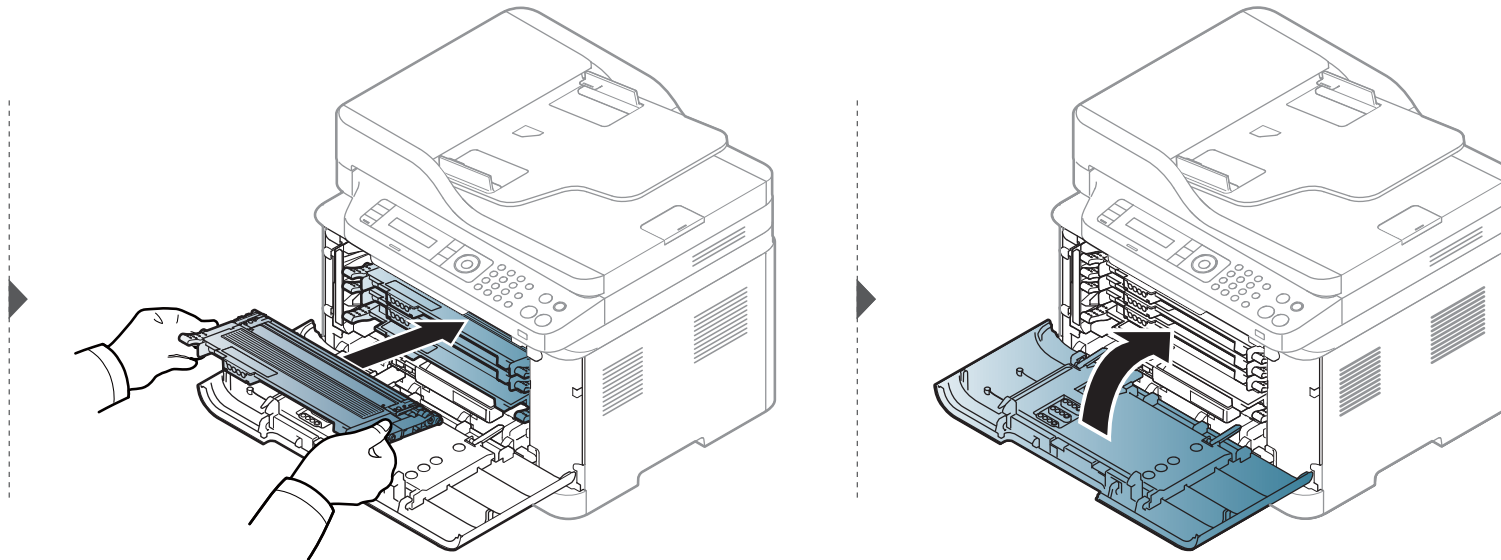
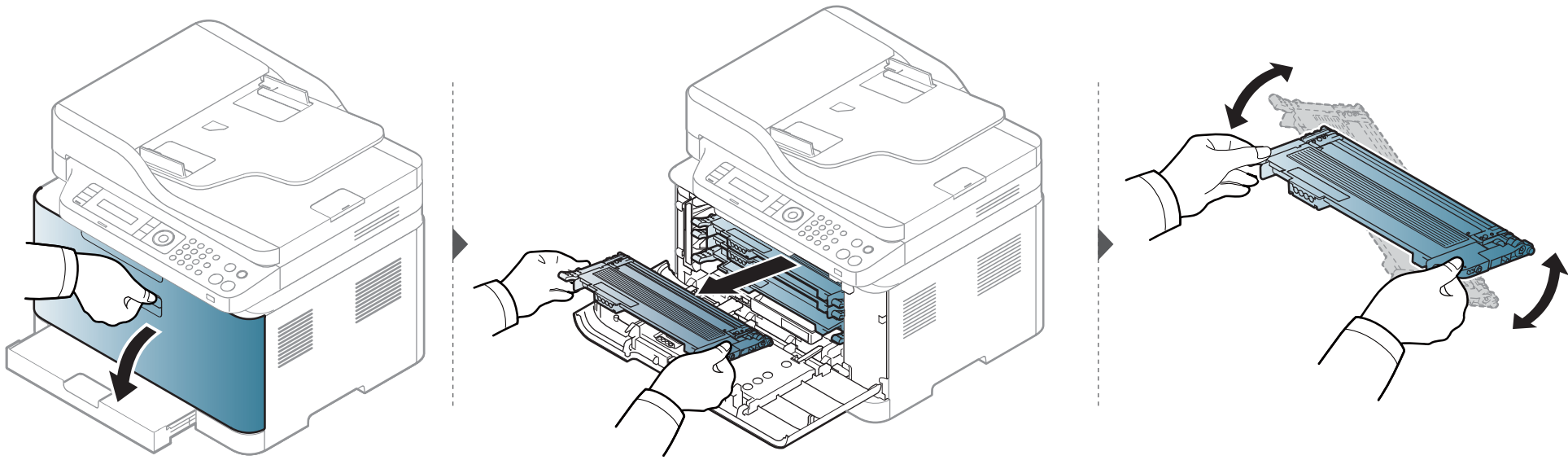

Replacing the toner cartridge



Click this link to open an animation about replacing a toner cartridge.



- Shake the toner cartridge thoroughly, it will increase the initial print quality.
- Illustrations on this user's guide may differ from your machine depending on its options or models. Check your machine type (see "Front view" on page 21).



- Do not use sharp objects such as a knife or scissors to open the toner cartridge package. They might scratch the drum of the cartridge.
- If toner gets on your clothing, wipe it off with a dry cloth and wash clothing in cold water. Hot water sets toner into fabric.
- When opening a scan unit, hold the document feeder and scan unit together.
- Printing even after the toner empty status can cause serious damage to your machine.

When a toner cartridge has reached the end of life, the Printing Status window appears on the computer, indicating the toner cartridge needs to be placed.

Replacing the toner cartridge

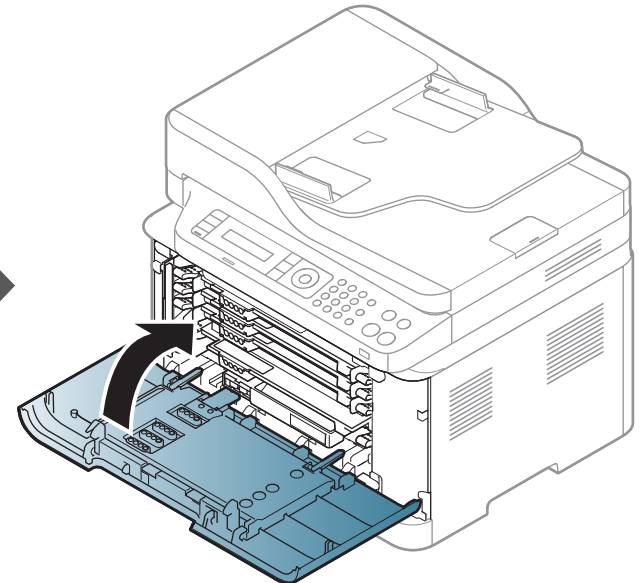
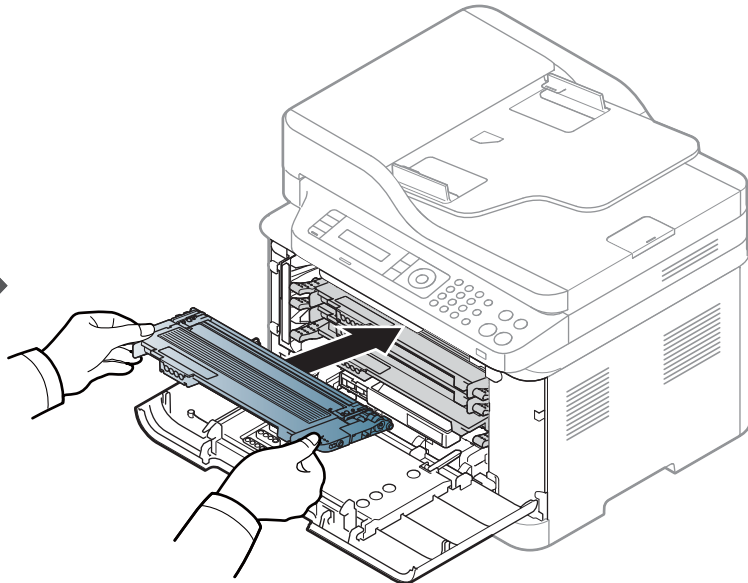
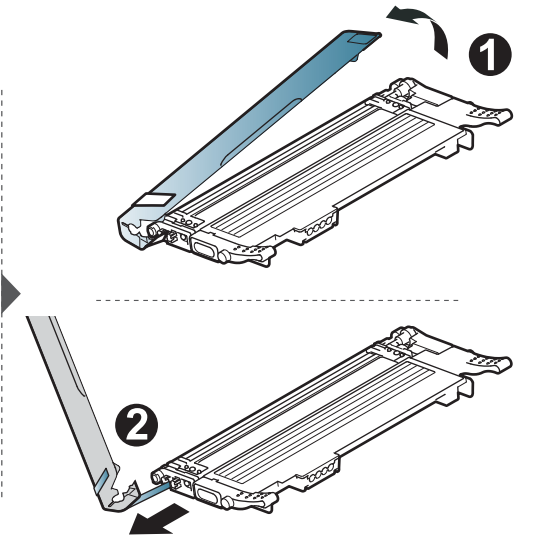
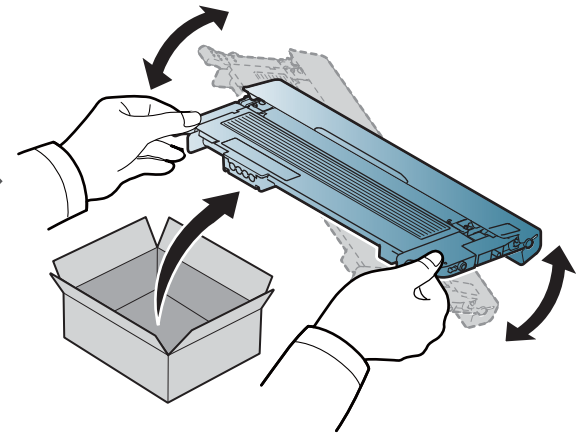
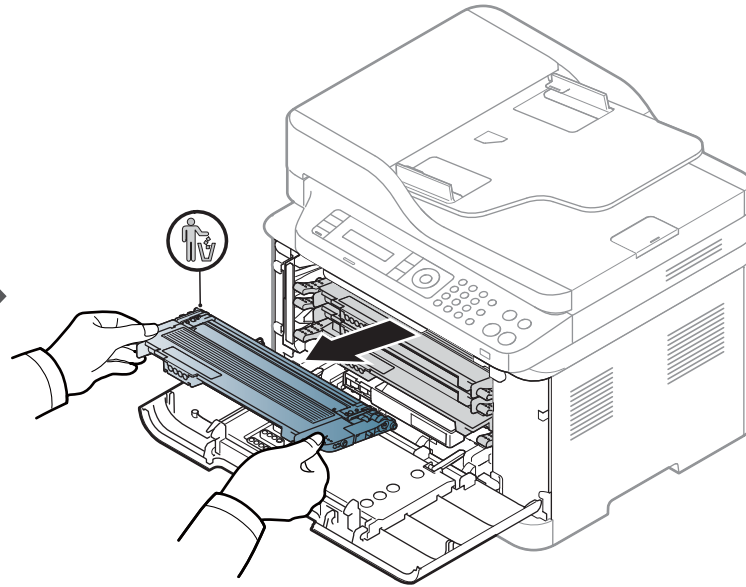
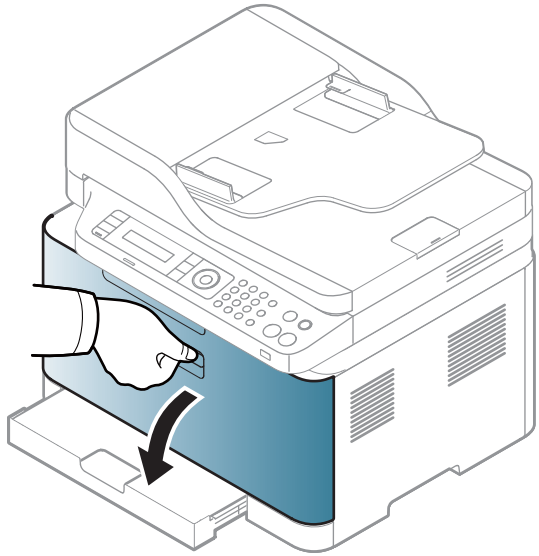

Replacing the waste toner container

When the life span of the waste toner container has expired, waste toner container-related message appears on the screen display of the control panel, indicating the waste toner container needs to be replaced. Check the waste toner container for your machine (see "Available supplies" on page 77). For information about installing the waste toner container, refer to the waste toner container installation guide included on the package.



- Toner particles can be released inside the machine but it does not mean the machine is damaged. Contact a service representative when print quality problems occur.
- When you pull out the waste toner container out of the machine, move the container carefully not to drop it from your hands.
- Make sure that you lay the waste toner container on a flat surface so that the toner does not spill.



Do not tilt or turn over the container.

Replacing the waste toner container

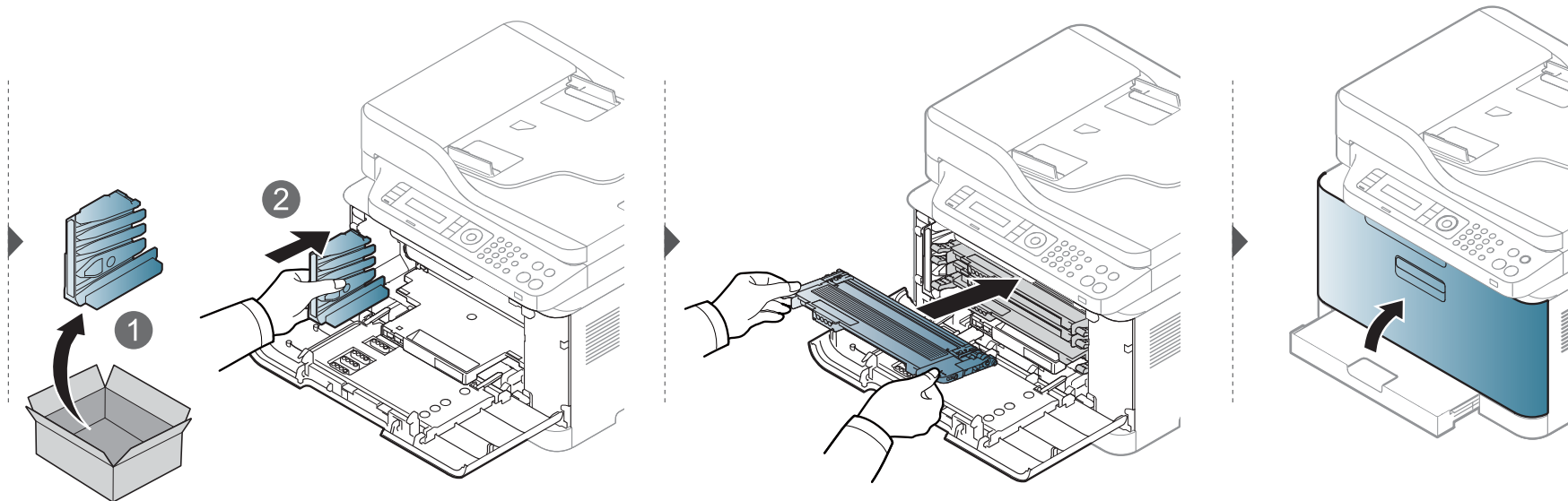
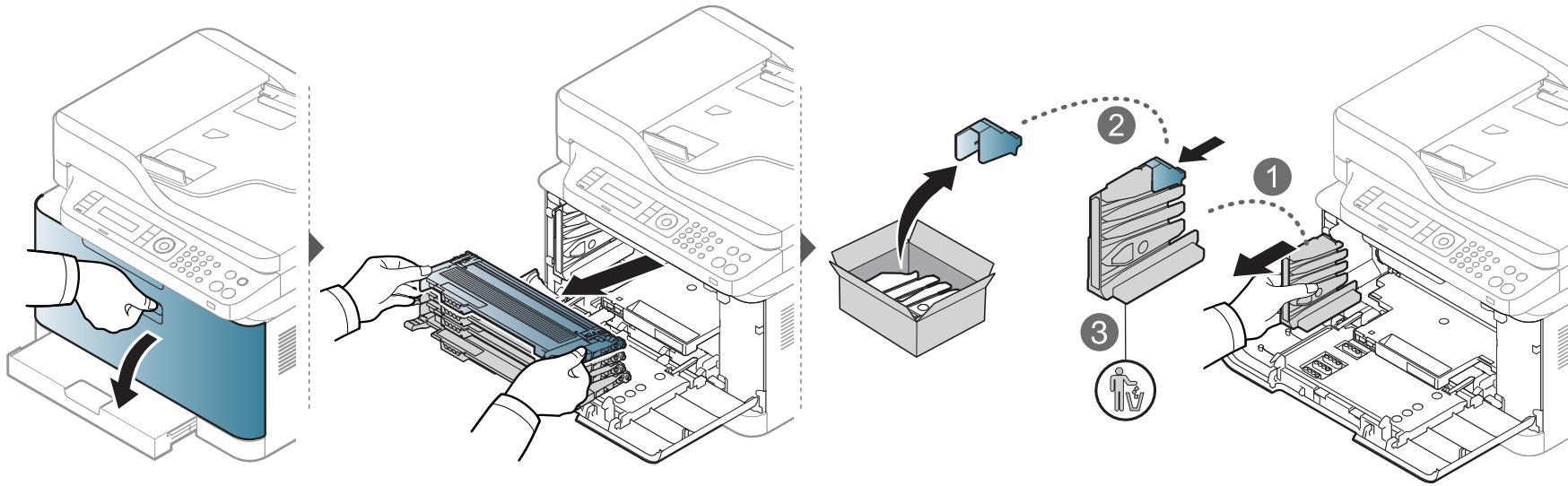

Replacing the imaging unit

When the life span of the imaging unit has expired, the Printing Status window appears on the computer, indicating the imaging unit needs to be placed. Otherwise, your machine stops printing.



- Don't use sharp objects such as a knife or scissors to open the imaging unit package. You could damage the surface of the imaging unit.
- Be careful not to scratch the surface of the imaging unit.
- To prevent damage, do not expose the imaging unit to light for more than a few minutes. Cover it with a piece of paper to protect it if necessary.
- Before closing the front cover, make sure all toner cartridges are installed properly.

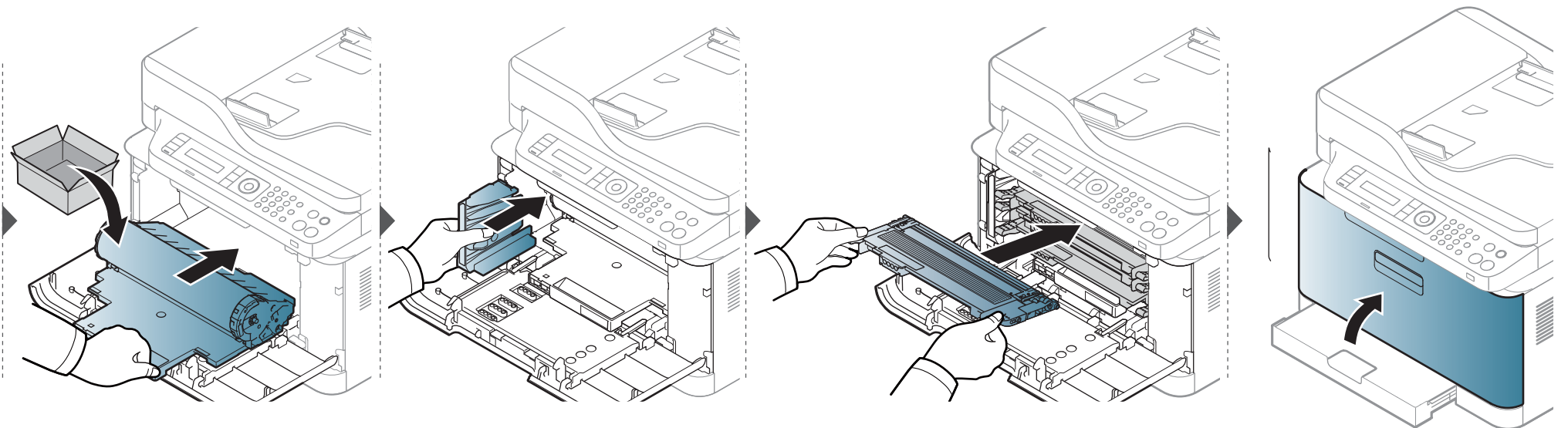
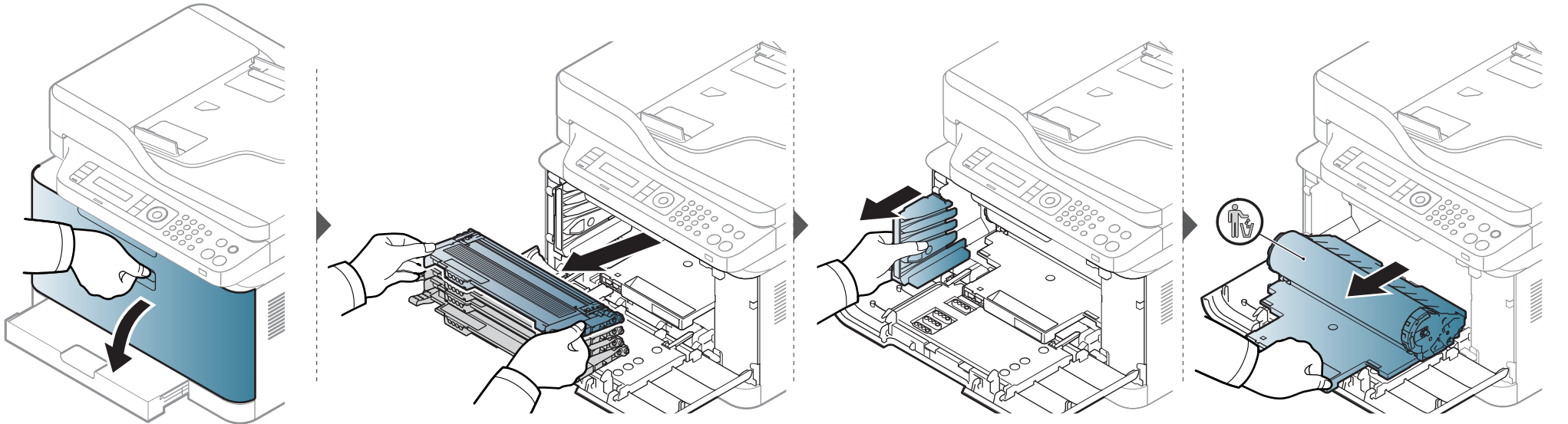

Replacing the imaging unit



Monitoring the supplies life

If you experience frequent paper jams or printing problems, check the number of pages the machine has printed or scanned. Replace the corresponding parts, if necessary.

 It may be necessary to press **OK** to navigate to lower-level menus for some models.

- 1 Select  (**Menu**) > **System Setup** > **Maintenance** > **Supplies Life** on the control panel.
- 2 Select the option you want and press **OK**.
 - **Total:** Displays the total number of pages printed.
 - **ADF Scan:** Displays the number of pages printed by using the document feeder.
 - **Platen Scan:** Displays the number of pages scanned by using scanner glass.
 - **Supplies Info.:** Prints the supply information page.
- 3 Press  (**Stop/Clear**) to return to ready mode.

Setting the toner low alert

If the amount of toner in the cartridge is low, a message or LED informing the user to change the toner cartridge appears. You can set the option for whether or not this message or LED appears.



- You can set the machine's settings by using the **Device Settings** in Samsung Easy Printer Manager program.
 - For Windows and Mac users, you set from **Samsung Easy Printer Manager** >  **(Switch to advanced mode)** > **Device Settings**, see "Device Settings" on page 259.
- It may be necessary to press **OK** to navigate to lower-level menus for some models.

- 1 Select  **(Menu)** > **System Setup** > **Maintenance** > **TonerLow Alert** on the control panel.
- 2 Select the option you want.
- 3 Press **OK** to save the selection.

Cleaning the machine

If printing quality problems occur or if you use your machine in a dusty environment, you need to clean your machine regularly to keep it in the best printing condition and use your machine longer.



- Cleaning the cabinet of the machine with cleaning materials containing large amounts of alcohol, solvents, or other strong substances can discolor or distort the cabinet.
- If your machine or the surrounding area is contaminated with toner, we recommend you use a cloth or tissue dampened with water to clean it. If you use a vacuum cleaner, toner blows in the air and might be harmful to you.

Cleaning the outside

Clean the machine cabinet with a soft, lint-free cloth. Dampen the cloth slightly with water, but be careful not to let any water drip onto or into the machine.

Cleaning the machine

Cleaning the inside

During the printing process, paper, toner, and dust particles can accumulate inside the machine. This buildup can cause print quality problems, such as toner specks or smearing. Cleaning the inside of the machine clears and reduces these problems.



- To prevent damage to the imaging unit, do not expose it to light for more than a few minutes. Cover it with a piece of paper, if necessary.
- Do not touch the green area of the imaging unit. Use the handle on the imaging unit to avoid touching this area.
- Use a dry lint free cloth when cleaning the inside of the machine, be careful not to damage the transfer roller or any other inside parts. Do not use solvents such as benzene or thinner. Printing quality problems can occur and cause damage to the machine.



- Use a dry lint-free cloth to clean the machine.
- Turn the machine off and unplug the power cord. Wait for the machine to cool down. If your machine has a power switch, turn the power switch off before cleaning the machine.
- Illustrations on this user's guide may differ from your machine depending on its options or models. Check your machine type (see "Front view" on page 21).
- When opening a scan unit, hold the document feeder and scan unit together.

Cleaning the machine

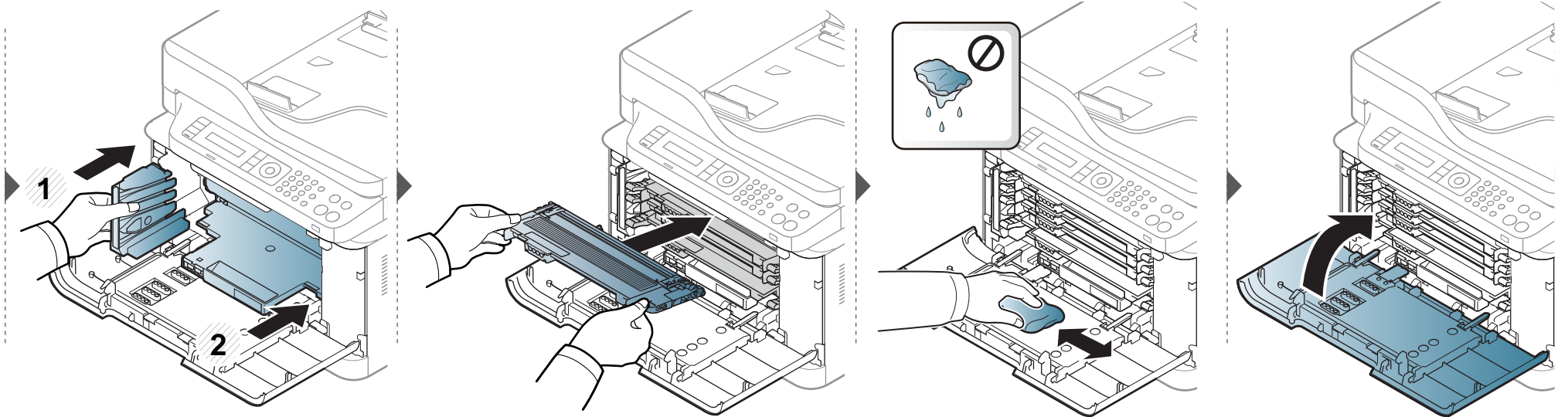
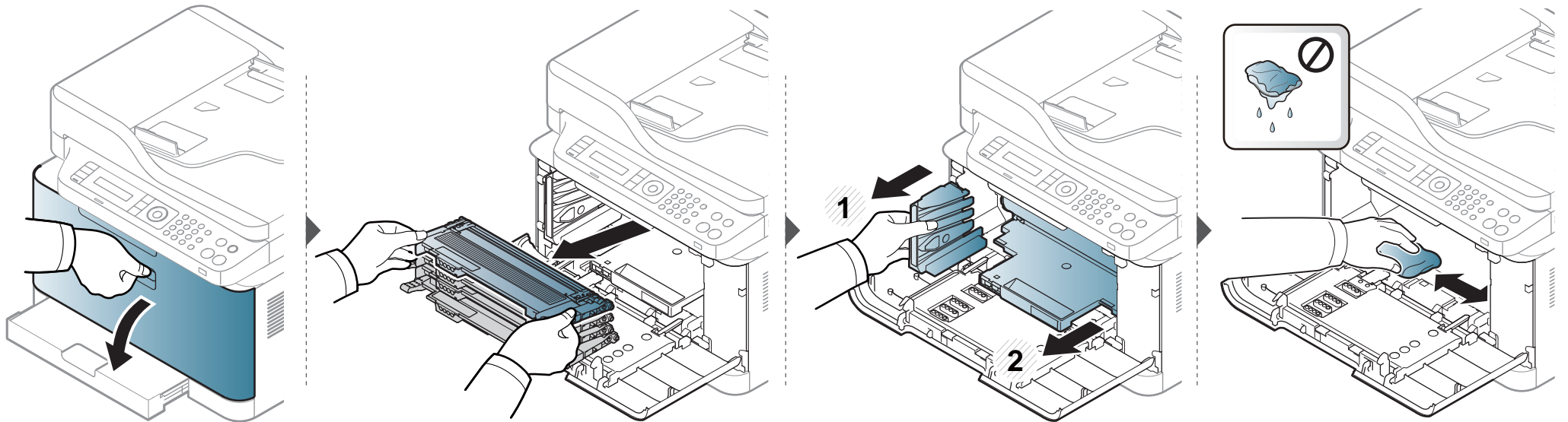

Cleaning the machine

Cleaning the scan unit

Keeping the scan unit clean helps ensure the best possible copies. We suggest that you clean the scan unit at the start of each day and during the day as needed.



- Turn the machine off and unplug the power cord. Wait for the machine to cool down. If your machine has a power switch, turn the power switch off before cleaning the machine.
- Illustrations on this user's guide may differ from your machine depending on its options or models. Check your machine type (see "Front view" on page 21).

- 1 Slightly dampen a soft, lint-free cloth or paper towel with water.
- 2 Lift and open the scanner lid.

Cleaning the machine

- 3** Wipe the surface of the scanner until it is clean and dry.

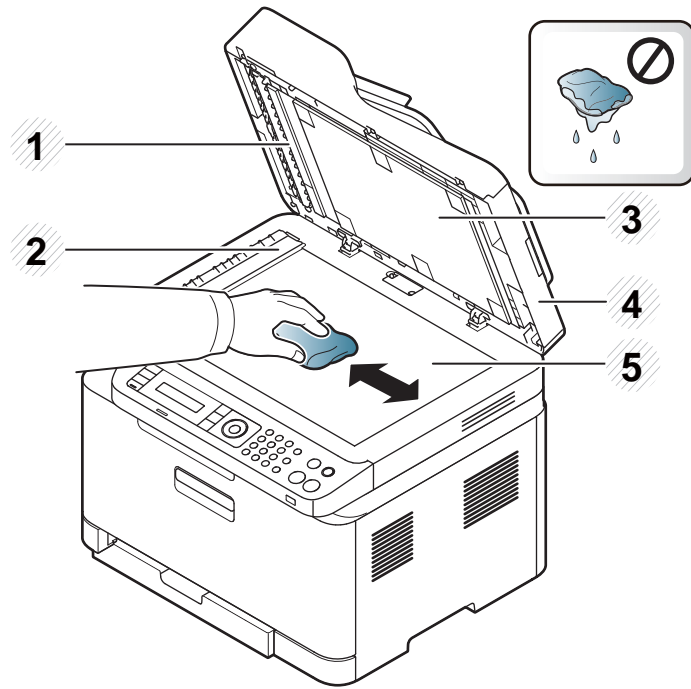

- 1** White bar
- 2** Document feeder glass
- 3** White sheet
- 4** Scanner lid
- 5** Scanner glass

- 4** Close the scanner lid.

Tips for moving & storing your machine

- When moving the machine, do not tilt or turn it upside down. Otherwise, the inside of the machine may be contaminated by toner, which can cause damage to the machine or reduce print quality.
- When moving the machine, make sure at least two people are holding the machine securely.



4. Troubleshooting

This chapter gives helpful information for what to do if you encounter an error.

- **Tips for avoiding paper jams** 98
- **Clearing original document jams** 99
- **Clearing paper jams** 104
- **Understanding the status LED** 110
- **Understanding display messages** 112



This chapter gives helpful information for what to do if you encounter an error. If your machine has a display screen, check the message on the display screen first to solve the error.

If you cannot find a solution to your problem in this chapter, refer to the **Troubleshooting** chapter in the Advanced Guide (see "Troubleshooting" on page 271).

If you cannot find a solution in the User's Guide or the problem persists, call for service.

Tips for avoiding paper jams

By selecting the correct media s, most paper jams can be avoided. To avoid paper jams, refer to the following guidelines:

- Ensure that the adjustable guides are positioned correctly (see "Tray overview" on page 43).
- Do not remove paper from the tray while your machine is printing.
- Flex, fan, and straighten paper before loading.
- Do not use creased, damp, or highly curled paper.
- Do not mix papers in a tray.
- Use only recommended print media (see "Print media specifications" on page 121).

Clearing original document jams

When an original document jams in the document feeder, a warning message appears on the display.

 To avoid tearing the document, remove the jammed document slowly and carefully.

 To prevent document jams, use the scanner glass for thick, thin or mixed paper- originals.

Clearing original document jams

Original paper jam in front of scanner



- Illustrations on this user's guide may differ from your machine depending on its options or models. Check your machine type (see "Front view" on page 21).
- This troubleshooting may not be available depending on model or optional goods (see "Variety feature" on page 10).

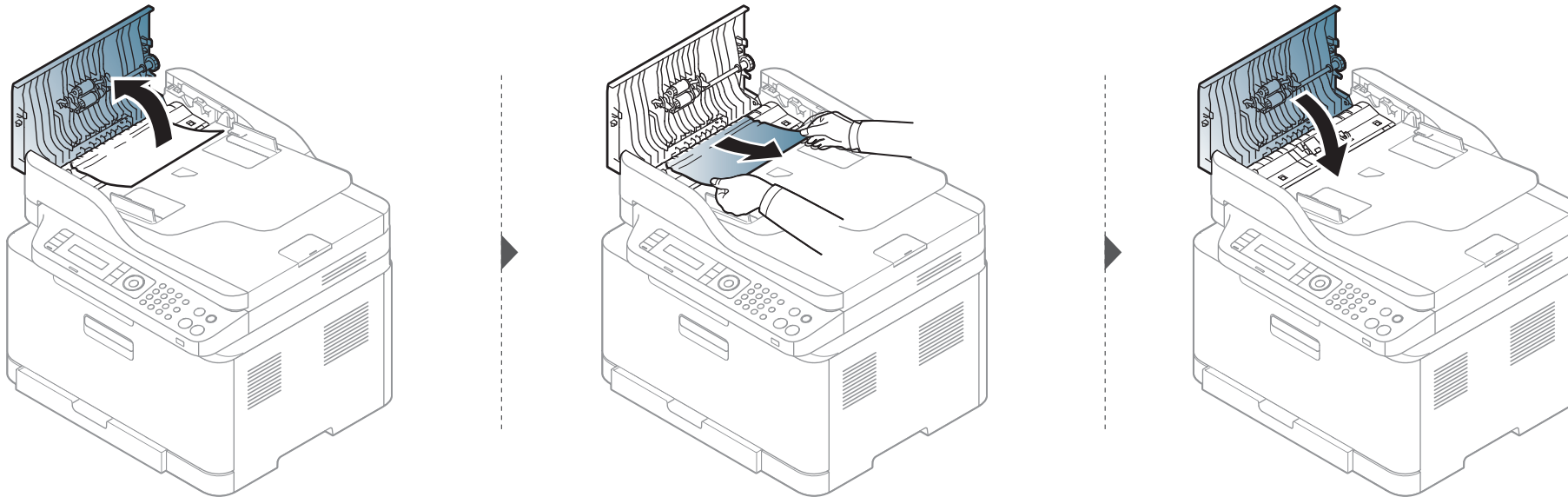

Clearing original document jams

Original paper jam inside of scanner



- Illustrations on this user's guide may differ from your machine depending on its options or models. Check your machine type (see "Front view" on page 21).
- This troubleshooting may not be available depending on model or optional goods (see "Variety feature" on page 10).

Clearing original document jams

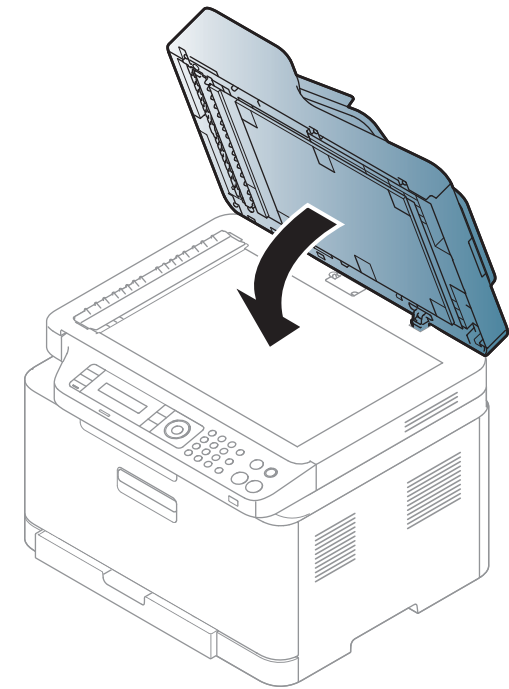
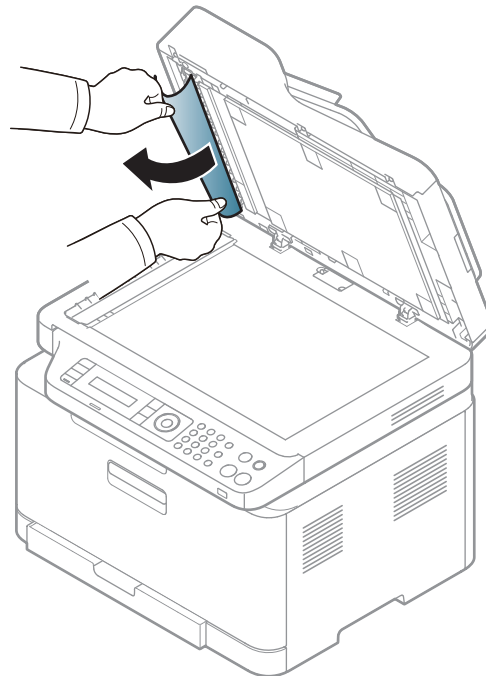
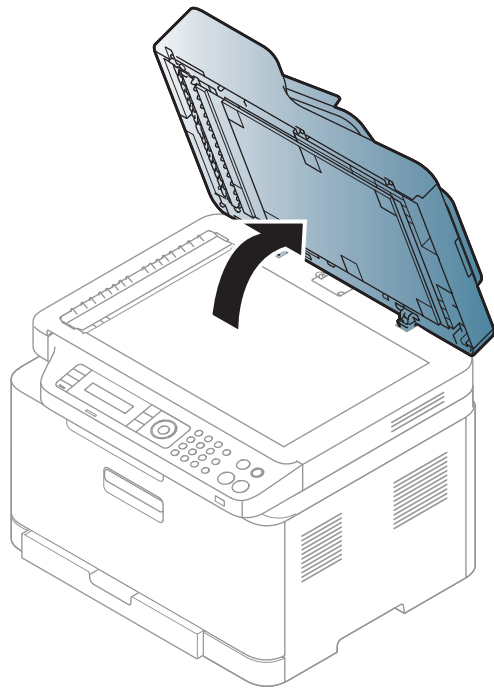
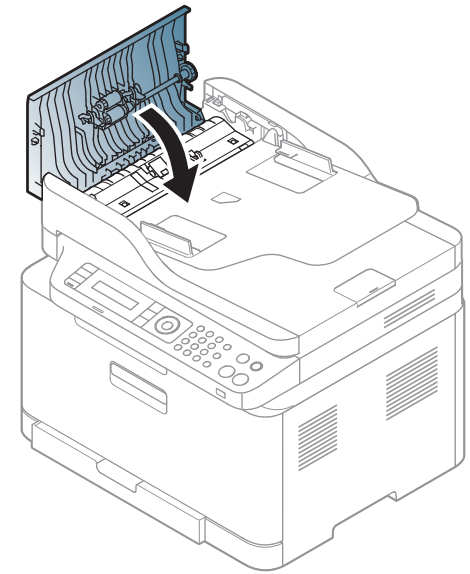
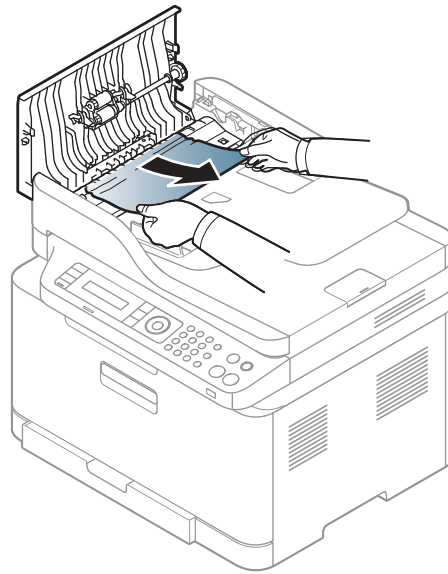
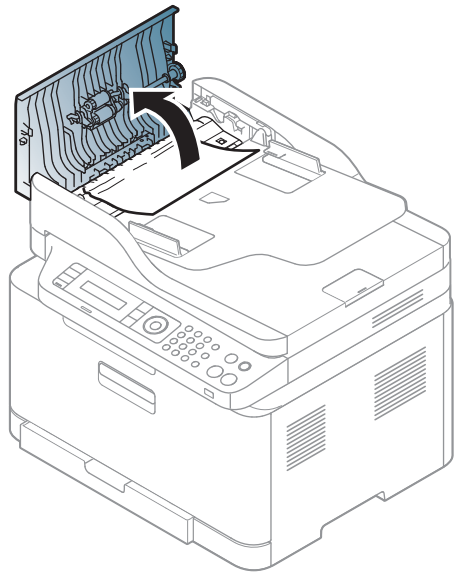

Clearing original document jams

Original paper jam in exit area of scanner



- Illustrations on this user's guide may differ from your machine depending on its options or models. Check your machine type (see "Front view" on page 21).
- This troubleshooting may not be available depending on model or optional goods (see "Front view" on page 21).

- 1 Remove any remaining pages from the document feeder.
- 2 Gently remove the jammed paper from the document feeder.

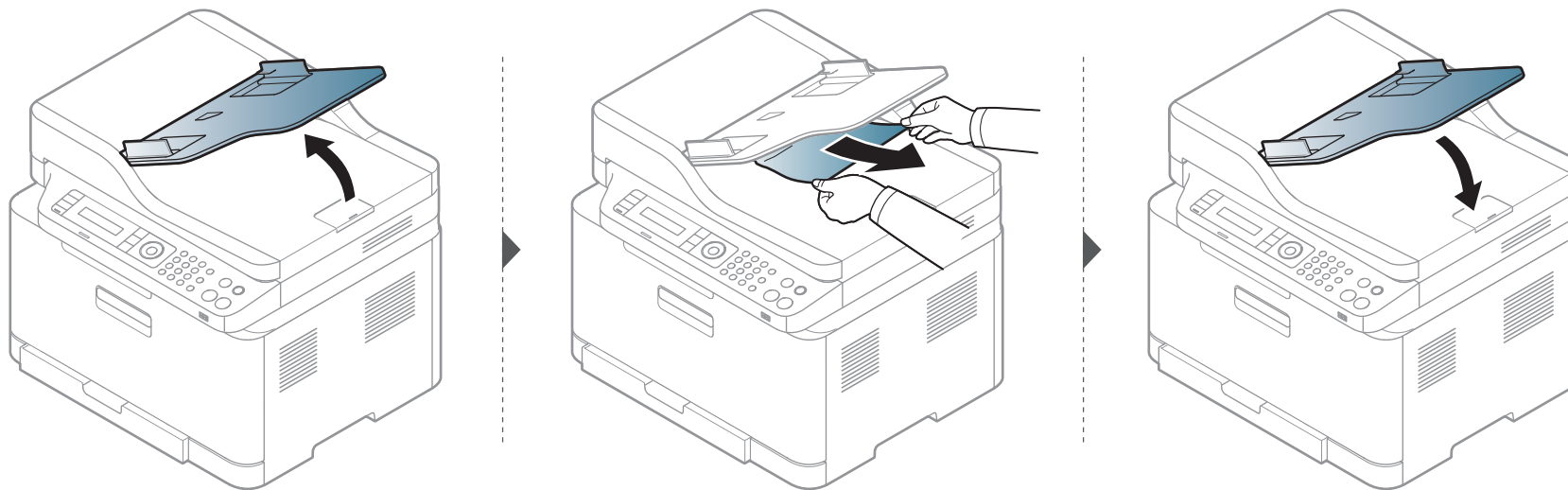

Clearing paper jams



To avoid tearing the paper, pull the jammed paper out slowly and gently.

In tray



Click this link to open an animation about clearing a jam.



Illustrations on this user's guide may differ from your machine depending on its options or models. Check your machine type (see "Front view" on page 21).

Clearing paper jams

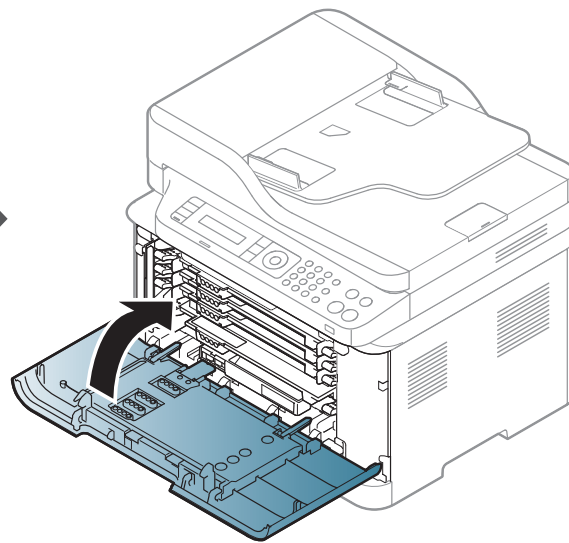
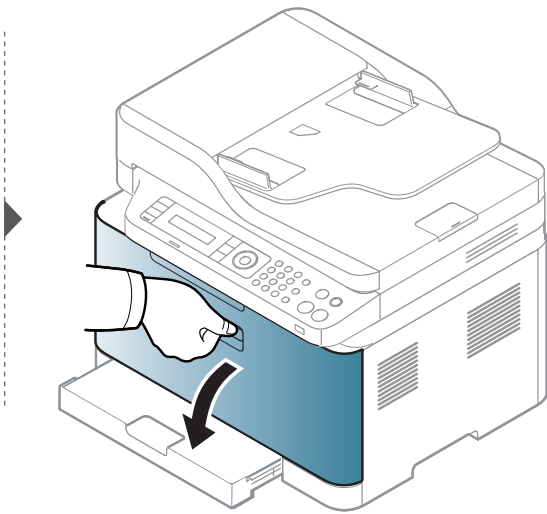
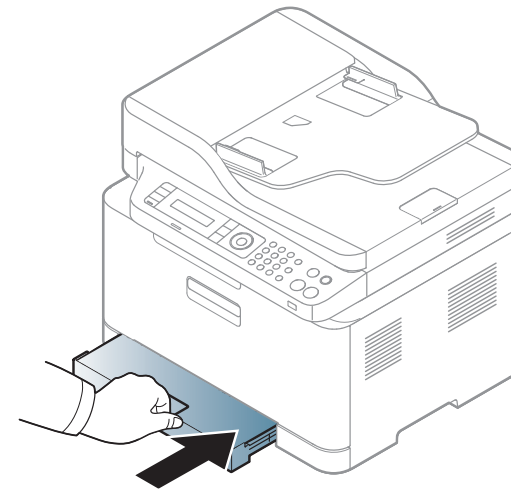
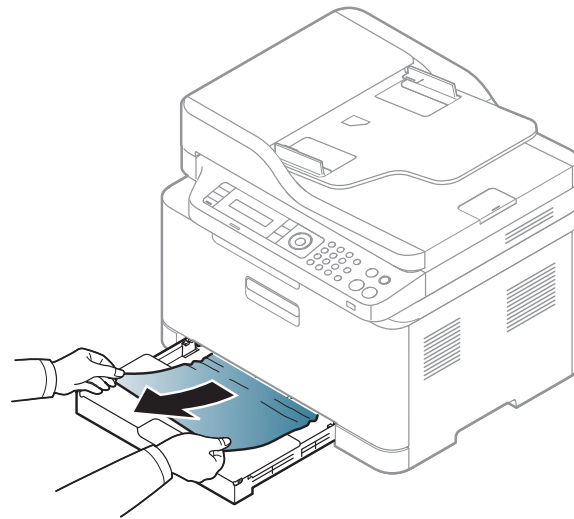
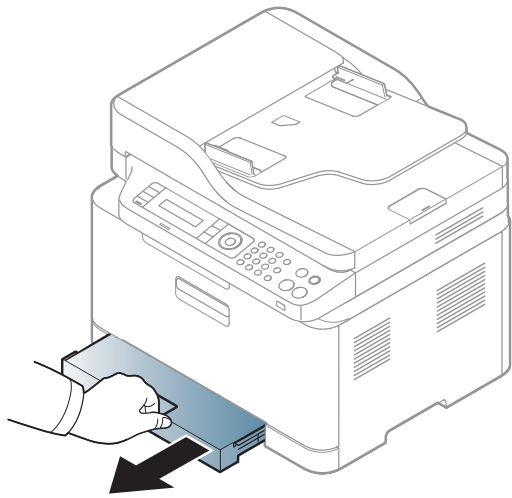

Clearing paper jams

Inside the machine



Click this link to open an animation about clearing a jam.



- The fuser area is hot. Take care when removing paper from the machine.
- Illustrations on this user's guide may differ from your machine depending on its options or models. Check your machine type (see "Front view" on page 21).

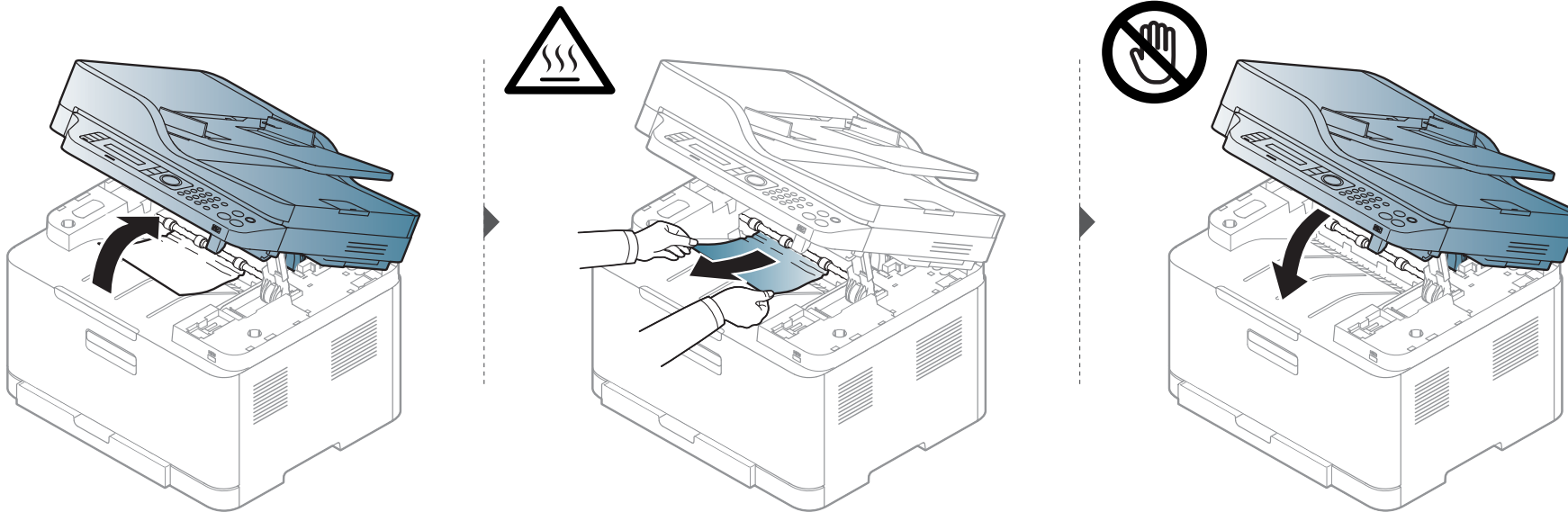

Clearing paper jams

In exit area



Click this link to open an animation about clearing a jam.

Clearing paper jams



- The fuser area is hot. Take care when removing paper from the machine.
- Illustrations on this user's guide may differ from your machine depending on its options or models. Check your machine type (see "Front view" on page 21).

Clearing paper jams

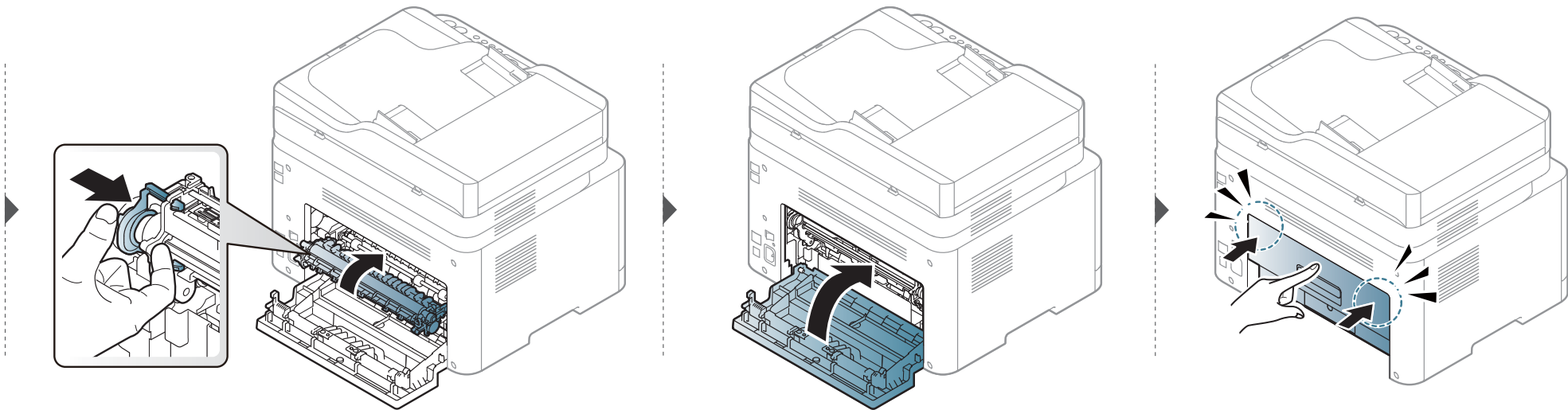
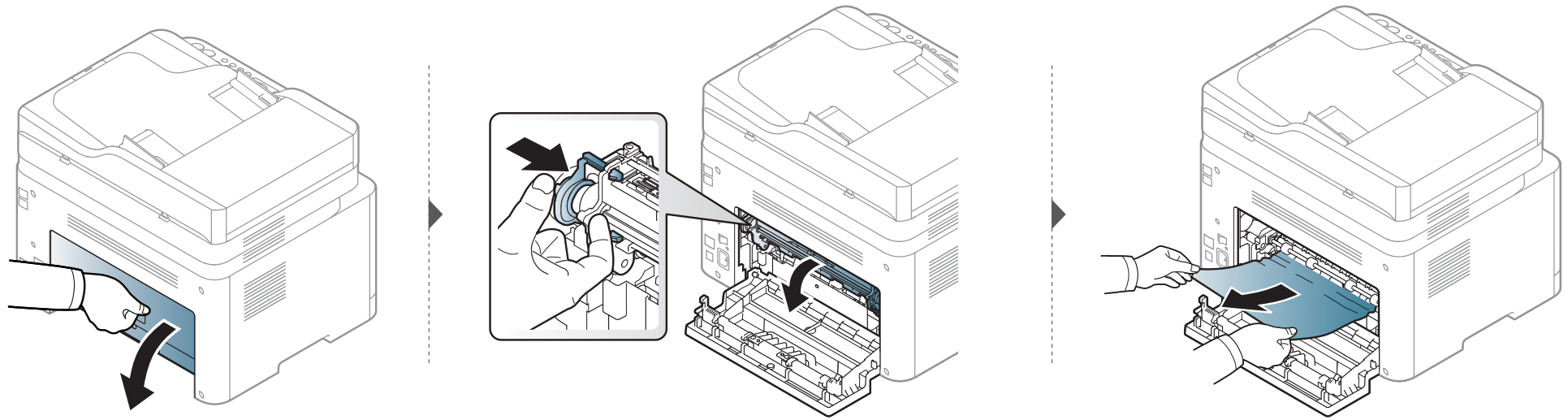

Understanding the status LED

The color of the LED indicates the machine's current status.



- Some LEDs may not be available depending on model or country (see "Control panel overview" on page 24).
- To resolve the error, look at the error message and its instructions from the troubleshooting part (see "Understanding display messages" on page 112).
- You also can resolve the error with the guideline from the computers's Samsung Printing Status window (see "Using Samsung Printer Status" on page 265).
- If the problem persists, call a service representative.

LED	Status	Description	
Status	Off	The machine is off-line.	
	Green	Blinking	When the backlight blinks, the machine is receiving or printing data.
		On	<ul style="list-style-type: none">• The machine is on-line and can be used.
	Red	Blinking	<ul style="list-style-type: none">• A minor error has occurred and the machine is waiting for the error to be cleared. Check the display message. When the problem is cleared, the machine resumes.• Small amount of toner is left in the cartridge. The estimated cartridge life^a of toner is close. Prepare a new cartridge for replacement. You may temporarily increase the printing quality by redistributing the toner (see "Redistributing toner" on page 81).^b
		On	<ul style="list-style-type: none">• A toner cartridge has almost reached its estimated cartridge life^a. It is recommended to replace the toner cartridge (see "Replacing the toner cartridge" on page 83).• The cover is opened. Close the cover.• There is no paper in the tray when receiving or printing data. Load paper in the tray.• The machine has stopped due to a major error. Check the display message (see "Understanding display messages" on page 112).• A paper jam has occurred (see "Clearing paper jams" on page 104).

Understanding the status LED

LED	Status		Description
Wireless ^b	Blue	Blinking	The machine is connecting to a wireless network.
		On	The machine is connected to a wireless network (see "Wireless network setup" on page 164).
		Off	The machine is disconnected from a wireless network.
Power/Wakeup (⏻)	Blue	On	The machine is in power save mode.
		Off	The machine is in ready mode or machine's power is off.
Eco	Green	On	Eco mode is on. The default setting of Eco mode is 2-up and toner save.
		Off	Eco mode is off.
Scan to	Green	On	Eco mode is on. The default setting of Eco mode is 2-up and toner save.
		Off	Eco mode is off.

a. Estimated cartridge life means the expected or estimated toner cartridge life, which indicates the average capacity of print-outs and is designed pursuant to ISO/IEC 19798. The number of pages may be affected by operating environment, percentage of image area, printing interval, graphics, media and media size. Some amount of toner may remain in the cartridge even when red LED is on and the printer stops printing.

b. Some LEDs may not be available depending on model or country (see "Control panel overview" on page 24).

Understanding display messages

Messages appear on the control panel display to indicate the machine's status or errors. Refer to the tables below to understand the messages' and their meaning, and correct the problem, if necessary.



- This function is not supported for the devices which has a control panel display. You can resolve the error with the guideline from the computers's Printing Status window (see "Using Samsung Printer Status" on page 265).
- If a message is not in the table, reboot the power and try the printing job again. If the problem persists, call a service representative.
- When you call for service, provide the service representative with the contents of display message.
- Some messages may not appear on the display depending on the options or models.
- [error number] indicates the error number.
- [tray type] indicates the tray number.
- [media type] indicates the media type.
- [media size] indicates the media size.
- [color] indicates the color of toner.

Paper Jam-related messages

Message	Meaning	Suggested solutions
Document jam. Remove jam	The loaded original document has jammed in the document feeder.	Clear the jam (see "Clearing original document jams" on page 99).
Jam or empty Door open&close	<ul style="list-style-type: none">• Paper has jammed in the paper feed area.• There is no paper in tray.	<ul style="list-style-type: none">• Clear the jam (see "In tray" on page 104).• Load paper in tray (see "Loading paper in the tray" on page 44).
Paper Jam inside machine	Paper has jammed in the inside machine.	Clear the jam (see "Inside the machine" on page 106).
Paper Jam in [tray type]	Paper has jammed in the paper tray.	Clear the jam (see "Clearing paper jams" on page 104).
Paper Jam in exit area	Paper has jammed in the exit area.	Clear the jam (see "In exit area" on page 107).
Paper Empty in [tray type]	There is no paper in tray.	Load paper in tray (see "Loading paper in the tray" on page 44).

Understanding display messages

Toner-related messages

Message	Meaning	Suggested solutions
<ul style="list-style-type: none"> • Install Toner • Install toner cartridge 	A toner cartridge is not installed.	Install a toner cartridge.
<ul style="list-style-type: none"> • Not Compatible [color] toner • Not Compatible toner cartridge 	The toner cartridge is not suitable for your machine.	Install the corresponding toner cartridge with a Samsung-genuine cartridge.
Not original [color] toner	The toner cartridge is not a Samsung-genuine toner cartridge.	Install the corresponding toner cartridge with a Samsung-genuine cartridge.
<ul style="list-style-type: none"> • Prepare toner • Prepare new cartridge 	Small amount of toner is left in the indicated cartridge. The estimated cartridge life of toner is close.	Prepare a new cartridge for a replacement. You may temporarily increase the printing quality by redistributing the toner (see "Redistributing toner" on page 81).

Message	Meaning	Suggested solutions
<ul style="list-style-type: none"> • Replace toner • Replace new cartridge 	The indicated toner cartridge has almost reached its estimated cartridge life. ^a	<ul style="list-style-type: none"> • You can choose Stop or Continue as shown on the control panel. If you select Stop, the printer stops printing and you cannot print any more without changing the cartridge. If you select Continue, the printer keeps printing but the printing quality cannot be guaranteed. Besides, it can cause serious damage to your machine. • Replace the toner cartridge for the best print quality when this message appears. Using a cartridge beyond this stage can result in printing quality issues (see "Replacing the toner cartridge" on page 83).
	The indicated toner cartridge has reached its estimated cartridge life. ^a The machine might stop printing.	Replace the toner cartridge (see "Replacing the toner cartridge" on page 83).

Understanding display messages

- a. Estimated cartridge life means the expected or estimated toner cartridge life, which indicates the average capacity of print-outs and is designed pursuant to ISO/IEC 19752 (see "Available supplies" on page 77). The number of pages may be affected by operating environment, percentage of image area, printing interval, media, percentage of image area, and media size. Some amount of toner may remain in the cartridge even when replace new cartridge appears and the machine stops printing.



Samsung does not recommend using a non-genuine Samsung toner cartridge such as refilled or remanufactured. Samsung cannot guarantee a non-genuine Samsung toner cartridge's quality. Service or repair required as a result of using non-genuine Samsung toner cartridges will not be covered under the machine warranty.

Understanding display messages

Tray-related messages

Message	Meaning	Suggested solutions
Jam or empty Door open&close	<ul style="list-style-type: none"> Paper has jammed in the paper feed area. There is no paper in tray. 	<ul style="list-style-type: none"> Clear the jam (see "In tray" on page 104). Load paper in tray (see "Loading paper in the tray" on page 44).

Network-related messages

Message	Meaning	Suggested solutions
Network Problem: IP Conflict	The network IP address you have set is being used by someone else.	Check the IP address and reset it if necessary (see "Printing a network configuration report" on page 152).
Wireless Network Error	Wireless module is not installed.	Reboot the power and try the printing job again. If the problem persists, please call for service.

Message	Meaning	Suggested solutions
<ul style="list-style-type: none"> BOOTP problem: Auto IP Run DHCP problem: Auto IP Run 	There is a problem with the network.	Change the Auto IP.
<ul style="list-style-type: none"> BOOTP problem: Reconfigure DHCP DHCP problem: Reconfigure DHCP 	The IP address assignment is failed. This happens, when Auto IP for BOOTP/DHCP is set in SyncThru™ Web Service.	Change the IP address assignment method to DHCP/BOOTP or Static. If you do not change this option, the BOOTP/DHCP server continually asks to assign the IP Address.
802.1x Network Error	Fail to authenticate.	Check the network authentication protocol. If the problem persists, contact your network administrator.

Misc. messages

Message	Meaning	Suggested solutions
Adjusting Color Registration	The machine is adjusting the color registration.	Wait a few minutes.

Understanding display messages

Message	Meaning	Suggested solutions
Calibrating image density...	The machine is calibrating the image density.	Wait a few minutes.
Door Open Close it	The cover is not securely latched.	Close the cover until it locks into place.
Scan Unit Open or Exit JAM	The scan unit is not securely latched or paper has jammed in the scanner area.	<ul style="list-style-type: none"> • Clear the jam (see "Clearing original document jams" on page 99). • Close the cover until it locks into place.
Door of scanner is open.	The cover of scanner is not securely latched.	Close the cover until it locks into place.
Error [error number] Install [color] toner	The indicated toner cartridge is installed improperly, or the connector is polluted.	Reinstall the Samsung-genuine toner cartridge two or three times to confirm it is seated properly. Or clean the connector. If the problem persists, contact the service representatives.
Error [error number] Turn off then on	The machine unit cannot be controlled.	Reboot the power and try the printing job again. If the problem persists, please call for service.
Error [error number] Call for service		

Message	Meaning	Suggested solutions
Scanner Locked	The scanner is locked.	Reboot the power. If the problem persists, please call for service.
Install TR. belt unit.	The transfer belt is not installed.	Install a Samsung-genuine transfer belt.
Not compatible transfer belt	The transfer belt of the machine is not for your machine.	Install the a Samsung-genuine part designed for your machine.
Not installed Waste tank	The waste toner container is not installed.	Install a Samsung-genuine waste toner container.
Check Fax Line	The fax line is not properly connected to the LINE port.	Connect the fax line to the LINE port not to the EXT port (see "Rear view" on page 23).
Not proper room temp. Move set	The machine is in a room with improper room temperature.	Move the machine to a room with proper room temperature.
Output bin Full Remove paper	The output tray is full. Or the sensor is not facing down.	Remove papers from the output tray, the machine resumes printing. Or make sure the sensor is facing down. If the problem persists, call for service.

Understanding display messages

Message	Meaning	Suggested solutions
Prepare new Transfer belt	The life of the transfer belt will expired soon.	Replace the transfer belt with a new one. Contact the service representatives.
Replace new Transfer belt	The life of the transfer belt has expired.	Replace the transfer belt with a new one. Contact the service representatives.
Transfer Belt Error	The transfer belt cannot be controlled.	Reboot the power and try the printing job again. If the problem persists, please call for service.
Prepare new Transfer roller	The life of the transfer belt will expired soon.	Replace the transfer belt with a new one. Contact the service representatives.
Replace new Transfer roller	The life of the transfer belt has expired.	Replace the transfer belt with a new one. Contact the service representatives.
Replace Fuser Soon	The life of the fuser unit will be expired soon.	Replace the fuser unit with a new one. Contact the service representatives.
Replace new Fuser unit	The life of the fuser unit will be expired.	

Message	Meaning	Suggested solutions
Replace/Install Waste Toner Tank	The life span of the waste toner container has expired and the printer will stop printing until a new waste toner container is placed into the printer.	Replace a waste toner container with a Samsung-genuine waste toner container.
Prepare new Imaging unit	The life of the imaging unit will be expired soon.	Replace the imaging unit with a new one. Contact the service representatives.
Replace with new imaging unit	The life of the imaging unit will be expired.	
Install imaging unit	The imaging unit is not installed	
Error [error number] Door open/close	The imaging unit is installed improperly, or the cover is not securely latched.	Reinstall the imaging unit to confirm it is seated properly. Close the cover until it locks into place.



5. Appendix

This chapter provides product specifications and information concerning applicable regulations.

- **Specifications** 119
- **Regulatory information** 128
- **Copyright** 141

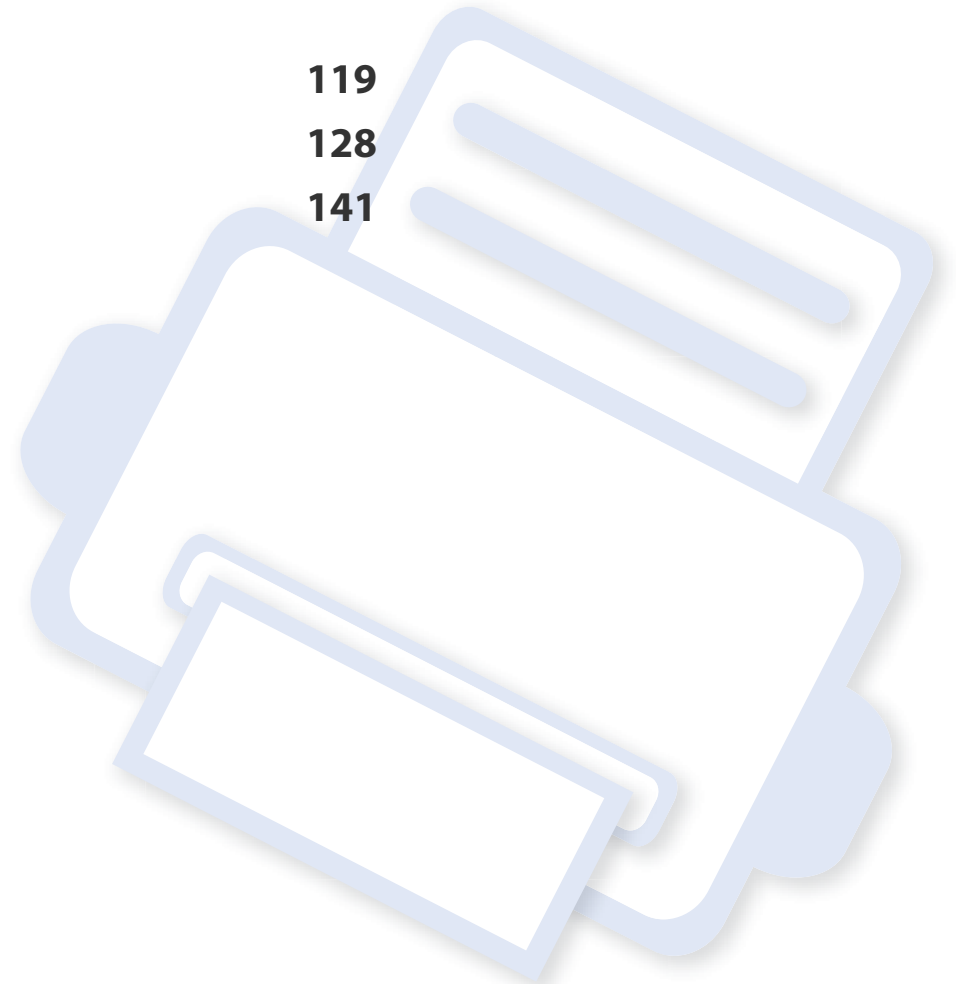

Specifications

General specifications



The specification values listed below are subject to change without notice. See www.samsung.com for possible changes in information.

Items		Description	
Dimension	Width x Length x Height	CLX-330x Series	406 x 362 x 288.6 mm (16 x 14.3 x 11.4 inches)
		CLX-330xW Series	
		CLX-330xFN Series	406 x 362 x 333.5 mm (16 x 14.3 x 13.1 inches)
		CLX-330xFW Series	
Weight	Machine with consumables	CLX-330x Series	12.80 Kg (28.22 lbs)
		CLX-330xW Series	
		CLX-330xFN Series	13.96 Kg (30.78 lbs)
		CLX-330xFW Series	
Noise Level^a	Ready mode	background noise level	
	Print mode	Color printing	Less than 46 dB (A)
		Black and white printing	Less than 48 dB (A)
	Copy mode	Scanner glass	Less than 52 dB (A)
		Document feeder	Less than 53 dB (A)
	Scan mode	Scanner glass	Less than 51 dB (A)
		Document feeder	Less than 51 dB (A)
	Temperature	Operation	10 to 32°C (50 to 89.6°F)
Storage (packed)		0 to 40°C (32 to 104°F)	

Specifications

	Items	Description
Humidity	Operation	20 to 80% RH
	Storage (packed)	10 to 90% RH
Power rating^b	110 volt models	AC 110 - 127 V
	220 volt models	AC 220 - 240 V
Power consumption	Average operating mode	Less than 290 W
	Ready mode	Less than 60 W
	Power save mode^c	<ul style="list-style-type: none"> • CLX-330x Series: Less than 1.2 W • CLX-330xW Series: Less than 1.7 W (Wi-Fi Direct on: Less than 2.3 W) • CLX-330xFN Series: Less than 1.6 W • CLX-330xFW Series: Less than 2.1 W (Wi-Fi Direct on: Less than 2.7 W)
	Power off mode^d	Less than 0.45 W
Wireless^e	Module	SPW-B4319S

a. Sound Pressure Level, ISO 7779. Configuration tested: basic machine installation, A4 paper, simplex printing.

b. See the rating label on the machine for the correct voltage (V), frequency (hertz) and of current (A) for your machine.

c. The power consumption of power save mode may be affected by machine's status, setting conditions, operating environment.

d. Power consumption can be completely avoided only when the power cable is not connected.

e. Wireless models only (see "Features by models" on page 7).

Specifications

Print media specifications

Type	Size	Dimensions	Print media weight/Capacity ^a
			Tray
Plain paper	Letter	216 x 279 mm (8.5 x 11 inches)	60 to 85 g/m ² (16 to 23 lbs bond)
	Legal	216 x 356 mm (8.5 x 14 inches)	• 150 sheets of 75 g/m ² (20 lbs bond)
	US Folio	216 x 330 mm (8.5 x 13 inches)	
	A4	210 x 297 mm (8.27 x 11.69 inches)	
	Oficio	216 x 343 mm (8.5 x 13.5 inches)	
	JIS B5	182 x 257 mm (7.17 x 10.12 inches)	
	ISO B5	176 x 250 mm (6.93 x 9.84 inches)	
	Executive	184 x 267 mm (7.25 x 10.5 inches)	
	A5	148 x 210 mm (5.83 x 8.27 inches)	
	A6	105 x 148 mm (4.13 x 5.83 inches)	
Thick paper	Refer to the Plain paper section	Refer to the Plain paper section	86 to 120 g/m ² (23 to 32 lbs bond) • 5 sheets
Thin paper	Refer to the Plain paper section	Refer to the Plain paper section	60 to 70 g/m ² (16 to 19 lbs bond) • 150 sheets of 60 g/m ² (16 lbs bond)

Specifications

Type	Size	Dimensions	Print media weight/Capacity ^a
			Tray
Cotton	Refer to the Plain paper section	Refer to the Plain paper section	75 to 90 g/m ² (20 to 24 lbs bond) <ul style="list-style-type: none"> • 150 sheets of 75 g/m² (20 lbs bond)
Colored, Pre-printed, Recycled	Refer to the Plain paper section	Refer to the Plain paper section	60 to 85 g/m ² (16 to 24 lbs bond) <ul style="list-style-type: none"> • 150 sheets of 75 g/m² (20 lbs bond)
Labels^b	Letter, Legal, Oficio, US Folio, A4, JIS B5, ISO B5, Executive, A5	Refer to the Plain paper section	120 to 150 g/m ² (32 to 40 lbs bond) <ul style="list-style-type: none"> • 5 sheets
Card stock	Letter, Legal, Oficio, US Folio, A4, JIS B5, ISO B5, Executive, A5, Postcard 4x6	Refer to the Plain paper section	121 to 163 g/m ² (32 to 43 lbs bond) <ul style="list-style-type: none"> • 5 sheets
Bond paper	Refer to the Plain paper section	Refer to the Plain paper section	105 to 120 g/m ² (28 to 32 lbs bond) <ul style="list-style-type: none"> • 10 sheets
Archive	Refer to the Plain paper section	Refer to the Plain paper section	70 to 90 g/m ² (18.6 to 24 lbs bond) <ul style="list-style-type: none"> • 100 sheets
Glossy Photo, Matte Photo	Letter, A4, Postcard 4x6	Refer to the Plain paper section	111 to 220 g/m ² (30 to 58 lbs bond) <ul style="list-style-type: none"> • 1 sheets

Specifications

Type	Size	Dimensions	Print media weight/Capacity ^a
			Tray
Minimum size (custom)		76 x 152 mm (3 x 6 inches)	60 to 120 g/m ² (16 to 32 lbs bond)
Maximum size (custom)		216 x 356 mm (8.5 x 14 inches)	

a. Maximum capacity may differ depending on media weight, thickness, and environmental conditions.

b. The smoothness of the labels used in this machine is 100 to 250 (sheffield). This means the numeric level of smoothness.

 If media weight is over 120 g/m² (32 lbs bond), load a paper into the tray one by one.

System requirements

Microsoft® Windows®

Operating system	Requirement (recommended)		
	CPU	RAM	free HDD space
Windows® XP	Intel® Pentium® III 933 MHz (Pentium IV 1 GHz)	128 MB (256 MB)	1.5 GB
Windows Server® 2003	Intel® Pentium® III 933 MHz (Pentium IV 1 GHz)	128 MB (512 MB)	1.25 GB to 2 GB
Windows Server® 2008	Intel® Pentium® IV 1 GHz (Pentium IV 2 GHz)	512 MB (2 GB)	10 GB

Specifications

Operating system	Requirement (recommended)		
	CPU	RAM	free HDD space
Windows Vista®	Intel® Pentium® IV 3 GHz	512 MB (1 GB)	15 GB
Windows® 7	Intel® Pentium® IV 1 GHz 32-bit or 64-bit processor or higher	1 GB (2 GB)	16 GB
	<ul style="list-style-type: none">• Support for DirectX® 9 graphics with 128 MB memory (to enable the Aero theme).• DVD-R/W Drive		
Windows Server® 2008 R2	Intel® Pentium® IV 1 GHz (x86) or 1.4 GHz (x64) processors (2 GHz or faster)	512 MB (2 GB)	10 GB



- Internet Explorer 6.0 or higher is the minimum requirement for all Windows operating systems.
- Users who have administrator rights can install the software.
- **Windows Terminal Services** is compatible with your machine.

Mac

Operating system	Requirements (Recommended)		
	CPU	RAM	Free HDD space
Mac OS X 10.4	<ul style="list-style-type: none">• Intel® processors• PowerPC G4/G5	<ul style="list-style-type: none">• 128 MB for a powerPC based Mac (512 MB)• 512 MB for an Intel-based Mac (1 GB)	1 GB

Specifications

Operating system	Requirements (Recommended)		
	CPU	RAM	Free HDD space
Mac OS X 10.5	<ul style="list-style-type: none">Intel® processors867 MHz or faster Power PC G4/G5	512 MB (1 GB)	1 GB
Mac OS X 10.6	<ul style="list-style-type: none">Intel® processors	1 GB (2 GB)	1 GB
Mac OS X 10.7 - 10.8	<ul style="list-style-type: none">Intel® processors	2 GB	4 GB

Linux

Items	Requirements
Operating system	Redhat® Enterprise Linux WS 4, 5 (32/64 bit) Fedora 5 ~ 13 (32/64 bit) SuSE Linux 10.1 (32 bit) OpenSuSE® 10.2, 10.3, 11.0, 11.1, 11.2 (32/64 bit) Mandriva 2007, 2008, 2009, 2009.1, 2010 (32/64 bit) Ubuntu 6.06, 6.10, 7.04, 7.10, 8.04, 8.10, 9.04, 9.10, 10.04 (32/64 bit) SuSE Linux Enterprise Desktop 10, 11 (32/64 bit) Debian 4.0, 5.0 (32/64 bit)
CPU	Pentium IV 2.4GHz (Intel Core™2)
RAM	512 MB (1 GB)

Specifications

Items	Requirements
Free HDD space	1 GB (2 GB)

Specifications

Network environment



Network and wireless models only (see "Features by models" on page 7).

You need to set up the network protocols on the machine to use it as your network machine. The following table shows the network environments supported by the machine.

Items	Specifications
Network interface	<ul style="list-style-type: none">• Ethernet 10/100 Base-TX Wired Lan• 802.11b/g/n Wireless LAN
Network operating system	<ul style="list-style-type: none">• Windows® XP, Windows Server® 2003, Windows Vista®, Windows® 7, Windows Server® 2008 R2• Various Linux OS• Mac OS X 10.4 -10.8
Network protocols	<ul style="list-style-type: none">• TCP/IPv4• DHCP, BOOTP• DNS, WINS, Bonjour, SLP, UPnP• Standard TCP/IP Printing (RAW), LPR, IPP, WSD• SNMPv 1/2/3, HTTP• TCP/IPv6 (DHCP, DNS, RAW, LPR, SNMPv 1/2/3, HTTP)
Wireless security	<ul style="list-style-type: none">• Authentication: Open System, Shared Key, WPA Personal, WPA2 Personal (PSK)• Encryption: WEP64, WEP128, TKIP, AES

Regulatory information

This machine is designed for a normal work environment and certified with several regulatory statements.

Laser safety statement

The printer is certified in the U.S. to conform to the requirements of DHHS 21 CFR, chapter 1 Subchapter J for Class I(1) laser products, and elsewhere is certified as a Class I laser product conforming to the requirements of IEC 60825-1 : 2007.

Class I laser products are not considered to be hazardous. The laser system and printer are designed so there is never any human access to laser radiation above a Class I level during normal operation, user maintenance or prescribed service condition.

Warning

Never operate or service the printer with the protective cover removed from laser/scanner assembly. The reflected beam, although invisible, can damage your eyes.

When using this product, these basic safety precautions should always be followed to reduce risk of fire, electric shock, and injury to persons:



CAUTION - CLASS 3B. INVISIBLE LASER RADIATION WHEN OPEN. AVOID EXPOSURE TO THE BEAM.

DANGER - INVISIBLE LASER RADIATION WHEN OPEN. AVOID DIRECT EXPOSURE TO BEAM.

DANGER - KLASSE 3B. UNSICHTBARE LASERSTRAHLUNG, WENN OFFEN. STRAHLENAUSSETZUNG VERMEIDEN.

VORSICHT - UNSICHTBARE LASERSTRAHLUNG KLASSE 3 B, WENN ABDECKUNG GEÖFFNET. NICHT DEM STRAHL AUSSETZEN.

ATTENZIONE - CLASSE 3B. RADIZIONI LASER INVISIBILI CON IL DISPOSITIVO APERTO. EVITARE L'ESPOSIZIONE AL RAGGIO.

PRECAUCIÓN - RADIACIÓN LÁSER INVISIBLE DE CLASE 3B PRESENTE AL ABRIR. EVITE LA EXPOSICIÓN AL HAZ.

PERIGO - CLASSE 3B. RADIAÇÃO LASER INVISÍVEL AO ABRIR. EVITE EXPOSIÇÃO DIRECTA AO FEIXE.

GEVAAR - KLASSE 3B. ONZICHTBARE LASERSTRALING INDIEN GEOPEND. VERMIJD BLOOTSTELLING AAN DE STRAAL.

ADVARSEL - KLASSE 3B. USYNLIG LASERSTRÅLING VED ÅBNING. UNDGÅ UDSÆTTELSE FOR STRÅLING.

ADVARSEL - KLASSE 3B. USYNLIG LASERSTRÅLING NÅR DEKSEL ÅPNES. UNNGÅ EKSPONERING FOR STRÅLEN.

VARNING - KLASSE 3B OSYNLIG LASERSTRÅLNING NÅR DENNA DEL ÅR ÖPPNAD. STRÅLEN ÅR FARLIG.

VAROITUS - LUOKAN 3B NÄKYMÄTTÖMÄLLE LASER-SÄTEILYÄ AVATTUNA. VÄLTÄ ALTISTUMISTA SÄTEELLE.

注意 - CLASS 3B. 严禁打开，以免被不可见激光辐射泄漏灼伤

주의 - 열리면 등급 3B 비가시 레이저 방사선 이 방출됩니다. 광선에 노출을 피하십시오.

Regulatory information

Ozone safety



This product's ozone emission rate is under 0.1 ppm. Because ozone is heavier than air, keep the product in a place with good ventilation.

Mercury Safety



Contains Mercury, Dispose According to Local, State or Federal Laws.(U.S.A. only)

Power saver



This printer contains advanced energy conservation technology that reduces power consumption when it is not in active use.

When the printer does not receive data for an extended period of time, power consumption is automatically lowered.

ENERGY STAR and the ENERGY STAR mark are registered U.S. marks.

For more information on the ENERGY STAR program see <http://www.energystar.gov>

For ENERGY STAR certified models, the ENERGY STAR label will be on your machine. Check if your machine is ENERGY STAR certified.

Recycling



Recycle or dispose of the packaging material for this product in an environmentally responsible manner.

Regulatory information

China only

回收和再循环

为了保护环境，我公司已经为废弃的产品建立了回收和再循环系统。我们会为您无偿提供回收同类废旧产品的服务。当您废弃您正在使用的产品时，请您及时与授权耗材更换中心取得联系，我们会及时为您提供服务。

中国能效标识

型号	能效等级	典型能耗 (kW·h)
CLX-3306	1	1.30
CLX-3306W	1	1.30
CLX-3306FN	1	1.40
CLX-3306FW	1	1.40

依据国家标准 GB 25956-2010



仅适用于海拔2000m以下地区安全使用。

《2000m 以下 海拔地区 安全使用 说明》

“此标识适用于海拔2000m以下地区安全使用”
دېگىز يۈزىدىن 2000 مېتىر تۆۋەن رايونلاردا بىخەتەر ئىشلەتكىلى بولىدۇ

Dan hab yungh youq gij digih haijbaz 2000 m doxroengz haenx ancienz sawjyungh.

Correct disposal of this product (Waste electrical & electronic equipment)

(Applicable in countries with separate collection systems)



This marking on the product, accessories or literature indicates that the product and its electronic accessories (e.g. charger, headset, USB cable) should not be disposed of with other household waste at the end of their working life. To prevent possible harm to the environment or human health from uncontrolled waste disposal, please separate these items from other s of waste and recycle them responsibly to promote the sustainable reuse of material resources.

Household users should contact either the retailer where they purchased this product, or their local government office, for details of where and how they can take these items for environmentally safe recycling.

Business users should contact their supplier and check the terms and conditions of the purchase contract. This product and its electronic accessories should not be mixed with other commercial wastes for disposal.

Regulatory information

(The United States of America only)

Dispose unwanted electronics through an approved recycler. To find the nearest recycling location, go to our website: www.samsung.com/recyclingdirect Or call, (877) 278 - 0799

State of California Proposition 65 Warning (US Only)

The California Safe Drinking Water and Toxic Enforcement Act requires the Governor of California to publish a list of chemicals known to the State of California to cause cancer or reproductive toxicity and requires businesses to warn of potential exposure to such chemicals.

WARNING: This product contains chemicals known to the State of California to cause cancer, birth defects or other reproductive harm.
This appliance can cause low-level exposure to the chemicals, which can be minimized by operating the appliance in a well ventilated area.

Taiwan only

警告

本電池如果更換不正確會有爆炸的危險
請依製造商說明書處理用過之電池

Radio frequency emissions

FCC information to the user

This device complies with Part 15 of the FCC Rules. Operation is subject to the following two conditions:

- This device may not cause harmful interference, and
- This device must accept any interference received, including interference that may cause undesired operation.

This equipment has been tested and found to comply with the limits for a Class B digital device, pursuant to Part 15 of the FCC Rules. These limits are designed to provide reasonable protection against harmful interference in a residential installation. This equipment generates, uses and can radiate radio frequency energy and, if not installed and used in accordance with the instructions, may cause harmful interference to radio communications. However, there is no guarantee that interference will not occur in a particular installation. If this equipment does cause harmful interference to radio or television reception, which can be determined by turning the equipment off and on, the user is encouraged to try to correct the interference by one or more of the following measures:

- Reorient or relocate the receiving antenna.
- Increase the separation between the equipment and receiver.
- Connect the equipment into an outlet on a circuit different from that to which the receiver is connected.

Regulatory information

- Consult the dealer or experienced radio TV technician for help.



Change or modifications not expressly approved by the manufacturer responsible for compliance could void the user's authority to operate the equipment.

Canadian radio interference regulations

This digital apparatus does not exceed the Class B limits for radio noise emissions from digital apparatus as set out in the interference-causing equipment standard entitled "Digital Apparatus", ICES-003 of the Industry and Science Canada.

Cet appareil numérique respecte les limites de bruits radioélectriques applicables aux appareils numériques de Classe B prescrites dans la norme sur le matériel brouilleur: "Appareils Numériques", ICES-003 édictée par l'Industrie et Sciences Canada.

United States of America

Federal Communications Commission (FCC)

Intentional emitter per FCC Part 15

Low power, Radio LAN devices (radio frequency (RF) wireless communication devices), operating in the 2.4 GHz/5 GHz Band, may be present (embedded) in your printer system. This section is only applicable if these devices are present. Refer to the system label to verify the presence of wireless devices.

Wireless devices that may be in your system are only qualified for use in the United States of America if an FCC ID number is on the system label.

The FCC has set a general guideline of 20 cm (8 inches) separation between the device and the body, for use of a wireless device near the body (this does not include extremities). This device should be used more than 20 cm (8 inches) from the body when wireless devices are on. The power output of the wireless device (or devices), which may be embedded in your printer, is well below the RF exposure limits as set by the FCC.

This transmitter must not be collocated or operation in conjunction with any other antenna or transmitter.

Operation of this device is subject to the following two conditions: (1) This device may not cause harmful interference, and (2) this device must accept any interference received, including interference that may cause undesired operation of the device.

Regulatory information



Wireless devices are not user serviceable. Do not modify them in any way. Modification to a wireless device will void the authorization to use it. Contact manufacturer for service.

FCC Statement for Wireless LAN use:



While installing and operating this transmitter and antenna combination the radio frequency exposure limit of 1m W/cm² may be exceeded at distances close to the antenna installed. Therefore, the user must maintain a minimum distance of 20cm from the antenna at all times. This device cannot be colocated with another transmitter and transmitting antenna.

Russia only

AB57



Минсвязи России



Germany only

Das Gerät ist nicht für die Benutzung am Bildschirmarbeitsplatz gemäß Bildschirmarbeitsverordnung vorgesehen.

Regulatory information

Turkey only

- **RoHS**
EEE Yönetmeliğine Uygundur.
This EEE is compliant with RoHS.
- Bu ürünün ortalama yaşam süresi 7 yıl, garanti süresi 2 yıldır.

Thai only

This telecommunication equipment conforms to NTC technical requirement.

Canada only

This product meets the applicable Industry Canada technical specifications. / Le présent matériel est conforme aux spécifications techniques applicables d'Industrie Canada.

The Ringer Equivalence Number (REN) is an indication of the maximum number of devices allowed to be connected to a telephone interface. The termination of an interface may consist of any combination of devices subject only to the requirement that the sum of the RENs of all the devices not exceed five. / L'indice d'équivalence de la sonnerie (IES) sert à indiquer le nombre maximal de terminaux qui peuvent être raccordés à une interface téléphonique. La terminaison d'une interface peut consister en une combinaison quelconque de dispositifs, à la seule condition que la somme d'indices d'équivalence de la sonnerie de tous les dispositifs n'excede pas cinq.

Fax Branding

The Telephone Consumer Protection Act of 1991 makes it unlawful for any person to use a computer or other electronic device to send any message via a telephone facsimile machine unless such message clearly contains in a margin at the top or bottom of each transmitted page or on the first page of the transmission the following information:

- 1 the date and time of transmission
- 2 identification of either business, business entity or individual sending the message; and
- 3 telephone number of either the sending machine, business, business entity or individual.

Regulatory information

The Telephone Company may make changes in its communications facilities, equipment operations or procedures where such action is reasonably required in the operation of its business and is not inconsistent with the rules and regulations in FCC Part 68. If such changes can be reasonably expected to render any customer terminal equipment incompatible with telephone company communications facilities, or require modification or alteration of such terminal equipment, or otherwise materially affect its use or performance, the customer shall be given adequate notice in writing, to allow the customer an opportunity to maintain uninterrupted service

Ringer Equivalence Number

The Ringer Equivalence Number and FCC Registration Number for this machine may be found on the label located on the bottom or rear of the machine. In some instances you may need to provide these numbers to the telephone company.

The Ringer Equivalence Number (REN) is a measure of the electrical load placed on the telephone line, and is useful for determining whether you have “overloaded” the line. Installing several s of equipment on the same telephone line may result in problems making and receiving telephone calls, especially ringing when your line is called. The sum of all Ringer Equivalence Numbers of the equipment on your telephone line should be less than five in order to assure proper service from the telephone company. In some cases, a sum of five may not be usable on your line. If any of your telephone equipment is not operating properly, you should immediately remove it from your telephone line, as it may cause harm to the telephone network.

The equipment complies with Part 68 of the FCC rules and the requirements adopted by the ACTA. On the rear of this equipment is a label that contains, among other information, a product identifier in the format US:AAAEQ##TXXXX. If requested, this number must be provided to the telephone company.



FCC Regulations state that changes or modifications to this equipment not expressly approved by the manufacturer could void the user’s authority to operate this equipment. In the event that terminal equipment causes harm to the telephone network, the telephone company should notify the customer that service may be stopped. However, where prior notice is impractical, the company may temporarily cease service, providing that they:

- a** promptly notify the customer.
- b** give the customer an opportunity to correct the equipment problem.
- c** inform the customer of the right to bring a complaint to the Federal Communication Commission pursuant to procedures set out in FCC Rules and Regulations Subpart E of Part 68.

You should also know that:

- Your machine is not designed to be connected to a digital PBX system.
- If you intend to use a computer modem or fax modem on the same phone line as your machine, you may experience transmission and reception problems with all the equipment. It is recommended that no other equipment, except for a regular telephone, share the line with your machine.

Regulatory information

- If your area experiences a high incidence of lightning or power surges, we recommend that you install surge protectors for both the power and the telephone lines. Surge protectors can be purchased from your dealer or telephone and electronic specialty stores.
- When programming emergency numbers and/or making test calls to emergency numbers, use a non-emergency number to advise the emergency service dispatcher of your intentions. The dispatcher will give you further instructions on how to actually test the emergency number.
- This machine may not be used on coin service or party lines.
- This machine provides magnetic coupling to hearing aids.

You may safely connect this equipment to the telephone network by means of a standard modular jack, USOC RJ-11C.

Replacing the Fitted Plug (for UK Only)

Important

The mains lead for this machine is fitted with a standard (BS 1363) 13 amp plug and has a 13 amp fuse. When you change or examine the fuse, you must re-fit the correct 13 amp fuse. You then need to replace the fuse cover. If you have lost the fuse cover, do not use the plug until you have another fuse cover.

Contact the people from you purchased the machine.

The 13 amp plug is the most widely used in the UK and should be suitable. However, some buildings (mainly old ones) do not have normal 13 amp plug sockets. You need to buy a suitable plug adaptor. Do not remove the moulded plug.



If you cut off the moulded plug, get rid of it straight away.

You cannot rewire the plug and you may receive an electric shock if you plug it into a socket.

Important warning:



You must earth this machine.

The wires in the mains lead have the following color code:

- **Green and Yellow:** Earth
- **Blue:** Neutral
- **Brown:** Live

If the wires in the mains lead do not match the colors marked in your plug, do the following:

You must connect the green and yellow wire to the pin marked by the letter “E” or by the safety ‘Earth symbol’ or colored green and yellow or green.

You must connect the blue wire to the pin which is marked with the letter “N” or colored black.

Regulatory information

You must connect the brown wire to the pin which is marked with the letter “L” or colored red.

You must have a 13 amp fuse in the plug, adaptor, or at the distribution board.

Declaration of conformity (European countries)

Approvals and Certifications

Hereby, Samsung Electronics, declares that this [CLX-330x Series] is in compliance with the essential requirements and other relevant provisions of Low Voltage Directive (2006/95/EC), EMC Directive (2004/108/EC).

 Hereby, Samsung Electronics, declares that this [CLX-330xFN Series/CLX-330xW Series/CLX-330xFW Series] is in compliance with the essential requirements and other relevant provisions of R&TTE Directive 1999/5/EC.

The declaration of conformity may be consulted at www.samsung.com, go to Support > Download center and enter your printer (MFP) name to browse the EuDoC.

January 1, 1995: Council Directive 2006/95/EC Approximation of the laws of the member states related to low voltage equipment.

January 1, 1996: Council Directive 2004/108/EC, approximation of the laws of the Member States related to electromagnetic compatibility.

March 9, 1999: Council Directive 1999/5/EC on radio equipment and telecommunications terminal equipment and the mutual recognition of their conformity. A full declaration, defining the relevant Directives and referenced standards can be obtained from your Samsung Electronics Co., Ltd. representative.

EC Certification

Certification to 1999/5/EC Radio Equipment & Telecommunications Terminal Equipment Directive (FAX)

This Samsung product has been self-certified by Samsung for pan-European single terminal connection to the analogue public switched telephone network (PSTN) in accordance with Directive 1999/5/EC. The product has been designed to work with the national PSTNs and compatible PBXs of the European countries:

In the event of problems, you should contact the Euro QA Lab of Samsung Electronics Co., Ltd. in the first instance.

The product has been tested against TBR21. To assist in the use and application of terminal equipment which complies with this standard, the European Telecommunication Standards Institute (ETSI) has issued an advisory document (EG 201 121) which contains notes and additional requirements to ensure network compatibility of TBR21 terminals. The product has been designed against, and is fully compliant with, all of the relevant advisory notes contained in this document.

Regulatory information

European radio approval information (for products fitted with EU-approved radio devices)

Low power, Radio LAN type devices (radio frequency (RF) wireless communication devices), operating in the 2.4 GHz/5 GHz band, may be present (embedded) in your printer system which is intended for home or office use. This section is only applicable if these devices are present. Refer to the system label to verify the presence of wireless devices.



Wireless devices that may be in your system are only qualified for use in the European Union or associated areas if a CE mark with a Notified Body Registration Number and the Alert Symbol is on the system label.

The power output of the wireless device or devices that may be embedded in your printer is well below the RF exposure limits as set by the European Commission through the R&TTE directive.

European states qualified under wireless approvals:

EU countries

European states with restrictions on use:

EU

In France, this equipment may only be used indoors.

EEA/EFTA countries

No limitations at this time

Israel only

מס' אישור אלחוטי של משרד התקשורת הוא 51-29003
אסור להחליף את האנטנה המקורית של המכשיר,
ולא לעשות בו כל שינוי טכני אחר.

Regulatory compliance statements

Wireless guidance

Low power, Radio LAN devices (radio frequency (RF) wireless communication devices), operating in the 2.4 GHz/5 GHz Band, may be present (embedded) in your printer system. The following section is a general overview of considerations while operating a wireless device.

Additional limitations, cautions, and concerns for specific countries are listed in the specific country sections (or country group sections). The wireless devices in your system are only qualified for use in the countries identified by the Radio Approval Marks on the system rating label. If the country you will be using the wireless device in, is not listed, contact your local Radio Approval agency for requirements. Wireless devices are closely regulated and use may not be allowed.

Regulatory information

The power output of the wireless device or devices that may be embedded in your printer is well below the RF exposure limits as known at this time. Because the wireless devices (which may be embedded into your printer) emit less energy than is allowed in radio frequency safety standards and recommendations, manufacturer believes these devices are safe for use. Regardless of the power levels, care should be taken to minimize human contact during normal operation.

As a general guideline, a separation of 20 cm (8 inches) between the wireless device and the body, for use of a wireless device near the body (this does not include extremities) is typical. This device should be used more than 20 cm (8 inches) from the body when wireless devices are on and transmitting.

This transmitter must not be collocated or operation in conjunction with any other antenna or transmitter.

Some circumstances require restrictions on wireless devices. Examples of common restrictions are listed below:



Radio frequency wireless communication can interfere with equipment on commercial aircraft. Current aviation regulations require wireless devices to be turned off while traveling in an airplane. IEEE 802.11 (also known as wireless Ethernet) and Bluetooth communication devices are examples of devices that provide wireless communication.



In environments where the risk of interference to other devices or services is harmful or perceived as harmful, the option to use a wireless device may be restricted or eliminated. Airports, Hospitals, and Oxygen or flammable gas laden atmospheres are limited examples where use of wireless devices may be restricted or eliminated. When in environments where you are uncertain of the sanction to use wireless devices, ask the applicable authority for authorization prior to use or turning on the wireless device.



Every country has different restrictions on the use of wireless devices. Since your system is equipped with a wireless device, when traveling between countries with your system, check with the local Radio Approval authorities prior to any move or trip for any restrictions on the use of a wireless device in the destination country.



If your system came equipped with an internal embedded wireless device, do not operate the wireless device unless all covers and shields are in place and the system is fully assembled.



Wireless devices are not user serviceable. Do not modify them in any way. Modification to a wireless device will void the authorization to use it. Contact manufacturer for service.



Only use drivers approved for the country in which the device will be used. See the manufacturer System Restoration Kit, or contact manufacturer Technical Support for additional information.

Regulatory information

China only

产品中有害有毒物质或元素的名称及含量

部件名称	有害有毒物质或元素					
	铅 (Pb)	汞 (Hg)	镉 (Cd)	六价铬 (Cr ⁶⁺)	多溴联苯 (PBB)	多溴联苯醚 (PBDE)
塑料	○	○	○	○	○	○
金属 (机箱)	X	○	○	○	○	○
印刷电路部件 (PCA)	X	○	○	○	○	○
电缆 / 连接器	X	○	○	○	○	○
电源设备	X	○	○	○	○	○
电源线	X	○	○	○	○	○
机械部件	X	○	○	○	○	○
卡盒部件	X	○	○	○	○	○
定影部件	X	○	○	○	○	○
扫描仪部件 - CCD (如果有)	X	X	○	○	○	○
扫描仪部件 - 其它 (如果有)	X	○	○	○	○	○
印刷电路板部件 (PBA)	X	○	○	○	○	○
墨粉	○	○	○	○	○	○
滚筒	○	○	○	○	○	○

○：表示该有害有毒物质在该部件所有均质材料中的含量均在 SJ/T 11363-2006 标准规定的限量要求以下。

X：表示该有害有毒物质至少在该部件的某一均质材料中的含量超出 SJ/T 11363-2006 标准规定的限量要求。

以上表为目前本产品含有有害有毒物质的信息。本信息由本公司的配套厂家提供，经本公司审核后而做成，本产品的部分部件含有有害有毒物质，这些部件是在现有科学技术水平下暂时无可替代物质，但三星电子将会一直为满足 SJ/T 11363-2006 标准而做不懈的努力。

Copyright

© 2012 Samsung Electronics Co., Ltd. All rights reserved.

This user's guide is provided for information purposes only. All information included herein is subject to change without notice.

Samsung Electronics is not responsible for any direct or indirect damages, arising from or related to use of this user's guide.

- Samsung and the Samsung logo are trademarks of Samsung Electronics Co., Ltd.
- Microsoft, Windows, Windows Vista, Windows 7, and Windows Server 2008 R2 are either registered trademarks or trademarks of Microsoft Corporation.
- Microsoft, Internet Explorer, Excel, Word, PowerPoint, and Outlook are either registered trademarks or trademarks of Microsoft Corporation in the United States and other countries.
- Google, Picasa, Google Docs, Android and Gmail are either registered trademarks or trademarks of Google Inc.
- Google Cloud Print is a trademark of Google Inc.
- iPad, iPhone, iPod touch, Mac and Mac OS are trademarks of Apple Inc., registered in the U.S and other countries.
- AirPrint and the AirPrint logo are trademarks of Apple Inc.
- All other brand or product names are trademarks of their respective companies or organizations.

Refer to the '**LICENSE.txt**' file in the provided CD-ROM for the open source license information.

REV. 1.03

User's Guide

CLX-330x/330xW Series
CLX-330xFN/330xFW Series

ADVANCED

This guide provides information about installation, advanced configuration, operation and troubleshooting on various OS environments.

Some features may not be available depending on models or countries.

BASIC

This guide provides information concerning installation, basic operation and troubleshooting on windows.



1. Software Installation

Installation for Mac	146
Reinstallation for Mac	147
Installation for Linux	148
Reinstallation for Linux	149



2. Using a Network-Connected

Useful network programs	151
Wired network setup	152
Installing driver over the network	155
IPv6 configuration	161
Wireless network setup	164
Samsung MobilePrint	187
AirPrint	188
Google Cloud Print	190



3. Useful Setting Menus

Before you begin reading a chapter	194
---	-----

Print	195
Copy	196
Fax	199
Scan	203
System setup	205
Network setup	211



4. Special Features

Altitude adjustment	214
Entering various characters	215
Setting up the fax address book	216
Printing features	219
Scan features	231
Fax features	240



5. Useful Management Tools

Easy Capture Manager	250
Samsung Easy Color Manager	251
Samsung AnyWeb Print	252
Easy Eco Driver	253
Using SyncThru™ Web Service	254

Using Samsung Easy Printer Manager	257
Using Samsung Easy Document Creator	260
Using Samsung Printer Status	265
Using the Linux Unified Driver Configurator	267



6. Troubleshooting

Paper feeding problems	272
Power and cable connecting problems	273
Printing problems	274
Printing quality problems	278
Copying problems	286
Scanning problems	287
Faxing problems	288
Operating system problems	290



1. Software Installation

This chapter provides instructions for installing essential and helpful software for use in an environment where the machine is connected via a cable. A locally connected machine is a machine directly attached to your computer using the cable. If your machine is attached to a network, skip the following steps below and go on to installing a network connected machine's driver (see "Installing driver over the network" on page 155).

- **Installation for Mac** **146**
- **Reinstallation for Mac** **147**
- **Installation for Linux** **148**
- **Reinstallation for Linux** **149**



- If you are a Windows OS user, refer to the Basic Guide for installing the machine's driver (see "Installing the driver locally" on page 31).
- Only use a USB cable no longer than 3 meter (118 inches).

Installation for Mac

- 1 Make sure that the machine is connected to your computer and powered on.
- 2 Insert the supplied software CD into your CD-ROM drive.
- 3 Double-click the CD-ROM icon that appears on your Mac desktop.
- 4 Double-click the **MAC_Installer** folder > **Installer OS X** icon.
- 5 Click **Continue**.
- 6 Read the license agreement and click **Continue**.
- 7 Click **Agree** to agree to the license agreement.
- 8 When the message that warns that all applications will close on your computer appears, click **Continue**.
- 9 Click **Continue** on the **User Options Pane**.
- 10 Click **Install**. All components necessary for machine operations will be installed.
If you click **Customize**, you can choose individual components to install.
- 11 Enter the password and click **OK**.
- 12 Installing software requires you to restart your computer. Click **Continue Installation**.
- 13 After the installation is finished, click **Quit** or **Restart**.
- 14 Open the **Applications** folder > **Utilities** > **Print Setup Utility**.
 - For Mac OS X 10.5 -10.8, open the **Applications** folder > **System Preferences** and click **Print & Fax**.
- 15 Click **Add** on the **Printer List**.
 - For Mac OS X 10.5 -10.8, click the "+" folder icon; a display window will pop up.
- 16 Click **Default Browser** and find the USB connection.
 - For Mac OS X 10.5-10.8, click **Default** and find the USB connection.
- 17 For Mac OS X 10.4, if Auto Select does not work properly, select **Samsung** in **Print Using** and your machine name in **Model**.
 - For Mac OS X 10.5-10.8, if Auto Select does not work properly, select **Select a driver to use...** and your machine name in **Print Using**.Your machine appears on the **Printer List**, and is set as the default machine.
- 18 Click **Add**.



To install the fax driver:

- a Open the **Applications** folder > **Samsung** > **Fax Queue Creator**.
- b Your machine appears on the **Printer List**
- c Select machine to use and click **Create** button

Reinstallation for Mac

If the printer driver does not work properly, uninstall the driver and reinstall it.

- 1 Make sure that the machine is connected to your computer and powered on.
- 2 Insert the supplied software CD into your CD-ROM drive.
- 3 Double-click the CD-ROM icon that appears on your Mac desktop.
- 4 Double-click the **MAC_Installer** folder > **Uninstaller OS X** icon.
- 5 Enter the password and click **OK**.
- 6 When the uninstall is done, click **OK**.



If a machine has already been added, delete it from the **Print Setup Utility** or **Print & Fax**.

Installation for Linux

You need to download Linux software packages from the Samsung website to install the printer software (<http://www.samsung.com> > find your product > Support or Downloads).

The installation program added the Unified Driver Configurator desktop icon and the Unified Driver group to the system menu for your convenience. If you have any difficulties, consult the on-screen help that is available through your system menu or from the driver package Windows applications, such as **Unified Driver Configurator** or **Image Manager**.

Installing the Unified Linux Driver

- 1 Make sure that the machine is connected to your computer and powered on.
- 2 When the **Administrator Login** window appears, type "root" in the **Login** field and enter the system password.



You must log in as a super user (root) to install the machine software. If you are not a super user, ask your system administrator.

- 3 From the Samsung website, download the Unified Linux Driver package to your computer.
- 4 Right-click the **Unified Linux Driver** package and extract the package.
- 5 Double click **cdroot** > **autorun**.
- 6 When the welcome screen appears, click **Next**.
- 7 When the installation is complete, click **Finish**.

Reinstallation for Linux

If the printer driver does not work properly, uninstall the driver and reinstall it.

- 1 Make sure that the machine is connected to your computer and powered on.
- 2 When the **Administrator Login** window appears, type "root" in the **Login** field and enter the system password.
You must log in as a super user (root) to uninstall the printer driver. If you are not a super user, ask your system administrator.
- 3 Open the Terminal program. When the Terminal screen appears, type in the following.

```
[root@localhost root]#cd /opt/Samsung/mfp/uninstall/  
[root@localhost uninstall]#./uninstall.sh
```
- 4 Click **Next**.
- 5 Click **Finish**.



2. Using a Network-Connected Machine

This chapter gives you step-by-step instructions for setting up a network connected machine and software.

- **Useful network programs** 151
- **Wired network setup** 152
- **Installing driver over the network** 155
- **IPv6 configuration** 161
- **Wireless network setup** 164
- **Samsung MobilePrint** 187
- **AirPrint** 188
- **Google Cloud Print** 190



Supported optional devices and features may differ according to your model (see "Features by models" on page 7).

Useful network programs

There are several programs available to setup the network settings easily in a network environment. For the network administrator especially, managing several machines on the network is possible.



- Before using the programs below, set the IP address first.
- Some features and optional goods may not be available depending on model or country (see "Features by models" on page 7).

SyncThru™ Web Service

The web server embedded on your network machine allows you to do the following tasks (see "Using SyncThru™ Web Service" on page 254).

- Check the supplies information and status.
- Customize machine settings.
- Set the email notification option. When you set this option, the machine status (toner cartridge shortage or machine error) will be sent to a certain person's email automatically.
- Configure the network parameters necessary for the machine to connect to various network environments.

SyncThru™ Web Admin Service

Web-based machine management solution for network administrators. SyncThru™ Web Admin Service provides you with an efficient way of managing network devices and lets you remotely monitor and troubleshoot network machines from any site with corporate internet access.

- Download this program from <http://solution.samsungprinter.com>.

SetIP wired network setup

This utility program allows you to select a network interface and manually configure the IP addresses for use with the TCP/IP protocol.

- See "IPv4 configuration using SetIP (Windows)" on page 152.
- See "IPv4 configuration using SetIP (Mac)" on page 153.
- See "IPv4 configuration using SetIP (Linux)" on page 154.



- The machine that does not support the network port, it will not be able to use this feature (see "Rear view" on page 23).
- TCP/IPv6 is not supported by this program.

Wired network setup

Printing a network configuration report

You can print **Network Configuration Report** from the machine's control panel that will show the current machine's network settings. This will help you to set up a network.

Press the  (**Menu**) button on the control panel and select **Network > Network Conf. (Network Configuration)**.

Using this **Network Configuration Report**, you can find your machine's MAC address and IP address.

For example:

- MAC Address: 00:15:99:41:A2:78
- IP Address: 169.254.192.192

Setting IP address



- The machine that does not support the network interface, it will not be able to use this feature (see "Rear view" on page 23).
- TCP/IPv6 is not supported by this program.

First, you have to set up an IP address for network printing and managements. In most cases a new IP address will be automatically assigned by a DHCP (Dynamic Host Configuration Protocol) server located on the network.

IPv4 configuration using SetIP (Windows)

Before using the SetIP program, disable the computer firewall from **Control Panel > Security Center > Windows Firewall**.

- 1 Install this program from the supplied CD-ROM by double-click **Application > SetIP > Setup.exe**.
- 2 Follow the instructions in the installation window.
- 3 Connect your machine to the network with a network cable.
- 4 Turn on the machine.
- 5 From the Windows **Start** menu, select **All Programs > Samsung Printers > SetIP > SetIP**.
- 6 Click the  icon (third from left) in the SetIP window to open the TCP/IP configuration window.

Wired network setup

- 7 Enter the machine's new information into the configuration window as follows. In a corporate intranet, you may need to have this information assigned by a network manager before proceeding.

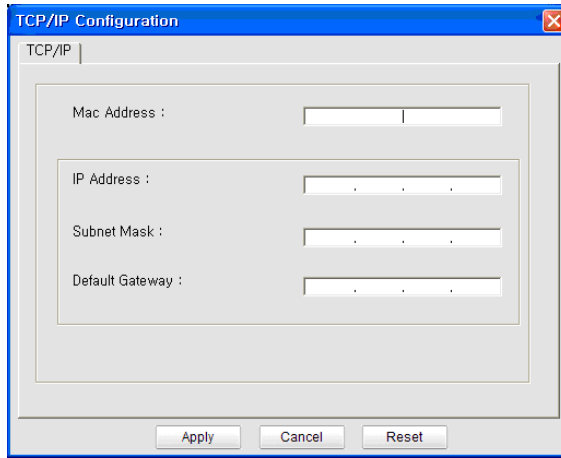

-  Find the machine's MAC address from the **Network Configuration Report** (see "Printing a network configuration report" on page 152) and enter it without the colons. For example, 00:15:99:29:51:A8 becomes 0015992951A8.

- 8 Click **Apply**, and then click **OK**. The machine will automatically print the **Network Configuration Report**. Confirm that all the settings are correct.

IPv4 configuration using SetIP (Mac)

Before using the SetIP program, disable the computer firewall from **System Preferences > Security > Firewall**.



The following instructions may vary from your model.

- 1 Connect your machine to the network with a network cable.
- 2 Insert the Installation CD-ROM, and open the disk window, select **MAC_Installer > MAC_Printer > SetIP > SetIPApplet.html**.
- 3 Double-click the file and **Safari** will automatically open, then select **Trust**. The browser will open the **SetIPApplet.html** page that shows the printer's name and IP address information.
- 4 Click the  icon (third from left) in the SetIP window to open the TCP/IP configuration window.
- 5 Enter the machine's new information into the configuration window. In a corporate intranet, you may need to have this information assigned by a network manager before proceeding.

Wired network setup



Find the machine's MAC address from the **Network Configuration Report** (see "Printing a network configuration report" on page 152) and enter it without the colons. For example, 00:15:99:29:51:A8 becomes 0015992951A8.

6 Select **Apply**, then **OK**, and **OK** again.

7 Quit **Safari**.



Find the machine's MAC address from the **Network Configuration Report** (see "Printing a network configuration report" on page 152) and enter it without the colons. For example, 00:15:99:29:51:A8 becomes 0015992951A8.

5 The machine will automatically print the **Network Configuration Report**.

IPv4 configuration using SetIP (Linux)

Before using the SetIP program, disable the computer firewall from **System Preferences** or **Administrator**.



The following instructions may vary from your model or operating systems.

1 Open `/opt/Samsung/mfp/share/utils/`.

2 Double-click the **SetIPApplet.html** file.

3 Click to open the TCP/IP configuration window.

4 Enter the machine's new information into the configuration window. In a corporate intranet, you may need to have this information assigned by a network manager before proceeding.

Installing driver over the network



- Some features and optional goods may not be available depending on model or country (see "Features by models" on page 7).
- The machine that does not support the network interface, it will not be able to use this feature (see "Rear view" on page 23).
- You can install the printer driver and software when you insert the software CD into your CD-ROM drive.
For windows, select the printer driver and software in the **Select Software to Install** window.

Windows

- 1 Make sure that the machine is connected to the network and powered on. Also, your machine's IP address should have been set (see "Setting IP address" on page 152).
- 2 Insert the supplied software CD into your CD-ROM drive.

- 3 Read and check **The software End User License Agreement** and **Using Enhanced Features and Participating in Printer Usage Information Collection Program** (optional). Then, click **Next**.

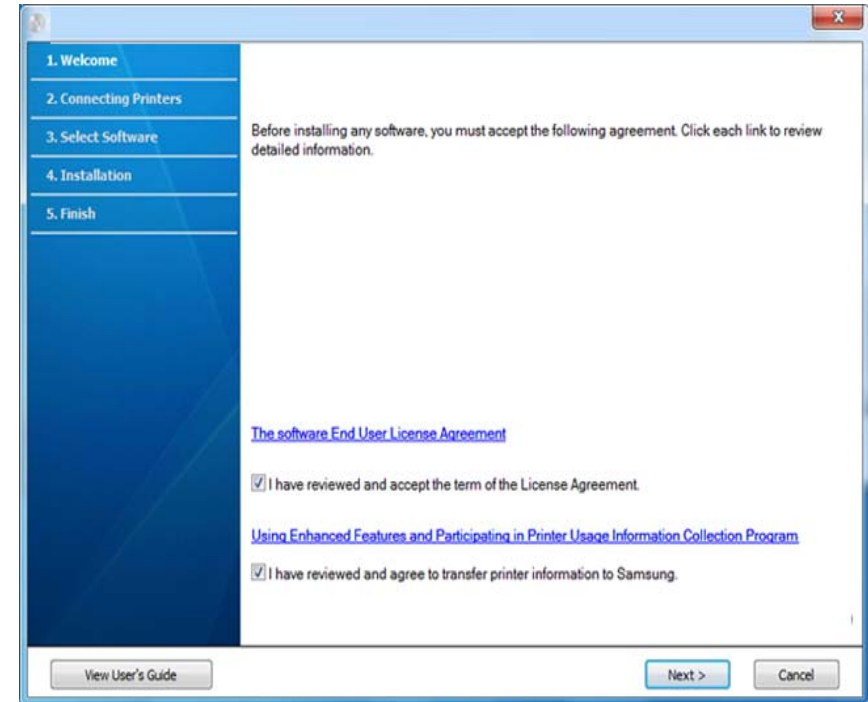

- 4 Select **Network connection** on the **Printer Connection Type** screen.
- 5 If the **Connect Device** window appears, check that the machine is connected to your network. Then, click **Next**.



The firewall software might be blocking network communication. Before connecting the device to the network, disable the computer's firewall.

Installing driver over the network

6 The searched machines will be shown on the screen. Select the one you wish to use and click **OK**.

7 Follow the instructions in the installation window.

Silent installation Mode



Silent installation mode is an installation method that does not require any user intervention. Once you start the installation, the machine driver and software are automatically installed on your computer. You can start the silent installation by typing */s* or */S* in the command window.

Command-line Parameters

Following table shows commands that can be used in the command window.

 Following command-line are effective and operated when command is used with */s* or */S*. But */h*, */H* or */?* are exceptional commands that can be operated solely.

Command- line	Definition	Description
<i>/s</i> or <i>/S</i>	Starts silent installation.	Installs machine drivers without prompting any UIs or user intervention.

Command- line	Definition	Description
<i>/p"<port name>"</i> or <i>/P"<port name>"</i>	<p>Specifies printer port.</p> <p> Network Port will be created by use of Standard TCP/IP Port monitor. For local port, this port must exist on system before being specified by command.</p>	<p>Printer port name can be specified as IP address, hostname, USB local port name or IEEE1284 port name.</p> <p>For example:</p> <ul style="list-style-type: none"><i>/p"xxx.xxx.xxx.xxx"</i> in where, "xxx.xxx.xxx.xxx" means IP address for network printer. <i>/p"USB001"</i>, <i>/P"LPT1:"</i>, <i>/p"hostname"</i>
<i>/a"<dest_path>"</i> or <i>/A"<dest_path>"</i>	<p>Specifies destination path for installation.</p> <p> The destination path should be a fully qualified path.</p>	<p>Since machine drivers should be installed on the OS specific location, this command applies to only application software.</p>
<i>/n"<Printer name>"</i> or <i>/N"<Printer name>"</i>	<p>Specifies printer name. Printer instance shall be created as specified printer name.</p>	<p>With this parameter, you can add printer instances as you wish.</p>

Installing driver over the network

Command- line	Definition	Description
/nd or /ND	Commands not to set the installed driver as a default machine driver.	It indicates installed machine driver will not be the default machine driver on your system if there are one or more printer drivers installed. If there is no installed machine driver on your system, then this option won't be applied because Windows OS will set installed printer driver as a default machine driver.
/x or /X	Uses existing machine driver files to create printer instance if it is already installed.	This command provides a way to install a printer instance that uses installed printer driver files without installing an additional driver.
/up"<printer name>" or /UP"<printer name>"	Removes only specified printer instance and not the driver files.	This command provides a way to remove only specified printer instance from your system without effecting other printer drivers. It will not remove printer driver files from your system.

Command- line	Definition	Description
/d or /D	Uninstalls all device drivers and applications from your system.	This command will remove all installed device drivers and application software from your system.
/v"<share name>" or /V"<share name>"	Shares installed machine and add other available platform drivers for Point & Print.	It will install all supported Windows OS platform's machine drivers to system and share it with specified <share name> for point and print.
/o or /O	Opens Printers and Faxes folder after installation.	This command will open Printers and Faxes folder after the silent installation.
/h, /H or /?	Shows Command-line Usage.	

Mac

- 1 Make sure that the machine is connected to your network and powered on.
- 2 Insert the supplied software CD into your CD-ROM drive.
- 3 Double-click the CD-ROM icon that appears on your Mac desktop.

Installing driver over the network

4 Double-click the **MAC_Installer** folder > **Installer OS X** icon.

5 Click **Continue**.

6 Read the license agreement and click **Continue**.

7 Click **Agree** to agree to the license agreement.

8 When the message which warns that all applications will close on your computer appears, click **Continue**.

9 Click **Continue** on the **User Options Pane**.



If you have not set the IP address yet, click Set IP address and refer to "IPv4 configuration using SetIP (Mac)" on page 153. If you want to set the wireless setting, refer to "Setup using Mac" on page 174.

10 Click **Install**. All components necessary for machine operations will be installed.

If you click **Customize**, you can choose individual components to install.

11 Enter the password and click **OK**.

12 Installing software requires you to restart your computer. Click **Continue Installation**.

13 After the installation is finished, click **Quit** or **Restart**.

14 Open the **Applications** folder > **Utilities** > **Print Setup Utility**.

- For Mac OS X 10.5-10.8, open the **Applications** folder > **System Preferences** and click **Print & Fax**.

15 Click **Add** on the **Printer List**.

- For Mac OS X 10.5-10.8, click the "+" icon. A display window will pop up.

16 For Mac OS X 10.4, click **IP Printer**.

- For Mac OS X 10.5-10.8, click **IP**.

17 Select **HP Jetdirect - Socket** in **Protocol**.



When printing a document containing many pages, printing performance may be enhanced by choosing **Socket** for **Printer Type** option.

18 Enter the machine's IP address in the **Address** input field.

19 Enter the queue name in the **Queue** input field. If you cannot determine the queue name for your machine server, try using the default queue first.

Installing driver over the network

20 For Mac OS X 10.4, if Auto Select does not work properly, select **Samsung** in **Print Using** and your machine name in **Model**.

- For Mac OS X 10.5-10.8, if Auto Select does not work properly, choose **Select Printer Software** and your machine name in **Print Using**.

21 Click **Add**.

Your machine appears in the **Printer List**, and is set as the default machine.



To install the fax driver:

- a** Open the **Applications** folder > **Samsung** > **Fax Queue Creator**.
- b** Your machine appears on the **Printer List**.
- c** Select machine to use and Click **Create** button.

Linux

You need to download Linux software packages from the Samsung website to install the printer software (<http://www.samsung.com> > find your product > Support or Downloads).

Install the Linux driver and add network printer

- 1** Make sure that the machine is connected to your network and powered on. Also, your machine's IP address should have been set.
- 2** Download the Unified Linux Driver package from the Samsung website.
- 3** Extract the UnifiedLinuxDriver.tar.gz file and open the new directory.
- 4** Double-click the **cdroot** > **autorun**
- 5** The Samsung installer window opens. Click **Next**.
- 6** The add printer wizard window opens. Click **Next**.
- 7** Select network printer and click **Search** button.
- 8** The machine's IP address and model name appears on list field.
- 9** Select your machine and click **Next**.
- 10** Input the printer description and **Next**.
- 11** After the machine is added, click **Finish**.
- 12** When installation is done, click **Finish**.

Installing driver over the network

Add a network printer

- 1 Double-click the **Unified Driver Configurator**.
- 2 Click **Add Printer**.
- 3 The **Add printer wizard** window opens. Click **Next**.
- 4 Select **Network printer** and click the **Search** button.
- 5 The printer's IP address and model name appears on list field.
- 6 Select your machine and click **Next**.
- 7 Enter the printer description and click **Next**.
- 8 After the machine is added, click **Finish**.

IPv6 configuration



IPv6 is supported properly only in Windows Vista or higher.



- Some features and optional goods may not be available depending on model or country (see "Features by models" on page 7 or "Menu overview" on page 35).
- If the IPv6 network seems to not be working, set all the network setting to the factory defaults and try again using **Clear Setting**.

The machine supports the following IPv6 addresses for network printing and managements.

- **Link-local Address:** Self-configured local IPv6 address (Address starts with FE80).
- **Stateless Address:** Automatically configured IPv6 address by a network router.
- **Stateful Address:** IPv6 address configured by a DHCPv6 server.
- **Manual Address:** Manually configured IPv6 address by a user.

In the IPv6 network environment, follow the next procedure to use the IPv6 address.

From the control panel

Activating IPv6

- 1 Press the  (**Menu**) button on the control panel.
- 2 Press **Network > TCP/IP (IPv6) > IPv6 Activate**.
- 3 Select **On** and press **OK**.
- 4 Turn the machine off and turn it on again.



When you install the printer driver, do not configure both IPv4 and IPv6. We recommend to configure either IPv4 or IPv6 (see "Installing driver over the network" on page 155).

DHCPv6 address configuration

If you have a DHCPv6 server on your network, you can set one of the following options for default dynamic host configuration.

- 1 Press the  (**Menu**) button on the control panel.
- 2 Press **Network > TCP/IP (IPv6) > DHCPv6 Config**.

IPv6 configuration

- 3 Press **OK** to select the required value you want.
 - **DHCPv6 Addr.:** Always use DHCPv6 regardless of router request.
 - **DHCPv6 Off:** Never use DHCPv6 regardless of router request.
 - **Router:** Use DHCPv6 only when requested by a router.

From the SyncThru™ Web Service

Activating IPv6

- 1 Access a web browser, such as Internet Explorer, from Windows. Enter the machine IP address (http://xxx.xxx.xxx.xxx) in the address field and press the Enter key or click **Go**.
- 2 If it's your first time logging into **SyncThru™ Web Service** you need to log-in as an administrator. Type in the below default ID and password. We recommend you to change the default password for security reasons.
 - **ID: admin**
 - **Password: sec00000**
- 3 When the **SyncThru™ Web Service** window opens, move the mouse cursor over the **Settings** of the top menu bar and then click **Network Settings**.
- 4 Click **TCP/IPv6** on the left pane of the website.

- 5 Check the **IPv6 Protocol** check box to activate IPv6.
- 6 Click the **Apply** button.
- 7 Turn the machine off and turn it on again.



- You can also set the DHCPv6.
- To manually set the IPv6 address:
Check the **Manual Address** check box. Then, the **Address/Prefix** text box is activated. Enter the rest of the address (e.g., :3FFE:10:88:194::**AAAA**. "A" is the hexadecimal 0 through 9, A through F).

IPv6 address configuration

- 1 Start a web browser, such as Internet Explorer, that supports IPv6 addressing as a URL.
- 2 Select one of the IPv6 addresses (**Link-local Address**, **Stateless Address**, **Stateful Address**, **Manual Address**) from **Network Configuration Report** (see "Printing a network configuration report" on page 152).
 - **Link-local Address:** Self-configured local IPv6 address (Address starts with FE80).
 - **Stateless Address:** Automatically configured IPv6 address by a network router.

IPv6 configuration

- **Stateful Address:** IPv6 address configured by a DHCPv6 server.
- **Manual Address:** Manually configured IPv6 address by a user.

3 Enter the IPv6 addresses (e.g.,: `http://[FE80::215:99FF:FE66:7701]`).



Address must be enclosed in '[' brackets.

Wireless network setup



- Make sure your machine supports wireless networking. Wireless networking may not be available depending on the model (see "Features by models" on page 7).
- If the IPv6 network seems to not be working, set all the network settings to the factory defaults and try again using **Clear Setting**.

Getting started

Understanding your network type

Typically, you can only have one connection between your computer and the machine at a time.

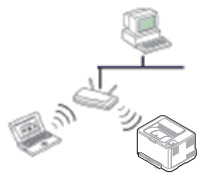

Infrastructure mode

This is an environment generally used for homes and SOHOs (Small Office/ Home Office). This mode uses an access point to communicate with the wireless machine.



Ad hoc mode

This mode does not use an access point. The wireless computer and wireless machine communicate directly.

Wireless network name and network password

Wireless networks require higher security, so when an access point is first set up, a network name (SSID), the type of security used, and a Network Password are created for the network. Ask your network administrator about this information before proceeding with the machine installation.

Wireless network setup

Introducing wireless set up methods

You can set wireless settings either from the machine or the computer. Choose the setting method from the below table.



Some wireless network installation types may not be available depending on the model or country.

Set up method	Connecting method	Description & Reference	
With Access Point	From th computer	Windows user, see "Access point via USB cable (recommended)" on page 170.	A
		Mac user, see "Access point via USB cable (recommended)" on page 175.	B
		See "Using a network cable" on page 178.	C
	From th machine's control panel	<ul style="list-style-type: none">• See "Machines with a display screen" on page 167.• See "Machines without a display screen" on page 168.	D
		See "Using the menu button" on page 169.	E
Without Access Point	From th computer	Windows user, see "Ad hoc via USB cable" on page 172.	F
		Mac user, see "Ad hoc via USB cable" on page 176.	G
	Wi-Fi Direct setup	See "Setting up Wi-Fi Direct" on page 182.	H



- If problems occur during wireless set up or driver installation, refer to the troubleshooting chapter (see "Troubleshooting" on page 183).
- It is strongly recommended that you set the password on Access Points. If you do not set the password on Access Points, they might be exposed to illegal access from unknown machines including PCs, smart phones and printers. Refer to the Access Point user' guide for password settings.

Wireless network setup

Using the WPS button

If your machine and an access point (or wireless router) support Wi-Fi Protected Setup™ (WPS), you can easily configure the wireless network settings by pressing the  (WPS) button on the control panel without a computer.





- If you want to use the wireless network using the infrastructure mode, make sure that the network cable is disconnected from the machine. Using the **WPS (PBC)** button or entering the PIN from the computer to connect to the access point (or wireless router) varies depending on the access point (or wireless router) you are using. Refer to the user's guide of the access point (or wireless router) you are using.
- When using the WPS button to set the wireless network, security settings may change. To prevent this, lock the WPS option for the current wireless security settings. The option name may differ depending on the access point (or wireless router) you are using.

Items to prepare

- Check if the access point (or wireless router) supports Wi-Fi Protected Setup™ (WPS).
- Check if your machine supports Wi-Fi Protected Setup™ (WPS).
- Networked computer (PIN mode only)

Choosing your type

There are two methods available to connect your machine to a wireless network using the  (WPS) button on the control panel.

The **Push Button Configuration (PBC)** method allows you to connect your machine to a wireless network by pressing both the  (WPS) button on the control panel of your machine and the WPS (PBC) button on a Wi-Fi Protected Setup™ WPS-enabled access point (or wireless router) respectively.

The **Personal Identification Number (PIN)** method helps you connect your machine to a wireless network by entering the supplied PIN information on a Wi-Fi Protected Setup™ WPS-enabled access point (or wireless router).

Factory default in your machine is **PBC** mode, which is recommended for a typical wireless network environment.



You can change the WPS mode in control panel ( **(Menu)** > **Network** > **Wireless** > **OK** > **WPS Setting**).

Wireless network setup

Machines with a display screen

Connecting in PBC mode

- 1** Press and hold the  (WPS) button on the control panel for more than 2 seconds.
The machine starts waiting for up to two minutes until you press the WPS (PBC) button on the access point (or wireless router).
- 2** Press the **WPS (PBC)** button on the access point (or wireless router).
The messages are displayed on the display screen in the order below:
 - a Connecting:** The machine is connecting to the access point (or wireless router).
 - b Connected:** When the machine is successfully connected to the wireless network, the WPS LED light stays on.
 - c AP SSID:** After completing the wireless network connection process, the AP's SSID information appears on the display.
- 3** Insert the supplied software CD into your CD-ROM drive, and follow the instructions in the window to set up the wireless network.

Connecting in PIN mode

- 1** Press and hold the  (WPS) button on the control panel for more than 2 seconds.
- 2** The eight-digit PIN appears on the display.
You need to enter the eight-digit PIN within two minutes on the computer that is connected to the access point (or wireless router).
The messages are displayed on the display screen in the order below:
 - a Connecting:** The machine is connecting to the wireless network.
 - b Connected:** When the machine is successfully connected to the wireless network, the WPS LED light stays on.
 - c SSID Type:** After completing the wireless network connection process, the AP's SSID information is displayed on the LCD display.
- 3** Insert the supplied software CD into your CD-ROM drive, and follow the instructions in the window to set up the wireless network.

Wireless network setup

Machines without a display screen



Connecting in PBC mode

- 1 Press and hold the  (WPS) button on the control panel for about 2 - 4 seconds until the status LED blinks quickly.

The machine starts connecting to the wireless network. The LED blinks slowly for up to two minutes until you press the PBC button on the access point (or wireless router).
- 2 Press the **WPS (PBC)** button on the access point (or wireless router).
 - a The light blinks fast on the WPS LED. The machine is connecting to the access point (or wireless router).
 - b When the machine is successfully connected to the wireless network, the WPS LED light stays on.
- 3 Insert the supplied software CD into your CD-ROM drive, and follow the instructions in the window to set up the wireless network.

Connecting in PIN mode

- 1 The network configuration report, including PIN, must be printed (see "Printing a network configuration report" on page 152).

In ready mode, press and hold the  (**Cancel** or **Stop/Clear**) button on the control panel for about 5 seconds. You can find your machine's PIN.
- 2 Press and hold the  (WPS) button on the control panel for more than 4 seconds until the status LED stays on.

The machine starts connecting to the access point (or wireless router).
- 3 You need to enter the eight-digit PIN within two minutes on the computer that is connected to the access point (or wireless router).

The LED blinks slowly for up to two minutes until you enter the eight-digit PIN.

The WPS LED blinks in the order below:
 - a The light blinks fast on the WPS LED. The machine is connecting to the access point (or wireless router).
 - b When the machine is successfully connected to the wireless network, the WPS LED light stays on.
- 4 Insert the supplied software CD into your CD-ROM drive, and follow the instructions in the window to set up the wireless network.

Wireless network setup

Re-connecting to a network

When the wireless function is off, the machine automatically tries to re-connect to the access point (or wireless router) with the previously used wireless connection settings and address.



In the following cases, the machine automatically re-connects to the wireless network:

- The machine is turned off and on again.
- The access point (or wireless router) is turned off and on again.

Canceling the connection process

To cancel the wireless network connection when the machine is connecting to the wireless network, press and release the  (**Cancel** or **Stop/Clear**) on the control panel. **You need to wait 2 minutes to re-connect to the wireless network.**

Disconnecting from a network

To disconnect the wireless network connection, press the  (WPS) button on the control panel for more than two seconds.

- **When the Wi-Fi network is in idle mode:** The machine is immediately disconnected from the wireless network and the WPS LED turns off.
- **When the Wi-Fi network is being used:** While the machine waits until the current job is finished, the light blinks fast on the WPS LED. Then, the wireless network connection is automatically disconnected and the WPS LED turns off.

Using the menu button



Some menus may not appear in the display depending on options or models. If so, it is not applicable to your machine (see "Menu overview" on page 35).

Before starting, you will need to know the network name (SSID) of your wireless network and the network key if it is encrypted. This information was set when the access point (or wireless router) was installed. If you do not know about your wireless environment, please ask the person who set up your network.

Wireless network setup



After completing the wireless network connection, you need to install a machine driver to print from an application (see "Installing driver over the network" on page 155).

- 1 Press the  (**Menu**) button on the control panel.
- 2 Press **Network > Wireless > WLAN Settings**.
- 3 Press the **OK** to select the setup method you want.
 - **Wizard** (recommended): In this mode, the setup is automatic. The machine will display a list of available networks from which to choose. After a network is chosen then printer will prompt for the corresponding security key.
 - **Custom**: In this mode, users can give or edit manually their own SSID, or choose the security option in detail.

Setup using Windows



Shortcut to the **Wireless Setting** program without the CD: If you have installed the printer driver once, you can access the **Wireless Setting** program without the CD. From the Start menu, select **Programs** or **All Programs > Samsung Printers > your printer driver name > Wireless Setting Program**.

Access point via USB cable (recommended)

Items to prepare

- Access point
- Network-connected computer
- Software CD that was provided with your machine
- A machine installed with a wireless network interface
- USB cable

Creating the infrastructure network

- 1 Check whether the USB cable is connected to the machine.
- 2 Turn on your computer, access point, and machine.
- 3 Insert the supplied software CD into your CD-ROM drive.

Wireless network setup

- 4 Read and check **The software End User License Agreement** and **Using Enhanced Features and Participating in Printer Usage Information Collection Program** (optional). Then, click **Next**.

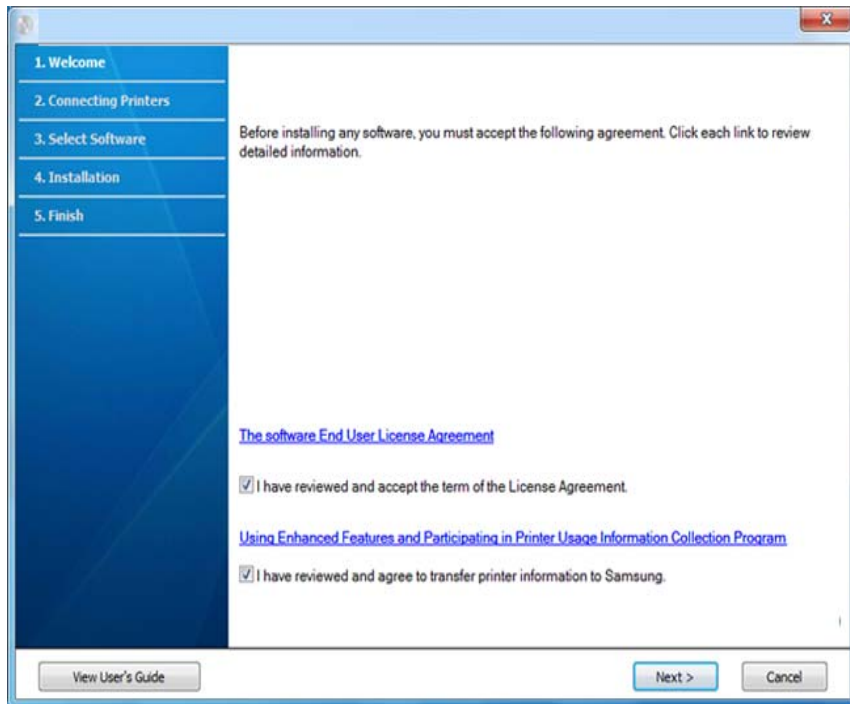

- 5 Select **Configure the wireless network connection using USB cable** on the **Printer Connection Type** screen. Then, click **Next**.
- 6 After searching, the window shows the wireless network devices. Select the name (SSID) of the access point you want to use and click **Next**.



If you cannot find the network name you want to choose, or if you want to set the wireless configuration manually, click **Advanced Setting**.

- **Enter the wireless Network Name:** Enter the SSID of the access point (SSID is case-sensitive).
- **Operation Mode:** Select **Infrastructure**.
- **Authentication:** Select an authentication type.
 - Open System:** Authentication is not used, and encryption may or may not be used, depending on the need for data security.
 - Shared Key:** Authentication is used. A device that has a proper WEP key can access the network.
 - WPA Personal or WPA2 Personal:** Select this option to authenticate the print server based on a WPA Pre-Shared Key. This uses a shared secret key (generally called Pre Shared Key pass phrase), which is manually configured on the access point and each of its clients.
- **Encryption:** Select the encryption (None, WEP64, WEP128, TKIP, AES, TKIP AES).
- **Network Password:** Enter the encryption network password value.
- **Confirm Network Password:** Confirm the encryption network password value.
- **WEP Key Index:** If you are using WEP Encryption, select the appropriate **WEP Key Index**.



The wireless network security window appears when the access point has security settings.

Enter the Network Password of the access point (or router).

Wireless network setup

- 7 If your printer supports Wi-Fi Direct, its corresponding screen will appear. Click **Ok** and **Next**.



- Wi-Fi Direct option appears on the screen only if your printer supports this feature.
- Can start to build Wi-Fi Direct by using Samsung Easy Printer Manager (see "Setting up Wi-Fi Direct" on page 182).
- **Wi-Fi Direct Name:** The default Network Name is the model name and the maximum length is 22 characters (not including "DIRECT-XX-").
- **Password setting** is the numeric string, and the size is 8 ~ 64 characters.

- 8 When the wireless network set up is completed, disconnect the USB cable between the computer and machine. Click **Next**.

- 9 Select software to be installed.

- 10 After selecting the components, you can also change the printer driver name, set the machine to be shared on the network, set the machine as the default machine. Click **Next**.

- 11 If you want to register your machine with the Samsung web site and receive useful information, click **On-line Registration**. If not, click **Finish**.

Ad hoc via USB cable

If you do not have an access point (AP), you may still connect the machine wirelessly to your computer by setting up an ad-hoc wireless network by following the simple steps below.

Items to prepare

- Network-connected computer
- Software CD that was provided with your machine
- A machine installed with a wireless network interface
- USB cable

Creating the ad hoc network in Windows

- 1 Check whether the USB cable is connected to the machine.
- 2 Turn on your computer and the wireless network machine.
- 3 Insert the supplied software CD into your CD-ROM drive.

Wireless network setup

- 4 Read and check **The software End User License Agreement** and **Using Enhanced Features and Participating in Printer Usage Information Collection Program** (optional). Then, click **Next**.

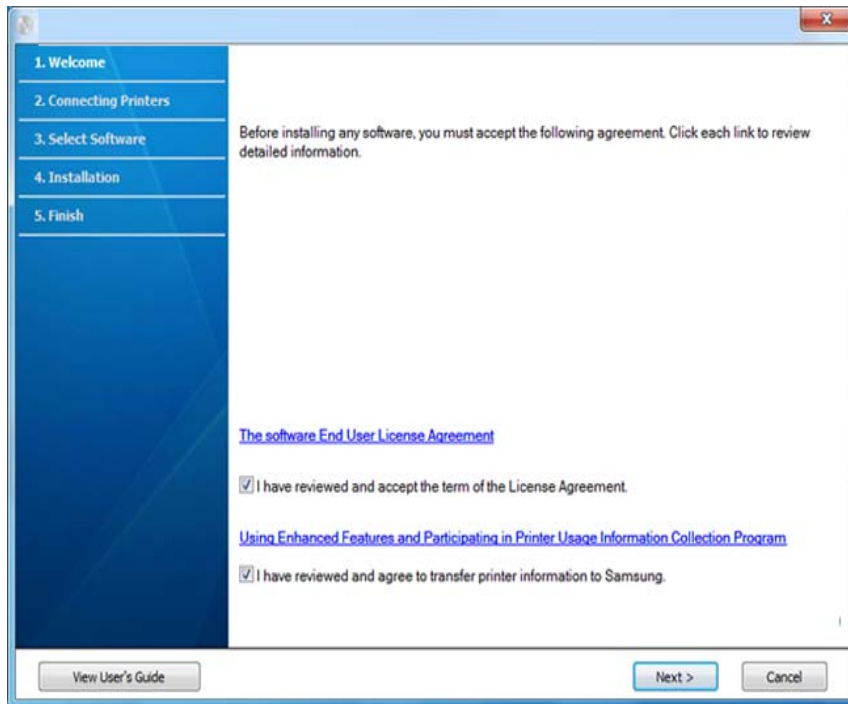

- 5 Select **Configure the wireless network connection using USB cable** on the **Printer Connection Type** screen. Then, click **Next**.
- 6 After searching the wireless networks, a list of wireless networks your machine has searched appears. Click **Advanced Setting**.



- **Enter the wireless Network Name:** Enter the SSID name you want (SSID is case-sensitive).
- **Operation Mode:** Select ad hoc.
- **Channel:** Select the channel. (**Auto Setting** or 2412 MHz to 2467 MHz).
- **Authentication:** Select an authentication type.
 - Open System:** Authentication is not used, and encryption may or may not be used, depending on the need for data security.
 - Shared Key:** Authentication is used. A device that has a proper WEP key can access the network.
- **Encryption:** Select the encryption (None, WEP64, WEP128).
- **Network Password:** Enter the encryption network password value.
- **Confirm Network Password:** Confirm the encryption network password value.
- **WEP Key Index:** If you are using WEP Encryption, select the appropriate **WEP Key Index**.

The wireless network security window appears when the ad hoc network has security enabled.

Select **Open System** or **Shared Key** for the authentication and click **Next**.

- WEP (Wired Equivalent Privacy) is a security protocol preventing unauthorized access to your wireless network. WEP encrypts the data portion of each packet exchanged on a wireless network using a 64-bit or 128-bit WEP encryption key.

- 7 The window showing the wireless network setting appears. Check the settings and click **Next**.

Wireless network setup



Before entering the IP address for the machine, you must know the computer's network configuration information. If the computer's network configuration is set to DHCP, the wireless network setting should also be DHCP. Likewise, if the computer's network configuration is set to Static, the wireless network setting should also be Static.

If your computer is set to DHCP and you want to use the Static wireless network setting, you must contact the network administrator to get the static IP address.

- **For the DHCP method**

If the IP address assignment method is DHCP, check if DHCP is shown in the **Wireless Network Setting Confirm** window. If it shows Static, click **Change TCP/IP** to change the assignment method to **Receive IP address automatically (DHCP)**.

- **For the Static method**

If the IP address assignment method is Static, check if Static is shown in the **Wireless Network Setting Confirm** window. If it shows DHCP, click **Change TCP/IP** to enter the IP address and other network configuration values for the machine.

For example,

If the computer's network information is as shown follows:

- IP address: 169.254.133.42
- Subnet Mask: 255.255.0.0

Then, the machine's network information should be as below:

- IP address: 169.254.133.**43**
- Subnet Mask: 255.255.0.0 (Use the computer's subnet mask.)
- Gateway: 169.254.133.**1**

- 8 The **Wireless Network Setting Complete** window appears. Click **Next**.
- 9 When the wireless network settings are completed, disconnect the USB cable between the computer and machine. Click **Next**.
- 10 Select software to be installed.
- 11 After selecting the components, you can also change the printer driver name, set the machine to be shared on the network, set the machine as the default machine. Click **Next**.
- 12 If you want to register your machine with the Samsung web site and receive useful information, click **On-line Registration**. If not, click **Finish**.

Setup using Mac

Items to prepare

- Access point
- Network-connected computer
- Software CD that was provided with your machine
- A machine installed with a wireless network interface
- USB cable

Wireless network setup

Access point via USB cable (recommended)

- 1 Check whether the USB cable is connected to the machine.
- 2 Turn on your computer, access point, and machine.
- 3 Insert the supplied software CD into your CD-ROM drive.
- 4 Double-click the CD-ROM icon that appears on your Mac desktop.
- 5 Double-click the **MAC_Installer** folder > **Installer OS X** icon.
- 6 Click **Continue**.
- 7 Read the license agreement and click **Continue**.
- 8 Click **Agree** to agree to the license agreement.
- 9 When the message that warns that all applications will close on your computer appears, click **Continue**.
- 10 Click **Wireless Network Setting** button on the **User Options Pane**.
- 11 After searching, the window shows the wireless network devices. Select the name (SSID) of the access point you want to use and click **Next**.

If the wireless network is already set up, the **Wireless Network Information** window appears. Select **I want to install software with the current settings. (Recommended)**. Then, click **Next**.



When you set the wireless configuration manually, click **Advanced Setting**.

- **Enter the wireless Network Name:** Enter the SSID of the access point (SSID is case-sensitive).
- **Operation Mode:** Select **Infrastructure**.
- **Authentication:** Select an authentication type.
 - Open System:** Authentication is not used, and encryption may or may not be used, depending on the need for data security.
 - Shared Key:** Authentication is used. A device that has a proper WEP key can access the network.
 - WPA Personal or WPA2 Personal:** Select this option to authenticate the print server based on the WPA Pre-Shared Key. This uses a shared secret key (generally called Pre Shared Key pass phrase) that is manually configured on the access point and each of its clients.
- **Encryption:** Select the encryption. (None, WEP64, WEP128, TKIP, AES, TKIP, AES)
- **Network Password:** Enter the encryption network password value.
- **Confirm Network Password:** Confirm the encryption network password value.
- **WEP Key Index:** If you are using WEP Encryption, select the appropriate **WEP Key Index**.

The wireless network security window appears when the access point has security enabled.

Enter the Network Password of the access point (or router).

Wireless network setup

- 12** If your printer supports Wi-Fi Direct, the following screen appears. Click **Next**.



- Can start to build Wi-Fi Direct by using Samsung Easy Printer Manager (see "Setting up Wi-Fi Direct" on page 182).
- **Network Name(SSID):** The default Network Name is the model name and the maximum length is 22 characters (not including "DIRECT-").
- **Network Password** is the numeric string, and the size is 8 ~ 64 characters.

- 13** When the wireless network settings are completed, disconnect the USB cable between the computer and machine.

- 14** Wireless network set up is completed. After the installation is finished, click **Quit**.



After completing the wireless network connection, you need to install a machine driver to print from an application (see "Installation for Mac" on page 146).

Ad hoc via USB cable

If you do not have an access point (AP), you may still connect the machine wirelessly to your computer by setting up an ad hoc wireless network by following these simple directions.

Items to prepare

- Network-connected computer
- Software CD that was provided with your machine
- A machine installed with a wireless network interface
- USB cable

Creating the ad hoc network in Mac

- 1** Check whether the USB cable is connected to the machine.
- 2** Turn on your computer and the wireless network machine.

Wireless network setup

- 3 Insert the supplied software CD into your CD-ROM drive.
- 4 Double-click the CD-ROM icon that appears on your Mac desktop.
- 5 Double-click the **MAC_Installer** folder > **Installer OS X** icon.
- 6 Click **Continue**.
- 7 Read the license agreement and click **Continue**.
- 8 Click **Agree** to agree to the license agreement.
- 9 When the message that warns that all applications will close on your computer appears, click **Continue**.
- 10 Click **Wireless Network Setting** button on the **User Options Pane**.
- 11 After searching the wireless networks, a list of wireless networks your machine has searched appears. Click **Advanced Setting**.



- **Enter the wireless Network Name:** Enter the SSID name (SSID is case-sensitive).
- **Operation Mode:** Select ad hoc.
- **Channel:** Select the channel (**Auto Setting** or 2412 MHz to 2467 MHz).
- **Authentication:** Select an authentication type.
Open System: Authentication is not used, and encryption may or may not be used, depending on the need for data security.
Shared Key: Authentication is used. A device that has a proper WEP key can access the network.

- **Encryption:** Select the encryption (None, WEP64, WEP128).
- **Network Password:** Enter the encryption network password value.
- **Confirm Network Password:** Confirm the encryption network password value.
- **WEP Key Index:** If you are using WEP Encryption, select the appropriate **WEP Key Index**.

The wireless network security window appears when the ad hoc network has security setting.

Select **Open System** or **Shared Key** for the authentication and click **Next**.

- WEP (Wired Equivalent Privacy) is a security protocol preventing unauthorized access to your wireless network. WEP encrypts the data portion of each packet exchanged on a wireless network using a 64-bit or 128-bit WEP encryption key.

- 12 The window showing the wireless network settings appears. Check the settings and click **Next**.

Wireless network setup



Before entering the IP address for the machine, you must know the computer's network configuration information. If the computer's network configuration is set to DHCP, the wireless network setting should also be DHCP. Likewise, if the computer's network configuration is set to Static, the wireless network setting should also be Static.

If your computer is set to DHCP and you want to use Static wireless network setting, you must contact the network administrator to get the static IP address.

- **For the DHCP method**

If the IP address assignment method is DHCP, check if DHCP is shown in the **Wireless Network Setting Confirm** window. If it shows Static, click **Change TCP/IP** to change the assignment method to **Receive IP address automatically (DHCP)**.

- **For the Static method**

If the IP address assignment method is Static, check if Static is shown in the **Wireless Network Setting Confirm** window. If it shows DHCP, click **Change TCP/IP** to enter the IP address and other network configuration values for the machine.

For example,

If the computer's network information is shown as follows:

- IP address: 169.254.133.42
- Subnet Mask: 255.255.0.0

Then, the machine's network information should be as shown below:

- IP address: 169.254.133.**43**
- Subnet Mask: 255.255.0.0 (Use the computer's subnet mask.)
- Gateway: 169.254.133.**1**

13 When the window that tells you that the network cable connection is confirmed appears, disconnect the network cable and click **Next**.

If the network cable is connected, it may have trouble finding the machine when configuring the wireless network.

14 The wireless network connects according to the network configuration.

15 Wireless network set up is completed. After installation is finished, click **Quit**.



After completing the wireless network connection, you need to install a machine driver to print from an application (see "Installation for Mac" on page 146).

Using a network cable



Machines that do not support the network port will not be able to use this feature (see "Rear view" on page 23).

Your machine is a network compatible machine. To enable your machine to work with your network, you will need to perform some configuration procedures.

Wireless network setup



- After completing the wireless network connection, you need to install a machine driver to print from an application (see "Installing driver over the network" on page 155).
- See your network administrator, or the person that set up your wireless network, for information about your network configuration.

Items to prepare

- Access point
- Network-connected computer
- Software CD that was provided with your machine
- A machine installed with a wireless network interface
- Network cable

Printing a network configuration report

You can identify the network settings of your machine by printing a network configuration report.

See "Printing a network configuration report" on page 152.

IP setting using SetIP Program (Windows)

This program is used to manually set the network IP address of your machine using its MAC address to communicate with the machine. The MAC address is the hardware serial number of the network interface and can be found in the **Network Configuration Report**.

See "Setting IP address" on page 152.

Configuring the machine's wireless network

Before starting you will need to know the network name (SSID) of your wireless network and the network key if it is encrypted. This information was set when the access point (or wireless router) was installed. If you do not know about your wireless environment, please ask the person who set up your network.

To configure wireless parameters, you can use **SyncThru™ Web Service**.

Using SyncThru™ Web Service

Before starting wireless parameter configuration, check the cable connection status.

Wireless network setup

1 Check whether or not the network cable is connected to the machine. If not, connect the machine with a standard network cable.

2 Start a web browser such as Internet Explorer, Safari, or Firefox and enter your machine's new IP address in the browser window.

For example,

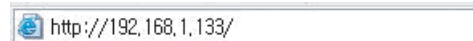

http://192.168.1.133/

3 Click **Login** on the upper right of the SyncThru™ Web Service website.

4 If it's your first time logging into **SyncThru™ Web Service** you need to log-in as an administrator. Type in the below default **ID** and **Password**. We recommend you to change the default password for security reasons.

- **ID: admin**
- **Password: sec00000**

5 When the **SyncThru™ Web Service** window opens, click **Network Settings**.

6 Click **Wireless > Wizard**.

 **Wizard** will help you setup the wireless network configuration. However, if you want to set the wireless network directly, select **Custom**.

7 Select the one **Network Name(SSID)** in the list.

- **SSID:** SSID (Service Set Identifier) is a name that identifies a wireless network, access points, and wireless devices attempting to connect to a specific wireless network must use the same SSID. The SSID is case sensitive.
- **Operation Mode: Operation Mode** refers to the type of wireless connections (see "Wireless network name and network password" on page 164).
 - **Ad-hoc:** Allows wireless devices to communicate directly with each other in a peer-to-peer environment.
 - **Infrastructure:** Allows wireless devices to communicate with each other through an access point.



If your network's **Operation Mode** is **Infrastructure**, select the SSID of the access point. If the **Operation Mode** is **Ad-hoc**, select the machine's SSID.

8 Click **Next**.

If the wireless security setting window appears, enter the registered password (network password) and click **Next**.

9 The confirmation window appears, please check your wireless setup. If the setup is right, click **Apply**.

Wireless network setup



Disconnect the network cable (standard or network). Your machine should then start communicating wirelessly with the network. In case of Ad-hoc mode, you can use a wireless LAN and wired LAN simultaneously.

- 10 Insert the supplied software CD into your CD-ROM drive, and follow the instructions in the window to set up the wireless network.

Turning the Wi-Fi network on/off



If your machine has a display, you can also turn on/off the Wi-Fi from the machine's control panel using the **Network** menu.

- 1 Check whether the network cable is connected to the machine. If not, connect the machine with a standard network cable.
- 2 Start a web browser such as Internet Explorer, Safari, or Firefox and enter your machine's new IP address in the browser window.

For example,



http://192.168.1.133/

- 3 Click **Login** on the upper right of the SyncThru™ Web Service website.

- 4 If it's your first time logging into **SyncThru™ Web Service** you need to log-in as an administrator. Type in the below default **ID** and **Password**. We recommend you to change the default password for security reasons.

- **ID: admin**
- **Password: sec00000**

- 5 When the **SyncThru™ Web Service** window opens, click **Network Settings**.

- 6 Click **Wireless > Custom**.

You can also turn the Wi-Fi network on/off.

Setting the Wi-Fi Direct for mobile printing

Wi-Fi Direct is an easy-to-setup peer-to-peer connection method between the Wi-Fi Direct certified printer and a mobile device that provides a secure connection and better throughput than ad hoc mode.

With Wi-Fi Direct, you can connect your printer to a Wi-Fi Direct network while concurrently connecting to an access point. You can also use a wired network and a Wi-Fi Direct network simultaneously so multiple users can access and print documents both from Wi-Fi Direct and from a wired network.

Wireless network setup



- You cannot connect your mobile device to the internet through the printer's Wi-Fi Direct.
- The supported protocol list may differ from your model, Wi-Fi Direct networks do NOT support IPv6, network filtering, IPSec, WINS, and SLP services.
- The maximum number of devices that can be connected via Wi-Fi Direct is 3.

Setting up Wi-Fi Direct

You can enable Wi-Fi Direct feature by one of the following methods.

From the USB cable-connected computer(recommended)

After the driver installation is complete, Samsung Easy Printer Manager can be set and changes in the Wi-Fi Direct can be made.



Samsung Easy Printer Manager is Available for Windows and Mac OS users only.

- From the **Start** menu, select **Programs** or **All Programs** > **Samsung Printers** > **Samsung Easy Printer Manager** > **Device Settings** > **Network**.
 - **Wi-Fi Direct On/Off:** Select **On** to enable.

- **Device Name:** Enter the printer's name for searching for your printer on a wireless network. By default, the device name is the model name.
- **IP Address:** Enter the IP address of the printer. This IP address is used only for the local network and not for the infrastructure wired or wireless network. We recommend using the default local IP address (the default local IP address of the printer for Wi-Fi Direct is 192.168.3.1)
- **Group Owner:** Activate this option to assign the printer the Wi-Fi Direct group's owner. The **Group Owner** acts similar to a wireless access point. We recommend activating this option.
- **Network Password:** If your printer is a **Group Owner**, a **Network Password** is required for other mobile devices to connect to your printer. You can configure a network password yourself, or can remember the given Network Password that is randomly generated by default.

From the machine (Machines with a display screen)

- Select **Network** > **Wireless** > **Wi-Fi Direct** from the control panel.
- Enable **Wi-Fi Direct**.

From the network-connected computer

If your printer is using a network cable or a wireless access point, you can enable and configure Wi-Fi Direct from SyncThru™ Web Service.

- Access **SyncThru™ Web Service**, select **Settings** > **Network Settings** > **Wireless** > **Wi-Fi Direct**.
- Enable or disable **Wi-Fi Direct** and set other options.

Wireless network setup



- For Linux OS users,
 - Print an IP network configuration report to check the output (see "Printing a network configuration report" on page 152).
 - Access **SyncThru Web Service**, select **Settings > Network Settings > Wireless > Wi-Fi Direct**.
 - Enable or disable **Wi-Fi Direct**.

Setting up the mobile device

- After setting up Wi-Fi Direct from the printer, refer to the user manual of the mobile device you are using to set its Wi-Fi Direct.
- After setting up Wi-Fi Direct, you need to download the mobile printing application (For example: Samsung Mobile printer) to print from your smartphone.



- When you have found the printer you want to connect to from your mobile device, select the printer and the printer's LED will blink. Press the WPS button on the printer and it will be connected to your mobile device.
- If your mobile device does not support WPS, you need to enter the "Network Key" of a printer instead of pushing the WPS button.

Troubleshooting

Problems during setup or driver installation

Printers Not Found

- Your machine may not be turned on. Turn on your computer and the machine.
- USB cable is not connected between your computer and machine. Connect the machine to your computer using the USB cable.
- The machine does not support wireless networking. Check the machine's user's guide included on the software CD supplied with your machine and prepare a wireless network machine.

Connecting Failure - SSID Not Found

- The machine is unable to find the network name (SSID) you have selected or entered. Check the network name (SSID) on your access point and try connecting again.
- Your access point is not turned on. Turn on your access point.

Wireless network setup

Connecting Failure - Invalid Security

- Security is not configured correctly. Check the configured security on your access point and machine.

Connecting Failure - General Connection Error

- Your computer is not receiving a signal from your machine. Check the USB cable and your machine's power.

Connecting Failure - Connected Wired Network

- Your machine is connected with a wired network cable. Remove the wired network cable from your machine.

Connecting Failure - Assigning the IP address

- Cycle the power for the access point (or wireless router) and machine.

PC Connection Error

- The configured network address is unable to connect between your computer and machine.
 - For a DHCP network environment
The receives the IP address automatically (DHCP) when computer is configured to DHCP.



If the printing job is not working in DHCP mode, the problem may be caused by the automatically changed IP address. Compare the IP address between the product's IP address and the printer port's IP address.

How to compare:

- 1 Print the network information report of your printer, and then check the IP address (see "Printing a network configuration report" on page 152).
- 2 Check the printer port's IP address from your computer.
 - a Click the Windows **Start** menu.
 - b For Windows XP/Server 2003, select **Printer and Faxes**.
 - For Windows Server 2008/Vista, select **Control Panel > Hardware and Sound > Printers**.
 - For Windows 7, select **Control Panel > Devices and Printers**.
 - For Windows Server 2008 R2, select **Control Panel > Hardware > Devices and Printers**.
 - c Right-click your machine.
 - d For Windows XP/2003/2008/Vista, press **Properties**.
For Windows 7 and Windows Server 2008 R2, from context menus, select the **Printer properties**.
If **Printer properties** item has ► mark, you can select other printer drivers connected with selected printer.

Wireless network setup

- e Click **Port** tab.
 - f Click **Configure Port..** button.
 - g Check if **Printer Name** or **IP Address:** is the IP address on the network configuration Sheet.
- 3** Change the printer port's IP address if it is different from the network information report's.
- If you want to use the software installation CD to change the port IP, connect to a network printer. Then reconnect the IP address.

- For a Static network environment

The machine uses the static address when the computer is configured to static address.

For example,

If the computer's network information is as shown below:

- IP address: 169.254.133.42
- Subnet Mask: 255.255.0.0

Then the machine's network information should be as below:

- IP address: 169.254.133.**43**
- Subnet Mask: 255.255.0.0 (Use the computer's subnet mask.)
- Gateway: 169.254.133.**1**

Other problems

If problems occur while using the machine on a network, check the following:



For information on the access point (or wireless router), refer to its own user's guide.

- You cannot enable wired and wireless networks at the same time.
 - Your computer, access point (or wireless router), or machine may not be turned on.
 - Check the wireless reception around the machine. If the router is far from the machine or there is an obstacle, you might have difficulty receiving the signal.
 - Cycle the power for the access point (or wireless router), machine, and computer. Sometimes cycling the power can recover network communication.
 - Check whether firewall software (V3 or Norton) is blocking the communication.
- If the computer and the machine are connected on the same network and it cannot be found when searching, firewall software might be blocking the communication. Refer to the user's guide for the software to turn it off and try searching for the machine again.
- Check whether the machine's IP address is allocated correctly. You can check the IP address by printing the network configuration report.
 - Check whether the access point (or wireless router) has a configured security (password). If it has a password, refer to the access point (or wireless router) administrator.

Wireless network setup

- Check the machine's IP address. Reinstall the machine driver and change the settings to connect to the machine on the network. Due to the characteristics of DHCP, the allocated IP address could change if the machine is not used for a long time or if the access point has been reset.

Register the product's MAC address when you configure the DHCP server on the access point (or wireless router). Then you can always use the IP address that is set with the MAC address. You can identify the Mac address of your machine by printing a network configuration report (see "Printing a network configuration report" on page 152).

- Check the wireless environment. You might not be able to connect to the network in the infrastructure environment where you need to type in a user's information before connecting to the access point (or wireless router).
- This machine only supports IEEE 802.11 b/g/n and Wi-Fi. Other wireless communication types (e.g., Bluetooth) are not supported.
- When using the ad hoc mode, in operating systems such as Windows Vista, you might need to set the wireless connection setting every time you use the wireless machine.
- You cannot use infrastructure mode and ad hoc mode at the same time for Samsung wireless network machines.
- The machine is within the range of the wireless network.
- The machine is located away from obstacles that could block the wireless signal.

Remove any large metal objects between the access point (or wireless router) and the machine.

Make sure the machine and wireless access point (or wireless router) are not separated by poles, walls, or support columns containing metal or concrete.

- The machine is located away from other electronic devices that may interfere with the wireless signal.

Many devices can interfere with the wireless signal, including a microwave oven and some Bluetooth devices.

- Whenever the configuration of your access point (or wireless router) changes, you must do the product's wireless network setup again.
- The maximum number of device that can be connected via **Wi-Fi Direct** is 3.
- If Wi-Fi Direct is ON, this machine only supports IEEE 802.11 b/g.
- If the access point is set to work with the 802.11n standard only, it may not connect to your machine.

Samsung MobilePrint

What is Samsung MobilePrint?

Samsung MobilePrint is a free application that enables users to print photos, documents, and web pages directly from your smartphone or tablet. **Samsung MobilePrint** is not only compatible with your Android, Windows and iOS smart phones but also with your iPod Touch and tablet PC. It connects your mobile device to a network connected Samsung printer or to a wireless printer through a Wi-Fi access point. Installing a new driver or configuring network settings isn't necessary – just simply install the **Samsung MobilePrint** application, and it will automatically detect compatible Samsung printers. Besides printing photos, web pages, and PDFs, scanning is also supported. If you have Samsung multifunction printer, scan any document into a JPG, PDF, or PNG format for quick and easy viewing on your mobile device.

Downloading Samsung MobilePrint

To download **Samsung MobilePrint**, go to the application store (Samsung Apps, Android Market, App Store, Marketplace) on your mobile device, and just search for "**Samsung MobilePrint**." You can also visit iTunes for Apple devices or Marketplace for Windows devices on your computer.



Supported Mobile OS

- Android OS 2.1 or higher
- iOS 4.0 or higher
- Windows Phone 7 or higher

Supported devices

- **iOS 4.0 or higher:** iPod Touch, iPhone, iPad
- **Android 2.1 or higher:** Galxy S, Galaxy S2, Galaxy Tab, and Android mobile devices
- **Windows Phone 7 or higher:** Samsung Focus, Omnia7, and OmniaW, and Windows mobile devices

AirPrint



CLX-330xW, CLX-330xFN, CLX-330xFW Series only.



AirPrint allows you to wirelessly print directly from iPhone, iPad and iPod touch running the latest version of iOS.

Setting up AirPrint

Bonjour(mDNS) and IPP protocols are required on your machine to use the **AirPrint** feature. You can enable the **AirPrint** feature by one of the following methods.

- 1 Check whether the machine is connected to the network.
- 2 Start a web browser such as Internet Explorer, Safari, or Firefox and enter your machine's new IP address in the browser window.

For example,



- 3 Click **Login** in the upper right of the SyncThru™ Web Service website.

- 4 If it's your first time logging into **SyncThru™ Web Service** you need to log-in as an administrator. Type in the below default **ID** and **Password**. We recommend you to change the default password for security reasons.

- **ID: admin**
- **Password: sec00000**

- 5 When the **Embedded Web Service** window opens, click **Settings > Network Settings**.

- 6 Click **Raw TCP/IP, LPR, IPP** or **mDNS**.
You can enable the IPP protocol or mDNS protocol.

Printing via AirPrint

For example, the iPad manual provides these instructions:

- 1 Open your email, photo, web page, or document you want to print.
- 2 Touch the action icon().
- 3 Select **your printer driver name** and option menu to set up.
- 4 Touch **Print** button. Print it out.

AirPrint



Cancelling print job: To cancel the printing job or view the print summary, click the print center icon () in multitasking area. You can click cancel in the print center.

Google Cloud Print

Google Cloud Print™ is a service that allows you to print to a printer using your smart phone, tablet, or any other web-connected devices. Just register your Google account with the printer, and you are ready to use the Google Cloud Print service. You can print your document or email with Chrome OS, Chrome browser, or a Gmail™/ Google Docs™ application on your mobile device, so you don't need to install the printer driver on the mobile device. Refer to the Google website (<http://support.google.com/cloudprint>) for more information about Google Cloud Print.

Registering your Google account to the printer



- Make sure the printer machine is turned on and connected to a wired or wireless network that has access to the Internet.
- You should create your Google account in the advance.

- 1 Open the Chrome browser.
- 2 Visit www.google.com.
- 3 Sign in to the Google website with your Gmail address.
- 4 Enter your printer's IP address in the address field and press the Enter key or click **Go**.

5 Click **Login** in the upper right corner of the SyncThru™ Web Service website.

6 If it's your first time logging into **SyncThru™ Web Service** you need to log-in as an administrator. Type in the below default **ID** and **Password**. We recommend you to change the default password for security reasons.

- **ID: admin**
- **Password: sec00000**



If the network environment is using a proxy server, you need to configure the proxy's IP and port number from **Settings > Network Settings > Google Cloud Print > Proxy Setting**. Contact your network service provider or network administrator for more information.

7 When the **SyncThru™ Web Service** window opens, click **Settings > Network Settings > Google Cloud Print**.

8 Enter your printer's name and description.

9 Click **Register**.
The confirmation pop-up window appears.



If you set the browser to block pop-ups, the confirmation window will not appear. Allow the site to show pop-ups.

Google Cloud Print

10 Click **Finish printer registration**.

11 Click **Manage your printers**.

Now your printer is registered with Google Cloud Print service.

Google Cloud Print-ready devices will appear in the list.

Printing with Google Cloud Print

The printing procedure varies depending on the application or the device you are using. You can see the application list that supports Google Cloud Print service.



Make sure the printer is turned on and connected to a wired or wireless network that has access to the Internet.

Printing from an application on mobile device

The following steps are an example of using the Google Docs app from Android mobile phone.

1 Install the Cloud Print application on your mobile device.



If you do not have the application, download it from the application store such as Android Market or App Store.

2 Access the Google Docs application from your mobile device.

3 Tap the option  button of the document that you want to print.

4 Tap the send  button.

5 Tap the Cloud Print  button.

6 Set the printing options if you want.

7 Tap **Click here to Print**.

Printing from the Chrome browser

The following steps are an example of using the Chrome browser.

1 Run Chrome.

2 Open the document or email that you want to print.

3 Click the wrench icon  in the browser's top right corner.

4 Click **Print**. A new tab for printing appears.

Google Cloud Print

- 5 Select **Print with Google Cloud Print**.
- 6 Click the **Print** button.



3. Useful Setting Menus

This chapter explains how to browse the current status of your machine, and the method of setting for advanced machine setup.

- **Before you begin reading a chapter** 194
- **Print** 195
- **Copy** 196
- **Fax** 199
- **Scan** 203
- **System setup** 205
- **Network setup** 211





Before you begin reading a chapter

This chapter explains all the features available for this series' models to help users easily understand the features.

You can check the features available for each model in the Basic Guide (see "Menu overview" on page 35).

The following are tips for using this chapter

- The control panel provides access to various menus to set up the machine or use the machine's functions. These menus can be accessed by pressing  (**Menu**).
- Some menus may not appear on the display depending on options or models. If so, it is not applicable to your machine.
- For models that do not have the  (**Menu**) on the control panel, this feature is not applicable (see "Control panel overview" on page 24).
- Some menu names may differ from your machine depending on its options or the models.

Print



Some menus may not appear in the display depending on options or models. If so, it is not applicable to your machine (see "Menu overview" on page 35).

To change the menu options:

- Press  (**Menu**) > **Print Setup** on the control panel.

Item	Description
Orientation	Selects the direction in which information is printed on a page.
Copies	You can enter the number of copies using the number keypad.
Resolution	Specifies the number of dots printed per inch (dpi). The higher the setting, the sharper printed characters and graphics.
Trapping	Reduces the white gap caused by misalignment of color channels in color printing mode. Also black text will be overprinted on other colors.
Document Type	Improves the printing quality by selecting the document type for the current printing job.

Item	Description
Screen	Affects the resolution and clarity of your color output. <ul style="list-style-type: none">• Enhanced: This mode will generate printouts with sharp texts and smooth graphic/photo objects in the page.• Detailed: This mode will generate printouts with sharp details over the entire page.• Normal: This mode will generate printouts with smooth tone over the entire page.
Clear Text	Selects this option to print texts clearer than on a normal document.
Auto CR	Allows you to append the required carriage return to each line feed, which is useful for Unix or DOS users.
Emulation	Sets the emulation type and option.

Copy

Copy feature



Some menus may not appear in the display depending on options or models. If so, it is not applicable to your machine (see "Menu overview" on page 35).

To change the menu options:

In copy mode, press (Menu) > **Copy Feature** on the control panel.



- **CLX-330x Series / CLX-330xW Series:** When the **Scan to** button's LED is off, the machine is in copy mode.
- **CLX-330xFN Series / CLX-330xFW Series:** Press (copy) on the control panel.

Item	Description
Original Size	Sets the image size.

Item	Description
Reduce/Enlarge	Reduces or enlarges the size of a copied image (see "Reduced or enlarged copy" on page 63). If the machine is set Eco mode, reduce and enlarge features are not available.
Darkness	Adjusts the brightness level to make a copy that is easier to read, when the original contains faint markings and dark images (see "Darkness" on page 61)
Original Type	Improves the copy quality by selecting the document type for the current copy job (see "Original" on page 62)
Layout	Adjusts the layout format such as poster, clone, ID copy, 2/4-up, booklet, etc.
Layout > 2-up or Layout > 4-up	Reduces the size of the original images and prints 2 or 4 pages onto one sheet of paper. This copy feature is available only when you load originals into the document feeder.

Copy

Item	Description
Layout > ID Copy	prints one side of the original on the upper half of the paper and the other side on the lower half without reducing the size of the original. This feature is helpful for copying a small-sized item such as business card.
Adjust Bkgd	<p>Prints an image without its background. This copy feature removes the background color and can be helpful when copying an original containing color in the background, such as a newspaper or a catalog.</p> <ul style="list-style-type: none">• Off: Does not use this feature.• Auto: Optimizes the background.• Enhance Lev.1~2: The higher the number is, the more vivid the background is.• Erase Lev.1~4: The higher the number is, the lighter the background is.

Copy Setup



Some menus may not appear in the display depending on options or models. If so, it is not applicable to your machine (see "Menu overview" on page 35).

To change the menu options:



In copy mode, press  (**Menu**) > **Copy Setup** on the control panel.



- **CLX-330x Series / CLX-330xW Series:** When the **Scan to** button's LED is off, the machine is in copy mode.
- **CLX-330xFN Series / CLX-330xFW Series:** Press  (copy) on the control panel.

Item	Description
Change Default	Resets the value or setting to the printer's out-of-box state.
Change Default > Copies	You can enter the number of copies using the number keypad.

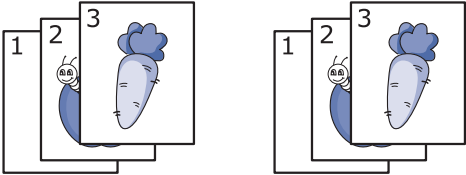
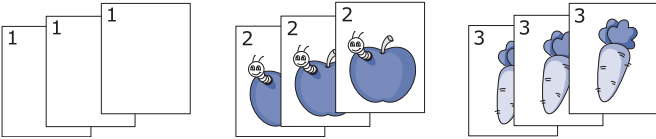
Copy

Item	Description
<p>Change Default > Copy Collation</p>	<p>Set the machine to sort the copy job. For example, if you make 2 copies of a 3 page original, one complete 3 page document will print followed by a second complete document.</p> <ul style="list-style-type: none"> • On: Prints output in sets to match the sequence of originals.  <ul style="list-style-type: none"> • Off: Prints output sorted into stacks of individual pages. 
<p>Change Default > Reduce/Enlarge</p>	<p>Reduces or enlarges the size of a copied image (see "Reduced or enlarged copy" on page 63).</p> <div data-bbox="383 1161 1081 1321" style="border: 1px solid gray; padding: 5px;">  <p>If the machine is set Eco mode, reduce and enlarge features are not available.</p> </div>

Item	Description
<p>Change Default > Darkness</p>	<p>Adjusts the brightness level to make a copy that is easier to read, when the original contains faint markings and dark images (see "Darkness" on page 61)</p>
<p>Change Default > Original Type</p>	<p>Improves the copy quality by selecting the document type for the current copy job (see "Original" on page 62)</p>
<p>Change Default > Adjust Bkgd</p>	<p>Prints an image without its background. This copy feature removes the background color and can be helpful when copying an original containing color in the background, such as a newspaper or a catalog.</p> <ul style="list-style-type: none"> • Off: Does not use this feature. • Auto: Optimizes the background. • Enhance Lev. 1~2: The higher the number is, the more vivid the background is. • Erase Lev. 1~4: The higher the number is, the lighter the background is.

Fax Feature



Some menus may not appear in the display depending on options or models. If so, it is not applicable to your machine (see "Menu overview" on page 35).

To change the menu options:

- Press (fax) > **(Menu)** > **Fax Feature** on the control panel.

Item	Description
Darkness	Adjusts the brightness level to scan an original that is easier to read, when the original contains faint markings and dark images (see "Darkness" on page 69).
Resolution	The default document settings procedure good results when using typical text-based originals. However, if you send originals that are of poor quality, or contain photographs, you can adjust the resolution to produce a higher quality fax (see "Resolution" on page 69).
Original Size	Sets the image size.

Item	Description
Multi Send	<p>Sends a fax to multiple destinations (see "Sending a fax to multiple destinations" on page 67).</p> <p> You cannot send a color fax using this feature.</p>
Delay Send	<p>Sets your machine to send a fax at a later time when you will not be present (see "Delaying a fax transmission" on page 242).</p> <p> You cannot send a color fax using this feature.</p>
Priority Send	<p>Scans the original into memory and immediately transmits it when the current operation is finished. Priority transmission will interrupt a sending to multiple destinations between stations (example, when the transmission to station A ends, before transmission to station B begins) or between redial attempts (see "Sending a priority fax" on page 243).</p>
Send Forward	<p>Forwards the sent fax to other destination by a fax. See "Forwarding a sent fax to another destination" on page 244.</p>

Fax

Item	Description
Rcv. Forward	Forwards the received fax to other destination by a fax or PC. If you are out of office but have to receive the fax, this feature may be useful. See "Forwarding a received fax" on page 244.
Secure Receive	Stores the received fax in memory without printing out. To print received documents, you need to enter the password. You can prevent your received faxes from being accessed by unauthorized people (see "Receiving in secure receiving mode" on page 247).
Add Page	Adds additional documents to a reserved delay fax job (see "Adding documents to a reserved fax" on page 243).
Cancel Job	Cancels the delayed fax job which is saved in memory (see "Canceling a reserved fax job" on page 243).

Sending setup



Some menus may not appear in the display depending on options or models. If so, it is not applicable to your machine (see "Menu overview" on page 35).

To change the menu options:

- Press  (fax) >  (**Menu**) > **Fax Setup** > **Sending** on the control panel.

Item	Description
Redial Times	Sets the number of redial attempts. If you enter 0, the machine will not redial.
Redial Term	Sets the time interval before automatic redialling.
Prefix Dial	Sets a prefix of up to five digits. This number dials before any automatic dial number is started. It is useful for accessing a PABX exchange.
ECM Mode	Sends faxes using error correction mode (ECM) to make sure the faxes are sent smoothly without any error. It may take more time.
Fax Confirm.	Sets the machine to print a report whether a fax transmission was successfully completed or not. If you select On-Error , the machine prints a report only when a transmission is not successful.
Image TCR	Prints a transmission report with a minimized image of the first page of the fax sent.
Dial Mode	Sets the dialing mode to either tone or pulse. This setting may not be available depending on your country.

Receiving setup



Some menus may not appear in the display depending on options or models. If so, it is not applicable to your machine (see "Menu overview" on page 35).

To change the menu options:

- Press (fax) > (Menu) > **Fax Setup** > **Receiving** on the control panel.

Item	Description
Receive Mode	Selects the default fax receiving mode.
Ring To Answer	Specifies the number of times the machine rings before answering an incoming call.
Stamp RCV Name	Automatically prints the page number, and the date and time of reception at the bottom of each page of a received fax.
Rcv Start Code	Initiates fax reception from an extension phone plugged into the EXT socket on the back of the machine. If you pick up the extension phone and hear fax tones, enter the code. It is preset to *9* at the factory.

Item	Description
Auto Reduction	Automatically reduces an incoming fax page to fit the size of the paper loaded in the machine.
Discard Size	Discards a specific length from the end of the received fax.
Junk Fax Setup	Blocks any unwanted faxes that you stored in the memory as junk fax numbers. This setting may not be available depending on your country.
DRPD Mode	Enables a user to use a single telephone line to answer several different telephone numbers. You can set the machine to recognize different ring patterns for each number. This setting may not be available depending on your country (see "Receiving faxes using DRPD mode" on page 247).



Another setup



Some menus may not appear in the display depending on options or models. If so, it is not applicable to your machine (see "Menu overview" on page 35).

Fax

To change the menu options:

- Press  (fax) >  (**Menu**) > **Fax Setup** on the control panel.

Item	Description
Change Default	Resets the value or setting to the printer's out-of-box state.
Auto Report	Sets the machine to print a report with detailed information about the previous 50 communication operations including time and dates.
Manual TX/RX	Setting this option to ON provides the ability to send or receive a fax while the line is busy. You can select to send or receive a fax by either picking up the extension phone receiver and pressing the Start button or by pressing the On Hook Dial button and pressing the Start button.

Scan

Scan feature



Some menus may not appear in the display depending on options or models. If so, it is not applicable to your machine (see "Menu overview" on page 35).

To change the menu options:

in scan mode, press  (**Menu**) > **Scan Feature** on the control panel.



- **CLX-330x Series / CLX-330xW Series:** When the **Scan to** button's LED is on, the machine is in scan mode.
- **CLX-330xFN Series / CLX-330xFW Series:** Press  (scan) on the control panel.

Item	Description
USB Feature	Sets scan destination to a USB. You scan the originals and save the scanned image to a USB device.
USB Feature > Original Size	Sets the image size.
USB Feature > Original Type	Sets the original document's type.

Item	Description
USB Feature > Resolution	Sets the image resolution.
USB Feature > Color Mode	Sets the color mode.
USB Feature > File Format	Sets the file format in which the image is to be saved. If you select BMP, JPEG, TIFF, or PDF, you can select to scan multiple pages.
USB Feature > Darkness	Adjusts the brightness level to scan.

Scan setup



Some menus may not appear in the display depending on options or models. If so, it is not applicable to your machine (see "Menu overview" on page 35).

To change the menu options:

In scan mode, press  (**Menu**) > **Scan Setup** on the control panel.

Scan



- **CLX-330x Series / CLX-330xW Series:** When the **Scan to** button's LED is on, the machine is in scan mode.
- **CLX-330xFN Series / CLX-330xFW Series:** Press  (scan) on the control panel.

Item	Description
Change Default	Resets the value or setting to the printer's out-of-box state.
Change Default > USB Default	Resets the USB scan setting to the printer's out-of-box state.

System setup

Machine setup



Some menus may not appear in the display depending on options or models. If so, it is not applicable to your machine (see "Menu overview" on page 35).

To change the menu options:

- Press (Menu) > **System Setup** > **Machine Setup** on the control panel.

Item	Description
Machine ID	Sets the machine ID which will be printed at the top of each fax page that you send.
Fax Number	Sets the fax number which will be printed at the top of each fax page that you send.
Date & Time	Sets the date and time.
Clock Mode	Selects the format for displaying time between 12 hr. and 24 hr.
Language	Sets the language of the text that appears on the control panel display.

Item	Description
Power Save	<p>Sets how long the machine waits before going to power save mode.</p> <p>When the machine does not receive data for an extended period of time, power consumption is automatically lowered.</p>
Auto Power Off	<p>Turns power off automatically when the machine has been in power save mode for the length of time set in Auto Power Off > On > Timeout.</p> <div data-bbox="1473 705 1534 767"></div> <ul style="list-style-type: none">• This option only appears in the CLX-330x Series/CLX-330xW Series.• To turn the machine on again, press the (Power/Wakeup) button on the control panel (make sure the main power switch is on).• If you run the printer driver or Samsung Easy Printer Manager, the time automatically extends.• While the machine is connected to the network or working on a print job, Auto Power Off feature doesn't work.

System setup

Item	Description
Wakeup Event	<p>You can set the condition to wake up from power-save mode.</p> <ul style="list-style-type: none">• On: The machine wake up from the power save mode on the following cases:<ul style="list-style-type: none">- Pressing any button- Opening or closing the paper tray- Inserting paper in the document feeder• Off: The machine wake up from the power save mode only when the Power/Wakeup button is pressed.
System Timeout	<p>Sets the time that the machine remembers previously used copy settings. After the timeout, the machine restores the default copy settings.</p>
Job Timeout	<p>Sets the length of time the printer waits before printing the last page of a print job that does not end with a command to print the page.</p>
Altitude Adj.	<p>Optimize print quality according to the machine's altitude.</p>
Humidity	<p>Optimizes print quality according to the humidity in the environment.</p>

Item	Description
Auto Continue	<p>Determine whether or not the machine continues printing when it detects the paper does not match the paper settings.</p> <ul style="list-style-type: none">• 30 Sec: If a paper mismatch occurs, an error message will display. The machine waits for about 30 second, then automatically clear the message and continue printing.• 0 Sec: Even though a paper mismatch occurs, the machine continues printing.• Off: If a paper mismatch occurs, the machine waits until you insert the correct paper.
Paper Substit.	<p>Automatically substitutes the printer driver's paper size to prevent the paper mismatch between Letter and A4. For example, if you have A4 paper in the tray but you set the paper size to Letter in the printer driver, the machine prints on A4 paper and vice versa.</p>
PrintBlankPage	<p>The printer detects the printing data from computer whether a page is empty or not. You can set to print or skip the blank page.</p>

System setup

Item	Description
Eco Settings	<p>Allows you to save print resources and enables eco-friendly printing.</p> <ul style="list-style-type: none">• Default Mode: Select whether to turn the Eco mode on or off. <p> On force (On-Forced): Sets the Eco mode on with password. If a user wants to turn the Eco mode on/off, the user needs to enter the password.</p> <ul style="list-style-type: none">• Select Template (Select Temp.): Selects the eco template set from the SyncThru™ Web Service.

Paper setup



Some menus may not appear in the display depending on options or models. If so, it is not applicable to your machine (see "Menu overview" on page 35).

To change the menu options:

- Press  (**Menu**) > **System Setup** > **Paper Setup** on the control panel.

Item	Description
Paper Size	Sets the paper size as A4, Letter, or other paper sizes, according to your requirements.
Paper Type	Chooses the type of the paper for each tray.
Margin	Sets the margins for the document.

Sound / Volume





Some menus may not appear in the display depending on options or models. If so, it is not applicable to your machine (see "Menu overview" on page 35).

To change the menu options:

- Press  (**Menu**) > **System Setup** > **Sound/Volume** on the control panel.

Item	Description
Key Sound	Turns the key sound on or off. With this option set to on, a tone sounds each time a key is pressed.

System setup

Item	Description
Alarm Sound	Turns the alarm sound on or off. With this option set to on, an alarm tone sounds when an error occurs or fax communication ends.
Speaker	<p>Turns on or off the sounds from the telephone line through the speaker, such as a dial tone or a fax tone. With this option set to Comm. which means the speaker is on until the remote machine answers.</p> <div> You can adjust the volume level using On Hook Dial. You can adjust the speaker volume only when the telephone line is connected.</div> <ol style="list-style-type: none">Press  (fax) on the control panel.Press On Hook Dial. A dial tone sounds from the speaker.Press the arrows until you hear the volume you want.Press On Hook Dial to save the change and return to ready mode.
Ringer	Adjusts the ringer volume. For the ringer volume, you can select off, low, middle, and high level.

Report



Some menus may not appear in the display depending on options or models. If so, it is not applicable to your machine (see "Menu overview" on page 35).

To change the menu options:

- Press  (**Menu**) > **System Setup** > **Report** on the control panel.

Item	Description
Configuration	Prints a report on the machine's overall configuration.
Supplies Info.	Prints supplies' information page.
Demo Page	Prints the demo page to check whether your machine is printing properly or not.
Address Book	Prints all of the fax number currently stored in the machine's memory.

System setup

Item	Description
Fax Confirm.	Prints a transmission report including the fax number, the number of pages, the elapsed time of the job, the communication mode, and the communication results for fax job. You can set up your machine to automatically print a transmission confirmation report after each fax job.
Fax Sent	Prints information on the faxes you have recently sent.
Fax Received	Prints information on the faxes you have recently received.
Schedule Jobs	Prints the document list currently stored for delayed faxes along with the starting time and type of each operation.
JunkFax	Prints the fax numbers specified as junk fax numbers.
Network Conf.	Prints information on your machine's network connection and configuration.
Usage Counter	Prints a usage page. The usage page contains the total number of pages printed.
Fax Options	Prints the information of a fax reports.

Maintenance



Some menus may not appear in the display depending on options or models. If so, it is not applicable to your machine (see "Menu overview" on page 35).

To change the menu options:

- Press (Menu) > **System Setup** > **Maintenance** on the control panel.

Item	Description
CLR Empty Msg.	When toner cartridge is empty, this option appears. You can clear the empty message.
Supplies Life	Shows the supply life indicators (see "Monitoring the supplies life" on page 89.)

System setup

Item	Description
Image Mgr.	<p>Allows you to adjust the color setting such as contrast level, color registration, color density, etc.</p> <ul style="list-style-type: none">• Custom Color: adjusts contrast, color by color.<ul style="list-style-type: none">- Default: optimizes colors automatically.- Print Density: allows you to manually adjust the color contrast for each cartridge. It is recommended to use the Default setting for best color quality.• Tone Adjust.: The machine calibrates the toner density of machine for the best possible color print quality.
Serial Number	<p>Shows the machine's serial number. When you call for service or register as a user on the Samsung website, you can find this.</p>
TonerLow Alert	<p>Customizes the level to alert toner low or toner empty (see "Setting the toner low alert" on page 90).</p>

Network setup





Some menus may not appear in the display depending on options or models. If so, it is not applicable to your machine (see "Menu overview" on page 35).

- Press (**Menu**) > **Network** on the control panel.

Option	Description
TCP/IP (IPv4)	<p>Selects the appropriate protocol and configure parameters to use the network environment.</p> <div style="border: 1px solid gray; padding: 5px; margin-top: 10px;"> There are lots of parameters to be set. If you are not sure, leave as is, or consult the network administrator. </div>
TCP/IP (IPv6)	Selects this option to use the network environment through IPv6 (see "IPv6 configuration" on page 161).
Ethernet Speed	Configure the network transmission speed.
Wireless	Selects this option to use the wireless network.
Clear Setting	Reverts the network settings to the default values. (Reboot required.)
Network Conf.	This list shows information on your machine's network connection and configuration.

Option	Description
Protocol Mgr.	<p>You can activate or deactivate the following protocols.</p> <ul style="list-style-type: none"> Net. Activate: You can set whether to use Ethernet on or off.
	<div style="border: 1px solid gray; padding: 5px; margin-top: 10px;"> Turn the power off and on after you change this option. </div> <ul style="list-style-type: none"> Http Activate: You can sets whether to use SyncThru™ Web Service or not.
	<div style="border: 1px solid gray; padding: 5px; margin-top: 10px;"> Turn the power off and on after you change this option. </div> <ul style="list-style-type: none"> WINS: You can configure the WINS server. WINS(Windows Internet Name Service) is used in the Windows operating system.
	<div style="border: 1px solid gray; padding: 5px; margin-top: 10px;"> Turn the power off and on after you change this option. </div>

Network setup

Option	Description
Protocol Mgr. (continued.)	<ul style="list-style-type: none">• SNMP V1/V2: You have to enable this option to use SNMP V1/V2 protocol. Administrator's can use SNMP to monitor and manage machines on the network.• UPnP(SSDP): You have to enable this option to use UPnP(SSDP) protocol. <div data-bbox="353 523 1081 675"> Turn the power off and on after you change this option.</div> <ul style="list-style-type: none">• MDNS: You have to enable this option to use MDNS (Multicast Domain Name System) protocol.• SetIP: You have to enable this option to use SetIP protocol.• SLP: You can configure SLP (Service Location Protocol) settings. This protocol allows host applications to find services in a local area network without prior configuration. <div data-bbox="353 1082 1081 1233"> Turn the power off and on after you change this option.</div>



4. Special Features

This chapter explains special copying, scanning, faxing, and printing features.

- **Altitude adjustment** 214
- **Entering various characters** 215
- **Setting up the fax address book** 216
- **Printing features** 219
- **Scan features** 231
- **Fax features** 240



- The procedures in this chapter are mainly based on Windows 7.
- It may be necessary to press **OK** to navigate to lower-level menus for some models.

Altitude adjustment

Print quality is affected by atmospheric pressure, which is determined by the height of the machine above sea level. The following information will guide you on how to set your machine for the best print quality.

Before you set the altitude value, determine the altitude where you are.

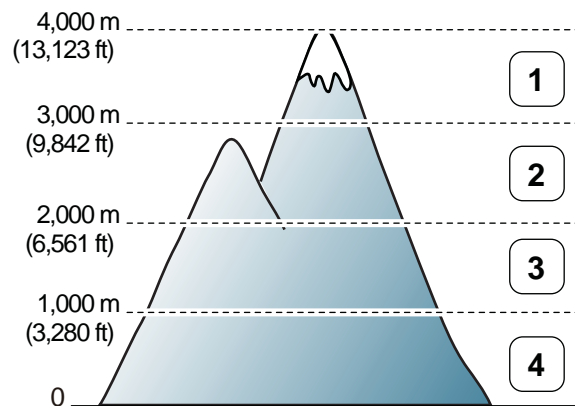

- 1 High 3
- 2 High 2
- 3 High 1
- 4 Normal

You can set the altitude value from **Device Settings** in Samsung Easy Printer Manager program.

- For Windows and Mac users, you set from **Samsung Easy Printer Manager** >  **(Switch to advanced mode)** > **Device Settings**. See "Device Settings" on page 259.



- If your machine is connected to the network, you can set the altitude via SyncThru™ Web Service (see "Using SyncThru™ Web Service" on page 254).
- You can also set the altitude in **System Setup** option on the machine's display (see "Machine's basic settings" on page 41).

Entering various characters

As you perform various tasks, you may need to enter names and numbers. For example, when you set up your machine, you enter your name or your company's name, and the fax number. When you store fax numbers or email addresses in memory, you may also enter the corresponding names.

Entering alphanumeric characters

Press the button until the correct letter appears on the display. For example, to enter the letter O, press 6, labeled with MNO. Each time you press 6, the display shows a different letter, M, N, O, m, n, o and finally 6. To find the letter that you want to enter, see "Keypad letters and numbers" on page 215.



- You can enter a space by pressing 1 twice.
- To delete the last digit or character, press the left/right or up/down arrow button.

Keypad letters and numbers





- Special character sets may differ from your machine depending on its options or the models.
- Some of the follow key values may not appear depending on the job you are doing.



Key	Assigned numbers, letters, or characters
1	@ / . ' 1
2	A B C a b c 2
3	D E F d e f 3
4	G H I g h i 4
5	J K L j k l 5
6	M N O m n o 6
7	P Q R S p q r s 7
8	T U V t u v 8
9	W X Y Z w x y z 9
0	& + - , 0
*	* % ^ _ ~ ! # \$ () [] (These symbols are available when you type for network authentication.)
#	# = ? " : { } < > ; (These symbols are available when you type for network authentication.)

Setting up the fax address book

You can set up speed number with the fax numbers you use frequently via SyncThru™ Web Service and then easily and quickly enter fax numbers by entering the location numbers assigned to them in address book.

Registering a speed dial number



- 1 Select  (fax) >  (**Address Book**) > **New&Edit** > **Speed Dial** on the control panel.
- 2 Enter a speed dial number and press **OK**.

 If an entry is already stored in the number you choose, the display shows the message to allow you to change it. To start over with another speed dial number, press  (**Back**).



- 3 Enter the name you want and press **OK**.
- 4 Enter the fax number you want and press **OK**.
- 5 Press the  (**Cancel** or **Stop/Clear**) button to return to ready mode.

Using speed dial numbers

When you are prompted to enter a destination number while sending a fax, enter the speed dial number at which you stored the number you want.

-  For a one-digit (0-9) speed dial number, press and hold the corresponding digit button on the number keypad for more than 2 seconds.
- For a two- or three-digit speed dial number, press the first digit button(s) and then hold down the last digit button for more than 2 seconds.
- You can print the address book list by selecting  (fax) >  (**Address Book**) > **Print**.



Editing speed dial numbers

- 1 Select  (fax) >  (**Address Book**) > **New&Edit** > **Speed Dial** on the control panel.
- 2 Enter the speed dial number you want to edit and press **OK**.
- 3 Change the name and press **OK**.
- 4 Change the fax number and press **OK**.

Setting up the fax address book

- 5 Press  (**Cancel** or **Stop/Clear**) to return to ready mode.

Registering a group dial number



- 1 Select  (fax) >  (**Address Book**) > **New&Edit** > **Group Dial** on the control panel.
- 2 Enter a group dial number and press **OK**.



If an entry is already stored in the number you choose, the display shows the message to allow you to change it. To start over with another speed dial number, press  (**Back**).

- 3 Search by entering the first few letters of the speed dial's name to put in the group.
- 4 Select the name and number you want and press **OK**.
- 5 Select **Yes** when **Add?** appears.
- 6 Repeat step 3 to include other speed dial numbers into the group.
- 7 When you have finished, select **No** when **Another No.?** appears and press **OK**.
- 8 Press  (**Cancel** or **Stop/Clear**) to return to ready mode.



Editing group dial numbers

- 1 Select  (fax) >  (**Address Book**) > **New&Edit** > **Group Dial** on the control panel.
- 2 Enter the group dial number you want to edit and press **OK**.
- 3 Enter a new speed dial number to add and press **OK**, then **Add?** appears. Enter a speed dial number stored in the group and press **OK**, **Delete?** appears.
- 4 Press **OK** to add or delete the number.
- 5 Repeat step 3 to add or delete more numbers.
- 6 Select **No** at the **Another No.?** and press **OK**.
- 7 Press  (**Cancel** or **Stop/Clear**) to return to ready mode.

Searching address book for an entry

There are two ways to search for a number in memory. You can either scan from A to Z sequentially, or you can search by entering the first letters of the name associated with the number.



Setting up the fax address book

- 1 Select **ct**  (fax) >  (**Address Book**) > **Search&Dial** > **Speed Dial** or **Group Dial** on the control panel.
- 2 Enter **All** or **ID** and press **OK**.
- 3 Press the name and number or the keypad button labeled with the letter you want to search.

For example, if you want to find the name "MOBILE," press the **6** button, which is labeled with "MNO."
- 4 Press  (**Cancel** or **Stop/Clear**) to return to ready mode.

Printing address book

You can check your  (**Address Book**) settings by printing a list.

- 1 Select **ct**  (fax) >  (**Address Book**) > **Print** on the control panel.
- 2 Press **OK**.
The machine begins printing.

Printing features



- For basic printing features, refer to the Basic Guide (see "Basic printing" on page 55).
- This feature may not be available depending on model or optional goods (see "Features by models" on page 7).

Changing the default print settings

- 1 Click the Windows **Start** menu.
- 2 Select **Control Panel > Devices and Printers**.
- 3 Right-click on your machine.
- 4 Select **Printing preferences**.



If **Printing preferences** has a ►, you can select other printer drivers connected to the selected printer.

- 5 Change the settings on each tab.
- 6 Click **OK**.



If you want to change the settings for each print job, change it in **Printing Preferences**.

Setting your machine as a default machine

- 1 Click the Windows **Start** menu.
- 2 Select **Control Panel > Devices and Printers**.
- 3 Select your machine.
- 4 Right-click your machine and select **Set as Default Printer**.



If **Printing preferences** has a ►, you can select other printer drivers connected to the selected printer.

Printing features

Using advanced print features



XPS printer driver: used to print XPS file format.

- See "Features by models" on page 7.
- The XPS printer driver can be installed only on Windows Vista OS or higher.
- For models that provide XPS driver on the software CD:
 - You can install the XPS printer driver when you insert the software CD into your CD-ROM drive. When the installation window appears, select **Custom Installation**. You can select the XPS printer driver in the **Select Software** window.
- For models that provide XPS driver from the Samsung website, www.samsung.com > find your product > Support or downloads.

Printing to a file (PRN)

You will sometimes need to save the print data as a file.

- 1 Check the **Print to file** box in the **Print** window.

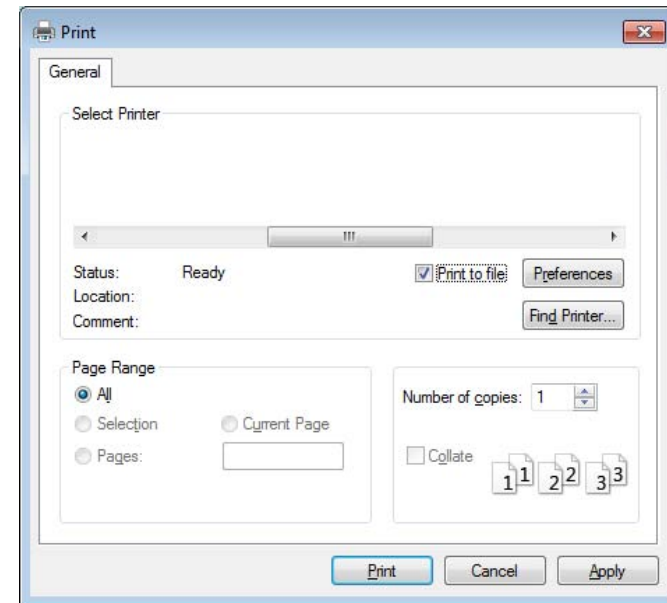

- 2 Click **Print**.
- 3 Type in the destination path and the file name, and then click **OK**.
For example, **c:\Temp\file name**.



If you type in only the file name, the file is automatically saved in **My Documents**, **Documents and Settings**, or **Users**. The saved folder may differ, depending on your operating system or the application you are using.

Printing features

Understanding special printer features

You can use advanced printing features when using your machine.





To take advantage of the printer features provided by your printer driver, click **Properties** or **Preferences** in the application's **Print** window to change the print settings. The machine name, that appears in the printer properties window may differ depending on the machine in use.

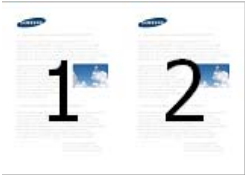

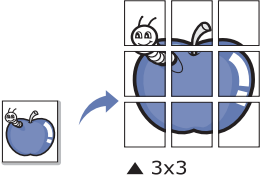
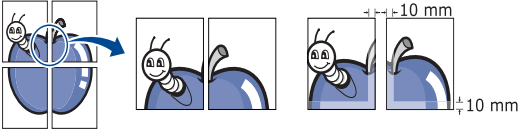
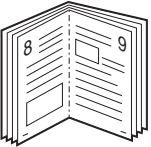

- Some menus may not appear on the display depending on options or models. If so, it is not applicable to your machine.
- Select the **Help** menu or click the  button from the window or press **F1** on your keyboard and click on any option you want to know about (see "Using help" on page 58).

Item	Description
<p data-bbox="51 815 315 887">Multiple Pages per Side</p> 	<p data-bbox="383 815 2175 887">Selects the number of pages to print on a single sheet of paper. To print more than one page per sheet, the pages will be reduced in size and arranged in the order you specify. You can print up to 16 pages on one sheet.</p>

Printing features

Item	Description
<p data-bbox="53 316 259 344">Poster Printing</p> 	<p data-bbox="383 272 2128 344">Prints a single-page document onto 4 (Poster 2x2), 9 (Poster 3x3), or 16 (Poster 4x4) sheets of paper, for the purpose of pasting the sheets together to form one poster-size document.</p> <p data-bbox="383 368 2186 440">Select the Poster Overlap value. Specify Poster Overlap in millimeters or inches by selecting the radio button on the upper right of Basic tab to make it easier to paste the sheets together.</p> 
<p data-bbox="53 746 277 775">Booklet Printing</p> 	<p data-bbox="383 643 2190 715">Prints your document on both sides of a sheet of paper and arranges the pages so that the paper can be folded in half after printing to produce a booklet.</p> <div data-bbox="383 775 2197 1062" style="background-color: #f0f0f0; padding: 10px;"><ul data-bbox="477 802 2190 1018" style="list-style-type: none"><li data-bbox="477 802 2067 831">• This option is available only when you use the PCL/SPL printer driver. This option is not available when you use XPS driver.<li data-bbox="477 855 2190 922">• The Booklet Printing option is not available for all paper sizes. Select the available paper Size option under the Paper tab to see what paper sizes are available.<li data-bbox="477 946 2190 1018">• If you select an unavailable paper size, this option can be automatically canceled. Select only available paper (paper without  or  mark).</div>

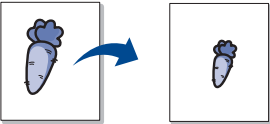

Printing features

Item	Description
Double-sided Printing (Manual)	<p>Print on both sides of a sheet of paper (duplex). Before printing, decide how you want your document oriented.</p> <div data-bbox="383 355 2197 603" style="background-color: #f0f0f0; padding: 10px;"><ul style="list-style-type: none"> This option is available only when you use the PCL/SPL printer driver. This option is not available when you use XPS driver.If your machine does not have a duplex unit, you should complete the printing job manually. The machine prints every other page of the document first. After that, a message appears on your computer.Skip Blank Pages feature does not work when you select the duplex option.</div> <ul style="list-style-type: none">None: Disables this feature.Long Edge: This option is the conventional layout used in bookbinding. Short Edge: This option is the conventional layout used in calendars. Reverse Double-Sided Printing: Check this option to reverse the print order when duplex printing. This option is not available when you use Double-sided Printing (Manual).
Paper Options 	Changes the size of a document to appear larger or smaller on the printed page by entering in a percentage by which to enlarge or decrease the document.

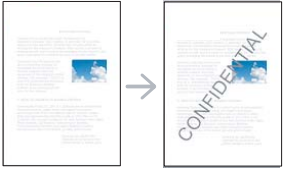
Printing features

Item	Description
Watermark 	The watermark option allows you to print text over an existing document. For example, you use it when you want to have large gray letters reading "DRAFT" or "CONFIDENTIAL" printed diagonally across the first page or all pages of a document.
Watermark (Creating a watermark)	<ul style="list-style-type: none">a To change the print settings from your software application, access Printing Preferences.b Click the Advanced tab, select Edit from the Watermark drop-down list. The Edit Watermarks window appears.c Enter a text message in the Watermark Message box. You can enter up to 256 characters. The message displays in the preview window.
Watermark (Editing a watermark)	<ul style="list-style-type: none">a To change the print settings from your software application, access Printing Preferences.b Click the Advanced tab, select Edit from the Watermark drop-down list. The Edit Watermarks window appears.c Select the watermark you want to edit from the Current Watermarks list and change the watermark message and options.d Click Update to save the changes.e Click OK or Print until you exit the Print window.
Watermark (Deleting a watermark)	<ul style="list-style-type: none">a To change the print settings from your software application, access Printing Preferences.b Click the Advanced tab, select Edit from the Watermark drop-down list. The Edit Watermarks window appears.c Select the watermark you want to delete from the Current Watermarks list and click Delete.d Click OK or Print until you exit the Print window.

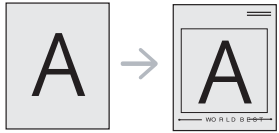
Printing features

Item	Description
<p data-bbox="53 389 163 421">Overlay</p> 	<p data-bbox="380 272 1928 304">This option is available only when you use the PCL/SPL printer driver. This option is not available when you use XPS driver</p> <p data-bbox="380 328 2159 485">An overlay is text and/or images stored in the computer hard disk drive (HDD) as a special file format that can be printed on any document. Overlays are often used to take the place of letterhead paper. Rather than using preprinted letterhead, you can create an overlay containing exactly the same information that is currently on your letterhead. To print a letter with your company's letterhead, you do not need to load preprinted letterhead paper in the machine: just print the letterhead overlay on your document.</p> <p data-bbox="380 509 1532 541">To use a page overlay, you must create a new page overlay containing your logo or image.</p> <div data-bbox="380 592 2197 751" style="background-color: #f0f0f0; padding: 10px;"><ul data-bbox="477 624 2197 703" style="list-style-type: none">• The overlay document size must be the same as the document you print with the overlay. Do not create an overlay with a watermark.• The resolution of the overlay document must be the same as that of the document you will print with the overlay.</div>
<p data-bbox="53 871 344 995">Overlay (Creating a new page overlay)</p>	<ol data-bbox="380 788 2047 1078" style="list-style-type: none">a To save the document as an overlay, access Printing Preferences.b Click the Advanced tab, and select Edit from the Text drop-down list. Edit Overlay window appears.c In the Edit Overlay window, click Create.d In the Save As window, type a name in the File name box. Select the destination path, if necessary (The default is C:\Formover).e Click Save. The name appears on the Overlay List.f Click OK or Print until you exit the Print window. The file is not printed. Instead, it is stored on your computer hard disk drive.

Printing features

Item	Description
Overlay (Using a page overlay)	<ul style="list-style-type: none">a Click the Advanced tab.b Select the desired overlay from the Text drop-down list.c If the overlay file you want does not appear in the Text drop-down list, select Edit... from the list and click Load. Select the overlay file you want to use. If you have stored the overlay file you want to use in an external source, you can also load the file when you access the Open window. After you select the file, click Open. The file appears in the Overlay List box and is available for printing. Select the overlay from the Overlay List box.d If necessary, check Confirm Page Overlay When Printing box. If this box is checked, a message window appears each time you submit a document for printing, asking you to confirm printing an overlay on your document. If this box is not checked and an overlay has been selected, the overlay automatically prints with your document.e Click OK or Print until you exit the Print window.
Overlay (Deleting a page overlay)	<ul style="list-style-type: none">a In the Printing Preferences window, click the Advanced tab.b Select Edit in the Text drop down list.c Select the overlay you want to delete from the Overlay List box.d Click Delete.e When a confirming message window appears, click Yes.f Click OK or Print until you exit the Print window. You can delete page overlays that you no longer use.

Mac printing



Some features may not be available depending on models or options. It means that the features are not supported.

Printing features

Printing a document

When you print with a Mac, you need to check the printer driver settings in each application you use. Follow the steps below to print from a Mac:

- 1 Open the document to print.
- 2 Open the **File** menu and click **Page Setup** (**Document Setup** in some applications).
- 3 Choose your paper size, orientation, scaling, other options, and make sure that your machine is selected. Click **OK**.
- 4 Open the **File** menu and click **Print**.
- 5 Choose the number of copies and indicate which pages to print.
- 6 Click **Print**.

Changing printer settings

You can use advanced printing features when using your machine.

Open an application and select **Print** from the **File** menu. The machine name, which appears in the printer properties window, may differ depending on the machine in use. Except for the name, the composition of the printer properties window is similar to the following.

Printing multiple pages on one sheet

You can print more than one page on a single sheet of paper. This feature provides a cost-effective way to print draft copies.

- 1 Open an application, and select **Print** from the **File** menu.
- 2 Select **Layout** from the drop-down list under **Orientation**. In the **Pages per Sheet** drop-down list, select the number of pages you want to print on one sheet of paper.
- 3 Select the other options to use.
- 4 Click **Print**.
The machine prints the selected number of pages to print on one sheet of paper.

Printing on both sides of the paper



Some features may not be available depending on models or options. It means that the features are not supported (see "Variety feature" on page 10).

Printing features

Before printing in the duplex mode, decide on which edge you will be binding your finished document. The binding options are, as follows:

- **Long-Edge Binding:** This option is the conventional layout used in book binding.
- **Short-Edge Binding:** This option is the type often used with calendars.

- 1 From your Mac application, select **Print** from the **File** menu.
- 2 Select **Layout** from the drop-down list under **Orientation**.
- 3 Select a binding orientation from the **Two-Sided** option.
- 4 Select the other options to use.
- 5 Click **Print** and the machine prints on both sides of the paper.



If you print more than 2 copies, the first copy and the second copy might print on the same sheet of paper. Avoid printing on both sides of paper when you are printing more than 1 copy.

Using help

Click the question mark on the bottom-left corner of the window and click on the topic you want to know about. A pop-up window appears with information about that option's feature, which is provided from the driver.

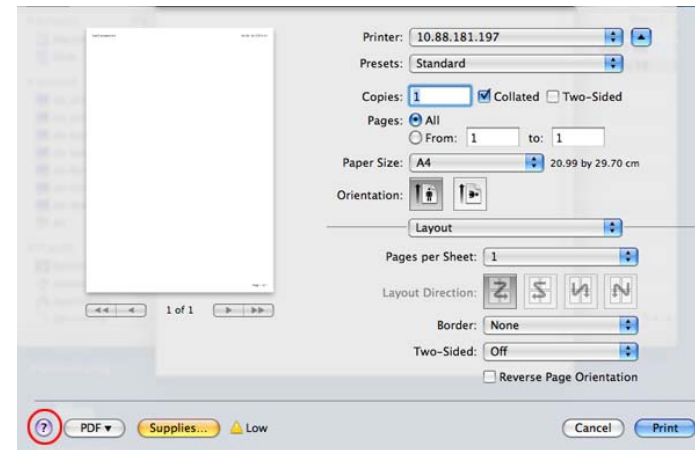

Linux printing



Some features may not be available depending on models or options. It means that the features are not supported.

Printing features

Printing from applications

There are a lot of Linux applications that allow you to print using Common UNIX Printing System (CUPS). You can print on your machine from any such application.

- 1 Open an application, and select **Print** from the **File** menu
- 2 Select **Print** directly using `lpr`.
- 3 In the LPR GUI window, select the model name of your machine from the printer list and click **Properties**.
- 4 Change the print job properties using the following four tabs displayed at the top of the window.
 - **General:** Changes the paper size, the paper type, and the orientation of the documents. It enables the duplex feature, adds start and end banners, and changes the number of pages per sheet.



Automatic/manual duplex printing may not be available depending on models. You can alternatively use the `lpr` printing system or other applications for odd-even printing.

- **Text:** Specifies the page margins and set the text options, such as spacing or columns.
- **Graphics:** Sets image options that are used when printing image files, such as color options, image size, or image position.

- **Advanced:** Sets the print resolution, paper source, and destination.

- 5 Click **Apply** to apply the changes and close the **Properties** window.
- 6 Click **OK** in the **LPR GUI** window to start printing.
- 7 The Printing window appears, allowing you to monitor the status of your print job.
To abort the current job, click **Cancel**.

Printing files

You can print many different types of files on your machine using the standard CUPS, directly from the command line interface. The CUPS `lpr` utility allows you to do that, but the driver's package replaces the standard `lpr` tool by a much more user-friendly LPR GUI program.

To print any document file:

- 1 Enter `lpr <file_name>` from the Linux shell command line and press **Enter**. The **LPR GUI** window appears.
When you type only `lpr` and press **Enter**, the **Select file(s) to print** window appears first. Just select any files you want to print and click **Open**.
- 2 In the **LPR GUI** window, select your machine from the list, and change the print job properties.
- 3 Click **OK** to start printing.

Printing features

Configuring Printer Properties

Using the **Printer Properties** window provided by the **Printers configuration**, you can change the various properties for your machine as a printer.

1 Open the **Unified Driver Configurator**.

If necessary, switch to **Printers configuration**.

2 Select your machine on the available printers list and click **Properties**.

3 The **Printer Properties** window appears.

The following five tabs display at the top of the window:

- **General:** Allows you to change the printer location and name. The name entered in this tab displays on the printer list in **Printers configuration**.
- **Connection:** Allows you to view or select another port. If you change the machine port from USB to parallel or vice versa while in use, you must re-configure the machine port in this tab.
- **Driver:** Allows you to view or select another machine driver. By clicking **Options**, you can set the default device options.
- **Jobs:** Shows the list of print jobs. Click **Cancel job** to cancel the selected job and select the **Show completed jobs** check box to see previous jobs on the job list.
- **Classes:** Shows the class that your machine is in. Click **Add to Class** to add your machine to a specific class or click **Remove from Class** to remove the machine from the selected class.

4 Click **OK** to apply the changes and close the **Printer Properties** window.

Scan features



- For basic scanning features, refer to the Basic Guide (see "Basic scanning" on page 65).
- This feature may not be available depending on model or optional goods (see "Features by models" on page 7).
- The maximum resolution that can be achieved depends upon various factors, including computer speed, available disk space, memory, the size of the image being scanned, and bit depth settings. Thus, depending on your system and what you are scanning, you may not be able to scan at certain resolutions, especially using enhanced dpi.

Basic scanning method



- This feature may not be available depending on model or optional goods (see "Variety feature" on page 10).

You can scan the originals with your machine via an USB cable or the network. The following methodologies can be used for scanning your documents:

- **Scan to PC:** Scan the originals from the control panel. Then, the scanned data will be stored in the connected computers **My Documents** folder (see "Basic Scanning" on page 65).
- **TWAIN:** TWAIN is the one of a preset imaging applications. Scanning an image launches the selected application, enabling you to control the scanning process. This feature can be used via the local connection or the network connection (see "Scanning from image editing program" on page 234).
- **Samsung Scan Assistant/Samsung Easy Document Creator:** You can use this program to scan images or documents.
 - See "Scanning with Samsung Scan Assistant" on page 235.
 - See "Using Samsung Easy Document Creator" on page 260.
- **WIA:** WIA stands for Windows Images Acquisition. To use this feature, your computer must be connected directly with the machine via an USB cable (see "Scanning using the WIA driver" on page 234).
- **USB Memory:** You can scan a document and save the scanned image onto an USB memory device.

Scan features

Setting the scan settings in the computer



This feature may not be available depending on model or optional goods (see "Features by models" on page 7).

- 1 Open **Samsung Easy Printer Manager** (see "Using Samsung Easy Printer Manager" on page 257).
- 2 Select the appropriate machine from the **Printer List**.
- 3 Select **Scan to PC Settings** menu.
- 4 Select the option you want.
 - **Scan Activation:** Determines whether or not scanning is enabled on the device.
 - **Basic** tab: Contains settings related to general scan and device settings.
 - **Image** tab: Contains settings related to image altering.
- 5 Press **Save** > **OK**.

Scanning from network connected machine



The machine that does not support the network interface, it will not be able to use this feature (see "Rear view" on page 23).

Make sure the printer driver is installed on your computer using the software CD, since the printer driver includes the scan program (see "Installing the driver locally" on page 31).

- 1 Place a single document face down on the document glass, or load the documents face up into the document feeder (see "Loading originals" on page 51).
- 2 Select  (**Scan**) > **Scan to PC** > **Network PC** on the control panel.



If you see **Not Available** message, check the port connection, or select **Enable Scan from Device Panel** in **Samsung Easy Printer Manager** >





Switch to advanced mode > **Scan to PC Settings**.

- 3 Select your registered computer **ID**, and enter the **Password** if necessary.

Scan features



- **ID** is the same ID as the registered scan ID for **Samsung Easy Printer Manager** >  Switch to advanced mode > **Scan to PC Settings**.
- **Password** is the 4 digit number registered password for **Samsung Easy Printer Manager** >  Switch to advanced mode > **Scan to PC Settings**.

4 Select the option you want and press **OK**.

5 Scanning begins.



Scanned image is saved in computer's **C:\Users\users name\My Documents**. The saved folder may differ, depending on your operating system or the application you are using.

Scanning to WSD

Scans the originals and saves the scanned data on a connected computer if the computer supports the WSD (Web Service for Device) feature. To use the WSD feature, you need to install the WSD printer driver on your computer. For Windows 7, you can install the WSD driver by **Control Panel > Devices and Printers > Add a printer**. Click **Add a network printer** from the wizard.



- The machine that does not support the network interface, it will not be able to use this feature (see "Features by models" on page 7).
- The WSD feature works only with Windows Vista® or later version that are the WSD-compliant computer.
- The following installation steps are based on Windows 7 computer.

Installing a WSD Printer Driver

- 1** Select **Start > Control Panel > Devices and Printers > Add a printer**.
- 2** Click **Add a network, wireless or Bluetooth printer** from the wizard.
- 3** In the printers list, select the one you want to use, and then click **Next**.





- The IP address for WSD printer is `http://IP address/ws/` (example: `http://111.111.111.111/ws/`).
- If no WSD printer is displayed in the list, click **The printer that I want isn't listed > Add a printer using a TCP/IP address or hostname** and select **Web Services Device** from **Device type**. Then enter the printer's IP address.

- 4** Follow the instructions in the installation window.

Scan features

Scanning using the WSD feature

- 1 Make sure that the machine is connected to your computer and powered on.
- 2 Place a single document face down on the document glass, or load the documents face up into the document feeder (see "Loading originals" on page 51).
- 3 Select  (**Scan**) > **Scan to WSD** on the control panel.

 If you see **Not Available** message, check the port connection. Or check the printer driver for WSD is correctly installed.

- 4 Select your computer name from **WSD PC List**.
- 5 Select the option you want and press **OK**.
- 6 Scanning begins.

Scanning from image editing program

You can scan and import documents at the image editing software such as Adobe Photoshop, if the software is TWAIN-compliant. Follow the steps below to scan with TWAIN-compliant software:

- 1 Make sure that the machine is connected to your computer and powered on.
- 2 Place a single document face down on the document glass, or load the documents face up into the document feeder (see "Loading originals" on page 51).
- 3 Open an application, such as Adobe Photoshop.
- 4 Click **File** > **Import**, and select the scanner device.
- 5 Set the scan options.
- 6 Scan and save your scanned image.

Scanning using the WIA driver

Your machine supports the Windows Image Acquisition (WIA) driver for scanning images. WIA is one of the standard components provided by Microsoft Windows 7 and works with digital cameras and scanners. Unlike the TWAIN driver, the WIA driver allows you to scan and easily adjust images without using additional software:

 The WIA driver works only on Windows OS (not supported Windows 2000) with a USB port.

Scan features

- 1 Make sure that the machine is connected to your computer and powered on.
- 2 Place a single document face down on the document glass, or load the documents face up into the document feeder (see "Loading originals" on page 51).
- 3 Click **Start > Control Panel > Hardware and Sound > Devices and Printers**.
- 4 Right-click on device driver icon in **Printers and Faxes > Start Scan**.
- 5 **New Scan** application appears.
- 6 Choose your scanning preferences and click **Preview** to see your preferences affect the picture.
- 7 Scan and save your scanned image.

Scanning with Samsung Scan Assistant

You need to download Samsung Scan Assistant software from the Samsung website to install the printer software (<http://www.samsung.com> > find your product > Support or Downloads).



- For Windows, you need to download Samsung Scan Assistant from the Samsung website to install the printer software (<http://www.samsung.com> > find your product > Support or Downloads).
- For Mac, open the **Application** folder > **Samsung** > Samsung Scan Assistant.
- For Windows, you can use the OCR (Optical Character Reader) feature from Samsung Scan Assistant program.

- 1 From the Samsung website, download the Samsung Scan Assistant software to your computer. Then unpack and install the software.
- 2 Make sure that the machine is connected to your computer and powered on.
- 3 Place a single document face down on the document glass, or load the documents face up into the document feeder (see "Loading originals" on page 51).
- 4 Click **Start > All programs > Samsung Printers**, and start **Samsung Scan Assistant**.



Select the **Help** menu or click the  button from the window and click on any option you want to know about.

- 5 Set the scan options.

Scan features

- 6 Click **Scan**.

Mac scanning

Scanning from USB connected machine

- 1 Make sure that the machine is connected to your computer and powered on.
- 2 Place a single document face down on the document glass, or load the documents face up into the document feeder (see "Loading originals" on page 51).
- 3 Start **Applications** and click **Image Capture**.

 If **No Image Capture device connected** message appears, disconnect the USB cable and reconnect it. If the problem continues, refer to the **Image Capture's** help.

- 4 Select the option you want.
- 5 Scan and save your scanned image.



If scanning does not operate in **Image Capture**, update Mac OS to the latest version. **Image Capture** operates properly in Mac OS X 10.4.7 or higher.

Scanning from network connected machine



Network or wireless model only (see "Features by models" on page 7).

- 1 Make sure that your machine is connected to a network.
- 2 Place a single document face down on the document glass, or load the documents face up into the document feeder (see "Loading originals" on page 51).
- 3 Start **Applications** and click **Image Capture**.
- 4 According to OS, follow steps below.
 - For 10.4
 - Click **Devices > Browse Devices** on Menu bar.
 - Select your machine in Twain devices option. Make sure that **Use TWAIN software** checkbox is checked.

Scan features

- Click **Connect**.

If a warning message appears, click **Change Port..** to select port, or If TWAIN UI appears, click **Change Port..** from the **Preference** tab and select a new port.

- For 10.5
 - Click **Devices > Browse Devices** on Menu bar.
 - Make sure that **Connected** checkbox is checked beside your machine in **Bonjour Devices**.
 - If you want to scan using TWAIN, refer to the Mac OS X10.4 steps above.
- For 10.6 -10.8, select your device below **SHARED**.

5 Set the scan options on this program.

6 Scan and save your scanned image.



- If scanning does not operate in Image Capture, update Mac OS to the latest version. Image Capture operates properly Mac OS X 10.4.7 or higher.
- For more information, refer to the **Image Capture's** help.
- You can also scan using TWAIN-compliant software, such as Adobe Photoshop.

Linux scanning

Scanning

- 1** Make sure that the machine is connected to your computer and powered on.
- 2** Double-click the **Unified Driver Configurator** on your desktop.
- 3** Click the  button to switch to Scanners Configuration.

Scan features

- 4 Select the scanner on the list.

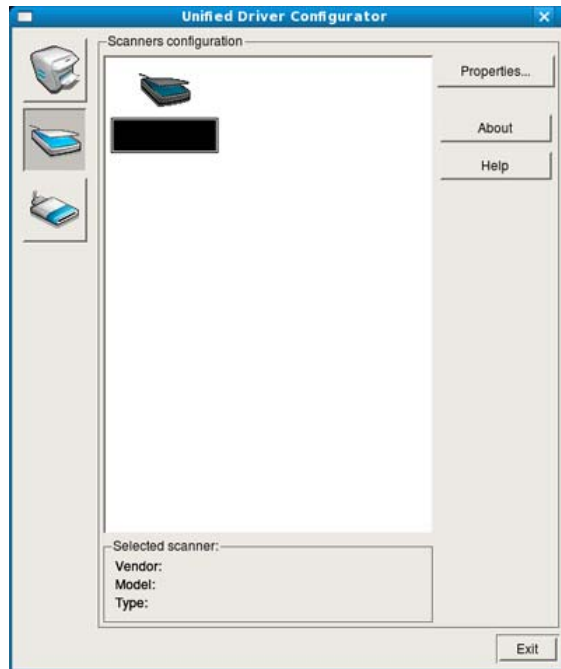

- 5 Click **Properties**.

- 6 Place a single document face down on the document glass, or load the documents face up into the document feeder (see "Loading originals" on page 51).

- 7 From the **Scanner Properties** window, click **Preview**.

- 8 The document is scanned and the image preview appears in the **Preview Pane**.

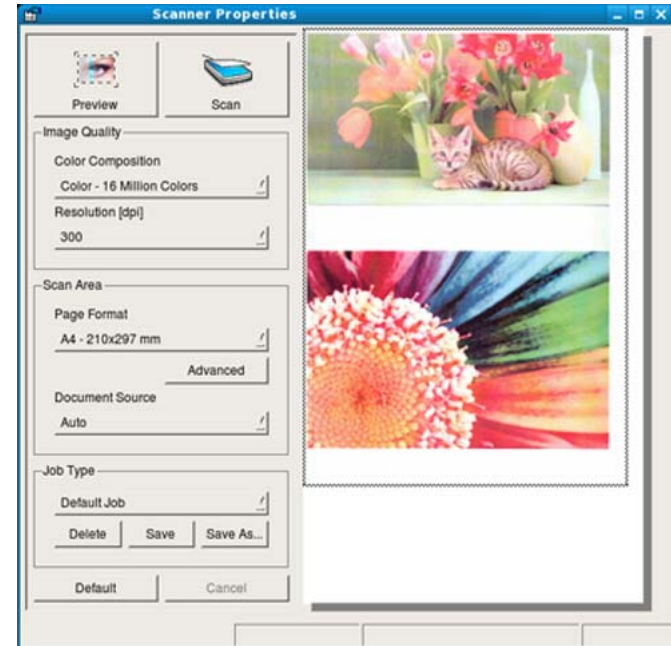

- 9 Drag the pointer to set the image area to be scanned in the **Preview Pane**.

- 10 Select the option you want.

- 11 Scan and save your scanned image.



For later use, you can save as your scan settings and add it to the **Job Type** drop-down list.

Scan features

Editing an image with Image Manager

The Image Manager application provides you with menu commands and tools to edit your scanned image.

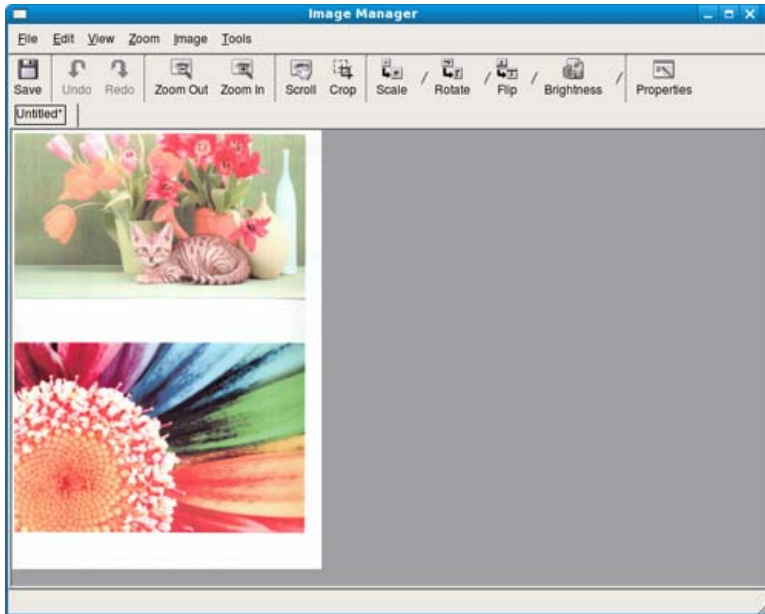



Fax features





- For basic faxing features, refer to the Basic Guide (see "Basic faxing" on page 66).
- This function is not supported for CLX-330x/CLX-330xW Series (see "Control panel overview" on page 24).

Automatic redialing

When the number you have dialed is busy or there is no answer when you send a fax, the machine automatically redials the number. The redial time depends on the country's factory default setting.

When the display shows **Retry Redial?**, press  (**Start**) button to redial the number without waiting. To cancel the automatic redialing, press  (**Cancel** or **Stop/Clear**).

To change the time interval between redials and the number of redial attempts.

- 1 Press  (fax) >  (**Menu**) > **Fax Setup** > **Sending** on the control panel.
- 2 Select **Redial Times** or **Redial Term** you want.
- 3 Select the option you want.

Redialing the fax number

- 1 Press  (**Redial/Pause**) button on the control panel.
- 2 Select the fax number you want.
Ten recently sent fax numbers with ten received Caller IDs are shown.
- 3 When an original is loaded in the document feeder, the machine automatically begins to send.
If an original is placed on the scanner glass, select **Yes** to add another page. Load another original and press **OK**. When you have finished, select **No** when **Another Page?** appears.



Confirming a transmission

When the last page of your original has been sent successfully, the machine beeps and returns to ready mode.

When something goes wrong while sending your fax, an error message appears on the display. If you receive an error message, press  (**Cancel** or **Stop/Clear**) to clear the message and try to send the fax again.



Fax features



You can set your machine to print a confirmation report automatically each time sending a fax is completed. Press  (fax) >  (**Menu**) > **Fax Setup** > **Sending** > **Send Report** on the control panel.

Sending a fax in the computer



- This feature may not be available depending on model or optional goods (see "Features by models" on page 7).
- To use this feature, set the option on the control panel:
Press  (fax) >  (**Menu**) > **Fax Feature** > **Rcv. Forward** > **Forward To PC** > **On** on the control panel.

You can send a fax from your computer without going to the machine.

To send a fax from your computer, the **Samsung Network PC Fax** program must be installed. This program will be installed when you installed the printer driver.

- 1 Open the document to be sent.
- 2 Select **Print** from the **File** menu.
The **Print** window will be displayed. It may look slightly different depending on your application.
- 3 Select **Samsung Network PC Fax** from the **Print** window
- 4 Click **Print** or **OK**.
- 5 Enter the recipients' numbers and select the option

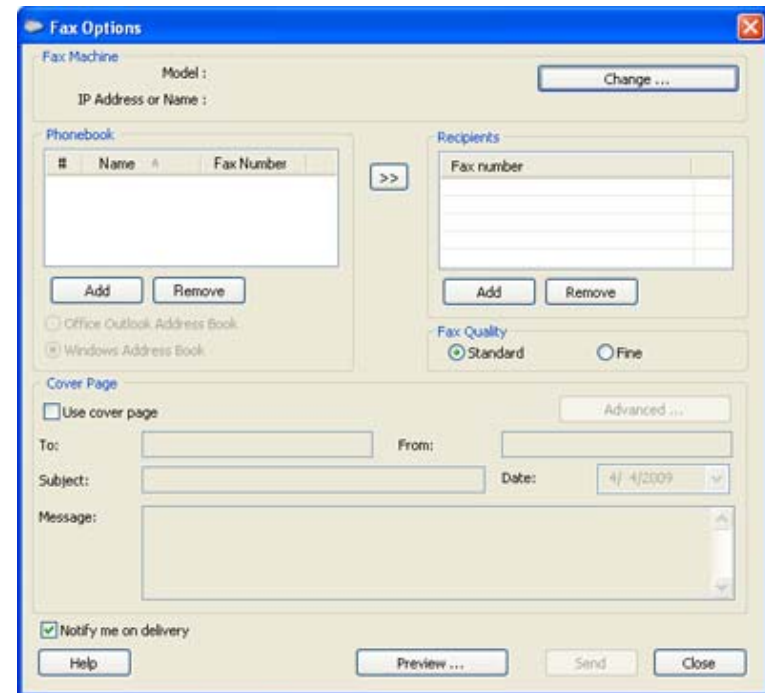

Fax features





Select the **Help** menu or click the  button from the window and click on any option you want to know about.

6 Click **Send**.

Delaying a fax transmission

You can set your machine to send a fax at a later time when you will not be present. You cannot send a color fax using this feature.

- 1 Place a single document face down on the document glass, or load the documents face up into the document feeder.
- 2 Press  (fax) on the control panel.
- 3 Adjust the resolution and the darkness to suit your fax needs.
- 4 Press  (**Menu**) > **Fax Feature** > **Delay Send** on the control panel.
- 5 Enter the number of the receiving fax machine and press **OK**.
- 6 The display asks you to enter another fax number to send the document.
- 7 To enter more fax numbers, press **OK** when **Yes** highlights and repeat steps 5.



- You can add up to 10 destinations.
- Once you entered a group dial number, you cannot enter another group dial numbers anymore.

8 Enter the job name and the time.



If you set a time earlier than the current time, the fax will be sent at that time on the following day.

9 The original is scanned into memory before transmission.

The machine returns to ready mode. The display reminds you that you are in ready mode and that a delayed fax is set.





You can check the list of delayed fax jobs.



Press  (**Menu**) > **System Setup** > **Report** > **Schedule Jobs** on the control panel.

Fax features

Adding documents to a reserved fax



- 1 Place a single document face down on the document glass, or load the documents face up into the document feeder.
- 2 Press  (fax) >  (Menu) > **Fax Feature** > **Add Page** on the control panel.
- 3 Select the fax job and press **OK**.
When you have finished, select **No** when **Another Page?** appears. The machine scans the original into memory.
- 4 Press  (Cancel or Stop/Clear) to return to ready mode.

Canceling a reserved fax job

- 1 Press  (fax) >  (Menu) > **Fax Feature** > **Cancel Job** on the control panel.
- 2 Select the fax job you want and press **OK**.
- 3 Press **OK** when **Yes** highlights.
The selected fax is deleted from memory.
- 4 Press  (Stop/Clear) to return to ready mode.

Sending a priority fax



This function is used when a high priority fax need to be sent ahead of reserved operations. The original is scanned into memory and immediately transmitted when the current operation is finished.

- 1 Place a single document face down on the document glass, or load the documents face up into the document feeder.
- 2 Press  (Fax) >  (Menu) > **Fax Feature** > **Priority Send** on the control panel.
- 3 Enter the destination fax number and press **OK**.
- 4 Enter the job name and press **OK**.
- 5 If an original is placed on the scanner glass, select **Yes** to add another pages. Load another original and press **OK**.
When you have finished, select **No** when **Another Page?** appears.
The machine starts to scan and send a fax to destinations.

Fax features

Forwarding a sent fax to another destination

You can set the machine to forward the received or sent fax to other destination by a fax. If you are out of office but have to receive the fax, this feature may be useful.



- 1 Place a single document face down on the document glass, or load the documents face up into the document feeder.
- 2 Press  (fax) >  (Menu) > **Fax Feature** > **Send Forward** > **Forward to Fax** > **On** on the control panel.

 **Forward** options may not be available depending on model or optional goods (see "Variety feature" on page 10).

- 3 Enter the destination fax number, email address, or server address and press **OK**.
- 4 Press  (**Cancel** or **Stop/Clear**) to return to ready mode.
Subsequent sent faxes will be forwarded to the specified fax machine.

Forwarding a received fax

You can set the machine to forward the received or sent fax to other destination by a fax. If you are out of office but have to receive the fax, this feature may be useful.

- 1 Press  (fax) >  (Menu) > **Fax Feature** > **Receive Forward** or **Rcv. Forward** > **Forward to Fax** or **Forward to PC** > **Forward** on the control panel.



- **Forward** options may not be available depending on model or optional goods (see "Variety feature" on page 10).
- To set the machine to print out a fax when fax forwarding has been completed, select **Forward&Print**.

- 2 Enter the destination fax number, email address, or server address and press **OK**.
- 3 Enter the starting time and ending time, then press **OK**.
- 4 Press  (**Cancel** or **Stop/Clear**) to return to ready mode.
Subsequent sent faxes will be forwarded to the specified fax machine.

Fax features

Receiving a fax in the computer



- This feature may not be available depending on model or optional goods (see "Features by models" on page 7).
- To use this feature, set the option on the control panel:





Press  (fax) >  (**Menu**) > **Fax Feature** > **Rcv. Forward** > **Forward to PC** > **Forward** the control panel.

- 1 Open the Samsung Easy Printer Manager.
- 2 Select the appropriate machine from the **Printer List**.
- 3 Select **Fax to PC Settings** menu.
- 4 Use **Enable Fax Receiving from Device** to change the fax settings.
 - **Image Type:** Convert the received faxes to PDF or TIFF.
 - **Save Location:** Select location to save the converted faxes.
 - **Prefix:** Select prefix.
 - **Print received fax:** After receiving the fax, set prints information for the received fax.
 - **Notify me when complete:** Set to show the popup window to notify receiving a fax.

- **Open with default application:** After receiving the fax, open it with default application.
- **None:** After receiving a fax, the machine does not notify the user or opens the application.

- 5 Press **Save** > **OK**.

Changing the receive modes

- 1 Press  (fax) >  (**Menu**) > **Fax Setup** > **Receiving** > **Receive Mode** on the control panel.
- 2 Select the option you want.
 - **Fax:** Answers an incoming fax call and immediately goes into the fax reception mode.
 - **Tel:** Receives a fax by pressing  (**On Hook Dial**) and then  (**Start**) button.
 - **Ans/Fax:** Is for when an answering machine attached to your machine. Your machine answers an incoming call, and the caller can leave a message on the answering machine. If the fax machine senses a fax tone on the line, the machine automatically switches to Fax mode to receive the fax.

Fax features



To use the **Ans/Fax** mode, attach an answering machine to the EXT socket on the back of your machine.



- **DRPD:** You can receive a call using the Distinctive Ring Pattern Detection (DRPD) feature. Distinctive Ring is a telephone company service which enables an user to use a single telephone line to answer several different telephone numbers. For further details, see "Receiving faxes using DRPD mode" on page 247.



This setting may not be available depending on your country.

- 3 Press **OK**.
- 4 Press  (**Cancel** or **Stop/Clear**) to return to ready mode.

Receiving manually in Tel mode

You can receive a fax call by pressing  (**On Hook Dial**) button and then pressing  (**Start**) when you hear a fax tone.

Receiving in Answering Machine/Fax mode

To use this mode, you must attach an answering machine to the EXT socket on the back of your machine. If the caller leaves a message, the answering machine stores the message. If your machine detects a fax tone on the line, it automatically starts to receive the fax.



- If you have set your machine to this mode and your answering machine is switched off, or no answering machine is connected to EXT socket, your machine automatically goes into Fax mode after a predefined number of rings.
- If the answering machine has a user-selectable ring counter, set the machine to answer incoming calls within 1 ring.
- If the machine is in Tel mode, disconnect or switch off the answering machine with the fax machine. Otherwise, the outgoing message from the answering machine will interrupt your phone conversation.

Receiving faxes with an extension telephone

When you are using an extension telephone connected to the EXT socket, you can receive a fax from someone you are talking to on the extension telephone, without going to the fax machine.

When you receive a call on the extension phone and hear fax tones, press the keys ***9*** on the extension phone. The machine receives the fax.

Fax features

9 is the remote receive code preset at the factory. The first and the last asterisks are fixed, but you can change the middle number to whatever you want.





While you are talking over the telephone connected to the EXT socket, copy and scan features are not available.

Receiving faxes using DRPD mode

This setting may not be available depending on your country. Distinctive Ring is a telephone company service which enables an user to use a single telephone line to answer several different telephone numbers. This feature is often used by answering services who answer telephones for many different clients and need to know which number someone is calling in on to properly answer the phone.



This setting may not be available depending on your country.

- 1 Select  (fax) >  (**Menu**) > **Fax Setup** > **Receiving** > **DRPD Mode** > **Waiting Ring** on the control panel.
- 2 Call your fax number from another telephone.

- 3 When your machine begins to ring, do not answer the call. The machine requires several rings to learn the pattern.

When the machine completes learning, the display shows **Completed DRPD Setup**. If the DRPD setup fails, **Error DRPD Ring** appears.

- 4 Press **OK** when DRPD appears and start over from step 2.



- DRPD must be set up again if you re-assign your fax number, or connect the machine to another telephone line.
- After DRPD has been set up, call your fax number again to verify that the machine answers with a fax tone. Then have a call placed to a different number assigned to that same line to be sure the call is forwarded to the extension telephone or answering machine plugged into the EXT socket.

Receiving in secure receiving mode





This feature may not be available depending on model or optional goods (see "Features by models" on page 7).



You may need to prevent your received faxes from being accessed by unauthorized people. Turn on secure receiving mode, then all incoming faxes go into memory. You can print the incoming faxes with entering the password.

Fax features



To use the secure receiving mode, activate the menu from  (fax) >  (Menu) > **Fax Feature** > **Secure Receive** on the control panel.

Printing received faxes

- 1 Select  (fax) >  (Menu) > **Fax Feature** > **Secure Receive** > **Print** on the control panel.
- 2 Enter a four-digit password and press **OK**.
- 3 The machine prints all of the faxes stored in memory.

Receiving faxes in memory



Since your machine is a multi-tasking device, it can receive faxes while you are making copies or printing. If you receive a fax while you are copying or printing, your machine stores incoming faxes in its memory. Then, as soon as you finish copying or printing, the machine automatically prints the fax.



If fax is received and being printed, other copy and print jobs cannot be processed at the same time.

Printing sent fax report automatically

You can set the machine to print a report with detailed information about the previous 50 communication operations, including time and dates.

- 1 Press  (fax) >  (Menu) > **Fax Setup** > **Auto Report** > **On** on the control panel.
- 2 Press  (**Cancel** or **Stop/Clear**) to return to ready mode.



5. Useful Management Tools

This chapter introduces management tools provided to help you make full use of your machine.

- **Easy Capture Manager** 250
- **Samsung Easy Color Manager** 251
- **Samsung AnyWeb Print** 252
- **Easy Eco Driver** 253
- **Using SyncThru™ Web Service** 254
- **Using Samsung Easy Printer Manager** 257
- **Using Samsung Easy Document Creator** 260
- **Using Samsung Printer Status** 265
- **Using the Linux Unified Driver Configurator** 267

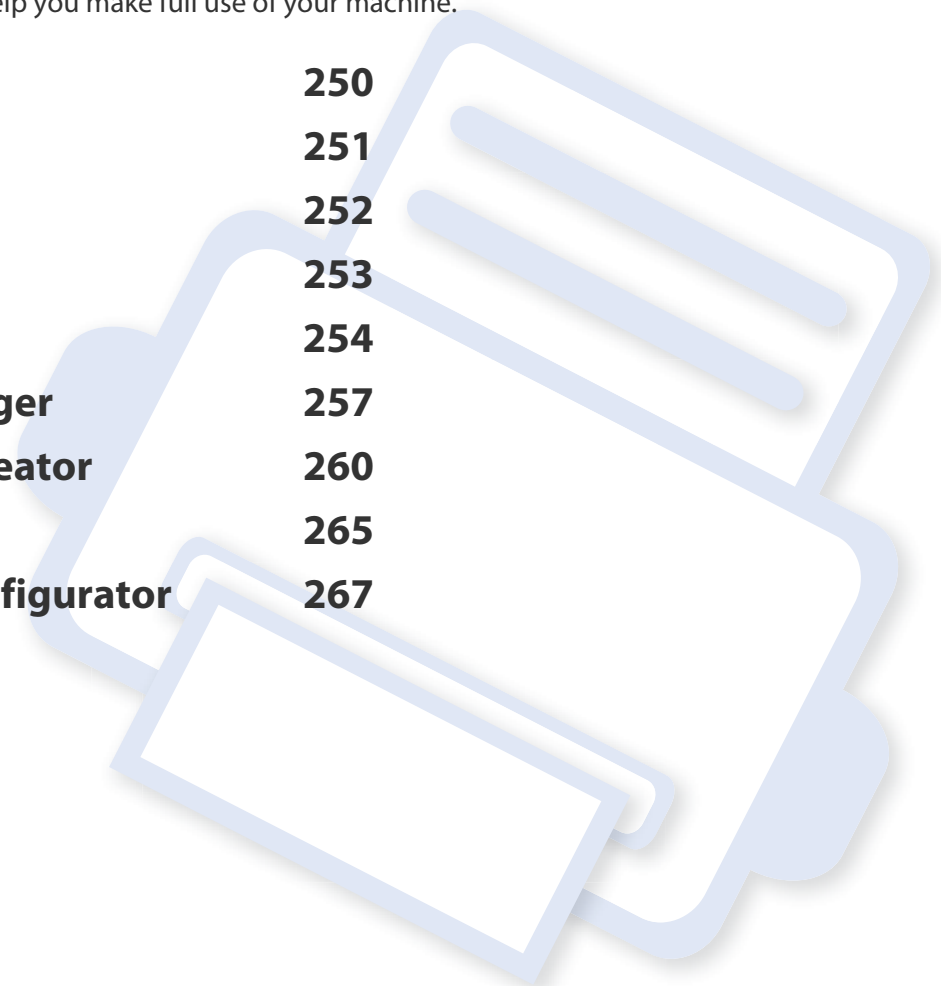

Easy Capture Manager



- This feature may not be available depending on model or optional goods (see "Software" on page 8).
- Available for Windows OS users only (see "Software" on page 8).

Capture your screen and launch Easy Capture Manager by simply pressing the Print Screen key. Now you can easily print your captured screen as captured or edited.

Samsung Easy Color Manager

Samsung Easy Color Manager helps users do fine adjustments with 6 color tones and other properties, such as brightness, contrast, and saturation. Color tone changes can be saved as a profile and can be used from the driver or from inside of the machine.



- This feature may not be available depending on model or optional goods (see "Software" on page 8).
- Available for Windows and Mac OS users only (see "Software" on page 8).

Helps Samsung color laser printer users to adjust color as they like.

Download the software from the Samsung website then unpack and install it: (<http://www.samsung.com> > find your product > Support or Downloads).

Samsung AnyWeb Print



- This feature may not be available depending on model or optional goods (see "Software" on page 8).
- Available for Windows and Mac OS users only (see "Software" on page 8).

This tool helps you screen-capture, preview, scrap, and print Windows Internet Explorer pages more easily, than when you use an ordinary program.

Download the software from the Samsung website then unpack and install it: (<http://www.samsung.com> > find your product > Support or Downloads).

Easy Eco Driver



- This feature may not be available depending on model or optional goods (see "Software" on page 8).
- Available for Windows OS users only (see "Software" on page 8).

With the Easy Eco Driver, you can apply Eco features to save paper and toner before printing. To use this application, **Start Easy Eco Driver before printing job** checkbox in the printer properties should be checked.

Easy Eco Driver also allows you simple editing such as removing images and texts, changing font's attribute, and more. You can save frequently used settings as a preset.

How to use:

- 1 Open a document to print.
- 2 Print the document.
A preview window appears.
- 3 Select the options you want to apply to the document.
You can see the preview of the applied features.
- 4 Click **Print**.

Using SyncThru™ Web Service



- Internet Explorer 6.0 or higher is the minimum requirement for SyncThru™ Web Service.
- SyncThru™ Web Service explanation in this user's guide may differ from your machine depending on its options or models.
- Network model only (see "Variety feature" on page 10).

Accessing SyncThru™ Web Service

- 1 Access a web browser, such as Internet Explorer, from Windows.
Enter the machine IP address of your printer (<http://xxx.xxx.xxx.xxx>) in the address field and press the Enter key or click **Go**.
- 2 Your machine's embedded website opens.

Logging into SyncThru™ Web Service

Before configuring options in SyncThru™ Web Service, you need to log-in as an administrator. You can still use SyncThru™ Web Service without logging in but you won't have access to **Settings** tab and **Security** tab.

- 1 Click **Login** on the upper right of the SyncThru™ Web Service website.
- 2 If it's your first time logging into **SyncThru™ Web Service** you need to log-in as an administrator. Type in the below default **ID** and **Password**. We recommend you to change the default password for security reasons.
 - **ID: admin**
 - **Password: sec00000**

SyncThru™ Web Service overview



Information

Settings

Security

Maintenance



Some tabs may not appear depending on your model.

Using SyncThru™ Web Service

Information tab

This tab gives you general information about your machine. You can check things, such as remaining amount of toner. You can also print reports, such as an error report.

- **Active Alerts:** Shows the alerts that have occurred in the machine and their severity.
- **Supplies:** Shows how many pages are printed and amount of toner left in the cartridge.
- **Usage Counters:** Shows the usage count by print types: simplex and duplex.
- **Current Settings:** Shows the machine's and network's information.
- **Print information:** Prints reports such as system related reports, e-mail address, and font reports.

Settings tab

This tab allows you to set configurations provided by your machine and network. You need to log-in as an administrator to view this tab.

- **Machine Settings** tab: Sets options provided by your machine.
- **Network Settings** tab: Shows options for the network environment. Sets options such as TCP/IP and network protocols.

Security tab

This tab allows you to set system and network security information. You need to log-in as an administrator to view this tab.

- **System Security:** Sets the system administrator's information and also enables or disables machine features.
- **Network Security:** Sets settings for IPv4/IPv6 filtering and Authentication servers.

Maintenance tab

This tab allows you to maintain your machine by upgrading firmware and setting contact information for sending emails. You can also connect to Samsung website or download drivers by selecting the **Link** menu.

- **Firmware Upgrade:** Upgrade your machine's firmware.
- **Contact Information:** Shows the contact information.
- **Link:** Shows links to useful sites where you can download or check information.

Setting the system administrator's information

This setting is necessary for using the e-mail notification option.

Using SyncThru™ Web Service



Some menus may not appear in the display depending on options or models. If so, it is not applicable to your machine.

- 1** Start a web browser, such as Internet Explorer, from Windows.
Enter the machine IP address (<http://xxx.xxx.xxx.xxx>) in the address field and press the Enter key or click **Go**.
- 2** Your machine's embedded website opens.
- 3** From the **Security** tab, select **System Security** > **System Administrator**
- 4** Enter the name of the administrator, phone number, location, and email address.
- 5** Click **Apply**.

Using Samsung Easy Printer Manager



- This feature may not be available depending on model or optional goods (see "Software" on page 8).
- Available for Windows and Mac OS users only (see "Software" on page 8).
- For Windows, Internet Explorer 6.0 or higher is the minimum requirement for Samsung Easy Printer Manager.

Samsung Easy Printer Manager is an application that combines Samsung machine settings into one location. Samsung Easy Printer Manager combines device settings as well as printing environments, settings/actions and launching. All of these features provide a gateway to conveniently use your Samsung machine. Samsung Easy Printer Manager provides two different user interfaces for the user to choose from: the basic user interface and the advanced user interface. Switching between the two interfaces is easy: just click a button.

Understanding Samsung Easy Printer Manager

To open the program:

For Windows,

Select **Start > Programs** or **All Programs > Samsung Printers > Samsung Easy Printer Manager > Samsung Easy Printer Manager**.

For Mac,

Open the **Applications** folder > **Samsung** folder > **Samsung Easy Printer Manager**.

The Samsung Easy Printer Manager interface is comprised of various basic sections as described in the table that follows:





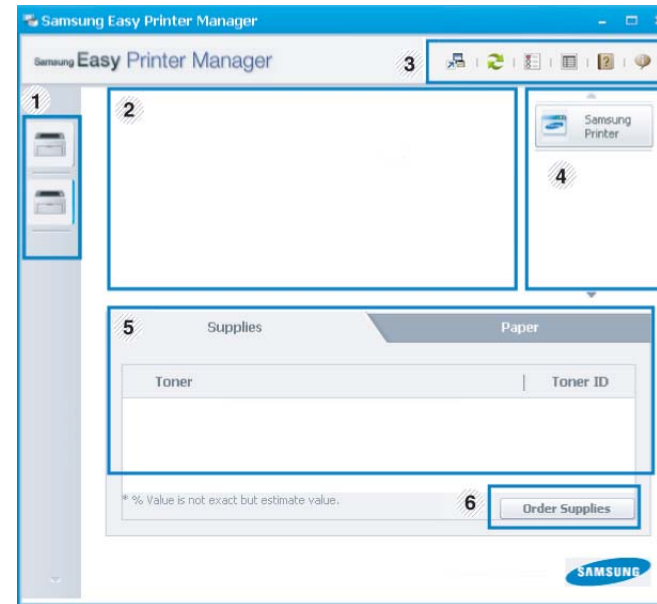

The screenshot may differ depending on operating system you are using.



1	Printer list	The Printer List displays printers installed on your computer and network printers added by network discovery (Windows only).
---	--------------	---

Using Samsung Easy Printer Manager

2	Printer information	<p>This area gives you general information about your machine. You can check information, such as the machine's model name, IP address (or Port name), and machine status.</p> <p> You can view the online User's Guide.</p> <p>Troubleshooting button: This button opens the Troubleshooting Guide when an error occurs. You can directly open the necessary section in the user's guide.</p>
3	Application information	<p>Includes links for changing to the advanced settings, preference, help, and about.</p> <p> The  button is used to change the user interface to the advanced settings user interface (see "Advanced settings user interface overview" on page 258).</p>

4	Quick links	<p>Displays Quick links to machine specific functions. This section also includes links to applications in the advanced settings.</p> <p> If you connect your machine to a network, the SyncThru™ Web Service icon is enabled.</p>
5	Contents area	<p>Displays information about the selected machine, remaining toner level, and paper. The information will vary based on the machine selected. Some machines do not have this feature.</p>
6	Order supplies	<p>Click on the Order button from the supply ordering window. You can order replacement toner cartridge(s) from online.</p>



Select the **Help** menu or click the  button from the window and click on any option you want to know about.

Advanced settings user interface overview

The advanced user interface is intended to be used by the person responsible for managing the network and machines.

Using Samsung Easy Printer Manager



Some menus may not appear in the display depending on options or models. If so, it is not applicable to your machine.

Device Settings

You can configure various machine settings such as machine setup, paper, layout, emulation, network, and print information.

Scan to PC Settings

This menu includes settings to create or delete scan to PC profiles.

- **Scan Activation:** Determines whether or not scanning is enabled on the device.
- **Basic** tab: Contains settings related general scan and device settings.
- **Image** tab: Contains settings related to image altering.

Fax to PC Settings

This menu includes settings related to the basic fax functionality of the selected device.

- **Disable:** If **Disable** is **On**, incoming faxes will not be received on this device.
- **Enable Fax Receiving from Device:** Enables faxing on the device and allow more options to be set.

Alert Settings (Windows only)

This menu includes settings related to error alerting.

- **Printer Alert:** Provides settings related to when alerts will be received.
- **Email Alert:** Provides options relating to receiving alerts via email.
- **Alert History:** Provides a history of device and toner related alerts.

Job Accounting

Provides querying of quota information of the specified job accounting user. This quota information can be created and applied to devices by job accounting software such as SyncThru™ or CounThru™ admin software.

Using Samsung Easy Document Creator

Samsung Easy Document Creator is an application to help users scan, compile, and save documents in multiple formats, including .epub format. These documents can be shared via social networking sites or fax. Whether you're a student needing to organize research from the library or a stay-at-home mom sharing scanned pictures from last year's birthday party, Easy Document Creator will provide you with the necessary tools.



- Available for Windows OS users only.
- Windows XP or higher and Internet Explorer 6.0 or higher is the minimum requirement for Samsung Easy Document Creator.
- Samsung Easy Document Creator is installed automatically when you install the machine software.

Understanding Samsung Easy Document Creator

To open the program:



Select **Start > Programs** or **All Programs > Samsung Printers > Samsung Easy Document Creator > Samsung Easy Document Creator**.

The Samsung Easy Document Creator interface is comprised of various basic sections as described in the table that follows:



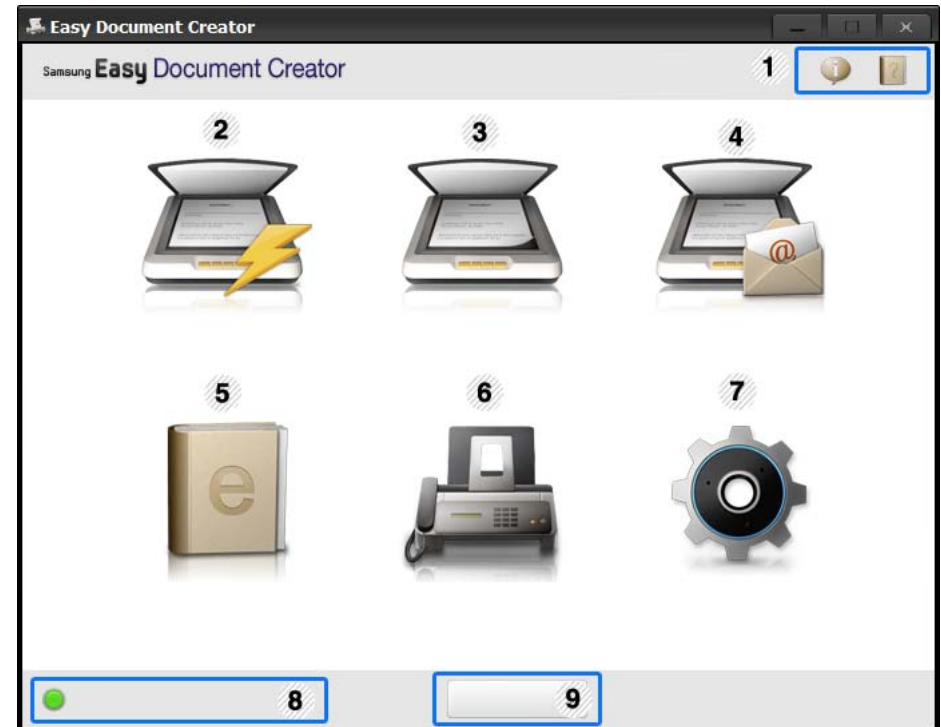

The screenshot may differ depending on operating system you are using.



1	 (Information)	Click the information button to see the program's version information.
	 (Help)	Click the help button to get the information of any option you want to use.

Using Samsung Easy Document Creator

2	Quick Scan	Automatically scans with the settings provided in Configuration. You can pre-set the options such as image type, document size, resolution, or file type (see "Quick Scanning" on page 262).
3	Scan	<p>Provides more in-depth options for scanning documents on a one-by-one basis (see "Scanning" on page 262).</p> <div data-bbox="353 496 1084 695" style="border: 1px solid #ccc; padding: 5px; margin: 10px 0;">  Text Converting will only be available after installing the optical character recognition (OCR) software provided in a separate installation file. </div> <ul style="list-style-type: none"> • Image Scanning: Use for scanning single or multiple pictures. • Document Scanning: Use for scanning documents with text or text and images. • Text Converting: Use for scanning documents that need to be saved in an editable text format. • Book Scanning: Use for scanning books with the flatbed scanner. • Favorites: User-created favorites for frequently-used scan settings.

4	SNS Upload	<p>Provides an easy and quick way to upload files to a variety of social networking sites (SNS). Scan an image directly or select an existing image to upload to Facebook, Flickr, Picasa, Google Docs, or Twitter (see "Scanning to a Social Networking Site" on page 263).</p> <div data-bbox="1464 448 2197 775" style="border: 1px solid #ccc; padding: 5px; margin: 10px 0;">  SNS Upload will only be available after Microsoft®.NET Framework 3.5 Service Pack 1 has been installed (http://www.microsoft.com/download/en/details.aspx?id=22) and Windows XP or higher and Internet Explorer 7.0 or higher are required </div>
5	E-Book Conversion	Provides the ability to scan multiple documents in as one e-book or convert existing files into an e-book format (.epub file) (see "Converting to an E-Book" on page 263).
6	Send Fax	<p>Provides the ability to directly fax a document from Easy Document Creator if the Samsung Network PC Fax driver is installed (see "Sending a fax in the computer" on page 241).</p> <div data-bbox="1464 1134 2197 1286" style="border: 1px solid #ccc; padding: 5px; margin: 10px 0;">  If the Samsung Network PC Fax driver is not installed, this will be grayed out. </div>
7	Configuration	Provides the options for a Common and Quick Scan.
8	Device Name	Shows the scanning/faxing device ready to use.

Using Samsung Easy Document Creator

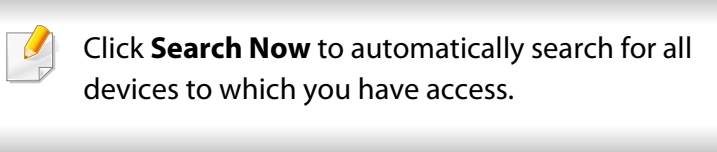
9	Search	If you cannot see any device ready to use, click this button to find a device.  Click Search Now to automatically search for all devices to which you have access.
---	---------------	--



Click the Help (?) button from the upper-right corner of the window and click on any option you want to know about.

Using features

Scanning

- 1 Place a single document face down on the document glass, or load the documents face up into the document feeder (see "Loading originals" on page 51).
- 2 Click **Scan** from the home screen.
- 3 Select the type of scanning or a favorites then click **Start**.
- 4 Make adjustments to the image (**Scan Settings** and **More Options**).

- 5 Click **Scan** to scan a final image or **Prescan** to get another preview image.
- 6 Select to **Save to Location**, **Send to E-mail**, or **Send to SNS**.
- 7 Click on **Save** (Saving a Scan), **Send** (E-mailing a Scan), or **Share** (Uploading).



If there is room on the document glass, more than one item can be scanned at the same time. Use the  tool to make multiple selection areas.

Quick Scanning

Configuring Quick Scan

To set up the Quick Scan options:

- 1 Click **Configuration** from the home screen.
- 2 Click on **Default** to use the default settings, or select your own options.
- 3 Click **Apply** to save changes.

Using Samsung Easy Document Creator

Using Quick Scan

- 1 Place a single document face down on the document glass, or load the documents face up into the document feeder (see "Loading originals" on page 51).
- 2 Click **Quick Scan** from the home screen.
- 3 Select a save location for the scanned images.
- 4 Click **Save** to save the image.



Click **Scan More** to scan another image with the same settings.

Scanning to a Social Networking Site

Scan Directly

- 1 Place a single document face down on the document glass, or load the documents face up into the document feeder (see "Loading originals" on page 51).
- 2 Click **SNS Upload** from the home screen.
- 3 Click **Scan to SNS > Start**.
- 4 Click **Scan**.

Upload Existing File

- 1 Click **SNS Upload** from the home screen.
- 2 Click **Existing File to SNS > Start**.
- 3 Select the site and click **Add Image** to find the file to upload.
- 4 Select a social networking site to send the image and click **Next**.
- 5 Follow the instructions in each social networking site.



If there are some problems on accessing or uploading to each SNS site due to a network environment issue, it's needed to check security limitations established in your network with network administrator. To guarantee correct functioning of SNS upload in Samsung Easy Document Creator, unrestricted network environment is needed for HTTPS communication.

Converting to an E-Book

Scan Directly

- 1 Place a single document face down on the document glass, or load the documents face up into the document feeder (see "Loading originals" on page 51).
- 2 Click **E-Book Conversion** from the home screen.

Using Samsung Easy Document Creator

3 Click **Scan to E-Book > Start**.

4 Enter a name and author to be used as metatag information for the **.epub** file, a file name, and select a save location.

5 Click **Save**.

Convert Existing Files

1 Click **E-Book Conversion** from the home screen.

2 Click **Existing File to E-Book > Start**.

3 Click **Add Image** to find the file to convert.

4 Enter a name and author to be used as metatag information for the **.epub** file, a file name, and select a save location.

5 Click **Save**.

Sending a Fax

1 Click **Send Fax** from the home screen.

2 Click add file and locate the file to fax.

3 Click **Send Fax**.

4 Enter the fax information (recipient's number, cover page information, etc).

5 Click **Send**.

Plug-ins

Easy Document Creator will also create new plug-ins for Microsoft PowerPoint, Word, and Excel. These new plug-ins will be in a new Easy Document Creator menu on the applications' menu bars: **Scan to Office**, **Send Fax**, and **E-Book**.

Using Samsung Printer Status

The Samsung Printer Status is a program that monitors and informs you of the machine status.



- The Samsung Printer Status window and its contents shown in this user's guide may differ depending on the machine or operating system in use.
- Check the operating system(s) that are compatible with your machine (see "Specifications" on page 119).
- Available for Windows OS users only (see "Software" on page 8).

Samsung Printer Status overview

If an error occurs while operating, you can check the error from the Samsung Printer Status. Samsung Printer Status is installed automatically when you install the machine software.

You can also launch Samsung Printer Status manually. Go to the **Printing Preferences**, click the **Basic** tab > **Printer Status** button.

These icons appear on the Windows task bar:

Icon	Mean	Description
	Normal	The machine is in ready mode and experiencing no errors or warnings.
	Warning	The machine is in a state where an error might occur in the future. For example, it might be in toner low status, which may lead to toner empty status.
	Error	The machine has at least one error.

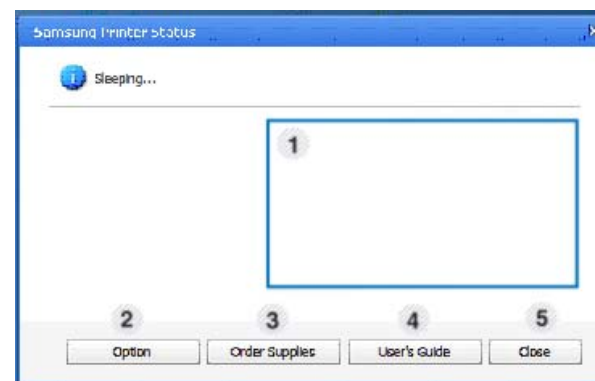

1	Toner Level	You can view the level of toner remaining in each toner cartridge. The machine and the number of toner cartridge(s) shown in the above window may differ depending on the machine in use. Some machines do not have this feature.
2	Option	You can set printing job alert related settings.

Using Samsung Printer Status

3	Order Supplies	You can order replacement toner cartridge(s) from online.
4	User's Guide	<p>You can view the online User's Guide.</p> <div data-bbox="421 395 1084 639"> This button opens the Troubleshooting Guide when an error occurs. You can directly open the troubleshooting section in the user's guide.</div>
5	Close	Close the window.

Using the Linux Unified Driver Configurator

The Unified Driver Configurator is a tool primarily intended for configuring machine devices. You need to install Unified Linux Driver to use Unified Driver Configurator (see "Installation for Linux" on page 148).

After the driver is installed on your Linux system, the Unified Driver Configurator icon will automatically be created on your desktop.

Opening Unified Driver Configurator

- 1 Double-click the **Unified Driver Configurator** on the desktop. You can also click the **Startup** Menu icon and select **Samsung Unified Driver > Unified Driver Configurator**.
- 2 Click each button on the left to switch to the corresponding configuration window.

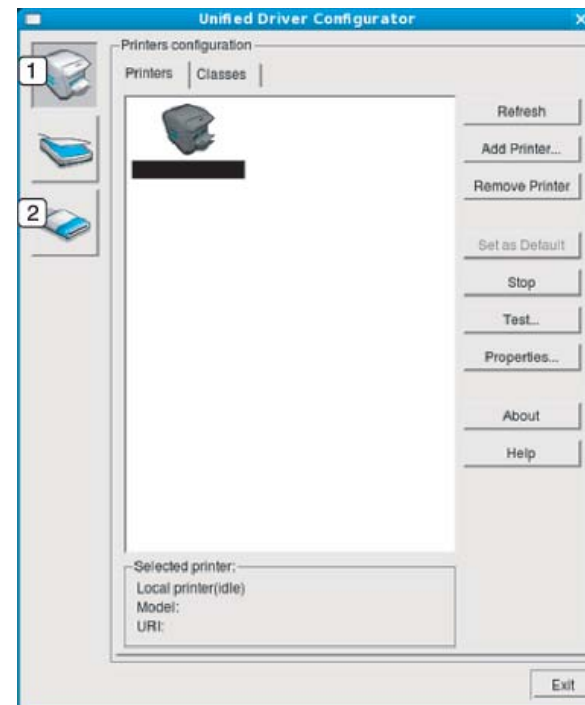

- 1 **Printer Configuration**
- 2 **Port Configuration**

Using the Linux Unified Driver Configurator



To use the on screen help, the **Help** or **?** button from the window.

- 3 After changing the configurations, click **Exit** to close the **Unified Driver Configurator**.

Printers configuration

Printers configuration has the two tabs: **Printers** and **Classes**.

Printers tab

View the current system's printer configuration by clicking on the machine icon button on the left side of the **Unified Driver Configurator** window.

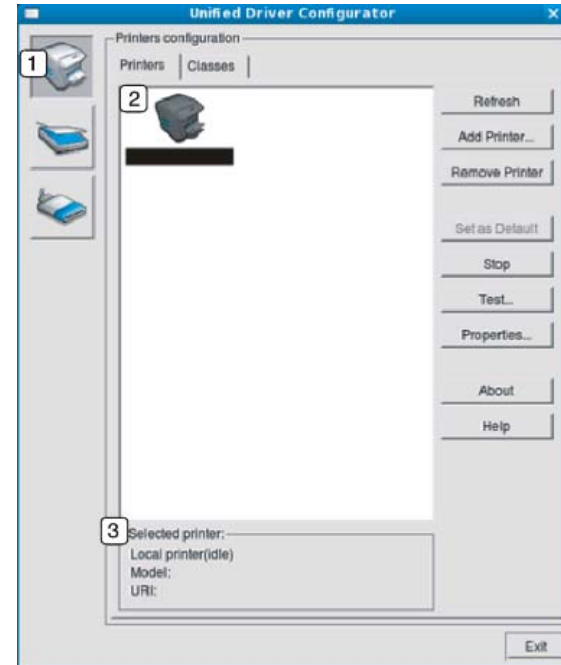

- | | |
|---|--|
| 1 | Switches to Printers configuration . |
| 2 | Shows all of the installed machines. |
| 3 | Shows the status, model name, and URI of your machine. |

Using the Linux Unified Driver Configurator

The printer control buttons are, as follows:

- **Refresh:** Renews the available machines list.
- **Add Printer:** Allows you to add a new machines.
- **Remove Printer:** Removes the selected machine.
- **Set as Default:** Sets the current selected machine as a default machine.
- **Stop/Start:** Stops/starts the machine.
- **Test:** Allows you to print a test page to ensure the machine is working properly.
- **Properties:** Allows you to view and change the printer's properties.

Classes tab

The Classes tab shows a list of available machine classes.

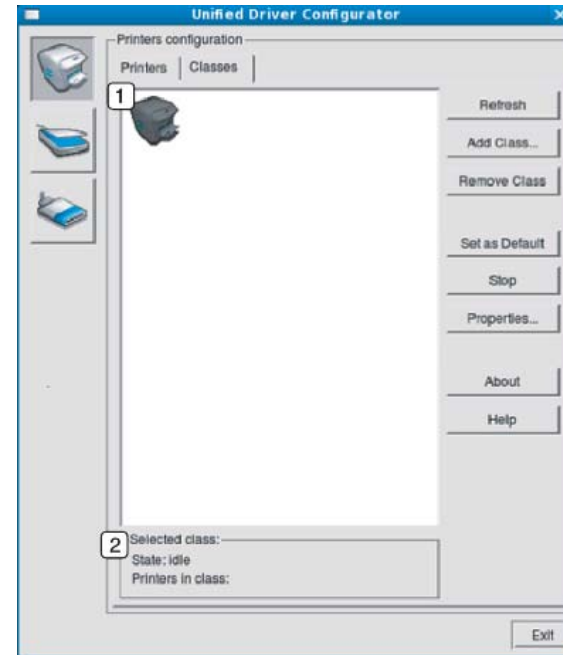

- | | |
|---|--|
| 1 | Shows all of the machine classes. |
| 2 | Shows the status of the class and the number of machines in the class. |

- **Refresh:** Renews the classes list.
- **Add Class:** Allows you to add a new machine class.
- **Remove Class:** Removes the selected machine class.

Using the Linux Unified Driver Configurator

Ports configuration

In this window, you can view the list of available ports, check the status of each port and release a port that is stalled in a busy state when its owner has terminated the job for any reason.

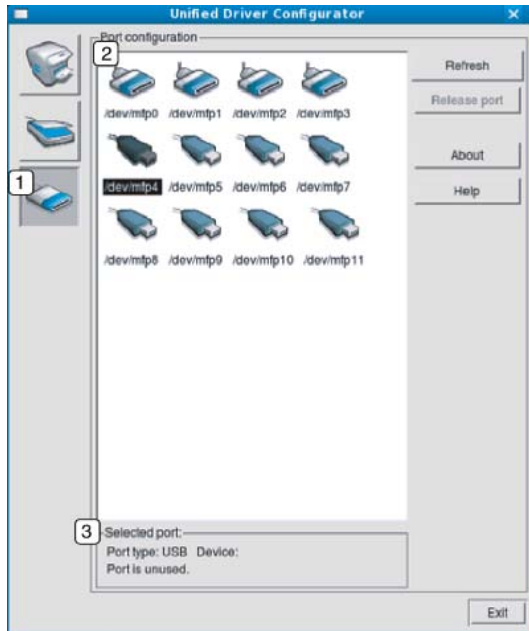

1	Switches to Ports configuration .
2	Shows all of the available ports.
3	Shows the port type, device connected to the port, and status.

- **Refresh:** Renews the available ports list.
- **Release port:** Releases the selected port.



6. Troubleshooting

This chapter gives helpful information for what to do if you encounter an error.

- **Paper feeding problems** 272
- **Power and cable connecting problems** 273
- **Printing problems** 274
- **Printing quality problems** 278
- **Copying problems** 286
- **Scanning problems** 287
- **Faxing problems** 288
- **Operating system problems** 290



For errors that occur during the wireless software installation and settings, refer to the troubleshooting section in the wireless setting chapter (see "Troubleshooting" on page 183).

Paper feeding problems

Condition	Suggested solutions
Paper jams during printing.	Clear the paper jam.
Paper sticks together.	<ul style="list-style-type: none">• Check the maximum paper capacity of the tray.• Make sure that you are using the correct type of paper.• Remove paper from the tray and flex or fan the paper.• Humid conditions may cause some paper to stick together.
Multiple sheets of paper do not feed.	Different types of paper may be stacked in the tray. Load paper of only one type, size, and weight.
Paper does not feed into the machine.	<ul style="list-style-type: none">• Remove any obstructions from inside the machine.• Paper has not been loaded correctly. Remove paper from the tray and reload it correctly.• There is too much paper in the tray. Remove excess paper from the tray.• The paper is too thick. Use only paper that meets the specifications required by the machine.
The paper keeps jamming.	<ul style="list-style-type: none">• There is too much paper in the tray. Remove excess paper from the tray. If you are printing on special materials, use the manual feeding in tray.• An incorrect type of paper is being used. Use only paper that meets the specifications required by the machine.• There may be debris inside the machine. Open the front cover and remove any debris.

Power and cable connecting problems



Click this link to open an animation about solving power problems.

Condition	Suggested solutions
The machine is not receiving power, or the connection cable between the computer and the machine is not connected properly.	<ul style="list-style-type: none">• Connect the machine to the electricity supply first. If the machine has a  (Power/Wakeup) button on the control, press it.• Disconnect the machine's cable and reconnect it.

Printing problems

Condition	Possible cause	Suggested solutions
The machine does not print.	The machine is not receiving power.	Connect the machine to the electricity supply first. If the machine has a  (Power/Wakeup) button on the control, press it.
	The machine is not selected as the default machine.	Select your machine as your default machine in Windows.
	Check the machine for the following: <ul style="list-style-type: none">• The cover is not closed. Close the cover.• Paper is jammed. Clear the paper jam (see "Clearing paper jams" on page 104).• No paper is loaded. Load paper (see "Loading paper in the tray" on page 44).• The toner cartridge is not installed. Install the toner cartridge (see "Replacing the toner cartridge" on page 83).• Make sure the protect cover and sheets are removed from the toner cartridge (see "Replacing the toner cartridge" on page 83). If a system error occurs, contact your service representative.	
	The connection cable between the computer and the machine is not connected properly.	Disconnect the machine cable and reconnect it (see "Rear view" on page 23).
	The connection cable between the computer and the machine is defective.	If possible, attach the cable to another computer that is working properly and print a job. You can also try using a different machine cable.
	The port setting is incorrect.	Check the Windows printer settings to make sure that the print job is sent to the correct port. If the computer has more than one port, make sure that the machine is attached to the correct one.

Printing problems

Condition	Possible cause	Suggested solutions
The machine does not print.	The machine may be configured incorrectly.	Check the Printing Preferences to ensure that all of the print settings are correct.
	The printer driver may be incorrectly installed.	Uninstall and reinstall the machine's driver.
	The machine is malfunctioning.	Check the display message on the control panel to see if the machine is indicating a system error. Contact a service representative.
	The document size is so big that the hard disk space of the computer is insufficient to access the print job.	Get more hard disk space and print the document again.
	The output tray is full.	Once the paper is removed from the output tray, the machine resumes printing.
The machine selects print materials from the wrong paper source.	The paper option that was selected in the Printing Preferences may be incorrect.	For many software applications, the paper source selection is found under the Paper tab within the Printing Preferences (see "Opening printing preferences" on page 57). Select the correct paper source. See the printer driver help screen (see "Using help" on page 58).
A print job is extremely slow.	The job may be very complex.	Reduce the complexity of the page or try adjusting the print quality settings.
Half the page is blank.	The page orientation setting may be incorrect.	Change the page orientation in your application (see "Opening printing preferences" on page 57). See the printer driver help screen (see "Using help" on page 58).
	The paper size and the paper size settings do not match.	Ensure that the paper size in the printer driver settings matches the paper in the tray. Or, ensure that the paper size in the printer driver settings matches the paper selection in the software application settings you use (see "Opening printing preferences" on page 57).
The machine prints, but the text is wrong, garbled, or incomplete.	The machine cable is loose or defective.	Disconnect the machine cable and reconnect. Try a print job that you have already printed successfully. If possible, attach the cable and the machine to another computer that you know works and try a print job. Finally, try a new machine cable.

Printing problems

Condition	Possible cause	Suggested solutions
	The wrong printer driver was selected.	Check the application's printer selection menu to ensure that your machine is selected.
	The software application is malfunctioning.	Try printing a job from another application.
	The operating system is malfunctioning.	Exit Windows and reboot the computer. Turn the machine off and back on again.
Pages print, but they are blank.	The toner cartridge is defective or out of toner.	Redistribute the toner, if necessary. If necessary, replace the toner cartridge. <ul style="list-style-type: none">• See "Redistributing toner" on page 81.• See "Replacing the toner cartridge" on page 83.
	The file may have blank pages.	Check the file to ensure that it does not contain blank pages.
	Some parts, such as the controller or the board, may be defective.	Contact a service representative.
The machine does not print PDF files correctly. Some parts of graphics, text, or illustrations are missing.	Incompatibility between the PDF file and the Acrobat products.	Printing the PDF file as an image may enable the file to print. Turn on Print As Image from the Acrobat printing options.  It will take longer to print when you print a PDF file as an image.
The print quality of photos is not good. Images are not clear.	The resolution of the photo is very low.	Reduce the photo size. If you increase the photo size in the software application, the resolution will be reduced.
Before printing, the machine emits vapor near the output tray.	Using damp paper can cause vapor during printing.	This is not a problem. Just keep printing.

Printing problems

Condition	Possible cause	Suggested solutions
The machine does not print special-sized paper, such as billing paper.	Paper size and paper size setting do not match.	Set the correct paper size in the Custom in Paper tab in Printing Preferences (see "Opening printing preferences" on page 57).
The printed billing paper is curled.	The paper type setting does not match.	Change the printer option and try again. Go to Printing Preferences , click Paper tab, and set type to Thick (see "Opening printing preferences" on page 57).

Printing quality problems

If the inside of the machine is dirty or paper has been loaded improperly, there might be a reduction in print quality. See the table below to clear the problem.

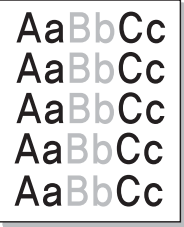
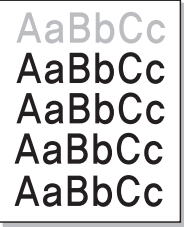
Condition	Suggested solutions
<p data-bbox="51 363 322 395">Light or faded print</p> 	<ul data-bbox="506 363 2186 850" style="list-style-type: none">• If a vertical white streak or faded area appears on the page, the toner supply is low. Install a new toner cartridge (see "Replacing the toner cartridge" on page 83).• If a vertical white streak or faded area still appears on the page even though the machine has enough toner supply, open and close the front door 3 ~ 4 times (see "Machine overview" on page 20).• The paper may not meet paper specifications; for example, the paper may be too moist or rough.• If the entire page is light, the print resolution setting is too low or the toner save mode is on. Adjust the print resolution and turn the toner save mode off. See the help screen of the printer driver.• A combination of faded or smeared defects may indicate that the toner cartridge needs cleaning. Clean the inside of your machine (see "Cleaning the machine" on page 91).• The surface of the LSU part inside the machine may be dirty. Clean the inside of your machine (see "Cleaning the machine" on page 91). If these steps do not correct the problem, contact a service representative.
<p data-bbox="51 884 472 1002">The top half of the paper is printed lighter than the rest of the paper</p> 	<p data-bbox="506 884 1301 916">The toner might not adhere properly to this type of paper.</p> <ul data-bbox="506 940 2186 1011" style="list-style-type: none">• Change the printer option and try again. Go to Printing Preferences, click the Paper tab, and set the paper type to Recycled (see "Opening printing preferences" on page 57).

Printing quality problems

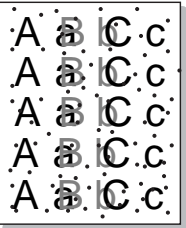
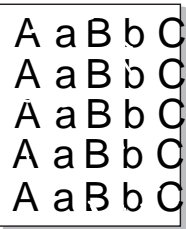
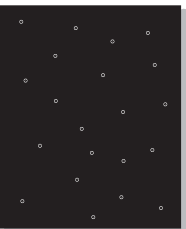
Condition	Suggested solutions
<p>Toner specks</p> 	<ul style="list-style-type: none">• The paper may not meet specifications; for example, the paper may be too moist or rough.• The transfer roller may be dirty. Clean the inside of your machine (see "Cleaning the machine" on page 91).• The paper path may need cleaning. Contact a service representative (see "Cleaning the machine" on page 91).
<p>Dropouts</p> 	<p>If faded areas, generally rounded, occur randomly on the page:</p> <ul style="list-style-type: none">• A single sheet of paper may be defective. Try reprinting the job.• The moisture content of the paper is uneven or the paper has moist spots on its surface. Try a different brand of paper.• The paper lot is bad. The manufacturing processes can cause some areas to reject toner. Try a different kind or brand of paper.• Change the printer option and try again. Go to Printing Preferences, click the Paper tab, and set type to Thick (see "Opening printing preferences" on page 57). <p>If these steps do not correct the problem, contact a service representative.</p>
<p>White Spots</p> 	<p>If white spots appear on the page:</p> <ul style="list-style-type: none">• The paper is too rough and a lot of dirt from paper falls to the inner components within the machine, so the transfer roller may be dirty. Clean the inside of your machine (see "Cleaning the machine" on page 91).• The paper path may need cleaning. Clean the inside of your machine (see "Cleaning the machine" on page 91). <p>If these steps do not correct the problem, contact a service representative.</p>

Printing quality problems

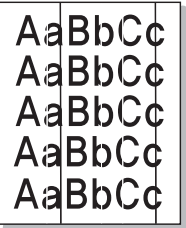
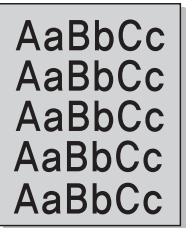
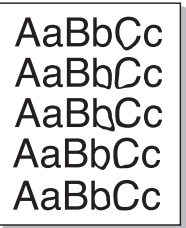
Condition	Suggested solutions
<p>Vertical lines</p> 	<p>If black vertical streaks appear on the page:</p> <ul style="list-style-type: none">• The surface (drum part) of the imaging unit inside the machine has probably been scratched. Remove the imaging unit and install a new one (see "Replacing the imaging unit" on page 87). <p>If white vertical streaks appear on the page:</p> <ul style="list-style-type: none">• The surface of the LSU part inside the machine may be dirty. Clean the inside of your machine (see "Cleaning the machine" on page 91). If these steps do not correct the problem, contact a service representative.
<p>Black or color background</p> 	<p>If the amount of background shading becomes unacceptable:</p> <ul style="list-style-type: none">• Change to a lighter weight paper.• Check the environmental conditions: very dry conditions or a high level of humidity (higher than 80% RH) can increase the amount of background shading.• Remove the old imaging unit and install a new one (see "Replacing the imaging unit" on page 87).• Thoroughly redistribute the toner (see "Redistributing toner" on page 81).
<p>Toner smear</p> 	<ul style="list-style-type: none">• Clean the inside of the machine (see "Cleaning the machine" on page 91).• Check the paper type and quality.• Remove the imaging unit and install a new one (see "Replacing the imaging unit" on page 87).

Printing quality problems

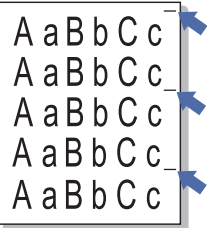
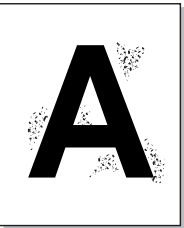
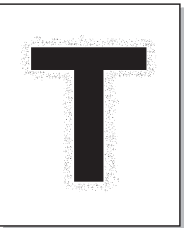
Condition	Suggested solutions
<p data-bbox="51 272 405 304">Vertical repetitive defects</p> 	<p data-bbox="506 272 1473 304">If marks repeatedly appear on the printed side of the page at even intervals:</p> <ul data-bbox="506 328 2190 544" style="list-style-type: none"><li data-bbox="506 328 2190 400">• The imaging unit may be damaged. If you still have the same problem, remove the imaging unit and, install a new one (see "Replacing the imaging unit" on page 87).<li data-bbox="506 416 2190 488">• Parts of the machine may have toner on them. If the defects occur on the back of the page, the problem will likely correct itself after a few more pages.<li data-bbox="506 504 1464 544">• The fusing assembly may be damaged. Contact a service representative.
<p data-bbox="51 612 322 644">Background scatter</p> 	<p data-bbox="506 612 1621 644">Background scatter results from bits of toner randomly distributed on the printed page.</p> <ul data-bbox="506 668 2190 1059" style="list-style-type: none"><li data-bbox="506 668 2190 740">• The paper may be too damp. Try printing with a different batch of paper. Do not open packages of paper until necessary so that the paper does not absorb too much moisture.<li data-bbox="506 756 2190 876">• If background scatter occurs on an envelope, change the printing layout to avoid printing over areas that have overlapping seams on the reverse side. Printing on seams can cause problems. Or select Thick from the Printing Preferences window (see "Opening printing preferences" on page 57).<li data-bbox="506 892 2190 1011">• If background scatter covers the entire surface area of a printed page, adjust the print resolution through your software application or in Printing Preferences (see "Opening printing preferences" on page 57). Ensure the correct paper type is selected. For example: If Thicker Paper is selected, but Plain Paper actually used, an overcharging can occur causing this copy quality problem.<li data-bbox="506 1027 1872 1059">• If you are using a new toner cartridge, redistribute the toner first (see "Redistributing toner" on page 81).
<p data-bbox="51 1091 479 1163">Toner particles are around bold characters or pictures</p> 	<p data-bbox="506 1091 1249 1123">The toner might not adhere properly to this type of paper.</p> <ul data-bbox="506 1147 2190 1315" style="list-style-type: none"><li data-bbox="506 1147 2190 1219">• Change the printer option and try again. Go to Printing Preferences, click the Paper tab, and set the paper type to Recycled (see "Opening printing preferences" on page 57).<li data-bbox="506 1235 2190 1315">• Ensure the correct paper type is selected. For example: If Thicker Paper is selected, but Plain Paper actually used, an overcharging can occur causing this copy quality problem.

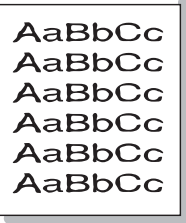
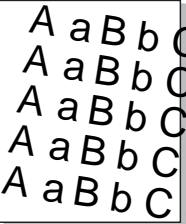
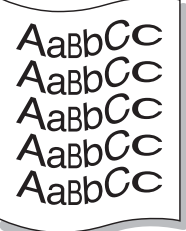

Printing quality problems

Condition	Suggested solutions
<p data-bbox="51 272 353 304">Misformed characters</p> 	<ul data-bbox="506 272 2069 304" style="list-style-type: none">• If characters are improperly formed and producing hollow images, the paper stock may be too slick. Try different paper.
<p data-bbox="51 608 203 639">Page skew</p> 	<ul data-bbox="506 608 1518 743" style="list-style-type: none">• Ensure that the paper is loaded properly.• Check the paper type and quality.• Ensure that the guides are not too tight or too loose against the paper stack.
<p data-bbox="51 951 226 983">Curl or wave</p> 	<ul data-bbox="506 951 1727 1086" style="list-style-type: none">• Ensure that the paper is loaded properly.• Check the paper type and quality. Both high temperature and humidity can cause paper curl.• Turn the stack of paper over in the tray. Also try rotating the paper 180° in the tray.

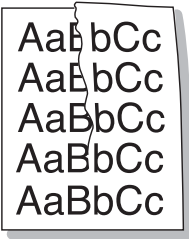
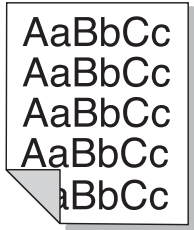
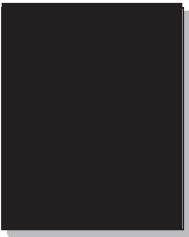
Printing quality problems

Condition	Suggested solutions
<p data-bbox="49 272 318 304">Wrinkles or creases</p> 	<ul data-bbox="504 272 1601 411" style="list-style-type: none">• Ensure that the paper is loaded properly.• Check the paper type and quality.• Turn the stack of paper over in the tray. Also try rotating the paper 180° in the tray.
<p data-bbox="49 619 414 651">Back of printouts are dirty</p> 	<ul data-bbox="504 619 1787 651" style="list-style-type: none">• Check for leaking toner. Clean the inside of the machine (see "Cleaning the machine" on page 91).
<p data-bbox="49 986 407 1018">Solid color or black pages</p> 	<ul data-bbox="504 986 2197 1125" style="list-style-type: none">• The imaging unit may not be installed properly. Remove the imaging unit and reinsert it.• The imaging unit may be defective. Remove the imaging unit and install a new one (see "Replacing the imaging unit" on page 87).• The machine may require repairing. Contact a service representative.

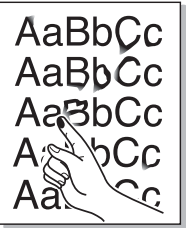
Printing quality problems

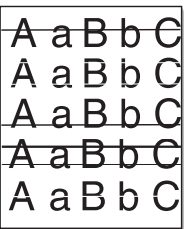
Condition	Suggested solutions
<p>Loose toner</p> 	<ul style="list-style-type: none">• Clean the inside of the machine (see "Cleaning the machine" on page 91).• Check the paper type and quality.• Remove the imaging unit and then, install a new one (see "Replacing the toner cartridge" on page 83). <p>If the problem persists, the machine may require repair. Contact a service representative.</p>
<p>Character voids</p> 	<p>Character voids are white areas within parts of characters that should be solid black:</p> <ul style="list-style-type: none">• You may be printing on the wrong surface of the paper. Remove the paper and turn it around.• The paper may not meet paper specifications.
<p>Horizontal stripes</p> 	<p>If horizontally aligned black streaks or smears appear:</p> <ul style="list-style-type: none">• The imaging unit may be installed improperly. Remove the imaging unit and reinsert it.• The imaging unit may be defective. Remove the imaging unit and install a new one (see "Replacing the imaging unit" on page 87). <p>If the problem persists, the machine may require repairing. Contact a service representative.</p>

Printing quality problems

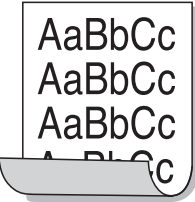
Condition	Suggested solutions
<p>Curl</p> 	<p>If the printed paper is curled or paper does not feed into the machine:</p> <ul style="list-style-type: none">• Turn the stack of paper over in the tray. Also try rotating the paper 180° in the tray.• Change the printer's paper option and try again. Go to Printing Preferences, click the Paper tab, and set type to Thin (see "Opening printing preferences" on page 57).
<ul style="list-style-type: none">• An unknown image repetitively appears on a few sheets• Loose toner• Light print or contamination occurs	<p>Your machine is probably being used at an altitude of 1,000 m (3,281 ft) or above.</p> <p>The high altitude may affect the print quality, such as loose toner or light imaging. Change the altitude setting for your machine (see "Altitude adjustment" on page 214).</p>

Copying problems

Condition	Suggested solutions
Copies are too light or too dark.	Adjust the darkness in copy feature to lighten or darken the backgrounds of copies (see "Changing the settings for each copy" on page 61).
Smears, lines, marks, or spots appear on copies.	<ul style="list-style-type: none">• If the defects are on the original, adjust darkness in copy feature to lighten the background of your copies.• Adjust background in copy setup removes the background color (see "Adjust Bkgd" on page 197).• If there are no defects on the original, clean the scan unit (see "Cleaning the scan unit" on page 94).
Copy image is skewed.	<ul style="list-style-type: none">• Ensure that the original is aligned with the registration guide.• The transfer roller may be dirty. Clean the inside of your machine (see "Cleaning the machine" on page 91).
Blank copies print out.	Ensure that the original is face down on the scanner glass or face up in the document feeder. If these steps do not correct the problem, contact a service representative.
Image rubs off the copy easily.	<ul style="list-style-type: none">• Replace the paper in the tray with paper from a new package.• In high humidity areas, do not leave paper in the machine for extended periods of time.
Frequent copy paper jams occur.	<ul style="list-style-type: none">• Fan the paper, then turn it over in the tray. Replace the paper in the tray with a fresh supply. Check/adjust the paper guides, if necessary.• Ensure that the paper is the proper type and weight (see "Print media specifications" on page 121).• Check for copy paper or pieces of copy paper remaining in the machine after a paper jam has been cleared.
Toner cartridge produces fewer copies than expected before running out of toner.	<ul style="list-style-type: none">• Your originals may contain pictures, solids, or heavy lines. For example, your originals may be forms, newsletters, books, or other documents that use more toner.• The scanner lid may be left open while copies are being made.• Turn the machine off and back on.

Scanning problems

Condition	Suggested solutions
The scanner does not work.	<ul style="list-style-type: none">• Make sure that you place the original to be scanned face down on the scanner glass, or face up in the document feeder (see "Loading originals" on page 51).• There may not be enough available memory to hold the document you want to scan. Try the Prescan function to see if that works. Try lowering the scan resolution rate.• Check that the machine printer cable is connected properly.• Make sure that the machine printer cable is not defective. Switch the printer cable with a known good cable. If necessary, replace the printer cable.• Check that the scanner is configured correctly. Check scan setting in the Easy Document Creator or the application you want to use to make certain that the scanner job is being sent to the correct port (for example, USB001).
The unit scans very slowly.	<ul style="list-style-type: none">• Check if the machine is printing received data. If so, scan the document after the received data has been printed.• Graphics are scanned more slowly than text.
Message appears on your computer screen: <ul style="list-style-type: none">• Device can't be set to the H/W mode you want.• Port is being used by another program.• Port is disabled.• Scanner is busy receiving or printing data. When the current job is completed, try again.• Invalid handle.• Scanning has failed.	<ul style="list-style-type: none">• There may be a copying or printing job in progress. Try your job again when that job is finished.• The selected port is currently being used. Restart your computer and try again.• The machine printer cable may be improperly connected or the power may be off.• The scanner driver is not installed or the operating environment is not set up properly.• Ensure that the machine is properly connected and the power is on, then restart your computer.• The USB cable may be improperly connected or the power may be off.

Faxing problems

Condition	Suggested solutions
The machine is not working, there is no display, or the buttons are not working.	<ul style="list-style-type: none">• Unplug the power cord and plug it in again.• Ensure that there is power being supplied to the electrical outlet.• Ensure that the power is turned on.
No dial tone.	<ul style="list-style-type: none">• Check that the phone line is properly connected (see "Rear view" on page 23).• Check that the phone socket on the wall is working by plugging in another phone.
The numbers stored in memory do not dial correctly.	Make sure that the numbers are stored in memory correctly. To check that, print an address book list.
The original does not feed into the machine.	<ul style="list-style-type: none">• Make sure that the paper is not wrinkled and you are inserting it in correctly. Check that the original is the right size, not too thick or thin.• Make sure that the document feeder is firmly closed.• The document feeder rubber pad may need to be replaced. Contact a service representative (see "Available maintenance parts" on page 78).
Faxes are not received automatically.	<ul style="list-style-type: none">• The receiving mode should be set to fax (see "Changing the receive modes" on page 245).• Make sure that there is paper in the tray (see "Print media specifications" on page 121).• Check to see if the display shows any error message. If it does, clear the problem.
The machine does not send.	<ul style="list-style-type: none">• Make sure that the original is loaded in the document feeder or on the scanner glass.• Check the fax machine you are sending to, to see if it can receive your fax.
The incoming fax has blank spaces or is of poor-quality.	<ul style="list-style-type: none">• The fax machine sending you the fax may be faulty.• A noisy phone line can cause line errors.• Check your machine by making a copy.• A toner cartridge has almost reached its estimated cartridge life. Replace the toner cartridge (see "Replacing the toner cartridge" on page 83).

Faxing problems

Condition	Suggested solutions
Some of the words on an incoming fax are stretched.	The fax machine sending the fax had a temporary document jam.
There are lines on the originals you sent.	Check your scan unit for marks and clean it (see "Cleaning the scan unit" on page 94).
The machine dials a number, but the connection with the other fax machine fails.	The other fax machine may be turned off, out of paper, or cannot answer incoming calls. Speak with the other machine operator and ask them to solve the problem on their side.
Faxes do not store in memory.	There may not be enough memory space to store the fax. If the display indicating the memory status shows, delete any faxes you no longer need from the memory, and then try to store the fax again. Call for service.
Blank areas appear at the bottom of each page or on other pages, with a small strip of text at the top.	You may have chosen the wrong paper settings in the user option setting. Check the paper size and type again.

Operating system problems

Common Windows problems

Condition	Suggested solutions
“File in Use” message appears during installation.	Exit all software applications. Remove all software from the startup group, then restart Windows. Reinstall the printer driver.
“General Protection Fault”, “Exception OE”, “Spool 32”, or “Illegal Operation” messages appear.	Close all other applications, reboot Windows and try printing again.
“Fail To Print”, “A printer timeout error occurred” message appear.	These messages may appear during printing. Just keep waiting until the machine finishes printing. If the message appears in ready mode or after printing has completed, check the connection and/or whether an error has occurred.



Refer to the Microsoft Windows User's Guide that came with your computer for further information on Windows error messages.

Operating system problems

Common Mac problems

Condition	Suggested solutions
The machine does not print PDF files correctly. Some parts of graphics, text, or illustrations are missing.	<p>Printing the PDF file as an image may enable the file to print. Turn on Print As Image from the Acrobat printing options.</p> <p> It will take longer to print when you print a PDF file as an image.</p>
Some letters are not displayed normally during cover page printing.	<p>Mac OS cannot create the font while printing the cover page. The English alphabet and numbers are displayed normally on the cover page.</p>
When printing a document in Mac with Acrobat Reader 6.0 or higher, colors print incorrectly.	<p>Make sure that the resolution setting in your machine driver matches the one in Acrobat Reader.</p>



Refer to the Mac User's Guide that came with your computer for further information on Mac error messages.

Operating system problems

Common Linux problems

Condition	Suggested solutions
The machine does not print.	<ul style="list-style-type: none">• Check if the printer driver is installed in your system. Open Unified Driver Configurator and switch to the Printers tab in the Printers configuration window to look at the list of available machines. Make sure that your machine is displayed on the list. If not, open Add new printer wizard to set up your device.• Check if the machine is started. Open Printers configuration and select your machine from the printers list. Look at the description in the Selected printer pane. If its status contains Stopped, press the Start button. Normal operation of the machine should be restored. The “stopped” status might be activated when some problems in printing occur.• Check if your application has special print options such as “-oraw”. If “-oraw” is specified in the command line parameter, then remove it to print properly. For Gimp front-end, select “print” -> “Setup printer” and edit the command line parameter in the command item.
Some color images come out all black.	<p>This is a known bug in Ghostscript (until GNU Ghostscript version 7.05) when the base color space of the document is indexed color space and it is converted through CIE color space. Because Postscript uses CIE color space for Color Matching System, you should upgrade Ghostscript on your system to at least GNU Ghostscript version 7.06 or later. You can find recent Ghostscript versions at www.ghostscript.com.</p>
Some color images come out in unexpected color.	<p>This is a known bug in Ghostscript (until GNU Ghostscript version 7.xx) when the base color space of the document is indexed RGB color space and it is converted through CIE color space. Because Postscript uses CIE color space for Color Matching System, you should upgrade Ghostscript on your system to at least GNU Ghostscript version 8.xx or later. You can find recent Ghostscript versions at www.ghostscript.com.</p>
The machine does not print whole pages, and output is printed on half the page.	<p>It is a known problem that occurs when a color machine is used on version 8.51 or earlier of Ghostscript, 64-bit Linux OS, and has been reported to bugs.ghostscript.com as Ghostscript Bug 688252. The problem is solved in AFPL Ghostscript v. 8.52 or above. Download the latest version of AFPL Ghostscript from http://sourceforge.net/projects/ghostscript/ and install it to solve this problem.</p>

Operating system problems

Condition	Suggested solutions
I cannot scan via Gimp Front-end.	<p>Check if Gimp Front-end has Xsane:Device dialog. on the Acquire menu. If not, you should install Xsane plug-in for Gimp on the your computer. You can find Xsane plug-in package for Gimp on Linux distribution CD or Gimp home page. For the detailed information, refer to the Help for Linux distribution CD or Gimp Front-end application.</p> <p>If you wish to use another kind of scan application, refer to application's Help.</p>
"Cannot open port device file" error message appears when printing a document.	<p>Avoid changing print job parameters (e.g., via LPR GUI) while a print job is in progress. Known versions of CUPS server break the print job whenever print options are changed and then try to restart the job from the beginning. Since Unified Linux Driver locks the port while printing, the abrupt termination of the driver keeps the port locked and unavailable for subsequent print jobs. If this situation occurs, try to release the port by selecting Release port in the Port configuration window.</p>
The machine does not appear on the scanners list.	<ul style="list-style-type: none">• Ensure your machine is attached to your computer, connected properly via the USB port, and is turned on.• Ensure the scanner driver for your machine is installed in your system. Open Unified Linux Driver configurator, switch to Scanners configuration, then press Drivers. Make sure that driver with a name corresponding to your machine's name is listed in the window.• Ensure the port is not busy. Since functional components of machine (printer and scanner) share the same I/O interface (port), the situation of simultaneous access of different user applications to the same port is possible. To avoid possible conflicts, only one of them at a time is allowed to gain control over the device. The other user will encounter "device busy" response. This usually happens when starting a scan procedure. An appropriate message box appears. <p>To identify the source of the problem, open the Ports configuration and select the port assigned to your scanner, port's symbol /dev/mfp0 corresponds to LP:0 designation displayed in the scanners' options, /dev/mfp1 relates to LP:1, and so on. USB ports start at /dev/mfp4, so scanner on USB:0 relates to /dev/mfp4 respectively and so forth sequentially. In the Selected port pane, you can see if the port is occupied by another application. If this is the case, you should either wait for completion of the current job or press the Release port button, if you are sure that the present port application is not functioning properly.</p>
The machine does not scan.	<ul style="list-style-type: none">• Ensure a document is loaded into the machine, ensure your machine is connected to the computer.• If there is an I/O error while scanning.

Operating system problems



Refer to the Linux User's Guide that came with your computer for further information on Linux error messages.

Common PostScript problems

The following situations are PS language specific and may occur when several printer languages are used.

Problem	Possible cause	Solution
The PostScript file cannot be printed	The PostScript driver may not be installed correctly.	<ul style="list-style-type: none">• Install the PostScript driver (see "Software Installation" on page 145).• Print a configuration page and verify that the PS version is available for printing.• If the problem persists, contact a service representative.
Limit Check Error report prints	The print job was too complex.	You might need to reduce the complexity of the page or install more memory.
A PostScript error page prints	The print job may not be PostScript.	Make sure that the print job is a PostScript job. Check to see whether the software application expected a setup or PostScript header file to be sent to the machine.
The optional tray is not selected in the driver	The printer driver has not been configured to recognize the optional tray.	Open the driver properties, select the Device Options tab, and set the tray option.
When printing a document in Mac with Acrobat Reader 6.0 or higher, colors print incorrectly	The resolution setting in the printer driver may not be matched with the one in Acrobat Reader.	Make sure that the resolution setting in your printer driver matches the one in Acrobat Reader.



Quick Guide for Windows 8 User

This chapter will outline features specific to the Windows 8 OS. This chapter applies to users running Windows 8.

- **Understanding the screen** 296
- **System requirements** 297
- **Installing the driver locally** 298
- **Installing the driver over the network** 300
- **Installing the driver over the wireless network** 302
- **Uninstalling the driver** 304
- **Using Samsung Printer Experience** 305
- **Accessing management tools** 310
- **Installing accessories** 311
- **Troubleshooting** 312



- The screen may appear somewhat different depending on the model or interface in use.
- Since this guide has been prepared based on Windows 8, some of the instructions may differ depending on the version. It may also be modified without prior notice.

Understanding the screen

Windows 8 provides both the new **Start** screen mode and the **Desktop** screen mode of the existing OS.

Start Screen

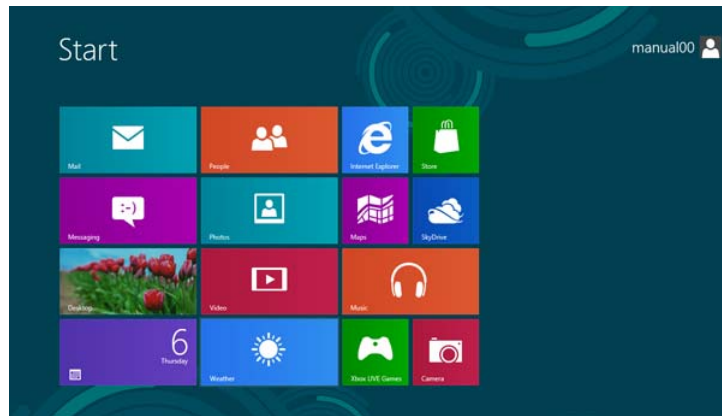

Desktop Screen



System requirements

Operating system	Requirement (recommended)		
	CPU	RAM	Free HDD Space
Windows® 8	Intel® Pentium® IV 1 GHz 32-bit or 64-bit processor or higher	1 GB (2 GB)	16 GB
	<ul style="list-style-type: none">• Support for DirectX® 9 graphics with 128 MB memory (to enable the Aero theme).• DVD-R/W Drive		

Installing the driver locally

A locally connected machine is a machine directly attached to your computer using the cable.



- Only use a USB cable no longer than 3 meters (118 inches).
- **Samsung Printer Experience** app can only be used in the **Start** screen when V4 driver is installed. The V4 driver is automatically downloaded from the Windows Update if your computer is connected to the Internet. If not, you can manually download the V4 driver from Samsung website, www.samsung.com > find your product > Support or downloads.
- If you install the driver using the supplied software CD, V4 driver is not installed. If you want to use the V4 driver in the **Desktop** screen, you can download from the Samsung website, www.samsung.com > find your product > Support or downloads.

From the Start Screen

- 1 Make sure that your computer is connected to the Internet and powered on.
- 2 Make sure that the machine is powered on.
- 3 Connect the computer and the machine with a USB cable.
The driver is automatically installed from the **Windows Update**.



- If you want to install Samsung's printer management tools, you need to install them using the supplied software CD (see "From the Desktop Screen" on page 298).
- You can download Samsung Printer Experience app from the **Windows Store**. You need have a Microsoft account to use the Windows **Store**.
 - 1 From **Charms**, select **Search**.
 - 2 Click **Store**.
 - 3 Search and click **Samsung Printer Experience**.
 - 4 Click **Install**.

From the Desktop Screen



- If you install the driver using the supplied software CD, you cannot use the installed driver from the **Start** screen.

Installing the driver locally

- 1 Insert the supplied software CD into your CD-ROM drive.

If the installation window does not appear, from **Charms**, select **Search** > **Apps** and search for **Run**. Type in X:\Setup.exe, replacing "X" with the letter that represents your CD-ROM drive and click **OK**.



If "Tap to choose what happens with this disc." pop-up window appears, click the window and select **Run Setup.exe**.

- 2 Read and accept **The software End User License Agreement** and **Using Enhanced Features and Participating in Printer Usage Information Collection Program** (optional). Then, click **Next**.

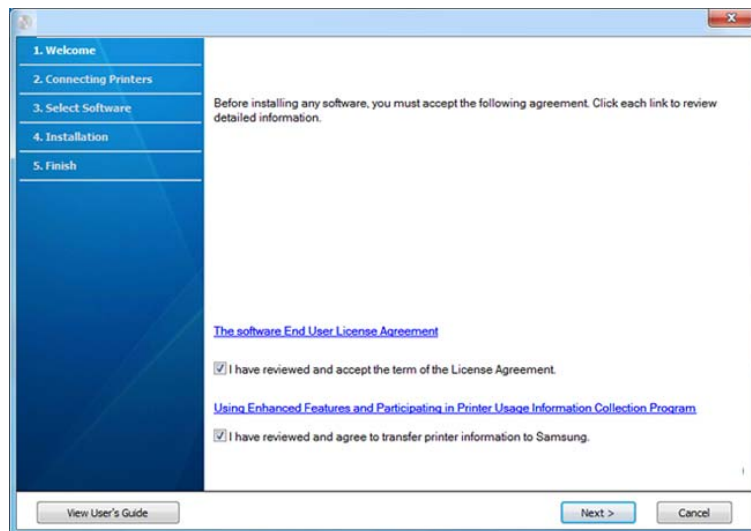

- 3 Follow the instructions in the installation window.

Installing the driver over the network



- Some features and optional goods may not be available depending on model or country (see "Features by models" on page 7).
- Machine that do not support networking will not be able to use this feature (see "Rear view" on page 23).
- **Samsung Printer Experience** app can only be used in the **Start** screen when V4 driver is installed. The V4 driver is automatically downloaded from the Windows Update if your computer is connected to the Internet. If not, you can manually download the V4 driver from Samsung website, www.samsung.com >find your product > Support or downloads.
- If you install the driver using the supplied software CD, V4 driver is not installed. If you want to use the V4 driver in the **Desktop** screen, you can download from the Samsung website, www.samsung.com >find your product > Support or downloads.



- You can print a Network Configuration Report from the machine's control panel that will show the current machine's host name (see "Printing a network configuration report" on page 179).
- If you want to install Samsung's printer management tools, you need to install them using the supplied software CD (see "From the Desktop Screen" on page 298).
- You can download Samsung Printer Experience app from the **Windows Store**. You need have a Microsoft account to use the Windows **Store**.
 - 1 From **Charms**, select **Search**.
 - 2 Click **Store**.
 - 3 Search and click **Samsung Printer Experience**.
 - 4 Click **Install**.

5 The driver is automatically installed from the **Windows Update**.

From the Start Screen

- 1 Make sure that the machine is connected to the network and powered on. Also, your machine's IP address should have been set (see "Setting IP address" on page 152).
- 2 From **Charms**, select **Settings** > **Change PC settings** > **Devices**.
- 3 Click **Add a device**.
Discovered machines will be shown on the screen.
- 4 Click the model name or host name you wish to use.

From the Desktop Screen



If you install the driver using the supplied software CD, you cannot use the installed driver from the **Start** screen.

Installing the driver over the network

- 1 Make sure that the machine is connected to the network and powered on. Also, your machine's IP address should have been set (see "Setting IP address" on page 152).
- 2 Insert the supplied software CD into your CD-ROM drive.
If the installation window does not appear, from **Charms**, select **Search** > **Apps** and search for **Run**. Type in X:\Setup.exe, replacing "X" with the letter that represents your CD-ROM drive and click **OK**.

 If "Tap to choose what happens with this disc." pop-up window appears, click the window and select **Run Setup.exe**.

- 3 Read and accept **The software End User License Agreement** and **Using Enhanced Features and Participating in Printer Usage Information Collection Program** (optional). Then, click **Next**.

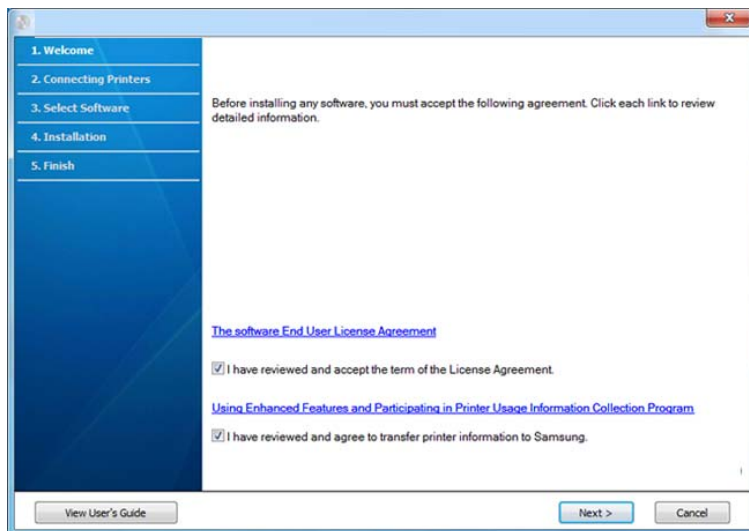

- 4 Select **Network connection** on the **Printer Connection Type** screen.
- 5 If the **Connect Device** window appears, check that the machine is connected to your network. Then, click **Next**.

 The firewall software might be blocking network communication. Before connecting the device to the network, disable the computer's firewall.

- 6 Discovered machines will be shown on the screen. Select the one you wish to use and click **OK**.
- 7 Follow the instructions in the installation window.

Installing the driver over the wireless network



- **Samsung Printer Experience** app can only be used in the **Start** screen when V4 driver is installed. The V4 driver is automatically downloaded from the Windows Update if your computer is connected to the Internet. If not, you can manually download the V4 driver from Samsung website, www.samsung.com >find your product > Support or downloads.
- If you install the driver using the supplied software CD, V4 driver is not installed. If you want to use the V4 driver in the **Desktop** screen, you can download from the Samsung website, www.samsung.com >find your product > Support or downloads.
- You must set up for wireless network using the supplied software CD in Desktop screen mode.
- If you are using a computer without a CD-ROM, you can set up the wireless network from the machine's control panel (see "Wireless network setup" on page 164).

From the Start Screen

- 1 After completing the wireless network connection, you need to install a machine driver to print from an application.
- 2 From **Charms**, select **Settings** > **Change PC settings** > **Devices**.
- 3 Click **Add a device**.
Discovered machines will be shown on the screen.
- 4 Click the model name or host name you wish to use.



You can print a Network Configuration Report from the machine's control panel that will show the current machine's host name (see "Printing a network configuration report" on page 179).

5 The driver is automatically installed from the **Windows Update**.



- If you want to install Samsung's printer management tools, you need to install them using the supplied software CD (see "From the Desktop Screen" on page 298).
- You can download Samsung Printer Experience app from the **Windows Store**. You need have a Microsoft account to use the Windows **Store**.
 - 1 From **Charms**, select **Search**.
 - 2 Click **Store**.
 - 3 Search and click **Samsung Printer Experience**.
 - 4 Click **Install**.

From the Desktop Screen



If you install the driver using the supplied software CD, you cannot use the installed driver from the **Start** screen.

Installing the driver over the wireless network

- 1 Turn on your computer, access point, and machine.
- 2 Insert the supplied software CD into your CD-ROM drive.
If the installation window does not appear, from **Charms**, select **Search** > **Apps** and search for **Run**. Type in X:\Setup.exe, replacing "X" with the letter that represents your CD-ROM drive and click **OK**.

 If "Tap to choose what happens with this disc." pop-up window appears, click the window and select **Run Setup.exe**.

- 3 Read and accept **The software End User License Agreement** and **Using Enhanced Features and Participating in Printer Usage Information Collection Program** (optional). Then, click **Next**.

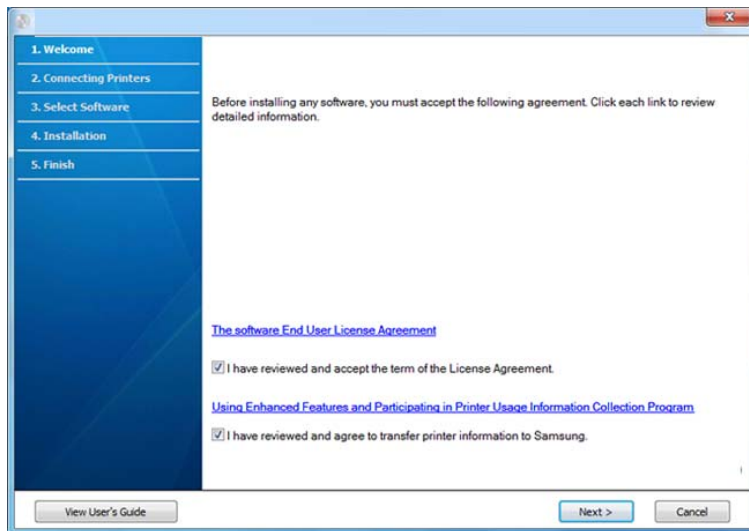

- 4 Select **Configure the wireless network connection using USB cable** on the **Printer Connection Type** screen. Then, click **Next**.
- 5 Follow the instructions in the installation window.

 For wireless set up or driver installation, refer to the wireless network setup chapter (see "Wireless network setup" on page 164).

Uninstalling the driver

From the Start Screen

- 1 Make sure that the machine is connected to your computer and powered on.
- 2 Click on the **Uninstall Samsung Printer Software** tile in the **Start** screen.
- 3 Follow the instructions in the window.



- If you cannot find a Samsung Printer Software tile, uninstall from the desktop screen mode (see "From the Desktop Screen" on page 304).
- If you want to uninstall Samsung's printer management tools, from the **Start** screen, right-click the app > **Uninstall** > right-click the program you want to delete > **Uninstall** and follow the instruction in the window.

From the Desktop Screen

- 1 From Charms, select **Search** > **Apps**.
- 2 Search and click **Control Panel**.
- 3 Click **Programs and Features**.
- 4 Right-click the driver you want to uninstall and select **Uninstall**.

- 5 Follow the instructions in the window.

Using Samsung Printer Experience

Samsung Printer Experience is a Samsung application that combines Samsung machine settings and machine management into one location. You can set device settings, order supplies, open troubleshooting guides, visit Samsung's web site, and check connected machine information. This application will be automatically downloaded from the Windows **Store** if the machine is connected to a computer with an Internet connection.

Understanding the Samsung Printer Experience

To open the application,

From the **Start** screen, select the **Samsung Printer Experience** () tile.

The **Samsung Printer Experience** interface comprises various useful features as described in the following table:



The screenshot may differ depending on the model you are using.

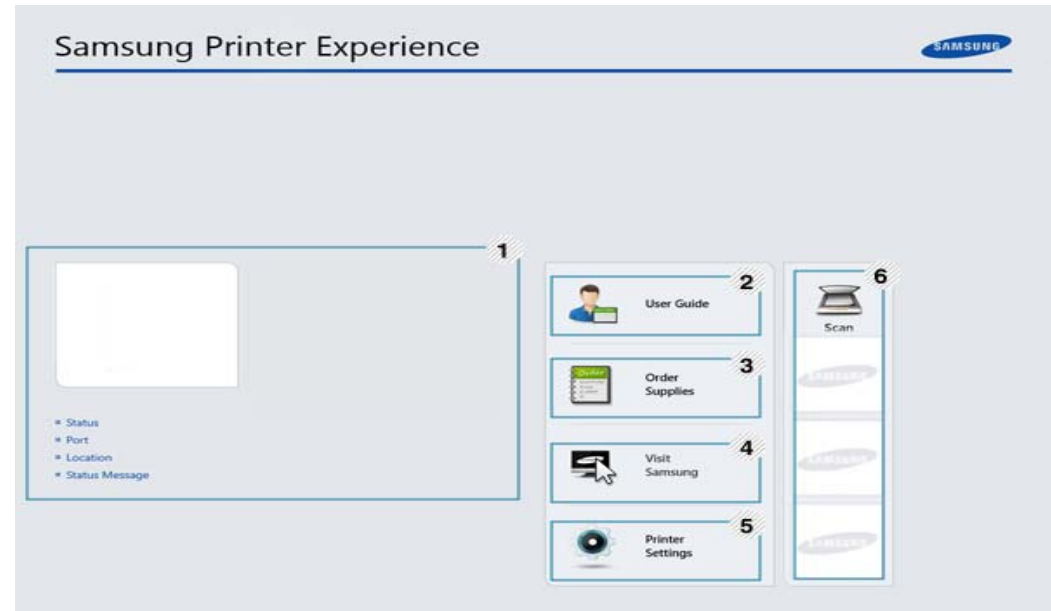

1	Printer Information	This area gives you general information about your machine. You can check information, such as the machine's status, location, IP address, and remaining toner level.
---	----------------------------	---

Using Samsung Printer Experience

2	User Guide	<p>You can view the online User's Guide. You need to be connected to the Internet to use this feature.</p> <div> This button opens the Troubleshooting Guide when an error occurs. You can directly open the troubleshooting section in the user's guide.</div>
3	Order Supplies	<p>Click on this button to order replacement toner cartridges online. You need to be connected to the Internet to use this feature.</p>
4	Visit Samsung	<p>Links to Samsung printer website. You need to be connected to the Internet to use this feature.</p>
5	Printer Settings	<p>You can configure various machine settings such as machine setup, paper, layout, emulation, networking, and print information through SyncThru™ Web Service. Your machine needs to be connected to a network. This button will be disabled if your machine is connected via USB cable.</p>
6	Device List & Latest Scanned Image	<p>The scan list displays devices that supports Samsung Printer Experience. Under the device, you can see the latest scanned images. Your machine needs to be connected to a network to scan from here.</p> <p>This section is for the users with multi-functional printers.</p>

Printing from Windows 8

This section explains common printing tasks from the **Start** screen.

Basic printing

- 1 Open the document to print.
- 2 From the **Charms**, select **Devices**.
- 3 Select your printer from the list
- 4 Select the printer settings, such as the number of copies and orientation.

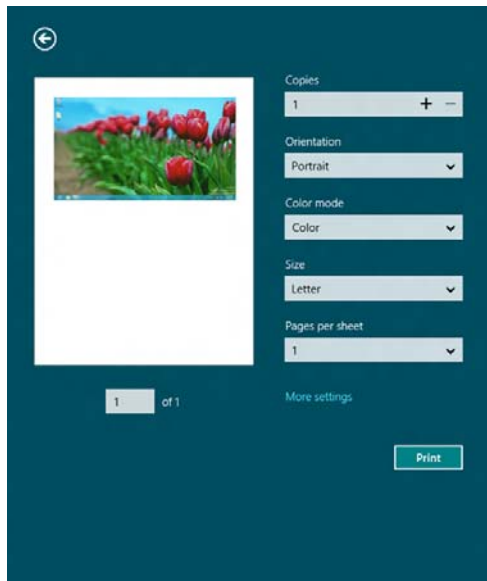

Using Samsung Printer Experience

- 5 Click the **Print** button to start the print job.



Cancelling a print job

If the printing job is waiting in the print queue or print spooler, cancel the job as follows:

- You can access this window by simply double-clicking the machine icon () in the Windows task bar.
- You can also cancel the current job by pressing  (**Cancel** or **Stop/Clear**) button on the control panel.

Opening more settings



The screen may appear somewhat different depending on the model or options.

You can set up more printing parameters.

- 1 Open the document you want to print.
- 2 From the **Charms**, select **Devices**.
- 3 Select your printer from the list
- 4 Click **More settings**.

Basic tab

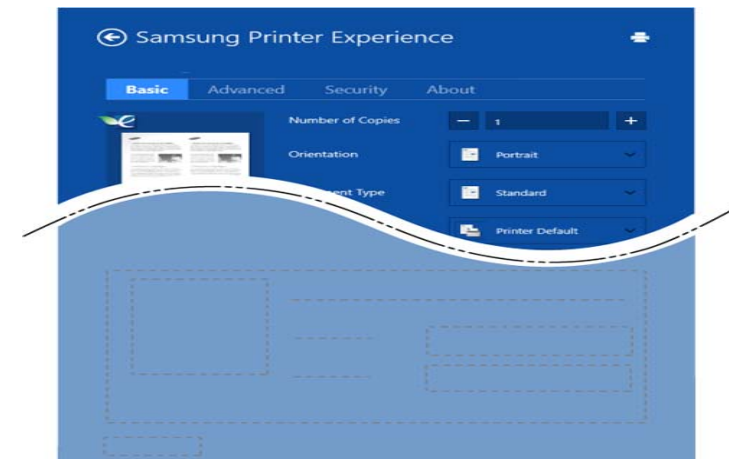

Using Samsung Printer Experience

Basic

This option allows you to choose the basic printing settings such as copies, orientation, and document type.

Eco settings

This option allows you to choose multiple pages per side to save media.

Advanced tab

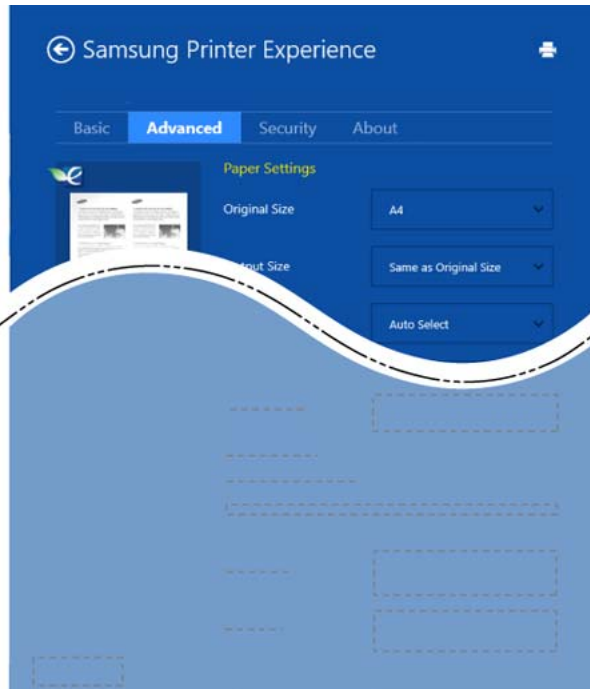

Paper settings

This option allows you to set the basic paper handling specifications.

Layout settings

This option allows you to set the various ways to layout your documents.

Security tab



Some features may not be available depending on the model or options. If this tab is not shown or disabled, it means that these features are not supported.

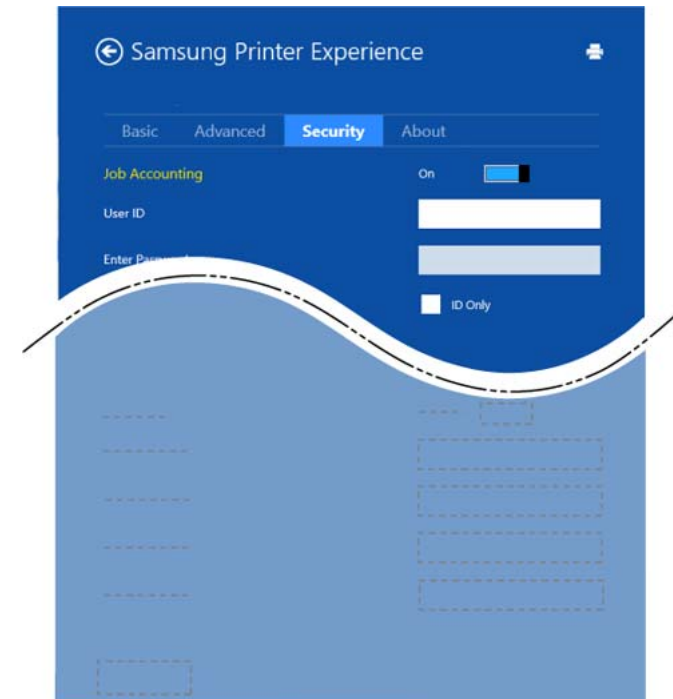

Job Accounting

Using Samsung Printer Experience

This option allows you to print with the given permission.

Confidential Printing

This option is used for printing confidential documents. You need to enter a password to print using it.

Scanning from Windows 8





This section is for the users with multi-functional printers.

Scanning with your machine lets you turn pictures and text into digital files that can be stored on your computer.

Scanning from Samsung Printer Experience

The most frequently used printing menus are displayed for quick scanning.

- 1 Place a single document face down on the document glass, or load the documents face up into the document feeder (see "Loading originals" on page 51).
- 2 Click the **Samsung Printer Experience** tile on the **Start** screen.
- 3 Click **Scan** ().

- 4 Set up the scanning parameters such as image type, document size, and resolution.
- 5 Click **Prescan** () to check the image.
- 6 Adjust the prescanned image with scanning operation functions such as rotate and mirror.
- 7 Click **Scan** () and save the image.



- When you place the originals in the ADF (or DADF), **Prescan** () is not available.
- You can skip step 5, if the **Prescan** option is selected.

Accessing management tools

Samsung provides a variety of management tools for Samsung printers. For more information on each tool, refer to "Useful Management Tools" on page 249.

- 1 From the **Charms**, select **Search > Apps**.
- 2 Find **Samsung Printers**.
- 3 Under **Samsung Printers**, you can see installed management tools.
- 4 Click the management tool you want to use.



After installing the driver, for some management tools, you can access them directly from the **Start** screen by clicking on the corresponding tile.

Installing accessories

When you install optional devices, such as optional tray, memory, etc, this machine automatically detects and sets the optional devices. If you cannot use the optional devices you installed in this driver, you can set the optional devices in **Device Settings** to use.

- 1 From the **Charms**, select **Search > Settings**.
- 2 Search for **Devices and Printers**.
- 3 Right-click on your printer icon and select **Printer properties**.



If **Printer properties** item has a ► mark, you can select other printer drivers connected with the selected printer.

- 4 Select **Device Settings**.



The **Printer properties** window may differ depending on the driver or operating system you are using.

- 5 Select the appropriate option.
- 6 Click **OK** until you exit the **Printer properties** window.

Troubleshooting

Problem	Suggested Solutions
Samsung Printer Experience is not shown when you click more settings .	Samsung Printer Experience is not installed. Download the app. from the Windows Store and install it.
Machine information is not displayed when you click the device in the Devices and Printers .	Check the Printer properties . Click the Ports tab. (Control Panel > Devices and Printers > Right-click on your printer icon and select Printer properties)
The error related toast message pops up.	If the port is set to File or LPT, uncheck them and select TCP/IP, USB, or WSD.

Contact SAMSUNG worldwide

If you have any comments or questions regarding Samsung products, contact the Samsung customer care center.

Country/Region	Customer Care Center	Web Site
ALBANIA	42 27 5755	www.samsung.com
ANGOLA	91-726-7864	www.samsung.com
ARGENTINE	0800-333-3733	www.samsung.com
ARMENIA	0-800-05-555	www.samsung.com
AUSTRALIA	1300 362 603	www.samsung.com
AUSTRIA	0810-SAMSUNG (7267864, € 0.07/min)	www.samsung.com
AZERBAIJAN	088-55-55-555	www.samsung.com
BAHRAIN	8000-4726	www.samsung.com/ae (English) www.samsung.com/ae_ar (Arabic)
BELARUS	810-800-500-55-500	www.samsung.com
BELGIUM	02-201-24-18	www.samsung.com/be (Dutch) www.samsung.com/be_fr (French)
BOLIVIA	800-10-7260	www.samsung.com

Country/Region	Customer Care Center	Web Site
BOSNIA	05 133 1999	www.samsung.com
BOTSWANA	0800-726-000	www.samsung.com
BRAZIL	0800-124-421 4004-0000	www.samsung.com
BULGARIA	07001 33 11 , normal tariff	www.samsung.com
CAMEROON	7095-0077	www.samsung.com
CANADA	1-800-SAMSUNG (726-7864)	www.samsung.com/ca (English) www.samsung.com/ca_fr (French)
CHILE	800-SAMSUNG (726-7864) From mobile 02-482 82 00	www.samsung.com
CHINA	400-810-5858	www.samsung.com
COLOMBIA	01-8000112112	www.samsung.com
COSTA RICA	0-800-507-7267	www.samsung.com/latin_en (English) www.samsung.com/latin (Spanish)
COTE D'IVOIRE	8000 0077	www.samsung.com
CROATIA	062 SAMSUNG (062 726 7864)	www.samsung.com

Contact SAMSUNG worldwide

Country/Region	Customer Care Center	Web Site
CYPRUS	8009 4000 only from landline	www.samsung.com
CZECH REPUBLIC	800-SAMSUNG (800-726786)	www.samsung.com
	Samsung Electronics Czech and Slovak, s.r.o., Oasis Florenc, Sokolovská 394/17, 180 00, Praha 8	
DENMARK	70 70 19 70	www.samsung.com
DOMINICA	1-800-751-2676	www.samsung.com/ latin_en (English)
		www.samsung.com/ latin (Spanish)
ECUADOR	1-800-10-7267	www.samsung.com/ latin_en (English)
		www.samsung.com/ latin (Spanish)
EGYPT	08000-726786	www.samsung.com
EIRE	0818 717100	www.samsung.com
EL SALVADOR	800-6225	www.samsung.com/ latin_en (English)
		www.samsung.com/ latin (Spanish)
ESTONIA	800-7267	www.samsung.com
FINLAND	09 85635050	www.samsung.com

Country/Region	Customer Care Center	Web Site
FRANCE	01 48 63 00 00	www.samsung.com
GERMANY	0180 5 SAMSUNG bzw. 0180 5 7267864* (*0,14 €/Min. aus dem dt. Festnetz, aus dem Mobilfunk max. 0,42 €/Min.)	www.samsung.com
GEORGIA	0-800-555-555	www.samsung.com
GHANA	0800-10077	www.samsung.com
	0302-200077	
GREECE	80111-SAMSUNG (80111 726 7864) only from land line	www.samsung.com
	(+30) 210 6897691 from mobile and land line	
GUATEMALA	1-800-299-0013	www.samsung.com/ latin_en (English)
		www.samsung.com/ latin (Spanish)
HONDURAS	800-27919267	www.samsung.com/ latin_en (English)
		www.samsung.com/ latin (Spanish)

Contact SAMSUNG worldwide

Country/Region	Customer Care Center	Web Site
HONG KONG	(852) 3698-4698	www.samsung.com/hk (Chinese) www.samsung.com/ hk_en/ (English)
HUNGARY	06-80-SAMSUNG (726-7864)	www.samsung.com
INDIA	1800 1100 11 3030 8282 1800 3000 8282 1800 266 8282	www.samsung.com
INDONESIA	0800-112-8888 021-5699-7777	www.samsung.com
IRAN	021-8255	www.samsung.com
ITALY	800-SAMSUNG (726-7864)	www.samsung.com
JAMAICA	1-800-234-7267	www.samsung.com
JAPAN	0120-327-527	www.samsung.com
JORDAN	800-22273 065777444	www.samsung.com
KAZAKHSTAN	8-10-800-500-55-500 (GSM:7799)	www.samsung.com
KENYA	0800 724 000	www.samsung.com
KOSOVO	+381 0113216899	www.samsung.com

Country/Region	Customer Care Center	Web Site
KUWAIT	183-2255	www.samsung.com/ae (English) www.samsung.com/ ae_ar (Arabic)
KYRGYZSTAN	00-800-500-55-500	www.samsung.com
LATVIA	8000-7267	www.samsung.com
LITHUANIA	8-800-77777	www.samsung.com
LUXEMBURG	261 03 710	www.samsung.com
MALAYSIA	1800-88-9999	www.samsung.com
MACEDONIA	023 207 777	www.samsung.com
MEXICO	01-800-SAMSUNG (726-7864)	www.samsung.com
MOLDOVA	0-800-614-40	www.samsung.com
MONGOLIA	+7-800-555-55-55	www.samsung.com
MONTENEGRO	020 405 888	www.samsung.com
MOROCCO	080 100 2255	www.samsung.com
NAMIBIA	8197267864	www.samsung.com
NETHERLANDS	0900-SAMSUNG (0900-7267864) (€ 0,10/min)	www.samsung.com
NEW ZEALAND	0800 SAMSUNG (0800 726 786)	www.samsung.com

Contact SAMSUNG worldwide

Country/Region	Customer Care Center	Web Site
NICARAGUA	00-1800-5077267	www.samsung.com/ latin_en (English) www.samsung.com/ latin (Spanish)
NIGERIA	0800-726-7864	www.samsung.com
NORWAY	815 56480	www.samsung.com
OMAN	800-SAMSUNG (726-7864)	www.samsung.com/ae (English) www.samsung.com/ ae_ar (Arabic)
PANAMA	800-7267	www.samsung.com/ latin_en (English) www.samsung.com/ latin (Spanish)
PERU	0-800-777-08	www.samsung.com
PHILIPPINES	1-800-10-SAMSUNG(726-7864) for PLDT 1-800-3-SAMSUNG(726-7864) for Digitel 1-800-8-SAMSUNG(726-7864) for Globe 02-5805777	www.samsung.com

Country/Region	Customer Care Center	Web Site
POLAND	0 801-1 SAMSUNG (172-678) +48 22 607-93-33	www.samsung.com
PORTUGAL	808 20-SAMSUNG (808 20 7267)	www.samsung.com
PUERTO RICO	1-800-682-3180	www.samsung.com
ROMANIA	08008 SAMSUNG (08008 726 7864) TOLL FREE No.	www.samsung.com
RUSSIA	8-800-555-55-55	www.samsung.com
SAUDI ARABIA	9200-21230	www.samsung.com/ae (English) www.samsung.com/ ae_ar (Arabic)
SENEGAL	800-00-0077	www.samsung.com
SERBIA	0700 SAMSUNG (0700 726 7864)	www.samsung.com
SINGAPORE	1800-SAMSUNG (726-7864)	www.samsung.com
SLOVAKIA	0800-SAMSUNG (0800-726-7864)	www.samsung.com
SOUTH AFRICA	0860-SAMSUNG (726-7864)	www.samsung.com
SPAIN	902-1-SAMSUNG(902 172 678)	www.samsung.com
SWEDEN	0771 726 7864 (SAMSUNG)	www.samsung.com

Contact SAMSUNG worldwide

Country/Region	Customer Care Center	Web Site
SWITZERLAND	0848-SAMSUNG (7267864, CHF 0.08/min)	www.samsung.com/ch (German) www.samsung.com/ch_fr(French)
TADJIKISTAN	8-10-800-500-55-500	www.samsung.com
TAIWAN	0800-329-999 0266-026-066	www.samsung.com
TANZANIA	0685 88 99 00	www.samsung.com
THAILAND	1800-29-3232 02-689-3232	www.samsung.com
TRINIDAD & TOBAGO	1-800-SAMSUNG (726-7864)	www.samsung.com
TURKEY	444 77 11	www.samsung.com
U.A.E	800-SAMSUNG (726-7864)	www.samsung.com
UGANDA	0800-300 300	www.samsung.com
U.K	0330 SAMSUNG (7267864)	www.samsung.com
U.S.A	1-800-SAMSUNG (726-7864)	www.samsung.com
UKRAINE	0-800-502-000	www.samsung.com/ua (Ukrainian) www.samsung.com/ua_ru (Russian)

Country/Region	Customer Care Center	Web Site
UZBEKISTAN	8-10-800-500-55-500	www.samsung.com
VENEZUELA	0-800-100-5303	www.samsung.com
VIETNAM	1 800 588 889	www.samsung.com
ZAMBIA	211350370	www.samsung.com



The following glossary helps you get familiar with the product by understanding the terminologies commonly used with printing as well as mentioned in this user's guide.

802.11

802.11 is a set of standards for wireless local area network (WLAN) communication, developed by the IEEE LAN/MAN Standards Committee (IEEE 802).

802.11b/g/n

802.11b/g/n can share same hardware and use the 2.4 GHz band. 802.11b supports bandwidth up to 11 Mbps, 802.11n supports bandwidth up to 150 Mbps. 802.11b/g/n devices may occasionally suffer interference from microwave ovens, cordless telephones, and Bluetooth devices.

Access point

Access Point or Wireless Access Point (AP or WAP) is a device that connects wireless communication devices together on wireless local area networks (WLAN), and acts as a central transmitter and receiver of WLAN radio signals.

ADF

An Automatic Document Feeder (ADF) is a scanning unit that will automatically feed an original sheet of paper so that the machine can scan some amount of the paper at once.

AppleTalk

AppleTalk is a proprietary suite of protocols developed by Apple, Inc for computer networking. It was included in the original Mac (1984) and is now deprecated by Apple in favor of TCP/IP networking.

BIT Depth

A computer graphics term describing the number of bits used to represent the color of a single pixel in a bitmapped image. Higher color depth gives a broader range of distinct colors. As the number of bits increases, the number of possible colors becomes impractically large for a color map. 1-bit color is commonly called as monochrome or black and white.

BMP

A bitmapped graphics format used internally by the Microsoft Windows graphics subsystem (GDI), and used commonly as a simple graphics file format on that platform.

BOOTP

Bootstrap Protocol. A network protocol used by a network client to obtain its IP address automatically. This is usually done in the bootstrap process of computers or operating systems running on them. The BOOTP servers assign the IP address from a pool of addresses to each client. BOOTP enables 'diskless workstation' computers to obtain an IP address prior to loading any advanced operating system.

CCD

Charge Coupled Device (CCD) is a hardware which enables the scan job. CCD Locking mechanism is also used to hold the CCD module to prevent any damage when you move the machine.

Collation

Collation is a process of printing a multiple-copy job in sets. When collation is selected, the device prints an entire set before printing additional copies.

Control Panel

A control panel is a flat, typically vertical, area where control or monitoring instruments are displayed. They are typically found in front of the machine.

Coverage

It is the printing term used for a toner usage measurement on printing. For example, 5% coverage means that an A4 sided paper has about 5% image or text on it. So, if the paper or original has complicated images or lots of text on it, the coverage will be higher and at the same time, a toner usage will be as much as the coverage.

CSV

Comma Separated Values (CSV). A type of file format, CSV is used to exchange data between disparate applications. The file format, as it is used in Microsoft Excel, has become a de facto standard throughout the industry, even among non-Microsoft platforms.

DADF

A Duplex Automatic Document Feeder (DADF) is a scanning unit that will automatically feed and turn over an original sheet of paper so that the machine can scan on both sides of the paper.

Default

The value or setting that is in effect when taking a printer out of its box state, reset, or initialized.

DHCP

A Dynamic Host Configuration Protocol (DHCP) is a client-server networking protocol. A DHCP server provides configuration parameters specific to the DHCP client host requesting, generally, information required by the client host to participate on an IP network. DHCP also provides a mechanism for allocation of IP addresses to client hosts.

DIMM

Dual Inline Memory Module (DIMM), a small circuit board that holds memory. DIMM stores all the data within the machine like printing data, received fax data.

DLNA

The Digital Living Network Alliance (DLNA) is a standard that allows devices on a home network to share information with each other across the network.

DNS

The Domain Name Server (DNS) is a system that stores information associated with domain names in a distributed database on networks, such as the Internet.

Dot Matrix Printer

A dot matrix printer refers to a type of computer printer with a print head that runs back and forth on the page and prints by impact, striking an ink-soaked cloth ribbon against the paper, much like a typewriter.

DPI

Dots Per Inch (DPI) is a measurement of resolution that is used for scanning and printing. Generally, higher DPI results in a higher resolution, more visible detail in the image, and a larger file size.

DRPD

Distinctive Ring Pattern Detection. Distinctive Ring is a telephone company service which enables a user to use a single telephone line to answer several different telephone numbers.

Duplex

A mechanism that will automatically turn over a sheet of paper so that the machine can print (or scan) on both sides of the paper. A printer equipped with a Duplex Unit can print on both sides of paper during one print cycle.

Duty Cycle

Duty cycle is the page quantity which does not affect printer performance for a month. Generally the printer has the lifespan limitation such as pages per year. The lifespan means the average capacity of print-outs, usually within the warranty period. For example, if the duty cycle is 48,000 pages per month assuming 20 working days, a printer limits 2,400 pages a day.

ECM

Error Correction Mode (ECM) is an optional transmission mode built into Class 1 fax machines or fax modems. It automatically detects and corrects errors in the fax transmission process that are sometimes caused by telephone line noise.

Emulation

Emulation is a technique of one machine obtaining the same results as another.

An emulator duplicates the functions of one system with a different system, so that the second system behaves like the first system. Emulation focuses on exact reproduction of external behavior, which is in contrast to simulation, which concerns an abstract model of the system being simulated, often considering its internal state.

Ethernet

Ethernet is a frame-based computer networking technology for local area networks (LANs). It defines wiring and signaling for the physical layer, and frame formats and protocols for the media access control (MAC)/data link layer of the OSI model. Ethernet is mostly standardized as IEEE 802.3. It has become the most widespread LAN technology in use during the 1990s to the present.

EtherTalk

A suite of protocols developed by Apple Computer for computer networking. It was included in the original Mac (1984) and is now deprecated by Apple in favor of TCP/IP networking.

FDI

Foreign Device Interface (FDI) is a card installed inside the machine to allow a third party device such as a coin operated device or a card reader. Those devices allow the pay-for-print service on your machine.

FTP

A File Transfer Protocol (FTP) is a commonly used protocol for exchanging files over any network that supports the TCP/IP protocol (such as the Internet or an intranet).

Fuser Unit

The part of a laser printer that fuses the toner onto the print media. It consists of a heat roller and a pressure roller. After toner is transferred onto the paper, the fuser unit applies heat and pressure to ensure that the toner stays on the paper permanently, which is why paper is warm when it comes out of a laser printer.

Gateway

A connection between computer networks, or between a computer network and a telephone line. It is very popular, as it is a computer or a network that allows access to another computer or network.

Grayscale

A shades of gray that represent light and dark portions of an image when color images are converted to grayscale; colors are represented by various shades of gray.

Halftone

An image type that simulates grayscale by varying the number of dots. Highly colored areas consist of a large number of dots, while lighter areas consist of a smaller number of dots.

Mass storage device (HDD)

Mass storage device (HDD), commonly referred to as a hard drive or hard disk, is a non-volatile storage device which stores digitally-encoded data on rapidly rotating platters with magnetic surfaces.

IEEE

The Institute of Electrical and Electronics Engineers (IEEE) is an international non-profit, professional organization for the advancement of technology related to electricity.

IEEE 1284

The 1284 parallel port standard was developed by the Institute of Electrical and Electronics Engineers (IEEE). The term "1284-B" refers to a specific connector type on the end of the parallel cable that attaches to the peripheral (for example, a printer).

Intranet

A private network that uses Internet Protocols, network connectivity, and possibly the public telecommunication system to securely share part of an organization's information or operations with its employees. Sometimes the term refers only to the most visible service, the internal website.

IP address

An Internet Protocol (IP) address is a unique number that devices use in order to identify and communicate with each other on a network utilizing the Internet Protocol standard.

IPM

The Images Per Minute (IPM) is a way of measuring the speed of a printer. An IPM rate indicates the number of single-sided sheets a printer can complete within one minute.

IPP

The Internet Printing Protocol (IPP) defines a standard protocol for printing as well as managing print jobs, media size, resolution, and so forth. IPP can be used locally or over the Internet to hundreds of printers, and also supports access control, authentication, and encryption, making it a much more capable and secure printing solution than older ones.

IPX/SPX

IPX/SPX stands for Internet Packet Exchange/Sequenced Packet Exchange. It is a networking protocol used by the Novell NetWare operating systems. IPX and SPX both provide connection services similar to TCP/IP, with the IPX protocol having similarities to IP, and SPX having similarities to TCP. IPX/SPX was primarily designed for local area networks (LANs), and is a very efficient protocol for this purpose (typically its performance exceeds that of TCP/IP on a LAN).

ISO

The International Organization for Standardization (ISO) is an international standard-setting body composed of representatives from national standards bodies. It produces world-wide industrial and commercial standards.

ITU-T

The International Telecommunication Union is an international organization established to standardize and regulate international radio and telecommunications. Its main tasks include standardization, allocation of the radio spectrum, and organizing interconnection arrangements between different countries to allow international phone calls. A -T out of ITU-T indicates telecommunication.

ITU-T No. 1 chart

Standardized test chart published by ITU-T for document facsimile transmissions.

JBIG

Joint Bi-level Image Experts Group (JBIG) is an image compression standard with no loss of accuracy or quality, which was designed for compression of binary images, particularly for faxes, but can also be used on other images.

JPEG

Joint Photographic Experts Group (JPEG) is a most commonly used standard method of lossy compression for photographic images. It is the format used for storing and transmitting photographs on the World Wide Web.

LDAP

The Lightweight Directory Access Protocol (LDAP) is a networking protocol for querying and modifying directory services running over TCP/IP.

LED

A Light-Emitting Diode (LED) is a semiconductor device that indicates the status of a machine.

MAC address

Media Access Control (MAC) address is a unique identifier associated with a network adapter. MAC address is a unique 48-bit identifier usually written as 12 hexadecimal characters grouped in pairs (e. g., 00-00-0c-34-11-4e). This address is usually hard-coded into a Network Interface Card (NIC) by its manufacturer, and used as an aid for routers trying to locate machines on large networks.

MFP

Multi Function Peripheral (MFP) is an office machine that includes the following functionality in one physical body, so as to have a printer, a copier, a fax, a scanner and etc.

MH

Modified Huffman (MH) is a compression method for decreasing the amount of data that needs to be transmitted between the fax machines to transfer the image recommended by ITU-T T.4. MH is a codebook-based run-length encoding scheme optimized to efficiently compress white space. As most faxes consist mostly of white space, this minimizes the transmission time of most faxes.

MMR

Modified Modified READ (MMR) is a compression method recommended by ITU-T T.6.

Modem

A device that modulates a carrier signal to encode digital information, and also demodulates such a carrier signal to decode transmitted information.

MR

Modified Read (MR) is a compression method recommended by ITU-T T.4. MR encodes the first scanned line using MH. The next line is compared to the first, the differences determined, and then the differences are encoded and transmitted.

Glossary

NetWare

A network operating system developed by Novell, Inc. It initially used cooperative multitasking to run various services on a PC, and the network protocols were based on the archetypal Xerox XNS stack. Today NetWare supports TCP/IP as well as IPX/SPX.

OPC

Organic Photo Conductor (OPC) is a mechanism that makes a virtual image for print using a laser beam emitted from a laser printer, and it is usually green or rust colored and has a cylinder shape.

An imaging unit containing a drum slowly wears the drum surface by its usage in the printer, and it should be replaced appropriately since it gets worn from contact with the cartridge development brush, cleaning mechanism, and paper.

Originals

The first example of something, such as a document, photograph or text, etc, which is copied, reproduced or translated to produce others, but which is not itself copied or derived from something else.

OSI

Open Systems Interconnection (OSI) is a model developed by the International Organization for Standardization (ISO) for communications. OSI offers a standard, modular approach to network design that divides the required set of complex functions into manageable, self-contained, functional layers. The layers are, from top to bottom, Application, Presentation, Session, Transport, Network, Data Link and Physical.

PABX

A private automatic branch exchange (PABX) is an automatic telephone switching system within a private enterprise.

PCL

Printer Command Language (PCL) is a Page Description Language (PDL) developed by HP as a printer protocol and has become an industry standard. Originally developed for early inkjet printers, PCL has been released in varying levels for thermal, dot matrix printer, and laser printers.

PDF

Portable Document Format (PDF) is a proprietary file format developed by Adobe Systems for representing two dimensional documents in a device independent and resolution independent format.

PostScript

PostScript (PS) is a page description language and programming language used primarily in the electronic and desktop publishing areas. - that is run in an interpreter to generate an image.

Printer Driver

A program used to send commands and transfer data from the computer to the printer.

Print Media

The media like paper, envelopes, labels, and transparencies which can be used in a printer, a scanner, a fax or, a copier.

PPM

Pages Per Minute (PPM) is a method of measurement for determining how fast a printer works, meaning the number of pages a printer can produce in one minute.

PRN file

An interface for a device driver, this allows software to interact with the device driver using standard input/output system calls, which simplifies many tasks.

Protocol

A convention or standard that controls or enables the connection, communication, and data transfer between two computing endpoints.

PS

See PostScript.

PSTN

The Public-Switched Telephone Network (PSTN) is the network of the world's public circuit-switched telephone networks which, on industrial premises, is usually routed through the switchboard.

RADIUS

Remote Authentication Dial In User Service (RADIUS) is a protocol for remote user authentication and accounting. RADIUS enables centralized management of authentication data such as usernames and passwords using an AAA (authentication, authorization, and accounting) concept to manage network access.

Resolution

The sharpness of an image, measured in Dots Per Inch (DPI). The higher the dpi, the greater the resolution.

SMB

Server Message Block (SMB) is a network protocol mainly applied to share files, printers, serial ports, and miscellaneous communications between nodes on a network. It also provides an authenticated Inter-process communication mechanism.

SMTP

Simple Mail Transfer Protocol (SMTP) is the standard for e-mail transmissions across the Internet. SMTP is a relatively simple, text-based protocol, where one or more recipients of a message are specified, and then the message text is transferred. It is a client-server protocol, where the client transmits an email message to the server.

SSID

Service Set Identifier (SSID) is a name of a wireless local area network (WLAN). All wireless devices in a WLAN use the same SSID in order to communicate with each other. The SSIDs are case-sensitive and have a maximum length of 32 characters.

Subnet Mask

The subnet mask is used in conjunction with the network address to determine which part of the address is the network address and which part is the host address.

TCP/IP

The Transmission Control Protocol (TCP) and the Internet Protocol (IP); the set of communications protocols that implement the protocol stack on which the Internet and most commercial networks run.

TCR

Transmission Confirmation Report (TCR) provides details of each transmission such as job status, transmission result and number of pages sent. This report can be set to print after each job or only after failed transmissions.

TIFF

Tagged Image File Format (TIFF) is a variable-resolution bitmapped image format. TIFF describes image data that typically come from scanners. TIFF images make use of tags, keywords defining the characteristics of the image that is included in the file. This flexible and platform-independent format can be used for pictures that have been made by various image processing applications.

Toner Cartridge

A kind of bottle or container used in a machine like a printer which contains toner. Toner is a powder used in laser printers and photocopiers, which forms the text and images on the printed paper. Toner can be fused by a combination of heat/pressure from the fuser, causing it to bind to the fibers in the paper.

TWAIN

An industry standard for scanners and software. By using a TWAIN-compliant scanner with a TWAIN-compliant program, a scan can be initiated from within the program. It is an image capture API for Microsoft Windows and Apple Mac operating systems.

UNC Path

Uniform Naming Convention (UNC) is a standard way to access network shares in Window NT and other Microsoft products. The format of a UNC path is:
\\<servername>\<sharename>\<Additional directory>

URL

Uniform Resource Locator (URL) is the global address of documents and resources on the Internet. The first part of the address indicates what protocol to use, the second part specifies the IP address or the domain name where the resource is located.

USB

Universal Serial Bus (USB) is a standard that was developed by the USB Implementers Forum, Inc., to connect computers and peripherals. Unlike the parallel port, USB is designed to concurrently connect a single computer USB port to multiple peripherals.

Watermark

A watermark is a recognizable image or pattern in paper that appears lighter when viewed by transmitted light. Watermarks were first introduced in Bologna, Italy in 1282; they have been used by papermakers to identify their product, and also on postage stamps, currency, and other government documents to discourage counterfeiting.

WEP

Wired Equivalent Privacy (WEP) is a security protocol specified in IEEE 802.11 to provide the same level of security as that of a wired LAN. WEP provides security by encrypting data over radio so that it is protected as it is transmitted from one end point to another.

WIA

Windows Imaging Architecture (WIA) is an imaging architecture that is originally introduced in Windows Me and Windows XP. A scan can be initiated from within these operating systems by using a WIA-compliant scanner.

WPA

Wi-Fi Protected Access (WPA) is a class of systems to secure wireless (Wi-Fi) computer networks, which was created to improve upon the security features of WEP.

WPA-PSK

WPA-PSK (WPA Pre-Shared Key) is special mode of WPA for small business or home users. A shared key, or password, is configured in the wireless access point (WAP) and any wireless laptop or desktop devices. WPA-PSK generates a unique key for each session between a wireless client and the associated WAP for more advanced security.

WPS

The Wi-Fi Protected Setup (WPS) is a standard for establishing a wireless home network. If your wireless access point supports WPS, you can configure the wireless network connection easily without a computer.

XPS

XML Paper Specification (XPS) is a specification for a Page Description Language (PDL) and a new document format, which has benefits for portable document and electronic document, developed by Microsoft. It is an XML-based specification, based on a new print path and a vector-based device-independent document format.

Index

A

accessing	
management tools	310
address book	
editing	216
group editing	217
group registering	217
registering	216
using	216
address book setup	216
AirPrint	188
AnyWeb Print	252

B

buttons	
eco	26, 27, 29
id copy	27
numeric keypad	28
print screen	25
scan to	25
wps	25, 27

C

cleaning

inside	92
outside	91
scan unit	94
cleaning a machine	91
control panel	24
convention	13
copy	
general setup	196
copying	
basic copying	61
reducing or enlarging copies	63

D

default settings	
tray setting	49

E

easy document creator	260
configuration	261
convert e-book	263
device name	261
e-book conversion	261
plug-in	264
quick scan	261

quick scanning	262
scan	261
scanning	262
search	262
send fax	261, 264
SNS scanning	263
SNS upload	261
eco printing	59
entering character	215
error message	112

F

favorites settings, for printing	58
fax	
adding documents to a reserved fax	243
automatic redialing	240
canceling a reserved fax job	243
changing the receive modes	245
delaying a fax transmission	242
forwarding a received fax to another destination	244
forwarding a sent fax to another destination	244
general setup	199
Printing sent fax report automatically	248

Index

receiving a fax in the computer	245		
receiving faxes in memory	248		
receiving in Answering Machine mode	246		
receiving in DRPD mode	247		
receiving in Fax mode	246		
receiving in secure mode	247		
receiving in Tel mode	246		
receiving with ext. telephone	246		
redialing the last number	240		
sending a fax in the computer	241		
sending a priority fax	243		
fax feature	240		
fax sending			
multi sending	67		
faxing			
adjusting darkness	69		
adjusting resolution	69		
preparing to fax	66		
receiving in Fax mode	68		
features	5		
machine features	193		
print media feature	121		
front view	21		
		G	
		general icons	13
		general settings	205
		glossary	318
		google cloud printing	190
		I	
		id copy	63
		installation	
		accessories	311
		J	
		jam	
		clearing original document	99
		clearing paper	104
		tips for avoiding paper jams	98
		L	
		LCD display	
		browsing the machine status	196, 197, 199, 203, 208
		Linux	
		common Linux problems	292
		driver installation for network connected	
			159
		driver installation for USB cable connected	148
		driver reinstallation for USB cable connected	149
		printer properties	230
		printing	228
		scanning	237
		unified driver configurator	267
		using SetIP	154
		linux scanning	237
		loading	
		paper in the tray1	44
		special media	47
		loading originals	51
		M	
		Mac	
		common Mac problems	291
		driver installation for network connected	157
		driver installation for USB cable connected	146
		driver reinstallation for USB cable connected	147

Index

printing	226	wired network setup	152	labels	48
scanning	236	wireless network setup	164	output support	121
system requirements	124	n-up printing		preprinted paper	49
using SetIP	153	Mac	227	setting the paper size	49
mac scanning	236			setting the paper type	49
machine information	196, 197, 199, 203, 208			special media	47
machine setup		O		print menu	195
machine status	196, 197, 199, 203, 208	output support	50	print resolution set	
maintenance parts	78	overlay printing		Linux	229
menu overview	35	create	225	printer preferences	
multi-purpose tray		delete	226	Linux	230
using special media	47	print	226	printer status	
				general information	265
N		P		printing	
network		placing a machine		changing the default print settings	219
driver installation		adjusting the altitude	214	Linux	228
Linux	159	postScript driver		Mac	226
Mac	157	troubleshooting	294	multiple pages on one sheet of paper	
Windows	155	preparing originals type	51	Mac	227
general setup	211	print		printing a document	
installing environment	127	general setup	195	Windows	55
introducing network programs	151	mobile OS	187	printing on both sides of paper	
IPv6 configuration	161	mobileprint	187	Mac	227
SetIP program	152, 153, 154, 179	print media		printing to a file	220
		card stock	48		

Index

setting as a default machine	219	resolution		service contact numbers	313
special printer features	221	faxing	69	SetIP program	152, 179
USB memory	72			Special features	213
printing a document		S		specifications	119
Linux	228	safety		print media	121
Mac	226	information	14	status	26, 28
printing feature	219	symbols	14	supplies	
problem		samsung printer experience	305	available supplies	77
operating system problems	290	Samsung Printer Status	265	estimated toner cartridge life	80
problems		scan		monitoring the supplies life	89
copying problems	286	general setup	203	ordering	77
faxing problems	288	Scan Assitant	235	replacing toner cartridge	83
paper feeding problems	272	scan feature	231	SyncThru Web Service	
power problems	273	Scanning		general information	254
printing problems	274	Scanning with Samsung Scan Assitant	235	SyncThru™ Web Service	254
printing quality problems	278	scanning		T	
scanning problems	287	basic information	231	toner cartridge	
R		Linux scanning	237	estimated life	80
rear view	23	Mac scanning	236	handling instructions	79
regulatory information	128	Scanning from image editing program	234	non-Samsung and refilled	79
reports		Scanning from network connected machine	232, 233	redistributing toner	81
machine information	196, 199, 200, 201, 205,	Scanning using the WIA driver	234	replacing the cartridge	83
	206, 208, 209	USB flash memory	71	storing	79

Index

tray		Windows		USB cable	170
adjusting the width and length	43	common Windows problems	290	WPS	
changing the tray size	43	driver installation for network connected	155	disconnecting	167
setting the paper size and type	49	driver installation for USB cable connected	31, 33	PBC mode	167
troubleshooting	312	driver installation for Windows 8 network connected	300	WPS (the machine does not have a display screen)	
U		driver installation for Windows 8 USB cable connected	298	PBC	168
understanding the status LED	110	driver installation for Windows 8 wireless network	302	PIN	168
Unix		system requirements	123	wireless network	
system requirements	125	using SetIP	152, 179	network cable	178
USB cable		Windows 8			
driver installation	31, 33, 146, 148	driver uninstallation	304		
driver reinstallation	147, 149	network			
USB flash memory		driver installation	300		
managing	73	USB cable			
printing	72	driver installation	298		
scanning	71	wireless			
using help	58, 228	driver installation	302		
W		wireless			
watermark		ad hoc mode	164		
create	224	Infrastructure mode	164		
delete	224				
edit	224				