

LC-37G4U LC-32G4U TU-GA1U-S

LIQUID CRYSTAL TELEVISION

ENGLISH

OPERATION MANUAL

Display

Model No.:
Serial No.:

AVC System

Model No.:
Serial No.:

IMPORTANT:

To aid reporting in case of loss or theft, please record the TV's model and serial numbers in the space provided. The numbers are located at the rear of the TV and the AVC System.

IMPORTANT INFORMATION

WARNING: TO REDUCE THE RISK OF FIRE OR ELECTRIC SHOCK, DO NOT EXPOSE THIS PRODUCT TO RAIN OR MOISTURE.

	CAUTION RISK OF ELECTRIC SHOCK DO NOT OPEN	
---	---	---

CAUTION: TO REDUCE THE RISK OF ELECTRIC SHOCK, DO NOT REMOVE COVER (OR BACK). NO USER-SERVICEABLE PARTS INSIDE. REFER SERVICING TO QUALIFIED SERVICE PERSONNEL.



The lightning flash with arrow-head symbol, within an equilateral triangle, is intended to alert the user to the presence of uninsulated "dangerous voltage" within the product's enclosure that may be of sufficient magnitude to constitute a risk of electric shock to persons.



The exclamation point within a triangle is intended to alert the user to the presence of important operating and maintenance (servicing) instructions in the literature accompanying the product.

IMPORTANT INFORMATION

CAUTION: TO PREVENT ELECTRIC SHOCK, MATCH WIDE BLADE OF PLUG TO WIDE SLOT, FULLY INSERT.

CAUTION:

DO NOT PLACE THIS PRODUCT ON AN UNSTABLE CART, STAND, TRIPOD, BRACKET, OR TABLE. THE PRODUCT MAY FALL CAUSING SERIOUS PERSONAL INJURY AND SERIOUS DAMAGE TO THE PRODUCT. USE ONLY WITH A CART, STAND, TRIPOD, BRACKET, OR TABLE RECOMMENDED BY THE MANUFACTURER OR SOLD WITH THE PRODUCT. FOLLOW THE MANUFACTURER'S INSTRUCTIONS WHEN INSTALLING THE PRODUCT AND USE MOUNTING ACCESSORIES RECOMMENDED BY THE MANUFACTURER. A PRODUCT AND CART COMBINATION SHOULD BE MOVED WITH CARE. QUICK STOPS, EXCESSIVE FORCE, AND UNEVEN SURFACES MAY CAUSE THE PRODUCT AND CART COMBINATION TO OVERTURN.



WARNING: FCC Regulations state that any unauthorized changes or modifications to this equipment not expressly approved by the manufacturer could void the user's authority to operate this equipment.

CAUTION:

This product satisfies FCC regulations when shielded cables and connectors are used to connect the unit to other equipment. To prevent electromagnetic interference with electric appliances such as radios and televisions, use shielded cables and connectors for connections.

DECLARATION OF CONFORMITY

SHARP LIQUID CRYSTAL TELEVISION, MODEL LC-37G4U (Display).
SHARP LIQUID CRYSTAL TELEVISION, MODEL LC-32G4U (Display).
SHARP LIQUID CRYSTAL TELEVISION, MODEL TU-GA1U-S (AVC System).

This device complies with Part 15 of the FCC Rules. Operation is subject to the following two conditions: (1) This device may not cause harmful interference, and (2) this device must accept any interference received, including interference that may cause undesired operation.

RESPONSIBLE PARTY:

SHARP ELECTRONICS CORPORATION
Sharp Plaza, Mahwah, New Jersey 07430-2135
TEL: 1-800-BE-SHARP

For Business Customers: URL <http://www.sharppusa.com>

INFORMATION:

This equipment has been tested and found to comply with the limits for a Class B digital device, pursuant to Part 15 of the FCC Rules. These limits are designed to provide reasonable protection against harmful interference in a residential installation. This equipment generates, uses and can radiate radio frequency energy and, if not installed and used in accordance with the instructions, may cause harmful interference to radio communications. However, there is no guarantee that interference will not occur in a particular installation. If this equipment does cause harmful interference to radio or television reception, which can be determined by turning the equipment off and on, the user is encouraged to try to correct the interference by one or more of the following measures:

- Reorient or relocate the receiving antenna.
- Increase the separation between the equipment and receiver.
- Connect the equipment into an outlet on a circuit different from that to which the receiver is connected.
- Consult the dealer or an experienced radio/TV technician for help.

"Note to CATV system installer: This reminder is provided to call the CATV system installer's attention to Article 820-40 of the National Electrical Code that provides guidelines for proper grounding and, in particular, specifies that the cable ground shall be connected to the grounding system of the building, as close to the point of cable entry as practical."

This product utilizes tin-lead solder, and fluorescent lamp containing a small amount of mercury. Disposal of these materials may be regulated due to environmental considerations. For disposal or recycling information, please contact your local authorities or the Electronic Industries Alliance: www.eia.org

Trademarks

- Manufactured under license from Dolby Laboratories. "Dolby", "Pro Logic" and the double-D symbol are trademarks of Dolby Laboratories.

- Manufactured under license from BBE Sound, Inc.
Licensed by BBE Sound, Inc. under USP4638258, 5510752 and 5736897. BBE and BBE symbol are registered trademarks of BBE Sound, Inc.

DEAR SHARP CUSTOMER

Thank you for your purchase of the Sharp Liquid Crystal Television. To ensure safety and many years of trouble-free operation of your product, please read the Important Safety Precautions carefully before using this product.

IMPORTANT SAFETY INSTRUCTIONS

Electricity is used to perform many useful functions, but it can also cause personal injuries and property damage if improperly handled. This product has been engineered and manufactured with the highest priority on safety. However, improper use can result in electric shock and/or fire. In order to prevent potential danger, please observe the following instructions when installing, operating and cleaning the product. To ensure your safety and prolong the service life of your Liquid Crystal Television, please read the following precautions carefully before using the product.

- 1) Read these instructions.
- 2) Keep these instructions.
- 3) Heed all warnings.
- 4) Follow all instructions.
- 5) Do not use this apparatus near water.
- 6) Clean only with dry cloth.
- 7) Do not block any ventilation openings. Install in accordance with the manufacturer's instructions.
- 8) Do not install near any heat sources such as radiators, heat registers, stoves, or other apparatus (including amplifiers) that produce heat.
- 9) Do not defeat the safety purpose of the polarized or grounding-type plug. A polarized plug has two blades with one wider than the other. A grounding type plug has two blades and a third grounding prong. The wide blade or the third prong are provided for your safety. If the provided plug does not fit into your outlet, consult an electrician for replacement of the obsolete outlet.
- 10) Protect the power cord from being walked on or pinched particularly at plugs, convenience receptacles, and the point where they exit from the apparatus.
- 11) Only use attachments/accessories specified by the manufacturer.
- 12) Use only with the cart, stand, tripod, bracket, or table specified by the manufacturer, or sold with the apparatus. When a cart is used, use caution when moving the cart/apparatus combination to avoid injury from tip-over.
- 13) Unplug this apparatus during lightning storms or when unused for long periods of time.
- 14) Refer all servicing to qualified service personnel. Servicing is required when the apparatus has been damaged in any way, such as power-supply cord or plug is damaged, liquid has been spilled or objects have fallen into the apparatus, the apparatus has been exposed to rain or moisture, does not operate normally, or has been dropped.
- 15) Power Sources — This product should be operated only from the type of power source indicated on the marking label. If you are not sure of the type of power supply to your home, consult your product dealer or local power company. For products intended to operate from battery power, or other sources, refer to the operating instructions.
- 16) Overloading — Do not overload wall outlets, extension cords, or integral convenience receptacles as this can result in a risk of fire or electric shock.
- 17) Object and Liquid Entry — Never push objects of any kind into this product through openings as they may touch dangerous voltage points or short-out parts that could result in a fire or electric shock. Never spill liquid of any kind on the product.
- 18) Damage Requiring Service — Unplug this product from the wall outlet and refer servicing to qualified service personnel under the following conditions:
 - a) When the AC cord or plug is damaged,
 - b) If liquid has been spilled, or objects have fallen into the product,
 - c) If the product has been exposed to rain or water,
 - d) If the product does not operate normally by following the operating instructions.
Adjust only those controls that are covered by the operating instructions as an improper adjustment of other controls may result in damage and will often require extensive work by a qualified technician to restore the product to its normal operation,
 - e) If the product has been dropped or damaged in any way, and
 - f) When the product exhibits a distinct change in performance – this indicates a need for service.
- 19) Replacement Parts — When replacement parts are required, be sure the service technician has used replacement parts specified by the manufacturer or have the same characteristics as the original part. Unauthorized substitutions may result in fire, electric shock, or other hazards.
- 20) Safety Check — Upon completion of any service or repairs to this product, ask the service technician to perform safety checks to determine that the product is in proper operating condition.
- 21) Wall or ceiling mounting — When mounting the product on a wall or ceiling, be sure to install the product according to the method recommended by the manufacturer.



IMPORTANT SAFETY INSTRUCTIONS

- **Water and Moisture** — Do not use this product near water – for example, near a bath tub, wash bowl, kitchen sink, or laundry tub; in a wet basement; or near a swimming pool; and the like.

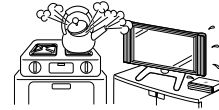

- **Stand** — Do not place the product on an unstable cart, stand, tripod or table. Placing the product on an unstable base can cause the product to fall, resulting in serious personal injuries as well as damage to the product. Use only a cart, stand, tripod, bracket or table recommended by the manufacturer or sold with the product. When mounting the product on a wall, be sure to follow the manufacturer's instructions. Use only the mounting hardware recommended by the manufacturer.



- **Ventilation** — The vents and other openings in the cabinet are designed for ventilation. Do not cover or block these vents and openings since insufficient ventilation can cause overheating and/or shorten the life of the product. Do not place the product on a bed, sofa, rug or other similar surface, since they can block ventilation openings. This product is not designed for built-in installation; do not place the product in an enclosed place such as a bookcase or rack, unless proper ventilation is provided or the manufacturer's instructions are followed.



- **The Liquid Crystal panel used in this product is made of glass.** Therefore, it can break when the product is dropped or applied with impact. Be careful not to be injured by broken glass pieces in case the panel breaks.

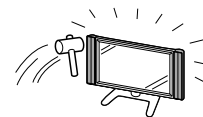

- **Heat** — The product should be situated away from heat sources such as radiators, heat registers, stoves, or other products (including amplifiers) that produce heat.

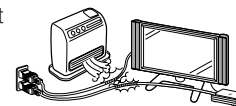

- The Liquid Crystal panel is a very high technology product with 3,147,264 thin film transistors, giving you fine picture details. Occasionally, a few non-active pixels may appear on the screen as a fixed point of blue, green or red. Please note that this does not affect the performance of your product.

Precautions when transporting the Display

When transporting the Display, never carry it by holding onto the speaker. Be sure to always carry the Display by two people holding it with two hands—one hand on each side of the Display.

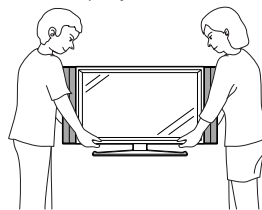

- **Lightning** — For added protection for this television equipment during a lightning storm, or when it is left unattended and unused for long periods of time, unplug it from the wall outlet and disconnect the antenna. This will prevent damage to the equipment due to lightning and power-line surges.

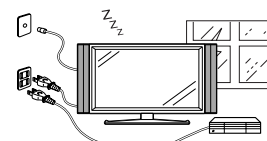

- **Power Lines** — An outside antenna system should not be located in the vicinity of overhead power lines or other electric light or power circuits, or where it can fall into such power lines or circuits. When installing an outside antenna system, extreme care should be taken to keep from touching such power lines or circuits as contact with them might be fatal.



IMPORTANT SAFETY INSTRUCTIONS

- Outdoor Antenna Grounding — If an outside antenna is connected to the television equipment, be sure the antenna system is grounded so as to provide some protection against voltage surges and built-up static charges. Article 810 of the National Electrical Code, ANSI/NFPA 70, provides information with regard to proper grounding of the mast and supporting structure, grounding of the lead-in wire to an antenna discharge unit, size of grounding conductors, location of antenna-discharge unit, connection to grounding electrodes, and requirements for the grounding electrode.

EXAMPLE OF ANTENNA GROUNDING AS PER NATIONAL ELECTRICAL CODE, ANSI/NFPA 70

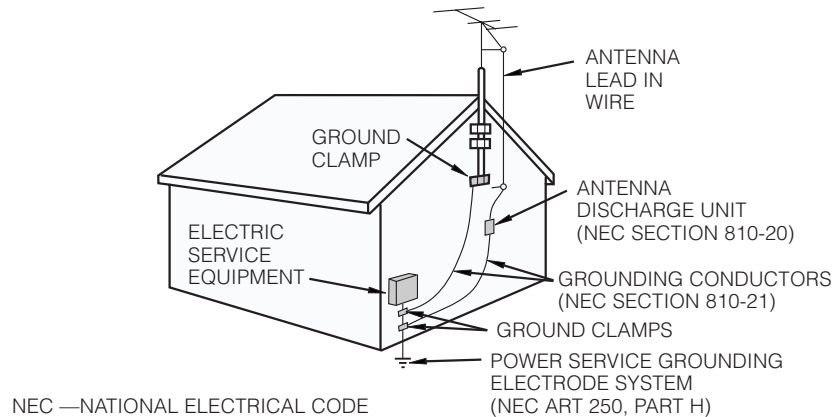

- To prevent fire, never place any type of candle or naked flames on the top or near the TV set.

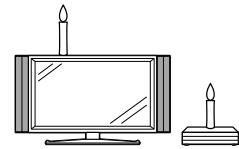

- To prevent fire or shock hazard, do not expose this product to dripping or splashing. No objects filled with liquids, such as vases, should be placed on the product.

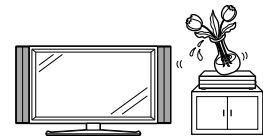

- To prevent fire or shock hazard, do not place the AC power cord under the TV set or other heavy items.

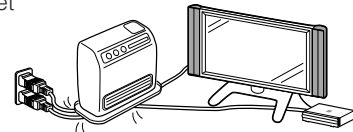

- Turn off the main power and unplug the AC cord from the wall outlet before handling.
- Use a soft cloth and gently wipe the surface of the display panel. Using a hard cloth may scratch the panel surface.
- Use a soft damp cloth to gently wipe the panel when it is really dirty. (It may scratch the panel surface when wiped strongly.)
- If the panel is dusty, use an anti-static brush, which is commercially available, to clean it.
- To protect the panel, do not use a dirty cloth, liquid cleaners or chemical cloth to clean it, such materials may damage the panel surface.

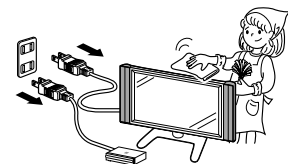

COPYRIGHT

It is the intent of Sharp that this product be used in full compliance with the copyright laws of the United States and that prior permission be obtained from copyright owners whenever necessary.





Contents

IMPORTANT INFORMATION	XX
Trademarks	XX
DEAR SHARP CUSTOMER	XX
IMPORTANT SAFETY INSTRUCTIONS	XX
Contents	XX
Supplied accessories	XX
Preparation	XX
Attaching speakers	XX
Where to place the System	XX
Setting the System	XX
Setting the AVC System with the stand	XX
Removing speakers	XX
Removing the stand	XX
Setting the Display on the wall	XX
Inserting the batteries	XX
Using the remote control unit	XX
Cautions regarding remote control unit ...	XX
Part names	XX
Display	XX
AVC System	XX
Remote control unit	XX
Watching TV	XX
Antennas	XX
Cable converter/VCR connection	XX
Outdoor antenna connection	XX
Connecting the AC cord	XX
Turning on the power	XX
Turning off the power	XX
Initial setup	XX
Simple button operations	
for changing channels	XX
Simple button operations	
for changing volume/sound	XX
Setting MTS/SAP stereo mode	XX
Basic adjustment settings	XX
AV input mode menu items	XX
PC input mode menu items	XX
EZ setup	XX
Channel setup	XX
Favorite channel setting	XX
Language setting	XX
OPC setting	XX
Picture adjustments	XX
C.M.S. (Color Management System)	XX
Color temperature	XX
Black	XX
3D-Y/C	XX
Monochrome	XX
Film mode (3:2 pull-down)	XX
I/P Setting	XX
Sound adjustment	XX
Dolby virtual	XX
Power control	XX
Power control for AV source	XX
Power control for PC source	XX
Using memory card	XX
Important notes on using memory card	XX
Card Setup mode menu items	XX
Recording a still image	XX
Displaying a still image	XX
Setting Slide Show	XX
My Program	XX
Audio Select	XX
Protecting still picture files	XX
Deleting a still image file	XX
Deleting all still image files	XX
Rec. Mode	XX
Pre Record	XX
Repeat Play	XX
Protecting motion picture files	XX
Displaying a motion picture	XX
Format	XX
Deleting a motion picture file	XX
Deleting all motion picture files	XX
Using external equipment	XX
Displaying an external equipment image	XX
Connecting a DVD player	XX
Connecting a VCR	XX
Connecting a game console	
or camcorder	XX
Connecting a Digital TV STB	XX
Connecting HDMI equipment	XX
Displaying an image from HDMI	
equipment	XX
Connecting a PC	XX
Useful adjustment settings	XX
Image position (AV input mode only)	XX
Moving the picture on the screen	XX
Connecting external speakers	XX
Selecting speakers	XX
Audio Quality Control	XX
Auto Sync. adjustment (PC input mode only) ...	XX
Fine Sync. adjustment (PC input mode only) ...	XX
Input Select	XX
Input label	XX
Picture flip	XX
AV MODE	XX
View mode for 4:3 Programs	XX
View mode (for PC input mode)	XX
Input signal (for PC input mode)	XX
Digital Noise Reduction	XX
Audio only	XX
Output Select	XX
Quick shoot	XX
Sleep timer	XX
Closed caption	XX
Caption Size	XX
Font Style	XX
Foreground Color	XX
Foreground Opacity	XX
Background Color	XX
Background Opacity	XX
Character Edge	XX
Secret number setting for parental control	
(AV input mode only)	XX
Parental control (setting V-CHIP level)	XX
How to temporarily release	
the V-CHIP BLOCK	XX
Reactivating the temporarily released	
the V-CHIP BLOCK	XX
Center Channel Input	XX
Other viewing options	XX
Twin picture functions	XX
Presetting remote control function	XX
Appendix	XX
Troubleshooting	XX
PC compatibility chart	XX
RS-232C port specifications	XX
Specifications	XX
Optional accessory	XX
Dimensional drawings	XX

Supplied accessories

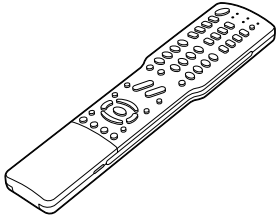
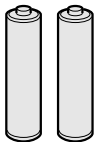
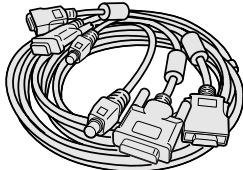
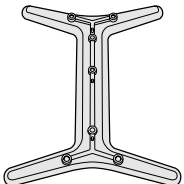
Make sure the following accessories are provided with the product.

AVC System: TU-GA1U-S

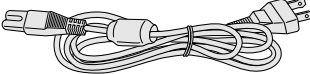
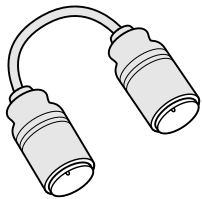
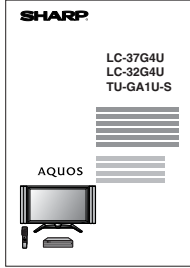
Remote control unit (×1)	“AAA” size battery (×2)	System cable (×1)
 <p>RRMCGA263WJSA Page XX</p>	 <p>Page XX</p>	 <p>QCNW-B856WJZZ Page XX</p>
Stand unit (for AVC System) (×1)	AC cord (×1)	RF cable (×1)
 <p>GDAI-A104WJSB</p>  <p>PSPAHA314WJZZ</p>  <p>GLEGGGA013WJZZ</p>  <p>XBPSN50P16JS0</p> <p>Stand (×1) Stand spacer (×4) Stand cushion (×4) Stand screw (×2)</p> <p>Page XX</p>	 <p>QACCCA019WJPZ Page XX</p>	 <p>QCNW-A342WJZZ Pages XX and XX</p>
	<p>Operation manual (×1)</p>	
	 <p>TINS-B116WJZZ</p>	

NOTE



- Always use the AC cord supplied with the Liquid Crystal Television and the one supplied with the AVC System for each respective unit.
- AC cords enclosed in this product are for 110-125V. When using this product on the 220-240V, please order and use “QACCZA036WJPZ” as an option in this manual.

SHARP ELECTRONICS CORPORATION
6100 Blue Lagoon Drive, Suite 230, Miami, Florida 33126, U.S.A.

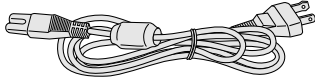

Supplied accessories

Make sure the following accessories are provided with the product.

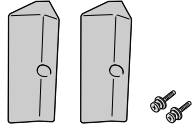
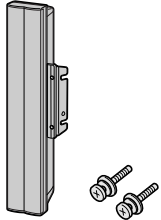
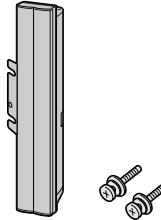
Display: LC-37G4U

AC cord (× 1)	Cable clamp (× 1)	Bracket unit (× 1)
 <p data-bbox="298 630 496 680">QACCCA019WJPZ Page XX</p>	 <p data-bbox="712 630 906 680">LHLDW0110CEZZ Page XX</p>	 <p data-bbox="1118 630 1312 680">CHLDZA331WJ02 Page XX</p>
Speaker unit (× 1)		
 <p data-bbox="310 1056 490 1129">Left speaker DSP-ZA053UJ03 Page XX</p>  <p data-bbox="716 1056 896 1129">Right speaker DSP-ZA053UJ04 Page XX</p>		

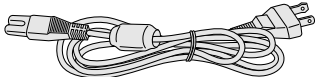
Display: LC-32G4U

AC cord (× 1)	Cable clamp (× 1)
 <p data-bbox="298 1585 505 1635">QACCCA019WJPZ Page XX</p>	 <p data-bbox="712 1585 906 1635">LHLDW0110CEZZ Page XX</p>

Preparation

Attaching speakers

LC-37G4U

1

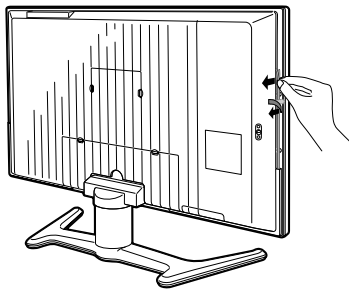

Peel off the tape holding the ends of the cables, and move cables towards behind the display.

5

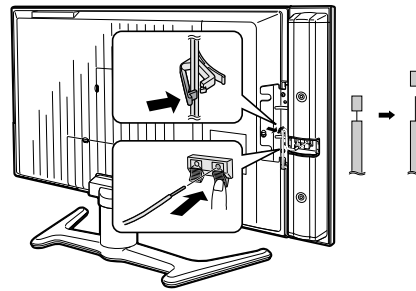

Fasten the speaker cable with the holder.
• Connect the ends of the cables to the speaker terminals as shown in the illustration.

2

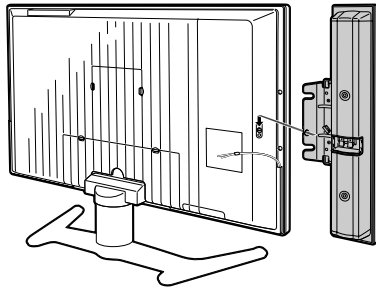

Hook the  hole of the speaker to the screw of the Display.

6

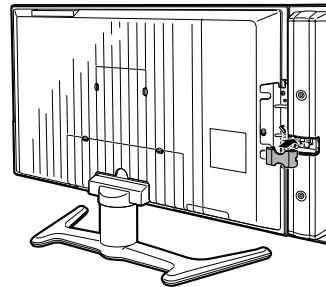

Fix the speaker terminal cover.

3

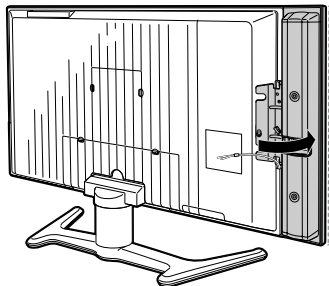

Turn the speaker to the front of the Display (direction of the arrow) and fit it to the screw hole.

7

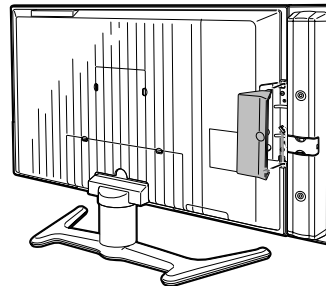

Align the nub of the bracket into the groove and fasten it.

4

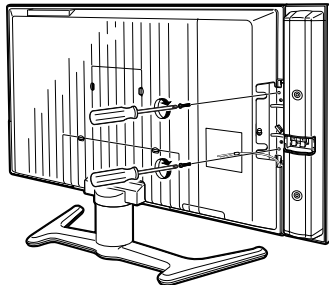

Fasten the screws.

8

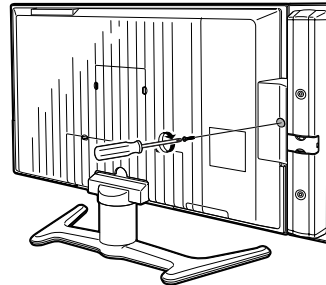

Fasten the bracket with the screw.

NOTE

- Perform the same steps for right speaker.
- To remove the speakers, perform the steps in reverse order.

Where to place the System

“System” means the Display and AVC System. First select the location where to place the System.

1 Selecting the location of the System

- Select a place with no direct sunlight and good ventilation.
- The Display and the AVC System are connected by the system cable. (See page XX for details.)

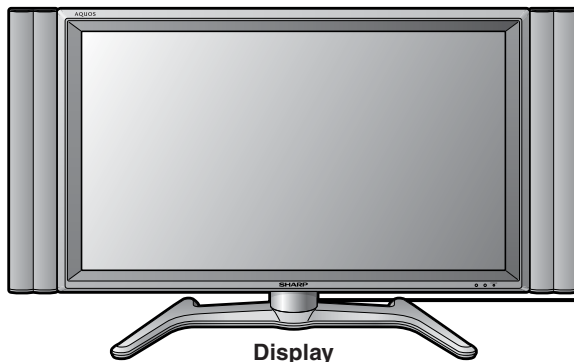
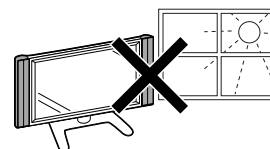

If you want to keep a longer distance between the Display and AVC System, please purchase the optional system cable AN-07SC2 (about 23 feet/7 meters). (See page XX.)

2 Setting the System in place

Handling the Display



- Do not remove the stand and speaker from the Display unless using an optional bracket to mount it.
- Keep enough space above and behind the Display.
- The Display weighs about XX kg (LC-37G4U) and XX kg (LC-32G4U). Move it with two or more people.
- When you move the Display, hold the portion of the Display, not the speaker.

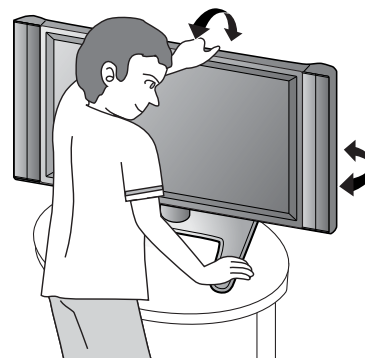

Handling the AVC System



- Do not put a VCR or other device on the AVC System.
- Keep enough space above and on the sides of the AVC System.
- Do not block the ventilation openings on the top and left side, and the exhaust fan on the right side.
- Do not spread a thick cloth beneath the AVC System, or cover it with one, as this can cause overheating and result in malfunction.



Adjust the screen with both hands. Put one hand on the Display and tilt the screen while steadying the stand with your other hand.

You can adjust the screen vertically up to 2 degrees forward or 6 degrees backward, or rotate 10 degrees horizontally.

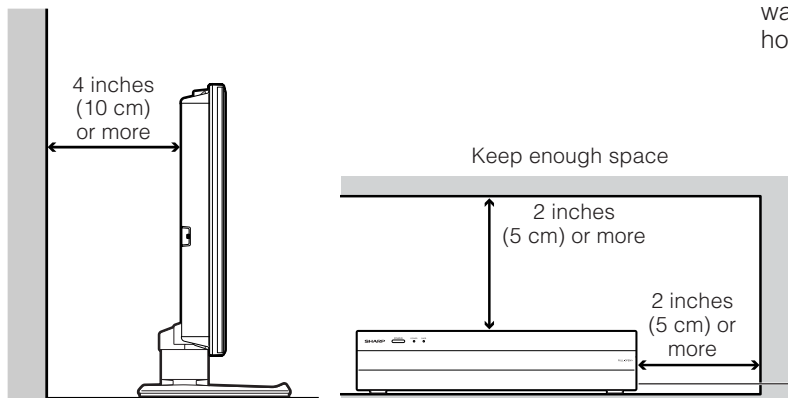

Setting the System

After putting the Display and the AVC System in place, connect the system cables and AC cords. Use the cable clamps for bundling the cables.

1 Removing the terminal cover

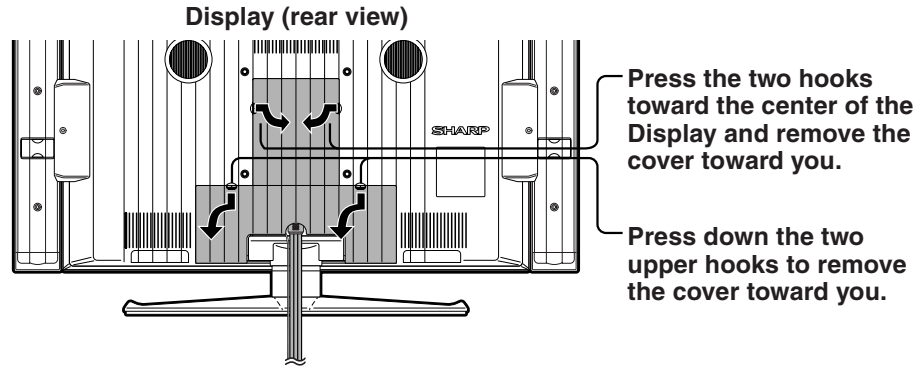

2 Connecting the system cable and the AC cord to the Display

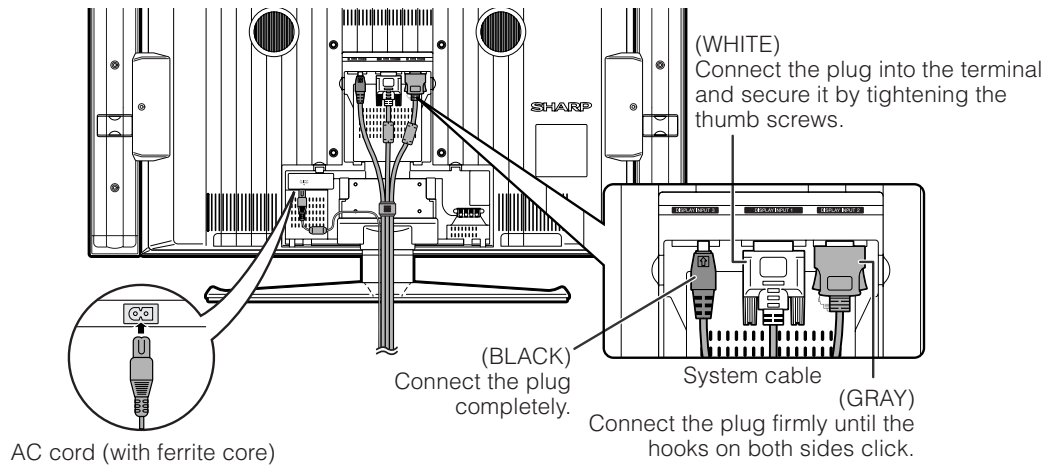

3 Connecting the system cable and the AC cord to the AVC System

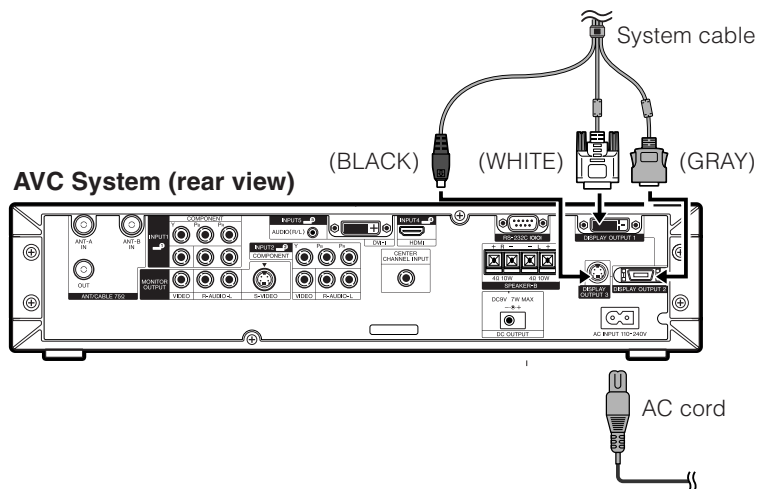

CAUTION

- TO PREVENT RISK OF ELECTRIC SHOCK, DO NOT TOUCH UN-INSULATED PARTS OF ANY CABLES WITH THE AC CORD CONNECTED.

4

Attaching the clamp and bundling the cables with the clamp

Cable clamp

Insert the cable clamp in the hole on the Display as shown.

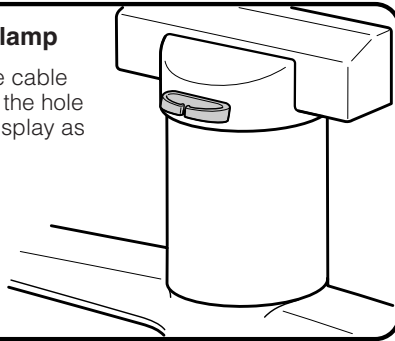

Display (rear view)

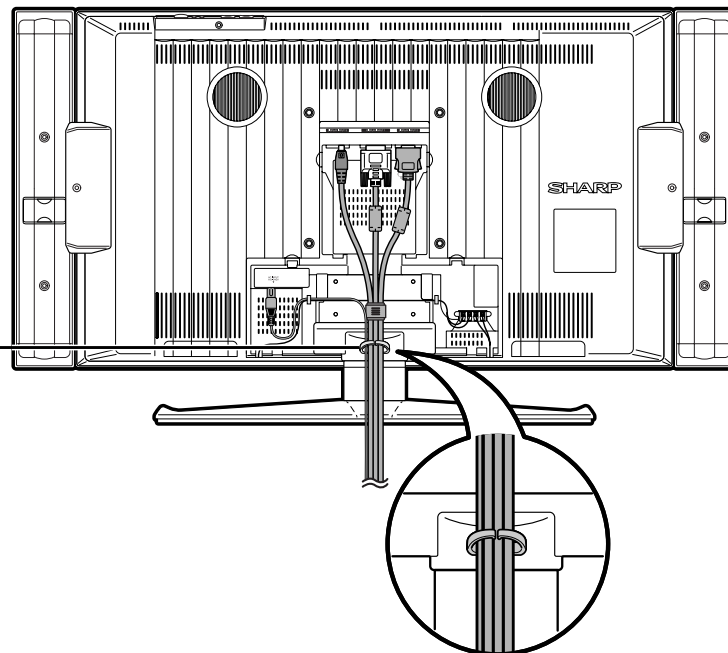

5

Closing the terminal cover

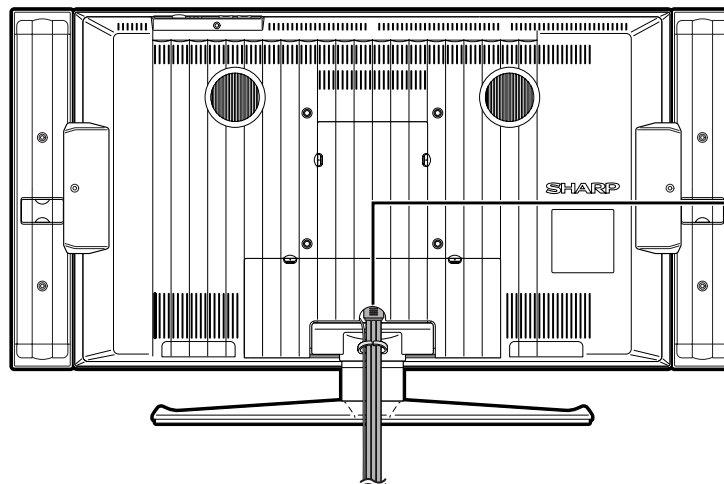

Cables come out from the small opening.

Preparation

Setting the AVC System with the stand

How to install the AVC System vertically using the stand unit.

- Use the supplied stand unit for installing the AVC System vertically in an upright position.

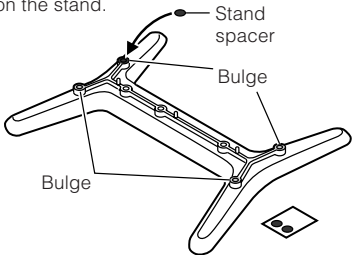
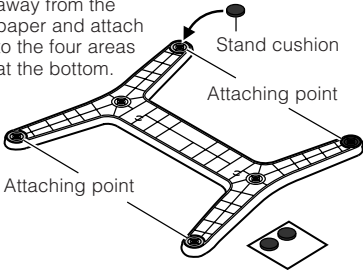
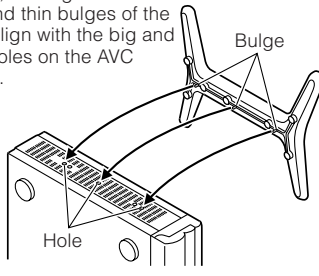
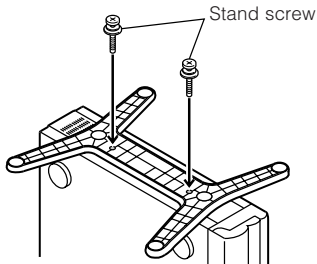
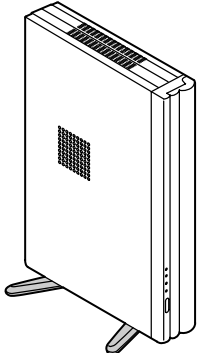
<p>1 Stick each spacer to the stand as shown.</p> <p>Peel each spacer away from the paper and attach to the four bulging areas on the stand.</p> 	<p>2 Attach each cushion to the stand as shown.</p> <p>Peel each cushion away from the paper and attach to the four areas at the bottom.</p> 	<p>3 Fit the stand to the AVC System.</p> <p>Insert the stand into the AVC System, making sure that the thick and thin bulges of the stand align with the big and small holes on the AVC System.</p> 
<p>4 Attach the stand using the stand screws as shown.</p> 	<p>The AVC System installed vertically with the stand.</p> 	

NOTE

- When mounting the AVC System vertically, always use the supplied stand. Be careful not to block vent holes when standing up directly on the floor or a flat surface as this can result in equipment failure.

Preparation

Removing speakers

LC-32G4U

1

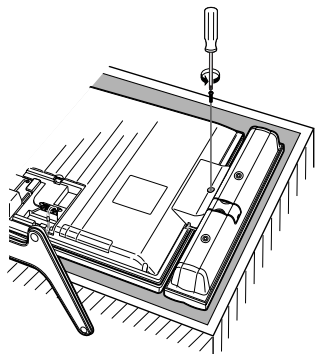

Unfasten the screw used to secure the speaker bracket.

4

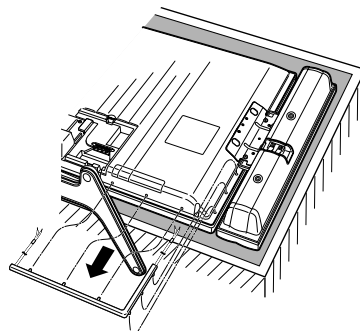

Take off the speaker cable cover.

2

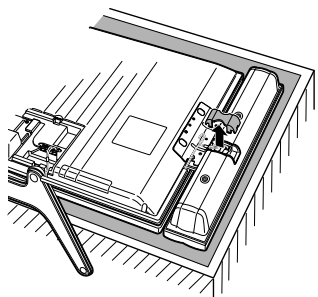

Take off the speaker terminal cover.

5

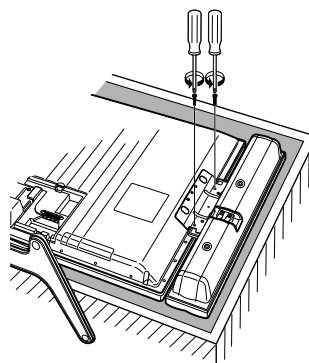

Unfasten the screws.

3

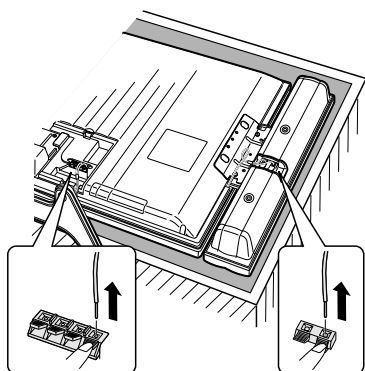

Disconnect the cable from the speaker.

CAUTION

- Do not remove the stand and speaker from the Display unless using an optional bracket to mount it.

NOTE

- Perform the same steps for right speaker.
- To attach the speakers, perform the steps in reverse order.

Preparation

Removing the stand

Before detaching (or attaching) stand, unplug the AC cord from the AC input and the system cable from the Display.



- Do not remove the stand from the Display unless using an optional wall mount bracket to mount it.

Before attaching/detaching stand

- Before performing work make sure to turn off the System.
- Before performing work spread cushioning over the base area to lay the Display on. This will prevent it from being damaged.

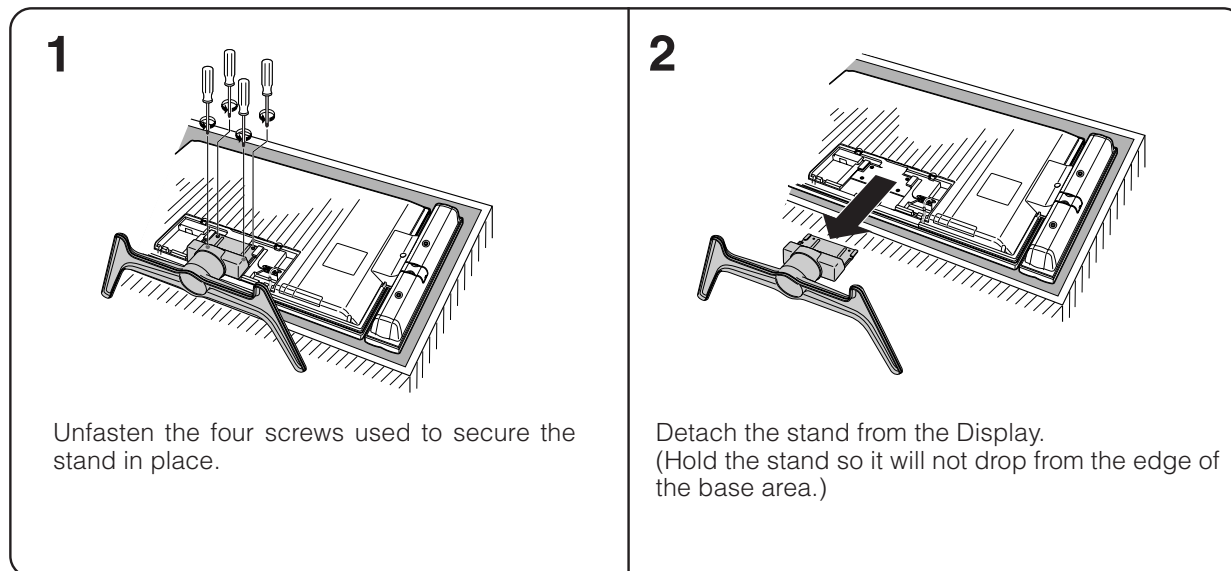

- Do not remove the stand and speaker from the Display unless using an optional bracket to mount it.



- To attach the stand, perform the above steps in reverse order.

Setting the Display on the wall



- Installing the Liquid Crystal Television requires special skill that should only be performed by qualified service personnel. Customers should not attempt to do the work themselves. SHARP bears no responsibility for improper mounting or mounting that results in accident or injury.

Using an optional bracket to mount the Display

- You can ask a qualified service personnel about using an optional AN-37AG2 bracket to mount the Display to the wall.
- Carefully read the instructions that come with the bracket before beginning work.

Hanging on the wall

AN-37AG2 wall mount bracket. (See the bracket instructions for details.)

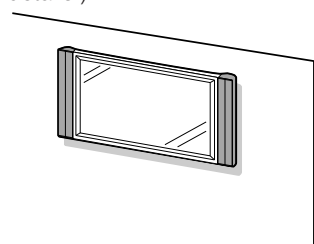

Vertical mounting

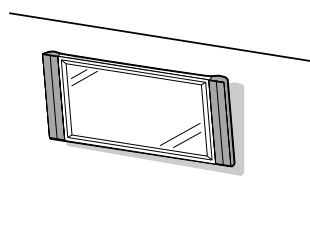

Angular mounting

About setting the Display angle

LC-37G4U

- You can set the Display on the wall up to 5 degrees forward when the speakers are attached and up to 20 degrees forward when the speakers are not attached. Do not set the angle outside those ranges.

LC-32G4U

- You can set the Display on the wall up to 15 degrees forward when the speakers are attached and up to 20 degrees forward when the speakers are not attached. Do not set the angle outside those ranges.



Preparation

Inserting the batteries

If the remote control fails to operate Liquid Crystal Television functions, replace the batteries in the remote control unit.

- 1 Open the battery cover.
- 2 Insert two “AAA” size batteries (supplied with the product).
- 3 Close the battery cover.

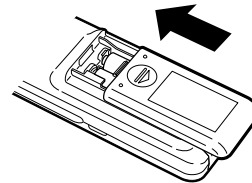
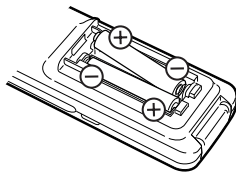
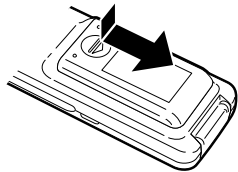

- Place the batteries with their terminals corresponding to the (+) and (-) indications in the battery compartment.

CAUTION

Improper use of batteries can result in chemical leakage or explosion. Be sure to follow the instructions below.

- Place the batteries with their terminals corresponding to the (+) and (-) indications.
- Do not mix batteries of different types. Different types of batteries have different characteristics.
- Do not mix old and new batteries. Mixing old and new batteries can shorten the life of new batteries or cause chemical leakage in old batteries.
- Remove batteries as soon as they are worn out. Chemicals that leak from batteries can cause a rash. If you find any chemical leakage, wipe thoroughly with a cloth.
- The batteries supplied with this product may have a shorter life expectancy due to storage conditions.
- If you will not be using the remote control unit for an extended period of time, remove batteries from it.

Using the remote control unit

Use the remote control unit by pointing it towards the remote control sensor on the Display. Objects between the remote control unit and the remote control sensor may prevent proper operation.

Cautions regarding remote control unit

- Do not expose the remote control unit to shock. In addition, do not expose the remote control unit to liquids, and do not place in an area with high humidity.
- Do not install or place the remote control unit under direct sunlight. The heat may cause deformation of the remote control unit.
- The remote control unit may not work properly if the remote control sensor on the Display is under direct sunlight or strong lighting. In such cases, change the angle of the lighting or the Display, or operate the remote control unit closer to the remote control sensor.

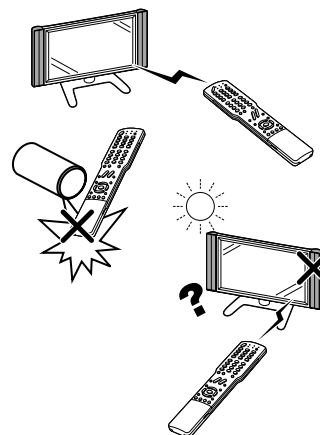

Part names

Display

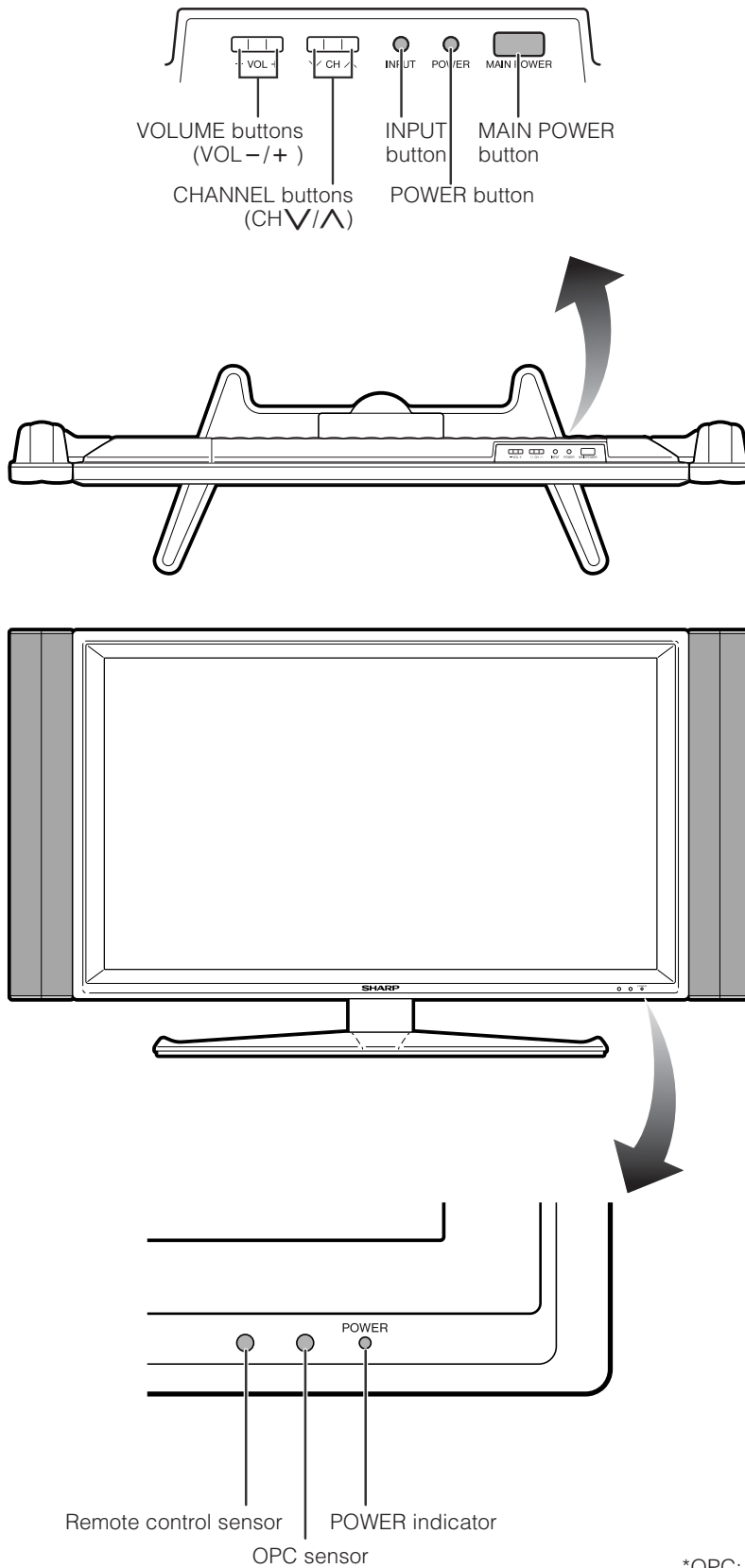

*OPC: Optical Picture Control
(See page XX.)

Part names

Bottom view

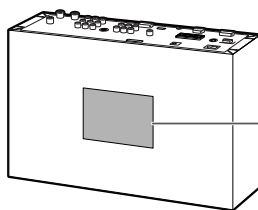

The name plate is attached on the bottom of the AVC System. Confirm it if necessary.

Remote control unit

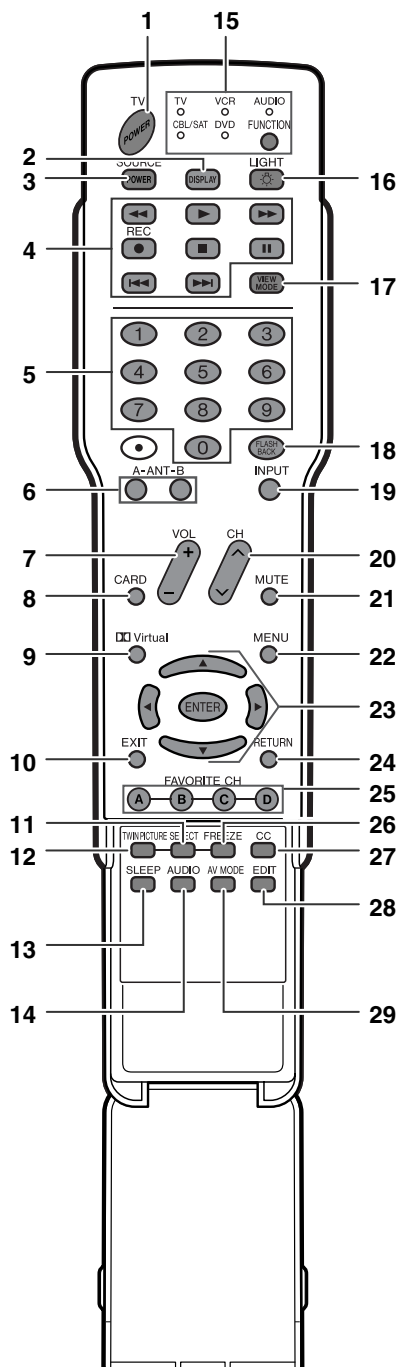

- 1 **TV POWER:** Switch the Liquid Crystal Television power on or off. (See page XX.)
- 2 **DISPLAY:** Display the channel information.
- 3 **SOURCE POWER:** Turns the power of the external equipment on and off.
- 4 **External equipment operational buttons:** Operate the external equipment.
- 5 **0 – 9:** Set the channel.
- 6 **ANT-A/B:** Select between ANT-A and B to watch broadcasts via the two tuners.
- 7 **VOL +/-:** Set the volume. (See page XX.)
- 8 **CARD:** Switch to card mode.
- 9 **Virtual:** Select Virtual Dolby Surround settings. (See page XX.)
- 10 **EXIT:** Turn off the menu screen.
- 11 **SELECT:** Select the active screen. (See page XX.)
- 12 **TWIN PICTURE:** Set the twin picture mode. Press again to return to normal screen. (See page XX.)
- 13 **SLEEP:** Set the sleep timer. (See page XX.)
- 14 **AUDIO:** Select the MTS/SAP. (See page XX.)
- 15 **FUNCTION:** Switches the remote control for TV, VCR, AUDIO, CBL/SAT and DVD operation. Indicator lights up for the current mode. (See page XX to XX for details.)
- 16 **Light icon:** When pressed all buttons on the remote control unit will light. The lighting will turn off if no operations are performed within about 5 seconds. This button is used for performing operations in dark places.
- 17 **VIEW MODE:** Select the screen size. (See pages XX and XX.)
- 18 **FLASHBACK:** Return to the previous channel or input external mode. (See page XX.)
- 19 **INPUT:** Select a Liquid Crystal Television input source. (TV, INPUT 1, INPUT 2, INPUT 3, INPUT 4, INPUT 5, Card) (See pages XX–XX and XX.)
- 20 **CH \wedge/\vee :** Select the channel.
- 21 **MUTE:** Mute the sound. (See page XX.)
- 22 **MENU:** Display the menu screen.
- 23 **Navigation arrows:** Select a desired item on the screen.
- 24 **RETURN:** Return to the previous menu screen.
- 25 **FAVORITE CH**
A, B, C, D: Select four preset favorite channels in four different categories. (See page XX for details.) You can preset up to 32 favorite channels in advance.

 While watching, you can toggle the selected channels by pressing A, B, C and D.
- 26 **FREEZE:** Set the still image. Press again to return to normal screen. (See page XX.)
- 27 **CC:** Display captions during closed-caption source. (See page XX.)
- 28 **EDIT:** Register favorite channel.
- 29 **AV MODE:** Select an audio or video setting. (See page XX.) (AV mode: STANDARD, MOVIE, GAME, USER, DYNAMIC (Fixed), DYNAMIC. PC mode: STANDARD, USER.)

NOTE

- When using the remote control unit, point it at the Liquid Crystal Television.

Watching TV

Simple operations for watching a TV program

Antennas

To enjoy a clearer picture, use an outdoor antenna. The following is a brief explanation of the types of connections that are used for a coaxial cable. If your outdoor antenna uses a 75-ohm coaxial cable with an F-type connector, plug it into the antenna terminal at the rear of the AVC System.

NOTE

- The antenna and the cable converter cannot be connected at the same time.

1. A 75-ohm system is generally a round cable with F-type connector that can easily be attached to a terminal without tools (Commercially available).
2. A 300-ohm system is a flat "twin-lead" cable that can be attached to a 75-ohm terminal through a 300/75-ohm adapter (Commercially available).

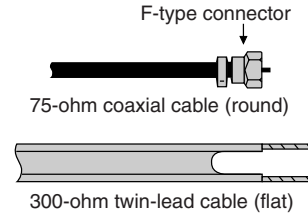

Cable converter/VCR connection

- **Be sure to connect the antenna or the cable converter as follows. Signal reception may fail if improperly connected.**
- Be sure to remember what kind of connection is made with your System.
- The connection type will determine whether to select "Air" or "Cable" for both ANT-A and B when configuring "Air/Cable" settings.

A-1. Connecting with Converter/Descrambler Box and VCR

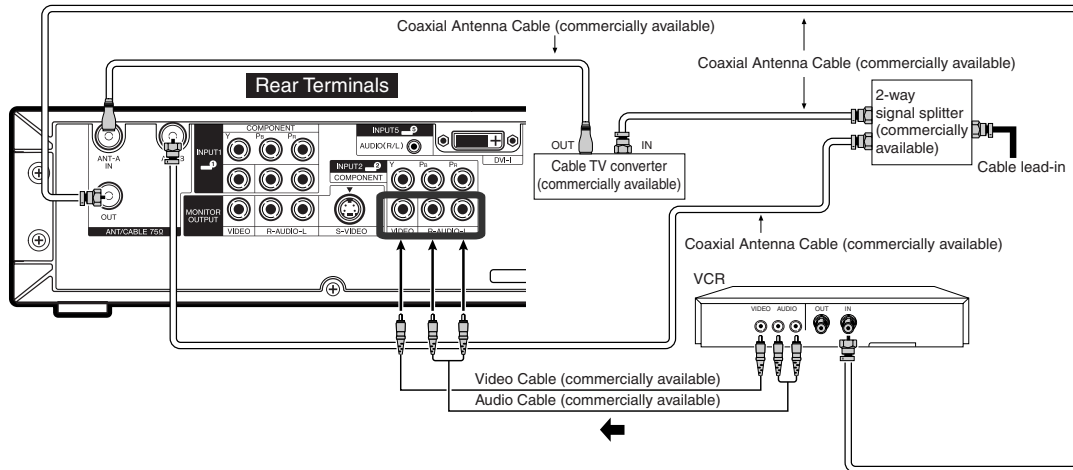

NOTE

- Be sure to remember what kind of connection is made with your System.
- Shown here is the preferred method of connecting a VCR and CATV Converter to your TV if you are in an area with good signal reception. This way you can view either TV programs or VCR tapes and not be concerned about the position of the VCR's TV/VCR switch and you can enjoy stereo tape playback from a stereo VCR.

Cable converter/VCR connection (continued)

A-2. Connecting with cable converter using AUX terminals for audio and video output.
 (If your cable TV converter has both RF OUTPUT and AUX terminals, it is recommended to connect it as shown in example A-1.)

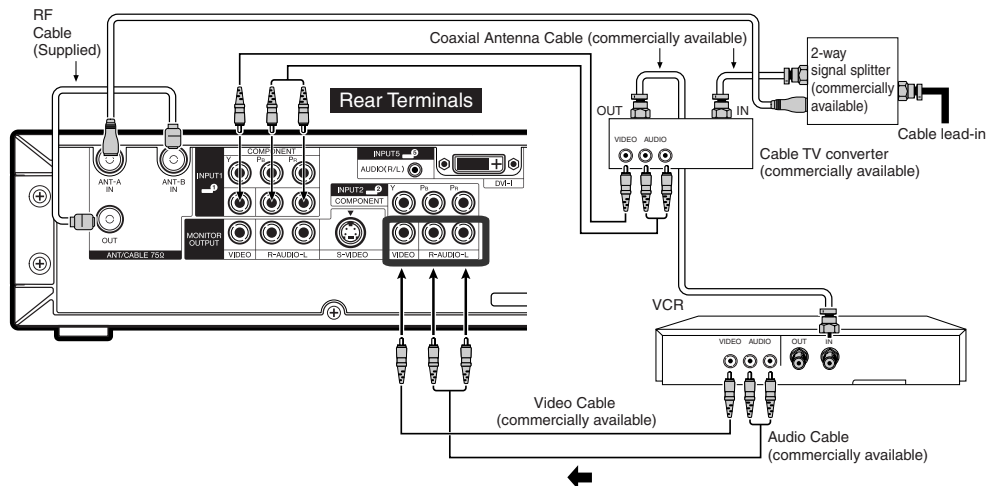

NOTE

- Be sure to remember what kind of connection is made with your System.
- Shown here is the preferred method of connecting a VCR and CATV Converter to your TV if you are in an area with good signal reception. This way you can view either TV programs or VCR tapes and not be concerned about the position of the VCR's TV/VCR switch and you can enjoy stereo tape playback from a stereo VCR.

B. Connecting with Converter/Descrambler Box without VCR

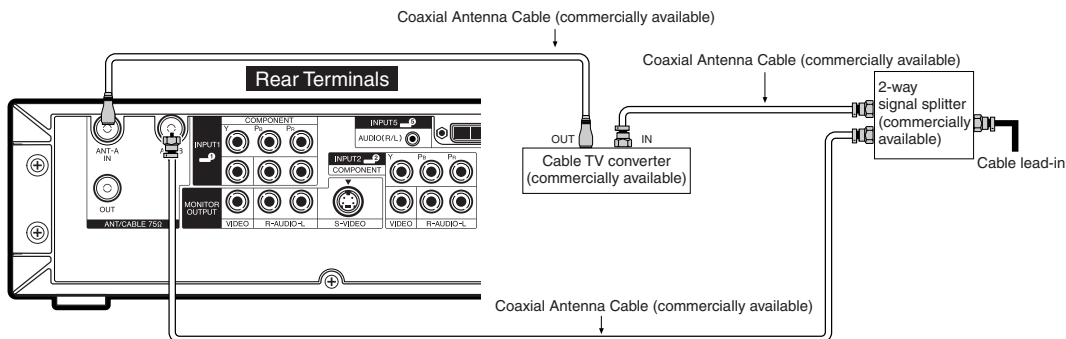

NOTE

- Be sure to remember what kind of connection is made with your System.
- Switching between Antenna-A and Antenna-B is possible by pressing the **ANT-A/B** button on the remote control.
- A good color picture depends on a good TV signal. So does good multi-channel sound. Ask your dealer for advice on how to install your outdoor antenna to receive the best possible signal.
- If you subscribe to Cable TV or have a central antenna for your building, you may not need an outdoor antenna.

C. Connecting Antenna Cable with VCR

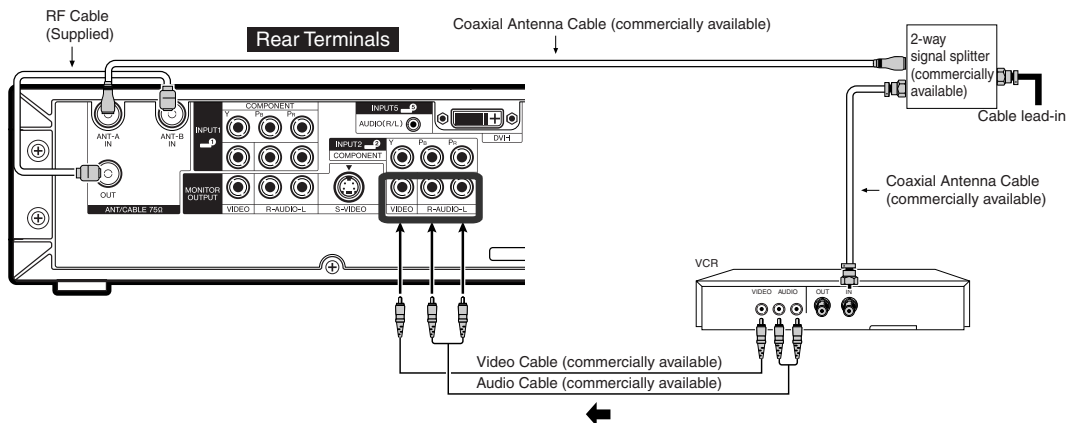

NOTE

- Be sure to remember what kind of connection is made with your System.
- Shown here is the preferred method of connecting a VCR to your TV if you are in an area with good signal reception. This way you can view either TV programs or VCR tapes and not be concerned about the position of the VCR's TV/VCR switch and you can enjoy stereo tape playback from stereo VCR.
- If your lead cable is a 300-ohm twin-lead cable or UHF/VHF separate cable, use a 300/75-ohm adapter or combiner (output side is 75-ohm coaxial) to connect to the TV (see below).

Outdoor antenna connection

Connecting Antenna Cable

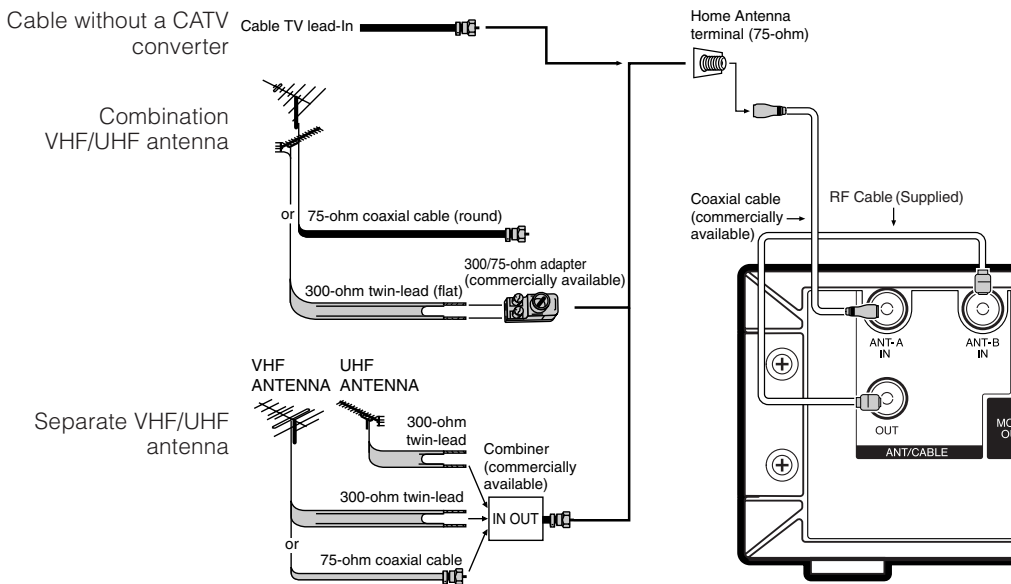

NOTICE

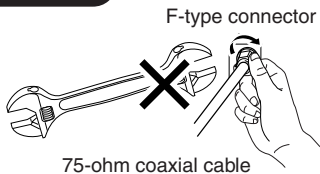

F-type connector should be finger-tightened only.

When connecting the RF cable to the TV set, do not tighten F-type connector with tools. If tools are used, it may cause damage to your TV set. (The breaking of internal circuit, etc.)

Watching TV

Connecting the AC cord

Connect the AC cords after all component connections have been completed.

Display (rear view)

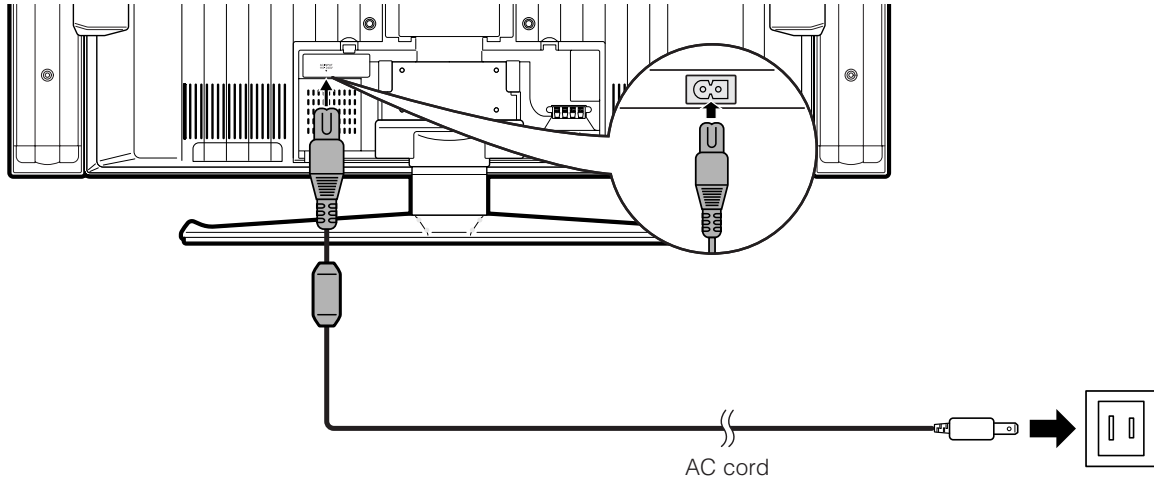

AVC System (rear view)

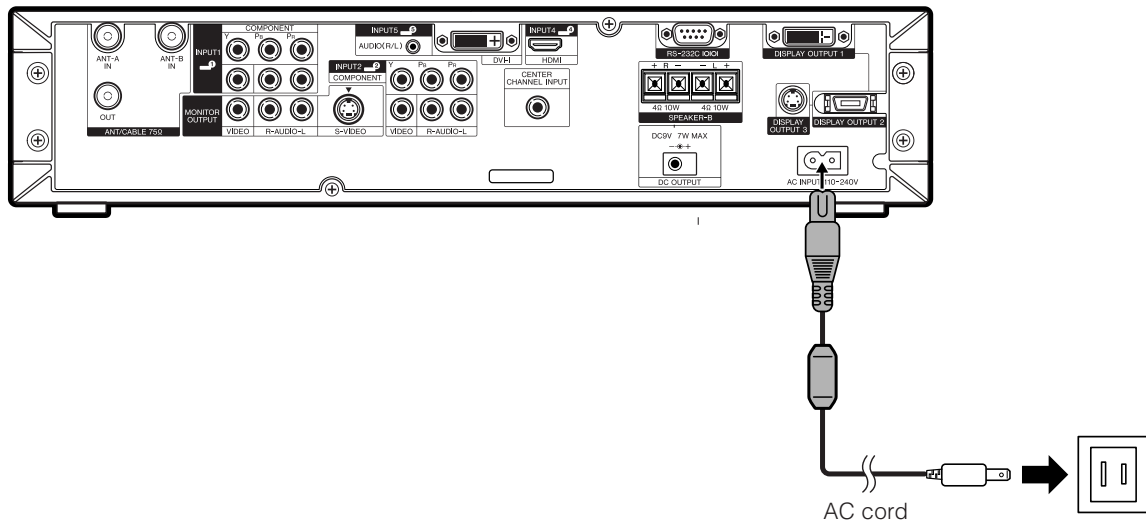

NOTE

- Always turn off the main power of the Display when connecting the AC cords.
- Disconnect the AC cords from the AC outlet, Display and AVC System when the System is not going to be used for a long period of time.

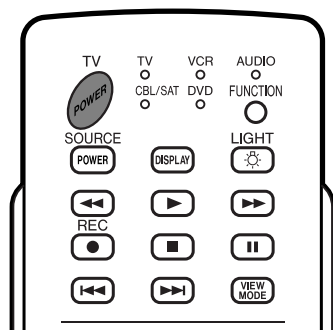
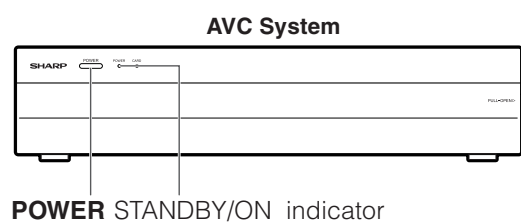
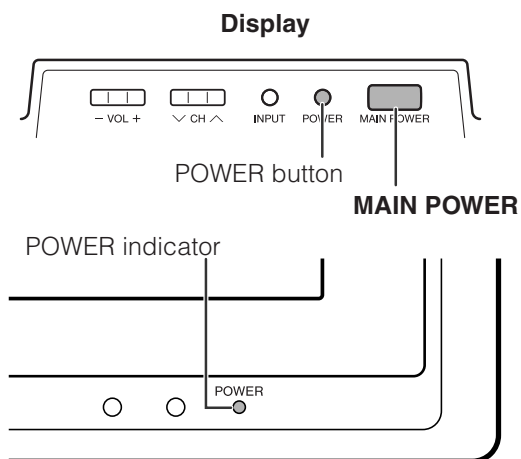

Turning on the power

Make sure that the system cable is connected before turning on the power.

1

- Press **MAIN POWER** on the Display.
- The POWER indicator on the Display lights up red.

2

- Press **POWER** on the AVC System.
- The System turns the power on.
- The POWER indicator on the Display lights up green and the STANDBY/ON indicator on the AVC System lights up green.
- If the STANDBY/ON indicator on the AVC System and the POWER indicator on the Display still light up red, press **TV POWER** on the remote control unit or **POWER** on the AVC System to turn the System on.

NOTE

- The initial setup starts when the System powers on for the first time. If the System has been turned on before, the EZ setup will not be invoked. See page 27 to try EZ setup from the Setup menu.

Turning off the power

Press **TV POWER** on the remote control unit or POWER button on the Display.

- The System enters standby mode and the image on the screen disappears.
- Both the STANDBY/ON indicator on the AVC System and the POWER indicator on the Display change from green to red.

Press **MAIN POWER** on the Display.

- The POWER indicator on the Display gradually turns off.

NOTE

- If you are not going to use this System for a long period of time, be sure to remove the AC cords from the power outlet.

Display status indicator

Off	Power off
Red	The System is in standby mode.
Green	The System is on.

AVC System status indicator

Off	Power off
Red	The System is in standby mode.
Green	The System is on or only the AVC System is on.

NOTE

- Check if the system cable is connected properly when display indicator flashes red.

Initial setup

When you turn on the System for the first time, it will automatically memorize the broadcasting channels where you live. Perform the following steps before you press **TV POWER** on the remote control unit.

1. Insert the batteries into the remote control unit. (See page XX.)
2. Connect the antenna cable to the AVC System. (See pages XX to XX.)
3. Plug in the AC cord to the AC outlet. (See page XX.)

Language setting

Select from among 3 languages: English, French and Spanish.

1

Press **▲/▼** to select the desired language listed on the screen, and then press **ENTER**.

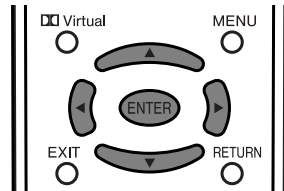

Antenna setting

Make sure what kind of connection is made with your System when selecting "Air" or "Cable" for both ANT-A and B.

2

Press **◀/▶** to select "Air" or "Cable" for ANT-A, then press **▲/▼** to move down. Press **◀/▶** to select "Air" or "Cable" for ANT-B. Press **ENTER** to enter the setting.

- This operation makes the System search for both ANT-A and B.
- There are 3 kinds of CATV system, including Standard, HRC and IRC. Select the one matches to your system. Select Auto when you do not know which one to select.

Example

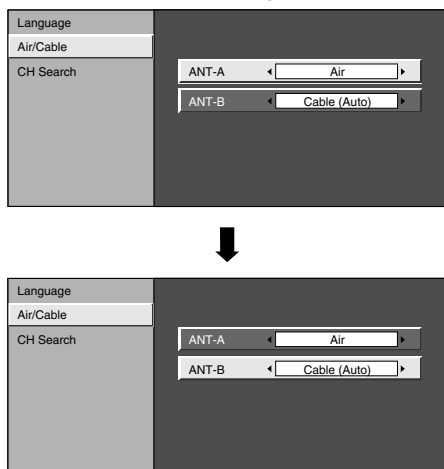

3

Press **◀/▶** to select "Yes" for ANT-A, then press **▲/▼** to move down. Press **◀/▶** to select "Yes" for ANT-B, then press **▲/▼** to move down to select "Search Start", and press **ENTER**.

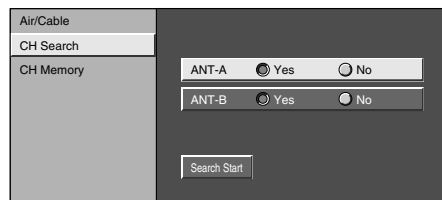

Example

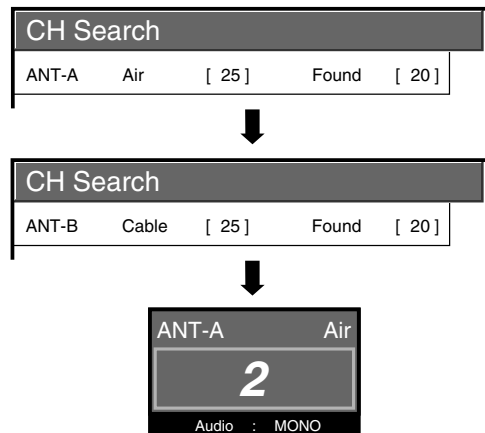

NOTE

- Make sure what kind of connection is made with your System when selecting "Air" or "Cable" for both ANT-A and B.
- If no channel is found, make sure what kind of connection is made with your System and try EZ setup again (see page XX).
- The illustrations and on-screen displays in this operation manual are for explanation purposes and may vary slightly from the actual operations.

Simple button operations for changing channels

You can change channels in several ways.

NOTE

- While watching a broadcast, press **ANT-A/B** to view the image received from the other tuner.

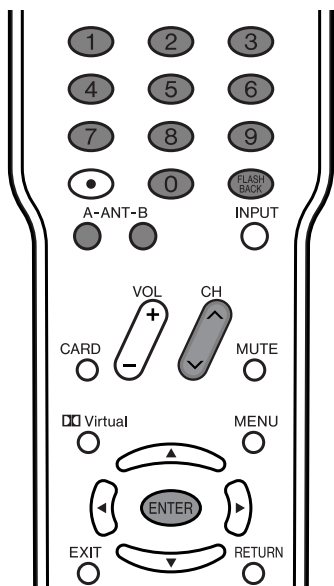

Using CH \wedge / \vee on the remote control unit

- Press **CH \wedge** to increase the channel number.
- Press **CH \vee** to decrease the channel number.

NOTE

- **CH \vee / \wedge** on the Display operates the same as **CH \wedge / \vee** on the remote control unit.

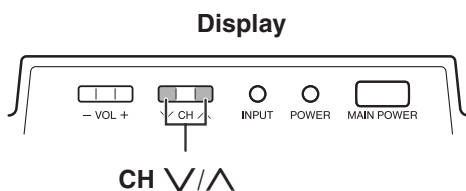

Changing channels with CH \wedge / \vee on the remote control unit or CH \vee / \wedge on the Display

Air: Press **CH \wedge** and the channel change in the order shown below:

2→3→...→68→69→2→3...

Press **CH \vee** and the channel change in the order shown below:

3→2→69→68→...→3→2...

Cable: Press **CH \wedge** and the channel change in the order shown below:

1→2→3→...→125→1→2→3...

Press **CH \vee** and the channel change in the order shown below:

3→2→1→125→...→3→2→1→...

Using FLASHBACK on the remote control unit

Press **FLASHBACK** to switch the currently tuned channel to the previously tuned channel.

Press **FLASHBACK** again to switch back to the currently tuned channel.

Press **FLASHBACK** to toggle between the currently selected input source and the previously selected one.

NOTE

- **FLASHBACK** will not work if no channel has been changed after the System is turned on.

Using 0 – 9 on the remote control unit

Select the channels directly by pressing buttons **0** to **9**.

- The System allows you to select up to 125 channels (1 to 125). To select a channel, enter a 2 or 3-digit number.

EXAMPLE

To select a 1 or 2-digit channel number (e.g., Channel 5):

Complete the following steps within 3 seconds.

- 1 Press the **0** button.
 - Complete the step 2 within 3 seconds after the step 1.

- 2 Press the **5** button.

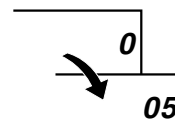

- 3 Press **ENTER** to enter the setting.
 - Channel selection will be made if there is no operations for 3 seconds.

NOTE

- When selecting a 1-digit channel number, do not fail to press the **0** button.

To select a 3-digit channel number (e.g., Channel 115):

Complete the following steps within 3 seconds.

- 1 Press the **1** button.
 - Complete the step 2 within 3 seconds after the step 1.

- 2 Press the **1** button again.
 - Complete the step 3 within 3 seconds after the step 2.

- 3 Press the **5** button.

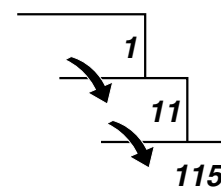

- 4 Press **ENTER** to enter the setting.
 - Channel selection will be made if there is no operations for 3 seconds.

Simple button operations for changing volume/sound

■ Changing the volume

You can change the volume on the Display or on the remote control unit.

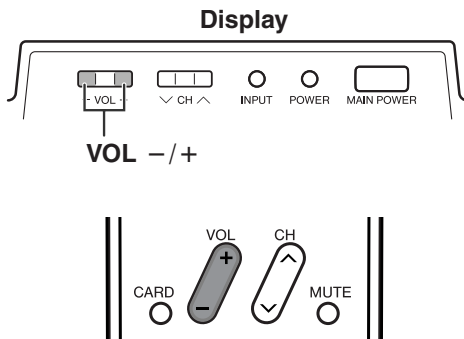

■ Using VOL +/- on the remote control unit

- To increase the volume, press **VOL +**.
- To decrease the volume, press **VOL -**.

Volume adjustment



NOTE

- **VOL -/+** on the Display operates the same as **VOL +/-** on the remote control unit.

Audio status

Output device	Output Select	
	Fixed	Variable
Speaker	Variable sound	Mute
MONITOR OUT	Constant as specified	Variable sound

* When "Output Select" is set to "Variable", the indicator on the screen changes as shown below.



NOTE

- See page XX for details on the audio out function.

■ Using MUTE on the remote control unit

Mutes the current sound output.

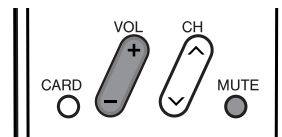

1

Press **MUTE**.

- "Mute" has been displayed on the screen for 30 minutes, and the sound is silenced.

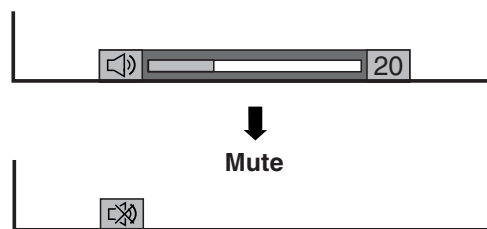

NOTE

- Within 30 minutes of pressing **MUTE**, mute can be canceled by using one of the methods below.
 - Pressing **VOL -/+** on the Display or **VOL +/-**, **MTS** or **MUTE** on the remote control unit can also cancel the mute.
- **Mute will be canceled after 30 minutes have passed. However, the System will not suddenly output a loud sound as the volume level is set to 0 automatically.**

2

Within 30 minutes, press **MUTE** again to cancel the mute.

- Before 30 minutes, the volume level returns to the previous setting.
- After 30 minutes, increase the volume level by pressing **VOL +**.

■ Using Virtual on the remote control unit

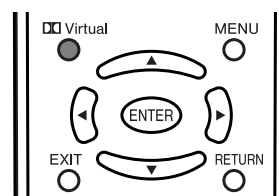

Virtual produces Dolby virtual effect from the speakers. Each time you press **Virtual**, the mode changes between On and Off.

Dolby Virtual sound options

- On: Makes it possible to enjoy natural, realistic surround sound.
- Off: Outputs the normal sound.



NOTE

- You can have the same settings by choosing "Dolby Virtual" on the menu items. (See page XX.)

Setting MTS/SAP stereo mode

The System has a feature that allows reception of sound other than the main audio for the program. This feature is called Multi-channel Television Sound (MTS). The System with MTS can receive mono sound, stereo sound and Secondary Audio Programs (SAP). The SAP feature allows a TV station to broadcast other information, which could be audio in another language or something completely different like weather information.

You can enjoy Hi-Fi stereo sound or SAP broadcasts where available.

- **Stereo broadcasts**
View programs like live sporting events, shows and concerts in dynamic stereo sound.
- **SAP broadcasts**
Receive TV broadcasts in either MAIN or SAP sound.
MAIN sound: The normal program soundtrack (either in mono or stereo).
SAP sound: Listen to second language, supplementary commentary and other information. (SAP is mono sound.)

If stereo sound is difficult to hear.

- Obtain a clearer sound by manually switching to fixed mono-sound mode.

NOTE

- Once "MONO" mode is selected, the sound remains mono even if the System receives a stereo broadcast. You must switch the mode back to "STEREO" if you want to hear stereo sound again.
- Selecting MTS while in the input mode does not change the type of sound. In this case, sound is determined by the video source.

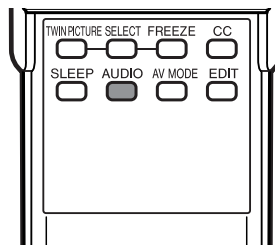

Each time you press **AUDIO**, MTS toggles as shown below.

Examples: when receiving MTS and SAP

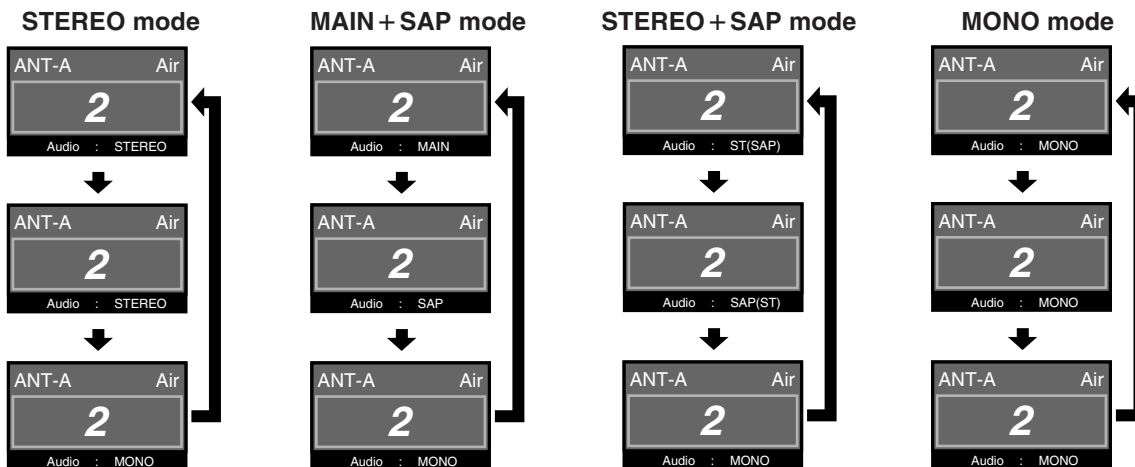

Basic adjustment settings

AV input mode menu items

List of AV menu items to help you with operations



OPC	Page XX
Backlight	Page XX
Contrast	Page XX
Brightness	Page XX
Color	Page XX
Tint	Page XX
Sharpness	Page XX
Advanced	
C.M.S.	Page XX
Color Temp.	Page XX
Black	Page XX
3D-Y/C	Page XX
Monochrome	Page XX
Film Mode	Page XX
I/P Setting	Page XX

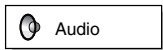

Treble	Page XX
Bass	Page XX
Balance	Page XX
Dolby Virtual	Page XX

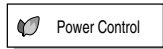

No Signal Off	Page XX
No Operation Off	Page XX

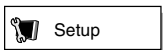

EZ Setup	Page XX
CH Setup	Pages XX-XX
Speaker	Page XX
Input Label	Page XX
Input Signal	Page XX
Parental CTRL	Pages XX-XX
Position	Page XX
Picture Flip	Page XX
Language	Page XX

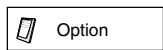

Audio Only	Page XX
Digital Noise Reduction	Page XX
Input Select	Page XX
Output Select	Page XX
Quick Shoot	Page XX
Center Channel Input	Page XX
Caption Setup	Page XX

PC input mode menu items

List of PC menu items to help you with operations



OPC	Page XX
Backlight	Page XX
Contrast	Page XX
Brightness	Page XX
Red	Page XX
Green	Page XX
Blue	Page XX
Advanced	
C.M.S.	Page XX

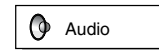

Treble	Page XX
Bass	Page XX
Balance	Page XX
Dolby Virtual	Page XX

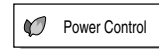

Power Management	Page XX
------------------------	---------

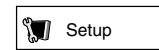

Speaker	Page XX
Input Signal	Page XX
Auto Sync.	Page XX
Fine Sync.	Page XX
Picture Flip	Page XX
Language	Page XX

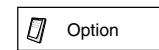

Audio Only	Page XX
Output Select	Page XX
Quick Shoot	Page XX

Basic adjustment settings

EZ setup

You can run EZ Setup again, even after setting up the preset channels.

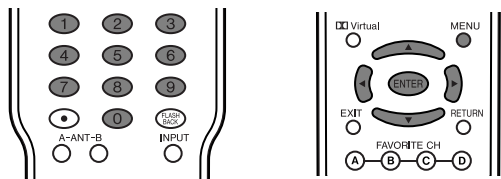

Language setting

Select from among 3 languages: English, French and Spanish.

1 Press **MENU** and the MENU screen displays.

2 Press **◀/▶** to select "Setup".

3 Press **▲/▼** to select "EZ Setup", and then press **ENTER**.

- If you already set the Secret No., go to step 4. If not, skip to step 5.

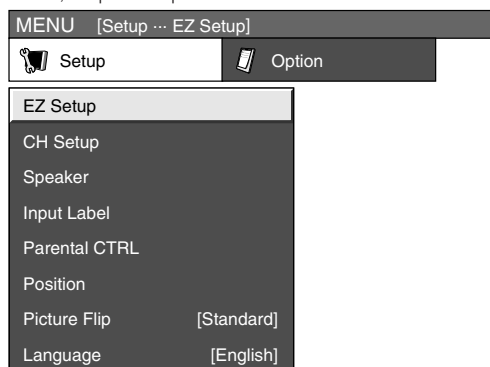

4 Input the 4-digit secret number by using **0 - 9**.

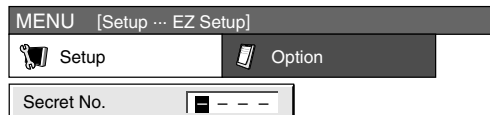

5 Press **▲/▼** to select the desired language listed on the screen, and then press **ENTER**.



Antenna setting

Make sure what kind of connection is made with your System when selecting "Air" or "Cable" for both ANT-A and B.

6 Press **◀/▶** to select "Air" or "Cable" for ANT-A, then press **▲/▼** to move down.

Press **◀/▶** to select "Air" or "Cable" for ANT-B.

Press **ENTER** to enter the setting.

- This operation makes the System search for both ANT-A and B.
- There are 3 kinds of CATV system, including Standard, HRC and IRC. Select the one matches to your system. Select Auto when you do not know which one to select.

Example

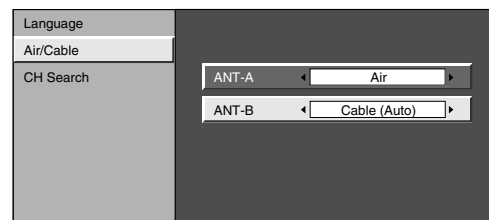
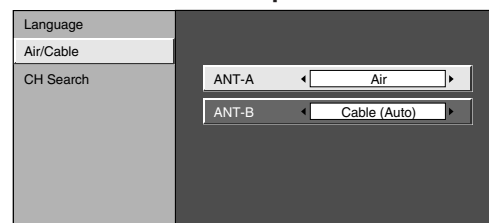

Channel search

Channel auto search makes the System look for all channels viewable in the set area.

7 Press **◀/▶** to select "Yes" for ANT-A, then press **▲/▼** to move down.

Press **◀/▶** to select "Yes" for ANT-B, then press **▲/▼** to move down to select "Search Start", and press **ENTER**.

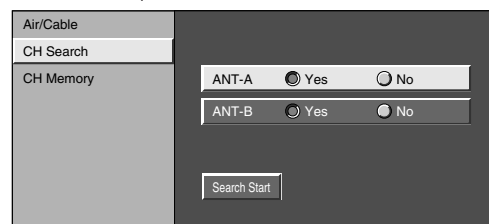

Searching TV channels Example

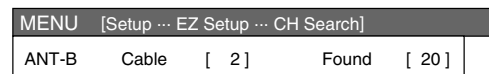
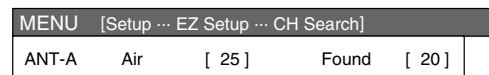

NOTE

- If no channel is found, make sure what kind of connection is made with your System and try EZ setup again.
- Make sure what kind of connection is made with your System when selecting "Air" or "Cable" for both ANT-A and B.

Basic adjustment settings

Channel setup

If initial setup does not memorize all the channels in your region, follow the instructions below to manually memorize the channels.

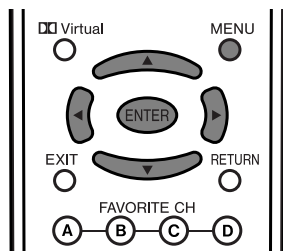

Antenna setting

1 Press **MENU** and the MENU screen displays.

2 Press **◀/▶** to select "Setup".

3 Press **▲/▼** to select "CH Setup", and then press **ENTER**.

- If you already set the Secret No., input the 4-digit secret number here. See page XX for setting a secret number.

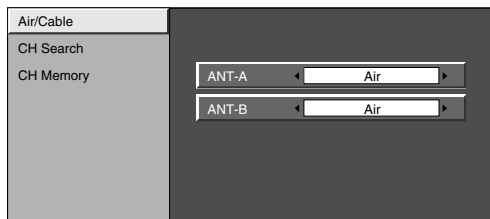

4 Press **▲/▼** to select "Air/Cable", and then press **ENTER**.

5 Press **◀/▶** to select "Air" or "Cable" for ANT-A, then press **▲/▼** to move down. Press **◀/▶** to select "Air" or "Cable" for ANT-B. Press **ENTER** to enter the setting.

Example

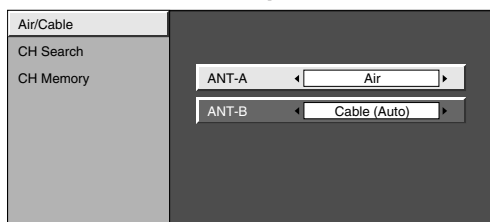

NOTE

- Make sure what kind of connection is made with your System when selecting "Air" or "Cable" for both ANT-A and B.
- There are 3 kinds of CATV system, including Standard, HRC and IRC. Select the one matches to your system. Select Auto when you do not know which one to select.

Channel search

Channel auto search makes the System look for all channels viewable in the set area.

1 Press **MENU** and the MENU screen displays.

2 Press **◀/▶** to select "Setup".

3 Press **▲/▼** to select "CH Setup", and then press **ENTER**.

- If you already set the Secret No., input the 4-digit secret number here. See page XX for setting a secret number.

4 Press **▲/▼** to select "CH Search", and then press **ENTER**.

5 Press **◀/▶** to select "Yes" for ANT-A, then press **▲/▼** to move down. Press **◀/▶** to select "Yes" for ANT-B, then press **▲/▼** to move down to select "Search Start", and press **ENTER**.

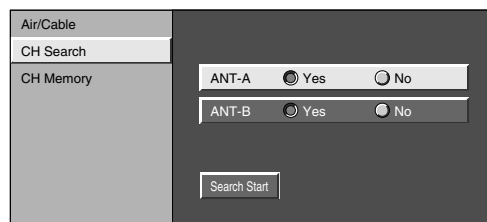

Example

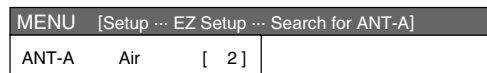

NOTE

- Make sure what kind of connection is made with your System.

Basic adjustment settings

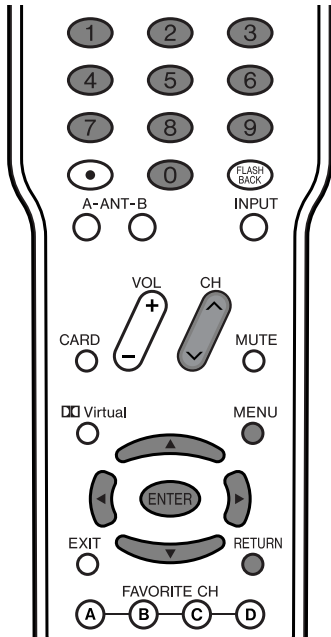

7

Press ▲/▼ to select “Skip”, and press ◀/▶ to select “On” or “Off”.

- On: Skips channels. (Channel selection disabled using **CH▲/▼**.)
- Off: Does not skip channels. (Channel selection enabled using **CH▲/▼**.)

NOTE

- Make sure what kind of connection is made with your System.

Channel memory setting

1

Press **MENU** and the MENU screen displays.

2

Press ◀/▶ to select “Setup”.

3

Press ▲/▼ to select “CH Setup”, and then press **ENTER**.

- If you already set the Secret No., input the 4-digit secret number here. See page XX for setting a secret number.

4

Press ▲/▼ to select “CH Memory”, and then press **ENTER**.

Example

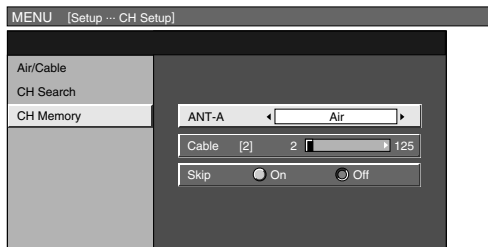

5

Press ◀/▶ to select ANT-A or B.

6

Press ▲/▼ and press ◀/▶ to select the channel you want to skip or not.

Basic adjustment settings

Favorite channel setting

This function allows you to program 4 favorite channels, in 4 different categories. By setting the favorite channels in advance, you can select your favorite channels easily.

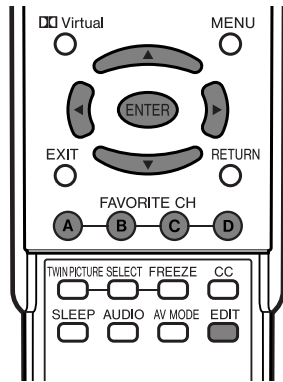

1 Select the channel you want to register as a favorite channel.

2 Press **EDIT**.

3 Press **▲/▼** to select "Register", and then press **ENTER**.



4 Press **▲/▼/◀/▶** to select the position in the area, and then press **ENTER** to register.

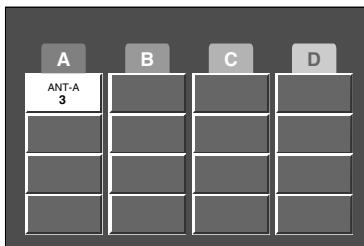

Delete favorite channel

1 Press **EDIT** and the favorite channel screen displays.

2 Press **▲/▼** to select "1 Data Clear", and then press **ENTER**.

3

Press **▲/▼/◀/▶** to select the channel you want to delete, and then press **ENTER**.

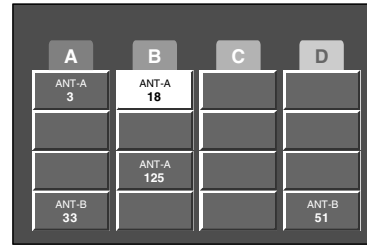

NOTE

- You can delete all the favorite channels by selecting "All Data Clear" at step 2 in Delete favorite channel.

Basic adjustment settings

Language setting

You can also select a language from the Setup menu. Select from among 3 languages: English, French and Spanish.

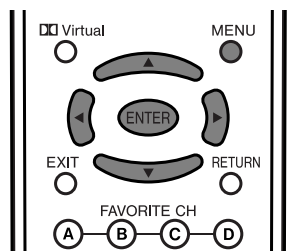

1 Press **MENU** and the MENU screen displays.

2 Press **◀/▶** to select "Setup".

3 Press **▲/▼** to select "Language", and then press **ENTER**.

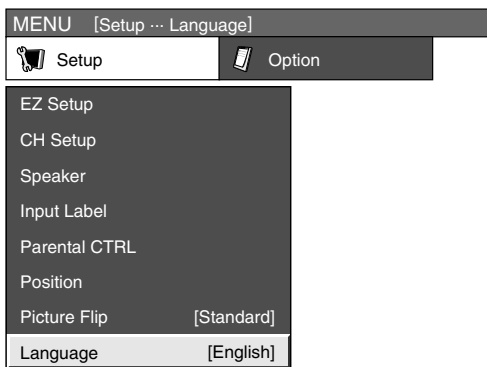

4 Press **▲/▼** to select the desired language listed on the screen, and then press **ENTER**.



Basic adjustment settings

OPC setting

Automatically adjusts the brightness of the screen.

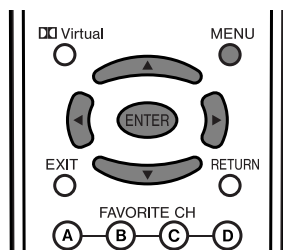

AV input mode

1 Press **MENU** and the MENU screen displays.

2 Press **◀/▶** to select "Picture".

3 Press **▲/▼** to select "OPC".

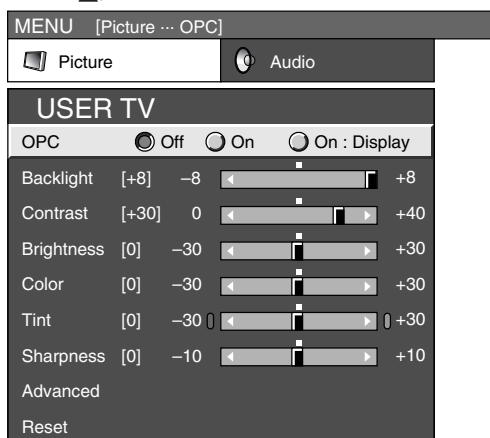

4 Press **◀/▶** to select "On".

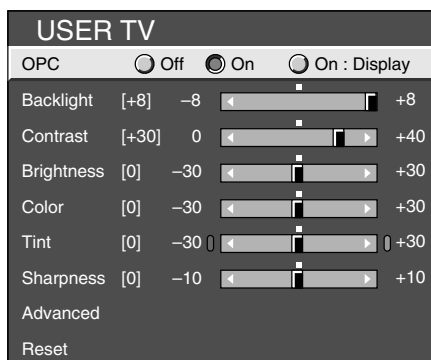

NOTE

- When set to "On", senses the surrounding light and automatically adjusts the backlight brightness. Make sure no object obstructs the OPC sensor, which could affect its ability to sense surrounding light.

PC input mode

1 Press **MENU** and the MENU screen displays.

2 Press **◀/▶** to select "Picture".

3 Press **▲/▼** to select "OPC".

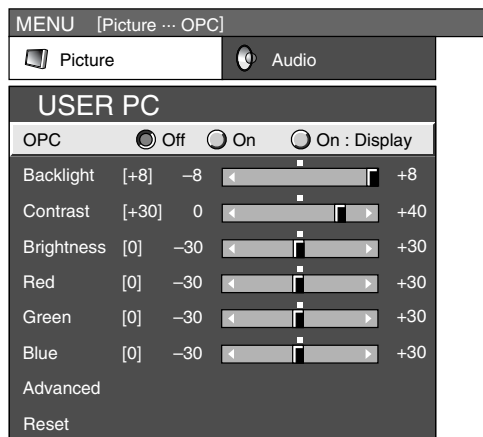

4 Press **◀/▶** to select "On".

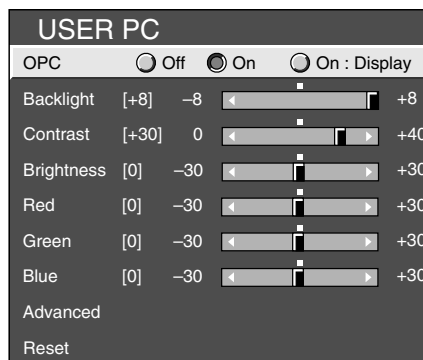

Selected item	Description
Off	No adjustment
On	Automatically adjusts
On: Display	Displays the OPC effect on the screen while adjusting the brightness of the screen.

NOTE

- When set to "On: Display", OPC effect displays on the screen while OPC is adjusting the screen brightness.

Basic adjustment settings

Picture adjustments

Adjusts the picture to your preference with the following picture settings.

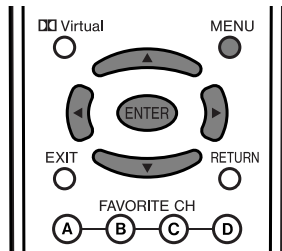

1

Press **MENU** and the MENU screen displays.

2

Press ◀▶ to select "Picture".

3

Press ▲/▼ to select a specific adjustment item.

4

Press ◀▶ to adjust the item to your desired position.

NOTE

- For resetting all adjustment items to factory preset values, press ▲/▼ to select "Reset", press **ENTER**, press ◀▶ to select "Yes", and then press **ENTER**.

Adjustments items for AV source

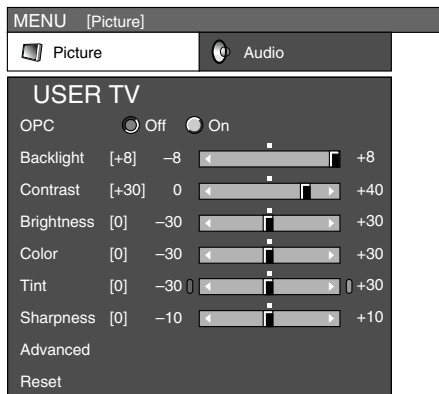

Adjustments items for PC source

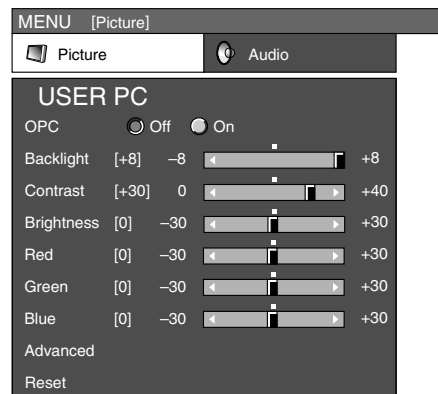

Selected item	◀ button	▶ button
Backlight	The screen dims	The screen brightens
Contrast	For less contrast	For more contrast
Brightness	For less brightness	For more brightness
Color	For less color intensity	For more color intensity
Tint	Skin tones become purplish	Skin tones become greenish
Sharpness	For less sharpness	For more sharpness

NOTE

- Select "Advanced" and then press **ENTER** to set "C.M.S-Hue", "C.M.S-Saturation", "C.M.S-Value", "Color Temp.", "Black", "3D-Y/C", "Monochrome", "Film Mode" or "I/P Setting". See pages XX to XX.

Selected item	◀ button	▶ button
Backlight	The screen dims	The screen brightens
Contrast	For less contrast	For more contrast
Brightness	For less brightness	For more brightness
Red	For weaker red	For stronger red
Green	For weaker green	For stronger green
Blue	For weaker blue	For stronger blue

NOTE

- Select "Advanced" and then press **ENTER** to set "C.M.S-Hue", "C.M.S-Saturation" and "C.M.S-Value".

Basic adjustment settings

C.M.S. (Color Management System)

Color tone is managed using the six-color adjustment setting.

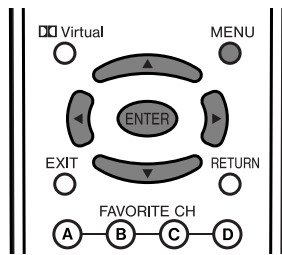

AV input mode

1 Press **MENU** and the MENU screen displays.

2 Press **◀/▶** to select "Picture".

3 Press **▲/▼** to select "Advanced", and then press **ENTER**.

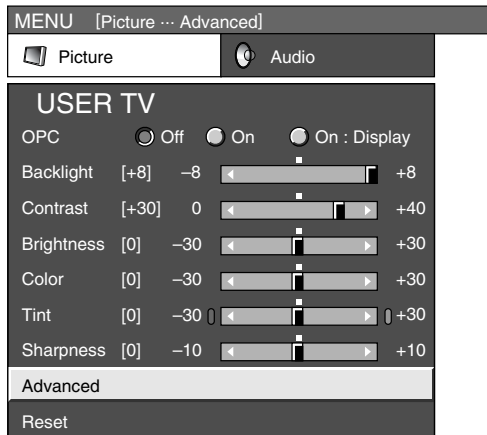

4 Press **▲/▼** to select "C.M.S-Hue", and then press **ENTER**.

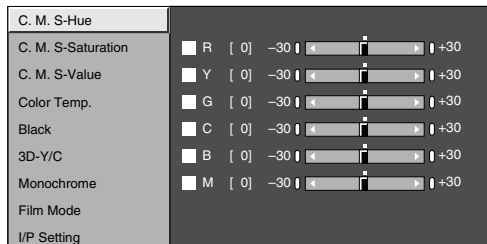

5 Press **▲/▼** to select a specific adjustment item. Press **◀/▶** to adjust the item to your desired position.

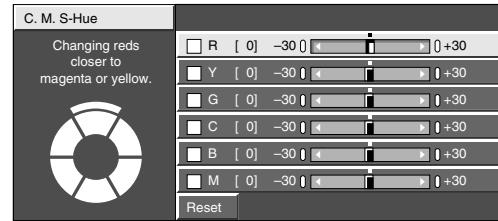

NOTE

- For resetting all adjustment items to the factory preset values, press **▲/▼** to select "Reset", and then press **ENTER**.
- To perform "C.M.S-Saturation" or "C.M.S-Value", select the one you like to adjust in step 4 above and follow the step 5 to adjust the items.

PC input mode

1 Press **MENU** and the MENU screen displays.

2 Press **◀/▶** to select "Picture".

3 Press **▲/▼** to select "Advanced", and then press **ENTER**.

4 Press **▲/▼** to select "C.M.S-Hue", and then press **ENTER**.

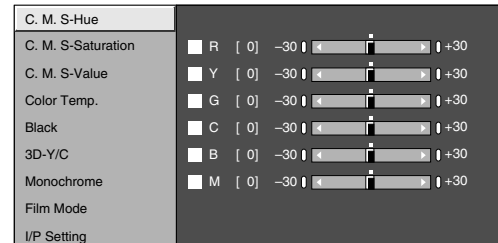

5 Press **▲/▼** to select a specific adjustment item. Press **◀/▶** to adjust the item to your desired position.

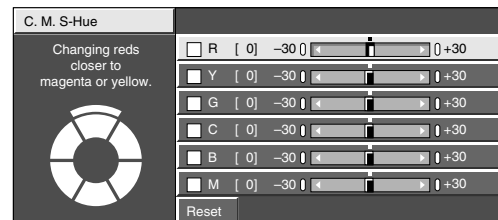

NOTE

- For resetting all adjustment items to the factory preset values, press **▲/▼** to select "Reset", and then press **ENTER**.
- To perform "C.M.S-Saturation" or "C.M.S-Value", select the one you like to adjust in step 4 above and follow the step 5 to adjust the items.

Basic adjustment settings

Color temperature

Adjusts the color temperature to give a better white balance.

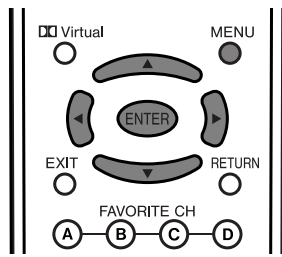

1 Press **MENU** and the MENU screen displays.

2 Press **◀/▶** to select "Picture".

3 Press **▲/▼** to select "Advanced", and then press **ENTER**.

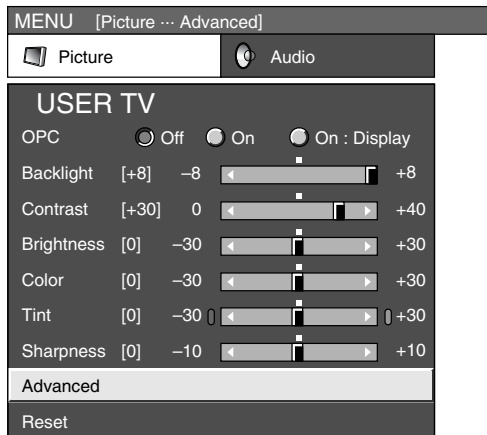

4 Press **▲/▼** to select "Color Temp.", and then press **ENTER**.

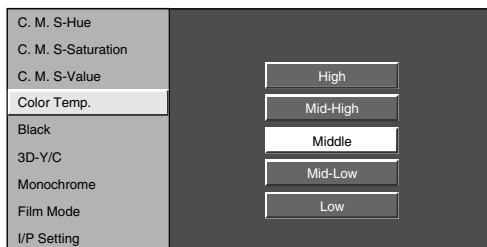

5 Press **▲/▼** to select the desired level, and then press **ENTER**.

Selected item	Description
High	White with Bluish tone
Mid-High	
Middle	↕
Mid-Low	
Low	White with Reddish tone

Black

For easier viewing, change the viewing depth by selecting a level for automatically adjusting the dark portion of an image.

1 Press **MENU** and the MENU screen displays.

2 Press **◀/▶** to select "Picture".

3 Press **▲/▼** to select "Advanced", and then press **ENTER**.

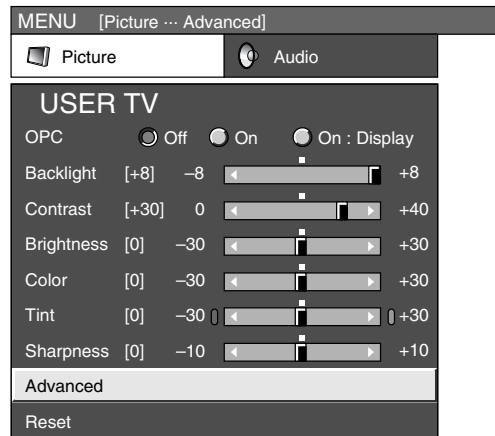

4 Press **▲/▼** to select "Black", and then press **ENTER**.

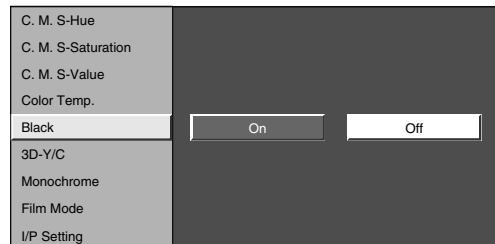

5 Press **◀/▶** to select "On", and then press **ENTER**.

Selected item	Description
Off	No adjustment
On	For high detail in black portions

Basic adjustment settings

3D-Y/C

Provides high quality images with minimal dot crawl and cross color noise.

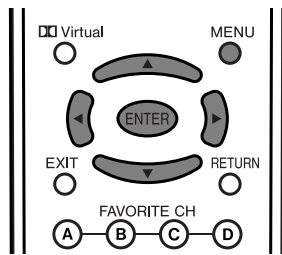

1 Press **MENU** and the MENU screen displays.

2 Press **◀/▶** to select "Picture".

3 Press **▲/▼** to select "Advanced", and then press **ENTER**.

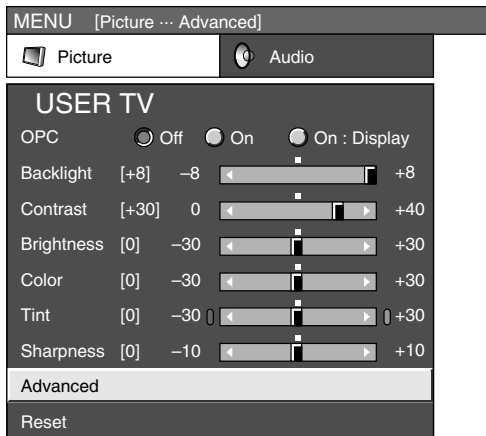

4 Press **▲/▼** to select "3D-Y/C", and then press **ENTER**.

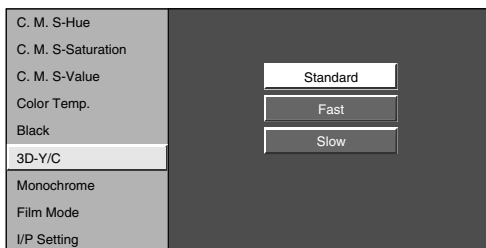

5 Press **▲/▼** to select the desired level, and then press **ENTER**.

Selected item	Description
Standard	Normal adjustment
Fast	For movie image
Slow	For still image

NOTE

- "3D-Y/C" is not selectable when receiving images from DVI or component video terminals.

Monochrome

For viewing a video in monochrome.

1 Press **MENU** and the MENU screen displays.

2 Press **◀/▶** to select "Picture".

3 Press **▲/▼** to select "Advanced", and then press **ENTER**.

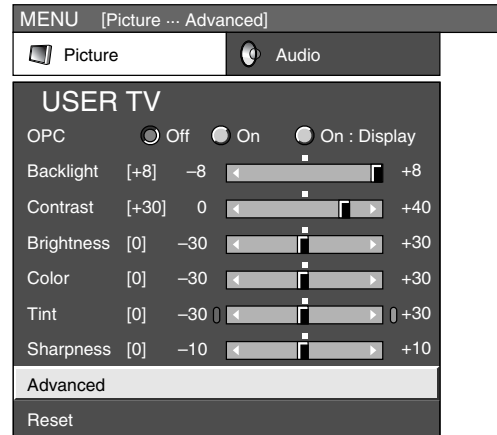

4 Press **▲/▼** to select "Monochrome", and then press **ENTER**.

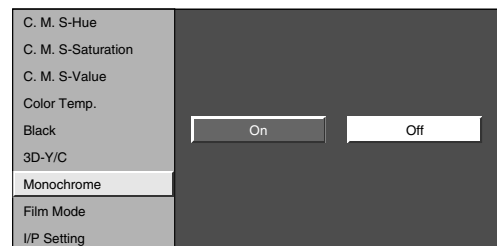

5 Press **◀/▶** to select "On", and then press **ENTER**.

Selected item	Description
Off	Normal color
On	For viewing in monochrome

Basic adjustment settings

Film mode (3:2 pull-down)

Automatically detects a film-based source (originally encoded at 24 frames/second), analyzes it then recreates each still film frame for high-definition picture quality.

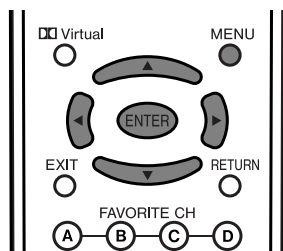

1 Press **MENU** and the MENU screen displays.

2 Press **◀/▶** to select "Picture".

3 Press **▲/▼** to select "Advanced", and then press **ENTER**.

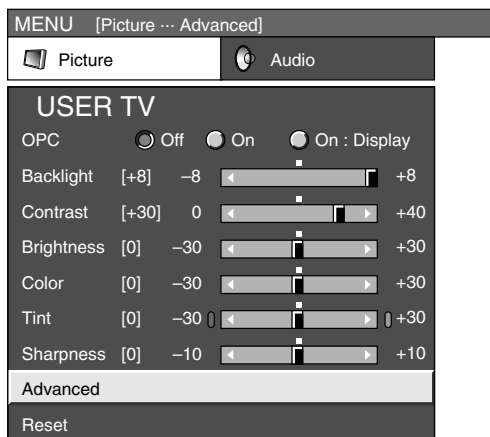

4 Press **▲/▼** to select "Film Mode", and then press **ENTER**.

- Some items may be grayed out. They are not selectable.

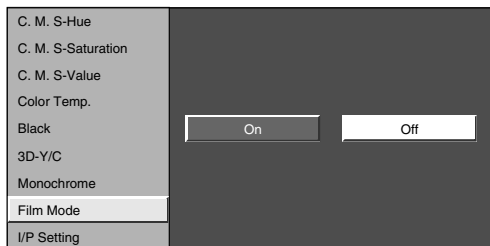

5 Press **◀/▶** to select "On", and then press **ENTER**.

Selected item	Description
Off	Normal viewing mode
On	Detects, analyzes, converts film source

I/P Setting

Adjusting the image and input signal can give you a more beautiful picture.

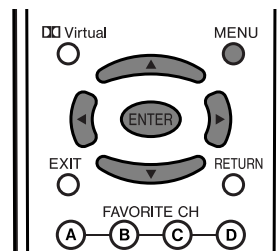

1 Press **MENU** and the MENU screen displays.

2 Press **◀/▶** to select "Picture".

3 Press **▲/▼** to select "Advanced", and then press **ENTER**.

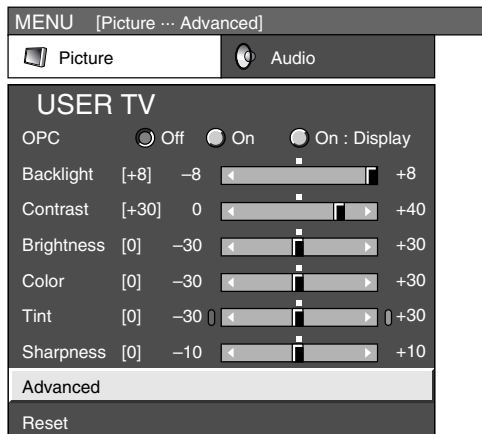

4 Press **▲/▼** to select "I/P Setting", and then press **ENTER**.

- Some items may be grayed out. They are not selectable.

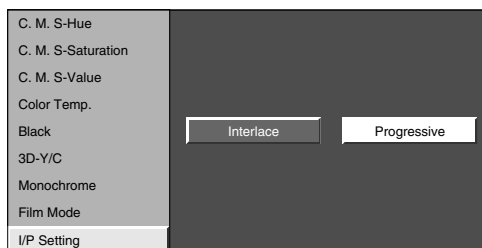

5 Press **◀/▶** to select "Interlace" or "Progressive", and then press **ENTER**.

NOTE

- I/P Setting is set to Progressive when Film Mode is "On".
- "I/P Setting" is not selectable when channel display shows an input resolution of 480P, 720P or 1080I.

Basic adjustment settings

Sound adjustment

You can adjust the sound quality to your preference with the following settings.

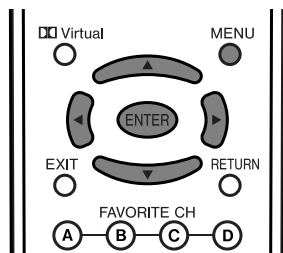

1 Press **MENU** and the MENU screen displays.

2 Press **◀/▶** to select "Audio".

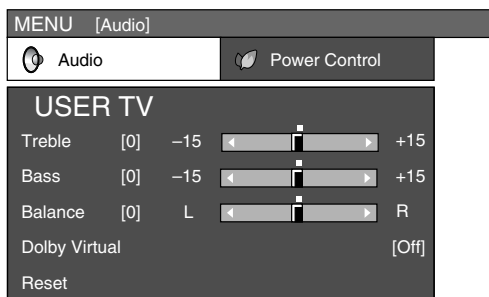

3 Press **▲/▼** to select a specific adjustment item.

4 Press **◀/▶** to adjust the item to your desired position.

Selected item	◀ button	▶ button
Treble	For weaker treble	For stronger treble
Bass	For weaker bass	For stronger bass
Balance	Decrease audio from the right speaker	Decrease audio from the left speaker

NOTE

- Audio menu is grayed out when Output Select is set to "Variable" or when headphones are in use.
- Balance and Audio Quality Control are grayed out when Dolby Virtual is set to "On".
- For resetting all adjustment items to factory preset values, press **▲/▼** to select "Reset", press **OK**, press **◀/▶** to select "Yes", and then press **OK**.

Dolby virtual

You can enjoy the SURROUND 2ch stereo with Dolby Pro Logic II technology.

VIRTUAL DOLBY SURROUND is a technology certified by Dolby Laboratories that creates a virtualized surround sound experience from two speakers using Dolby Pro Logic or Dolby Pro Logic II.

VIRTUAL DOLBY SURROUND retains all the original multichannel audio information and provides the listener with the sensation of being surrounded by additional speakers.

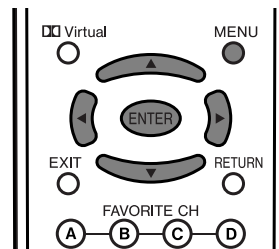

1 Press **MENU** and the MENU screen displays.

2 Press **◀/▶** to select "Audio".

3 Press **▲/▼** to select "Dolby Virtual", and then press **ENTER**.

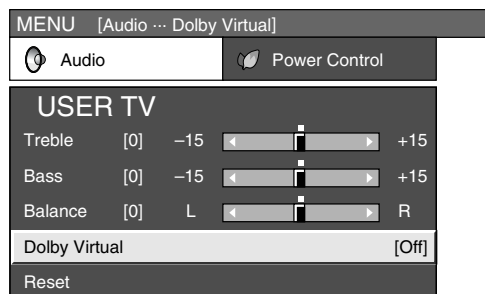

4 Press **◀/▶** to select "On", and then press **ENTER**.

NOTE

- You can choose Dolby Virtual by pressing **Virtual** on the remote control unit. See page XX for Dolby Virtual.
- Audio menu is grayed out when Output Select is set to "Variable" or when headphones are in use.
- Balance and Audio Quality Control are grayed out when Dolby Virtual is set to "On".
- For some discs, setup may be required on your DVD. In this case, please refer to the operation manual of your DVD player.
- You may not get the Dolby Virtual Surround effect if you adjust "Treble" or "Bass" setting.

Basic adjustment settings

Power control

Power control setting allows you to save energy.

Power control for AV source

No signal off

When set to “Enable”, the power will automatically shut down if no signal inputs for 15 minutes.

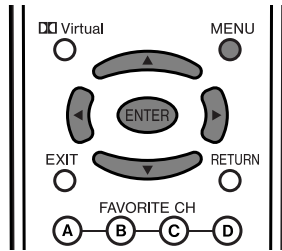

No operation off

When set to “Enable”, the power will automatically shut down if there is no operation for 3 hours.

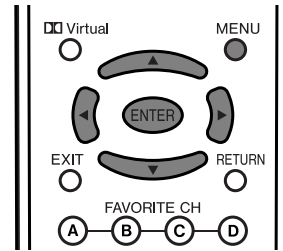

1 Press **MENU** and the MENU screen displays.

2 Press **◀/▶** to select “Power Control”.

3 Press **▲/▼** to select “No Signal Off”, and then press **ENTER**.

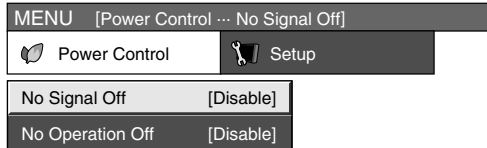

4 Press **◀/▶** to select “Enable”, and then press **ENTER**.

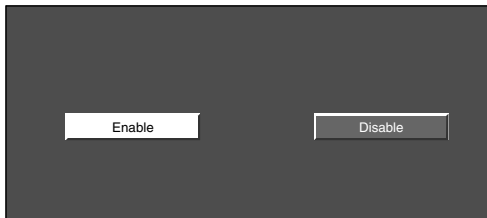

- Five minutes before the power shuts down, remaining time displays every minute.

NOTE

- “Disable” is factory preset value.
- When a TV program finishes, and the AVC System receives signal input, this function may not operate.

1 Press **MENU** and the MENU screen displays.

2 Press **◀/▶** to select “Power Control”.

3 Press **▲/▼** to select “No Operation Off”, and then press **ENTER**.

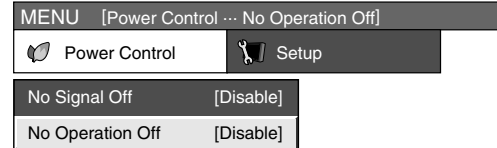

4 Press **◀/▶** to select “Enable”, and then press **ENTER**.

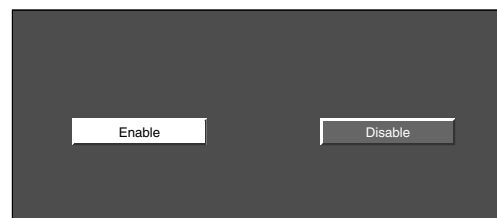

- Five minutes before the power shuts down, remaining time displays every minute.

NOTE

- “Disable” is factory preset value.

Basic adjustment settings

Power control for PC source

Power control setting allows you to save energy.

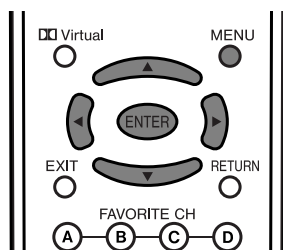

Power management

When set, the power will automatically shut down.

1 Press **MENU** and the MENU screen displays.

2 Press **◀▶** to select “Power Control”.

3 Press **▲/▼** to select “Power Management”, and then press **ENTER**.

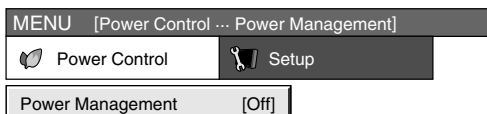

4 Press **▲/▼** to select “Mode1” or “Mode2”, and then press **ENTER**.

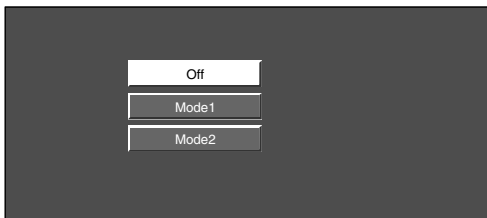

Selected item	Description
Off	<ul style="list-style-type: none"> No power management Factory preset value.
Mode1	<ul style="list-style-type: none"> If no signal inputs for 8 minutes, the power shuts down. Even if you start using the PC and the signal inputs again, the System stays off. The System turns on again by pressing POWER button on the Display or TV POWER on the remote control unit. (See page XX).
Mode2	<ul style="list-style-type: none"> If no signal inputs for 8 seconds, the power shuts down. When you start using the PC and the signal inputs again, the System turns on.

Using memory card

Important notes on using memory cards

- We will not be liable for misuse of the LCD TV set, any troubles during use, or other problems, or any damages arising out of the use of the LCD TV set, except for the cases for which we are liable by statute.
- If you or other people misuse the LCD TV set, or the LCD TV set is affected by static electricity or electrical noise, the recorded data may be in danger of being changed or lost.
- If you are making a record of importance, run a test in advance to ensure that the recording would be performed correctly in terms of picture or sound quality.
- We do not capture responsibility nor compensate even if pictures or sound could not be recorded correctly because of troubles.

Copyright

Duplicating images and music by copying and/or editing from videocassettes and/or TV programs that are subject to copyrights is only permitted when the edited or copied versions are used for personal pleasure. With the exception of cases when the user personally is the owner of the copyrights of the object in question or when specific and written permission has been obtained from the owner(s) of the object in question, the user is not permitted to make copies and/or duplications and/or edited versions as this constitutes a violation of the copyright laws, possibly exposing the user to demands for compensation for damages. Therefore, strictly adhere to the existing copyright laws.

In addition when using image data that includes third parties, the use without prior permission of these images may constitute an intrusion on the privacy of third parties, so strictly refrain from such usage.

The recording formats

Still picture	Recording/Playback file format	JPEG (DCF compliant)
	Size of a captured still picture	640 × 480 dots
Motion Picture	Recording file format	SP/LP... ASF (Motion Picture: MPEG-4 compliant, Sound: WMA-compliant) EP..... ASF (Motion Picture: MPEG-4 compliant, Sound: G.726-compliant)
	Size of a recorded motion picture/number of frames	SP ... Size: 320 × 240 dots, Frame: approx. 30 frames/sec LP ... Size: 320 × 240 dots, Frame: approx. 30 frames/sec EP ... Size: 320 × 240 dots, Frame: approx. 15 frames/sec
	Playback file format	ASF (Motion Picture: MPEG-4 compliant, Sound: WMA-compliant) ASF (Motion Picture: MPEG-4 compliant, Sound: G.726-compliant)

Approximate number of recordable pictures/time

Still Pictures

	Picture size	Memory card	
		32MB	256MB
Still picture	640 × 480	Approx. 328 pictures	Approx. 1000 pictures

* Recordable numbers may vary depending on the receiving condition of the LCD TV set and/or content of images.

Motion pictures

	Picture size	Recording mode	Memory card capacity	
			256MB	5GB
Recordable time	320 × 240	SP	Approx. 10 min.	Approx. 4h 20 min.
	320 × 240	LP	Approx. 30 min.	Approx. 10h 30 min.
	320 × 240	EP	Approx. 1h.	Approx. 25h 40 min.

- Recordable time may vary depending on receiving condition of the LCD TV set or content of images.
- The maximum amount of data you can record on a memory card is 1,024 pictures in total including still and motion pictures.
- In the FIT mode, pictures will be recorded in SP, LP or EP mode, in accordance with the remaining space in the memory card.

Using memory card

You can use memory cards (commercially available) for recording and playing back pictures.

- Please use an appropriate PC card adapter (commercially available) for each memory card.
- Following memory cards are available. (Note that names for memory cards vary depending on manufacturers.)

Memory card name	Storage capacity
SD Memory Card	128 MB or less
mini SD™ Card	32 MB or less
CompactFlash	512 MB or less
MultiMediaCard	64 MB or less
SmartMedia	128 MB or less
Memory Stick	128 MB or less
Memory Stick PRO	1 GB or less
Microdrive	2 GB or less
xD Picture Card	128 MB or less
PC Card Hard Disk	5 GB or less

* Each memory card name is a trademark.

* The capacity of memory card is approximate. The capacity varies depending on the manufacturer.

- To read picture files recorded with digital cameras, use the PC card adapter recommended by the corresponding manufacturer. (The names for PC card adapters vary depending on manufacturers.)
- For directions for use of digital cameras or PC card adapters, please refer to the operation manual provided for each product.

You can playback DCF compliant JPEG pictures captured with other devices in the card playback mode.

- DCF (Design rule for Camera File system) is a standard of the Japan Electronics and Information Technology Industries Association (JEITA). This standard specifies the image file format used for images shot with a digital camera.
- Some motion pictures recorded with other devices may not be played back correctly.

Commercially available memory cards

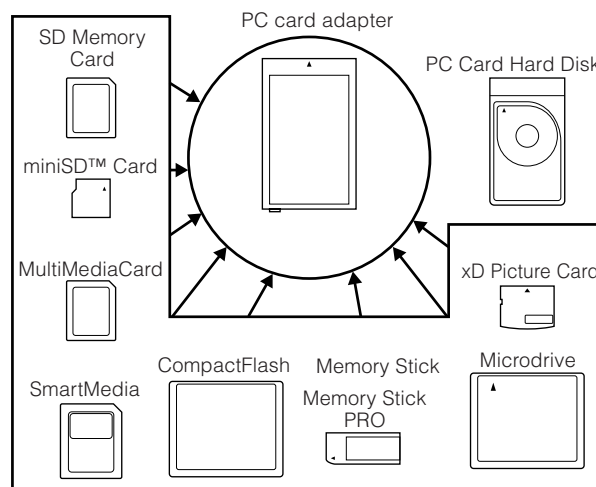

- Please use an appropriate PC card adapter (commercially available) for each memory card.

Preparing a memory card

Insert a memory card (commercially available) into a PC card adapter (commercially available).

Example:

Inserting the SD memory card into a PC card adapter.

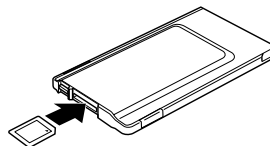

Notes on using memory cards and PC card adapter

Please note the following when using memory cards and PC card adapters to avoid corruption of data or malfunction of the LCD TV set.

- If you use memory cards other than those shown above, recording or playing back pictures are not guaranteed.
- Some PC card adapters have restrictions of memory card capacity. Refer to the relevant operation manual for such restrictions.
- Some pictures which have been created, modified, or copied on your PC may not be played back.
- Please be sure to turn off the LCD TV set when you insert or remove a PC card adapter.
- Do not bend, drop or apply a shock to memory cards or PC card adapters.
- Keep memory cards or PC card adapters away from heat, water or direct sunlight.
- Do not dismantle or modify memory cards or PC card adapters.
- Refer to the appropriate operation manuals for details on using or keeping memory cards or PC card adapters.
- Do not turn the LCD TV set off while a memory card is in operation (e.g. playing back, recording or displaying a slideshow).

Using memory card

Card Setup mode menu items

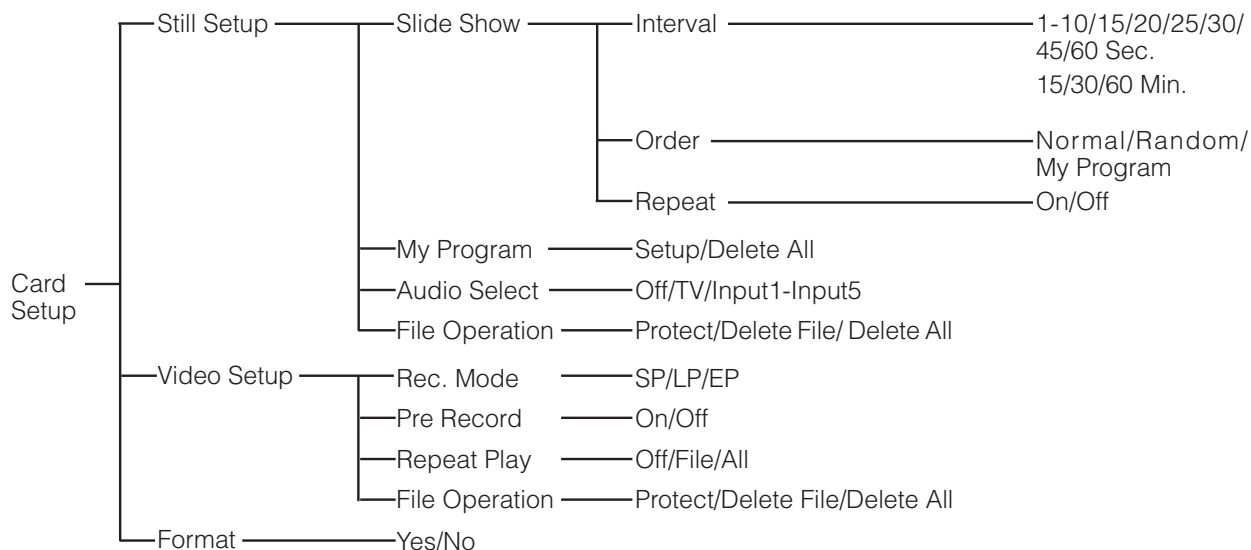

Slide show operation panel

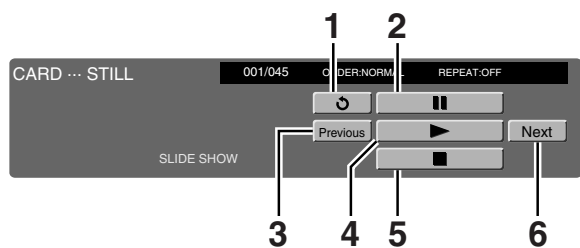

- 1 Rotate the image
- 2 Pause
- 3 Go to previous image
- 4 Start slide show
- 5 Stop slide show
- 6 Go to next image

Motion picture operation panel

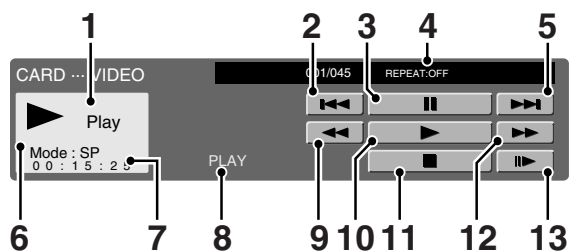

- 1 Action
- 2 Go back to the beginning of the file
- 3 Pause
- 4 Repeat playback setting
- 5 Go to the beginning of the next file
- 6 Recording mode
- 7 Counter
- 8 Current action
- 9 Reverse
- 10 Playback
- 11 Stop
- 12 Fast forward
- 13 Slow playback

Using memory card

Inserting a PC card adapter

- Insert a memory card to a PC card adapter beforehand. (See page XX.)
- Insert the PC adapter card slowly.

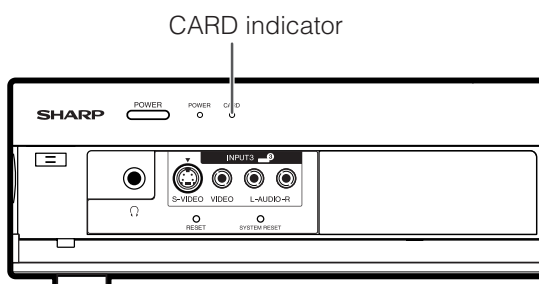
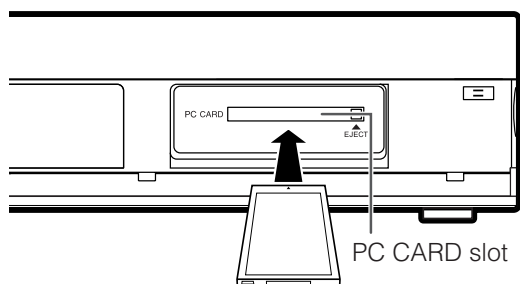

- CARD indicator lights up green when the card is inserted.

Ejecting the card

- Make sure the card indicator lights up green.

1

Press **EJECT** button.

- EJECT button is popped up.

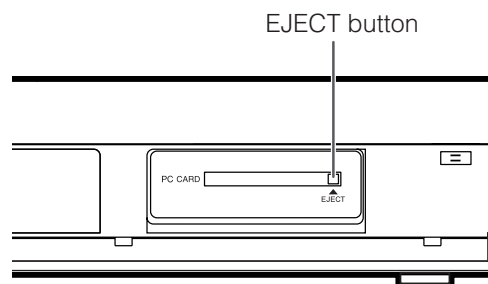

2

Press **EJECT** button again.

NOTE

- When "Card is not inserted" is displayed, eject the PC card adapter, and then insert the PC card adapter slowly all the way to the end.
- When over a thousand files are in a card, it takes several minutes to load. (Approx. 5 minutes.)
- Even the green light is on, you can not record on a card right after you inserted it.
- Make sure the CARD indicator lights green when you take out a card. Never take out a card when the CARD indicator lights red. This may damage the card.

Using memory card

Recording a still image

You can record a still image on the card.

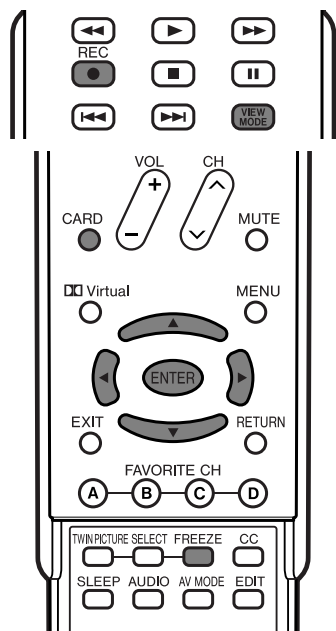

- 1 Press **FREEZE**.

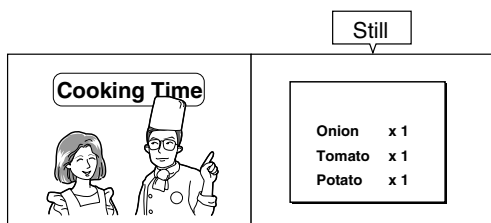

- 2 Press **REC**.

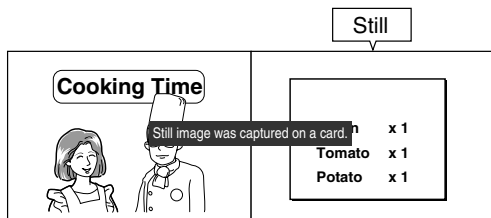

- "Still image was captured on a card." displays.

- 3 Press **ENTER** to update the still image.

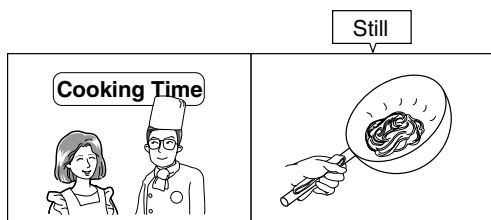

NOTE

The list of broadcasting type or input signal not available for recording:

- ① DTV broadcasting
- ② COMPONENT input
- ③ RGB input
- ④ Copyguarded signal
- ⑤ DVI-I input

Displaying a still image

- 1 Press **CARD** and the card mode screen displays.

- 2 Press **◀/▶** to select "Still Image".



- 3 Press **▲/▼/◀/▶** to select a file you want to display, and then press **ENTER**.



- To display the files that are in the previous or next page, select **◀/▶** on the index screen and press **ENTER**.
- To enlarge the still image while displaying, press **VIEW MODE**.

Displaying slide show

- 1 Repeat steps 1 and 2 in Displaying a still image above.

- 2 Press **CARD**.
 - The operation panel displays.



- 3 Press **▲/▼/◀/▶** to select **▶**, and then press **ENTER**.

- Slide show starts.
- Operate slide show with the operation panel appears on the screen.

NOTE

- See page XX for operation panel function.
- You can not rotate the image during slide show. Stop slide show to rotate the image.

Using memory card

Setting Slide Show

You can adjust the interval, order and repeat settings.

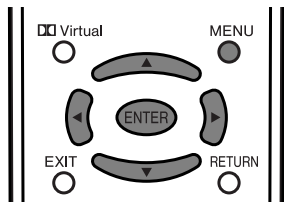

1 Press **CARD** and the card mode screen displays.

2 Press **MENU** and the MENU screen displays.

3 Press **◀/▶** to select “Card Setup”.

4 Press **▲/▼** to select “Still Setup”, and then press **ENTER**.

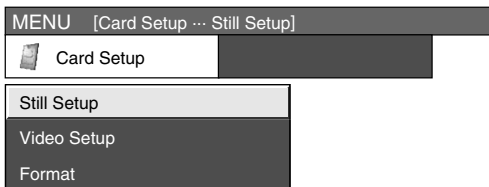

5 Press **▲/▼** to select “Slide Show” and then press **ENTER**.

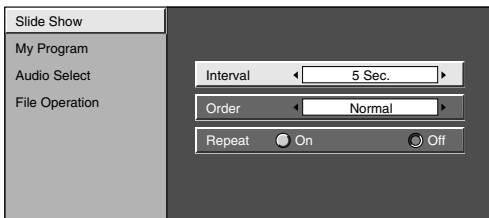

6 Press **▲/▼/◀/▶** to select the desired slide show setting.

Selected item	Selectable item
Interval	1-10/15/20/25/30/45/60 Sec. 15/30/60 Min.
Order	Normal, Random, My Program
Repeat	On, Off

My Program

You can select up to thirty-two pictures and specify the order for displaying in slide show.

1 Press **CARD** and the card mode screen displays.

2 Press **MENU** and the MENU screen displays.

3 Press **◀/▶** to select “Card Setup”.

4 Press **▲/▼** to select “Still Setup”, and then press **ENTER**.

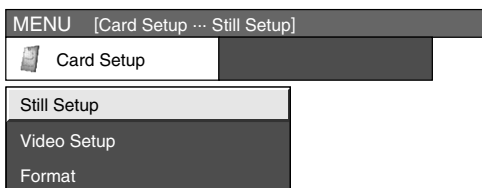

5 Press **▲/▼** to select “My Program”, and then press **ENTER**.

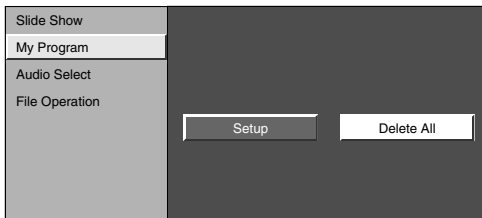

6 Press **◀/▶** to select “Setup”, and then press **ENTER**.

7 Press **▲/▼/◀/▶** to select the files, and then press **ENTER**.

To cancel My Program setting

1 Select “Delete All” at step 5 in “My Program”, and then press **ENTER**.

2 Press **◀/▶** to select “Yes”, and then press **ENTER**.

NOTE

- All the registered numbers are cleared.

Using memory card

Audio Select

You can enjoy the audio from TV or other external equipment during the still image playback.

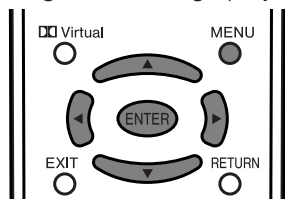

1 Press **CARD** and the card mode screen displays.

2 Press **MENU** and the MENU screen displays.

3 Press **◀/▶** to select "Card Setup".

4 Press **▲/▼** to select "Still Setup", and then press **ENTER**.

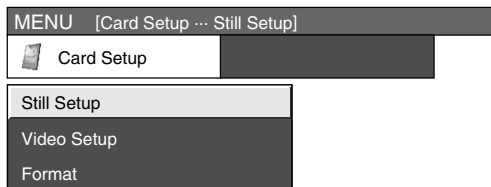

5 Press **▲/▼** to select "Audio Select", and then press **ENTER**.

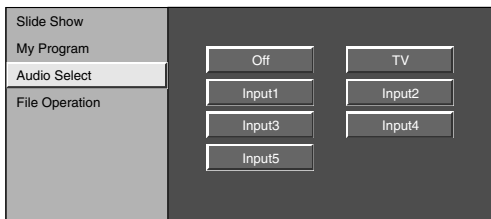

6 Press **▲/▼/◀/▶** to select the desired sound output, and then press **ENTER**.

Protecting still picture files

You can protect any file you do not want to delete.

1 Press **CARD** and the card mode screen displays.

2 Press **MENU** and the MENU screen displays.

3 Press **◀/▶** to select "Card Setup".

4 Press **▲/▼** to select "Still Setup", and then press **ENTER**.

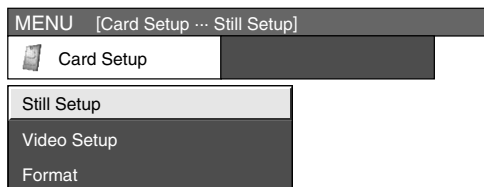

5 Press **▲/▼** to select "File Operation", and then press **ENTER**.

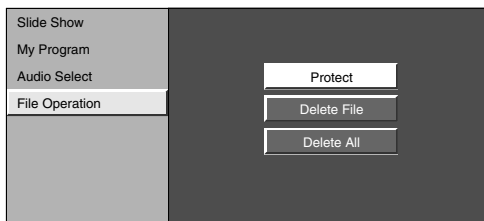

6 Press **◀/▶** to select "Protect", and then press **ENTER**.

7 Press **▲/▼/◀/▶** to select the file you want to protect, and then press **ENTER**.

- Protect mark displays.
- Select the file with a protect mark and press **ENTER** to cancel file protect.

Using memory card

Deleting a still image file

- 1 Press **CARD** and the card mode screen displays.
- 2 Press **MENU** and the MENU screen displays.
- 3 Press **◀/▶** to select "Card Setup".

- 4 Press **▲/▼** to select "Still Setup", and then press **ENTER**.

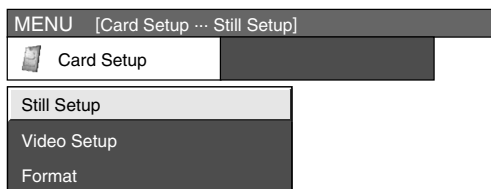

- 5 Press **▲/▼** to select "File Operation", and then press **ENTER**.

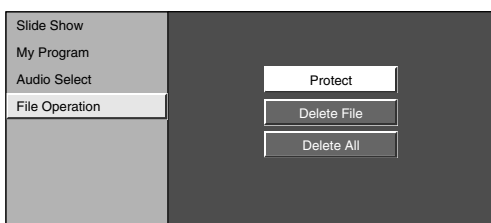

- 6 Press **▲/▼** to select "Delete File", and then press **ENTER**.

- 7 Press **▲/▼/◀/▶** to select the file you want to delete, and then press **ENTER**.

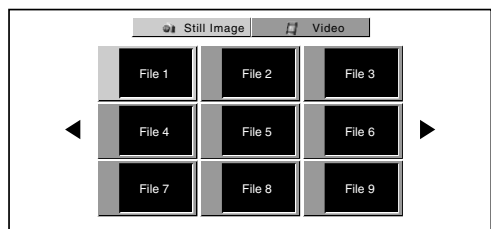

- 8 Press **◀/▶** to select "Yes", and then press **ENTER**.

NOTE

- Formatting a card deletes all files including the ones which set to protect.
- Do not turn off the power or take out a card when deleting a file. The card may malfunction.

Deleting all still image files

- 1 Press **CARD** and the card mode screen displays.
- 2 Press **MENU** and the MENU screen displays.
- 3 Press **◀/▶** to select "Card Setup".

- 4 Press **▲/▼** to select "Still Setup", and then press **ENTER**.

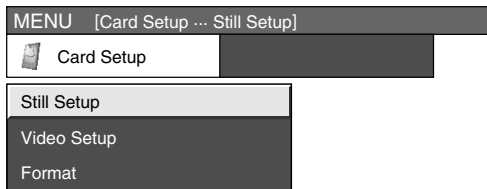

- 5 Press **▲/▼** to select "File Operation", and then press **ENTER**.

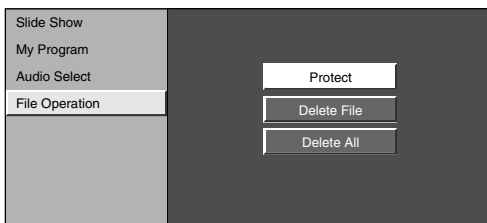

- 6 Press **◀/▶** to select "Delete All", and then press **ENTER**.

- 7 Press **◀/▶** to select "Yes", and then press **ENTER**.

NOTE

- Formatting a card deletes all files including the ones which set to protect.
- Do not turn off the power or take out a card when deleting a file. The card may malfunction.

Using memory card

Rec. Mode

Use this setting for recording images you are currently watching. You can select the recording mode (picture quality) for a motion picture.

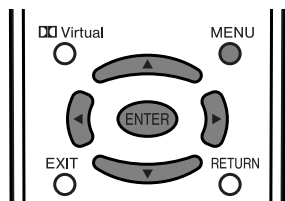

1 Press **CARD** and the card mode screen displays.

2 Press **MENU** and the MENU screen displays.

3 Press **◀/▶** to select "Card Setup".

4 Press **▲/▼** to select "Video Setup" and then press **ENTER**.

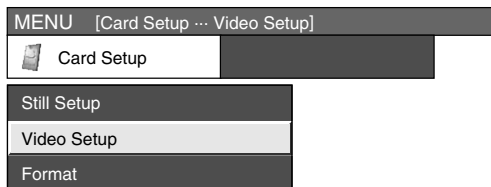

5 Press **▲/▼** to select "Rec. Mode", and then press **ENTER**.

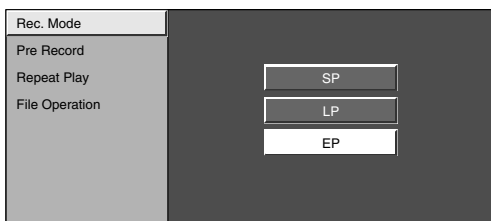

6 Press **▲/▼** to select the desired mode, and then press **ENTER**.

Pre Record

You can record the picture slightly before the point where you pressed the record button, enabling you to record just the scene you wanted.

1 Press **CARD** and the card mode screen displays.

2 Press **MENU** and the MENU screen displays.

3 Press **◀/▶** to select "Card Setup".

4 Press **▲/▼** to select "Video Setup" and then press **ENTER**.

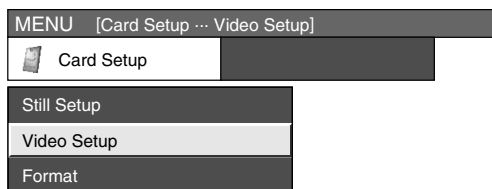

5 Press **▲/▼** to select "Pre Record", and then press **ENTER**.

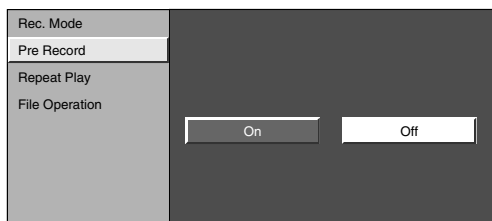

6 Press **◀/▶** to select "On", and then press **ENTER**.

Using memory card

Repeat Play

You can specify one file or all files to replay repeatedly.

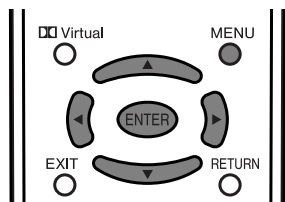

1 Press **CARD** and the card mode screen displays.

2 Press **MENU** and the MENU screen displays.

3 Press **◀/▶** to select “Card Setup”.

4 Press **▲/▼** to select “Video Setup” and then press **ENTER**.

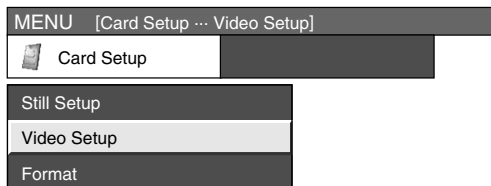

5 Press **▲/▼** to select “Repeat Play”, and then press **ENTER**.

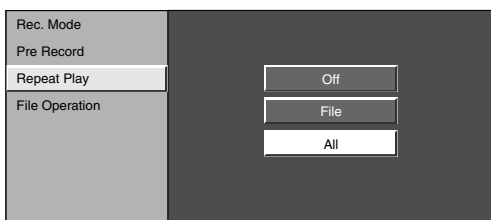

6 Press **▲/▼** to select desired setting, and then press **ENTER**.

Protecting motion picture files

You can protect any file you do not want to delete.

1 Press **CARD** and the card mode screen displays.

2 Press **MENU** and the MENU screen displays.

3 Press **◀/▶** to select “Card Setup”.

4 Press **▲/▼** to select “Video Setup”, and then press **ENTER**.

5

Press **▲/▼** to select “File Operation”, and then press **ENTER**.

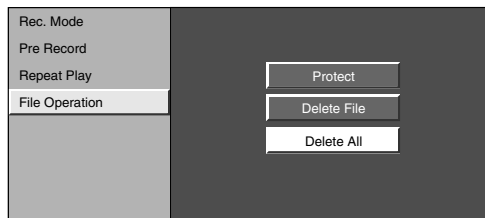

6

Press **▲/▼** to select “Protect”, and then press **ENTER**.

7

Press **▲/▼/◀/▶** to select the file you want to protect, and then press **ENTER**.

Using memory card

Deleteing a motion picture file

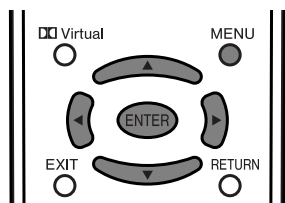

1 Press **CARD** and the card mode screen displays.

2 Press **MENU** and the MENU screen displays.

3 Press ◀/▶ to select “Card Setup”.

4 Press ▲/▼ to select “Video Setup”, and then press **ENTER**.

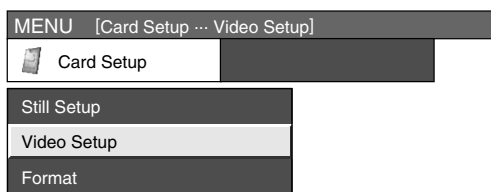

5 Press ▲/▼ to select “File Operation”, and then press **ENTER**.

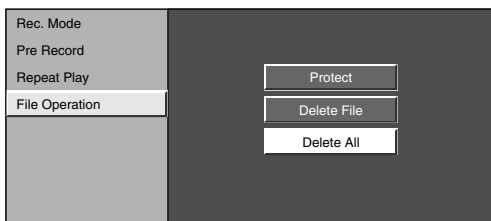

6 Press ▲/▼ to select “Delete File”, and then press **ENTER**.

7 Press ▲/▼/◀/▶ to select the file you want to delete, and then press **ENTER**.

8 Press ◀/▶ to select “Yes”, and then press **ENTER**.

NOTE

- Formatting a card deletes all files including the ones which set to protect.
- Do not turn off the power or take out a card when deleting a file. The card may malfunction.

Deleteing all motion picture files

1 Press **CARD** and the card mode screen displays.

2 Press **MENU** and the MENU screen displays.

3 Press ◀/▶ to select “Card Setup”.

4 Press ▲/▼ to select “Video Setup”, and then press **ENTER**.

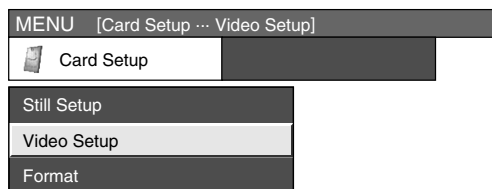

5 Press ▲/▼ to select “File Operation”, and then press **ENTER**.

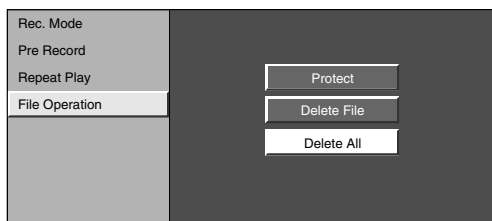

6 Press ◀/▶ to select “Delete All”, and then press **ENTER**.

7 Press ◀/▶ to select “Yes”, and then press **ENTER**.

NOTE

- Formatting a card deletes all files including the ones which set to protect.
- Do not turn off the power or take out a card when deleting a file. The card may malfunction.

Using memory card

Recording a motion picture

Record with the settings made in "Rec. Mode" and "Pre Record".

- 1 Press **REC** to start recording.
 - CARD indicator lights up red.
 - Recording information displays in the lower right corner of the screen.

- 2 Press **■** to stop recording.

NOTE

The list of broadcasting type or input signal not available for recording:

- ① DTV broadcasting
- ② COMPONENT input
- ③ RGB input
- ④ Copyguarded signal
- ⑤ DVI-I input

To display the remaining record time.

Press **DISPLAY** while not recording.

- Remaining record time displays in the lower right corner of the screen.

NOTE

- Do not press **MAIN POWER** on the display while recording. Recording cannot finish properly and may damage the file.
- Recording stops if you press **POWER** on the remote control while recording.
- When card has no capacity for recording, "Card is full" displays and stops recording.
- You cannot change the channel or switch the input source while recording.

Displaying a motion picture

- 1 Press **CARD** and the card mode screen displays.

- 2 Press **◀/▶** to select "Video", and then press **ENTER**.

- 3 Press **▲/▼/◀/▶** to select the file you want to play, and then press **ENTER**.
 - Video playback starts.

- 4 Press **CARD** again to display the operation panel.
 - See XX for the operation panel information.

Format

- 1 Press **MENU** and the MENU screen displays.

- 2 Press **◀/▶** to select "Card Setup".

- 3 Press **▲/▼** to select "Format" and then press **ENTER**.

- 4 Press **◀/▶** to select "Yes", and then press **ENTER**.

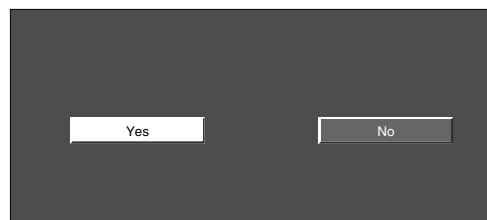

NOTE

- Formatting a card deletes all files including the ones which set to protect.

Using external equipment

You can connect many types of external equipment to your System, like a DVD player, VCR, Digital TV tuner, PC, HDMI equipment, game console and camcorder. To view external source images, select the input source from **INPUT** on the remote control unit or on the Display.

Displaying an external equipment image

Explanation here is for the setting when connecting DVD to INPUT1 terminal.

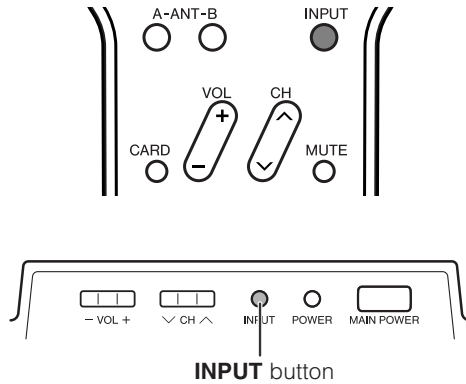

CAUTION

- To protect all equipment, always turn off the AVC System before connecting to a DVD player, VCR, Digital TV tuner, PC, HDMI equipment, game console, camcorder or other external equipment.

NOTE

- See pages X/X to X/X for external equipment connection.
- Please refer to the relevant operation manual (DVD player, PC, etc.) carefully before making connections.
- Each time **INPUT** is pressed, the input source toggles.
- If the image does not come in clearly, you may need to change the input signal type setting on the "Input Select" menu.
- Refer to your external equipment operation manual for the signal type.

1

To watch a DVD image, select "INPUT1" from "INPUT SOURCE" menu using **INPUT** on the remote control unit or on the Display. (See page XX.)

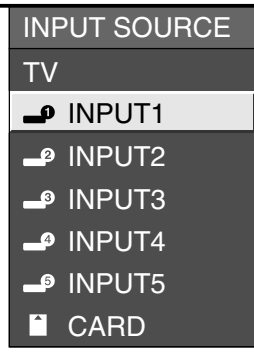

5

Select the desired signal type.

For INPUT1 signal

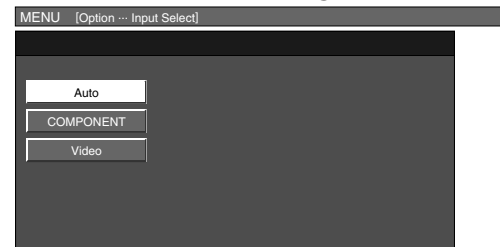

The setting is stored and can be selected on the "INPUT SOURCE" menu.

2

Press **MENU** and the MENU screen displays.

3

Press **◀/▶** to select "Option".

4

Press **▲/▼** to select "Input Select", and then press **ENTER**.

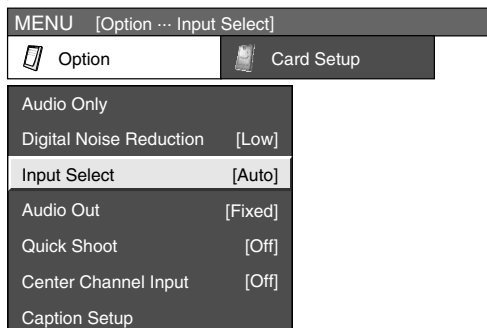

Using external equipment

Connecting a DVD player

You can use the INPUT 1 terminal when connecting to a DVD player and other audiovisual equipment.

When using component cable.

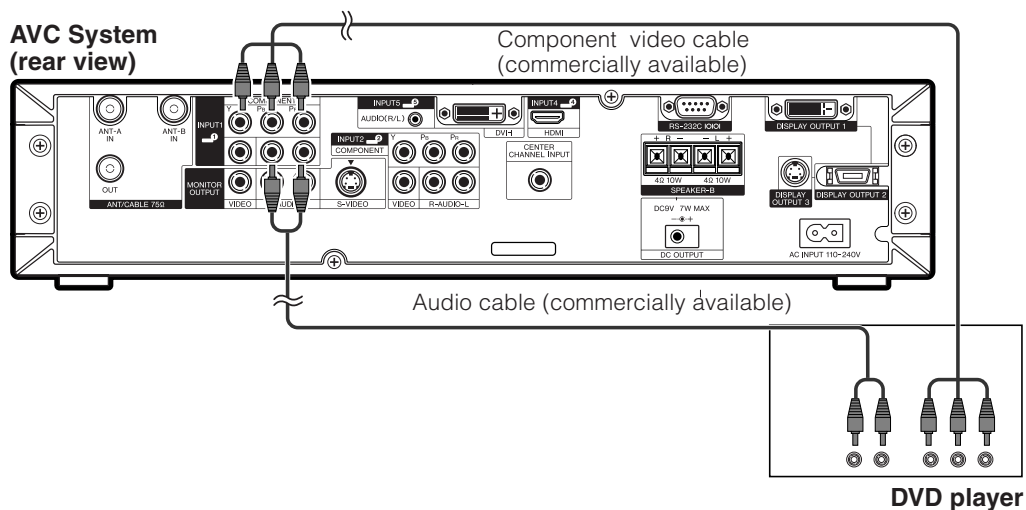

When using composite cable.

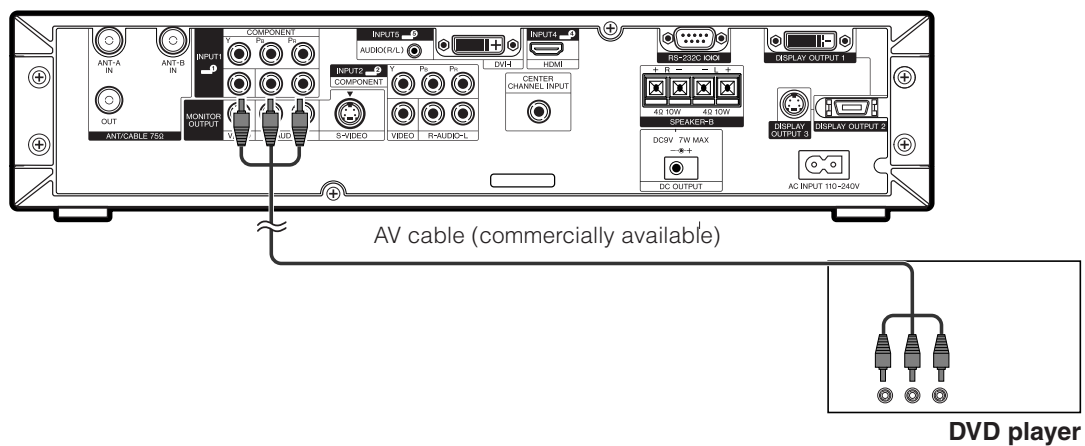

Using external equipment

Connecting a VCR

You can use the INPUT 2 terminal when connecting a VCR and other audiovisual equipment.

AVC System (rear view)

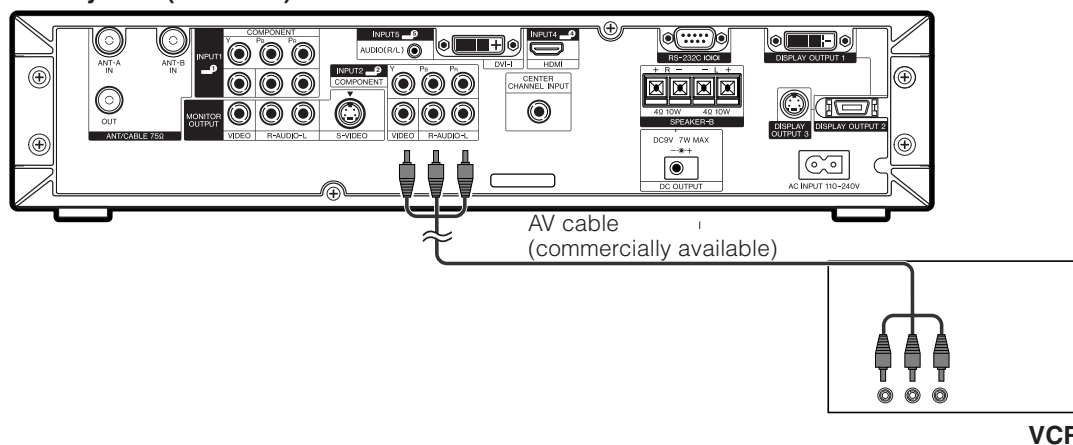

Connecting a game console or camcorder

A game console, camcorder and some other audiovisual equipment are conveniently connected using the INPUT 3 terminals.

NOTE

- The S-video terminal has priority over the video terminals.

AVC System (front view)

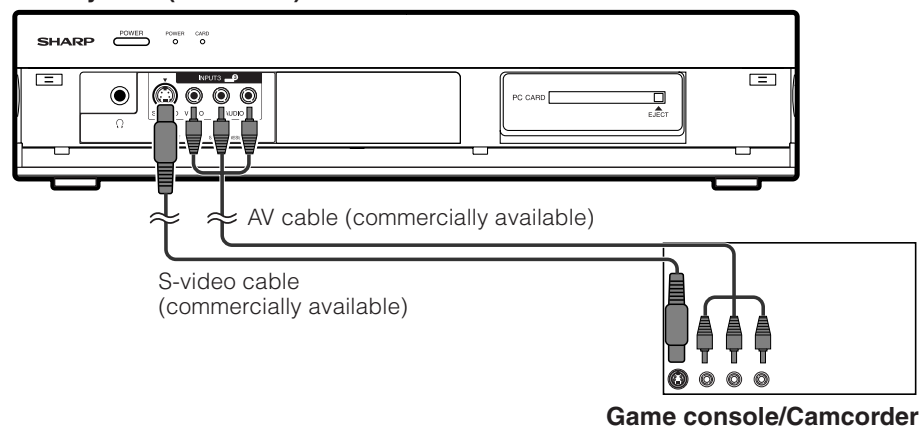

Using external equipment

Connecting a Digital TV STB

You can use the INPUT 2 terminal when connecting a Digital TV STB and other audiovisual equipment.

When using component cable.

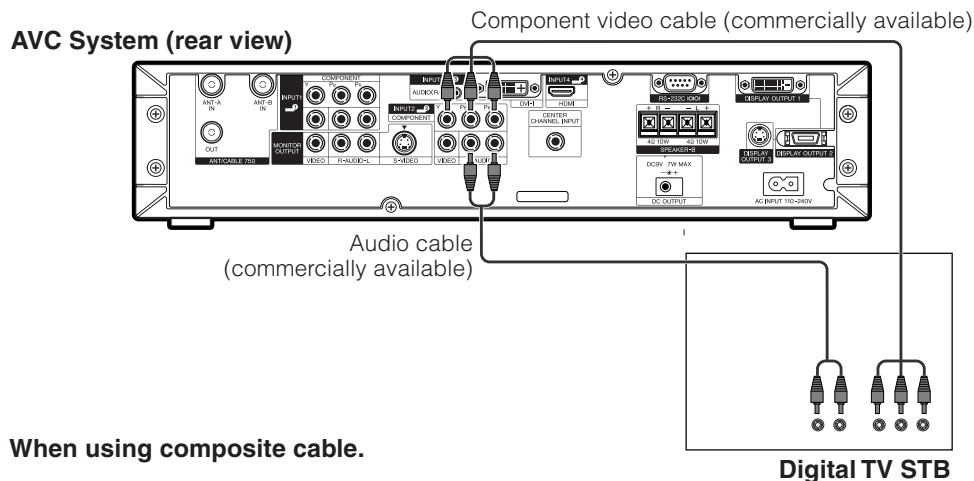

When using composite cable.

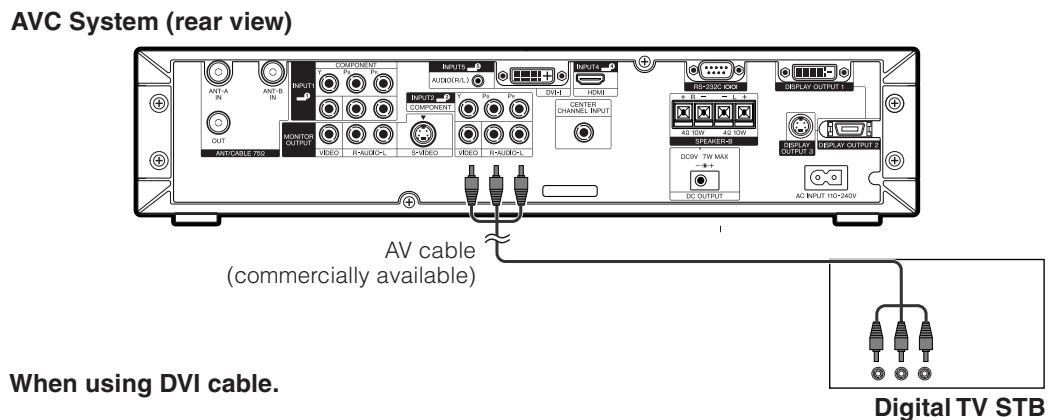

When using DVI cable.

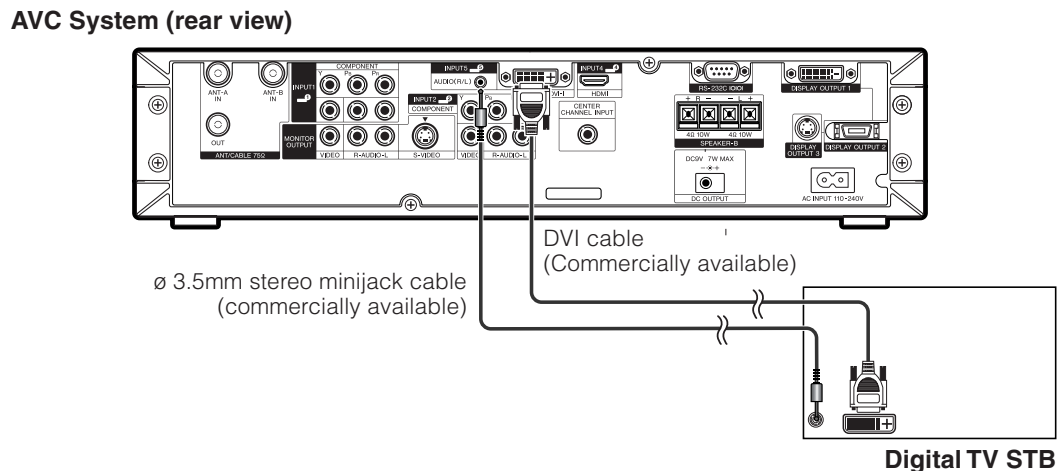

Using external equipment

Connecting HDMI equipment

You can use the INPUT 4 terminal when connecting an HDMI equipment.

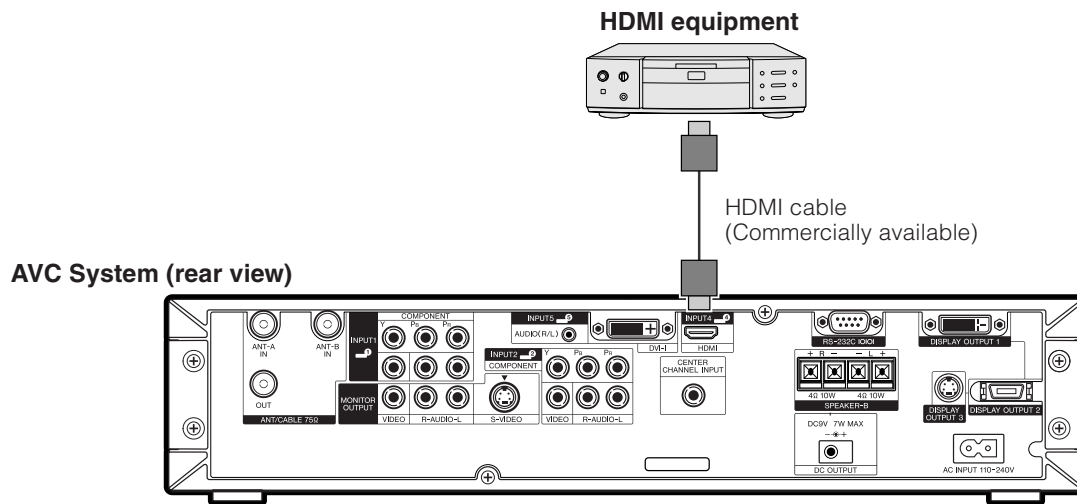

Displaying an image from HDMI equipment

- To watch an HDMI equipment image, select "INPUT4" from "INPUT SOURCE" menu using **INPUT** on the remote control unit or on the Display. (See page XX.)

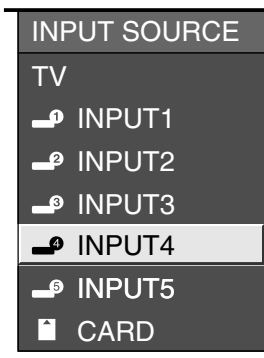

- Press **MENU** and the MENU screen displays.

- Press **Left/Right** to select "Option".

- Press **Up/Down** to select "HDMI Setup", and then press **ENTER**.

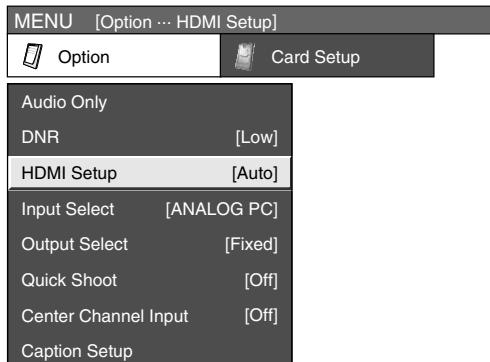

- Press **Up/Down** to select the desired item and press **ENTER**.

- Press **Up/Down/Left/Right** to select the desired setting and press **ENTER**.

NOTE

- Refer to your external equipment operation manual for the signal type.
- Unless you have a trouble viewing the image, select "Auto" or "Standard".

Using external equipment

Connecting a PC

Use the INPUT 5 terminal to connect a PC.

NOTE

- Refer to page XX for a list of PC signals compatible with the System.

AVC System (rear view)

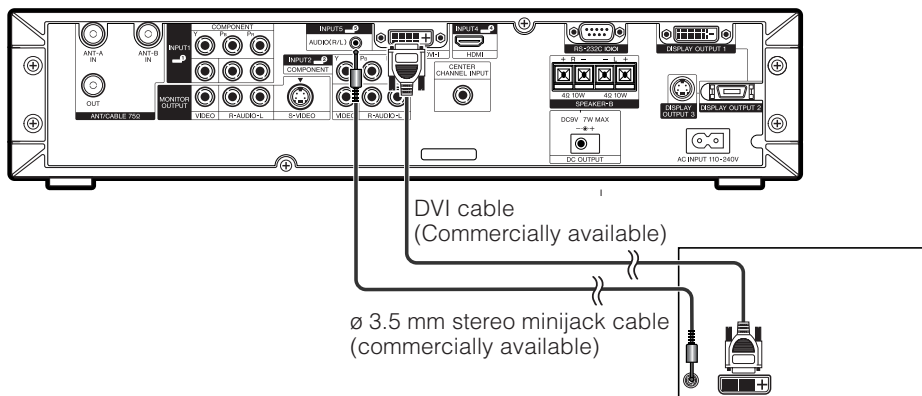
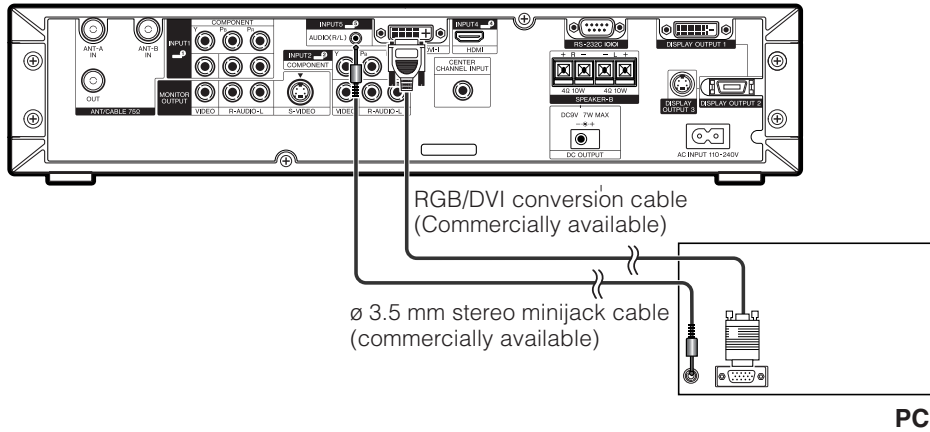

Useful adjustment settings

Image position (AV input mode only)

For adjusting a picture's horizontal and vertical position.

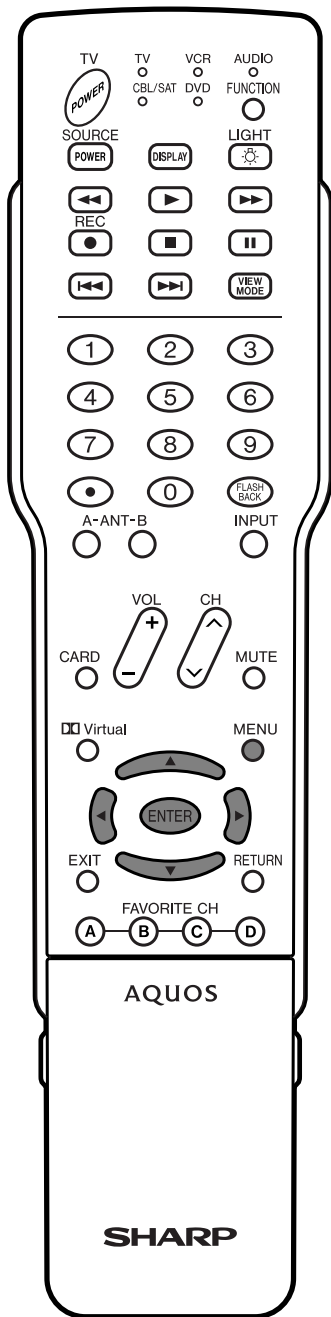

1 Press **MENU** and the MENU screen displays.

2 Press **◀/▶** to select "Setup".

3 Press **▲/▼** to select "Position", and then press **ENTER**.

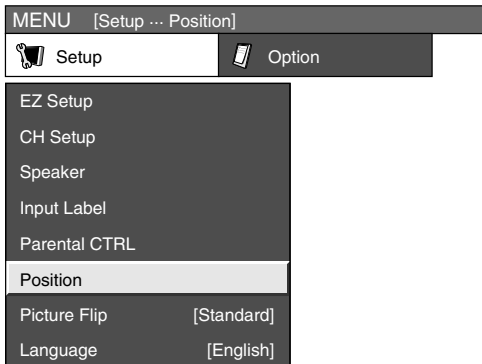

4 Press **▲/▼** to select "H-Pos." or "V-Pos.".

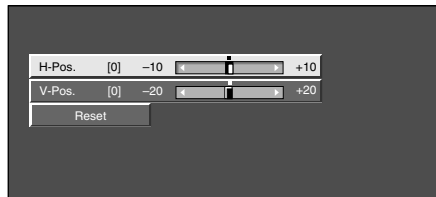

5 Press **◀/▶** to adjust the item to your desired position.

NOTE

- For resetting all adjustment items to the factory preset values, press **▲/▼** to select "Reset", and then press **ENTER**.
- **Adjustments are stored separately according to input source.**
- You can easily move the image position as shown on page XX, but when the power is switched off the image will return to the previously memorized position.

Selected item	Description
H-Pos.	Centers the image by moving it to the left or right.
V-Pos.	Centers the image by moving it up or down.

Moving the picture on the screen

You can move the picture around on the screen.

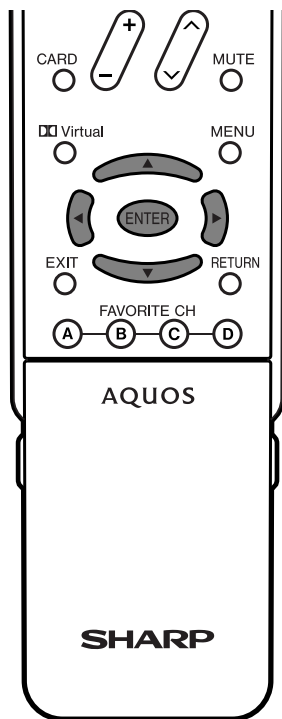

Press **▲/▼/◀/▶** to move an image on the screen to the desired position. Press **ENTER** to return to the initial image position.

NOTE

- While pressing **▲/▼/◀/▶**, an on-screen image, "Adjusting Position" displays to the desired position.
- This setting cannot be stored. Once the System shuts down or enters standby mode, the setting is erased. To move the picture around the screen again, you must perform the above procedure again.
- The image position setting using the steps on page XX can be stored. Select either according to your objectives.
- "TV", "INPUT1", "INPUT2", "INPUT3", "INPUT4" and "INPUT5" can each adjust the image position setting on this page. The same for view modes.
- An on-screen image from PC and card cannot be moved around.
- Even when the image fills the screen, its position can be adjusted with this function.
- Initialize the image position by pressing **ENTER**.

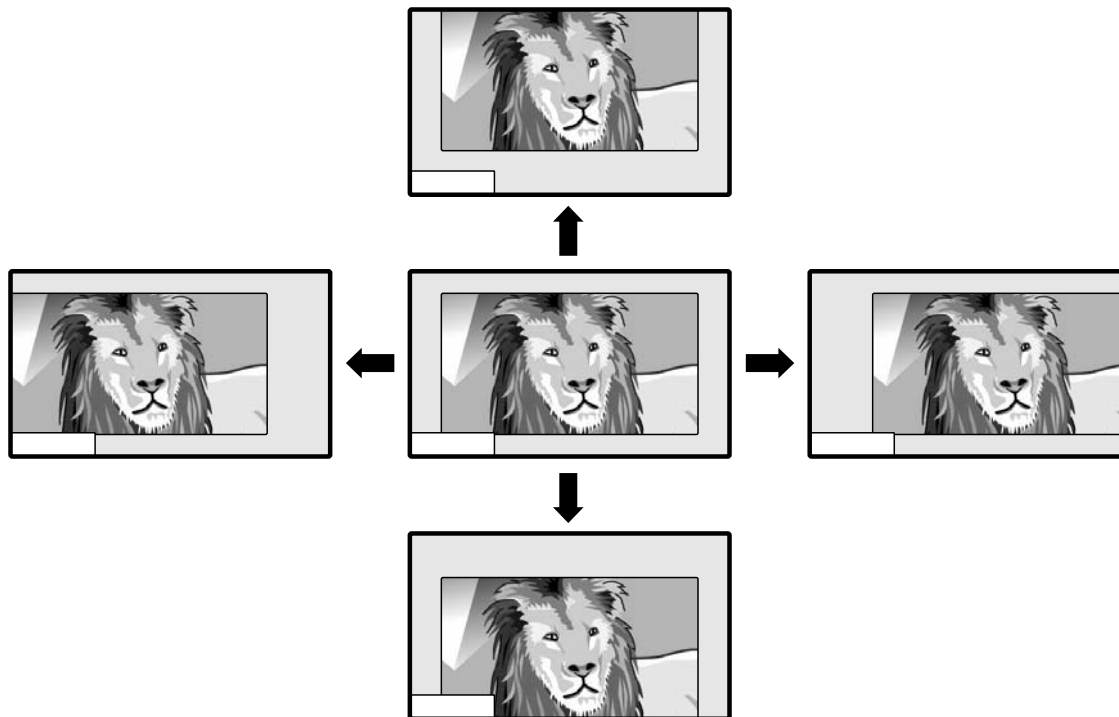

Connecting external speakers

Rear view

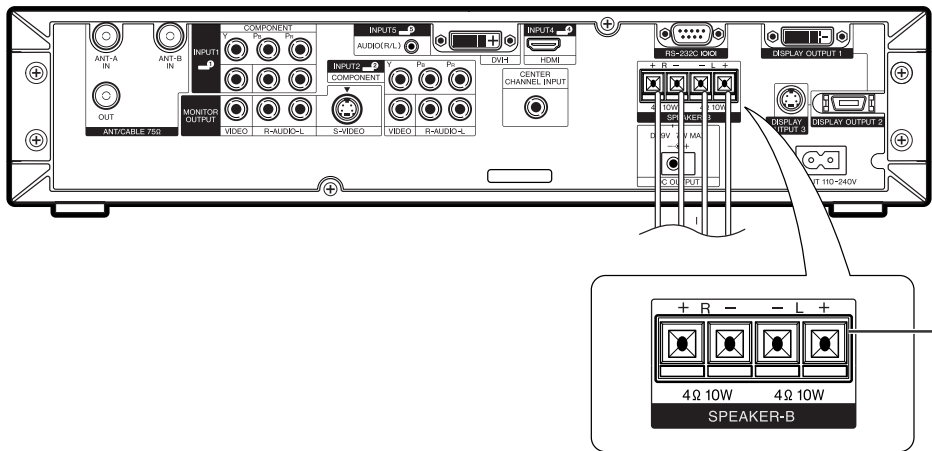

How to connect the speaker cable

- 1 Push down the tab.
- 2 Insert the end of the cable.
- 3 Lift the tab back up.

When using external speakers

- Change the speaker setting to external speakers. (See page XX.)

Make sure to connect the speaker terminal and cable polarity (+, -) properly

- The speaker terminals have plus (+) and minus (-) polarity.
- Plus is red and minus is black.
- The cables are also divided into plus and minus.
- When connecting the left/right speakers, be sure to connect the plus/minus terminals with the correct cables.

NOTE

- Unplug the AC cord from the AC outlet before installing the speakers.

CAUTION

- Make sure external speakers have 4 ohm and 10 watt specifications.
- Connect the plus/minus terminals with the correct cables. Incorrect connection may cause a short.

Useful adjustment settings

Selecting speakers

You can output audio using the supplied speakers or other external speakers.

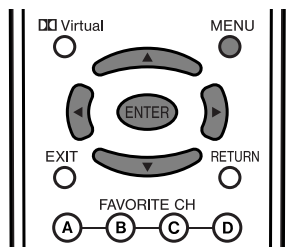

1 Press **MENU** and the MENU screen displays.

2 Press **◀/▶** to select "Setup".

3 Press **▲/▼** to select "Speaker", and then press **ENTER**.

4 Press **▲/▼** to select "Speaker", and then press **ENTER**.

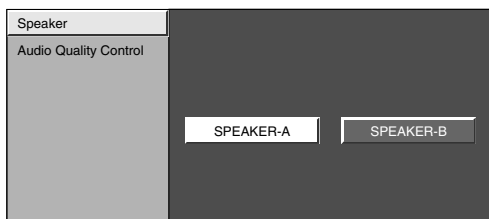

5 Press **◀/▶** to select "SPEAKER-A" or "SPEAKER-B", and then press **ENTER**.

Selected item	Description
SPEAKER-A	Speakers connected to the Display.
SPEAKER-B	Speakers connected to the AVC System.

Audio Quality Control

Audio Quality Control automatically optimizes the audio quality to suit internal (supplied) speakers.

1 Press **MENU** and the MENU screen displays.

2 Press **◀/▶** to select "Setup".

3 Press **▲/▼** to select "Speaker", and then press **ENTER**.

4 Press **▲/▼** to select "Audio Quality Control", and then press **ENTER**.

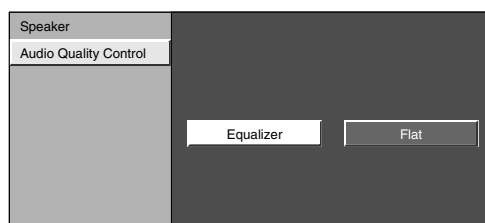

5 Press **◀/▶** to select "Equalizer" or "Flat", and then press **ENTER**.

Useful adjustment settings

Auto Sync. adjustment (PC input mode only)

For automatically adjusting the PC image.

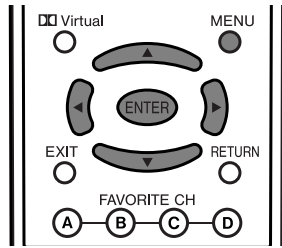

1 Press **MENU** and the MENU screen displays.

2 Press **◀/▶** to select "Setup".

3 Press **▲/▼** to select "Auto Sync.", and then press **ENTER**.

4 Press **◀/▶** to select "Yes", and then press **ENTER**.

- Auto Sync. starts and "Now adjusting the image" displays.

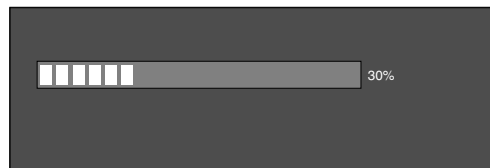
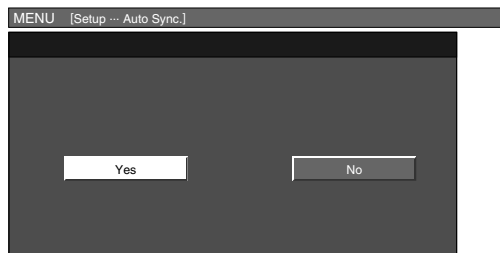

NOTE

- When Auto Sync. is successful, "Auto Sync completed successfully" displays. If not, Auto Sync. failed.
- Auto Sync. may fail even if "Auto Sync completed successfully" displays.
- Auto Sync. may fail with a PC image composed of similar patterns or monochrome. If not successful, change the PC image and try again.
- Be sure to connect the PC to the AVC System and switch it on before starting Auto Sync.

Fine Sync. adjustment (PC input mode only)

Ordinarily you can easily adjust the picture as necessary to change image position using Auto Sync. In some cases, however, manual adjustment is needed to optimize the image.

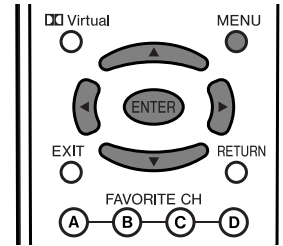

1 Press **MENU** and the MENU screen displays.

2 Press **◀/▶** to select "Setup".

3 Press **▲/▼** to select "Fine Sync.", and then press **ENTER**.

4 Press **▲/▼** to select the specific adjustment item.

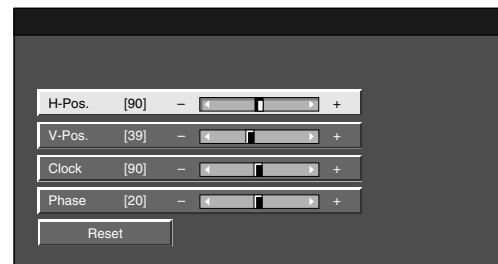

5 Press **◀/▶** to adjust the item to your desired position.

NOTE

- For resetting all adjustment items to the factory preset values, press **▲/▼** to select "Reset", and then press **ENTER**.

Selected item	Description
H-Pos.	Centers the image by moving it to the left or right.
V-Pos.	Centers the image by moving it up or down.
Clock	Adjusts the clock frequency.
Phase	Adjusts the clock phase.

Input Select

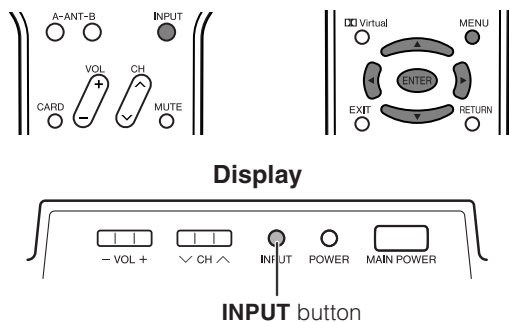

Selecting input source

Can use for selecting the input source.

- 1 Press **INPUT** on the remote control unit or on the Display.
- 2 Press **INPUT** on the remote control unit or on the Display to select the input source.
 - An image from the selected source automatically displays.
 - You can also select the input source by pressing $\blacktriangle/\blacktriangledown$.

NOTE

• Some items may be grayed out. They are not selectable.

Selecting input signal type

For setting the signal type of external equipment connected to INPUT 1 or 2 terminals.

- 1 Press **MENU** and the MENU screen displays.
- 2 Press $\blacktriangle/\blacktriangledown$ to select "Option".
- 3 Press $\blacktriangle/\blacktriangledown$ to select "Input Select", and then press **ENTER**.
- 4 Press $\blacktriangle/\blacktriangledown$ to select a signal type you want to set, and then press **ENTER**.
 - If the selected signal type is incorrect, an image does not display or no color image displays.

NOTE

- The System automatically sets input signals from "INPUT1" and "INPUT2".
- **If no (color) image displays, try to change the signal type.**
- Check the operation manual of the external equipment for the signal type.
- Setting INPUT 1 and INPUT 2 signal selection to "Auto" when other equipment is connected will result in the following connectivity priority.

INPUT 1 and INPUT 2	INPUT 5
1. COMPONENT VIDEO	1. DIGITAL PC
2. VIDEO	2. ANALOG PC
	3. DIGITAL AV
	4. ANALOG AV

DVI input signal setting

- 1 Press **INPUT** to select INPUT5.

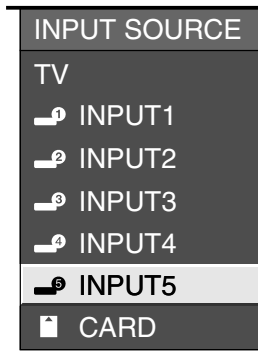

- 2 Press **MENU** and the MENU screen displays.
- 3 Press $\blacktriangle/\blacktriangledown/\blacktriangleleft/\blacktriangleright$ to select "Option".

- 4 Press $\blacktriangle/\blacktriangledown$ to select "Input Select", and then press **ENTER**.

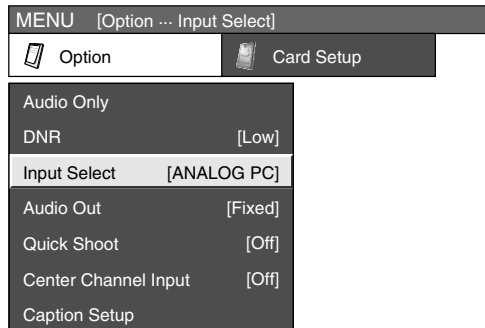

- 5 Press $\blacktriangle/\blacktriangledown$ to select the equipment connected to INPUT 5 terminal, and then press **ENTER**.



Useful adjustment settings

Input Label

Lets you set the input terminal displayed using the INPUT SOURCE menu or channel display.

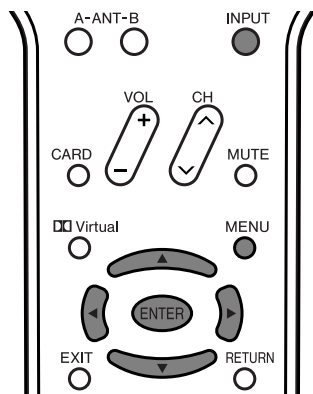

1 Press **MENU** and the MENU screen displays.

2 Press **◀/▶** to select "Setup".
• Option menu displays.

3 Press **▲/▼** to select "Input Label", and then press **ENTER**.

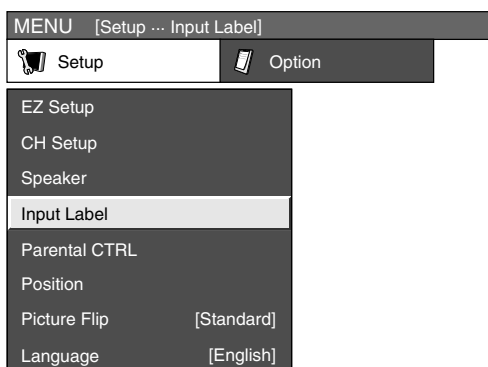

4 Press **▲/▼/◀/▶** to select the new name for the channel, and then press **ENTER**.

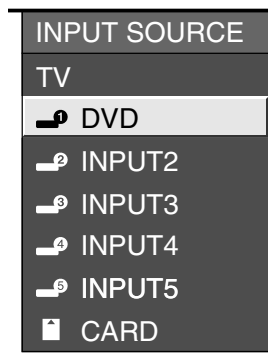

(Example)

Useful adjustment settings

Picture flip

You can set the orientation of the picture.

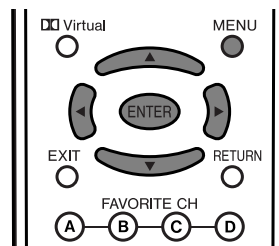

AV input mode

1 Press **MENU** and the MENU screen displays.

2 Press **◀/▶** to select "Setup".

3 Press **▲/▼** to select "Picture Flip", and then press **ENTER**.

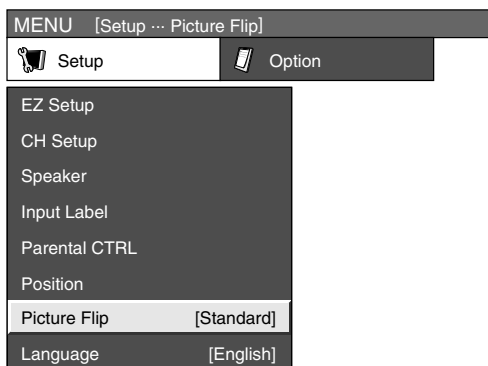

4 Press **▲/▼** to select the desired mode, and then press **ENTER**.

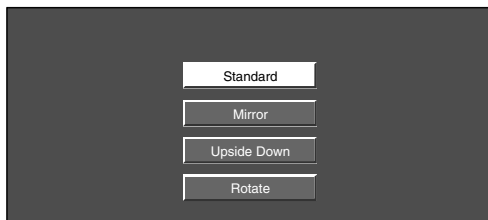

[Standard]: normal image.

[Mirror]: mirror image.



PC input mode

1 Press **MENU** and the MENU screen displays.

2 Press **◀/▶** to select "Setup".

3 Press **▲/▼** to select "Picture Flip", and then press **ENTER**.

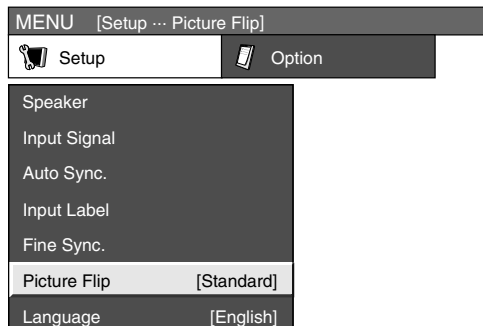

4 Press **▲/▼** to select the desired mode, and then press **ENTER**.

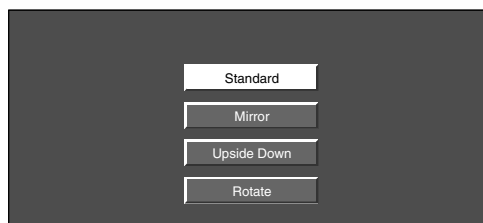

[Upside Down]: upside down image.

[Rotate]: rotated image.



Useful adjustment settings

AV MODE

AV MODE gives you six viewing options to choose from to best match environment of the System, which can vary due to factors like room brightness, type of program watched or the type of image input from external equipment.

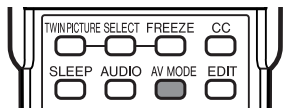

- 1 Press **AV MODE**.
 - Present AV MODE displays.

- 2 Press **AV MODE** again before the mode displayed on the screen disappears.
 - The mode changes as shown below.

Mode selection for the INPUT 1 to 5 terminals (Example)

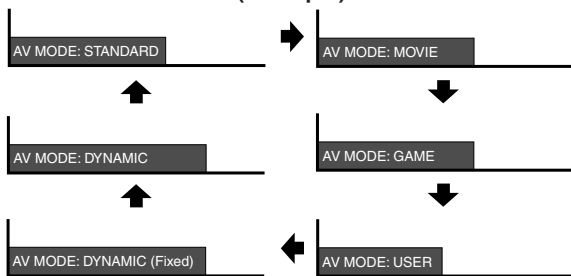

Mode selection for the PC terminal (Example)



Selected item	Description
STANDARD	For a highly defined image in a normally bright room
MOVIE	For a movie
GAME	Lowers image brightness for easier viewing
USER	Allows the user to customize settings as desired. You can set the mode for each input source.
DYNAMIC (Fixed)	Changing image and sound settings to factory preset values. No adjustments are allowed.
DYNAMIC	For a clear-cut image emphasizing high contrast for sports viewing

NOTE

- You can select a different AV MODE item for each input mode. (For example, select STANDARD for TV input and DYNAMIC for VIDEO input.)
- When AV MODE is set to DYNAMIC (Fixed), "No picture adjustments available in Dynamic (Fixed) mode" displays.

View mode for 4:3 Programs

- 1 Press **VIEW MODE**.
 - The View mode menu displays.
 - The menu lists the view mode options selectable for the type of video signal currently received.

- 2 Press **VIEW MODE** or ▲/▼ while the View mode menu is still on the screen.
 - You can sequentially select a view mode that has its own aspect ratio.

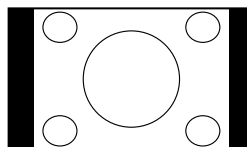
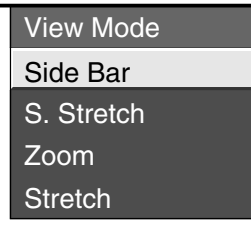
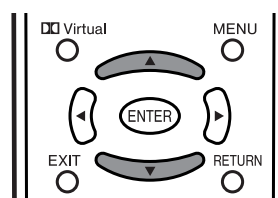

Side Bar: Suitable for viewing conventional 4:3 programs in their normal format.

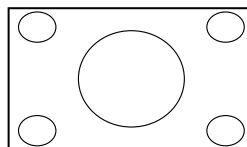

S.Stretch: (Smart stretch) Suitable for stretching 4:3 programs to fill the screen.

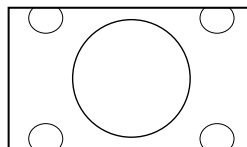

Zoom: Suitable for viewing wide-screen 2.35:1 anamorphic DVDs in full screen.

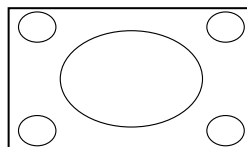

Stretch: This mode is useful for 1.78:1 DVDs. When viewing 1.85:1 DVDs, stretch mode will still show very thin black bands at the top and bottom of the screen.

Useful adjustment settings

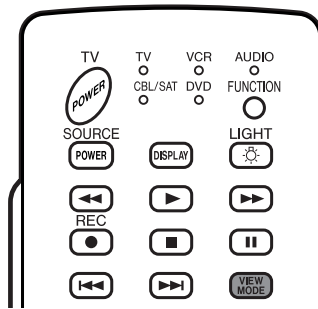

EXAMPLE

Input signal
(640 × 480)

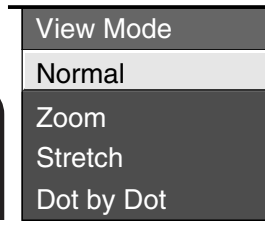

View mode (for PC input mode)

You can select the screen size.

NOTE

- Connect the PC before making adjustments. (See page XX.)
- Selectable screen size may vary with input signal type.

1

Press **VIEW MODE**.

- The View mode menu displays.

2

Press **VIEW MODE** or **▲/▼** to select a desired item on the menu.

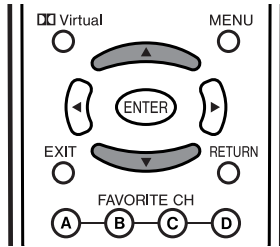

Input signal
(1024 × 768)

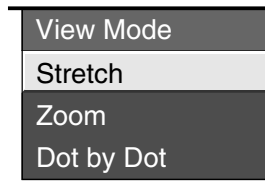

EXAMPLE

Screen size images.

Input signal	Normal	Zoom	Stretch	Dot by Dot
<p>640 × 480</p>	<p>Keeps the original aspect ratio in a full screen display.</p>	<p>Keeps the original aspect ratio in a full screen display. The top and bottom of the image is slightly cropped.</p>	<p>An image fully fills the screen.</p>	<p>Detects the resolution of the signal and displays an image with the same number of pixels on the screen.</p>

Input signal	Normal	Zoom	Stretch	Dot by Dot
<p>1024 × 768</p>		<p>Keeps the original aspect ratio in a full screen display. The top and bottom of the image is slightly cropped.</p>	<p>An image fully fills the screen.</p>	<p>Detects the resolution of the signal and displays an image with the same number of pixels on the screen.</p>

Useful adjustment settings

Input signal (for PC input mode)

- Some input signals may have to be registered manually to display properly.
- The pairs of input signals (resolutions) in the list below are not distinguishable when received. In such case, you have to set the correct signal manually. After setting once, it will display when the same signal (resolution) is input again.

640 × 400	720 × 400
640 × 480	848 × 480
1024 × 768	1280 × 768

NOTE

- You can only select the "Input Signal" on the Setup menu when receiving one of the 6 input signals listed above.

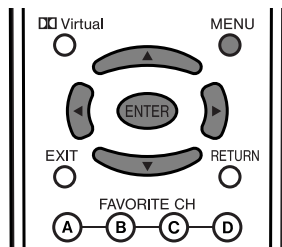

1 Press **MENU** and the MENU screen displays.

2 Press **◀/▶** to select "Setup".

3 Press **▲/▼** to select "Input Signal" and then press **ENTER**.

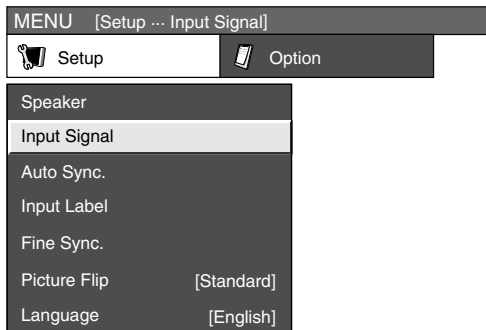

4 Press **▲/▼** to select the desired input signal on the display.

Example

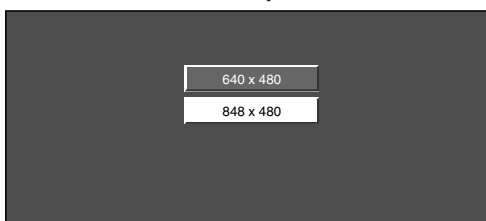

Digital Noise Reduction

Produces a clearer video image.

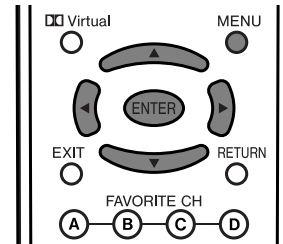

1 Press **MENU** and the MENU screen displays.

2 Press **◀/▶** to select "Option".

3 Press **▲/▼** to select "Digital Noise Reduction", and then press **ENTER**.

- Some items may be grayed out. They are not selectable.

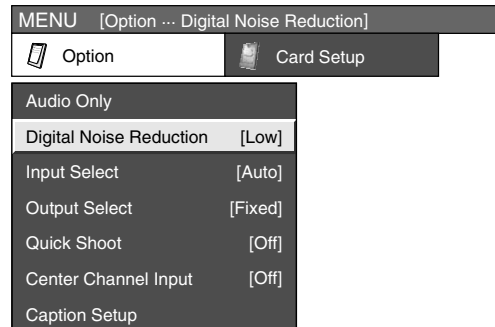

4 Press **▲/▼** to select the desired level, and then press **ENTER**.



NOTE

- "Digital Noise Reduction" is not selectable when channel display shows an input resolution of 720P or 1080I.

Useful adjustment settings

Audio only

When listening to music from a music program, you can set the Liquid Crystal display off and enjoy audio only.

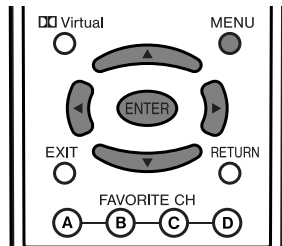

1 Press **MENU** and the MENU screen displays.

2 Press **◀/▶** to select "Option".

3 Press **▲/▼** to select "Audio Only", and then press **ENTER**.

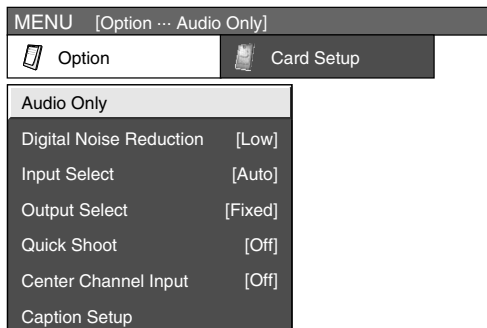

(On-screen display for AV input mode.)

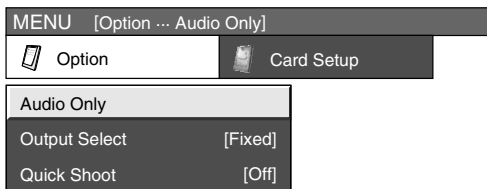

(On-screen display for PC input mode.)

4 Press **◀/▶** to select "On", and then press **ENTER**.

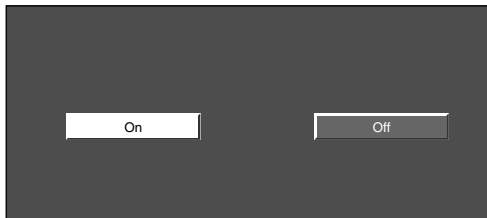

Selected item	Description
On	Audio is output without screen image.
Off	Both screen images and audio are output.

Output Select

Allows you to select what controls the audio output.

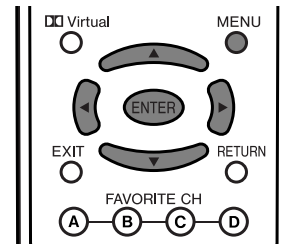

1 Press **MENU** and the MENU screen displays.

2 Press **◀/▶** to select "Option".

3 Press **▲/▼** to select "Output Select", and then press **ENTER**.

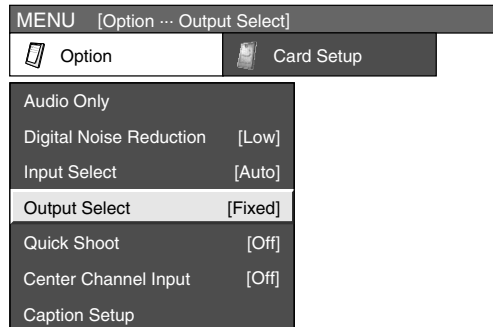

(On-screen display for AV input mode.)

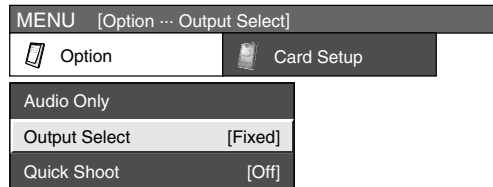

(On-screen display for PC input mode.)

4 Press **◀/▶** to select "Fixed" or "Variable", and then press **ENTER**.

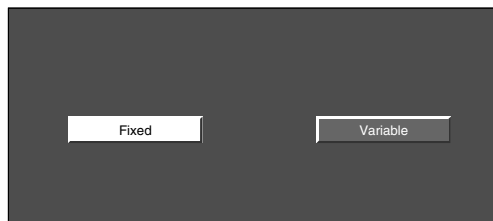

(On-screen display for AV input mode.)

Selected item	Description
Fixed	<ul style="list-style-type: none"> Sound via speaker is adjusted with VOL +/- on the remote control unit or VOL -/+ on the Display. Sound via the MONITOR OUTPUT terminal is not adjustable and constantly outputs.
Variable	<ul style="list-style-type: none"> Sound via the MONITOR OUTPUT terminal is adjusted with VOL +/- on the remote control unit or VOL -/+ on the Display. Sound via speaker is muted.

Useful adjustment settings

Quick shoot

Improves the response of Liquid Crystal Panel when viewing fast-moving images. The effect is greater at low room temperatures (at or below 59°F/15°C).

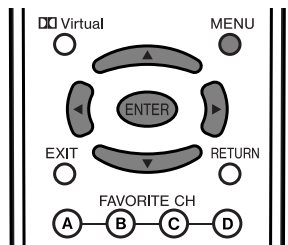

1 Press **MENU** and the MENU screen displays.

2 Press **◀▶** to select "Option".

3 Press **▲▼** to select "Quick Shoot", and then press **ENTER**.

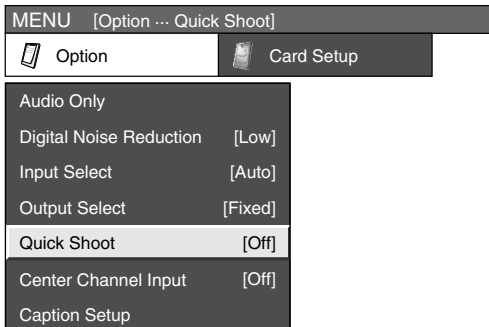

(On-screen display for AV input mode.)

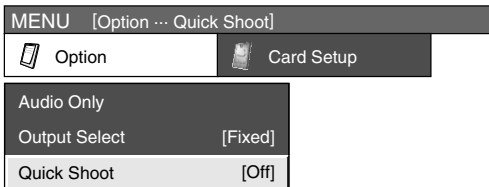

(On-screen display for PC input mode.)

4 Press **◀▶** to select "On", and then press **ENTER**.

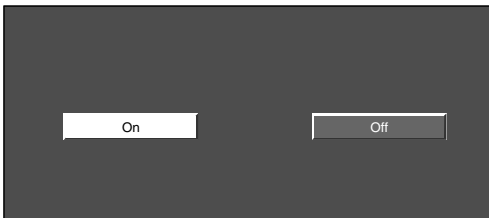

NOTE

- Quick Shoot may cause image noise. If this occurs turn the function "Off".

Sleep timer

Allows you to set a time when the TV automatically switches to standby.

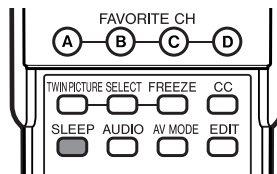

1 Press **SLEEP**.

- Remaining time displays when sleep timer has been set.

Sleep Timer: Remaining 30

2 Each time you press **SLEEP**, the remaining time switches as shown below.

- When set, the time automatically starts counting down.
- If you want to adjust the sleep timer, you can press **SLEEP** twice then change the time setting.
- Five minutes before time expires, the remaining time displays each minute.

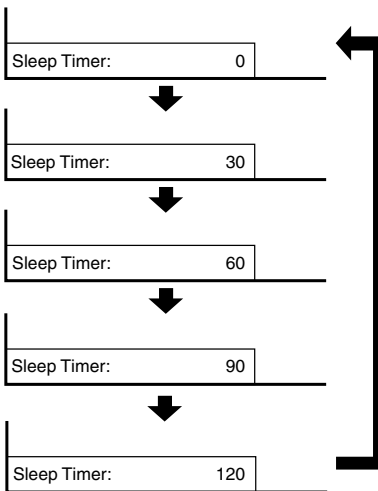

NOTE

- Select "0" by pressing **SLEEP** to cancel the sleep timer.
- When the sleep timer is working, its indicator on the Display lights red.

Useful adjustment settings

Closed caption

- Your System is equipped with an internal closed caption decoder. Closed caption is the system which allows you to view conversations, narration, and sound effects in TV programs and home videos as subtitles on your Display.
- Not all programs and videos offer closed caption. Please look for the “**CC**” symbol to ensure that captions will be shown.
- “CC1” or “CC2” displays subtitles of TV dramas and news programs while allowing a full view of the picture.
- “T1” or “T2” superimposes on the picture other information (e.g. TV guide, weather) that is independent of the TV in progress.

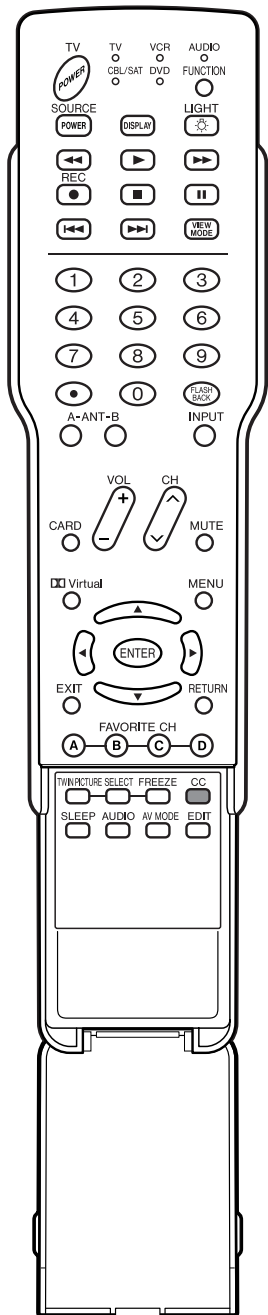

Each time you press **CC**, the closed caption toggles.

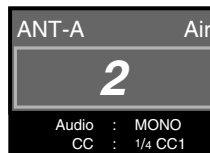

Closed caption information

NOTE

- See page XX to XX for the detailed closed caption settings.
- When using Twin Picture (see page XX) and Still Image (see page XX) functions, the right screen cannot display closed caption data.
- When the program contains no closed caption, “ — ” displays in the closed caption information.
- Four kinds of closed caption information is available. However, selectable item depends on the information program contains.

Useful adjustment settings

Caption Size

Select a caption size.

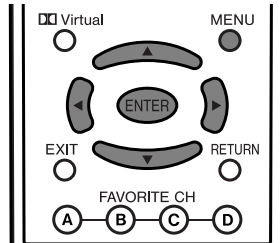

1 Press **MENU** and the MENU screen displays.

2 Press **◀/▶** to select "Option".

3 Press **▲/▼** to select "Caption Setup", and then press **ENTER**.

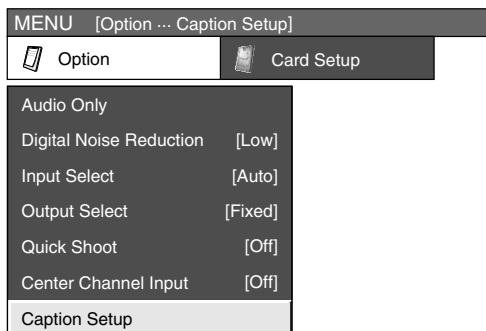

4 Press **▲/▼** to select "Caption Size", and then press **ENTER**.

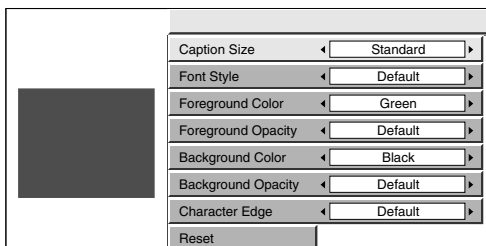

5 Press **◀/▶** to select the desired size, and then press **ENTER**.

NOTE

- Default: The size specified by broadcasting station or default size.

Font Style

Select a font style.

1 Press **MENU** and the MENU screen displays.

2 Press **◀/▶** to select "Option".

3 Press **▲/▼** to select "Caption Setup", and then press **ENTER**.

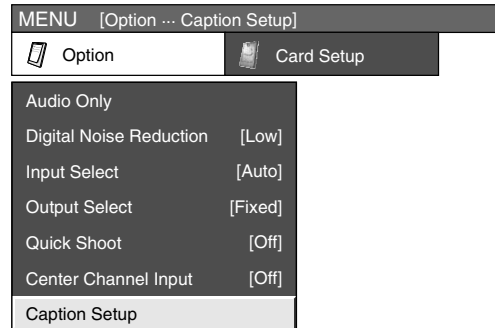

4 Press **▲/▼** to select "Font Style", and then press **ENTER**.

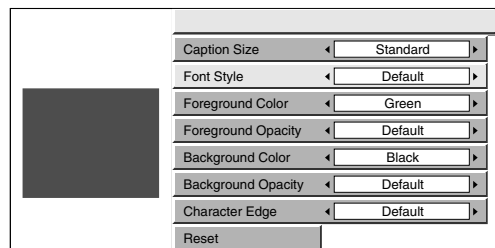

5 Press **◀/▶** to select the desired style, and then press **ENTER**.

Selected item	Description
Default	The font specified by broadcasting station or default font.
Type 0	Proportional font used in the MENU screen.
Type 1	Monospaced with serifs.
Type 2	Proportionally spaced with serifs.
Type 3	Monospaced without serifs.
Type 4	Proportionally spaced without serifs.
Type 5	Casual font type.
Type 6	Cursive font type.
Type 7	Small capitals.

Useful adjustment settings

Foreground Color

Select a character foreground color.

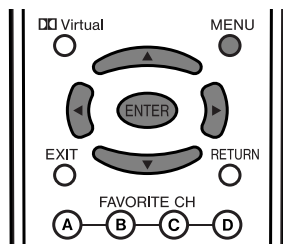

1 Press **MENU** and the MENU screen displays.

2 Press **◀/▶** to select “Option”.

3 Press **▲/▼** to select “Caption Setup”, and then press **ENTER**.

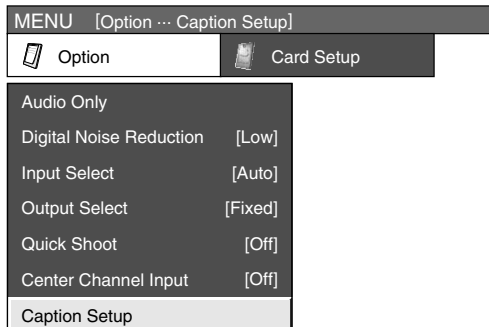

4 Press **▲/▼** to select “Foreground Color”, and then press **ENTER**.

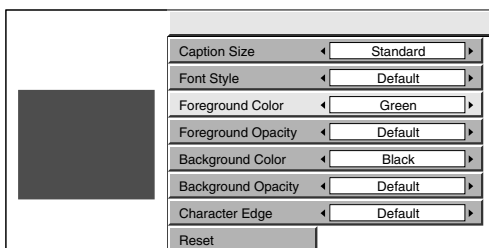

5 Press **◀/▶** to select the desired color, and then press **ENTER**.

NOTE

- Default: The color specified by broadcasting station or default color.

Foreground Opacity

Select a foreground opacity value.

1 Press **MENU** and the MENU screen displays.

2 Press **◀/▶** to select “Option”.

3 Press **▲/▼** to select “Caption Setup”, and then press **ENTER**.

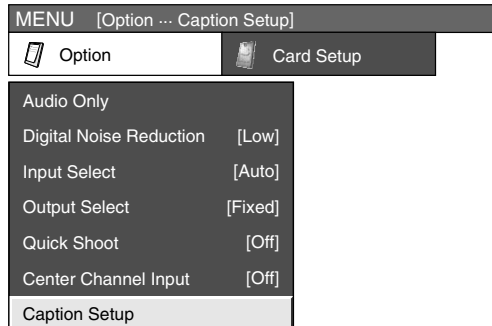

4 Press **▲/▼** to select “Foreground Opacity”, and then press **ENTER**.

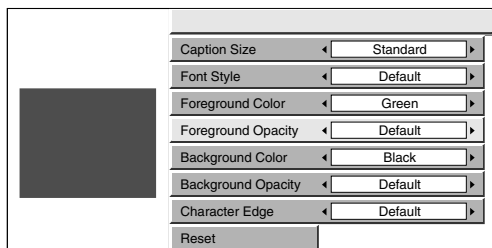

5 Press **◀/▶** to select the desired level, and then press **ENTER**.

NOTE

- Default: The opacity value specified by broadcasting station or default opacity value.

Useful adjustment settings

Background Color

Select a character background color.

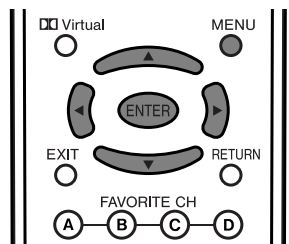

1 Press **MENU** and the MENU screen displays.

2 Press **◀/▶** to select "Option".

3 Press **▲/▼** to select "Caption Setup", and then press **ENTER**.

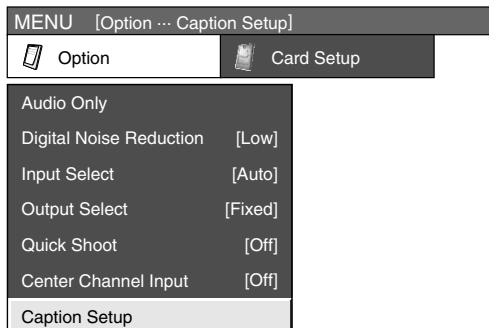

4 Press **▲/▼** to select "Background Color", and then press **ENTER**.

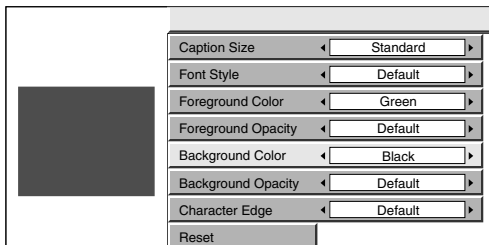

5 Press **◀/▶** to select the desired color, and then press **ENTER**.

NOTE

- Default: The color specified by broadcasting station or default color.

Background Opacity

Select a background opacity value.

1 Press **MENU** and the MENU screen displays.

2 Press **◀/▶** to select "Option".

3 Press **▲/▼** to select "Caption Setup", and then press **ENTER**.

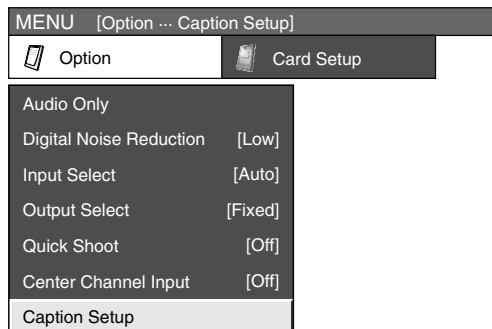

4 Press **▲/▼** to select "Background Opacity", and then press **ENTER**.

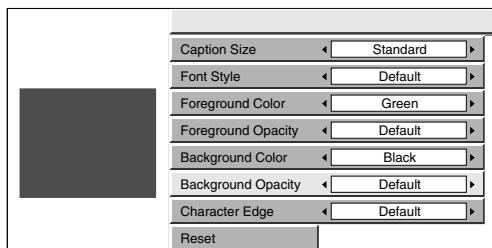

5 Press **◀/▶** to select the desired value, and then press **ENTER**.

NOTE

- Default: The opacity value specified by broadcasting station or default opacity value.

Useful adjustment settings

Character Edge

Select a character edge.

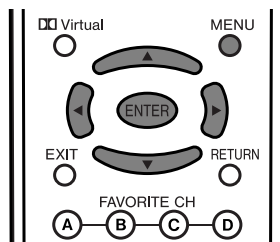

1 Press **MENU** and the MENU screen displays.

2 Press ◀/▶ to select “Option”.

3 Press ▲/▼ to select “Caption Setup”, and then press **ENTER**.

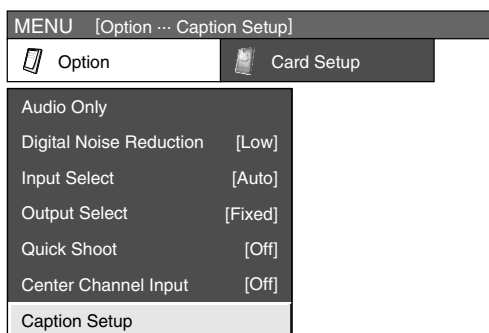

4 Press ▲/▼ to select “Character Edge”, and then press **ENTER**.

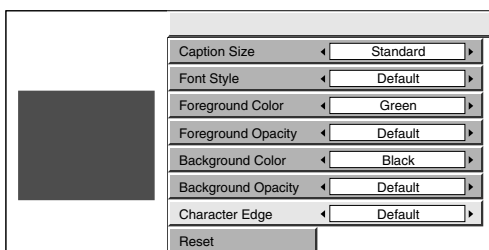

5 Press ◀/▶ to select the desired setting, and then press **ENTER**.

NOTE

- For resetting all adjustment items to the factory preset values, press ▲/▼ to select “Reset”, and then press **ENTER**.

Useful adjustment settings

Secret number setting for parental control (AV input mode only)

Allows you to use a secret number to protect certain settings from being accidentally changed.

IMPORTANT:

Three conditions must be met to enable V-Chip (see pages XX to XX):

- ① Secret No. is registered.
- ② V-Chip settings have been made.
- ③ "Status" is set to "On".

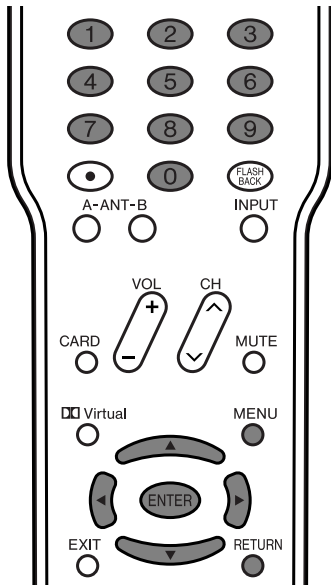

Setting a secret number

- 1 Press **MENU** and MENU screen displays.
- 2 Press **◀/▶** to select "Setup".
- 3 Press **▲/▼** to select "Parental CTRL", and then press **ENTER**.
- 4 Press **▲/▼** to select "Secret No.", and then press **ENTER**.

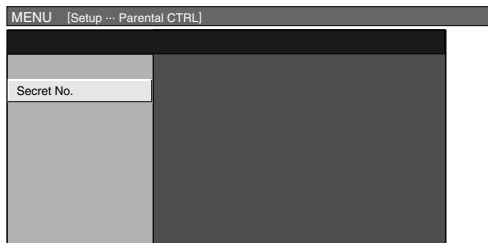

5

Select "New Secret No.", and then press **ENTER**.
Input the new 4-digit secret number by using **0 – 9**.

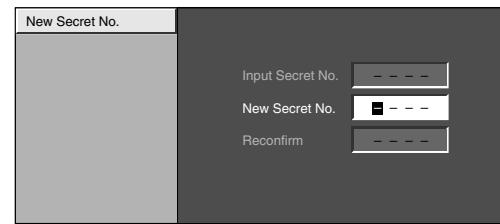

6

Input the same 4-digit number on the "Reconfirm" screen as in step 5 to confirm.

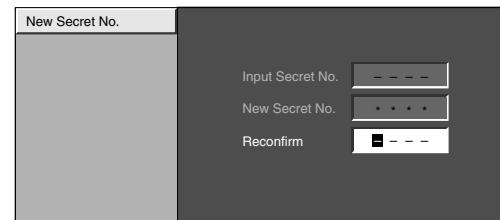

7

Press **RETURN** to start configuring V-Chip settings. (See pages XX and XX for details.)

Setting parental control status

Used to enable or disable the parental control function.

1

Repeat steps 1 to 3 in **Setting a secret number**.
• Secret number setting menu displays.

2

Input the 4-digit secret number by using **0 – 9**.

3

Press **▲/▼** to select "Status", and then press **ENTER**.

4

Press **◀/▶** to select "On" or "Off", and then press **ENTER**.
• Select "On" to enable and "Off" to disable Parental CTRL.

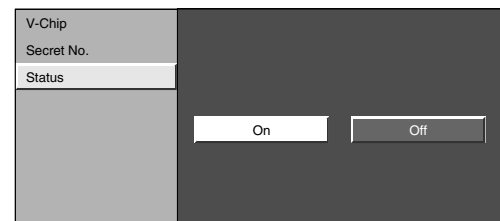

NOTE

- You can skip step 1 and 2 above while in Parental CTRL screen.

Useful adjustment settings

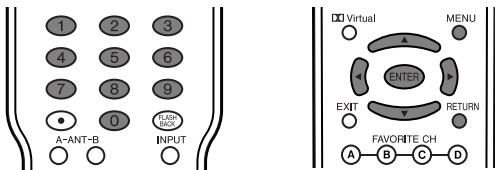

Changing the secret number

Allows you to change your current secret number.

- 1 Repeat steps 1 to 3 in **Setting a secret number**.
 - Secret number setting menu displays.
- 2 Input the 4-digit secret number by using **0 – 9**.
- 3 Press **▲/▼** to select “Secret No.”, and then press **ENTER**.
- 4 Press **▲/▼** to select “New Secret No.”, and then press **ENTER**.
- 5 Input the old 4-digit number you have set using **0 – 9**.

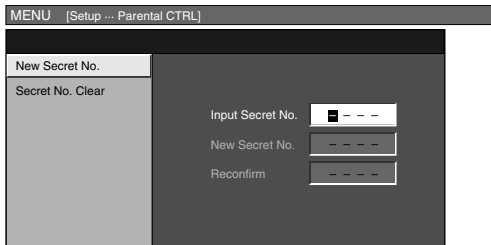

- 6 Input the new 4-digit number using **0 – 9**.

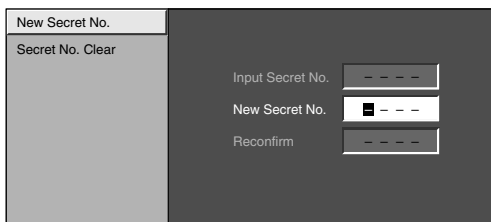

- 7 Input the same 4-digit number on the “Reconfirm” screen as in step 6 to confirm.

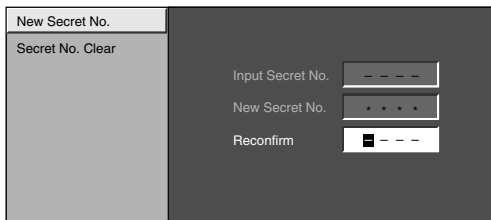

Clearing the secret number

Allows you to clear your secret number.

- 1 Repeat steps 1 to 3 in **Setting a Secret Number**.
 - Secret number setting menu displays.
- 2 Input the 4-digit secret number by using **0 – 9**.
- 3 Press **▲/▼** to select “Secret No.”, and then press **ENTER**.
- 4 Press **▲/▼** to select “Secret No. Clear”, and then press **ENTER**.
- 5 Press **◀/▶** to select “Yes”, and then press **ENTER**.
 - Your secret number is cleared.

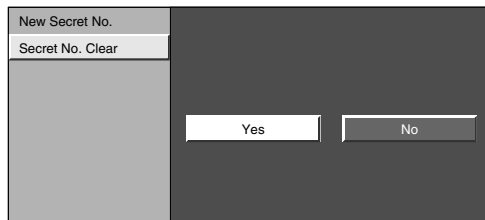

NOTE

- See page XX for re-registering with a new secret number after being cleared.
- **As a precautionary measure, make a note of your secret number and keep it in a familiar place. If you lose or forget your secret number, initialize the Liquid Crystal Television to return all settings except for the TV channel settings to factory preset values. (See page XX.)**
- If the secret number is cleared the Status setting automatically sets to “Off”. “V-Chip” and “Status” will not be selectable from the menu.

Useful adjustment settings

Parental control (setting V-CHIP level)

V-CHIP is an electronic filtering device built into your System. This tool gives parents a great degree of control over broadcasts accessed by their children. It allows parents to select programs judged suitable for child viewing while blocking ones judged not suitable. It does so automatically once you activate the V-CHIP feature in your Liquid Crystal Television.

“V-Chip” and “Status” will not be selectable from the menu if you do not first configure your secret number. (See page XX for Secret number setting for parental control.)

- The U.S. has two rating systems for viewing content: TV Parental Guidelines and movie ratings.
- The TV Parental Guidelines work in conjunction with the V-CHIP to help parents screen out inappropriate television shows from their children.
- Movie ratings are used for original movies rated by the Motion Picture Association of America (MPAA) as watched on cable TV and not edited for television. The V-CHIP can also be set to block MPAA-rated movies.

Voluntary movie rating system (MPAA)

Rating	Description	
Age	G	General audiences. All ages admitted.
	PG	Parental guidance suggested. Some material may not be suitable for children.
	PG-13	Parents strongly cautioned. Some material may be inappropriate for children under 13.
	R	Restricted. Under 17 requires accompanying parent or adult guardian (age varies in some jurisdictions).
	NC-17	No one 17 and under admitted.
X	A rating that has now been superseded by NC-17.	

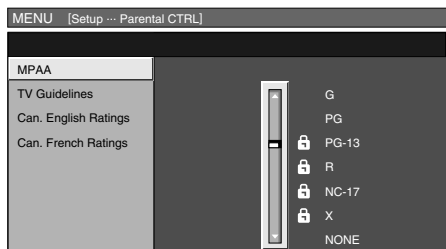

EXAMPLE

- If you select “PG-13”, this will automatically block the higher ratings “R”, “NC-17” and “X”.

NOTE

- Voluntary movie rating system only uses an age-based rating.

TV Parental Guidelines

Rating	Content				
	FV (Fantasy violence)	V (Violence)	S (Sexual situation)	L (Adult language)	D (Sexually suggestive dialog)
Suggested age	TV-Y (All children)				
	TV-Y7 (Directed to older children)	X			
	TV-G (General audience)				
	TV-PG (Parental Guidance suggested)		X	X	X
	TV-14 (Parents strongly cautioned)		X	X	X
TV-MA (Mature audience only)		X	X	X	

X: Content rating can be set.

Useful adjustment settings

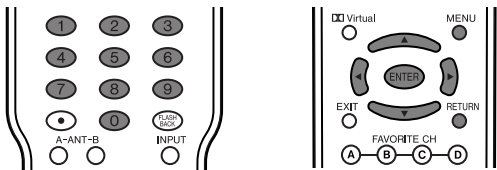

Voluntary movie rating system (MPAA)

1 Press **MENU** and the MENU screen displays.

2 Press **◀/▶** to select "Setup".

3 Press **▲/▼** to select "Parental CTRL", and then press **SET/ENTER**.

- Secret number setting menu displays only when "Secret No." is set. (See page XX.)
- "V-Chip" and "Status" will not be selectable from the menu if you do not first configure your secret number. (See page XX.)

4 Input the 4-digit secret number by using **0 – 9**.

5 Press **▲/▼** to select "V-Chip", and then press **ENTER**.

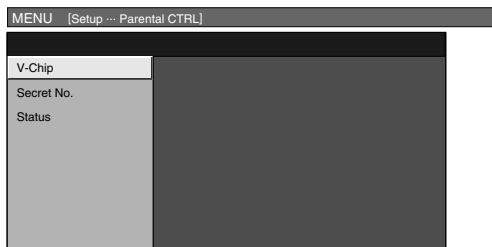

6 Press **▲/▼** to select "MPAA", and then press **ENTER**.

7 Press **▲/▼** to adjust the item to your desired position. "🔒" indicates the item is blocked. Press **RETURN**.

- The setting automatically enters "Block" for any ratings below your selection.
- If Status is not set to "On" the configuration settings will not work. (See page XX.)

Example

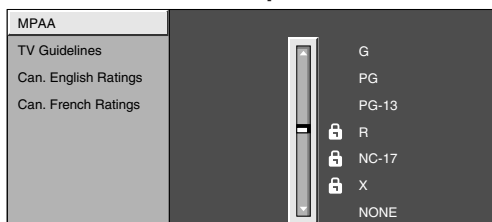

TV Parental Guidelines (TV Guidelines)

1 Repeat steps 1 to 5 in **Voluntary movie rating system (MPAA)**.

2 Press **▲/▼** to select "TV Guidelines", and then press **ENTER**.

3 Press **▲/▼** to adjust the item to your desired position. "🔒" indicates the item is blocked.

- The setting automatically enters "Block" for any ratings below your selection.

Example



When setting an individual content-based rating item, do as follows:

- 1 Press **▶** to access block content items from the currently selected age-based rating item.
- 2 Press **▲/▼** to select an individual item, and then press **ENTER** to unblock ("🔒" is removed). Repeat the same steps for other items.
- 3 Press **◀** or **RETURN** to register after all individual content rating items are set.

Example



- If Status is not set to "On" the configuration settings will not work. (See page XX.)

Useful adjustment settings

Canadian Rating Systems

- The TV rating systems in Canada are based on the Canadian Radio-Television and Telecommunications Commission (CRTC) policy on violence in television programming.
- While violence is the most important content element to be rated, the structure developed takes into consideration other program content like language, nudity, sexuality and mature themes.
- When setting the V-CHIP on the Canadian system you can choose either the Canadian English ratings or the Canadian French ratings.

Canadian English ratings

Rating		Description
Age	E	Exempt: Includes news, sports, documentaries and other information programming; talk shows, music videos, and variety programming.
	C	Children: Intended for younger children under the age of 8 years. Pays careful attention to themes that could threaten their sense of security and well-being.
	C8+	Children over 8 years old: Contains no portrayal of violence as the preferred, acceptable, or only way to resolve conflict; nor encourage children to imitate dangerous acts which they may see on the screen.
	G	General: Considered acceptable for all age groups. Appropriate viewing for the entire family, contains very little violence, physical, verbal or emotional.
	PG	Parental Guidance: Intended for a general audience, but may not be suitable for younger children (under the age of 8) because it could contain controversial themes or issues.
	14+	Over 14 Years: Could contain themes where violence is one of the dominant elements of the storyline, but it must be integral to the development of plot or character. Language usage could be profane and nudity present within the context of the theme.
	18+	Adults: Intended for viewers 18 years and older and might contain depictions of violence, which while related to the development of plot, character or themes, are intended for adult viewing. Could contain graphic language and portrayals of sex and nudity.

Canadian French ratings

Rating		Description
Age	E	Exempt programming.
	G	General: All ages and children, contains minimal direct violence, but may be integrated into the plot in a humorous or unrealistic manner.
	8ans +	General but inadvisable for young children: May be viewed by a wide public audience, but could contain scenes disturbing to children under 8 who cannot distinguish between imaginary and real situations. Recommended for viewing with parent.
	13ans +	Over 13 years: Could contain scenes of frequent violent scenes and therefore recommended for viewing with parent.
	16ans +	Over 16 years: Could contain frequent violent scenes and intense violence.
	18ans +	Over 18 years: Only for adult viewing. Could contain frequent violent scenes and extreme violence.

Useful adjustment settings

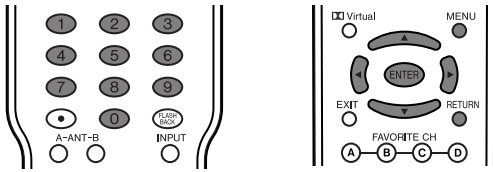

Canadian English ratings

1 Press **MENU** and the MENU screen displays.

2 Press **◀/▶** to select "Setup".

3 Press **▲/▼** to select "Parental CTRL", and then press **ENTER**.

- Secret number setting menu displays only when "Secret No." is set. (See page XX.)
- "V-Chip" and "Status" will not be selectable from the menu if you do not first configure your secret number. (See page XX.)

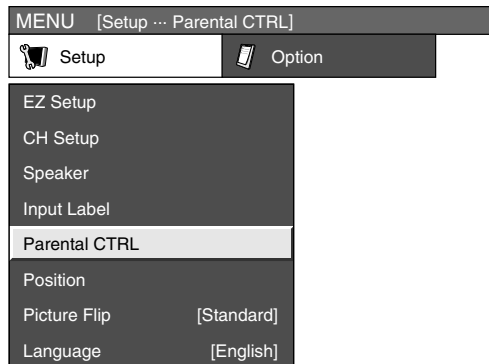

4 Input the 4-digit secret number by using **0 – 9**.

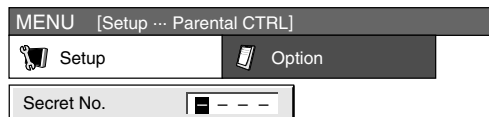

5 Press **▲/▼** to select "V-Chip", and then press **ENTER**.

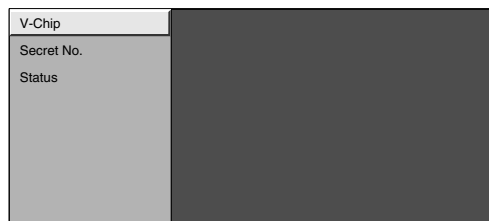

6 Press **▲/▼** to select "Can. English Ratings", and then press **ENTER**.

7

Press **▲/▼** to adjust the item to your desired position. "🔒" indicates the item is blocked.

- The setting automatically enters "Block" for any ratings below your selection.
- If Status is not set to "On" the configuration settings will not work. (See page XX.)

Example

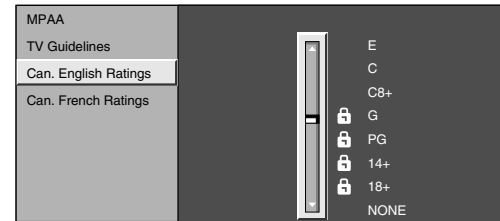

Canadian French ratings

1

Repeat steps 1 to 5 in **Canadian English ratings**.

2

Press **▲/▼** to select "Can. French Ratings", and then press **ENTER**.

3

Press **▲/▼** to adjust the item to your desired position. "🔒" indicates the item is blocked.

- The setting automatically enters "Block" for any ratings below your selection.
- If Status is not set to "On" the configuration settings will not work. (See page XX.)

Example

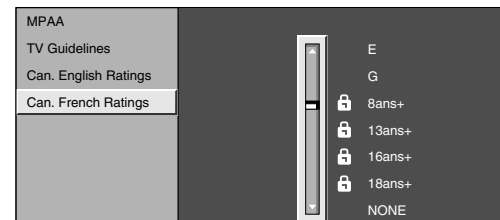

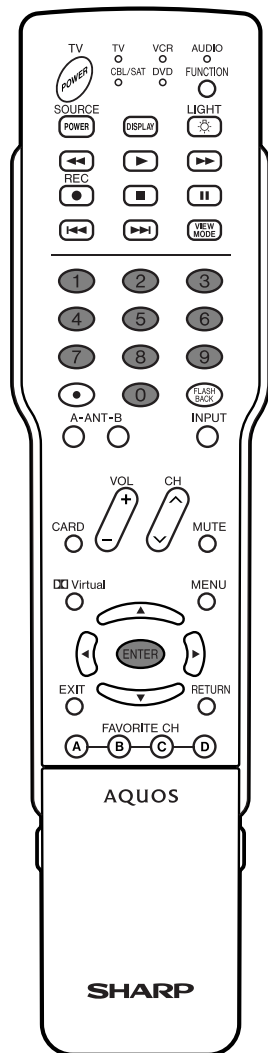

How to temporarily release the V-CHIP BLOCK

- The V-CHIP BLOCK is working and censors a broadcast, "V-CHIP HAS BEEN ACTIVATED." displays.

1

Press **ENTER** while the V-CHIP is working and then the secret number setting menu displays.

2

Enter your 4-digit secret number with **0 – 9** and then press **ENTER**. At this time V-CHIP BLOCK temporarily releases.

Reactivating the temporarily released the V-CHIP BLOCK

- You can reactivate the temporarily released V-CHIP BLOCK as shown below.

Method 1:

Select "Status" setting from the Parental CTRL menu to reactivate BLOCK. See page XX.

Method 2:

Select "V-Chip" setting ("MPAA", "TV Guidelines", "Can. English Ratings" or "Can. French Ratings") from the Parental CTRL to reactivate BLOCK. See pages XX and XX.

Method 3:

Switch off the AVC System power.

NOTE

- Performing any of the three above will activate the V-CHIP BLOCK.

Useful adjustment settings

Center Channel Input

You can use the display speakers as center speaker when using 5.1ch surrounding sound system.

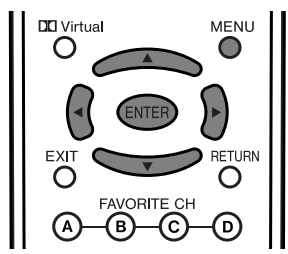
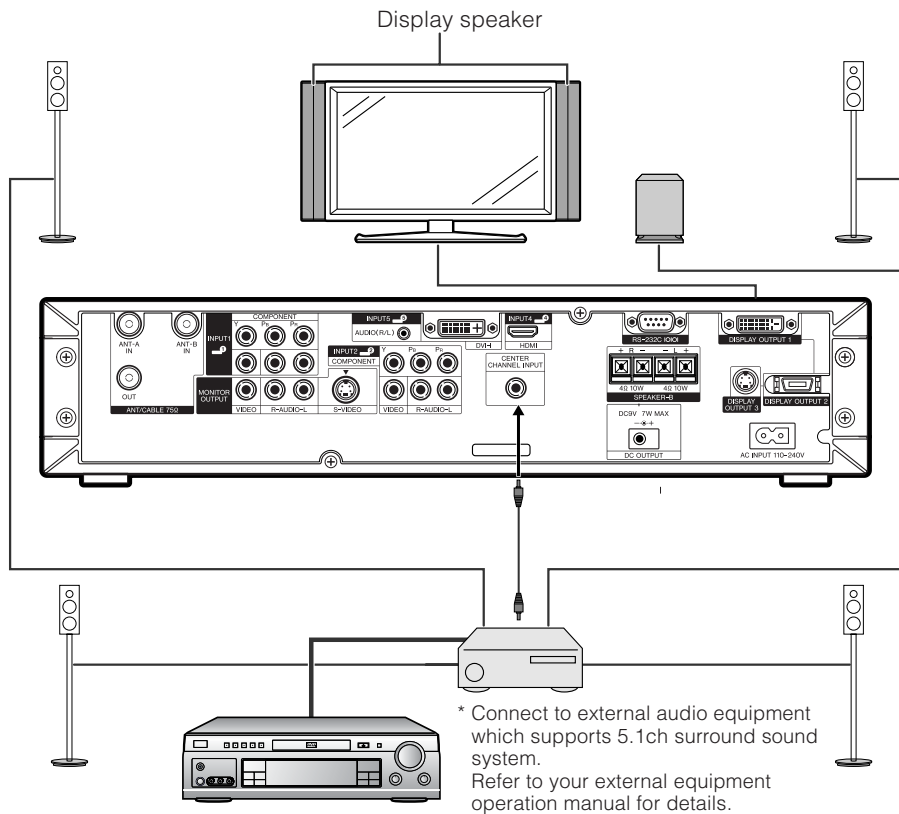

- 1 Press **MENU** and the MENU screen displays.
- 2 Press **◀▶** to select "Option", and then press **ENTER**.
- 3 Press **▲▼** to select "Center Channel Input", and then press **ENTER**.

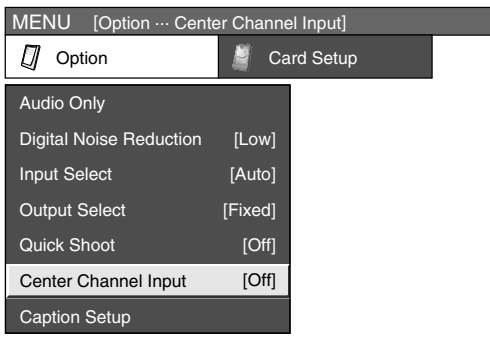

- 4 Press **◀▶** to select "On", and then press **ENTER**.

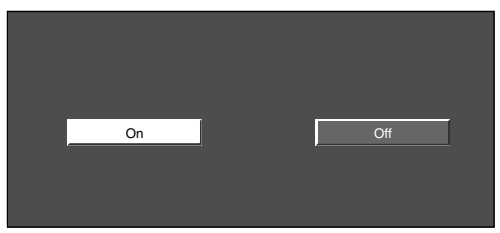

NOTE

- Sound from Centre Channel Input terminal is output from the display speaker.

Other viewing options

Twin picture functions

Allows you to display two pictures on the screen at one time.

Twin picture in all cases

You can display two same-sized pictures except when inputting from INPUT 5 terminal and card.

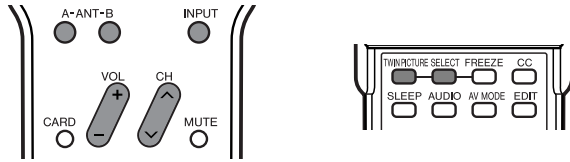

1

Press **TWIN PICTURE**.

- Twin picture displays and a selected input source image displays.



2

Press **SELECT** to set either screen to be active.

- “♪” displays on the active screen, which has sound output.

3

Press **TWIN PICTURE** to exit twin picture.

NOTE

- This function does not work under the following input conditions:
 - ① PC INPUT mode,
 - ② CARD mode,
 - ③ Two pictures from the same source (e.g. INPUT 1 and INPUT 1),
 - ④ HDTV signal source is input on the right side screen display.
- When this function is not available, “No dual screen display available” will display.
- Pressing **ANT-A/B** while viewing in Twin Picture mode (TV image and video image) with TV selected will display the TV image of the other tuner.
- Pressing **ANT-A/B** while viewing Twin Picture with video selected will not change the image displayed.
- Pressing **ANT-A/B** while viewing Twin Picture with two TV images displayed will not have any effect.
- Pressing **ANT-A/B** while viewing Twin Picture with two video images displayed will switch the selected screen to a TV image.

Picture and still image

You can display two same-sized pictures – one moving and one still – when inputting from an AV source.

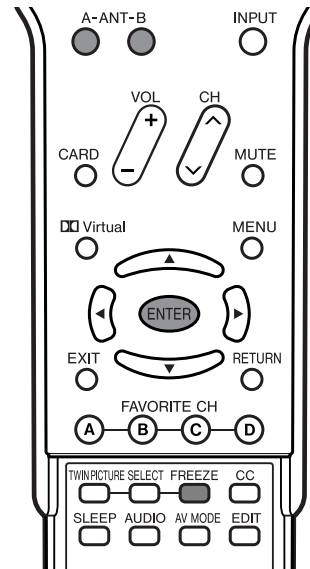

1

Press **FREEZE**.

- A moving image displays on the left screen and a still image displays on the right screen. The still image is one frame captured from a moving image at the moment you press **FREEZE**.

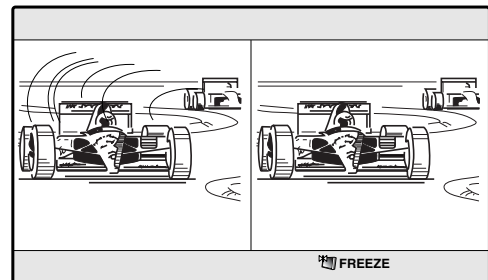

2

Update the still image by pressing **ENTER**.

- Each time you press **ENTER**, the image on the right screen updates.

3

Press **RETURN** to exit still image.

NOTE

- This function does not work in PC and Card mode.
- When this function is not available, “No still image display available.” will display.
- The still image automatically goes out after 30 minutes.

Other viewing options

Presetting remote control function

You can operate the connected AV products (AV Receiver, Cable Box, SAT tuner, DTV, VCR, DVD, LD) using the presetting manufacturer function for your remote control unit.

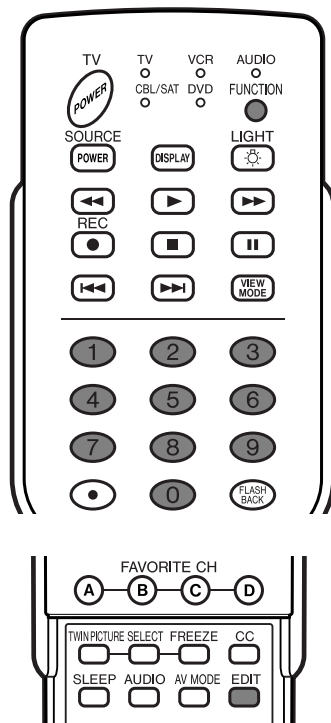

Presetting manufacturer codes

- 1 Press **FUNCTION** to match the device to which you want to preset the remote control code.
- 2 Press **EDIT** and **1** at the same time.
 - LED flashes continuously.
- 3 Press **0 – 9** to enter the manufacturer code. (See page XX.)
 - Preset mode is finished once the LED no longer lights up.

NOTE

- To stop the EDIT mode in the middle, press **EDIT** once more.
- If **FUNCTION** is pressed while in EDIT mode, EDIT mode will be canceled.
- If there is no operation for over 1 minute running, exit this mode.
- When you enter a code that is not listed, LED flashes quickly.
- The initial mode is "00".

Other viewing options

Manufacturer codes

VCR BRAND	REMOTE CONTROL CODE NUMBER
Akai	25, 26, 37
Audio	15, 22, 30
Broksonic	32
Canon	04
Capehart	34
Craig	10, 31
Curtis Mathis	04
Daewoo	34
DBX	15, 22, 30
Dynatech	29
Emerson	21, 32, 35
Fisher	09, 10, 11
Funai	28, 29
G.E.	04
Goldstar	24
Hitachi	06, 47
Instant Replay	04
JC Penney	04, 06, 24, 30
JVC	15, 41, 42, 53
Kenwood	14, 15
Lloyds	29
Magnavox	04, 05, 08
Magnin	31
Marantz	30
Memorex	04, 10, 24, 29
Minolta	06
Mitsubishi	17, 18, 39, 40
Montgomery Ward	02, 43
Multitech	29
NEC	15, 22, 30
Panasonic	44, 45
Pentax	05, 06
Philco	05
Philips	05, 08
RCA	06, 07, 33, 51
Realistic	01, 02, 10, 24
Samsung	23, 31
Sanyo	10, 14, 52
Scott	20
Sears	06, 11, 24
Sharp	01, 02, 03
Shintom	36
Sony	12, 13, 38
Sound Design	29
Sylvania	05, 08
Symphonic	29
Tatung	15
Teac	15, 29
Teknika	27, 29
Thomas	29
TMK	21
Toshiba	19, 20
Video Concepts	30
Yamaha	15, 29, 30
Zenith	16

DVD/LD BRAND	REMOTE CONTROL CODE NUMBER
Denon	02
JVC	09, 13
Kenwood	21
Magnavox	04
Marantz	04
Mitsubishi	06
Panasonic	02, 22
Philips	04, 23
Pioneer	08, 11, 20
Proscan	03
RCA	03, 24
Samsung	07, 12
Sharp	01, 10
Sony	05, 25
Toshiba	04
Yamaha	02
Zenith	04

CATV CONVERTER BRAND	REMOTE CONTROL CODE NUMBER
Anvision	04, 05
Cable Star	04, 05
Eagle	05
General Instrument	02, 03, 07, 12, 13, 14, 19, 22
Jerrold	02, 03, 07, 12, 13, 14, 19, 22, 31, 32, 33, 34, 35, 36, 37, 38, 39, 40
Magnavox	04, 05, 09, 14, 17, 18, 20, 21, 24, 25
Oak Sigma	8
Panasonic	16, 23
Philips	04, 05, 09, 15, 17, 18, 20, 21, 24, 25
Pioneer	08, 10, 29, 30, 46
Randtek	04, 05
RCA	16, 27, 44, 45
Scientific Atlanta	01, 26
Sony	28
Viewstar	04, 05, 09, 15, 17, 18, 20, 21, 24, 25
Zenith	06, 14

AUDIO BRAND	REMOTE CONTROL CODE NUMBER
Sharp	01

Other viewing options

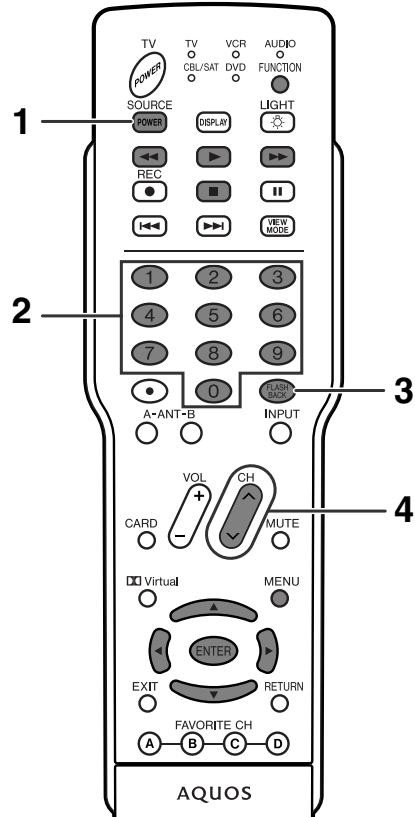

Cable control buttons

When the **FUNCTION** is set to CBL/SAT the cable converter connected to the Display can operate using **1** to **4**.

- 1 SOURCE POWER**
Turns the cable converter power on and off.
- 2 0 – 9**
Press a button (or buttons) that corresponds to the channel that you wish to watch.
- 3 FLASHBACK ***
Press to switch between the current channel and the channel you were watching immediately before.
- 4 CH ▲/▼**
Press **CH ▲** or **CH ▼** to tune in a higher or lower channel.

* Some manufacturers do not preset **FLASHBACK**.

NOTE

- CABLE and SAT cannot be selected at the same time.

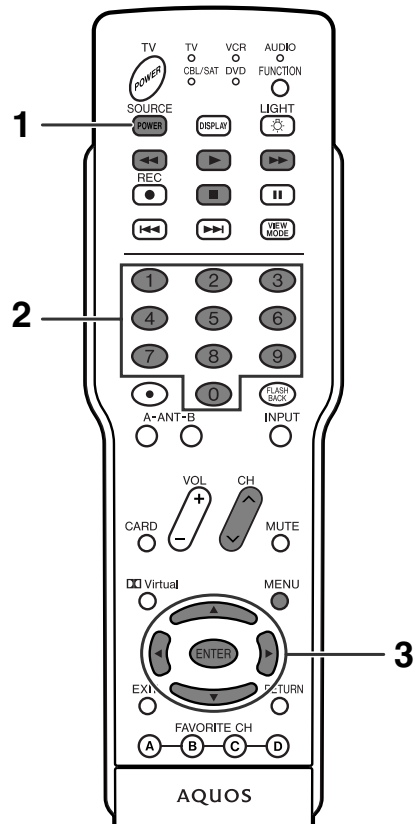

SAT control buttons

- 1 SOURCE POWER**
Turns the Satellite broadcast tuner power on and off.
- 2 0 – 9**
Press a button (or buttons) that corresponds to the channel that you wish to watch.
- 3 ENTER, ▲/▼/◀/▶**
ENTER: Press to activate the selected function.
▲/▼/◀/▶: Press the button to select items on the SAT GUIDE screen or SAT MENU screen.

NOTE

- CABLE and SAT cannot be selected at the same time.

Other viewing options

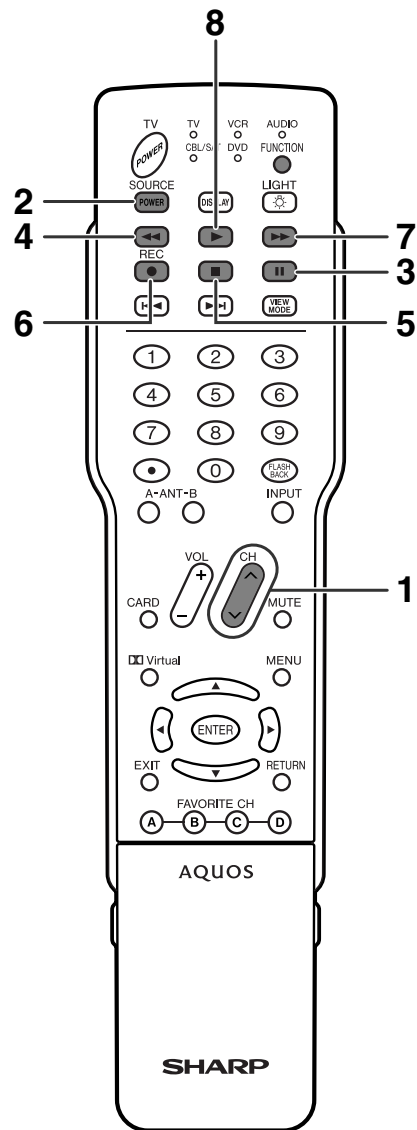

VCR control buttons

The remote control unit button will function as follows when the **FUNCTION** of the remote control unit is set to VCR.

- When the input selector button having the same number as the input terminal connecting the VCR is pressed, the VCR can operate using **1 to 8**.

- 1 CH ▲/▼**
Press to select the channel of the TV tuner on the VCR.
- 2 SOURCE POWER**
Turns the power of the VCR on and off.
- 3 II**
Sets pauses and still pictures.
- 4 ◀◀**
Rewinds the tape and allows picture search.
- 5 ■**
Stops the tape transport.
- 6 REC**
Start recording.
- 7 ▶▶**
Rapidly advances the tape and allows picture search.
- 8 ▶**
Starts playback.

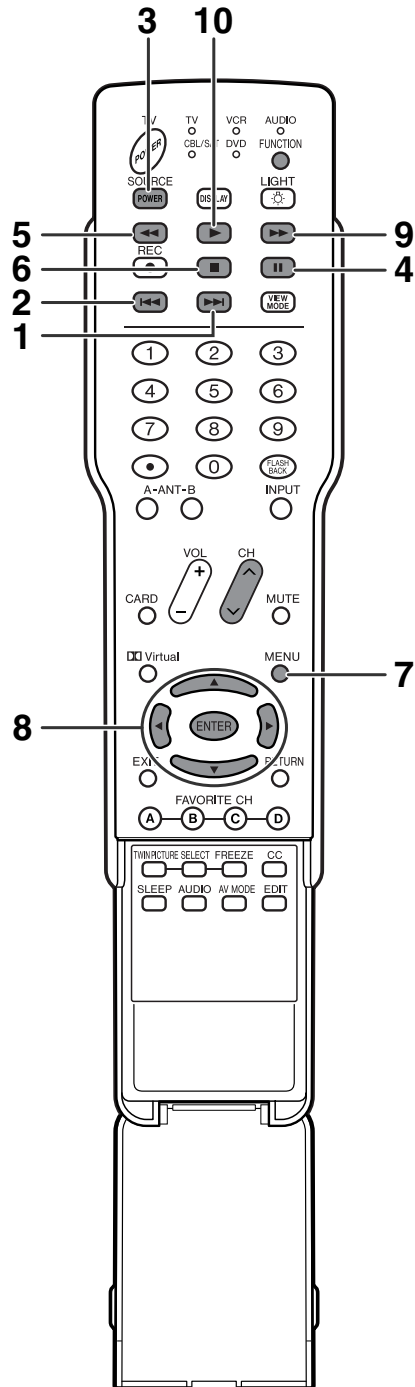

DVD control buttons

The remote control unit button will function as follows when the **FUNCTION** of the remote control unit is set to DVD.

- When the input selector button having the same number as the input terminal connecting a DVD player is pressed, these players can operate using **1 to 11**. (7 to 9 are for DVD players only.)

- Pressing quickly once takes you to the start of the next chapter. Each time you press it, you move ahead to the start of the next chapter.
- Pressing quickly once takes you to the start of the chapter currently playing. Each time you press it, you move back to the start of the previous chapter.
- SOURCE POWER**
Turns the power of the DVD player on and off.
- Set pauses and still pictures.
- Continue pressing to go backward.
- Playback stops when pressing once. With some DVD players, pressing the button twice may open the disc tray.
- DVD MENU**
When this button is pressed, the DVD menu will display.
- ENTER, ▲/▼/◀/▶**
ENTER: Press to activate the selected function.
▲/▼/◀/▶: Press the button to select items on the DVD MENU screen.
- Continue pressing for fast forward.
- Starts playback.

Appendix

Troubleshooting

Problem	Possible Solution
<ul style="list-style-type: none"> No power 	<ul style="list-style-type: none"> Make sure the Display and the AVC System are connected correctly. (See page XX.) Check if you pressed TV POWER on the remote control unit. (See page XX.) If the indicator on the Display lights up red, press POWER on the Display. Is the AC cord disconnected? (See page XX.) Has the main power been turned on? (See page XX.)
<ul style="list-style-type: none"> Unit cannot be operated. 	<ul style="list-style-type: none"> External influences such as lightning, static electricity, may cause improper operation. In this case, operate the unit after first turning on the power of the Display and the AVC System, or unplugging the AC cord and replugging it in after 1 or 2 minutes.
<ul style="list-style-type: none"> Remote control unit does not operate. 	<ul style="list-style-type: none"> Is the Mode switch set correctly? Slide it to the TV setting position. Are batteries inserted with polarity (+, -) aligned? (See page XX.) Are batteries worn out? (Replace with new batteries.) Are you using it under strong or fluorescent lighting? Is a fluorescent light illuminated near the remote control sensor?
<ul style="list-style-type: none"> Picture is cut off/with sidebar screen. 	<ul style="list-style-type: none"> Is the image position correct? (See pages XX and XX.) Are screen mode adjustments such as picture size made correctly? (See pages XX and XX)
<ul style="list-style-type: none"> Strange color, light color, or color misalignment 	<ul style="list-style-type: none"> Adjust the picture tone. (See pages XX to XX.) Is the room too bright? The picture may look dark in a room that is too bright. Check the input signal setting. (See page XX.)
<ul style="list-style-type: none"> Power is suddenly turned off. 	<ul style="list-style-type: none"> Is the sleep timer set? (See page XX.) Check the power control settings. (See pages XX and XX.) The unit's internal temperature has increased. Remove any objects blocking vent or clean.
<ul style="list-style-type: none"> No picture 	<ul style="list-style-type: none"> Is connection to other components correct? (See pages XX to XX.) Is correct input signal source selected after connection? (See page XX.) Is the correct input selected? (See page XX.) Is a non-compatible signal being input? (See page XX.) Is picture adjustment correct? (See pages XX to XX.) Is "On" selected in "Audio Only"? (See page XX.)
<ul style="list-style-type: none"> No sound 	<ul style="list-style-type: none"> Is the volume too low? (See page XX.) Is "Variable" selected in "Output Select"? (See page XX.) Is correct speaker output ("Speaker-A" or "Speaker-B") selected in "Speaker"? (See pages XX and XX.) Is "On" selected in "Center Channel Input"? (See page XX.)

Cautions regarding use in high and low temperature environments

- When the unit is used in a low temperature space (e.g. room, office), the picture may leave trails or appear slightly delayed. This is not a malfunction, and the unit will recover when the temperature returns to normal.
 - Do not leave the unit in a hot or cold location. Also, do not leave the unit in a location exposed to direct sunlight or near a heater, as this may cause the cabinet to deform and the Liquid Crystal panel to malfunction.
- Storage temperature: -4°F to +140°F (-20°C to +60°C)

PC compatibility chart

PC/MAC	Resolution		Horizontal Frequency	Vertical Frequency	VESA Standard
PC	VGA	640 x 400	31.5 kHz	60 Hz	
			37.9 kHz	85 Hz	O
		720 x 400	31.5 kHz	60 Hz	
			37.9 kHz	85 Hz	O
		640 x 480	31.5 kHz	60 Hz	O
			37.9 kHz	72 Hz	O
	37.5 kHz		75 Hz	O	
	43.3 kHz		85 Hz	O	
	WVGA	848 x 480	31.5 kHz	60 Hz	
	SVGA	800 x 600	35.1 kHz	56 Hz	O
			37.9 kHz	60 Hz	O
			48.1 kHz	72 Hz	O
			46.9 kHz	75 Hz	O
			53.7 kHz	85 Hz	O
	XGA	1024 x 768	48.4 kHz	60 Hz	O
			56.5 kHz	70 Hz	O
			60.0 kHz	75 Hz	O
			68.7 kHz	85 Hz	O
	WXGA	1280 x 720	45.0 kHz	60 Hz	
		1280 x 768	48.1 kHz	60 Hz	
SXGA	1280 x 1024	64.0 kHz	60 Hz	O	
MAC13"	VGA	640 x 480	34.9 kHz	67 Hz	
MAC16"	SVGA	832 x 624	49.7 kHz	75 Hz	
MAC19"	XGA	1024 x 768	60.2 kHz	75 Hz	

Apple and Macintosh are registered trademarks of Apple Computer, Inc.
 DDC is a registered trademark of Video Electronics Standards Association.
 Power Management is a registered trademark of Sun Microsystems, Inc.
 VGA and XGA are registered trademarks of International Business Machines Co., Inc.

RS-232C port specifications

PC Control of the System

- When a program is set, the Display can be controlled from the PC using the RS-232C terminal.
The input signal (PC/AV) can be selected, the volume can be adjusted and various other adjustments and settings can be made, enabling automatic programmed playing.
- Attach an RS-232C cable cross-type (commercially available) to the supplied Din/D-Sub RS-232C for the connections.

NOTE

- This operation system should be used by a person who is accustomed to using computers.

Communication conditions

Set the RS-232C communications settings on the PC to match the display's communications conditions. The Display's communications settings are as follows:

Baud rate:	9,600 bps
Data length:	8 bits
Parity bit:	None
Stop bit:	1 bit
Flow control:	None

Communication procedure

Send the control commands from the PC via the RS-232C connector. The display operates according to the received command and sends a response message to the PC. Do not send multiple commands at the same time. Wait until the PC receives the OK response before sending the next command.

Command format

Eight ASCII codes + CR



Parameter

Input the parameter values, aligning left, and fill with blank(s) for the remainder. (Be sure that 4 values are input for the parameter.)

When the input parameter is not within an adjustable range, "ERR" returns. (Refer to "Response code format".)
No problem to input any numerical value for "x" on the table.

0			
0	0	0	9
-	3	0	
1	0	0	
0	0	5	5

When "?" is input for some commands, the present setting value responds.

?			
?	?	?	?

Appendix

Response code format

Normal response

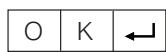

Return code (0DH)

Problem response (communication error or incorrect command)



Return code (0DH)

Command table

- About the command except being indicated here, it is outside the guarantee range of operation.

CONTROL ITEM		COMMAND	PARAMETER	CONTROL CONTENTS		
POWER SETTING		P O W E R	0 _ _ _	It shifts to standby.		
INPUT SELECTION A	TOGGLE	I T T G D	x _ _ _	(Toggle) It input-switches by the toggle. (It is the same as an input change key)		
	TV	I T V D	0 _ _ _	It input-switches to TV. (A channel remains as it is. (Last memory))		
	INPUT1-5	I A V D	* _ _ _	Input terminal number (1-5) It input-switches to INPUT1~INPUT5.		
	CARD	I C R D	x _ _ _	It shifts to CARD mode.		
INPUT SELECTION B	INPUT 1	I N P 1	0 _ _ _	AUTO	An input change is also included.	
			1 _ _ _	VIDEO		
	INPUT 2	I N P 2	0 _ _ _	AUTO		
			1 _ _ _	VIDEO		
	INPUT 5	I N P 5	5 _ _ _	DIGITAL PC		
			6 _ _ _	ANALOG PC		
			7 _ _ _	DIGITAL AV		
			8 _ _ _	ANALOG AV		
	AV MODE SELECTION		A V M D	0 _ _ _		(Toggle) Although it can choose now, it is toggle operation in inside.
				1 _ _ _		STANDARD
			2 _ _ _	MOVIE		
			3 _ _ _	GAME		
			4 _ _ _	USER		
			5 _ _ _	DYNAMIC (Fixed)		
			6 _ _ _	DYNAMIC		
VOLUME		V O L M	* * _ _	Volume (0-60)		
POSITION	H-POSITION	H P O S	* * * _	AV mode. (± 10)		
			* * * _	PC mode. (0-180)		
	V-POSITION	V P O S	* * * _	AV mode. (± 20)		
			* * * _	PC mode. (0-100)		
	CLOCK	C L C K	* * * _	Only PC mode. (0-180)		
PHASE	P H S E	* * * _	Only PC mode. (0-40)			
VIEWMODE		W I D E	0 _ _ _	(Toggle) [AV] Although it can choose now, it is toggle operation in inside.		
			1 _ _ _	Side Bar [AV]		
			2 _ _ _	S.Stretch [AV]		
			3 _ _ _	Zoom [AV]		
			4 _ _ _	Stretch [AV]		
			5 _ _ _	Normal [PC]		
			6 _ _ _	Zoom [PC]		
			7 _ _ _	Stretch [PC]		
			8 _ _ _	Dot by Dot [PC]		
MUTE		M U T E	0 _ _ _	(Toggle) 1 _ _ _ On 2 _ _ _ Off		
Dolby Virtual		A C D V	0 _ _ _	(Toggle) 1 _ _ _ On 2 _ _ _ Off		
AUDIO SELECTION		A C H A	x _ _ _	(Toggle)		
SLEEP TIMER		O F T M	0 _ _ _	OFF 1 _ _ _ OFF TIMER - 30 MIN. 2 _ _ _ OFF TIMER - 60 MIN. 3 _ _ _ OFF TIMER - 90 MIN. 4 _ _ _ OFF TIMER - 120 MIN.		
CHANNEL	DIRECT CHANNEL	D C C H	* * * _	The channel number of TV (1-125) An input change is included if it is not TV display. In Air, 2-69ch is effective. In Cable, 1-125ch is effective.		
	CH UP	C H U P	x _ _ _	The channel number of TV + 1 If it is not TV display, it will input-switch to TV.		
	CH DOWN	C H D W	x _ _ _	The channel number of TV - 1 If it is not TV display, it will input-switch to TV.		
ANT-A/B	A N T S	x _ _ _	(Toggle) Change toggle operation of tuner A/B.			
CC	C L C P	x _ _ _	(Toggle) Toggle operation of a closed caption.			

NOTE

- If an underbar (_) appears in the parameter column, enter a space.
- If an asterisk (*) appears, enter a value in the range indicated in brackets under CONTROL CONTENTS.
- As long as that from which the parameter (x) in the table is a numerical value, it may write anything.

Appendix

Specifications

Item			32" LIQUID CRYSTAL TELEVISION, Model: LC-32G4U (Display) TU-GA1U-S (AVC System)	37" LIQUID CRYSTAL TELEVISION, Model: LC-37G4U (Display) TU-GA1U-S (AVC System)	
LCD panel			32" Advanced Super View & BLACK TFT LCD	37" Advanced Super View & BLACK TFT LCD	
Number of dots			3,147,264 dots (1366 × 768 × 3dots)		
TV Function	TV-standard (CCIR)		American TV Standard NTSC System		
	Receiving Channel	VHF/UHF	VHF 2-13ch, UHF 14-69ch		
		CATV	1-125ch		
	Audio multiplex		BTSC System		
Brightness			450 cd/m ²		
Backlight			60,000 hours (at Backlight Standard position)		
Viewing angles			H : 170° V : 170°		
Audio amplifier			10W × 2		
Speakers			Ø 8cm 2pcs, Ø 2.5cm 2pcs		
Terminals	AVC System	Rear	INPUT 1	AV in, COMPONENT in	
			INPUT 2	AV in, COMPONENT in	
			INPUT 4	HDMI in	
			INPUT 5	Audio in, DVI-I in	
			ANTENNA	75 Ω Unbalance, F Type for VHF/UHF/CATV in × 2, out × 1	
			Monitor Out	S-VIDEO out, AV out	
			SPEAKER-B	4 Ω 10W (L/R)	
			CENTER CHANNEL INPUT	RCA pin	
	Front	INPUT 3	S-VIDEO in, AV in		
		Headphones	Ø 3.5mm jack		
OSD language			English/French/Spanish		
Power Requirement			AC 110-240 V, 50/60 Hz		
Power Consumption	AVC System		48W (0.4W Standby with AC 120 V)		
	Display		127W (0.2W Standby with AC 120 V)	168W (0.2W Standby with AC 120 V)	
Weight	AVC System		14.8 lbs./6.7 kg (w/o stand), 15.2 lbs./6.9 kg (with stand)		
	Display		28.7 lbs./13 kg (Display only), 38.6 lbs./17.5 kg (with Display and speaker), 48.5 lbs./22 kg (with Display, speaker and stand)	30.9 lbs./14 kg (Display only), 43 lbs./19.5 kg (with Display and speaker), 52.9 lbs./24 kg (with Display, speaker and stand)	
Accessories			Operation manual (× 1), Remote control unit (× 1), System cable (× 1), AC cord (× 2), "AAA" size battery (× 2), AVC system stand unit (× 1), Cable clamp (× 1), RF cable (× 1)	Operation manual (× 1), Remote control unit (× 1), System cable (× 1), AC cord (× 2), "AAA" size battery (× 2), AVC system stand unit (× 1), Cable clamp (× 1), RF cable (× 1), Bracket unit (× 1), Speaker unit (× 1)	

- As part of policy of continuous improvement, SHARP reserves the right to make design and specification changes for product improvement without prior notice. The performance specification figures indicated are nominal values of production units. There may be some deviations from these values in individual units.

Optional accessory

The listed optional accessory is available for the Liquid Crystal Television. Please purchase it at your nearest shop.

- Additional optional accessories may be available in the near future. When purchasing, please read the newest catalogue for compatibility and check the availability.

Part name	Part number
Wall mount bracket	AN-37AG2

Dimensional drawings

Display LC-37G4U

Unit: inch/(mm)

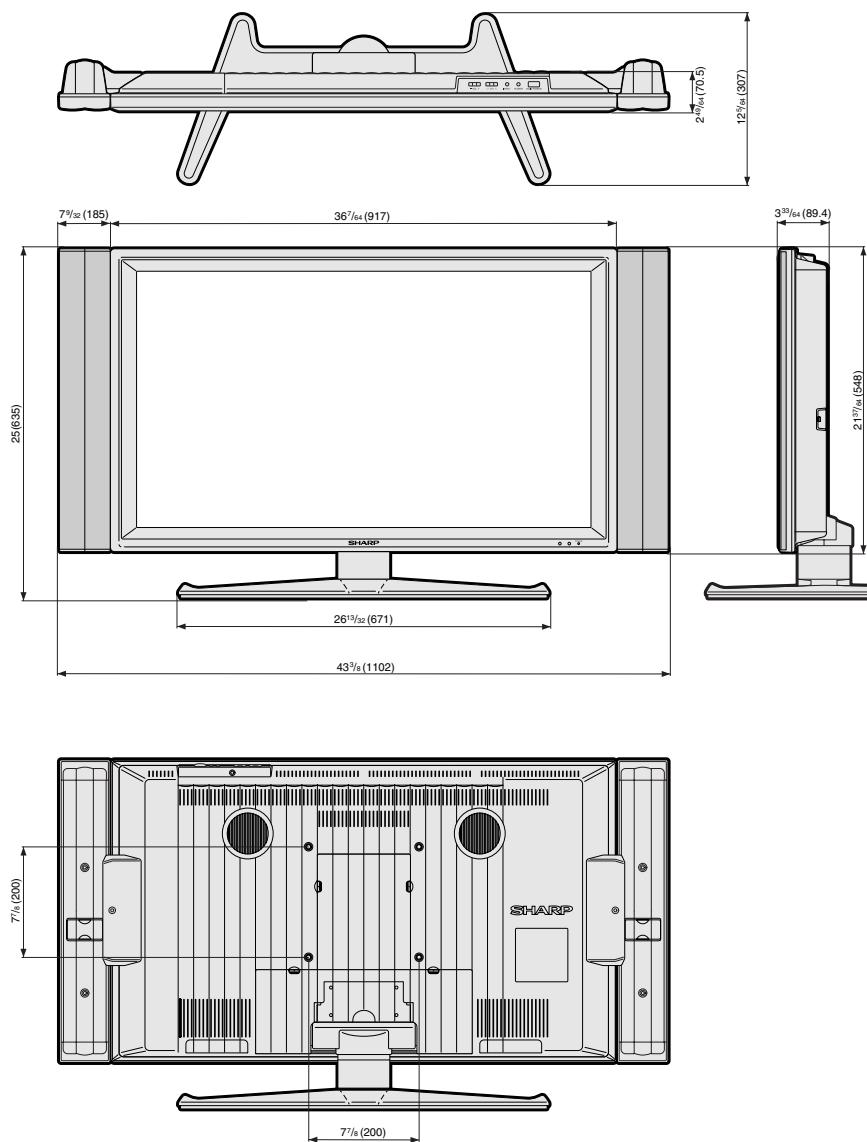

Dimensional drawings

Display LC-32G4U

Unit: inch/(mm)

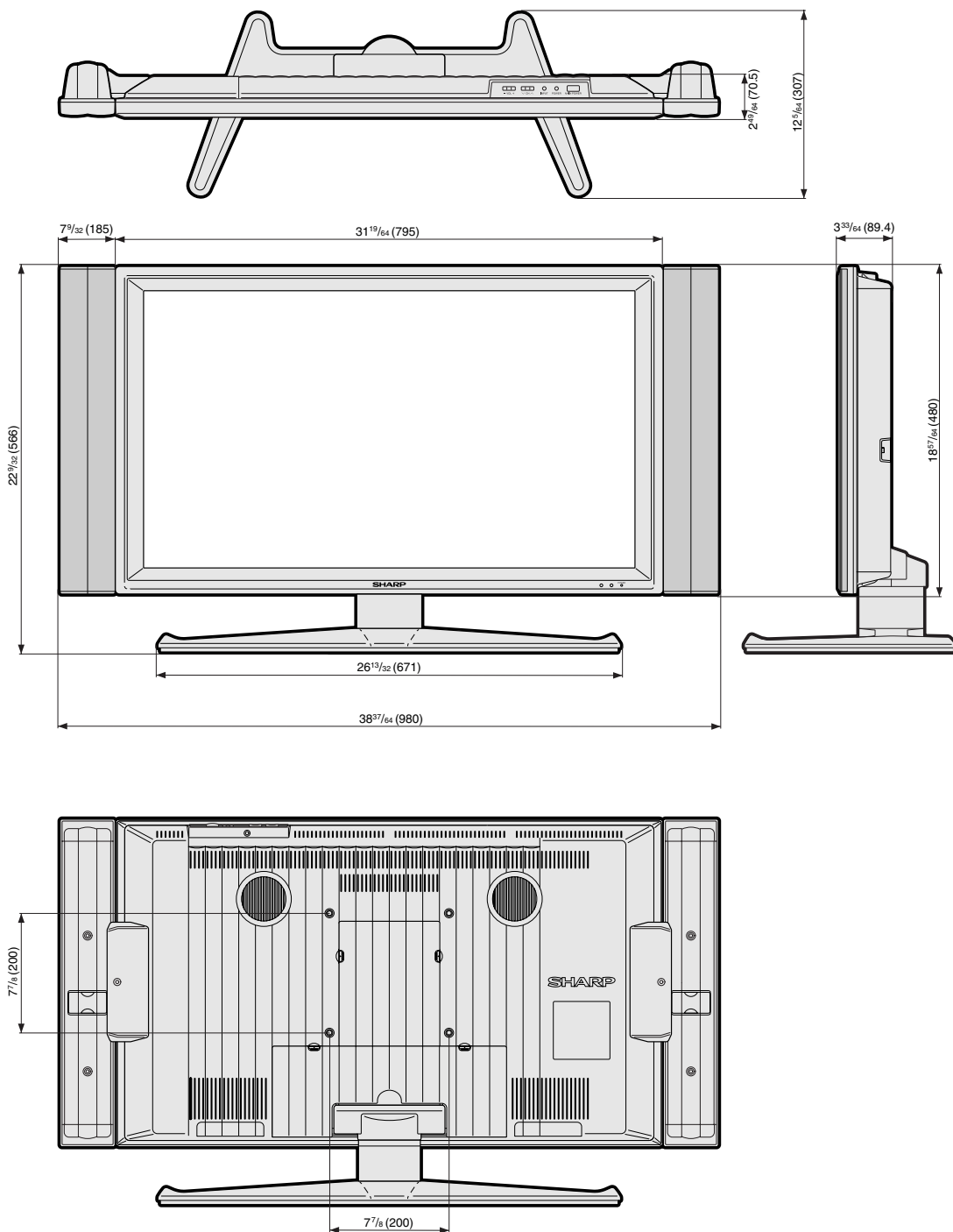

Dimensional drawings

AVC System

Unit: inch/(mm)

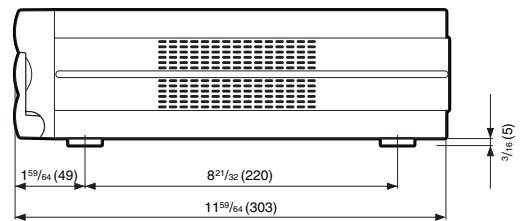
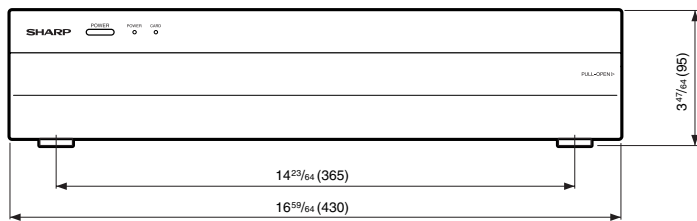
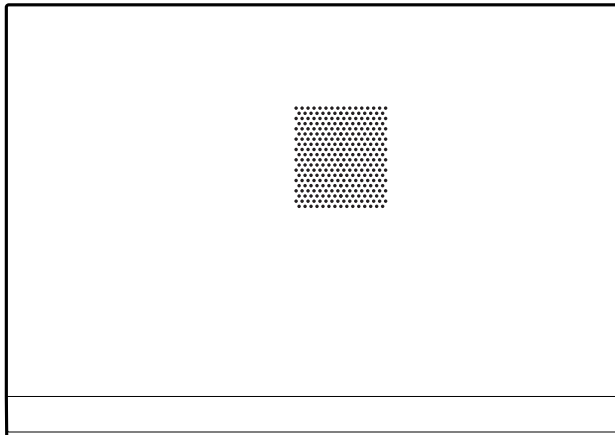

HOW TO SET THE FACTORY PRESETS

Press and hold down **RESET** on the AVC System while it is in standby mode. Then press **POWER** button on the Display or **TV POWER** on the remote control unit to turn the System on. All setting items (except TV channel) return to the factory presetting.

NOTE

- Running the factory presetting operation also clears the secret number.

You can run the EZ Setup again by using the following steps.

- 1** Turn on the power of the Display and the AVC System.
- 2** Press **MENU**. (Make sure the menu screen displays.)
- 3** Press **◀/▶** to select "Setup".
- 4** Press **▲/▼** to select "EZ Setup".
- 5** Press **ENTER**.

NOTE

- If the secret number setting screen displays, you need to enter your secret number.
- If you forget your secret number, refer to HOW TO SET THE FACTORY PRESETS above.

The secret number is

				.
--	--	--	--	---

NOTE

- As a precautionary measure, make a note of your secret number above, scissor it from this manual, and keep it in a familiar place.



Calling for Service

For location of the nearest Sharp Authorized Service, or to obtain product literature, accessories, supplies, or customer assistance, please call 1-800-BE-SHARP.

LIMITED WARRANTY

CONSUMER LIMITED WARRANTY

SHARP ELECTRONICS CORPORATION warrants to the first consumer purchaser that this Sharp brand product (the "Product"), when shipped in its original container, will be free from defective workmanship and materials, and agrees that it will, at its option, either repair the defect or replace the defective Product or part thereof with a new or remanufactured equivalent at no charge to the purchaser for parts or labor for the period(s) set forth below.

This warranty does not apply to any appearance items of the Product nor to the additional excluded item(s) set forth below nor to any Product the exterior of which has been damaged or defaced, which has been subjected to improper voltage or other misuse, abnormal service or handling, or which has been altered or modified in design or construction.

In order to enforce the rights under this limited warranty, the purchaser should follow the steps set forth below and provide proof of purchase to the servicer.

The limited warranty described herein is in addition to whatever implied warranties may be granted to purchasers by law. ALL IMPLIED WARRANTIES INCLUDING THE WARRANTIES OF MERCHANTABILITY AND FITNESS FOR USE ARE LIMITED TO THE PERIOD(S) FROM THE DATE OF PURCHASE SET FORTH BELOW. Some states do not allow limitations on how long an implied warranty lasts, so the above limitation may not apply to you.

Neither the sales personnel of the seller nor any other person is authorized to make any warranties other than those described herein, or to extend the duration of any warranties beyond the time period described herein on behalf of Sharp.

The warranties described herein shall be the sole and exclusive warranties granted by Sharp and shall be the sole and exclusive remedy available to the purchaser. Correction of defects, in the manner and for the period of time described herein, shall constitute complete fulfillment of all liabilities and responsibilities of Sharp to the purchaser with respect to the Product, and shall constitute full satisfaction of all claims, whether based on contract, negligence, strict liability or otherwise. In no event shall Sharp be liable, or in any way responsible, for any damages or defects in the Product which were caused by repairs or attempted repairs performed by anyone other than an authorized servicer. Nor shall Sharp be liable or in any way responsible for any incidental or consequential economic or property damage. Some states do not allow the exclusion of incidental or consequential damages, so the above exclusion may not apply to you.

THIS WARRANTY GIVES YOU SPECIFIC LEGAL RIGHTS. YOU MAY ALSO HAVE OTHER RIGHTS WHICH VARY FROM STATE TO STATE.

Model Specific Section

Your Product Model Number & Description:

LC-37G4U LCD Color Television
LC-32G4U LCD Color Television
TU-GA1U-S LCD Color Television
(Be sure to have this information available when you need service for your Product.)

Warranty Period for this Product:

One (1) year parts and labor from the date of purchase.

Additional Item(s) Excluded from Warranty Coverage (if any):

Non-rechargeable batteries.

Where to Obtain Service:

From a Sharp Authorized Servicer located in the United States. To find the location of the nearest Sharp Authorized Servicer, call Sharp toll free at 1-800-BE-SHARP.

What to do to Obtain Service:

Contact your Sharp Authorized Servicer to obtain in-home service for this Product. The Servicer will come to your home and if it is necessary to remove the Product, the Servicer will reinstall it. Be sure to have **Proof of Purchase** available.

TO OBTAIN PRODUCT INFORMATION, CALL 1-888-LCD-SHARP OR VISIT www.sharppusa.com

SHARP®

SHARP ELECTRONICS CORPORATION

Sharp Plaza, Mahwah, New Jersey 07430-2135

SHARP CORPORATION

SHARP®

LIMITED WARRANTY

Consumer Electronics Products

Congratulations on your purchase!

Sharp Electronics of Canada Ltd. (hereinafter called "Sharp") gives the following express warranty to the first consumer purchaser for this Sharp brand product, when shipped in its original container and sold or distributed in Canada by Sharp or by an Authorized Sharp Dealer:

Sharp warrants that this product is free, under normal use and maintenance, from any defects in material and workmanship. If any such defects should be found in this product within the applicable warranty period, Sharp shall, at its option, repair or replace the product as specified herein.

This warranty shall not apply to:

- (a) Any defects caused or repairs required as a result of abusive operation, negligence, accident, improper installation or inappropriate use as outlined in the owner's manual.
- (b) Any Sharp product tampered with, modified, adjusted or repaired by any party other than Sharp, Sharp's Authorized Service Centres or Sharp's Authorized Servicing Dealers.
- (c) Damage caused or repairs required as a result of the use with items not specified or approved by Sharp, including but not limited to head cleaning tapes and chemical cleaning agents.
- (d) Any replacement of accessories, glassware, consumable or peripheral items required through normal use of the product including but not limited to earphones, remote controls, AC adapters, batteries, temperature probe, stylus, trays, filters, belts, ribbons, cables and paper.
- (e) Any cosmetic damage to the surface or exterior that has been defaced or caused by normal wear and tear.
- (f) Any damage caused by external or environmental conditions, including but not limited to transmission line/power line voltage or liquid spillage.
- (g) Any product received without appropriate model, serial number and CSA/cUL markings.
- (h) Any products used for rental or commercial purposes.
- (i) Any installation, setup and/or programming charges.

Should this Sharp product fail to operate during the warranty period, warranty service may be obtained upon delivery of the Sharp product together with proof of purchase and a copy of this LIMITED WARRANTY statement to an Authorized Sharp Service Centre or an Authorized Sharp Servicing Dealer. In home warranty service may be provided at Sharp's discretion on any Sharp television with the screen size of 27" or larger and on any Sharp Over-the-Range Microwave Oven.

This warranty constitutes the entire express warranty granted by Sharp and no other dealer, service centre or their agent or employee is authorized to extend, enlarge or transfer this warranty on behalf of Sharp. To the extent the law permits, Sharp disclaims any and all liability for direct or indirect damages or losses or for any incidental, special or consequential damages or loss of profits resulting from a defect in material or workmanship relating to the product, including damages for the loss of time or use of this Sharp product or the loss of information. The purchaser will be responsible for any removal, reinstallation, transportation and insurance costs incurred. Correction of defects, in the manner and period of time described herein, constitute complete fulfillment of all obligations and responsibilities of Sharp to the purchaser with respect to the product and shall constitute full satisfaction of all claims, whether based on contract, negligence, strict liability or otherwise.

WARRANTY PERIODS:

	Parts & Labour (exceptions noted)
Audio Products	1 year
Camcorder	1 year
DVD Products	1 year
Projector	1 year (lamp 90 days)
LCD & Plasma Display TV	1 year
Microwave Oven	1 year (magnetron component-4 additional years)
Television Products	1 year (picture tube component-1 additional year)
VCR Products	1 year
Vacuum Cleaner	1 year

To obtain the name and address of the nearest Authorized Sharp Service Centre or Dealer, please contact:
SHARP ELECTRONICS OF CANADA LTD. 335 Britannia Road East, Mississauga, Ontario L4Z 1W9

For more information on this Warranty, Sharp Extended Warranty Offers, Sharp Canada Products, Accessory Sales, Dealer or Service Locations, please call (905) 568-7140
Visit our Web site: www.sharp.ca

