

**Simplicity**<sup>®</sup>  
Sewing Machines

**Fashion**  
 **PRO**

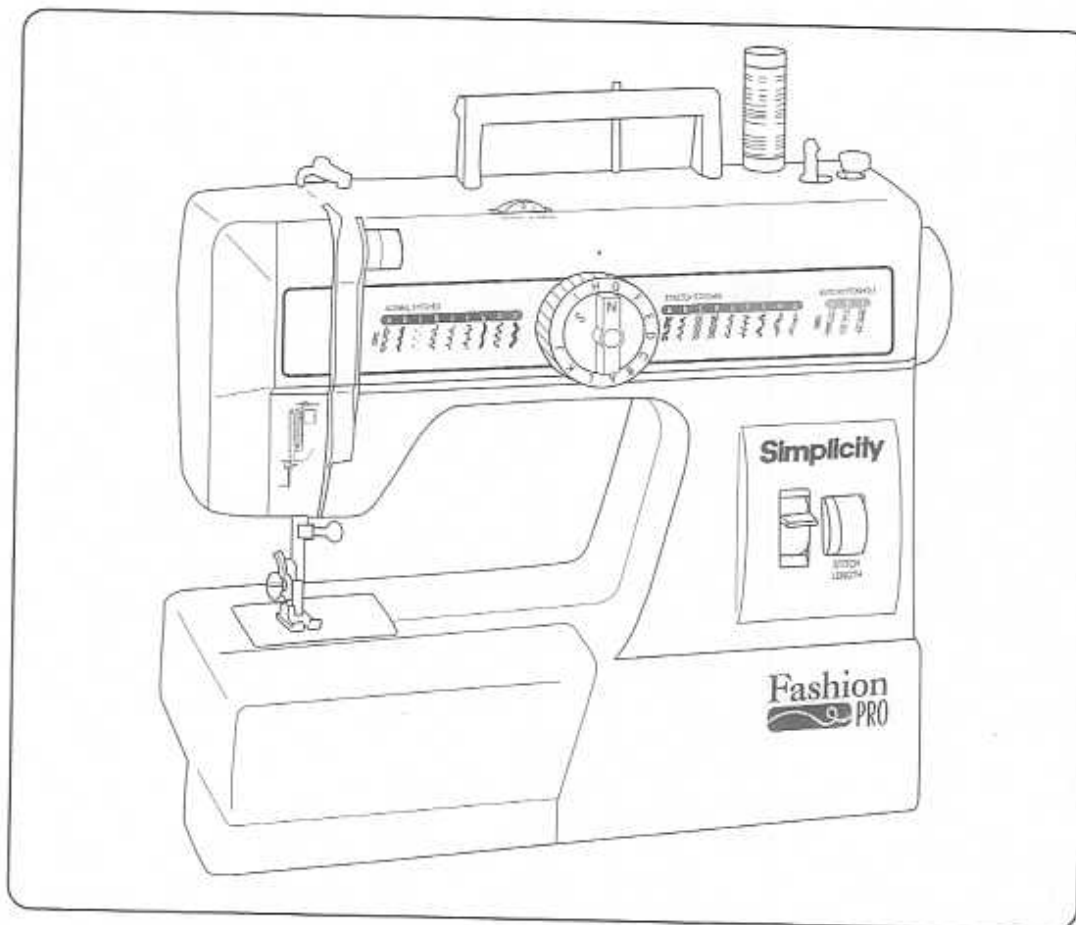

**Sewing Machine Model SW2145**

# **INSTRUCTION MANUAL**

**Manual de Instrucciones**

**Simplicity Sewing Machine Education Helpline: 800-822-6691**

# CONTENTS

Names of Parts .....	1 & 2
Accessories.....	3
Before sewing (Power supply and Sewing Lamp) .....	4
Removing extension table, free arm sewing .....	5
Winding the bobbin .....	6
Removing bobbin case and bobbin.....	7
Inserting bobbin into bobbin case .....	7
Inserting bobbin case into shuttle race .....	8
Threading upper thread .....	9
Drawing up bobbin thread.....	10
Changing sewing directions .....	10
Leveling machine & Adjusting thread tension .....	11 & 12
Regulating the presser foot pressure .....	13
Drop feed .....	13
Changing needle .....	14
Fabric. Thread. Needle table .....	15
Sewing (pattern selector) and operation table .....	16
To start sewing .....	17
To finish seam .....	18
Straight stitch .....	19
Zigzag sewing .....	19
Stretch stitch adjustment.....	19
Overcasting .....	20
Straight and zigzag stretch stitch .....	20
Blind stitch.....	21 & 22
Button sewing .....	23
Binding .....	23
Zipper sewing.....	24
Buttonhole sewing.....	25
Hemming.....	26
Twin needle.....	27
Embroidery.....	27
Quilter .....	28
Seam guide.....	28
Maintenance(Cleaning and oiling) .....	29
Trouble shooting .....	30

# IMPORTANT SAFETY INSTRUCTIONS

When using an electrical appliance, basic safety precautions should always be followed including the following:

**Read all instructions before using this sewing machine.**

## **DANGER** To reduce the risk of electric shock:

An appliance should never be left unattended when plugged in. Always unplug this appliance from the electric outlet immediately after using and before cleaning.

Always unplug before relamping, Replace bulb with same type rated 15 watts.

This appliance has a polarized plug (one blade wider than the other). To reduce the risk of electric shock, this plug is intended to fit in a polarized outlet only one way. If the plug does not fit fully in the outlet, reverse the plug. If it still does not fit, contact a qualified electrician to install the proper outlet. Do not modify the plug in any way.

## **WARNING** To reduce the risk of burns, fire, electric shock, or injury to persons:

1. Do not allow to be used as a toy. Close attention is necessary when this appliance is used by or near children.
2. Use this appliance only for its intended use as described in this manual. Use only attachments recommended by the manufacturer as contained in this manual.
3. Never operate this appliance if it has a damaged cord or plug, if it is not working properly, if it has been dropped or damaged, or dropped into water, Return the appliance to the nearest authorized dealer or service center for examination, repair, electrical or mechanical adjustment.
4. Never operate the appliance with any air openings blocked, Keep ventilation openings of the sewing machine and foot controller free from the accumulation of lint, dust and loose cloth.
5. Never drop or insert any object into any opening.
6. Do not use outdoors.
7. Do not operate where aerosol(spray) products are being used or where oxygen is being administered.
8. To disconnect, turn all controls to the off("0") position, then remove plug from outlet.
9. Do not unplug by pulling on cord. To unplug, grasp the plug, not the cord.
10. Keep fingers away from all moving parts. Special care is required around the sewing machine needle.
11. Always use the proper needle plate. The wrong plate can cause the needle to break.
12. Do not use bent needles.
13. Do not pull or push fabric while stitching. It may deflect the needle causing it to break.
14. Unplug the sewing machine when making any adjustments in the needle area, such as threading needle, changing needle, threading bobbin, or changing presser foot, etc.
15. Always unplug sewing machine from the electrical outlet when removing covers, lubricating, or when making any other user servicing adjustments mentioned in the instruction manual.

**SAVE THESE INSTRUCTIONS**

# NAME OF PARTS (FRONT VIEW)

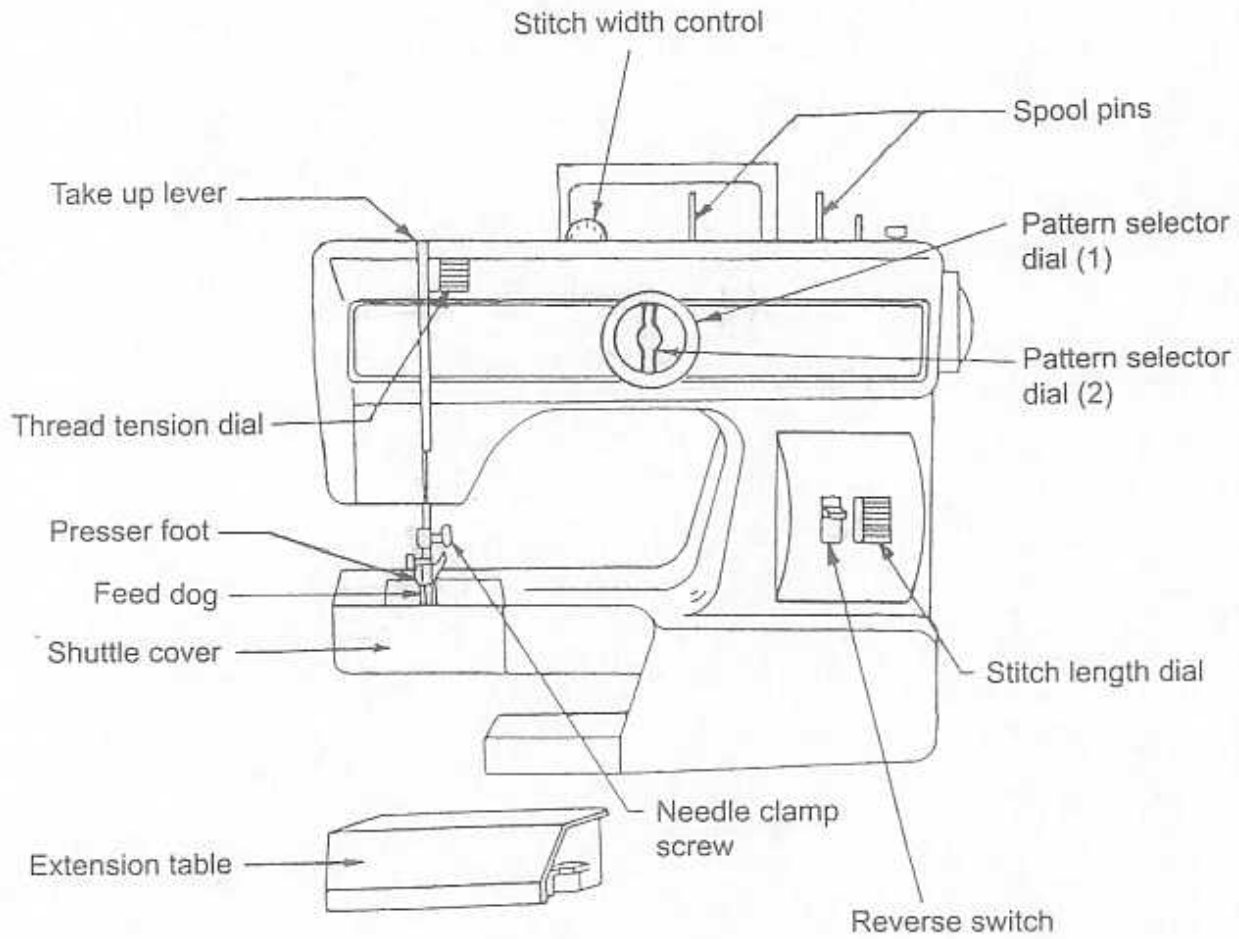

## (REAR VIEW)

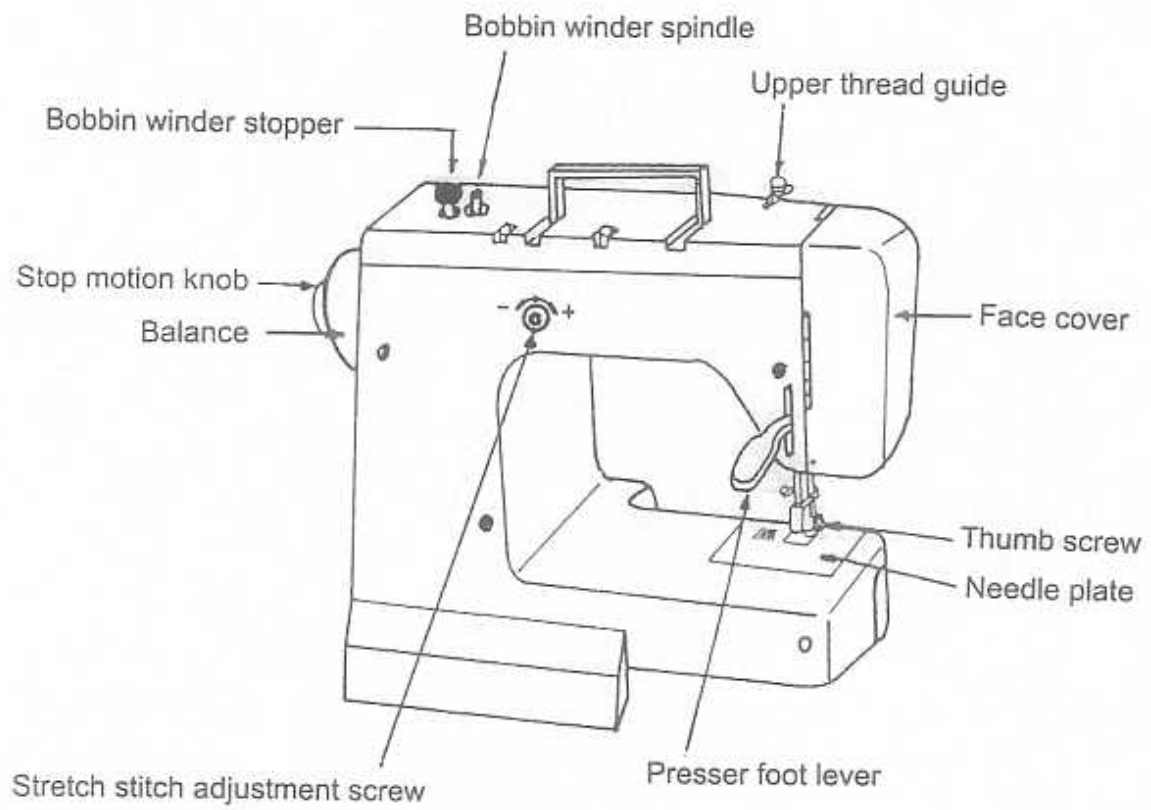

## ACCESSORIES



Bobbins



Felt cushions



Zigzag foot (On machine)

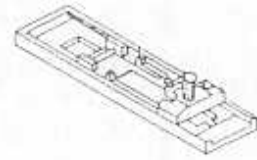

Buttonhole presser foot

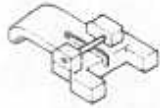

Button attaching  
presser foot



Hemmer foot



Open toe satin stitch foot



Cording foot



Blind hem foot



Embroidery foot



Zipper presser foot



Overcasting foot



Screwdriver



Seam ripper



Spool pin



Needles

## BEFORE SEWING

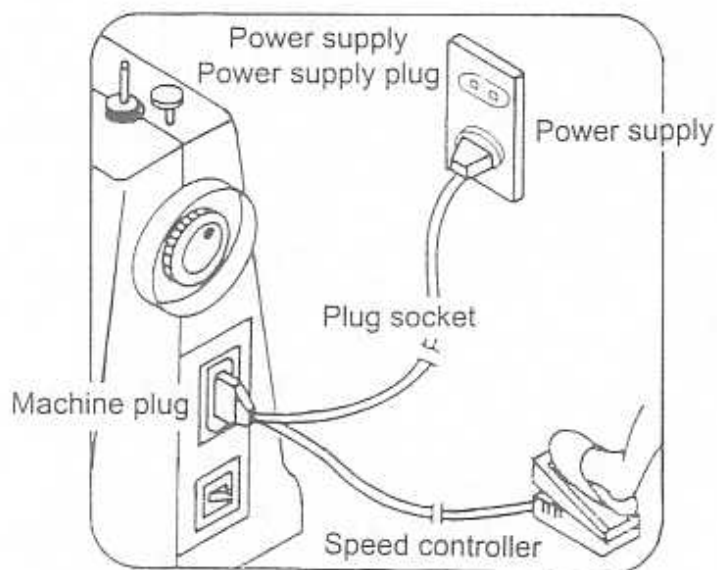

1. Fit plug into the machine.
2. Plug the machine to the power supply.
3. Sewing speed can be varied by the foot control.

Use only VGK model EZ-168A foot controller with sewing machine model SW2145.

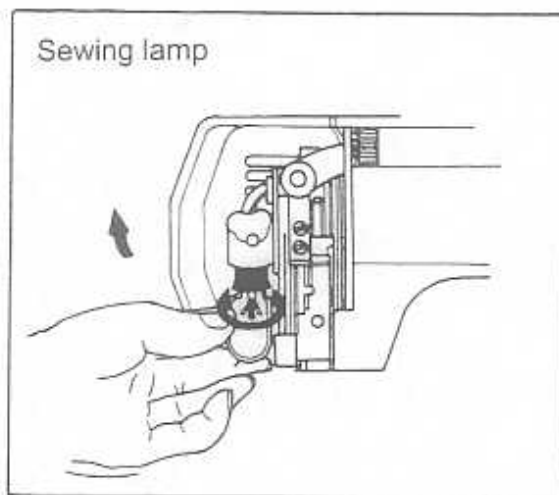

### REMOVE OR INSTALL BULB

1. Open face cover in direction of arrow.
2. Remove bulb by unscrewing, it clockwise.
3. Install a new bulb by screwing it in counter-clockwise.
4. Use a screw type bulb with 120V/15W(Max).

**IMPORTANT:** When leaving the sewing machine unattended, the plug must be removed from the socket outlet.

When servicing the sewing machine, or when removing covers or changing lamps, the machine must be disconnected from the supply by removing the plug from the socket outlet.

## REMOVING EXTENSION TABLE

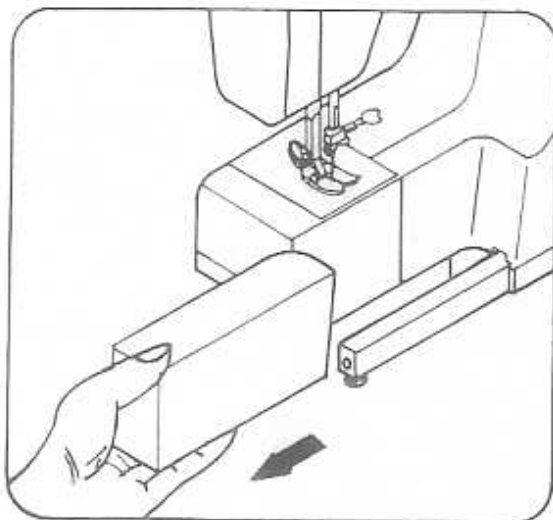

1. Hold the left end of table and pull out in direction of arrow.

## FREE-ARM SEWING

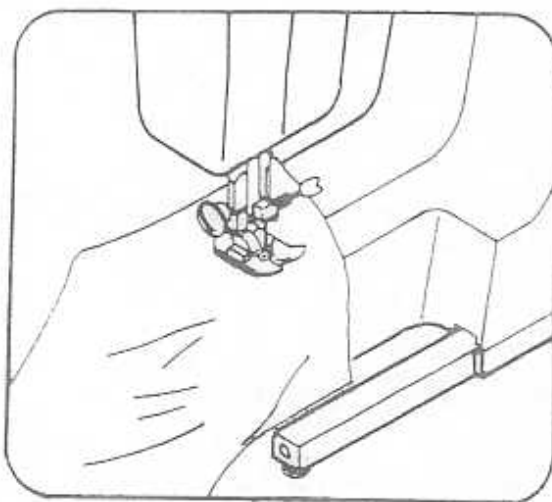

1. This sewing machine can be used as a flat bed machine but easily converts to free arm machine by removing the extension table.
2. Especially useful for sewing sleeves, pant legs, tubular fabrics etc., more easily.
3. To sew tubular just slip the sleeve or leg of pants on to the free arm as shown at side.



## WINDING THE BOBBIN

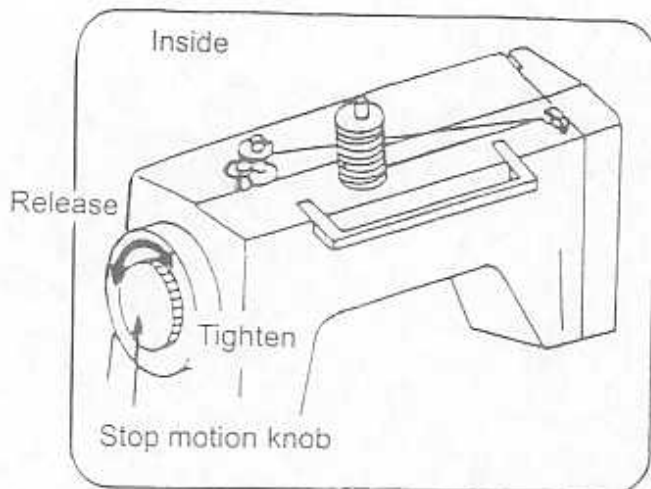

1. Release stop motion knob.
2. Thread as shown.
3. When bobbin is filled, tighten stop motion knob.

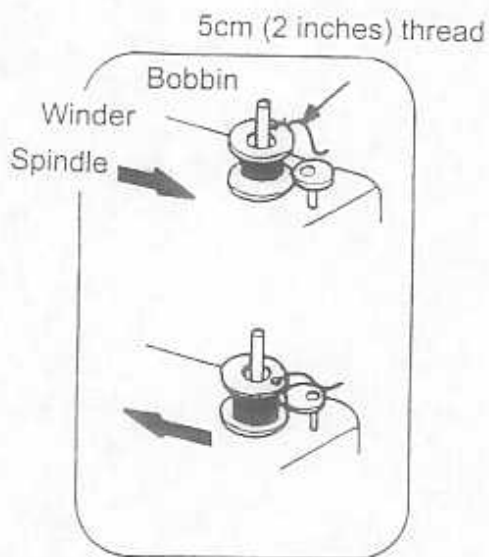

Push bobbin winder spindle in direction of arrow.

When bobbin winding is completed return spindle to original position.

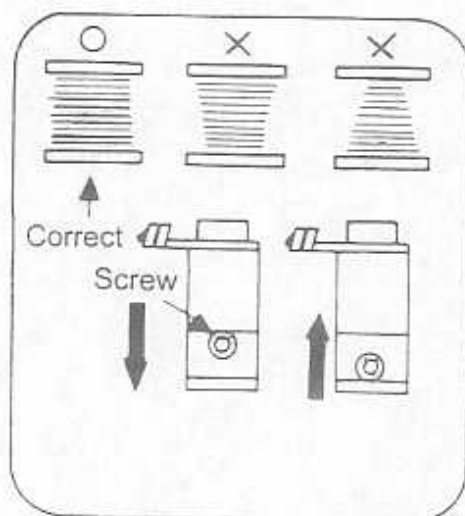

When bobbin winding is incorrect, release the screw of upper thread guide and adjust up or down until bobbin winding is balanced.

## REMOVING BOBBIN CASE AND BOBBIN

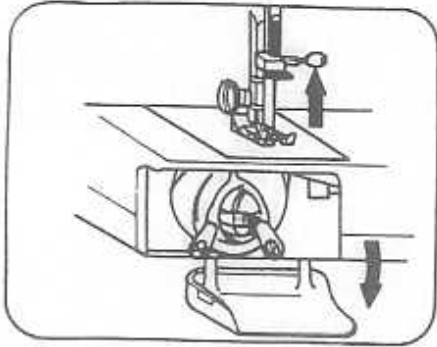

1. Raise needle to its highest position and open the shuttle race cover.



2. Open hinged latch of bobbin case and pull bobbin case out of machine.

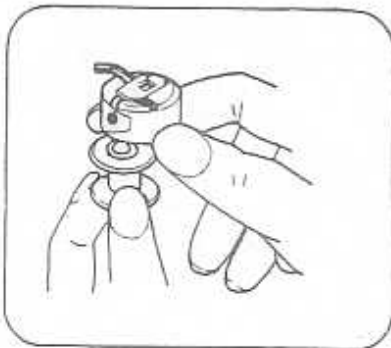

3. Release the latch and bobbin will fall out easily.

## INSERTING BOBBIN INTO BOBBIN CASE

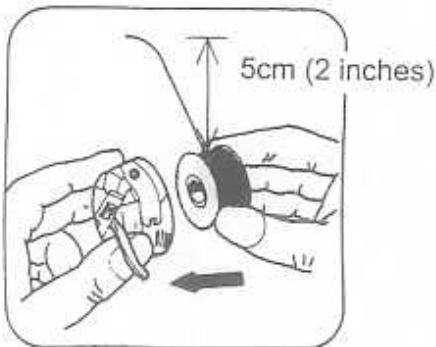

1. Pull off 5cm (2 inches) of thread from bobbin and insert it into bobbin case as shown.

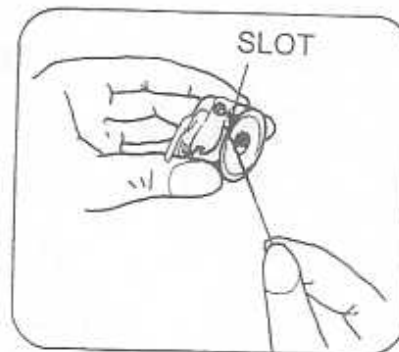

2. Guide the end of thread into slot.

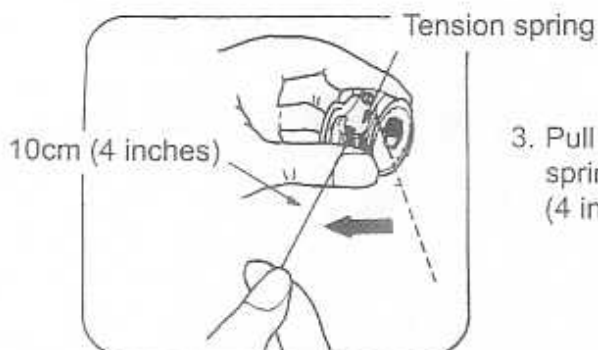

3. Pull into slot and under tension spring and draw out about 10cm (4 inches) of thread.

## INSERTING BOBBIN CASE INTO SHUTTLE RACE

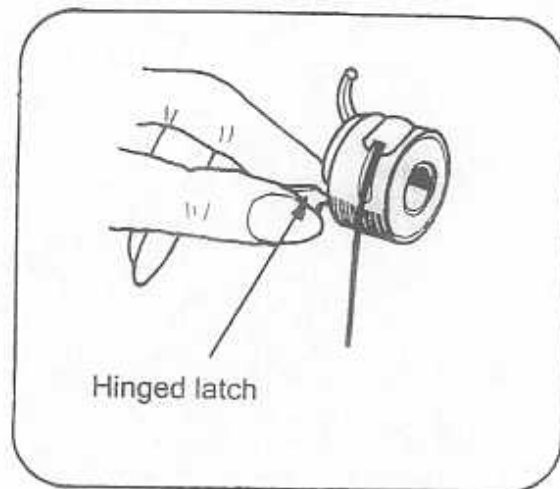

1. Raise needle to its highest position, pulling thread to the front, open the latch of bobbin case and hold it.

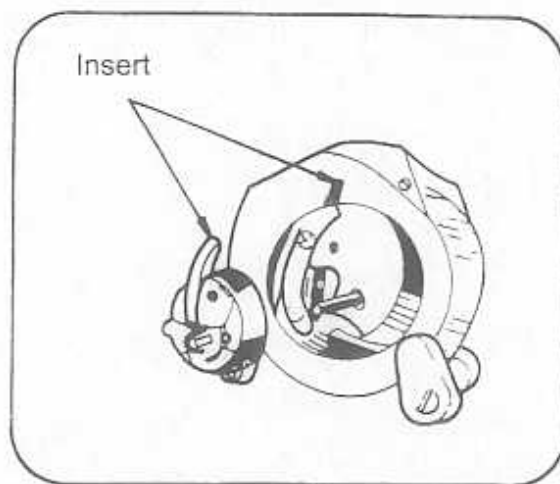

2. Holding latch open, place bobbin case onto centre pin in shuttle and release latch.

# THREADING UPPER THREAD

Pass the thread from A to F as shown.

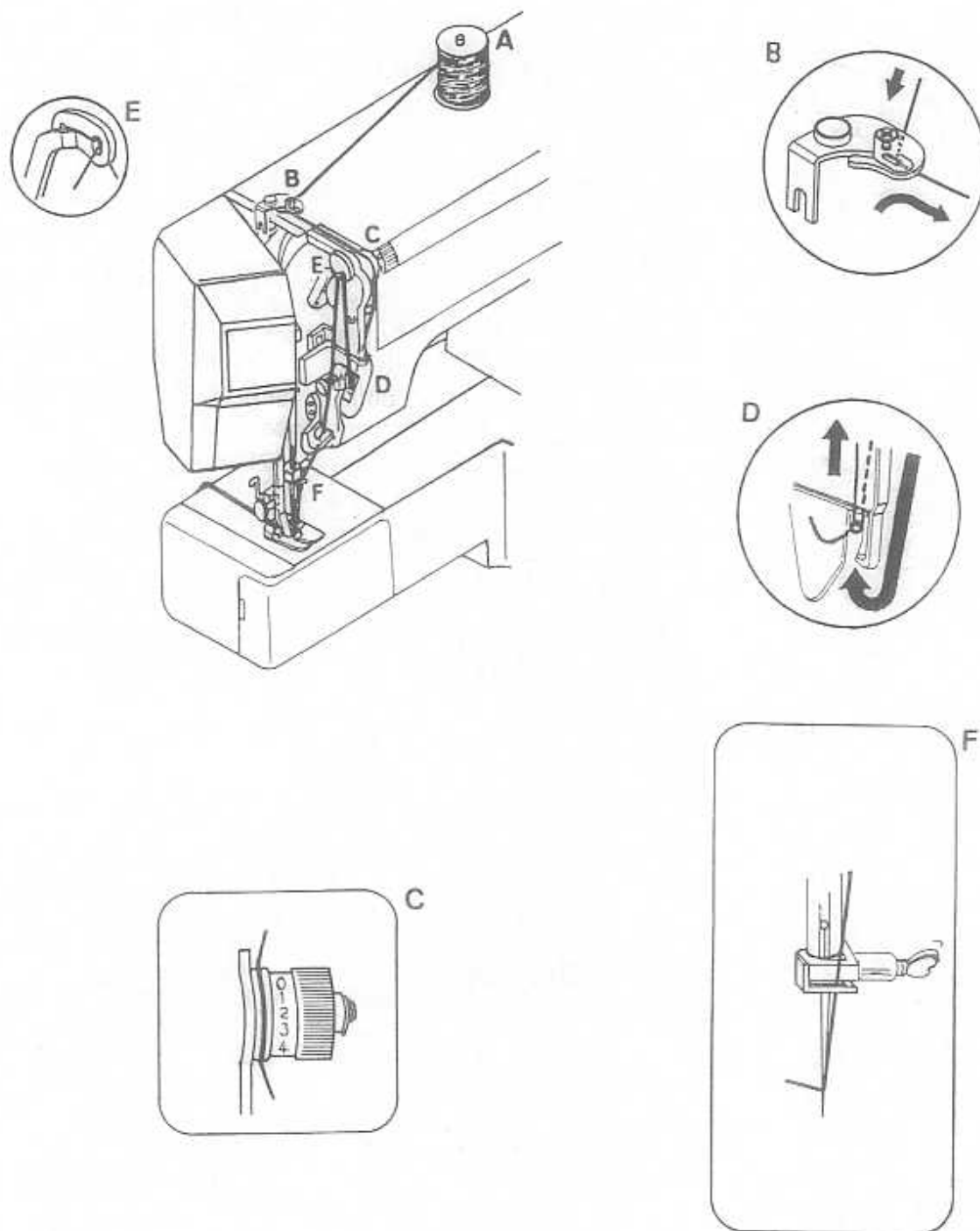

## DRAWING UP BOBBIN THREAD

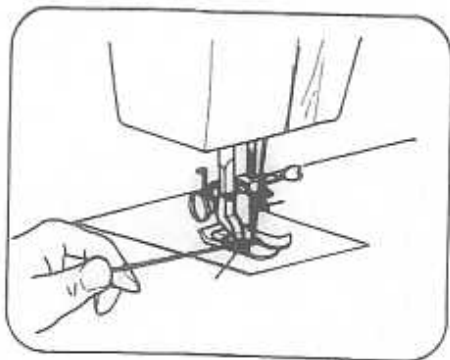

1. Hold upper thread with left hand, turn the hand wheel slowly towards you until the needle goes down and comes up. Then stop the hand wheel when the take up lever is at its highest position. Lightly draw up the upper thread and the lower thread will be brought up in a loop.

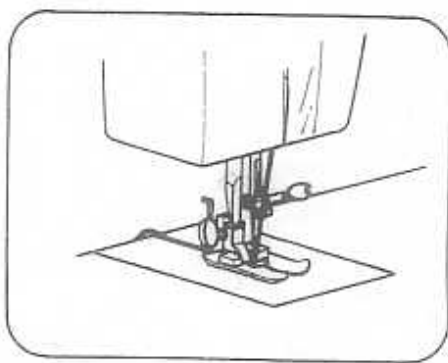

2. Pull out both threads and place them together under presser foot to the rear of machine.
3. Place fabric under presser foot from the front, lower presser foot.
4. Start to sew.(see page 17)

## CHANGING SEWING DIRECTIONS

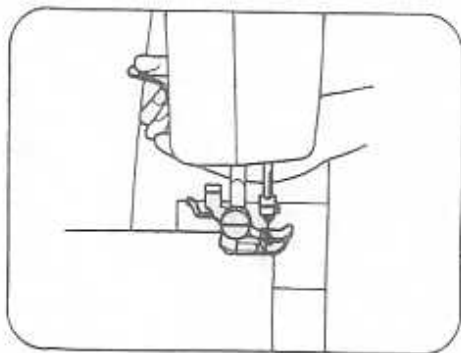

1. Lower needle down into fabric and raise presser foot, pivot the fabric around the needle to change direction as desired.

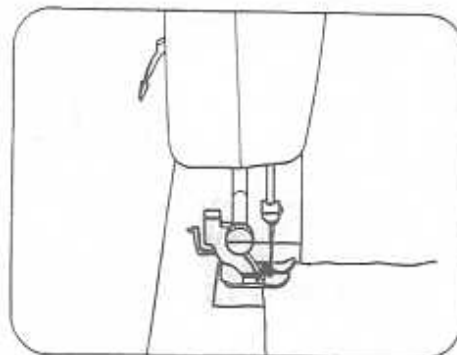

2. Lower presser foot and start to sew.

# LEVELING MACHINE

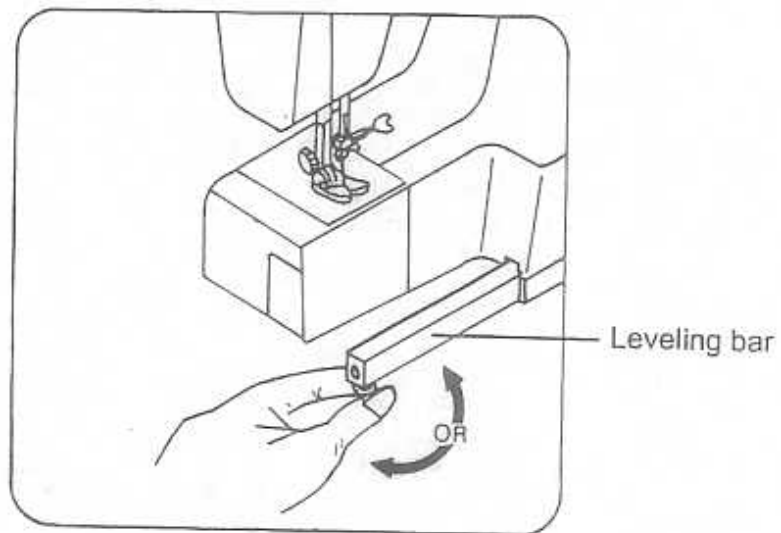

To level the machine turn the screw under the bar as indicated.

# ADJUSTING THREAD TENSION

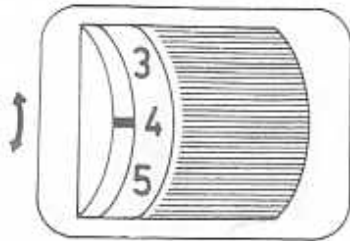

## UPPER THREAD TENSION

Upper thread tension may be adjusted by turning the thread tension dial. Higher number on tension dial is tighter tension. Lower number on tension dial is looser tension.

### TOO LOOSE

When the needle thread is too loose, the needle thread loops on the underside of the fabric. Tighten the needle thread tension by moving the dial to a higher number.

### TOO TIGHT

When the needle thread is too tight, the bobbin thread loops on the upper surface of the fabric. Loosen the needle thread tension by moving the dial to a lower number.

Correct

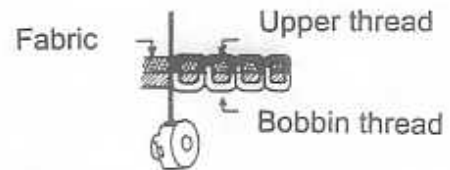

Incorrect

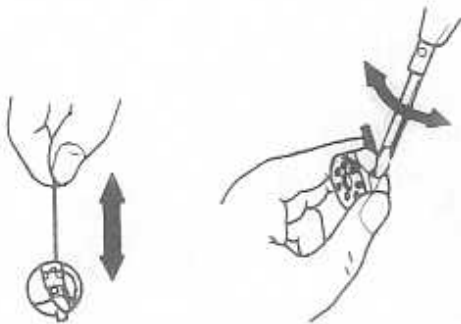

## LOWER THREAD TENSION

Lower thread tension can be adjusted by turning screw on bobbin case slightly to the right (clock-wise) to increase tension. Turn the screw (counter-clockwise) to the left to decrease tension.

## REGULATING THE PRESSER FOOT PRESSURE

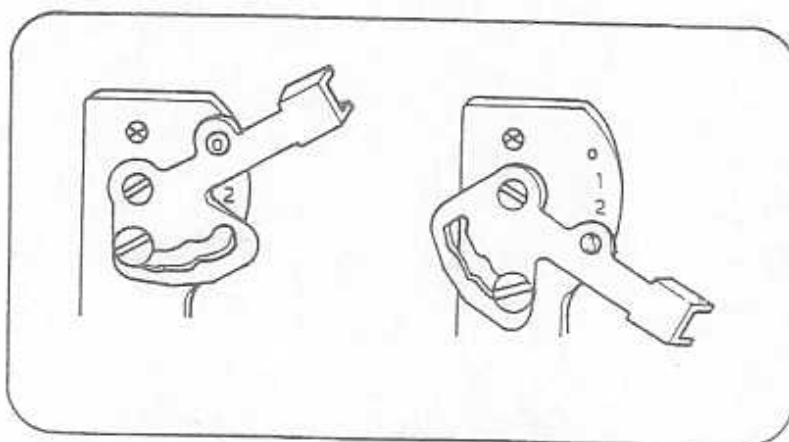

Open the face cover to readjust the presser foot pressure regulator.

1. Move the lever up or down for the desired pressure. For heavy fabrics set lever at 1, set at 2 for medium fabrics and 3 for light fabrics.
2. Insufficient pressure may cause poor feeding, skipped stitches. Or difficulty in guiding the fabric.
3. When darning or sewing freehand embroidery release the pressure by setting the lever on 0.

## DROP FEED

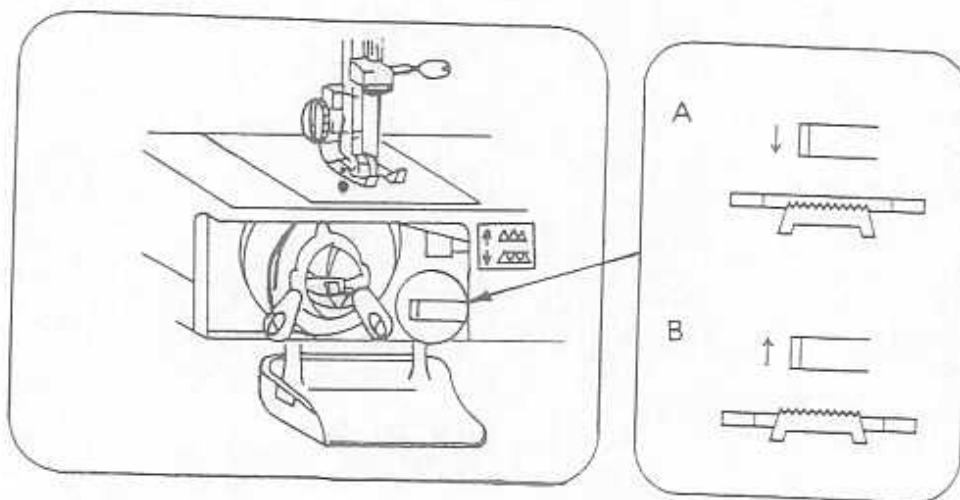

Raise presser foot with presser foot lever.

- A. Push feed lever down to drop feed dog below needle plate for darning embroidery and button attaching.
- B. Push lever up to raise feed dog above needle plate for normal sewing.





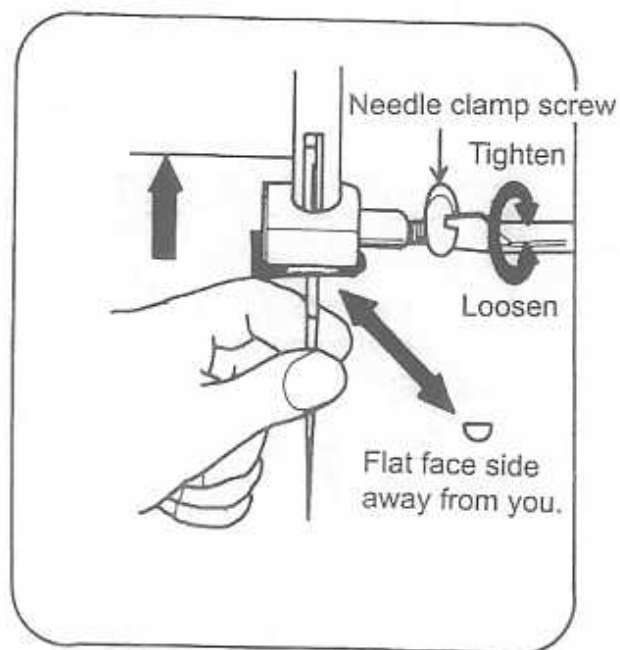











## CHANGING NEEDLE





































1. Raise needle bar to its highest position.
2. Loosen needle clamp screw and remove old needle.
3. With the flat side of the needle facing away from you, insert needle as far up as it will go.
4. Tighten the needle clamp screw securely.

# FABRIC. THREAD. NEEDLE TABLE

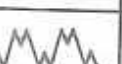
Please note that the following list is a guide when sewing different fabrics.

				Pressure of Presser foot	Length of stitches		Indication of tension
	Fabric	Thread	Needle		ST.	ZZ.	
				Pressure regulation 	Stitch length dial 		
Light 	Nylon	80 Cotton	9		1-3	1-4	
	Tricot	60 S Fiber					
	Silk	50 silk					
	Wool silk	50 S Fiber Silk	11				
Medium 	Gingham	60-80 Cotton	11-14		0.5-3	0.5-4	
	Thin Jersey	60 S Fiber	11				
	Gabardine	50 Silk					
Heavy 	Denim	50 cotton	14-16		0.5-3	0.5-4	
	Jersey	50 S Fiber	11-14				
	Tweed	50 Silk	11-14				

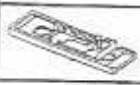
# SEWING (PATTERN SELECTOR) AND OPERATION TABLE

Stitch pattern		Stitch no.		Stitch length	Stitch width	Sewing foot	
		(1)	(2)				
	Stretch straight stitch/ ric-rac stitch	A	S	• 	0-5		
	Pullover stitch	B			5		
	Honeycomb stitch	C					
	Double overlock stitch	D					
	Single overlock stitch	E					
	Feather stitch	F					
	Elastic embroidery stitch	G					
	Elastic embroidery stitch	H					
	Elastic embroidery stitch	I					
	Straight stitch/ zig-zag stitch	A	N	• 	0-5		
	Elastic blindstitch	B			• 	3-5	
	Jersey stitch	C				• 	5
	Box stitch	D			• 		5
	Blind stitch	E				3-5	
	Embroidery stitches	F			• 	5	
		G					
		H					
		I					
	Buttonhole	J-K-L			• 	5	
zig-zag 0-5	Free-hand embroidery		• 	5			

## TO START SEWING

### Important Hints

1. Raise the take-up lever to its highest position before starting and after stopping sewing.
2. Hold both threads about 10 cms (4 inches) to the rear of machine for the first two or three stitches.
3. Sufficient fabric should be placed under needle before lowering presser foot.
4. Depress foot control and start to sew.
5. Test the machine stitches on a scrap of fabric you plan to use, adjusting the machine for the length of stitch and tension suitable to your fabric.

### Attention

1. When turning the balance wheel manually, always turn it toward you.
2. Guide the cloth gently with your hand.
3. To prevent breaking needle always raise the needle out of the fabric when you stop sewing.

## TO FINISH SEAM

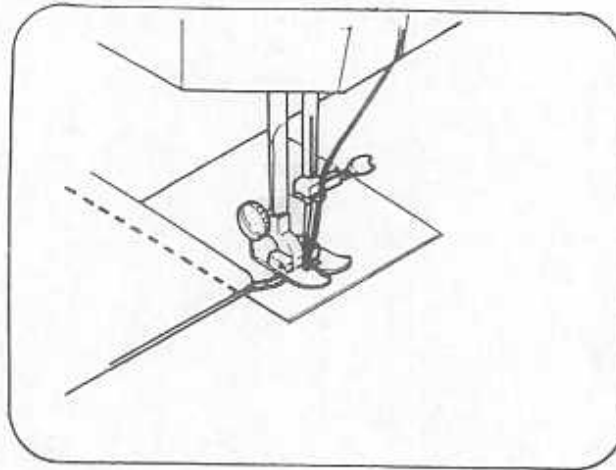

1. Sew to the edge of seam.
2. Push the reverse button and sew in reverse for about 3-4 stitches.
3. Raise needle to its highest position.
4. Lift presser foot and pull out the fabric to rear of machine.

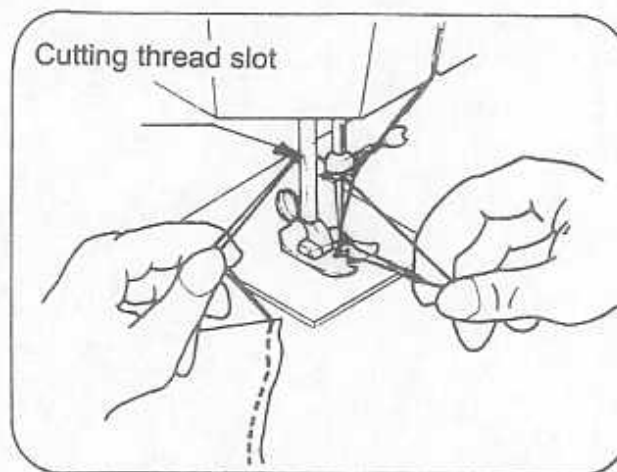

5. Cut threads as shown on the thread cutter.

## STRAIGHT STITCH

This type of stitching is used most frequently for garment constructing.

1. Attach the zig-zag presser foot for both straight and zig-zag sewing.
2. Set pattern selector dial (1) to "A" with "N" on pattern selector dial (2).
3. Set the stitch width control at "0"
4. Set the stitch length dial between 2 and 4, For sewing light fabric; use smaller stitch length.

## ZIGZAG SEWING

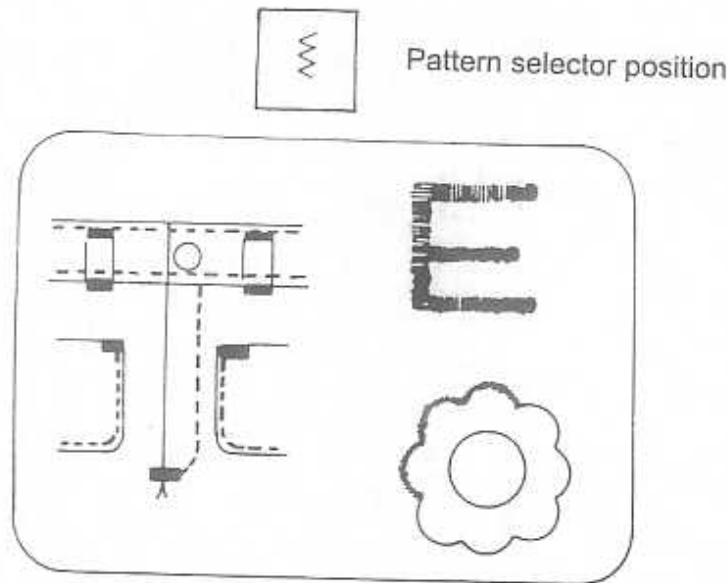

Satin stitching can be used for sewing initials, patterns, applique, etc.

## STRETCH STITCH ADJUSTMENT

When stretch stitches are not sewing correctly, the adjustment can be made by turning the stretch stitch adjustment screw on the back of the machine.

Incorrect stitch shown → Direction of screwdriver → Correct stitch shown

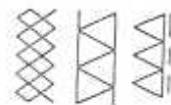
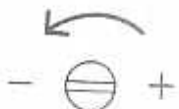
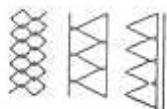
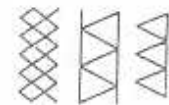
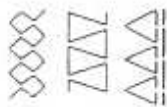

## OVERCASTING

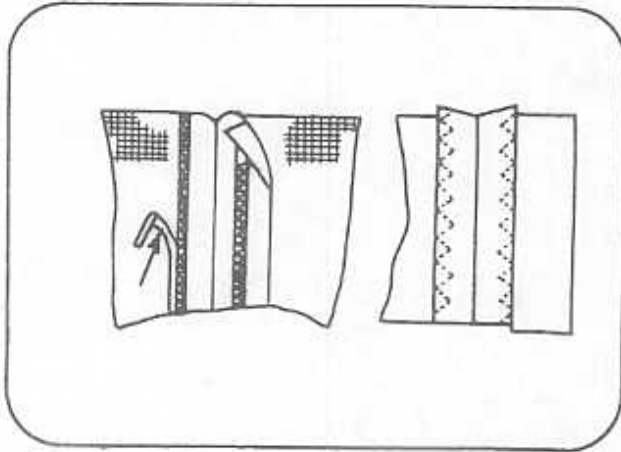

Use these stitches for sewing a clean edge to unfinished fabric edges.

## STRAIGHT AND ZIGZAG STRETCH STITCH

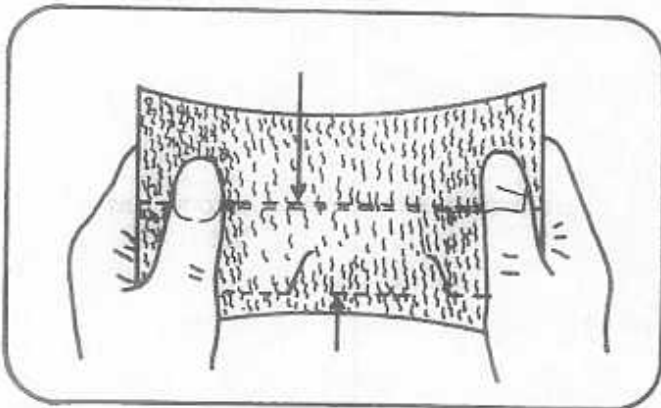

Use this stitch with knitted, tricot or other stretchy fabrics.

The stitch enables your seam to stretch with out breaking the thread.

It is also a very strong straight stitch for areas under stress.

# BLIND STITCH

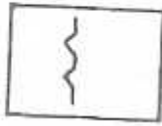

1. Fold fabric as shown.

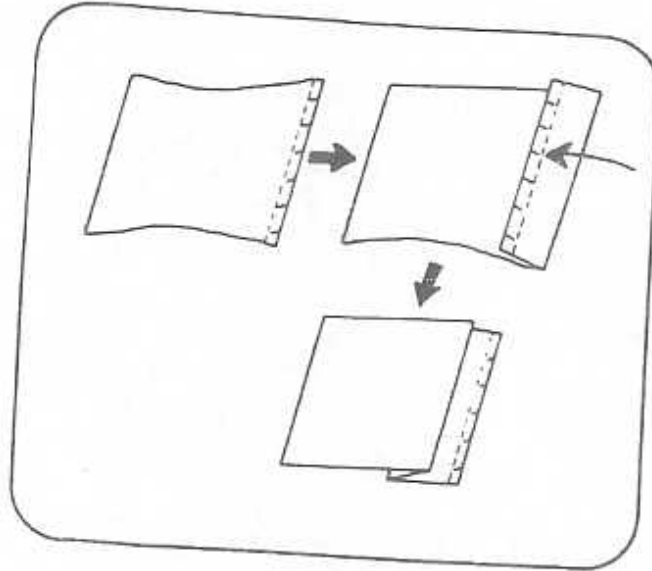

2. To finish seam as shown.

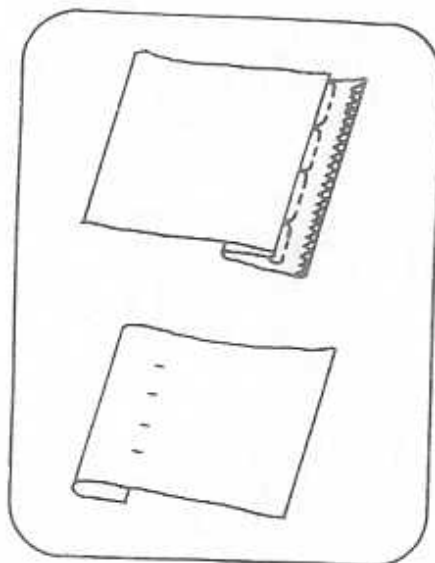



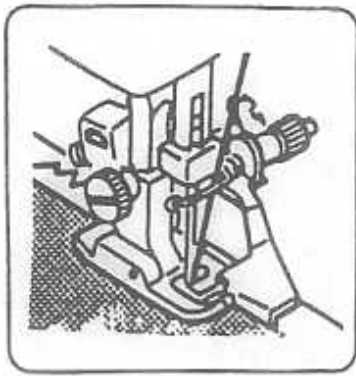

Turn the handwheel to position the needle in the left swing of the stitch. Lower the needle to pierce the edge of the fold of the fabric. Adjust the width dial to obtain the correct stitch width.

Needle is not piercing edge of fold at all.

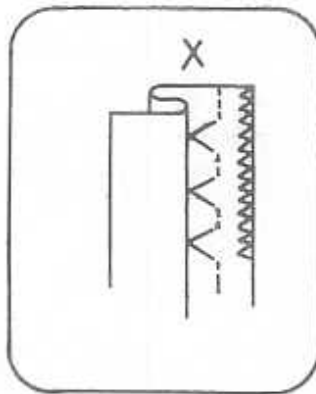

(A)

Needle pierces edge of fold too much.

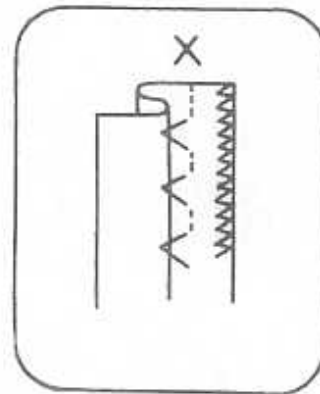

(B)

Correct seam

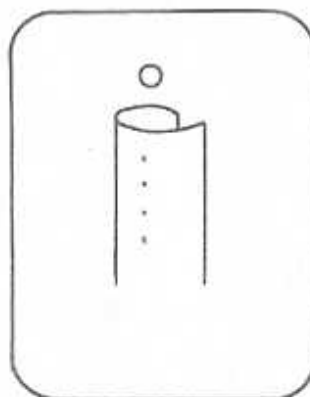

## BUTTON SEWING

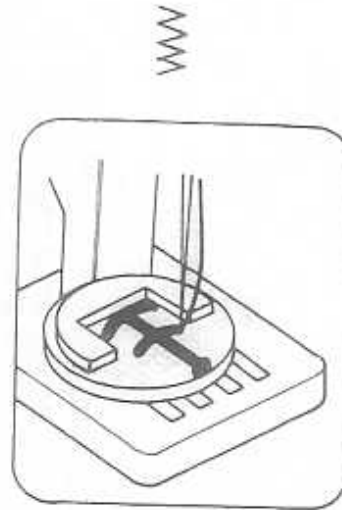
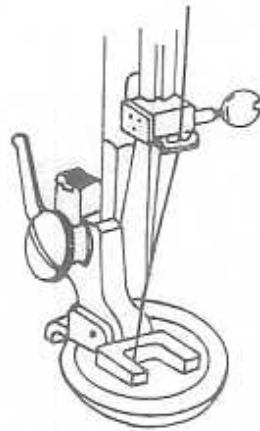

1. Lower drop feed.
2. Place button attaching presser foot in position.
3. Place button between presser foot and fabric and lower presser foot.
4. Manually turn hand wheel towards you ensuring that the needle enters into both holes of button without obstruction.  
(Increase or decrease width setting)
5. Sew about 7 stitches.
6. Pull both threads to the underside and tie together.

## BINDING

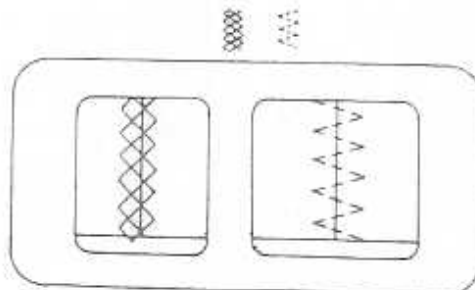

To sew fabrics edge to edge select the multi zig-zag stitch.

## ZIPPER SEWING

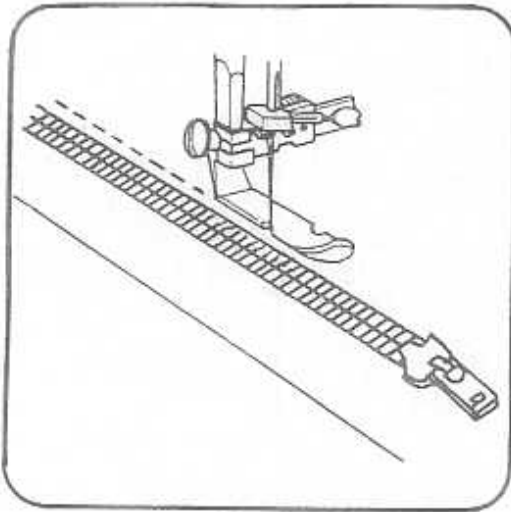

Select straight stitch.

1. Zipper foot is designed to sew close to a raised edge preventing sewing on zipper.
2. place zipper foot in position and attach firmly.
3. Fold the fabric about 2 cm (5/8 inch) and place fabric under foot.

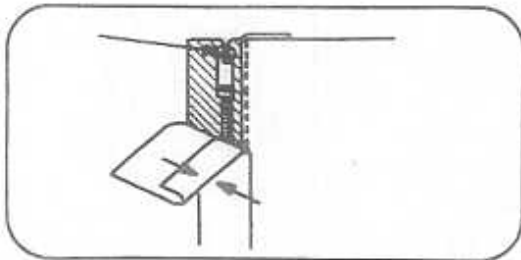

1. To sew the left side of zipper set the zipper foot on the right side of the needle.
2. To sew the right side of zipper set the zipper foot on the left side of the needle.

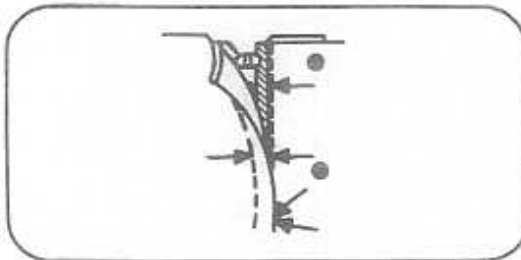

Sew as illustrated.

## BUTTONHOLE SEWING

The buttonhole mechanism makes it possible to sew button holes in a short time without turning the material.

Presser foot.....	buttonhole foot
Pattern Selector.....	J + K + L + K
Stitch length dial.....	0.5 to 1

### PREPARATION

1. Change the presser foot with buttonhole foot.
2. Push the sleigh to the bottom end. Then put button between nail A & nail B. Secure the button by tightening the fixing screw.
3. Take away the button from buttonhole foot you can get identical buttonhole size each time.
4. Push the sleigh all the way to the back to sew. Follow steps J, K, L, K on front of the machine.

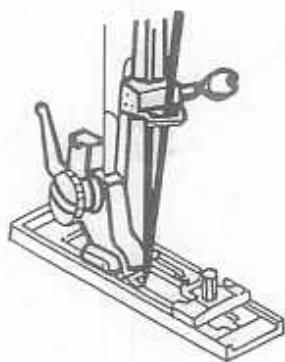
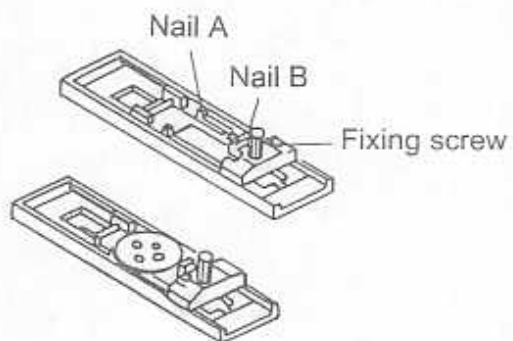

Before sewing fit button-hole foot as shown.

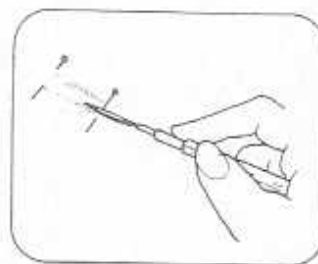

Cut buttonhole along center with cutter as shown.

## HEMMING

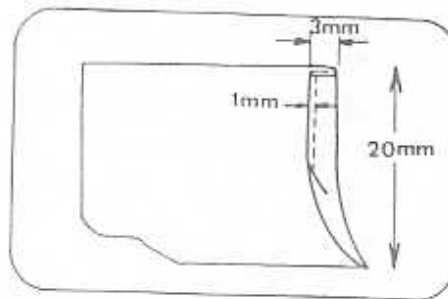

1. Raise the foot and the needle to its highest position. Replace the foot with the hemmer foot.
2. Fold over the fabric edge by about 3mm (1/8 inch) and place it under the foot. Secure the folded edge with a few stitches. Take out the workpiece and draw the hem into the hemmer foot by pulling the threads.

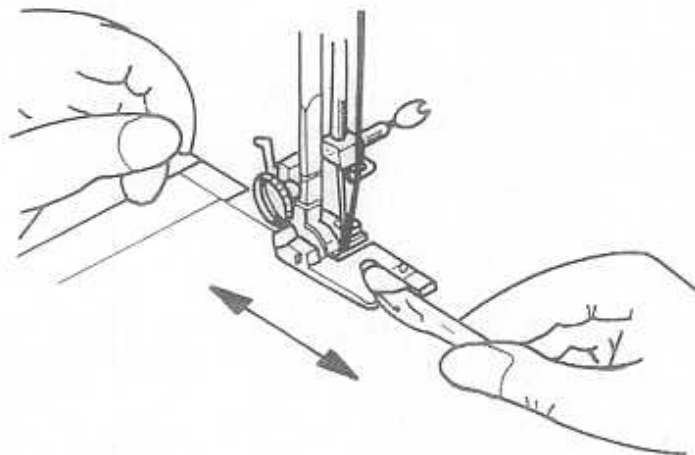

3. Lower the foot and sew the hem.
4. During sewing, fold the fabric to the left a little and allow it to run into the hemmer foot.
5. Make sure that the fabric does not move under the right half of the foot. The fabric must be fed in to the scroll of the hemmer sufficiently so that the work-piece edge runs freely through the groove under the foot.

Only suitable materials can be used and some practice may be necessary to achieve best results.

## TWIN NEEDLE

Note: Twin needle can be purchased separately

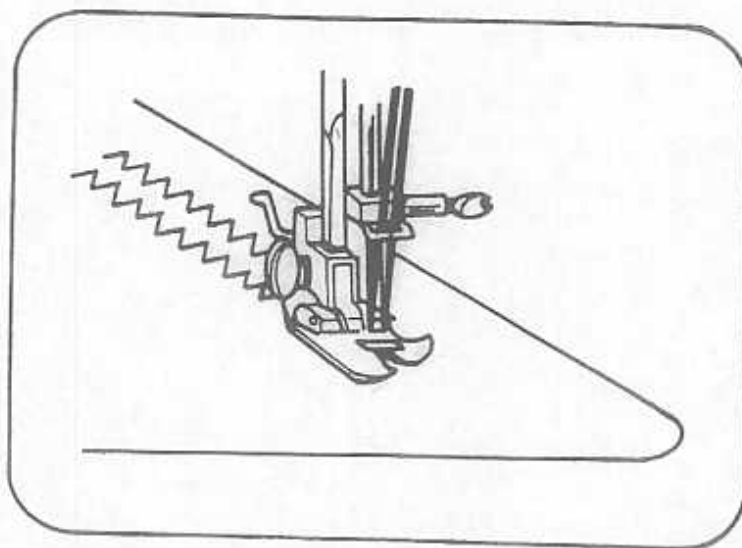

Remove regular needle and insert twin needle. Thread both threads through the same path as for normal sewing. Separate threads before last thread guide above the needle. Insert one thread into the right needle of twin needle. Insert other thread into the left needle of twin needle.

**CAUTION:** Do not set stitch width wider than number 2 setting. Exceeding this will cause breaking of needle.

## EMBROIDERY

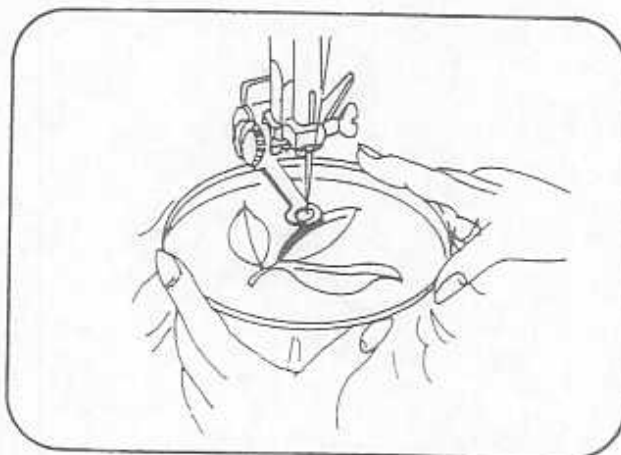

Lower feed dog and move hooped fabric slowly to form the desired effect. See page 13 drop feed.

## QUILTER

Note: Quilt guide can be purchased separately

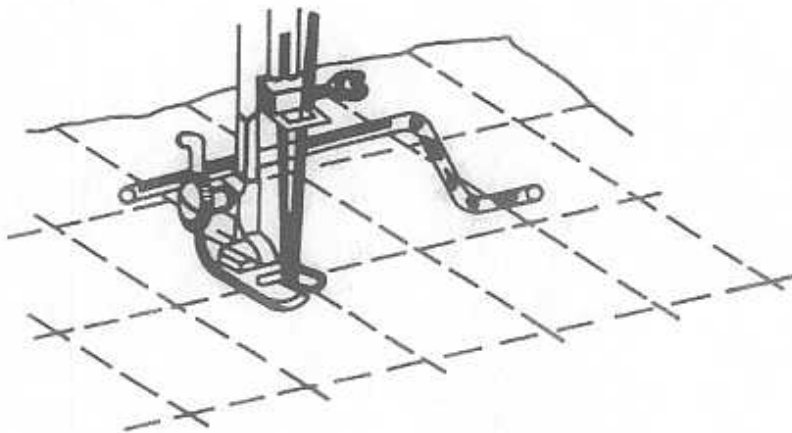

1. Slide arm through hole on top of presser foot holder.
2. Move guide to required stitch distance.

## SEAM GUIDE

Note: Seam guide can be purchased separately.

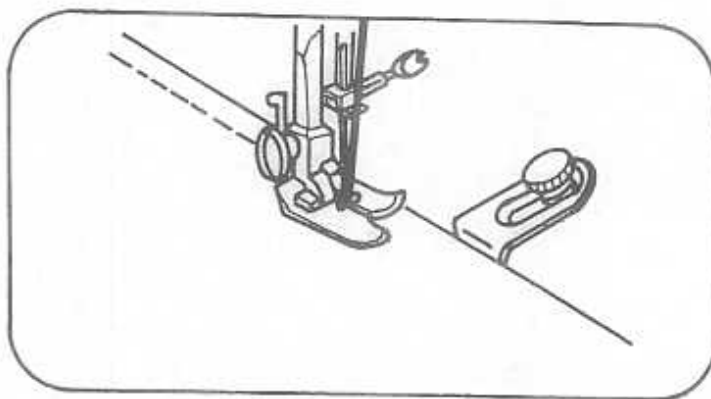

1. Use seam guide when sewing a long seam of regular distance from edge of material.
2. Set guide hole on bed, at right of needle plate, and adjust distance from the needle to the guide for desired seam allowance.
3. Run machine with edge of material touching guide.

## MAINTENANCE (CLEANING AND OILING)

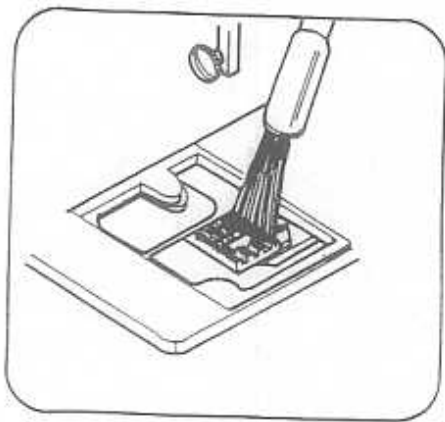

Remove throat plate and presser foot to clean lint from feed dog.

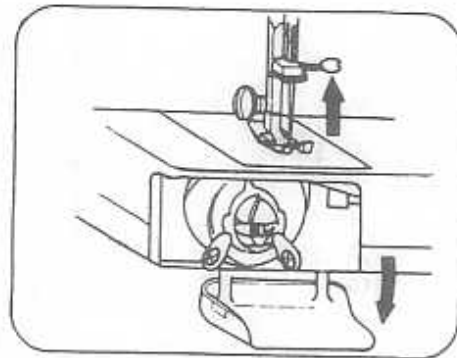

Open shuttle cover and raise presser foot.

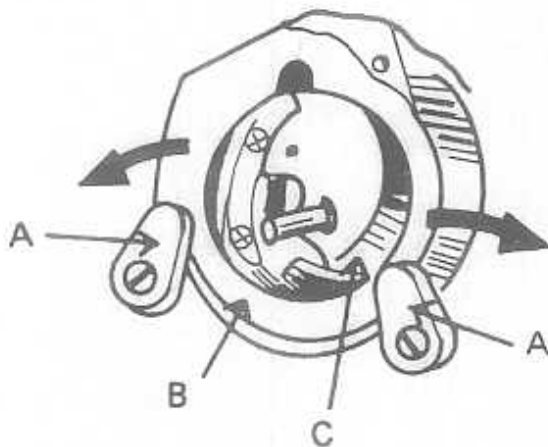

Cleaning shuttle race  
(A) Latch knob  
(B) Shuttle race cover  
(C) Shuttle hook

Note: Only use sewing machine oil.

1. Raise needle to its highest position.
2. Take out bobbin case.
3. Turn latch knob A as illustrated.
4. Take off shuttle race cover.
5. Take out shuttle hook.
6. Clean and oil shuttle race and hook, Then replace parts in the reverse order and close latch knobs A.



## TROUBLE SHOOTING

PROBLEM	PROBABLE CAUSE	CORRECTION
Fabric not moving	<ul style="list-style-type: none"> <li>- Feed dog down.</li> <li>- Machine not moving.</li> <li>- Stitch length dial in 0 position.</li> <li>- Light pressure on presser foot.</li> </ul>	<ul style="list-style-type: none"> <li>- Raise feed dog.</li> <li>- Tighten stop motion.</li> <li>- Moving dial to 1-4.</li> <li>- Increase pressure on presser foot.</li> </ul>
Breaking Needle	<ul style="list-style-type: none"> <li>- Incorrect setting of needle.</li> <li>- Needle bent.</li> <li>- Pulling fabric.</li> <li>- Incorrect use of needle, thread or fabric.</li> </ul>	<ul style="list-style-type: none"> <li>- Reset needle.</li> <li>- Fit new needle.</li> <li>- Do not pull fabric.</li> <li>- Correct use of needle, thread or fabric.</li> </ul>
Breaking Bobbin Thread	<ul style="list-style-type: none"> <li>- Improper threading.</li> <li>- Tight upper thread tension.</li> <li>- Needle bent.</li> <li>- Nicks or burrs on shuttle.</li> </ul>	<ul style="list-style-type: none"> <li>- Re-thread machine.</li> <li>- Loosen upper thread tension.</li> <li>- Fit new needle.</li> <li>- Replace shuttle, or polish off burrs completely.</li> </ul>
Machine Jamming Knocking Noise	<ul style="list-style-type: none"> <li>- No oil.</li> <li>- Dust and thread in shuttle.</li> </ul>	<ul style="list-style-type: none"> <li>- Needs oiling.</li> <li>- Clean shuttle.</li> </ul>
Puckering	<ul style="list-style-type: none"> <li>- Tension too tight.</li> <li>- Sewing foot pressure too strong.</li> <li>- Incorrect use of fabric, and thread.</li> </ul>	<ul style="list-style-type: none"> <li>- Reset.</li> <li>- Adjust sewing foot pressure.</li> <li>- Use correct fabric, needle and thread.</li> </ul>