

SINGER®

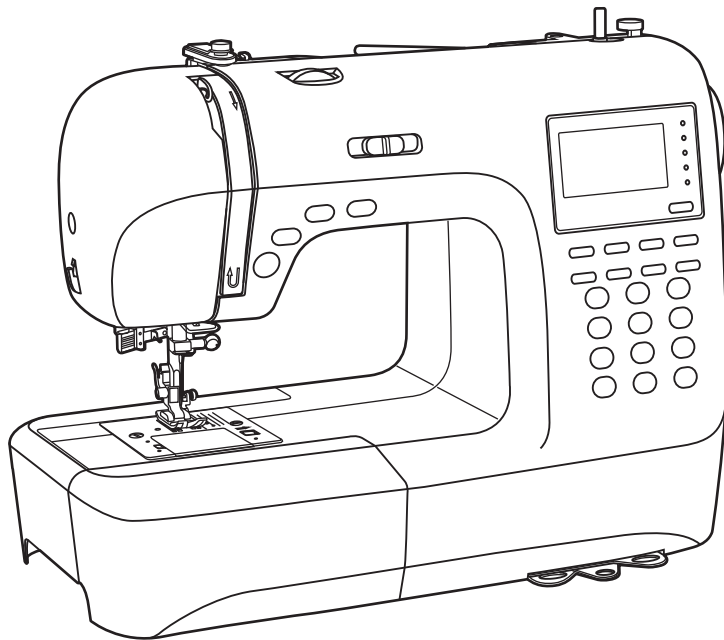

2010 Instruction Manual

SYMBOL INSTRUCTIONS

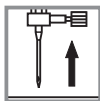

Raise needle



Raise presser foot

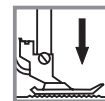

Lower presser foot

IMPORTANT SAFETY INSTRUCTIONS

When using an electrical appliance, basic safety should always be followed, including the following: Read all instructions before using this sewing machine.

DANGER -To reduce the risk of electrical shock:

1. An appliance should never be left unattended when plugged in.
2. Always unplug this appliance from the electric outlet immediately after using and before cleaning.

WARNING -To reduce the risk of burns, fire, electrical shock, or injury to persons:

1. Do not allow to be used as a toy. Close attention is necessary when this appliance is used by or near children.
2. Use this appliance only for its intended use as described in this manual. Use only the attachments recommended by the manufacturer as contained in this manual.
3. Never operate this appliance if it has a damaged cord or plug, if it is not working properly, if it has been dropped or damaged, or dropped into water. Return the appliance to the nearest authorized dealer or service center for examination, repair, electrical or mechanical adjustment.
4. Never operate the appliance with any air openings blocked. Keep ventilation openings of the sewing machine and foot controller free from accumulation of lint, dust, and loose cloth.
5. Keep fingers away from all moving parts. Special care is required around the sewing machine needle.
6. Always use the proper needle plate, as using the wrong needle plate may cause the needle to break.
7. Do not use bent needles.
8. Do not pull or push fabric while stitching. It may deflect the needle causing it to break.
9. Switch the sewing machine off ("O") when making any adjustments in the needle area, such as threading needle, changing needle, threading bobbin, changing presser foot or changing the light.
10. Always unplug sewing machine from the electrical outlet when removing covers, lubricating, or when making any other user servicing adjustments mentioned in the instruction manual.
11. Never drop or insert any object into any opening.
12. Do not use outdoors.
13. Do not operate where aerosol spray products are being used or where oxygen is being administered.
14. To disconnect, turn all controls to the off ("O") position, then remove plug from outlet.
15. Do not unplug by pulling on cord. To unplug, grasp the plug, not the cord.
16. The sound pressure level under normal operating conditions is 75dB(A).
17. Please turn off or unplug the machine if it is not operating properly.
18. Never place anything on the foot controller.
19. This appliance is not intended for use by persons (including children) with reduced physical, sensory or mental capabilities, or lack of experience and knowledge, unless they have been given supervision or instruction concerning use of the appliance by a person responsible for their safety.
20. Children should be supervised to ensure that they do not play with the appliance.

SAVE THESE INSTRUCTIONS

This sewing machine is intended for household use only.

CONTENTS

PRINCIPAL PARTS OF THE MACHINE	1
MACHINE CONTROL BUTTONS	2-3
Operation buttons (see page 24/25).	2
Function buttons (see page 26/27/28)	2
Selection buttons (see page 29/30)	3
LCD SCREEN	4-5
PATTERN CHART	6-7
ACCESSORIES	8
CONNECTING THE MACHINE TO THE POWER SOURCE	9
Connecting the machine	9
WINDING THE BOBBIN	10-11
Bobbin winding	10-11
INSERTING THE BOBBIN	12
THREADING THE UPPER THREAD	13-14
USING THE NEEDLE THREADER	15
DRAWING UP THE LOWER THREAD	16
CUTTING THE THREAD	16
TWO-STEP PRESSER FOOT LIFTER	17
STARTING SEWING	18
Start/stop button	18
Foot control	18
THREAD TENSION	19
CHANGING THE PRESSER FOOT	20
PRESSER FOOT CHART	21
MATCHING NEEDLE/ FABRIC/ THREAD	22
REPLACING THE NEEDLE	23
RAISE OR LOWER FEED DOGS	23
OPERATION BUTTONS	24-25
Start/stop button	24
Reverse button	24
Auto-lock button	25
Needle up/ down position button	25
FUNCTION BUTTONS	26-28
Stitch width adjustment button	26
Stitch length adjustment button	27
MODE selection button	27
Elongation button (see page 59)	27
Mirror button (see page 60)	28
Twin needle button (see page 61)	28
SELECTION BUTTONS	29-30
Direct pattern selection and number buttons	29
Edit button.	30
Memory button	30
Clear button	30
SEWING TIPS	31-32
Sewing corners	31
Reverse	31
Free arm	31
Installing the extension table.	32
Sewing on heavy fabric	32
NEEDLE POSITION AND STITCH LENGTH	33
ZIGZAG STITCHES	33
STRETCH STITCHES	34

CONTENTS

OVERCASTING STITCHES	35
Using the overcasting foot	35
Using the all purpose foot	35
BLIND HEMS	36
BUTTON SEWING	37
CORDED BUTTONHOLES	38-41
Making a buttonhole on stretch fabrics	41
BAR TACK STITCH	42
EYELET STITCH	43
DARNING STITCH	44-45
ZIPPER INSERTION	46-47
Inserting a centered zipper	46
Inserting a lapped zipper	47
NARROW HEMMING	48
CORDING	49
Single cording	49
Triple cording	49
SATIN STITCH SEWING	50
EDGE/QUILTING GUIDE	51
GATHERING	52
SMOCKING	53
FREE MOTION SEWING	54-55
Darning	54
Embroidery	55
Monogramming	55
WALKING FOOT	56
FAGOTING	57
DECORATIVE TOPSTITCHING	57
SCALLOP STITCH	58
Scallop hem	58
Scallop edging	58
ELONGATION	59
MIRROR IMAGE	60
USING THE TWIN NEEDLE	61
MEMORY	62-65
Combining patterns or letters	62-63
Adding patterns or letters	63
Editing patterns	64
Clearing patterns or letters	64
Recalling and sewing the memorized pattern	65
WARNING FUNCTIONS	66-67
Warning animation message display	66
Instruction animation message display	66
Warning beeping sound	67
BUZZER SOUND	68
MAINTENANCE	69-70
Cleaning the screen	69
Cleaning the sewing machine surface	69
Cleaning the hook	69-70
TROUBLE SHOOTING GUIDE	71-72
STITCH ADJUSTMENT REFERENCE CHART	73-78



PRINCIPAL PARTS OF THE MACHINE

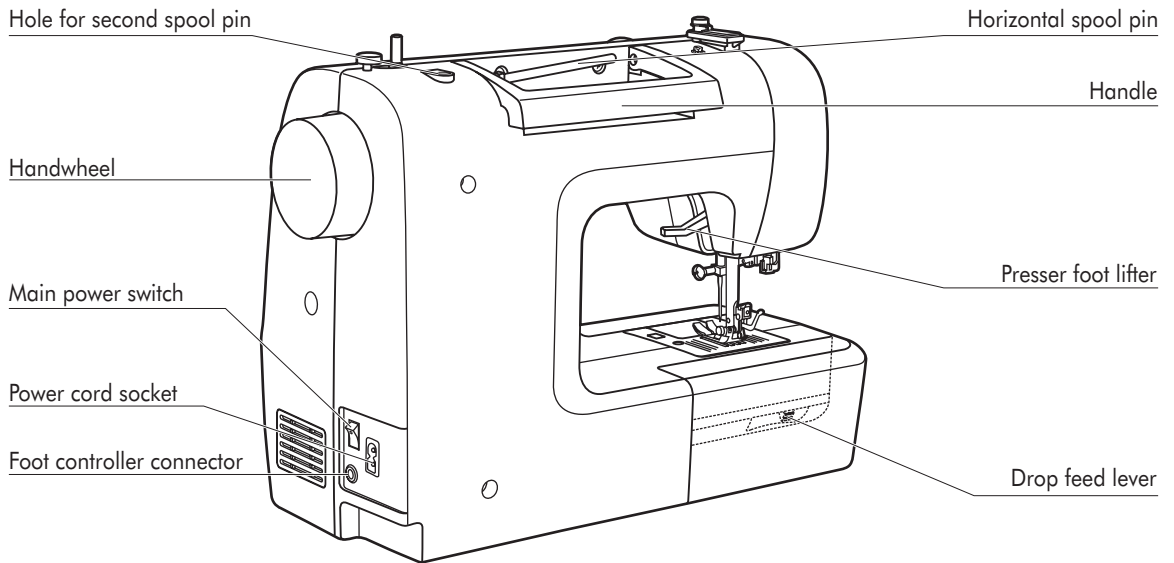
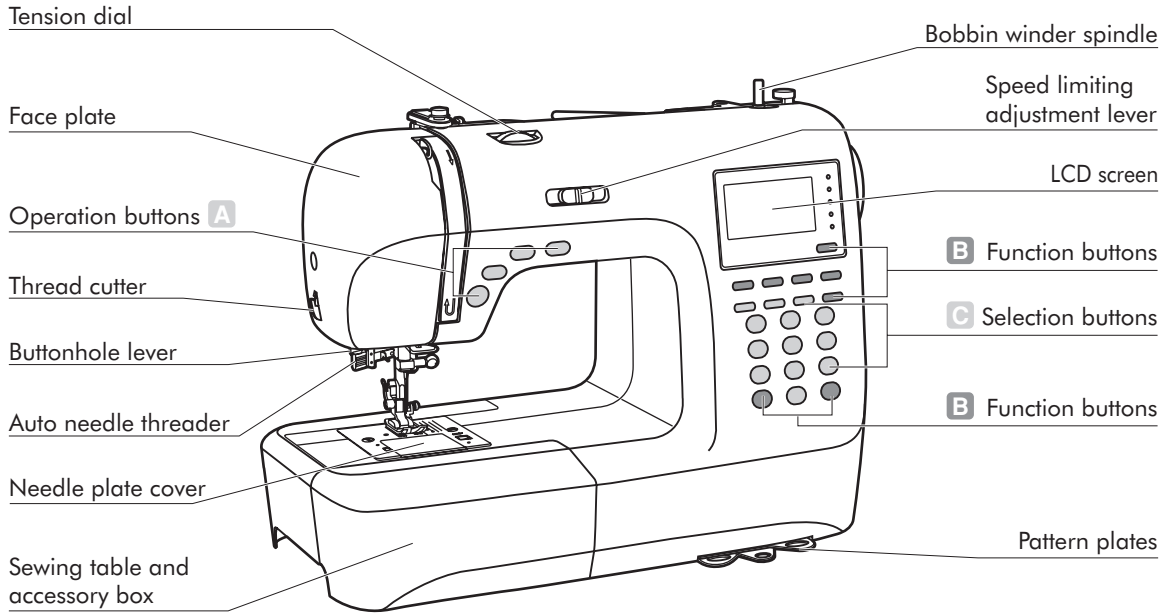

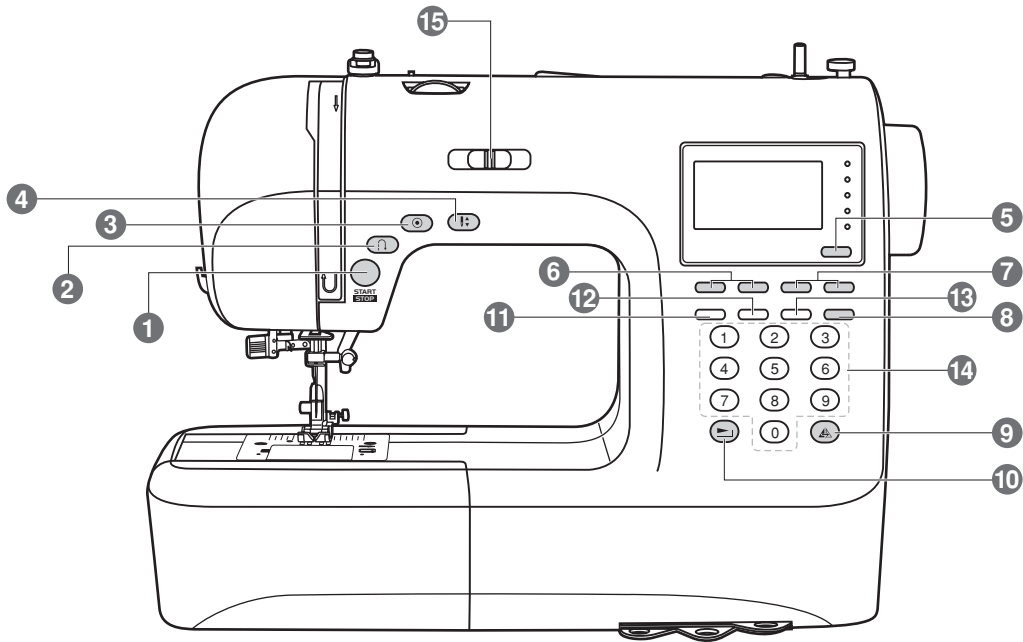

● **A. Operation buttons** (see page 24/25)

1. Start/stop button

Press this button to start or stop the machine.

2. Reverse button

Hold down this button to sew stitches in reverse or sew reinforcement stitches at a low speed.

3. Auto-lock button

Hold down this button to sew locking stitches immediately or at the end of the current patterns and automatically stop.

4. Needle up/down position button

Press this button to move the needle to either up or down position. Needle will be programmed to stop in selected position until button is pressed again.

● **B. Function buttons** (see page 26/27/28)

5. Mode selection button

Press this button to select direct mode, utility and decorative pattern mode, block letter mode, script letter mode and outline letter mode.

6. Stitch width adjustment buttons

Press this button to adjust the width of the zigzag stitch.



MACHINE CONTROL BUTTONS

7. **Stitch length adjustment buttons**

Press this button to adjust the length of the stitch.

8. **Twin needle button**

Press this button to fix the width range when using the twin needle to sew.

9. **Mirror button**

Press this button to sew a reflection pattern.

10. **Elongation button**

Pattern 28 to 51 can be elongated up to five times its normal length by pressing this button.

● **C. Selection buttons** (see page 29/30)

11. **Edit button**

Press this button to set an added pattern when sewing combinations of decorative stitches.

12. **Memory button**

Press this button to enter or store the created pattern combination in the memory.

13. **Clear button**

If an incorrect pattern is selected or memorized, pressing this button will clear it.

14. **Direct pattern selection and number buttons**

Instant access to direct pattern or press number buttons of the pattern number to select the desired pattern.

15. **Speed limiting adjustment lever**

Slide this lever to change the sewing speed.

● Pattern

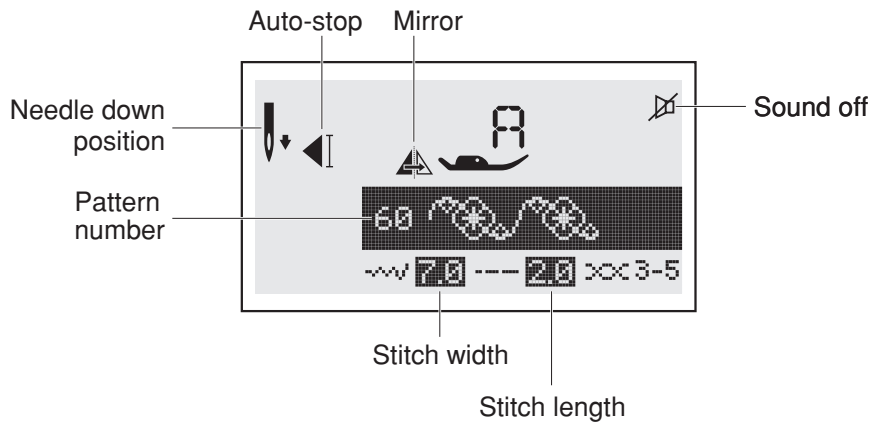
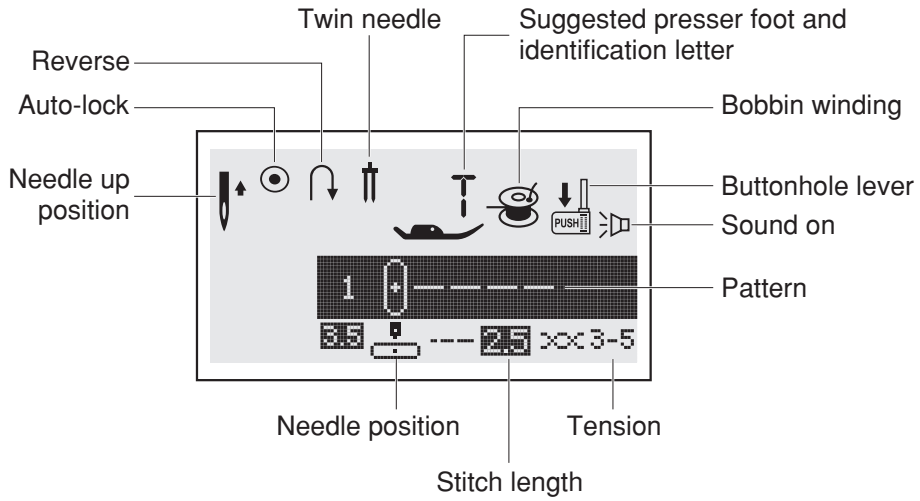

● Alphabet

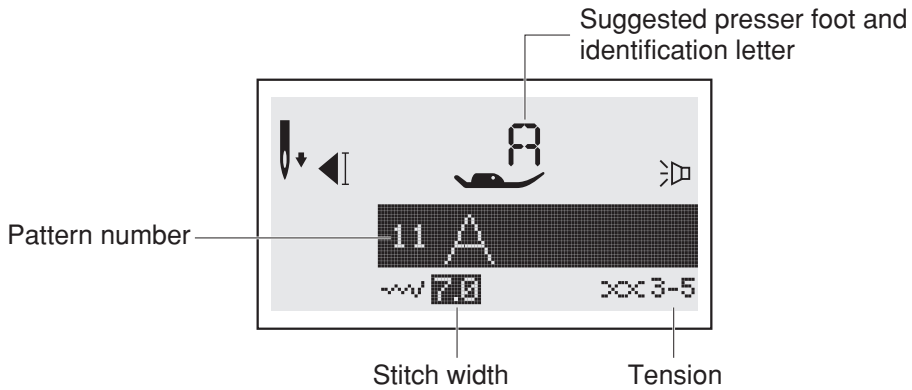

● **Memory**

Editing patterns

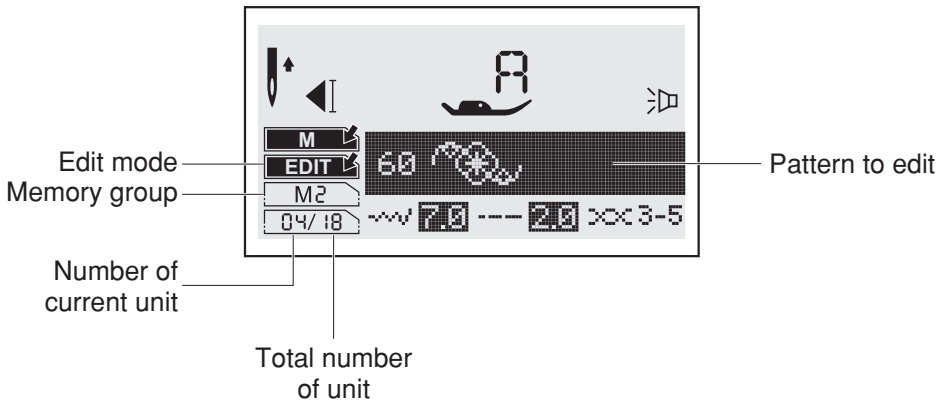

Sewing the memorized pattern

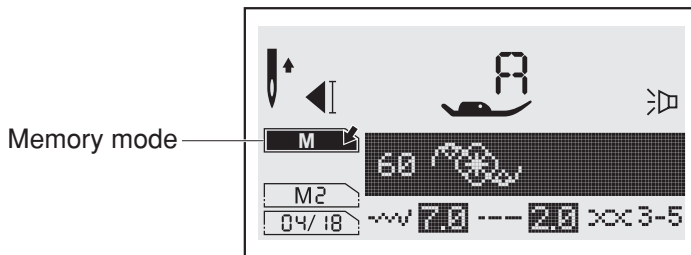

● **Elongation**

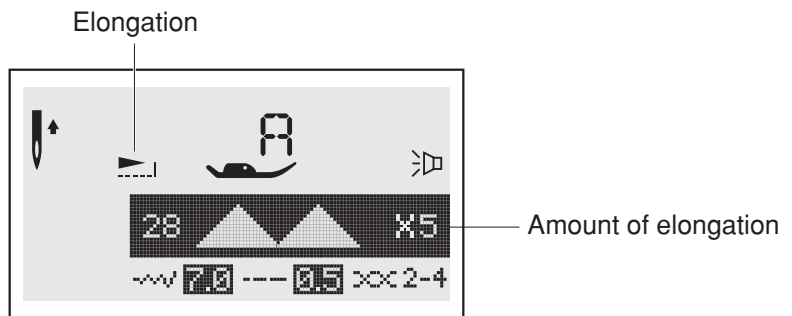



PATTERN CHART

The portions marked in gray (on the chart below) show the single unit of each stitch.

● Patterns

Direct Patterns-10

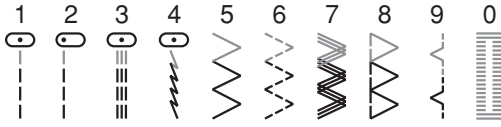

A Group Patterns-100

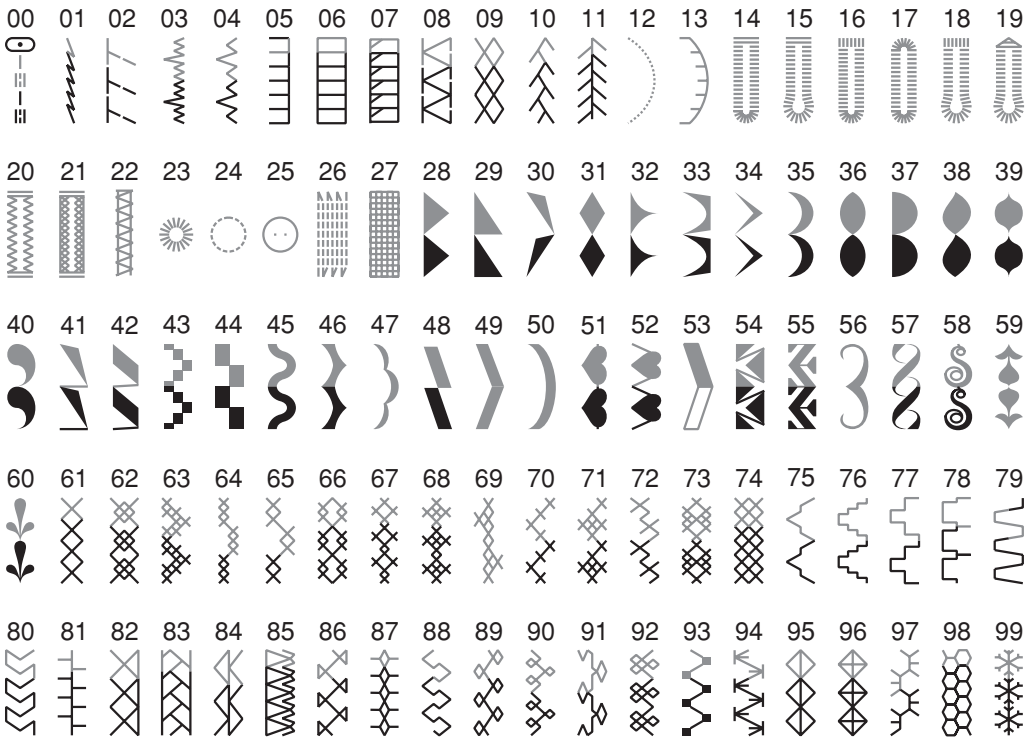

B Group Patterns-100





PATTERN CHART

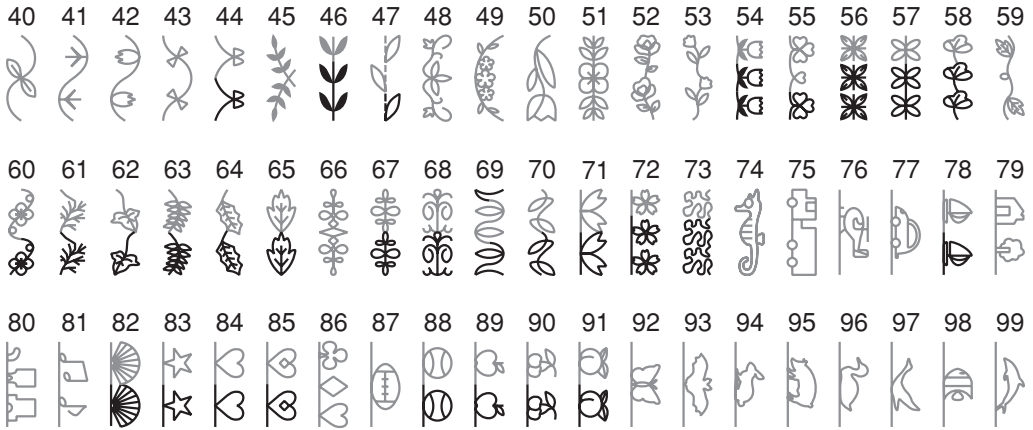

● Alphabets











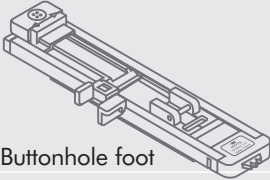

Block style

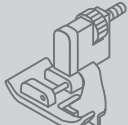
01	02	03	04	05	06	07	08	09	10																
1	2	3	4	5	6	7	8	9	0																
11	12	13	14	15	16	17	18	19	20	21	22	23	24	25	26	27	28	29	30	31	32	33	34	35	36
A	B	C	D	E	F	G	H	I	J	K	L	M	N	O	P	Q	R	S	T	U	V	W	X	Y	Z
37	38	39	40	41	42	43	44	45	46	47	48	49	50	51	52	53	54	55	56	57	58	59	60	61	62
a	b	c	d	e	f	g	h	i	j	k	l	m	n	o	p	q	r	s	t	u	v	w	x	y	z
63	64	65	66	67	68	69	70	71	72	73	74	75	76	77	78	79	80	81	82	83	84	85	86	87	88
Ä	Å	Æ	Ñ	Ö	Ø	Ç	Ü	ä	å	æ	ë	è	é	ê	ñ	ö	ø	ì	ç	ü	ÿ	ß	&		
89	90	91	92	93	94	95	96	97																	
?	!	_	'	,	.	-	()																	

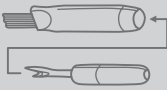
Script style

01	02	03	04	05	06	07	08	09	10																
1	2	3	4	5	6	7	8	9	0																
11	12	13	14	15	16	17	18	19	20	21	22	23	24	25	26	27	28	29	30	31	32	33	34	35	36
A	B	C	D	E	F	G	H	I	J	K	L	M	N	O	P	Q	R	S	T	U	V	W	X	Y	Z
37	38	39	40	41	42	43	44	45	46	47	48	49	50	51	52	53	54	55	56	57	58	59	60	61	62
a	b	c	d	e	f	g	h	i	j	k	l	m	n	o	p	q	r	s	t	u	v	w	x	y	z
63	64	65	66	67	68	69	70	71	72	73	74	75	76	77	78	79	80	81	82	83	84	85	86	87	88
Ä	Å	Æ	Ñ	Ö	Ø	Ç	Ü	ä	å	æ	ë	è	é	ê	ñ	ö	ø	ì	ç	ü	ÿ	ß	&		
89	90	91	92	93	94	95	96	97																	
?	!	_	'	,	.	-	()																	

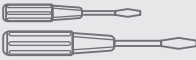
Standard

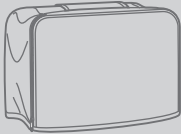
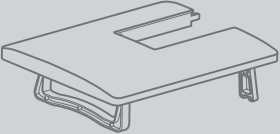
			
All purpose foot T 006186008	Zipper foot I 006905008	Buttonhole foot D 006H1A0004	Overcasting foot E 006907008
			
Blind hem foot F 006904008	Satin stitch foot A 006172008	Button sewing foot 006914008	Brush/ Seam ripper 006099008
			
Spool holders (L & S) R12373209(L) TA10943209(S)	Edge/quilting guide 006008001	Bobbin (3x) 006084009	Screwdriver (L & S) 006012008
			
Spool pin felt 006015009	Second spool pin R60033209	Sewing machine dust cover 020L008000	Extension table H1A1464209

Optional

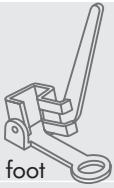
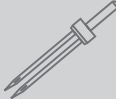
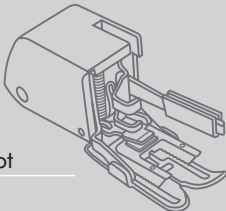
			
Cording foot M 006813008	Rolled hem foot K 006900008	Quilting foot P 006916008	Darning/ Embroidery foot 006016008
			
Gathering foot 006917008	SINGER style 2025 twin needle 006020008	Walking foot 0061850081	

CONNECTING THE MACHINE TO THE POWER SOURCE

Caution: Always make sure that the machine is unplugged from power source and the main switch is on "O" when the machine is not in use and before inserting or removing parts.

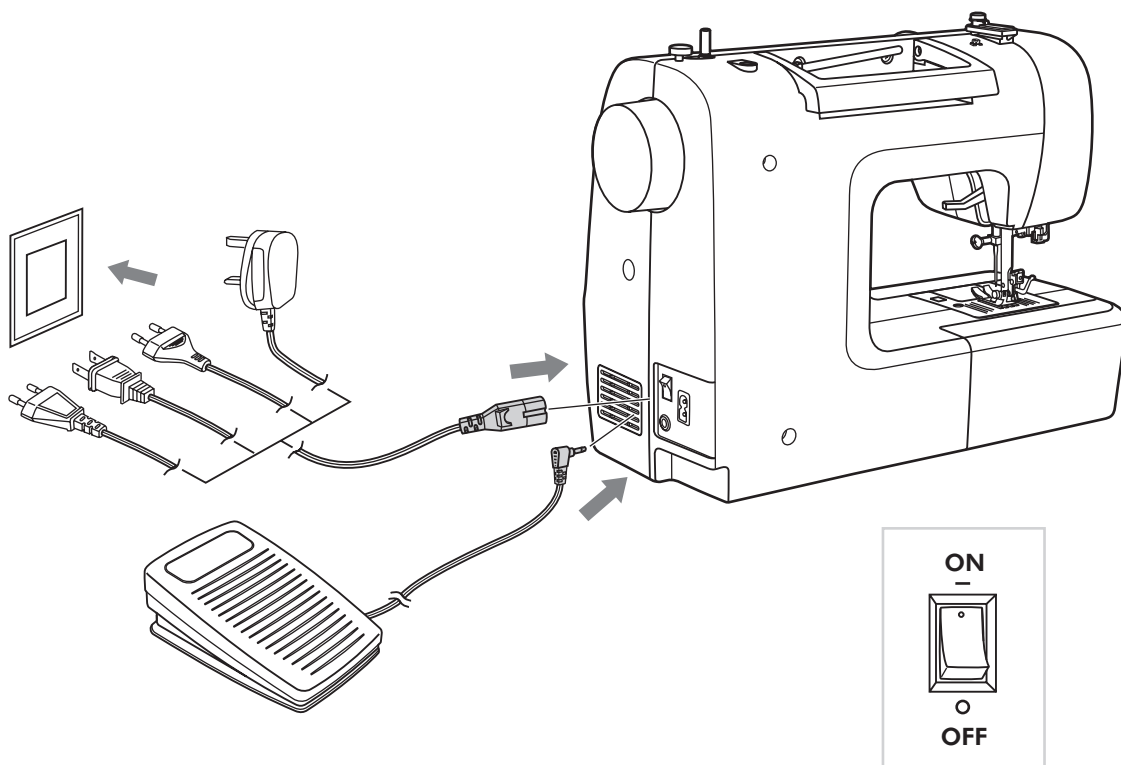

● Connecting the machine

Before connecting the power supply, make sure that the voltage and frequency shown on the machine is conforming with your electrical power.

Place machine on a stable surface.

1. Connect the power line cord to the machine by inserting the 2-hole plug into the power cord socket.
2. Connect the power line plug to the electric outlet.
3. Turn on the power switch.
4. The sewing lamp will light up when the switch is turned on.

To disconnect, turn the power switch to the off position, then remove plug from outlet.

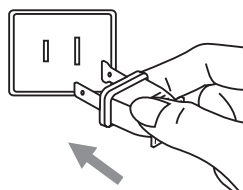

Polarized plug information

This appliance has a polarized plug (one blade wider than the other), to reduce the risk of electrical shock; this plug will fit in a polarized outlet only one way. If the plug does not fit fully in the outlet, reverse the plug. If it still does not fit, contact a qualified electrician. Do not modify the plug in any way.

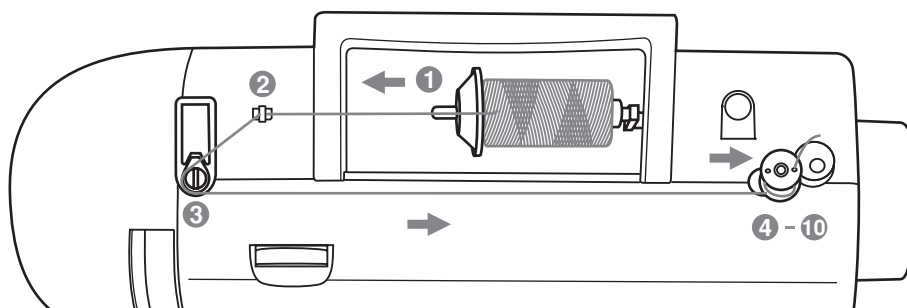
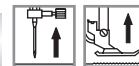

● Bobbin winding

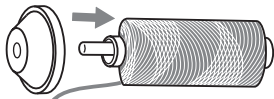
- 

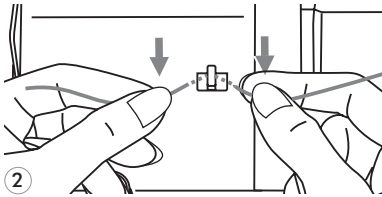
1 Place the thread and spool holder onto the spool pin. For larger spools of thread, place the large side of the spool holder toward the spool. For smaller spools of thread, place the small side of the spool holder toward the spool, or use the small spool holder. If the thread spool has a thread retaining slit, place this end of the spool toward the right, so the thread doesn't get caught while winding the bobbin.
- 

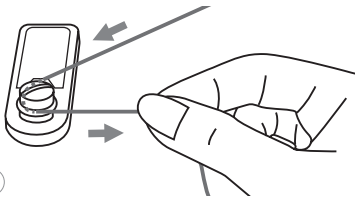
2 Snap the thread into the thread guide.
- 

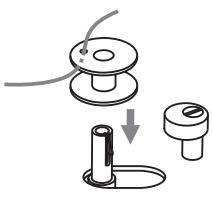
3 Wind the thread counter-clockwise around the bobbin winder tension disks.
- 

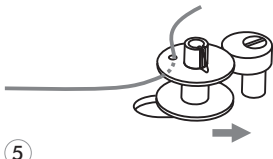
4 Place the thread end through one of the inner holes in the bobbin as illustrated and place empty bobbin on the spindle.
- 

5 Push the bobbin to right.

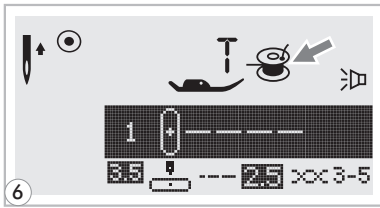
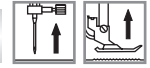

6 When the bobbin winder spindle is pushed to the right, which is the "bobbin winding position", the symbol "  " appears on the LCD screen.

The symbol will disappear from the LCD screen when the bobbin winder spindle is pushed to the left, which is the "sewing position".

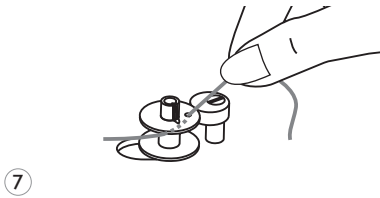

7 Hold the thread tail securely in one hand.

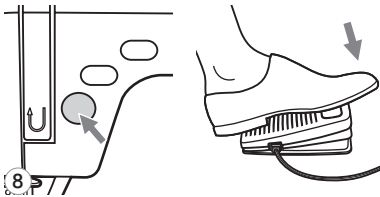

8 Press the Start/stop button or the foot control.

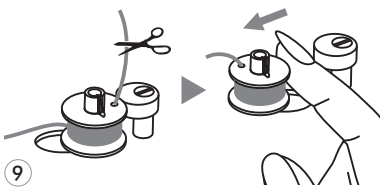

9 After the bobbin has wound a few turns stop the machine and cut the thread near the hole of the bobbin. Continue winding the bobbin until it is full. The motor stops automatically when the bobbin is full. Stop the machine. Push the bobbin winder spindle to left.

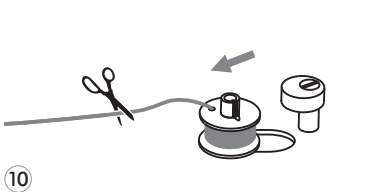

10 Cut the thread and then remove the bobbin.

 **Please Note:** When the bobbin winder switch is placed on the right, "bobbin winding position", the machine will not sew and the handwheel will not turn. To start sewing, push the bobbin winder switch to the left "sewing position".

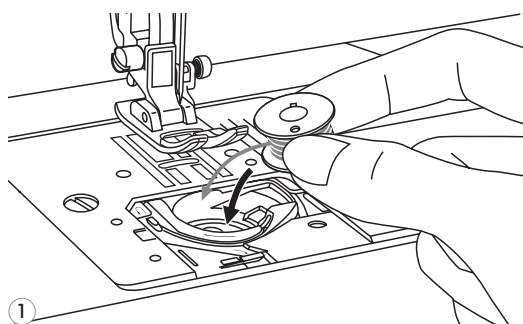
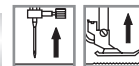

⚠ Attention: Turn power switch to off ("O") before inserting or removing the bobbin.

When inserting or removing the bobbin, the needle and presser foot must be fully raised.

1 Insert the bobbin in the bobbin case with the thread running in a counterclockwise direction (arrow).

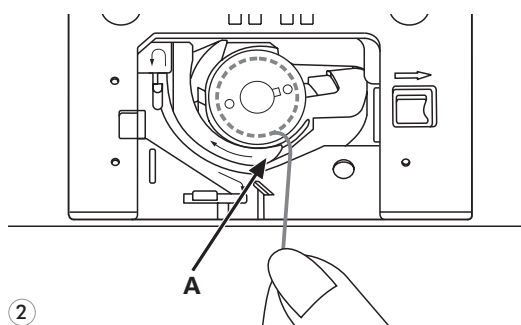

2 Pull the thread through the slit (A).

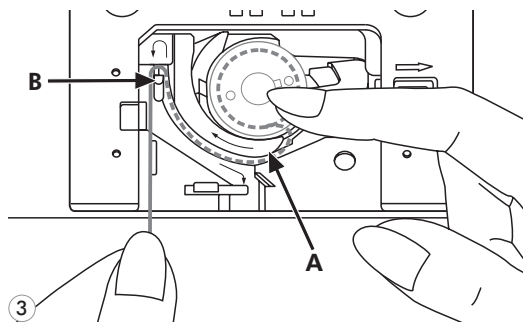

3 With a finger held gently on top of the bobbin.

Draw the thread at the arrow markings into the stitch plate thread guide from (A) to (B).

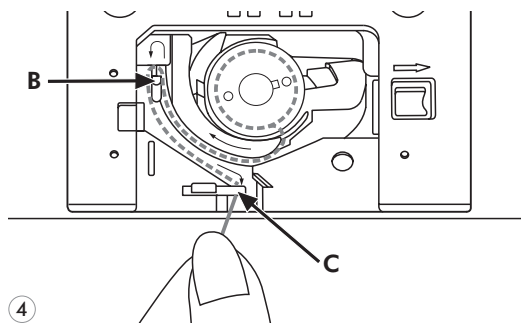

4 Pull the thread at the arrow markings into the stitch plate thread guide from (B) to (C).

To cut off excess thread pull thread back over the cutting off blade at point (C). Close the bobbin cover plate.

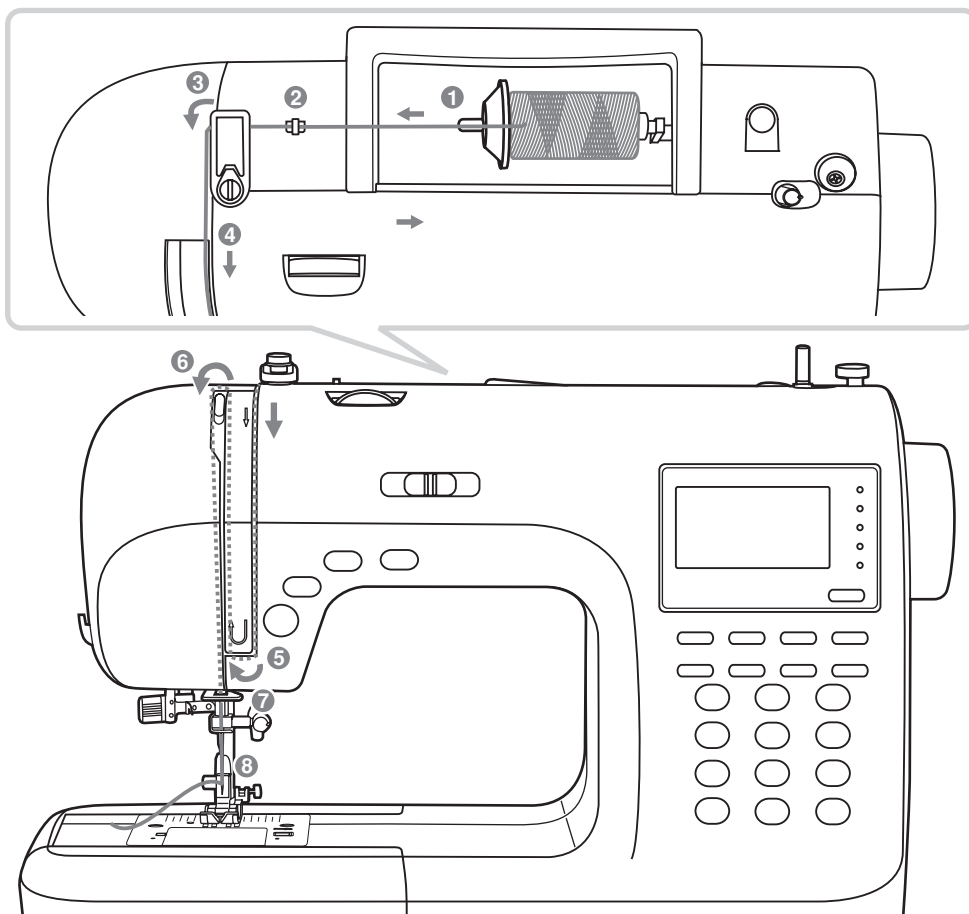
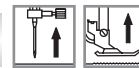

Please Note: It is important to carry out the threading correctly as by not doing so several sewing problems could result.

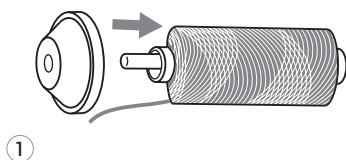

①

Start by raising the needle to its highest point, and also raise the presser foot to release the tension discs.

1 Lift up the spool pin. Place the spool of thread on the spool pin so that the thread comes from the front of the spool, then place the spool cap at the end of the spool pin.

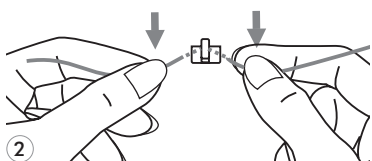

②

2 Draw the thread from the spool through the upper thread guide.

THREADING THE UPPER THREAD

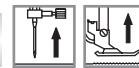

3

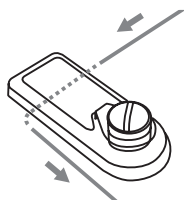

- 3** Guide the thread around the thread guide pulling the thread through the pre-tension spring as illustrated.

4

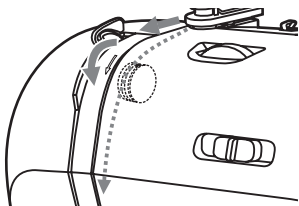

- 4** Thread the tension module by passing the thread between the silver discs.

5

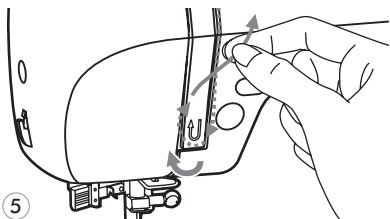

- 5** Then, down and around the check spring holder.

6

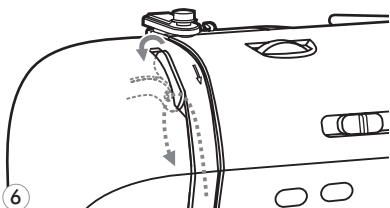

- 6** At the top of this movement, pass the thread from right to the left through the slotted eye of the take-up lever and then downwards again.

7

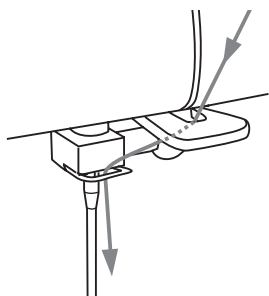

- 7** Pass the thread behind the flat, horizontal thread guide. Guide the thread through the thread guide located above the needle. Pull the end of the thread through the needle from front to rear, and pull out about 10 cm of thread. Use the needle threader to thread the needle. (On the next page.)

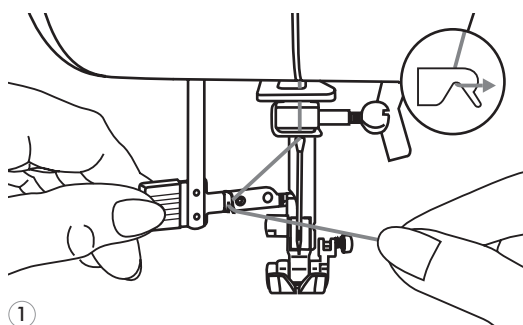

1

! Attention: Turn power switch to the off position ("O").

Raise the needle to its highest position and lower the presser foot.

1 Lower the needle threader lever slowly and draw the thread through the thread guide as illustrated and then to the right.

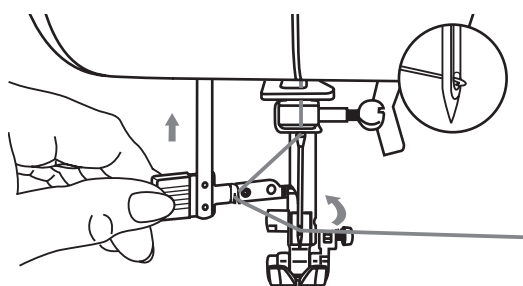

2

2 The needle threader automatically turns to the threading position and the hook pin passes through the needle eye.

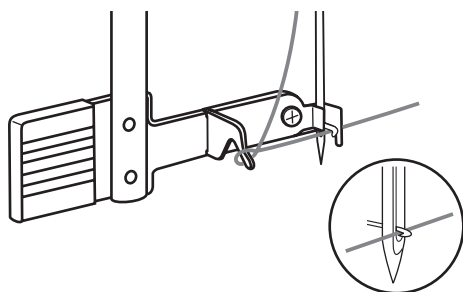

3

3 Take the thread in front of the needle.

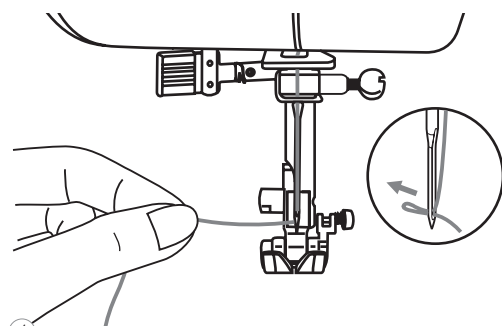

4

4 Hold the thread loosely and release the lever slowly. The hook will turn and pass the thread through the needle eye forming a loop.

Pull the thread through the needle eye.

DRAWING UP THE LOWER THREAD

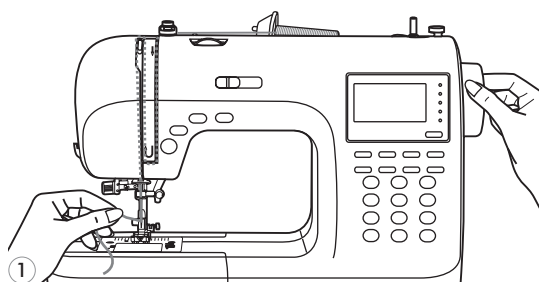

- 1** Hold the upper thread with the left hand. Turn the handwheel towards you (counterclockwise) lowering, then raising the needle.

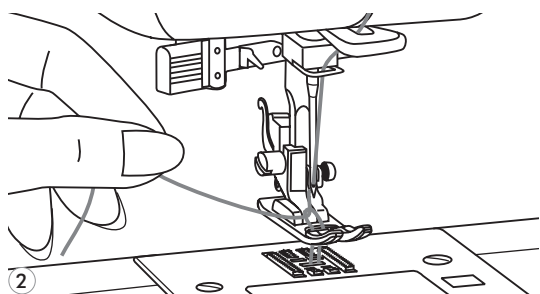

- 2** Gently pull on the upper thread to bring the bobbin thread up through the needle plate hole. The bobbin thread will come up in a loop.

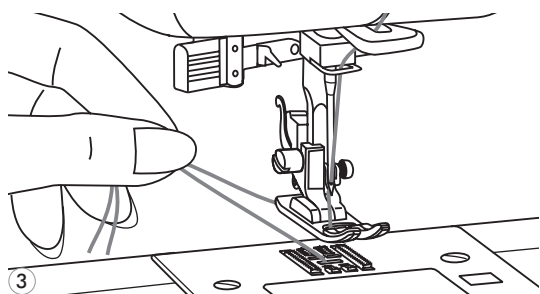

- 3** Pull both threads to the back under the presser foot.

CUTTING THE THREAD

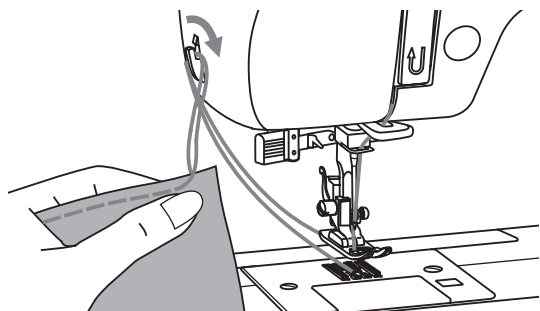
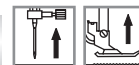

Raise the presser foot. Remove the fabric, draw the threads to the left side of the face cover and cut using the thread cutter.

The threads are cut at the proper length to start the next seam.



TWO-STEP PRESSER FOOT LIFTER

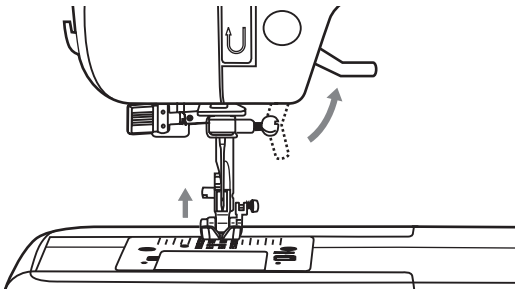

The presser foot lifter raises and lowers the presser foot.

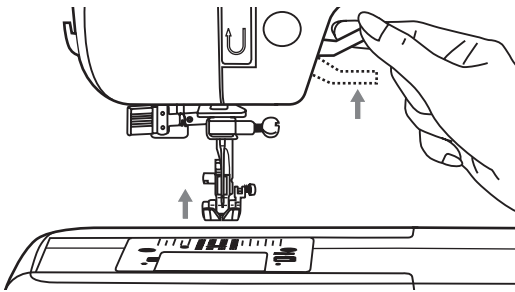

When sewing several layers or thick fabrics, the presser foot can be raised a second stage for easy positioning of the work.



STARTING SEWING

● Start/stop button

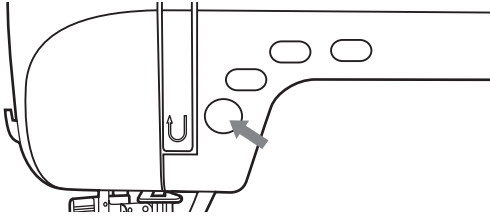

The Start/Stop button can be used to run the machine when the foot controller is unplugged from the machine. Press the button to start sewing, then press it again to stop sewing. The machine will run slowly at the start of sewing.

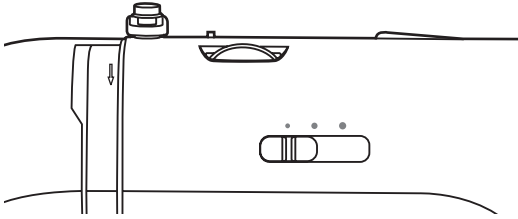

The speed limiting adjustment lever can control the sewing speed. To increase the sewing speed, slide the lever to the right, To decrease the sewing speed, slide the lever to the left.

● Foot control

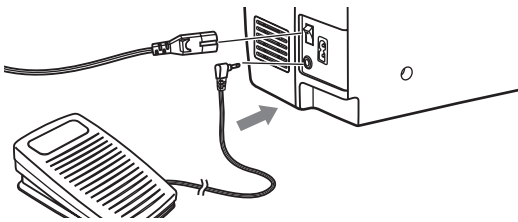

With the sewing machine turned off, insert the foot control plug into its connector on the sewing machine.

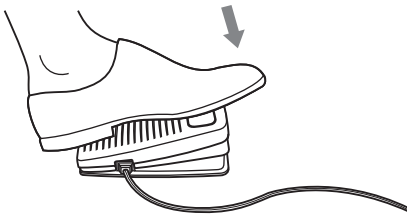

Turn on the sewing machine, and then slowly depress the foot control to start sewing.

Release the foot control to stop the sewing machine.



Please Note: The setting of the speed limiting adjustment lever will limit the maximum speed of the machine.



THREAD TENSION

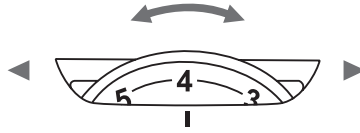

- Basic thread tension setting is "4". To increase the tension, turn the dial to the next number up. To decrease the tension, turn the dial to the next number down.
- Proper setting of tension is important for good sewing. There is no single tension setting appropriate for all the stitch functions and fabrics. However, 90% of all sewing will be between the "3" and "5" ("4" is the basic setting).
- For decorative sewing you will always obtain a nicer stitch and less fabric puckering when the upper thread appears on the bottom side of your fabric.

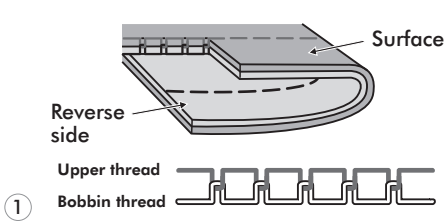

1 Normal thread tension for straight stitch sewing.

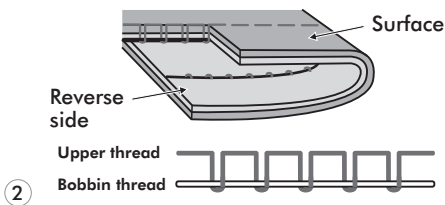

2 Thread tension is too loose for straight stitch sewing. Turn dial to higher number.

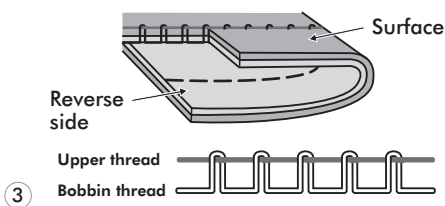

3 Thread tension is too tight for straight stitch sewing. Turn dial to lower number.

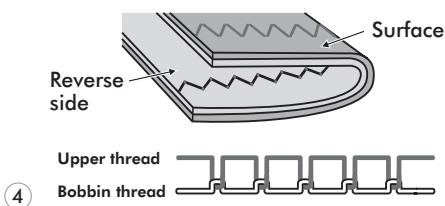

4 Normal thread tension for zig zag and decorative sewing.



Attention: Turn power switch of off ("O") position when carrying out any of the operations shown below.

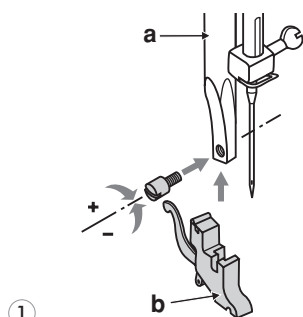

1 Attaching the presser foot holder
Raise the presser foot bar (a) by raising the presser foot lifter. Attach the presser foot holder (b) as illustrated.

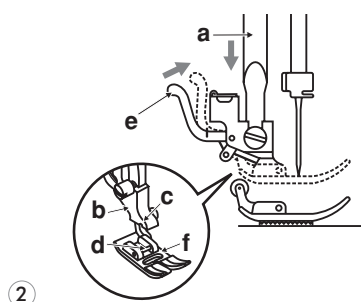

2 Attaching the presser foot
Lower the presser foot holder (b) until the cut-out (c) is directly above the pin (d). Raise the lever (e). Lower the presser foot holder (b) and the presser foot (f) will engage automatically.

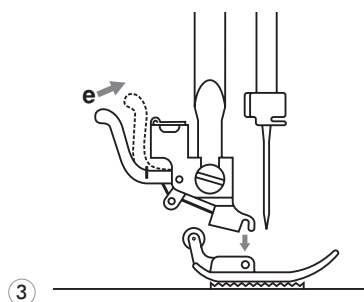

3 Removing the presser foot
Raise the presser foot. Raise the lever (e) and the foot will disengage.

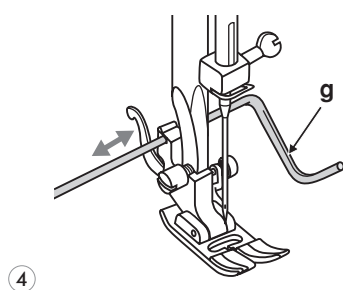

4 Attaching the edge/quilting guide
The edge/quilting guide (g) can be attached as illustrated. Adjust as needed for hems, pleats, quilting, etc.

PRESSER FOOT CHART

(The twin needle can be used for some stitches, offering more stitching options. For more information, go to the section: USING THE TWIN NEEDLE)

PRESSER FOOT	APPLICATION	NEEDLE	PRESSER FOOT	APPLICATION	NEEDLE
<p>All purpose foot (T)</p>	General sewing, Patchwork stitches, Decorative stitching, Smocking, Fagoting, etc.		<p>Satin stitch foot (A)</p>	Satin stitch sewing	
<p>Zipper foot (I)</p>	Inserting zippers				
<p>Buttonhole foot (D)</p>	Buttonhole sewing, Darning-stitch sewing		<p>Quilting foot (P) (Optional)</p>	Quilting	
<p>Cording foot (M) (Optional)</p>	Cording		<p>Darning/ Embroidery foot (Optional)</p>	Free-motion darning, embroidery, monogramming	
<p>Overcasting foot (E)</p>	Overcasting		<p>Gathering foot (Optional)</p>	Gathering	
<p>Blind hem foot (F)</p>	Blind hem stitching		<p>Button sewing foot</p>	Button sewing	
<p>Rolled hem foot (K) (Optional)</p>	Narrow hemming		<p>Walking foot (Optional)</p>	This foot helps to prevent uneven feeding of quilt layers, napped fabrics, and difficult- to-handle fabrics.	



NEEDLE, FABRIC, THREAD SELECTION GUIDE

NEEDLE SIZE	FABRICS	THREAD
9-11 (70-80)	Lightweight fabrics-thin cottons, voile, serge, silk, muslin, interlocks, cotton knits, tricot, jerseys, crepes, woven polyester, shirt & blouse fabrics.	Light-duty thread in cotton, nylon, polyester or cotton wrapped polyester.
11-14 (80-90)	Medium weight fabrics-cotton, satin, sailcloth, double knits, lightweight woolen.	Most threads sold are medium size and suitable for these fabrics and needle sizes. Use polyester threads on synthetic materials and cotton on natural woven fabrics for best results. Always use the same thread on top and bottom.
14 (90)	Medium weight fabrics-cotton duck, woolen, heavier knits, terrycloth, denims.	
16 (100)	Heavyweight fabrics-canvas, woolens, outdoor tent and quilted fabrics, denims, upholstery material (light to medium).	
18 (110)	Heavy woolens, overcoat fabrics, upholstery fabrics, some leathers and vinyls.	Heavy duty thread, carpet thread.



Please Note:

- In general, fine threads and needles are used for sewing fine fabrics, and thicker threads are used for sewing heavy fabrics.
- Always test thread and needle size on a small piece of fabric which will be used for actual sewing.
- Use the same thread for needle and bobbin.

REPLACING THE NEEDLE

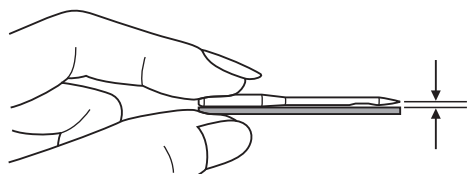
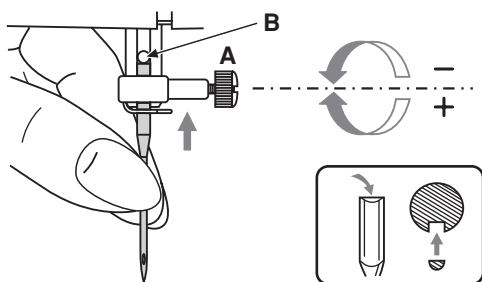

Attention: Turn power switch of off ("O") position when carrying out any of the operations shown below.

Change the needle regularly, especially if it is showing signs of wear and causing problems.

Insert the needle following the illustrated instructions.

A. Loosen the needle clamp screw and tighten again after inserting the new needle.

The flat side of the shaft should be towards the back.

B. Insert the needle as far up as it will go.

Needles must be in perfect condition.

Problems can occur with:

- Bent needles
- Blunt needles
- Damaged points

RAISE OR LOWER THE FEED DOGS

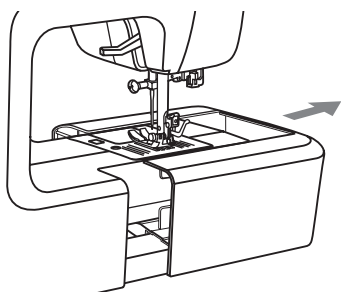

With the sewing table off the machine, the feed dogs adjustment lever can be seen on the base in back of the sewing machine.

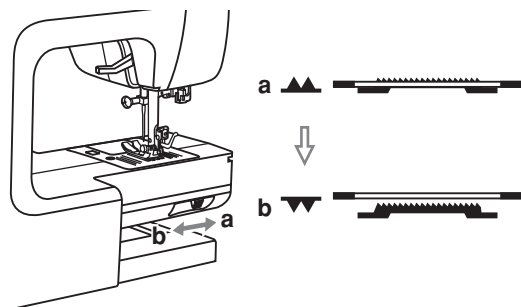

Sliding the lever to the "▼" (b) will lower the feed dog, for example during button sewing. If you wish to continue sewing normally, slide the lever to the "▲" (a) in order to raise the feed dogs.

The feed dogs will not raise up if you do not turn the handwheel, even if the lever is slid to the right. Make a complete turn (one full revolution of the handwheel) to raise the feed dogs.



OPERATION BUTTONS

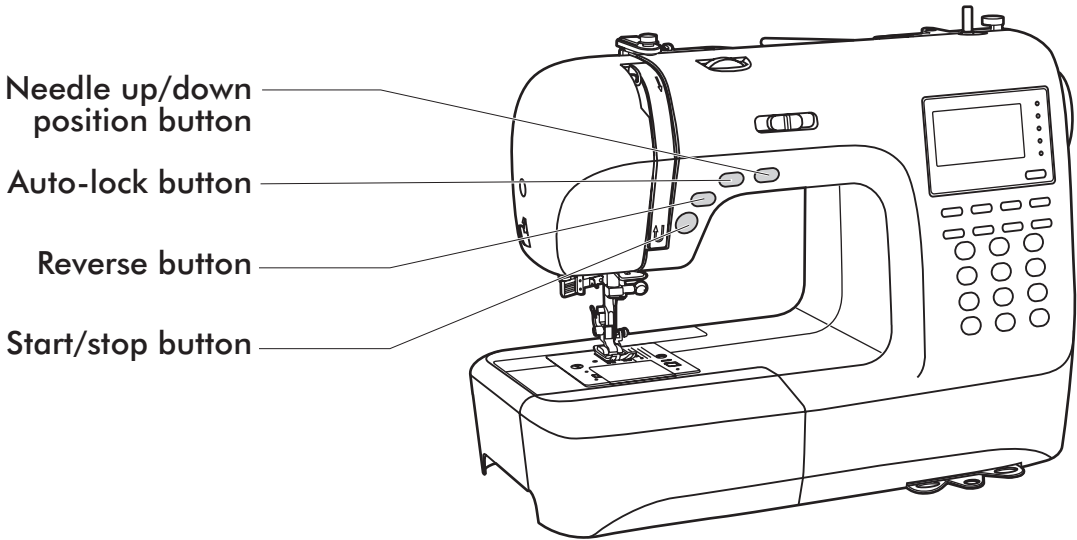

● Start/stop button

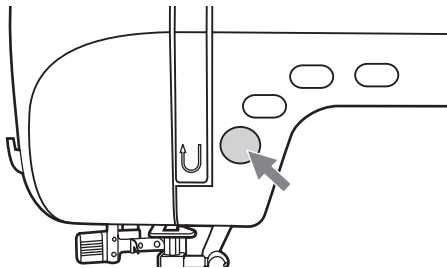

The machine will start running when start/stop button is pressed and will stop when pressed the second time. The machine will rotate slowly at the beginning of sewing.

The sewing speed will increase slowly until reaching the speed setting selected with the speed limiting adjustment lever.

The foot control must be disconnected to complete this operation.

● Reverse button

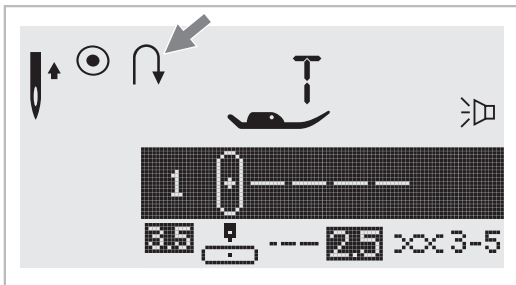

Select Direct Patterns 1-5, or A Group Pattern 00 and the machine will sew in reverse. An arrow "↵" on the LCD screen display appears while stitching in reverse. The machine will sew forward after the button is released.

If you press and reverse the button before starting to sew, the machine will permanently sew in reverse. Press the button again to sew forward again.

Select Direct patterns 6-9, A Group Patterns 01-13, 28-99, and B Group Patterns 00-99 a reinforcement stitch sews at a low speed and machine automatically stops if the reverse button is pressed.

● Auto-lock button

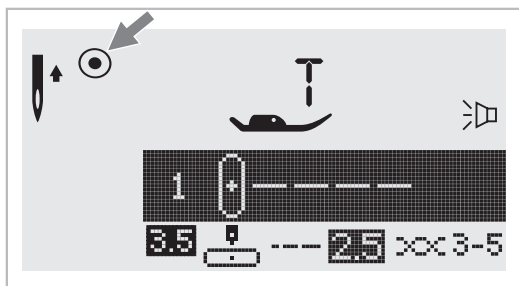

When Direct Patterns 1-4, and A Group Pattern 00 are selected, the machine will immediately sew 3 locking stitches when the Auto-lock button is pressed, then automatically stop.

The LCD screen will display the figure "⊙" until the machine is stopped.

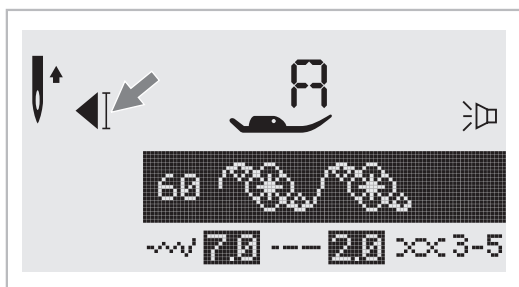

When Direct Patterns 5-9, A Group Patterns 01-13, 28-99, and B Group Patterns 00-99 are selected, press the Auto-lock button, the machine will sew 3 locking stitches at the end of the current pattern and automatically stop.

The function will be cancelled if you press the button once again or select another pattern.

The LCD screen will display the figure "◀" until the machine is stopped.

● Needle up/ down position button

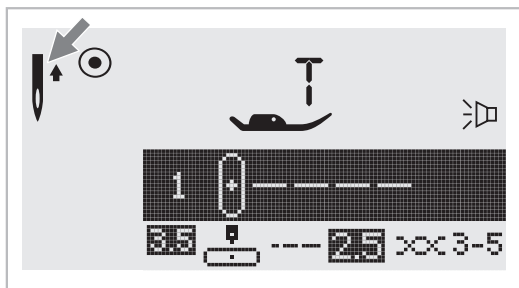

With the Needle up/ down position button, you decide whether the needle shall stop in the up position or in the material when you stop sewing.

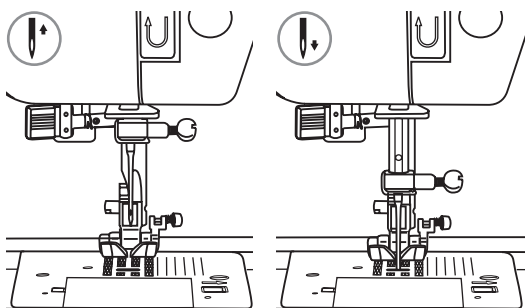

When you press the button so that the arrow (which displays just to the right of the needle icon on the LCD screen) will point upward, the needle will stop in the highest position.

When you press the button so that the arrow (which displays just to the right of the needle icon on the LCD screen) points downward, the machine will stop with the needle in the lowest position.

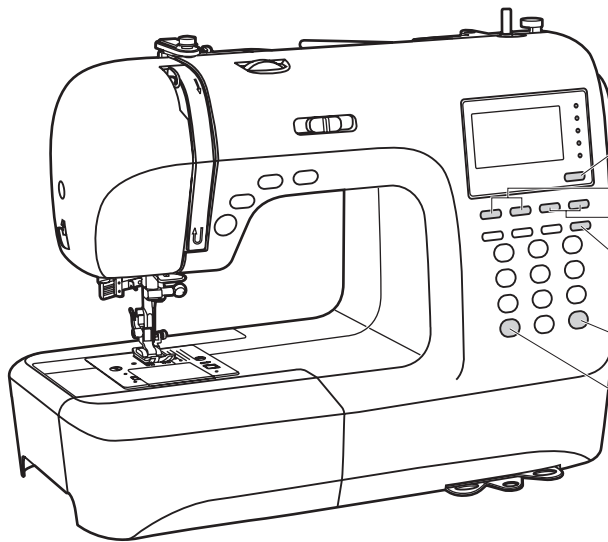
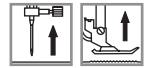

- Mode selection button
- Stitch width adjustment buttons
- Stitch length adjustment buttons
- Twin needle button
- Mirror button
- Elongation button

● Stitch width adjustment button

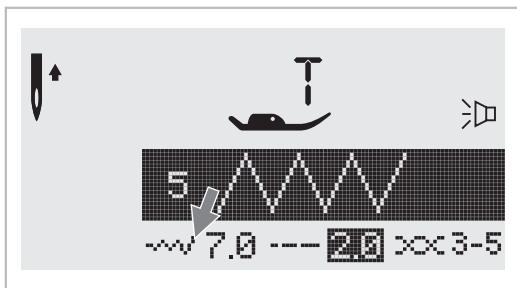

When you select a stitch, the machine will automatically set the recommended stitch width, which will be indicated by numbers on the LCD screen. The stitch width can be regulated by pressing the stitch width adjustment buttons.

Certain stitches have a limited stitch width.

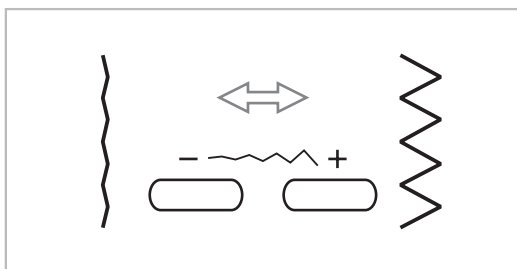

For a narrower stitch, press the "-" button (left). For a wider stitch, press the "+" button (right).

The stitch width can be adjusted between "0.0-7.0".

Certain stitches have a limited stitch width.

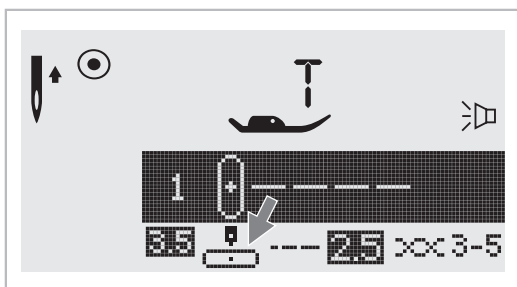

When Direct Patterns 1-4, and A Group Pattern 00 are selected, the needle position is regulated by the stitch width adjustment buttons. Pressing the "-" button (left), will move the needle to the left and pressing the "+" button (right), will move the needle to the right. The numbers will be changed from left position "0.0" to extreme right position "7.0". The pre-set center needle position will be indicated as "3.5".

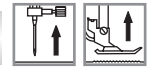

● Stitch length adjustment buttons

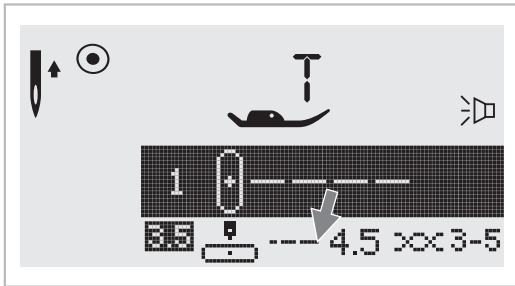

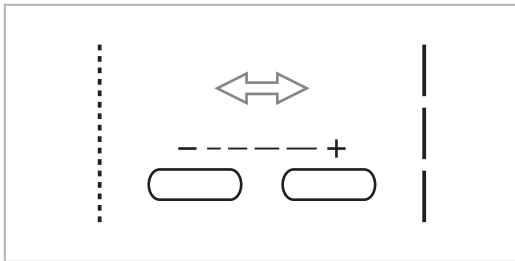

When you select a stitch the machine will automatically set the recommended stitch length which will be indicated by numbers on the LCD screen. The stitch length can be adjusted by pressing the stitch length adjustment buttons.





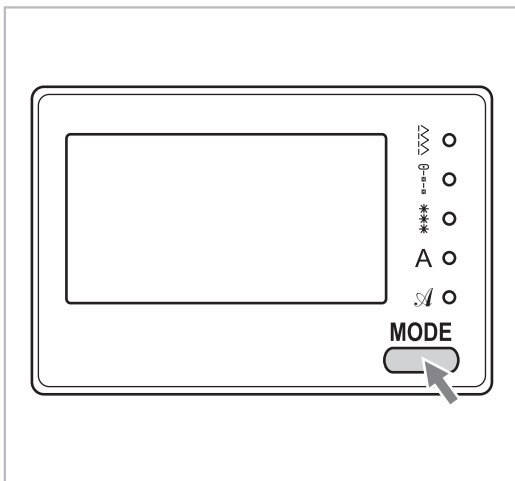

To shorten the stitch length, press the " - " button (left). For a longer stitch length, press the "+" button (right). The stitch length can be adjusted between "0.0-4.5". Certain stitches have a limited length.

● MODE selection button



The LED light will be set at direct mode "  " when start the machine. By pressing the button, LED light will move step by step to select the stitch mode, as shown.

-  **Direct mode stitch selection.**
-  **Utility and satin pattern mode:**
Stitch selection using number buttons.
-  **Decorative pattern mode:**
Character selection using number buttons.
- A Block letter mode:**
Character selection using number buttons.
-  **Script letter mode:**
Character selection using number buttons.

● Elongation button (see page 59)

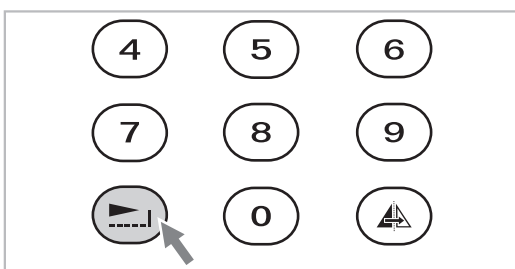

A Group Patterns 28-51 can be elongated up to five times its normal length by pressing the "  " button.

When the width or length or stitch is changed, a greater variety of patterns are available.

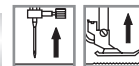

● **Mirror button** (see page 60)

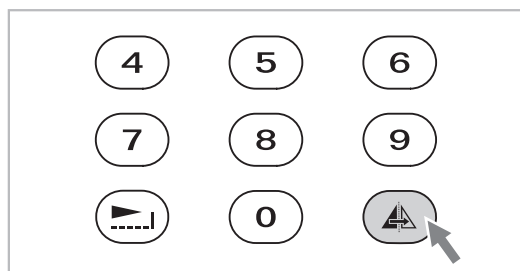

The Direct Patterns 1-9, A Group Patterns 00-13, 28-99, and B Group Patterns 00-99 can be mirror imaged along a vertical axis by pressing the "▲" button. The machine will continue to sew the reflected pattern until the mirror button is pressed again. The mirror function also will be canceled if the pattern changed.

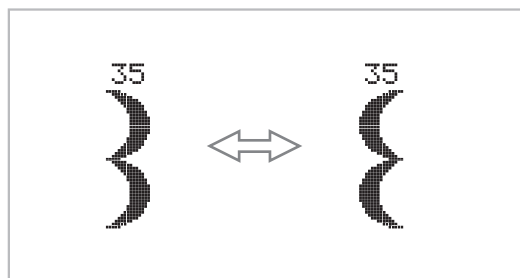

The function for mirror imaging the pattern appears on the LCD screen.

● **Twin needle button** (see page 61)

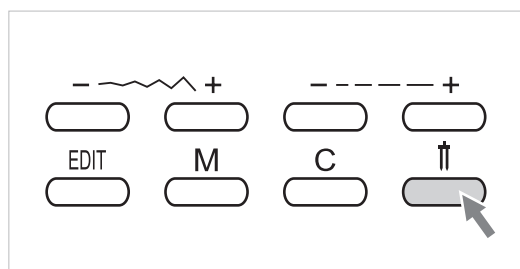

With the twin needle, the Direct Patterns 1-9, A Group Patterns 00-13, 28-99, and B Group Patterns 00-99 can be sewn in two parallel lines of the same stitch with two different threads.

Press the "‡" button, the machine automatically reduces the maximum width for twin needle sewing. Press the button again for single needle sewing.

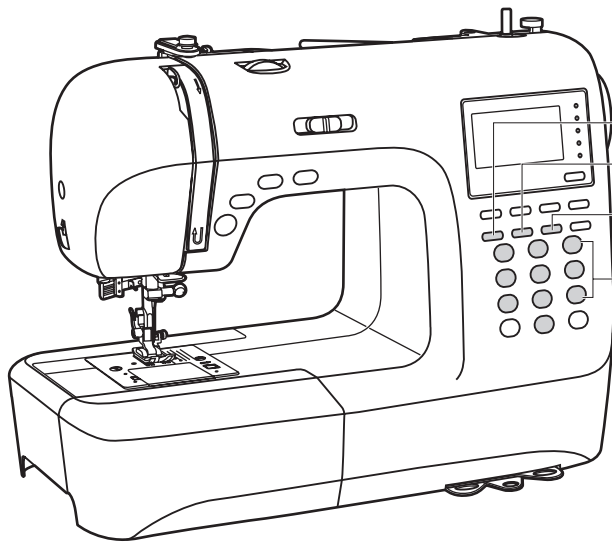
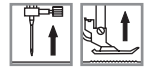

- Edit button
- Memory button
- Clear button
- Direct pattern selection and number buttons

● Direct pattern selection and number buttons

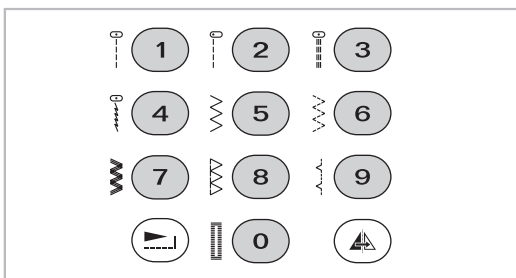

Direct pattern selection

Press the buttons to select the utility patterns shown beside the number button when the mode button is set at the Direct mode.

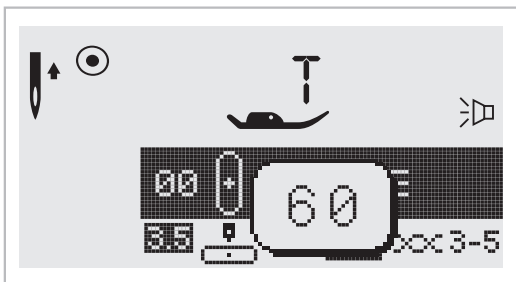

Number buttons

To select the desired pattern and press the number buttons .

Except the Direct Pattern mode, the other mode can be selected by pressing the desired numbers.

For example: pattern 60

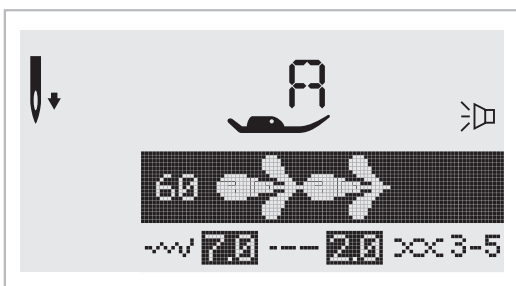

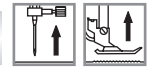

● Edit button

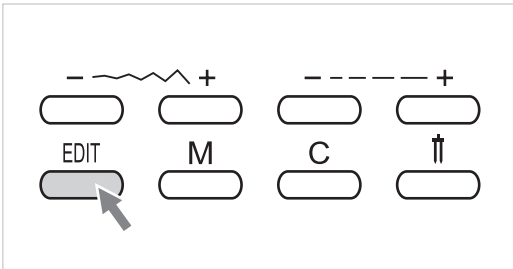

If you wish to modify any settings in the memory mode, use the stitch width " + " or " - " button to select the pattern to be modified, and press the " EDIT " button to set the selected pattern under the editing mode, the LED light will turn on. Manual setting function of the stitch width, stitch length, mirror, elongation and auto-lock for these memorized patterns is now possible. Press the " EDIT " button again to leave the editing mode and return to memory mode.

● Memory button

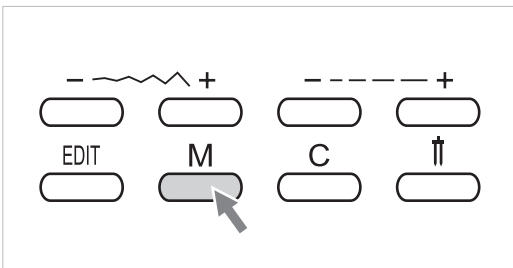

Press the " M " button to enter the memory mode, and store the combinations of characters or decorative stitches. Use the stitch width " + " or " - " button to confirm the pattern memorized by pressing this button in memory mode.

 **Please Note:** The Direct mode patterns and the A Group Patterns 14-27 cannot be memorized.

● Clear button

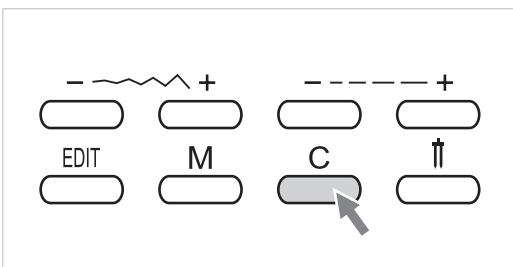

Press this button when the incorrect character is selected. Each press of this button erases one character, or press this button to remove an added pattern when sewing combinations of characters or decorative stitches.

● **Sewing corners**

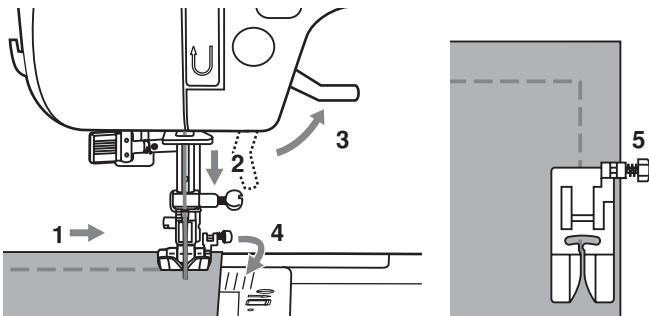

1. Stop the sewing machine when you reach a corner.
2. Lower the needle into the fabric manually or by pressing the needle up/ down button once.
3. Raise the presser foot.
4. Use the needle as a pivot and turn the fabric.
5. Lower the presser foot and resume sewing.

● **Reverse**

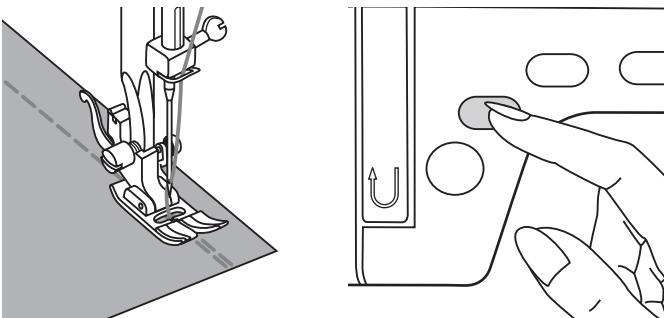

Reverse stitching is used to secure the threads at the beginning and at the end of a seam.

Press the reverse button and sew 4-5 stitches.

The machine will sew forward when the button is released.

● **Free arm**

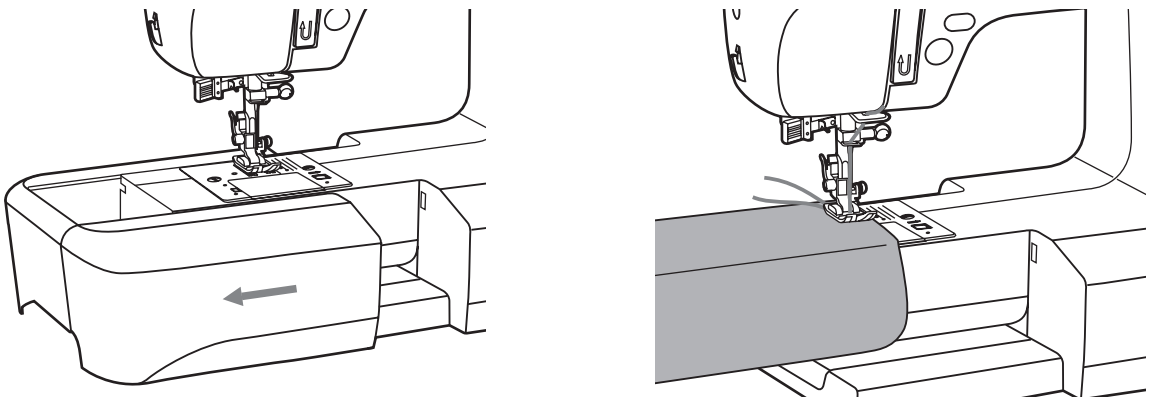

Free-arm sewing is convenient for sewing tubular areas such as pant hems and cuffs.

● **Installing the extension table**

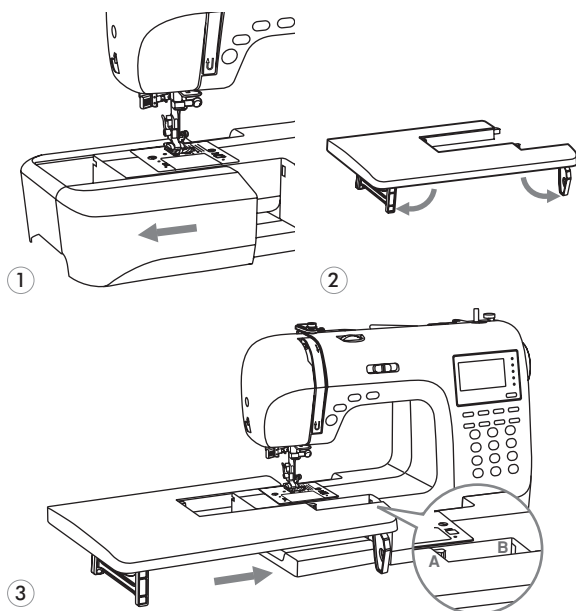

* The Extension Table is an optional accessory.

1. Pull the sewing table and accessory box off by sliding it to the left.
2. Follow the arrow, and stretch the foot of the extension table.
3. Snap (A) of the extension table into (B) of the machine.

● **Sewing on heavy fabrics**

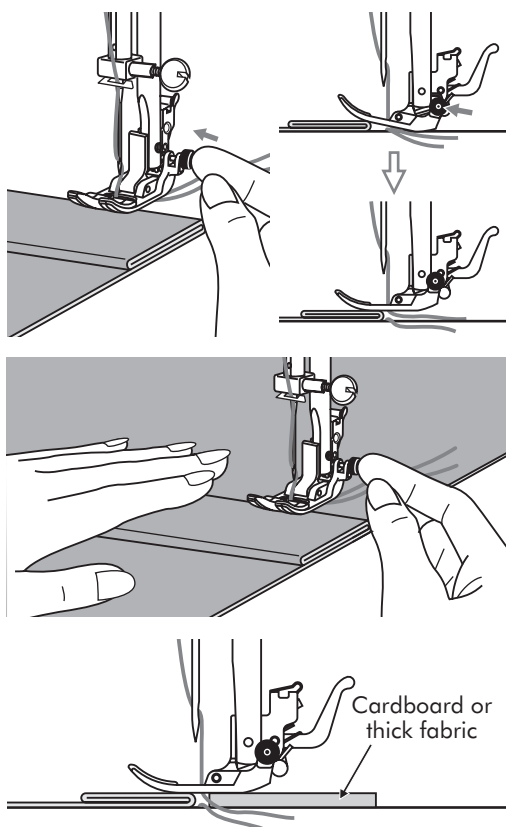

The black button on the left side of the all purpose presser foot will lock the presser foot in a horizontal position if you push it in before lowering the presser foot. This ensures even feeding at the beginning of a seam and helps when sewing multiple layers of fabric such as sewing over seams when hemming jeans.

When you reach the point of an increased thickness, lower the needle and raise the presser foot. Press the toe of the foot and push in the black button, then lower the foot and continue sewing.

The black button releases automatically after sewing few stitches.

You also can place another piece of fabric with the same thickness at the back of the seam. Or support the presser foot while feeding by hand and sewing toward the folded side.

NEEDLE POSITION AND STITCH LENGTH

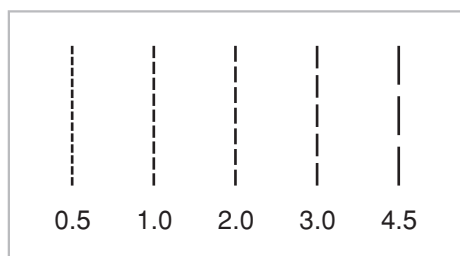
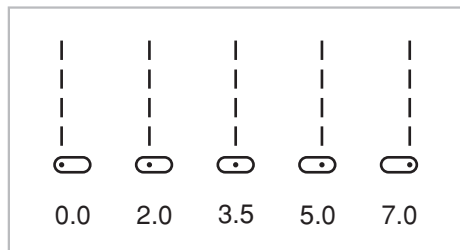
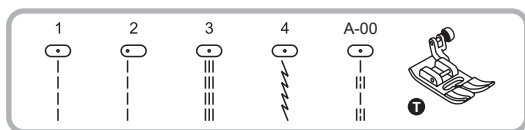

Changing the needle position

These settings apply only to Direct Patterns 1-4, or A Group Pattern 00. The pre-set position is "3.5", center position. When you press the "-" of stitch width adjustment button, the needle position will be moved to the left. When you press the "+" of stitch width adjustment button, the needle position will be moved to the right. On the LCD screen, the point illustration and the number indicate the needle position.

Changing the stitch length

To shorten the stitch length, press the "-" of stitch length adjustment button. For a longer stitch length, press the "+" of stitch length adjustment button.

Generally speaking, the thicker the fabric, thread and needle, the longer the stitch should be.

ZIGZAG STITCHES

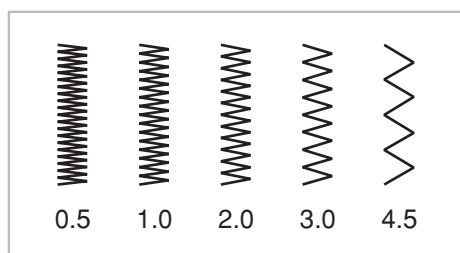
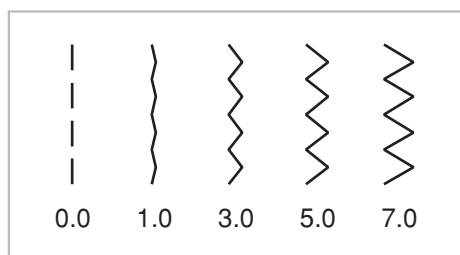
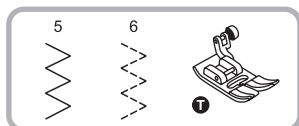

Adjusting the stitch width

The maximum zigzag stitch width for zigzag stitching is "7.0"; however, the width can be reduced on any patterns. The width increases as you press the "+" of stitch width adjustment button from "0.0-7.0".

Adjusting the stitch length

The density of zigzag stitches increase as the setting of stitch length approaches "0.3".

Neat zigzag stitches are usually achieved at "1.0-2.5". Closed up zigzag stitches (close together) are referred to as a satin stitch.

STRETCH STITCHES

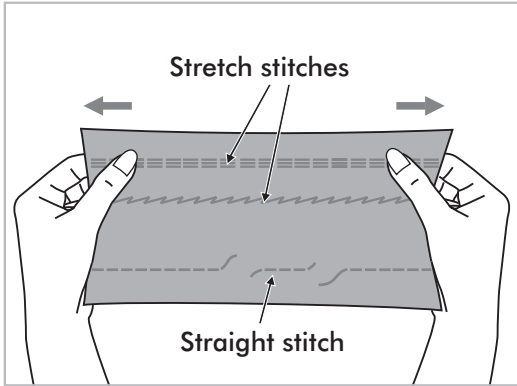
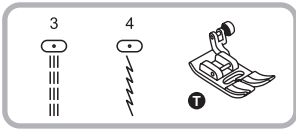

Stretch stitches are strong and flexible and will give with the fabric without breaking. Good for easy to ravel and knit fabrics. It is good for joining durable fabric such as denims.

These stitches can also be used as a decorative top stitch.

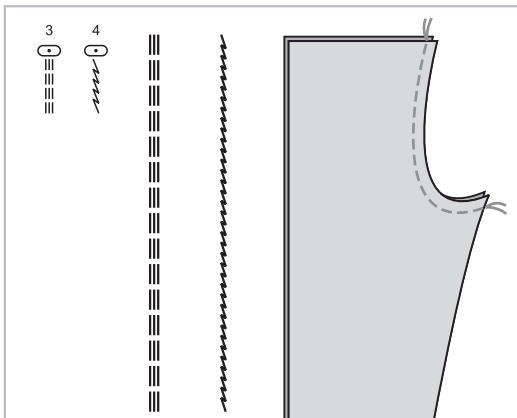

Straight stretch stitch is used to add triple reinforcement to stretch and hardwearing seams.



OVERCASTING STITCHES

● Using the overcasting foot

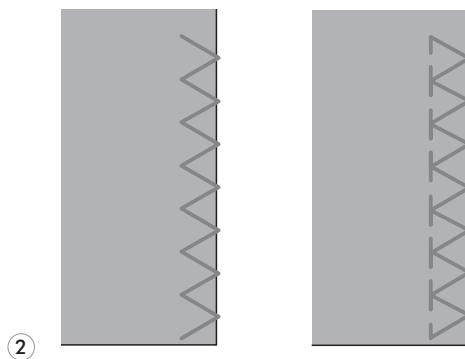
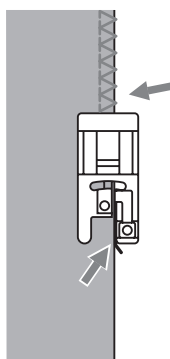
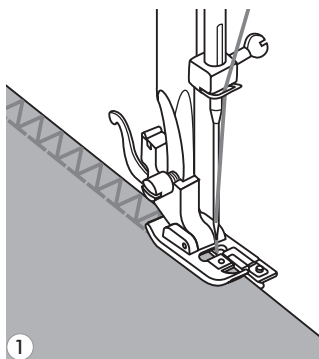
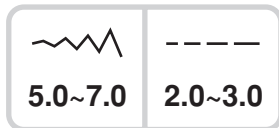
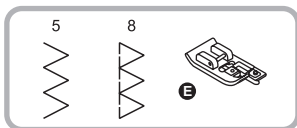

1 Change the presser foot to the overcasting foot.

2 Sew the fabric with the fabric edge against the guide of the overcasting foot.

! **Attention:** The overcasting foot should be used to sew with Direct Patterns 5 and 8 only. Do not set the stitch with narrower than "5.0", as it is possible that the needle could hit the presser foot and break when sewing other patterns and width settings.

● Using the all purpose foot

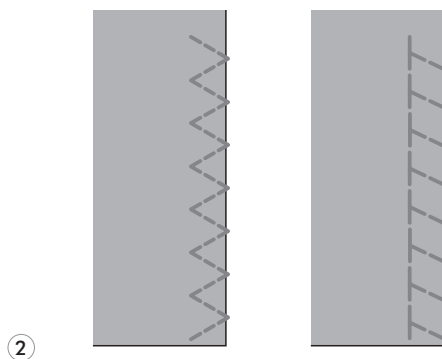
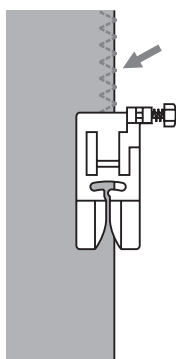
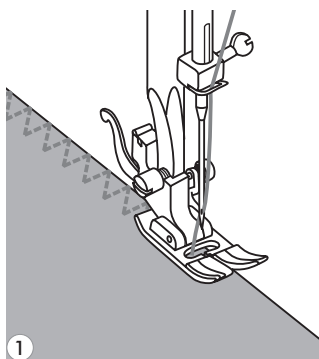
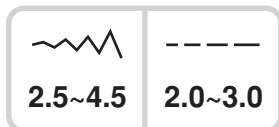
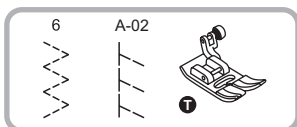

1 Change the presser foot to the all purpose foot.

2 Sewing the overcasting along the edge of the fabric so that the needle drops over the edge of the fabric on the right side.

BLIND HEMS

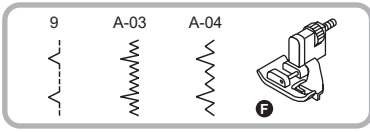

9: Blind hem for woven fabrics
 A-03: Blind hem for stretch fabrics
 A-04: Blind hem for stretch fabrics

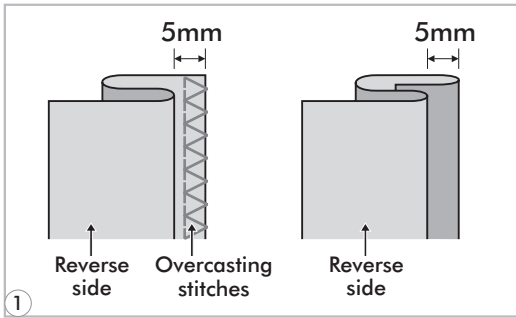

Please Note: It takes practice to sew blind hems. Always make a sewing test first.

1 Fold the fabric as illustrated with the wrong side uppermost.

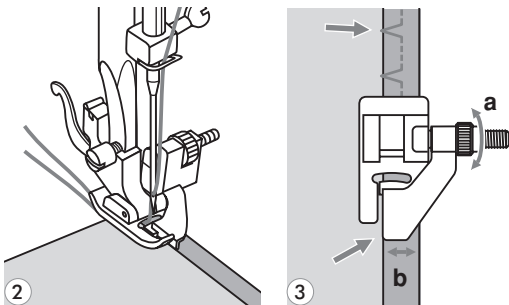

2 Place the fabric under the foot. Turn the handwheel counter-clockwise by hand until the needle swings fully to the left. It should just pierce the fold of the fabric. If it does not, adjust the stitch width accordingly.

3 Adjust the guide (b) by turning the knob (a) so that the guide just rests against the fold.

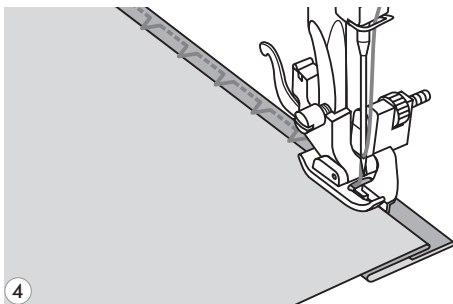

4 Sew slowly, guiding the fabric carefully along the edge of the guide.

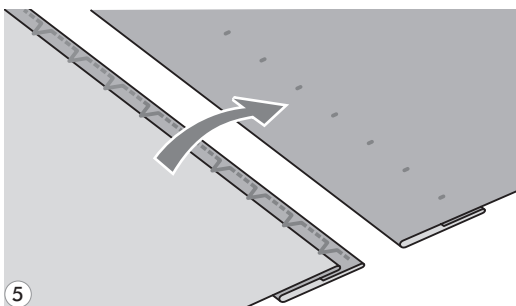

5 Turn over the fabric.



BUTTON SEWING

25



2.5~4.5

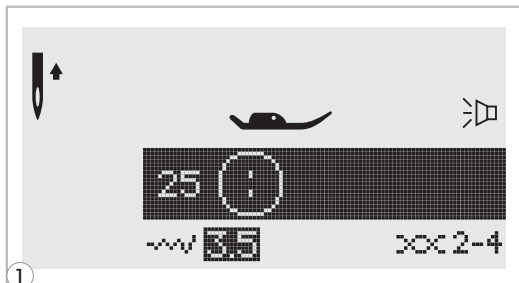

1 Select the pattern 25 from the Group Patterns "A" to get the button sewing stitch. Change the presser foot to the button sewing foot.

Move the drop feed lever to "▼" to lower the feed dogs.

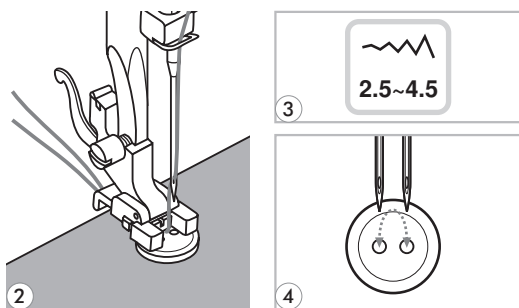

2 Position the work under the foot. Place the button in the desired position, lower the foot.

3 Adjust the stitch width to " 2.5-4.5 " according to the distance between the two holes of the button.

4 Turn the handwheel to check that the needle goes cleanly into the left and right holes of the button.

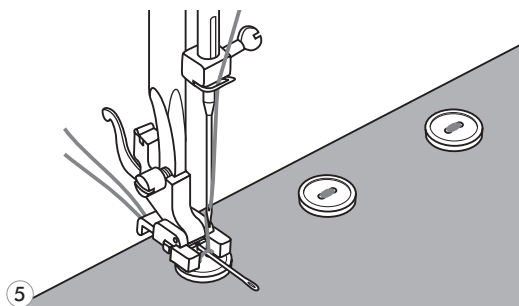

5 Before sewing, press the Auto-lock button to sew reinforcement stitches automatically at the beginning and at the end of the stitch.



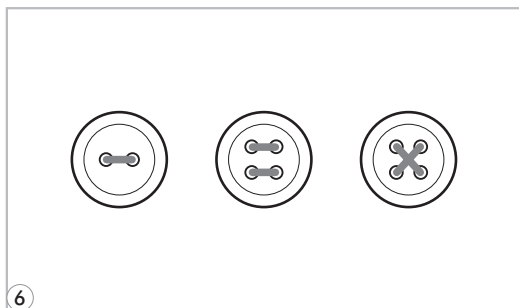

If a shank is required, place a darning needle on top of the button and sew.

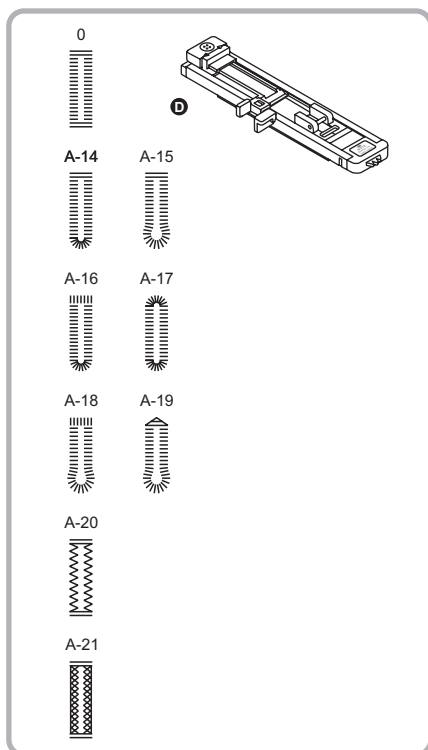

6 For buttons with 4 holes, sew through the front two holes first, push work forward and then sew through the back two holes.

BUTTONHOLE SEWING



	----	0: For light to medium weight fabrics
2.5~7.0	0.3~1.0	A-14: For light or medium weight fabrics
	----	A-15: For light or medium weight fabrics
3.0~7.0	0.3~1.0	A-16: For heavier weight fabrics
	----	A-17: For light or medium weight fabrics
2.5~5.5	0.3~1.0	A-18: For heavy weight fabrics
	----	A-19: For jeans or trousers
5.5~7.0	0.3~1.0	A-20: For jeans or stretch fabric with a coarse weave
	----	A-21: For stretch fabric
3.0~7.0	1.0~2.0	
	----	
3.0~7.0	1.0~3.0	

 **Please Note:** Before sewing a buttonhole on your project, practice on a scrap piece of the same type of fabric.

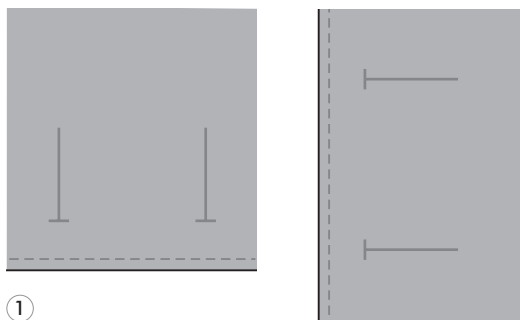

①

1 Mark the positions of the buttonhole on the fabric.

The maximum buttonhole length is 3cm (1 3/16 inch). (Total of diameter + thickness of button.)

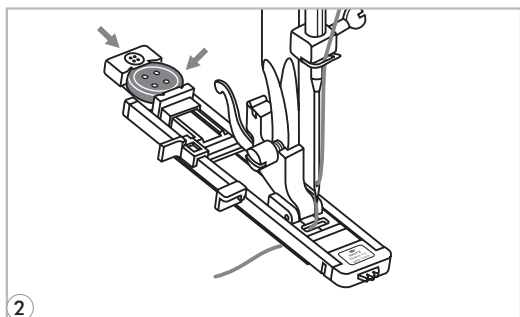

②

2 Attach the buttonhole foot, then pull out the button holder plate and insert the button. The size of the buttonhole is determined by the button inserted in the button plate.

The thread should be passed through the hole in the presser foot, then be placed under the foot.

BUTTONHOLE SEWING

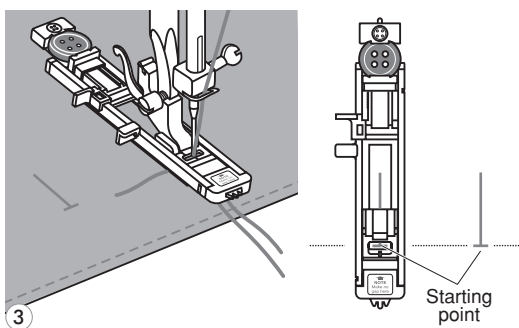

- 3 Select the buttonhole stitch. Adjust the stitch width and the stitch length to the desired width and density.

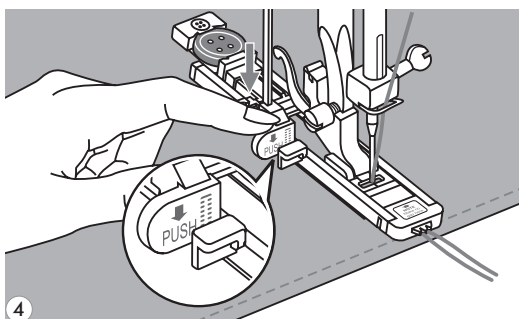

- 4 Position the fabric under the presser foot so that the centerline's mark is aligning with the center of the buttonhole foot.
Lower the buttonhole lever, making sure it is positioned behind the bracket on the buttonhole foot, as illustrated.

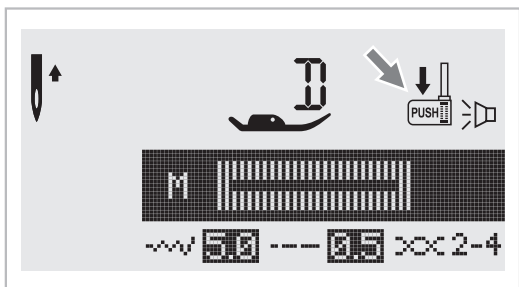

- Please Note:** When you select any buttonhole pattern, the LCD screen will display the figure "  ", to remind you to lower the buttonhole lever.

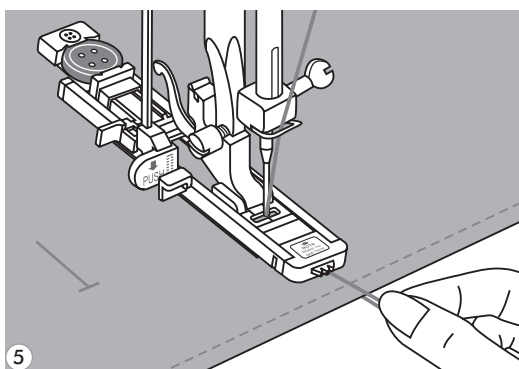

- 5 While lightly holding the end of upper thread and start sewing.



BUTTONHOLE SEWING

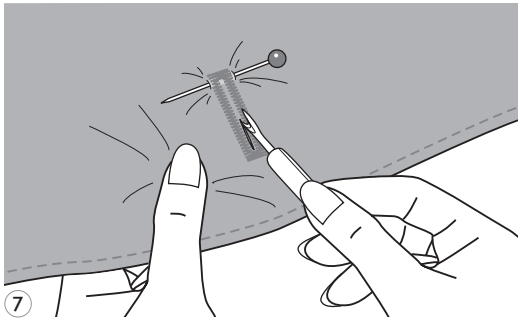
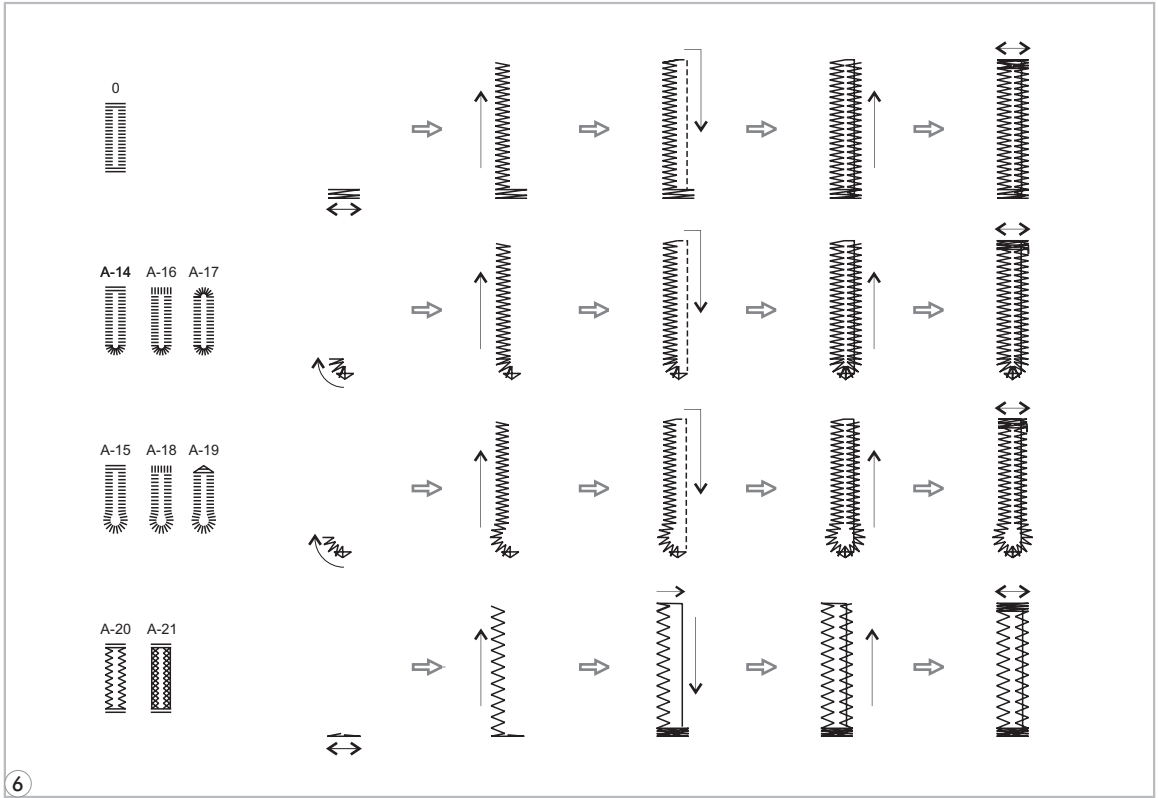

6 Buttonholes are sewn from the front of the presser foot to the back, as shown.

7 Cut the center of the buttonhole being careful not to cut any stitches on either side. Use a pin as a stopper at the bar tack so you do not cut too much.



BUTTONHOLE SEWING

● Making corded buttonholes

When sewing corded buttonholes, hook a heavy thread or cord under the buttonhole foot.

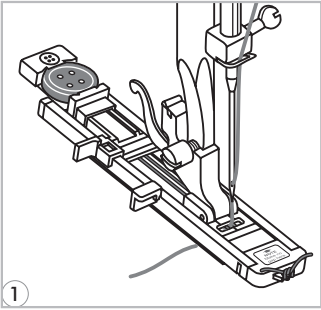

1 Attach the buttonhole foot and hook the gimp thread onto the back of the presser foot. Bring the two gimp thread ends to the front of the foot and insert them into the grooves, then temporarily tie them there. Lower the presser foot and start sewing.

Set the stitch width to match the diameter of the gimp thread.

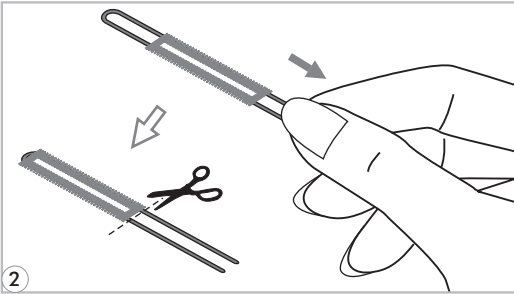

2 Once sewing is completed, pull the gimp thread gently to remove any slack, then trim off any excess.



Please Note: It is suggested that you use interfacing on the backside of the fabric.

BAR TACK STITCH

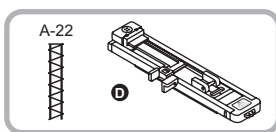

1.0~3.0	0.3~1.0

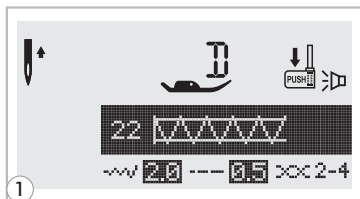

1 Select pattern 22 of from the Group Patterns "A" to get the bar tack stitch. Change the presser foot to the buttonhole foot.

2 Pull the button holder to the rear. Set the button guide plate on the buttonhole foot to the desired length.

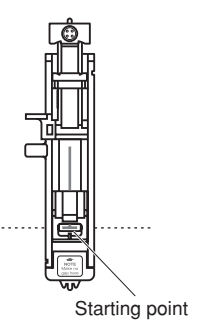
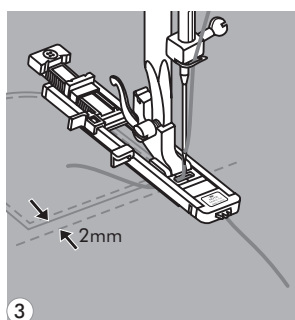

3 Position the fabric so that the needle is 2mm (1/16") in front of where you want the sewing to start, and then lower the presser foot.

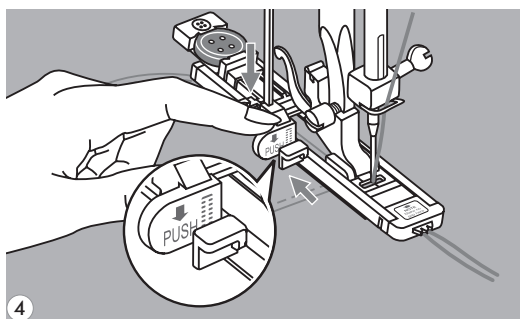

4 Pass the upper thread down through the hole in the presser foot. Pull down the buttonhole lever. The buttonhole lever is positioned behind the bracket on the buttonhole foot. Gently hold the end of the upper thread in your left hand, and then start sewing.

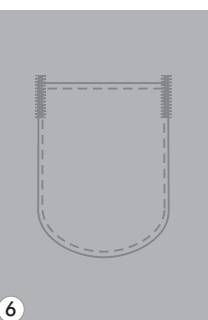
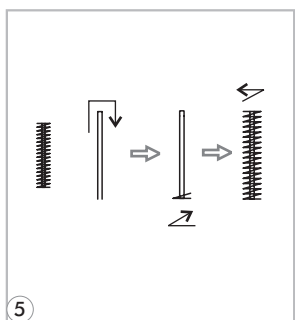

5 Bar tack stitches are sewn.

6 As an example, the illustration shows the procedure for sewing bar tacks at pocket corners.

EYELET STITCH

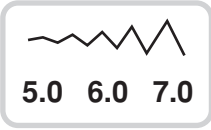
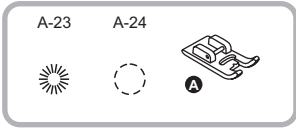

A-23: Select for sewing eyelets on belts , etc
 A-24: Select for sewing eyelets on belts , etc

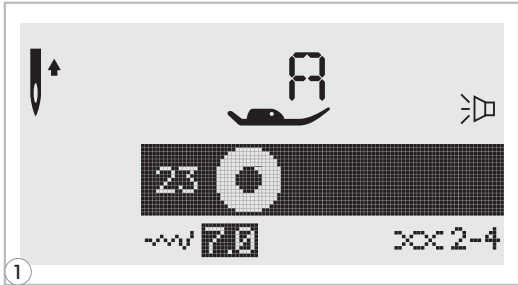

1 Select pattern 23 or 24 from the Group Patterns "A" to get the eyelet stitch. Attach presser the foot "A".

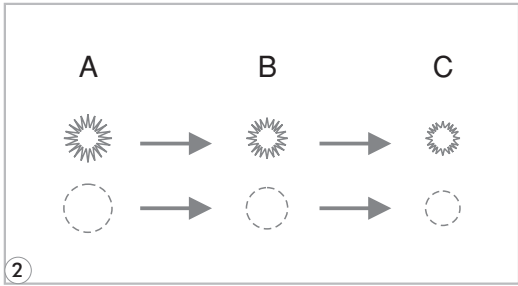

2 Press the " - " or " + " stitch width adjustment to button select the eyelet size.
 Size of eyelet.
 A. Large: 7.0mm (1/4 inch).
 B. Medium: 6.0mm (15/64 inch).
 C. Small: 5.0mm (3/16 inch).

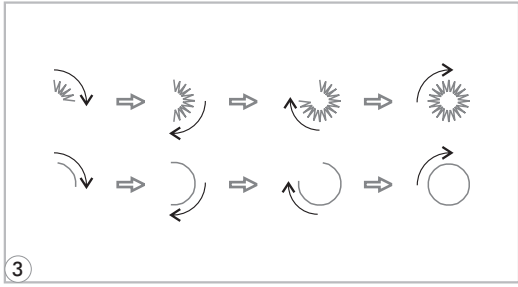

3 Lower the needle into the fabric at the beginning of the stitching, and then lower the presser foot lever.
 Once sewing is completed, the machine automatically sews reinforcement stitches, then stops.

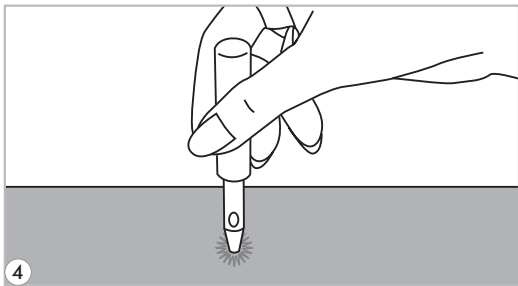

4 Make a hole at the center using an eyelet punch.
 *Eyelet punch is not included with the machine.

DARNING STITCH

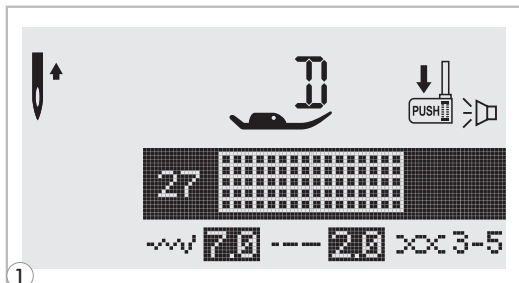
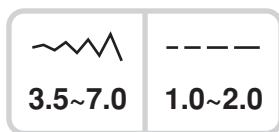
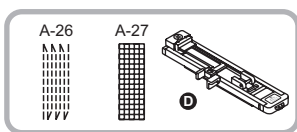

1 Select pattern 26 or 27 from the Group Patterns "A" to get the darning stitch. Change the presser foot to the buttonhole foot.

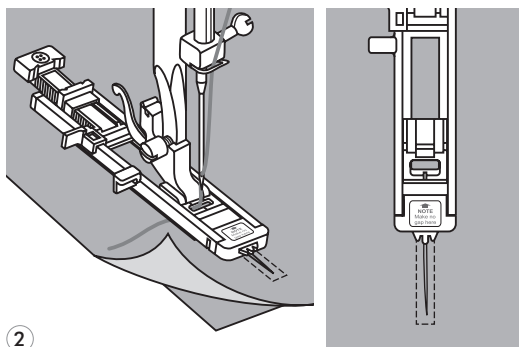

2 Baste the upper fabric and the reinforcement fabric together. Select the width of the pattern by using the stitch width button. Lower the presser foot over the center of the tear.

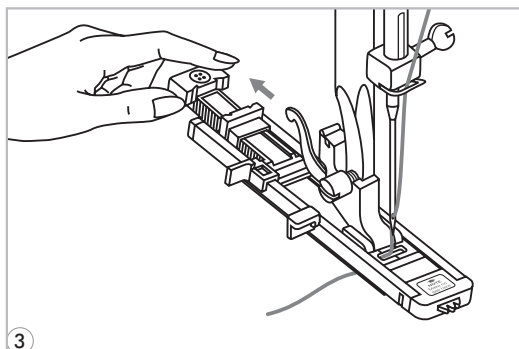

3 Pull the button holder to rear. Set the button guide plate on buttonhole foot to the desired length.

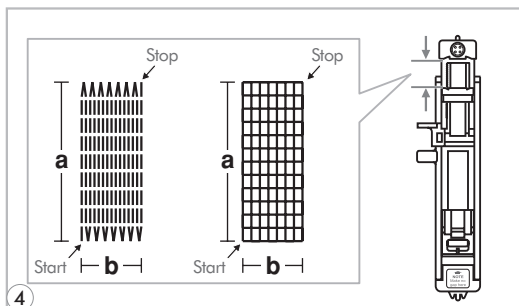

4 The size of the darning cycle is variable. However, the maximum stitch length is 2.6cm (1 inch) and the maximum stitch width is 7mm (9/32 inch).

- a. The length of darning pattern.
- b. The width of darning pattern.

DARNING STITCH

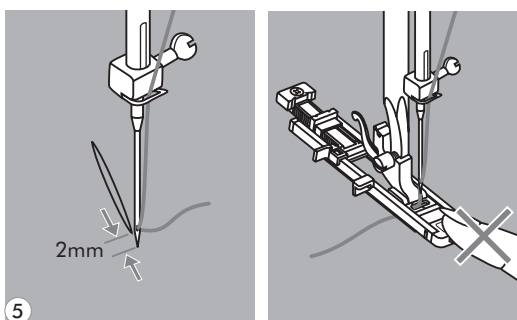

- 5** Position the fabric so that the needle is 2mm (1/16 inch) in front of the area to be darned, and then lower the presser foot lever.

Please Note: When lowering the presser foot, do not push in the front of the presser foot, otherwise the darning will not be sewn with the correct size.

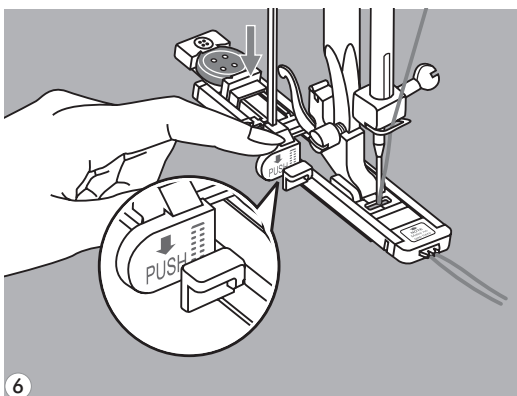

- 6** Pass the upper thread down through the hole in the presser foot. Pull down the buttonhole lever. The buttonhole lever is positioned behind the bracket on the buttonhole foot. Gently hold the end of the upper thread in your left hand, and then start sewing.

Please Note: When you select any buttonhole pattern or darning pattern, the LCD screen will display the figure "↓" to remind you to lower the buttonhole lever.

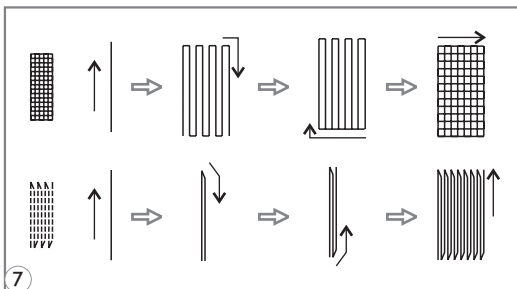

- 7** Darning stitches are sewn from the front of the presser foot to the back, as shown.

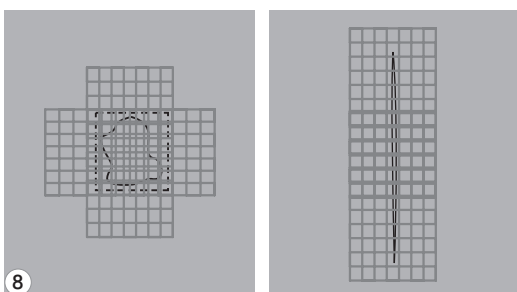

- 8** If the area to be sewn is large, you may sew several times across the area to achieve the desired result.

ZIPPER INSERTION

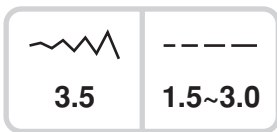
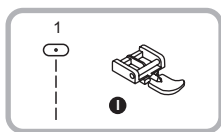

Attention: Zipper foot should be used with machine set for straight stitch in center needle position. It is possible that the needle could hit the presser foot and break when sewing other patterns.

● Inserting a centered zipper

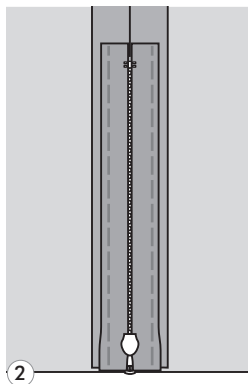
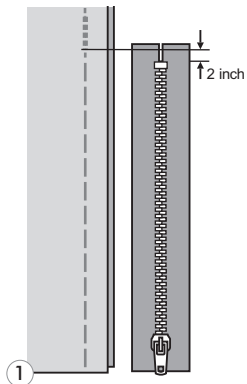

1 Baste the zipper opening on the garment.

2 Press open the seam allowance. Place the zipper face down on the seam allowance with the teeth against the seam line. Baste the zipper tape in place.

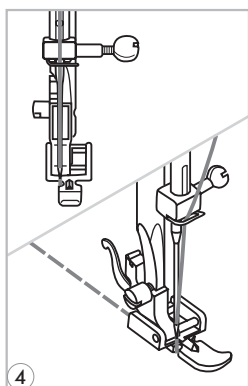
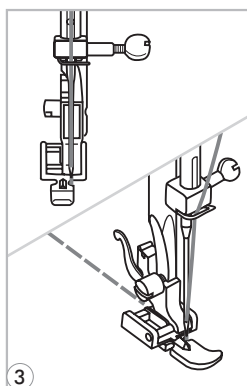

3 Attach the zipper foot. Attach the right side of the presser foot pin to the holder when sewing the left side of the zipper.

4 Attach the left side of the presser foot pin to the presser foot holder when sewing the right side of the zipper.

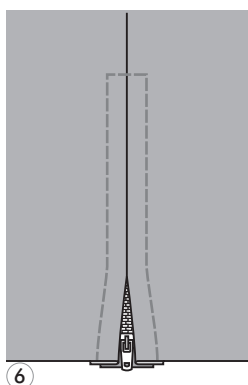
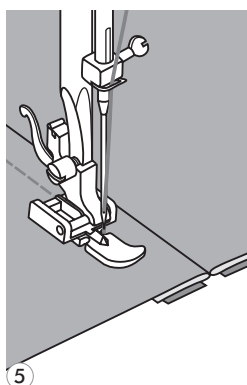

5 Stitch the left side of the zipper from the bottom of the zipper to the top.

6 Stitch across the lower end and right side of zipper. Remove the basting and press.

● Inserting a lapped zipper

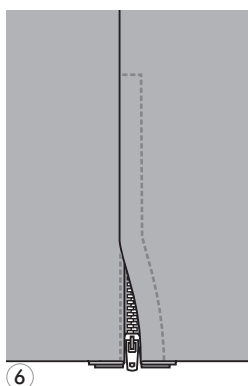
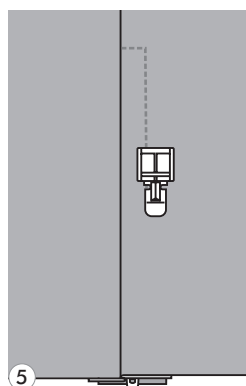
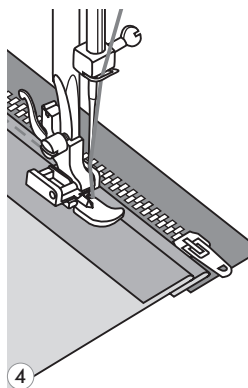
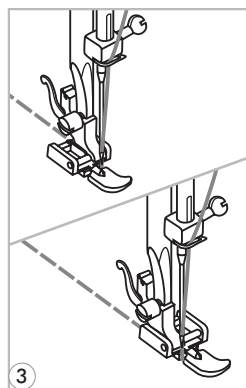
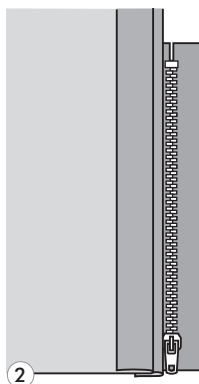
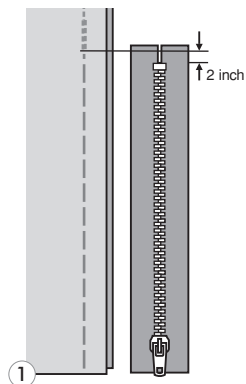

1 Baste the zipper opening on the garment.

2 Fold back to the left seam allowance. Turn under the right seam allowance to form 3mm (1/8 inch) fold.

3 Attach the zipper foot. Attach the right side of the presser foot pin to the holder when sewing the left side of the zipper. Attach the left side of the presser foot pin to the presser foot holder when sewing the right side of the zipper.

4 Stitch the left side of zipper from bottom to top.

5 Turn the fabric right side out, stitch across the lower end and right side of zipper.

6 Stop about 5cm (2 inches) from the top of zipper. Remove the basting and open the zipper. Stitch the remainder of the seam.

NARROW HEMMING

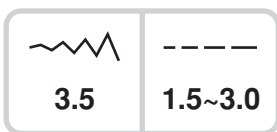
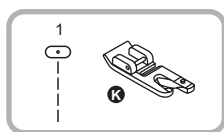

* The Rolled hem foot is an optional accessory.

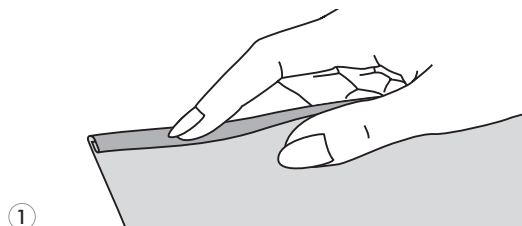

- 1** Fold the edge of the fabric over about 3mm (1/8 inch), then fold it over again 3mm (1/8 inch) for about 5cm (2 inches) along the edge of the fabric.

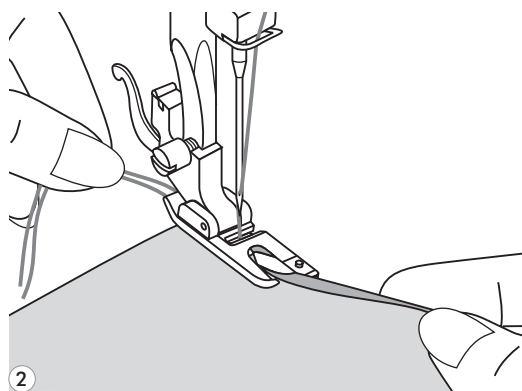

- 2** Insert the needle into the fold by rotating the handwheel toward you, and lower the presser foot. Sew several stitches and raise the presser foot.

Insert the fabric fold into the spiral opening of the rolled hem foot. Move fabric back and forth until the fold forms a scroll shape.

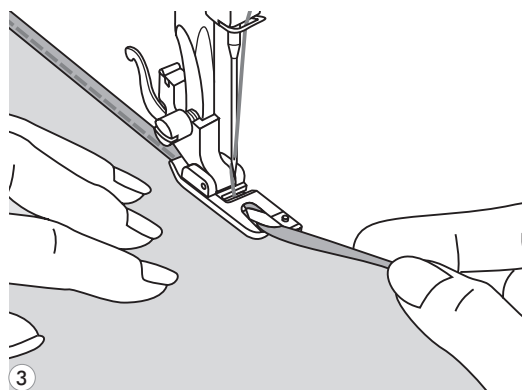

- 3** Lower the presser foot and start sewing, slowly guiding the raw edge of the fabric in front of the rolled hem foot, guiding it evenly into the scroll of the foot.

CORDING

Sew over one, two or three strands of cord to embellish fabrics. Pearl cotton, embroidery floss or fine wool yarn can be used for cording.

● Single cording

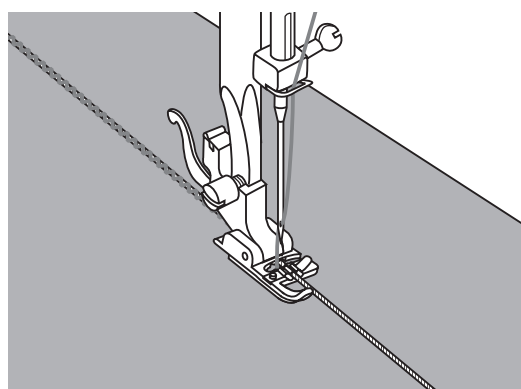
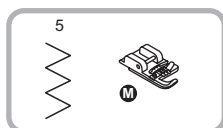

* The Cording foot is an optional accessory.

Mark the design on the fabric. Insert the cord in the center groove of the cording foot from the right side opening. Pull the cord about 5cm (2 inches) behind the foot.

The grooves of the foot will hold the length of the cord in place while the stitches are being formed over the cord.

Select the stitch and adjust the stitch width so that the stitches are just covering the cord. Lower the foot and sew slowly, guiding the cord over the design.

● Triple cording

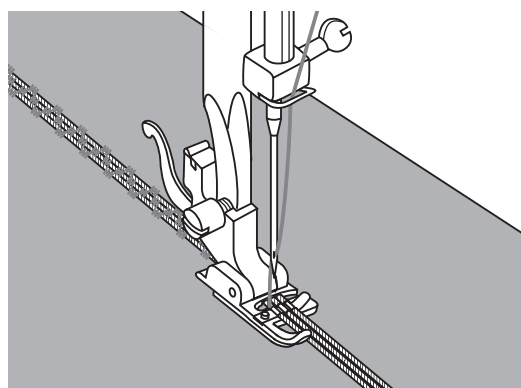
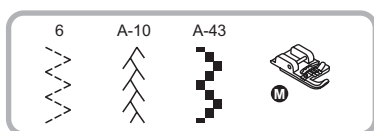

Push the sewing thread to the left and insert three cords into the grooves of the foot and pull about 5cm (2 inches) of the cords behind the foot. Select the desired pattern and adjust the stitch width so that the stitches are just covering the cords. Lower the foot and sew slowly guiding the cords.

SATIN STITCH SEWING

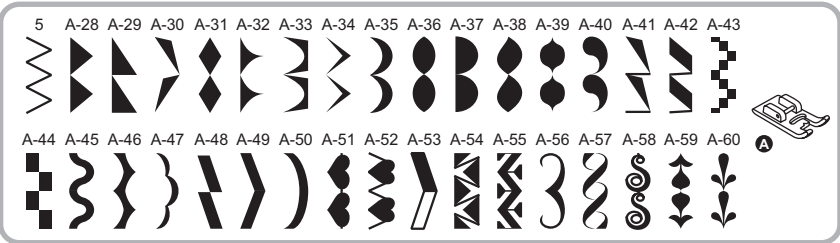

3.5~7.0	0.5~2.0

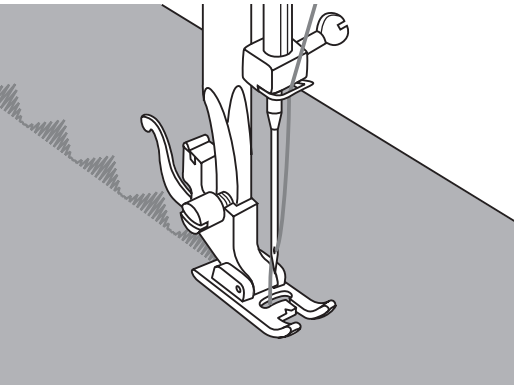

Use the satin stitch foot for satin stitching and sewing decorative stitches. This foot has a groove on the underside which allows dense stitching to pass freely underneath.

To change the satin or decorative stitch pattern, you may adjust the length and width of the pattern by pressing the stitch length and width adjustment buttons. Experiment by sewing on fabric scraps first, until you achieve the desired length and width.

 **Please Note:** When sewing very light weight fabrics, it is recommended that you use interfacing or stabilizer on the backside of the fabric.

EDGE/QUILTING GUIDE

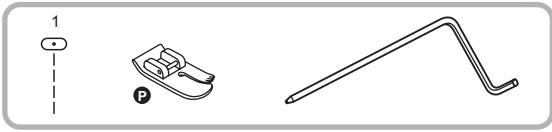

	
3.5	1.0~3.0

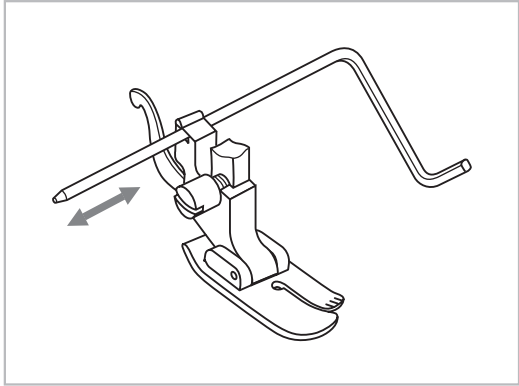

* The quilting foot is an optional accessory.

Insert the edge/quilting guide in the presser foot holder as illustrated and set the space as you desire.

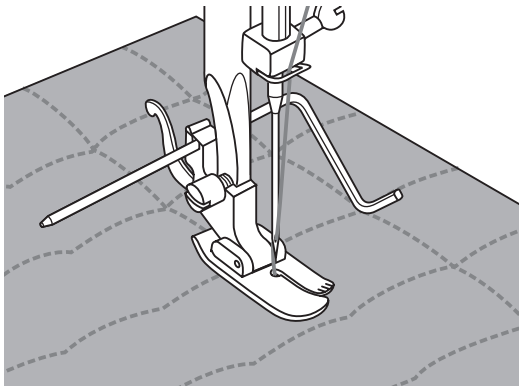

Sew the first row and move over the fabric to sew successive rows with the guide riding along the previous row of stitching.

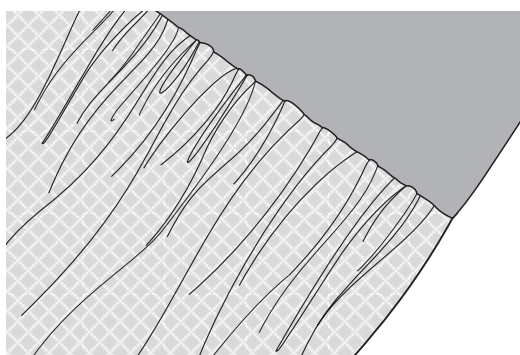
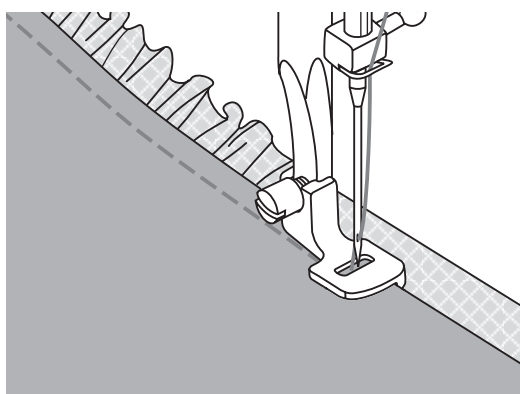
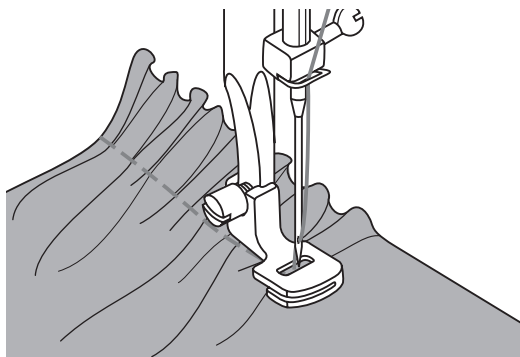
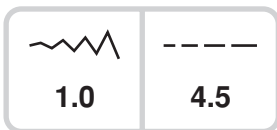
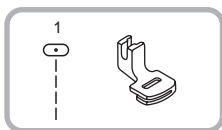

* The Gathering foot is an optional accessory.

Gathered fabric

Remove the presser foot holder and attach the gathering foot.

Place fabric to be gathered under the presser foot.

Sew a row of stitching. The stitches will automatically cause the fabric to gather.

Adjust the upper thread tension dial to achieve the amount of fullness desired. Less tension will result in softer gathers, more tension will result in fuller gathers.

The stitch length dial can also be used to adjust fullness. The longer the stitch length setting is, the more fullness that is achieved in the gathers.

Gather and attach fabric in one step

Look closely at the gathering foot to see a slot on the bottom.

When using the slot, you can gather the bottom layer of the fabric while attaching it to a flat top layer, such as the waistband on a dress bodice.

- Remove the presser foot holder and attach gathering foot.
- Place the fabric to be gathered with right side up under the foot.
- Place top layer of the fabric right side down in the slot.
- Guide the two layers as illustrated.

 **Note:** When testing machine for adjustments to achieve desired fullness, work with 10" increments of the fabric, trims or elastic. This makes it easier to determine the adjustments and how much change is needed for your project. Always test on your project fabric and on the same grainline as will be used in your finished project.

 **Note:** Sew slow to medium speed for better fabric control.

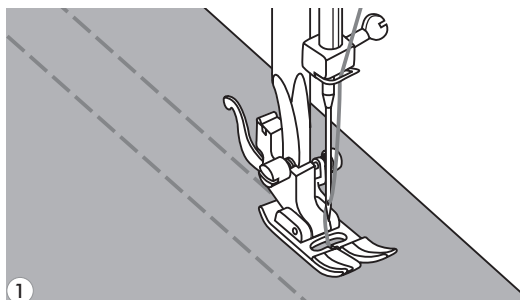
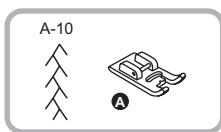
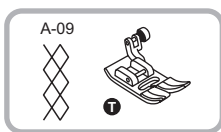

1 Use the all purpose foot to sew straight lines 1cm (3/8") apart, across the area. It may be helpful to reduce the needle thread tension slightly, so that the bobbin thread may be drawn later to gather the fabric.

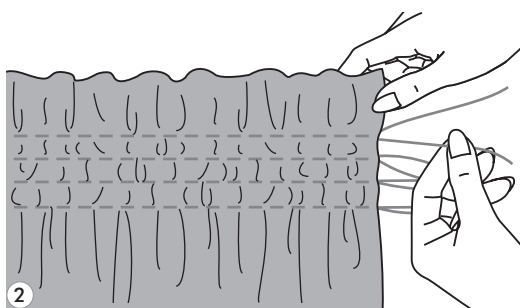

2 Knot the threads along one edge. Pull the bobbin threads and distribute the gathers evenly. Secure the threads at the other end.

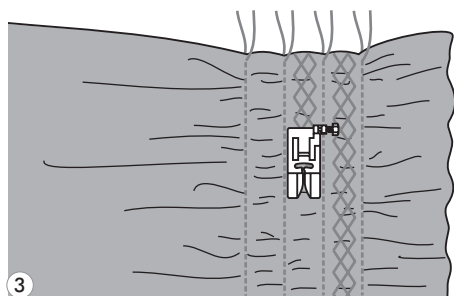

3 Reduce the tension, if necessary and sew decorative pattern stitches between the straight seams.

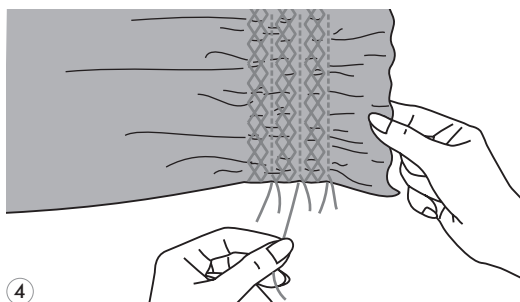

4 Pull out the gathering stitches.

FREE MOTION SEWING

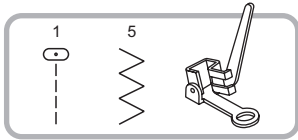

* The Darning foot is an optional accessory.

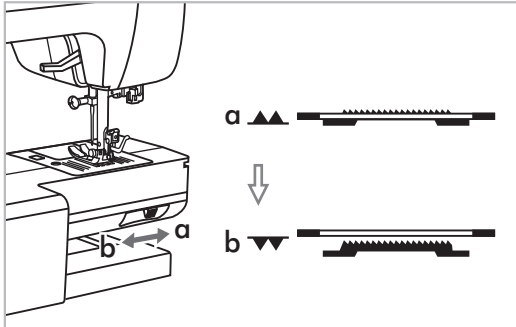

Move the drop feed lever to " ▼▼ " to lower the feed dogs.

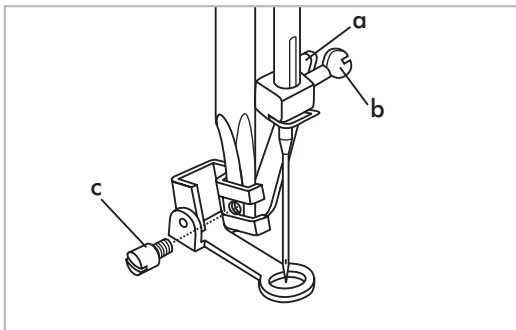

Remove the presser foot holder, and attach the darning foot to the presser foot holder bar. The lever (a) should be behind the needle clamp screw (b). Press the darning foot on firmly from behind with your index finger and tighten the screw (c).

● Darning

 **Please Note:** Free motion darning is accomplished without the sewing machine internal feed system. Movement of the fabric is controlled by the operator. It is necessary to coordinate sewing speed and movement of fabric.

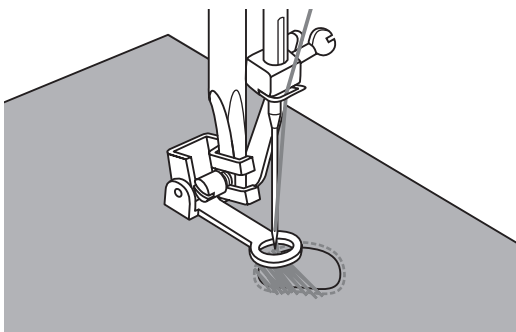

First sew around the edges of the hole to secure the threads. Stitch across the opening moving the hoop backward and forward under the needle. Overlap the outline stitching at each end of the area, keeping the lines of stitching closely spaced and even in length. When the opening is filled, turn the work and cover the area with crosswise lines of stitching.



FREE MOTION SEWING

● Embroidery

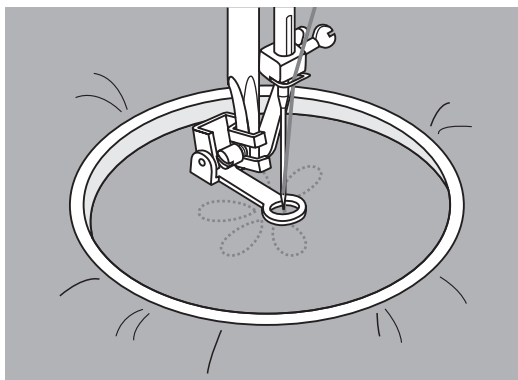

Stitch along the outline of the design by moving the embroidery hoop. Select zigzag stitch pattern and adjust the stitch width as desired. When sewing, make sure to maintain a constant speed.

Fill in the design working from the outline towards the inside. Keep the stitches close together.

You will get longer stitches by moving the hoop faster and shorter stitches by moving the hoop more slowly.

Secure with reinforcement stitches at the end by pressing the Auto-lock button.

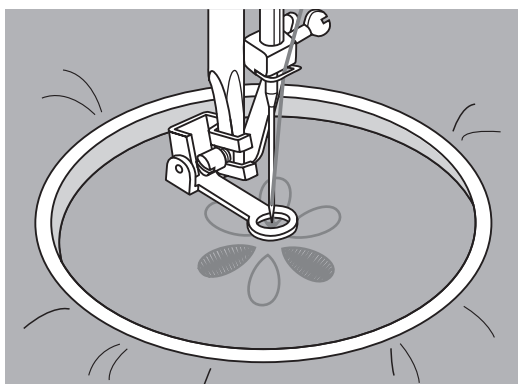

● Monogramming

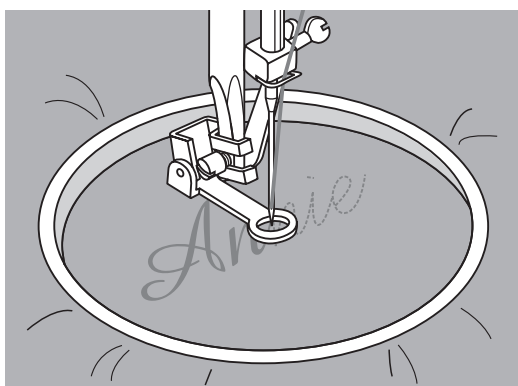

Select the zigzag stitch pattern and adjust the stitch width as desired. Sew at a constant speed, moving the hoop slowly along the lettering.

When the letter is finished. Secure with a reinforcement stitches at the end by press Auto-lock button.

* Embroidery hoop is not included with the machine.

WALKING FOOT

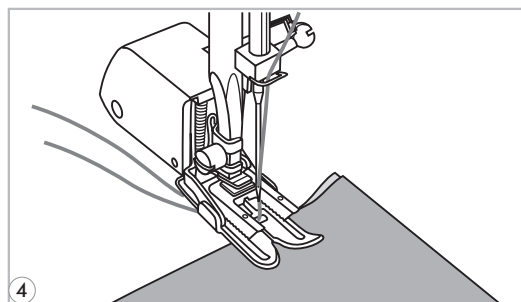
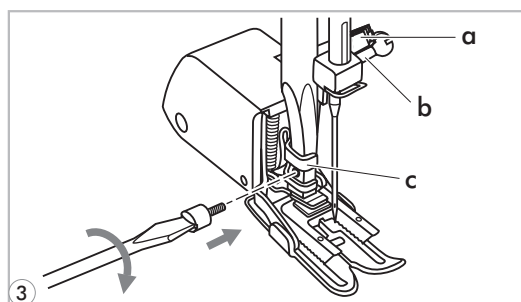
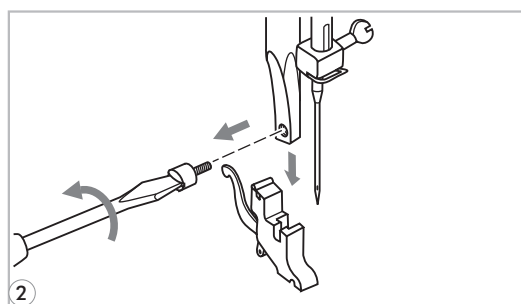
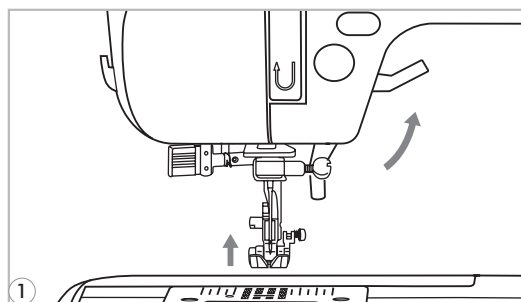
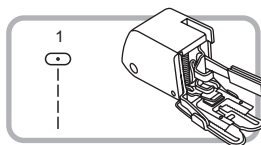

* The Walking foot is an optional accessory.

Please Note: Always try to sew first without the walking foot accessory which should be used only when necessary.

It is easier to guide the fabric and you have a better view of the seam when using the standard, regular foot on your machine. Your sewing machine offers excellent stitch quality on a wide range of fabrics from delicate chiffons to multiple layers of denim.

The Walking foot attachment equalizes the feeding of the fabric layers. It improves the matching of plaids, stripes and patterns. It also helps to prevent uneven feeding of difficult or napped fabrics, such as velvet or corduroy.

- 1** Lift the presser foot lifter to raise the presser foot bar.
- 2** Remove the presser foot holder by unscrewing (counterclockwise) the presser bar attaching screw.
- 3** Attach the Walking foot to the machine as follows:
 - The arm (a) should fit into above the needle screw and clamp (b).
 - Slide the attaching head (c) from left to right, so that it is fitted onto the presser foot bar.
 - Lower the presser foot bar.
 - Replace and tighten (clockwise) the presser bar attaching screw.
 - Make sure both the needle screw and the presser bar attaching screw are tightly secured.
- 4** Draw the bobbin thread up and place both the bobbin thread and the needle thread behind the walking foot attachment.

FAGOTING

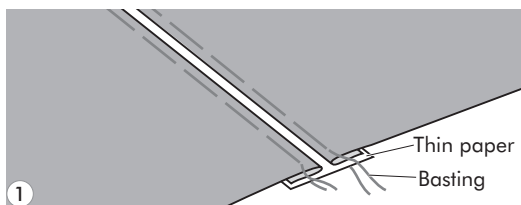
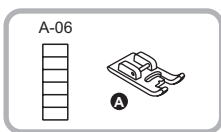
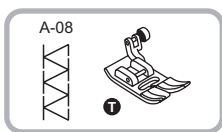

1 Separate the folded edges of the fabric pieces with a gap of 4mm (1/8 inch) and baste them onto a piece of thin paper or water-soluble stabilizer sheet.

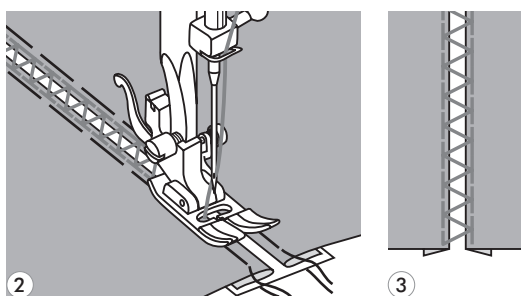

2 Align the center of the presser foot with the center of the two pieces of fabric and begin sewing.

3 After sewing, remove the paper.

DECORATIVE TOPSTITCHING

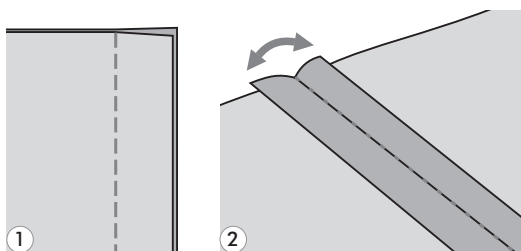
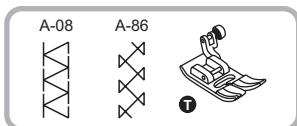

1 Place the two fabrics, right sides together, and sew using a straight stitch.

2 Open the seam allowance and press it flat.

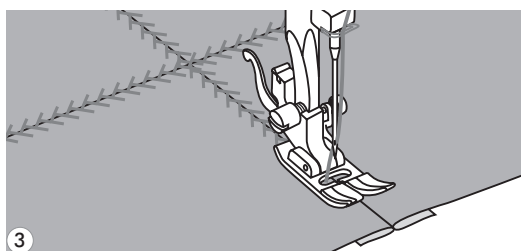

3 Working on the right side of the fabric, place the center of the presser foot on the seam line of the joined fabrics and stitch over the seam.

SCALLOP STITCH

● Scallop hem

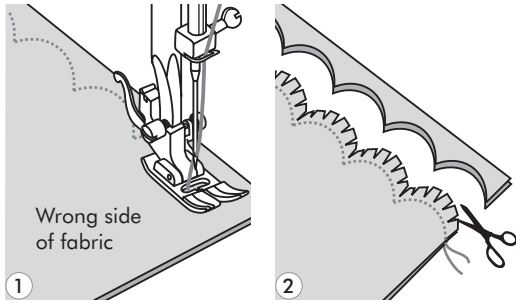
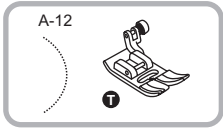

1 Fold the fabric, right sides together. Sew along the folded edge, as illustrated.

2 Cut the fabric along the seam leaving an allowance of 3mm (1/8 inch) for seaming. Notch the allowance.

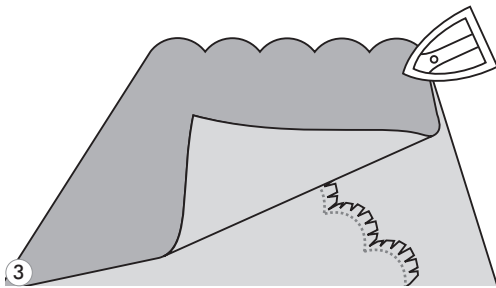

3 Turn fabric over and push out the curved seam to the surface and press it.

● Scallop edging

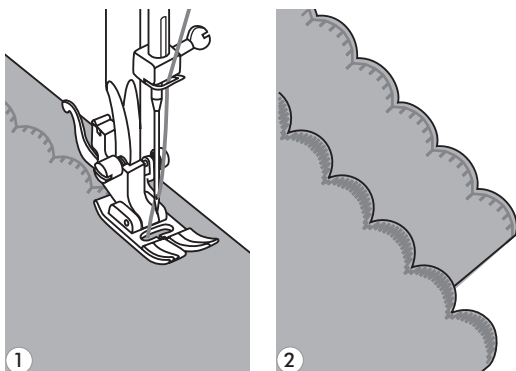
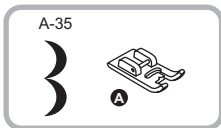
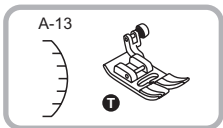

1 Sew on hem line.

2 Trim the fabric close to the stitching taking care not to cut the thread.

ELONGATION

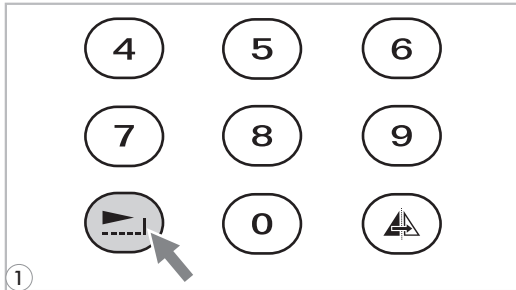
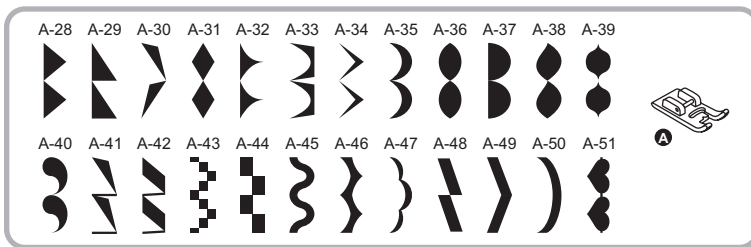

1 The stitches shown in the diagram above can be elongated up to five times the normal length by pressing the elongation button.

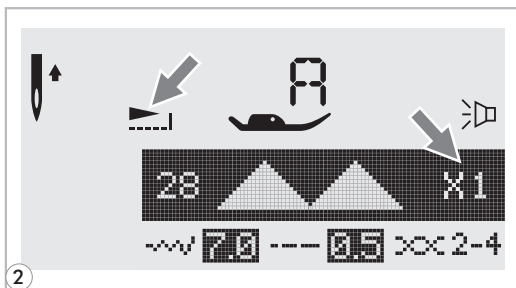

2 The LCD screen icon for elongation imaging of the pattern appears.

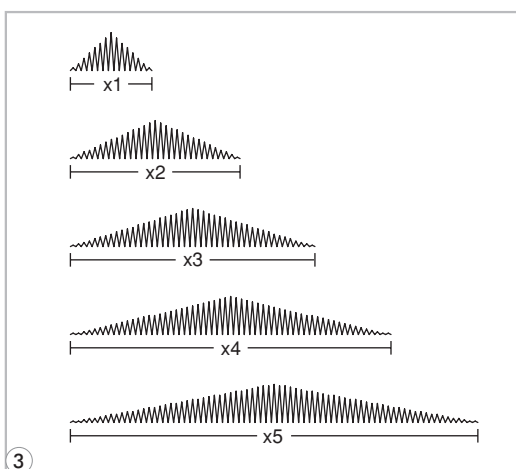

3 When the width or length of the stitch is changed, a greater variety of the selected pattern is available.

Please Note: Patterns from A Group 28-51 can be elongated and mirrored simultaneously.



MIRROR IMAGE



Please Note:

- The Direct Patterns "I" and A Group Patterns 14 -27 cannot be mirror imaged.
- Mirror imaged patterns can also be combined with other patterns.

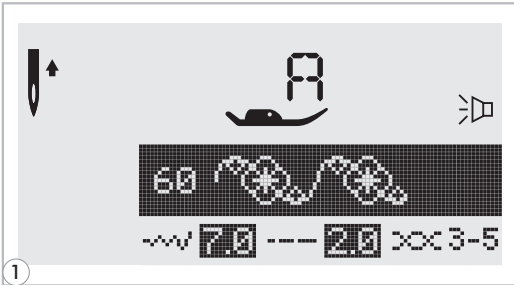

1 Select the pattern.

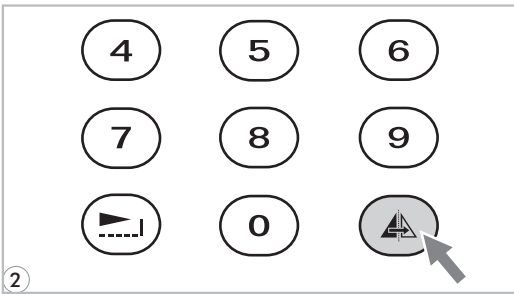

2 Pressing the mirror button.

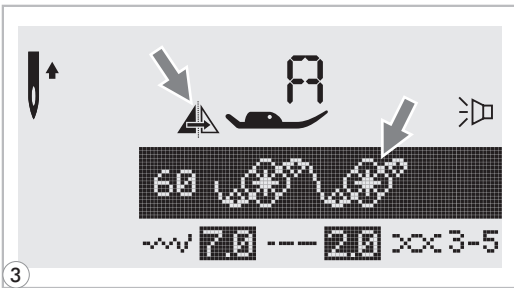

3 The LCD screen icon for mirror imaging of the pattern appears.

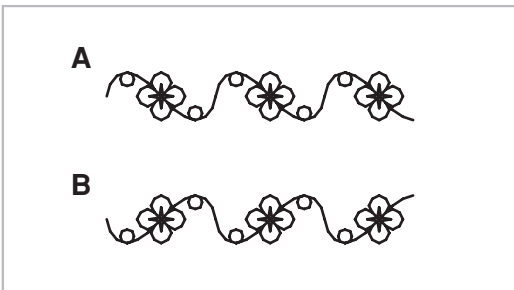

- A. Normal pattern sewing.
- B. Mirror pattern sewing.

USING THE TWIN NEEDLE



Please Note: When using twin needles, use the " T " presser foot regardless of what kind of sewing will be carried out.

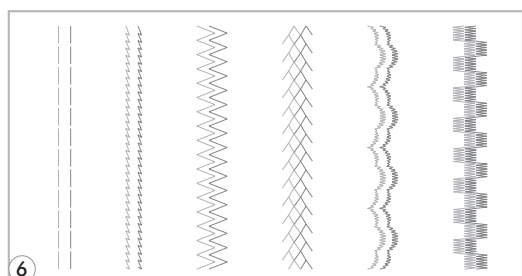
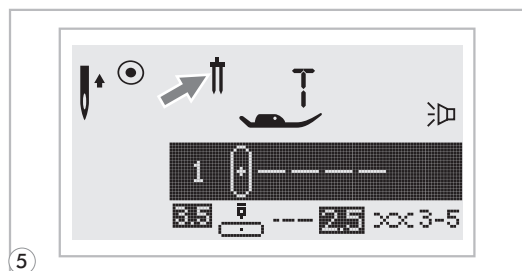
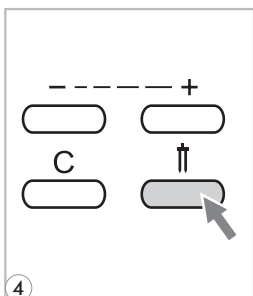
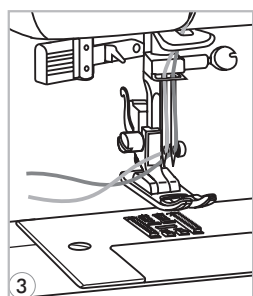
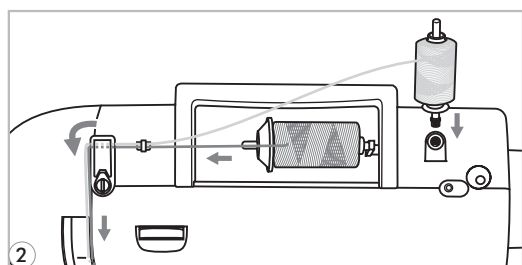
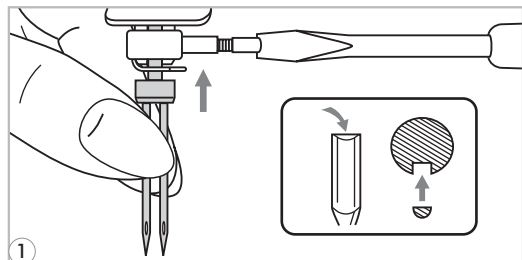

1 Insert the twin needle.

Attention: Use a SINGER style 2025 twin needle. For more information, go to www.singer.com. Use of any other type of twin needle may possibly bend the needle or damage the machine. Bent needles can easily break, possibly resulting in injury.

2 Follow the instructions for single-needle threading using the horizontal spool pin. Thread through the left needle. Set the second spool pin (included with the accessories) into the hole on the top of the machine. Thread through remaining points, making certain to omit the thread guide above the needle and pass thread through the right needle.

3 Thread each needle separately.

Please Note: Make sure that the two threads used to thread the twin needle are of the same weight. You can use one or two colors.

4 Press the Twin needle button, and the machine automatically reduces the maximum width for twin needle sewing.

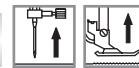

6 Select a pattern and start to sew. Except the Direct patterns " I " and A Group patterns 14-27, the other patterns can be used. Two lines of stitching are sewn parallel to each other.

Please Note: When sewing with twin needle, always proceed slowly, and make sure to maintain a low speed to insure quality stitching.







Combined patterns can be stored for later use. Since stored patterns are not lost after the sewing machine is turned off, they can be recalled at any time. This is convenient for patterns such as names, which may be used frequently.

Please Note:

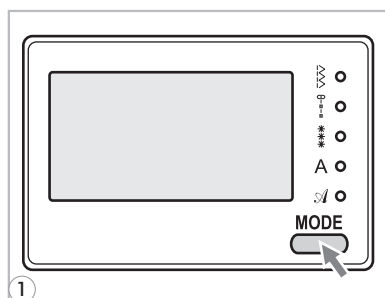
- Multiple patterns selecting from pattern modes  ,  , **A** ,  can be combined and sewn together.
- This machine has 4 modules of program memory and each module can retain 20 units of stitches.
- The Direct mode patterns and the A Group Patterns 14-27 cannot be entered into memory.
- All the units in the memory can be edited to set its function such as Stitch length, Stitch width, Elongation, Mirror, and Auto-lock.

● Combining patterns or letters



1 Press "MODE" button to select any desired pattern group among  ,  , **A** ,  on front cover. The LED will indicate the selected group.

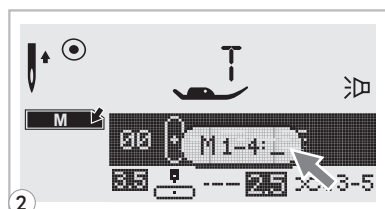

2 Press the " M " button to open the memory mode and then appears a sub-screen in the center. It is available to select the number of the memory module when the cursor start flashing.

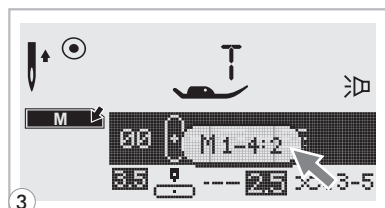

3 Press number of memory module. (e.g. 2)

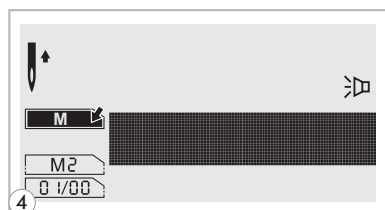

4 The memory screen appears automatically.

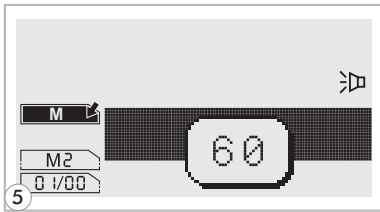
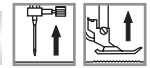

5 Press the desired pattern number. (e.g. 60)

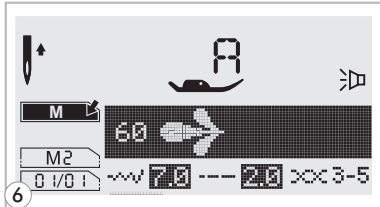

6 The selected pattern displays on the LCD screen.

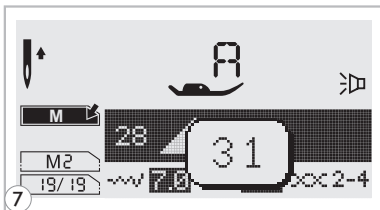

7 Repeat step 5, 6 for more patterns to be stored in the memory.

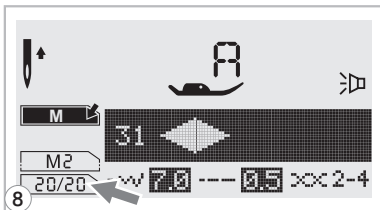

Please Note: When the memory the full with 20 units of patterns, the machine will beep to signal it.

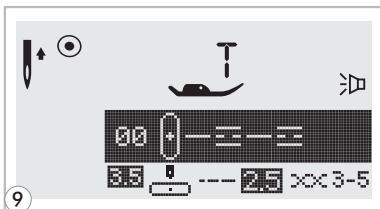

9 Press the "M" button to leave the memory mode and return to the normal screen.

Attention: The selected pattern will be cleared from the memory module after closing the machine if you do not press the "M" button again when you have completed your selection.

● Adding patterns or letters

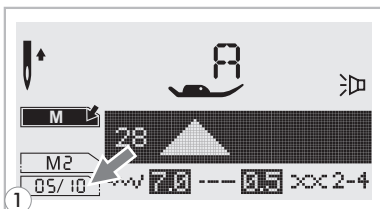

1 While in the memory mode, press stitch width adjustment button until the stitch number you have selected is displayed, then add the new stitch.

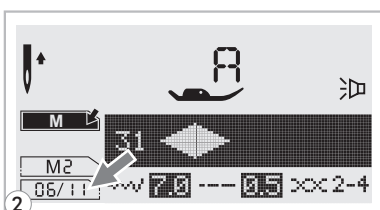

2 Press pattern No. (e.g. 31) The selected pattern will be inserted.

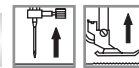

● Editing patterns

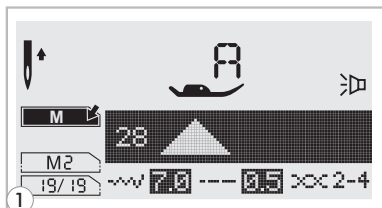

1 Use the stitch width adjustment button to select the pattern that you wish to edit while in the memory mode.

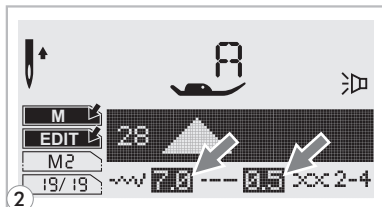

2 Press the " EDIT " button to edit the pattern. The stitch length, stitch width, Elongation, Mirror, and Auto-lock of the patterns can be adjusted manually.

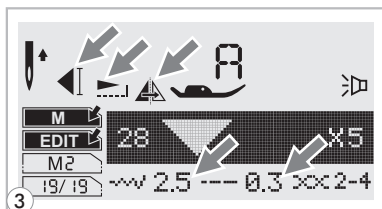

Please Note: The stitch length, stitch width, Elongation, Mirror, and Auto-lock of the patterns can be adjusted manually.

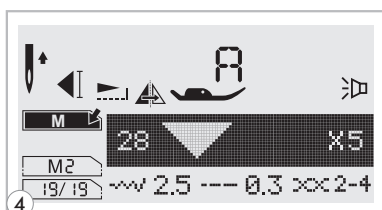

4 Press the " EDIT " button when complete and return to browse status.

● Clearing patterns or letters

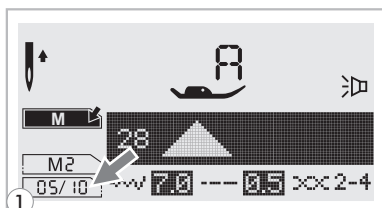

1 While in the memory mode, press stitch width adjustment button to select the pattern that you want to clear .

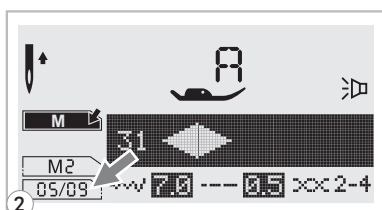

2 Press the " C " button to delete the selected pattern and the next pattern in the back will move forward.

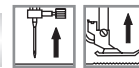

● Recalling and sewing the memorized pattern

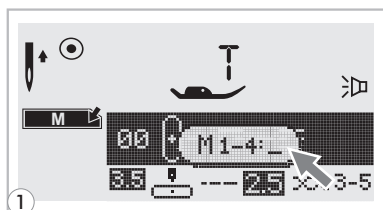

1 Press the " M " button to enter memory mode and then input the number of memory module when the cursor start flashing.

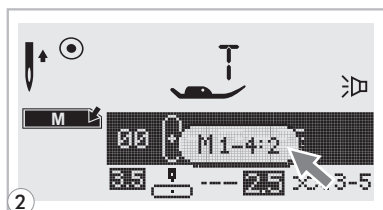

2 Input the number of memory module. (e.g. 2)

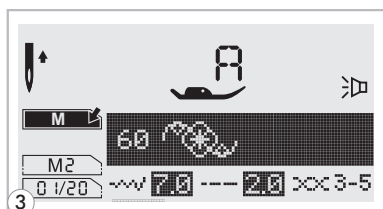

3 LCD screen shows the first pattern of the selected memory module.
Select or browse memory patterns by pressing stitch width " - " or " + " buttons.

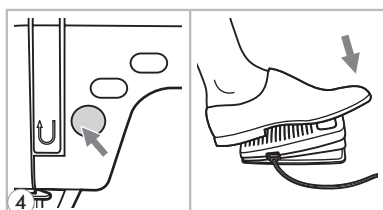

4 Press on the foot control or press the start/stop button to start the sewing machine.

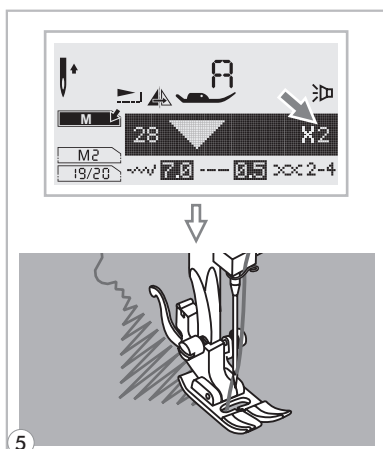

5 The screen shows the current sewing pattern.

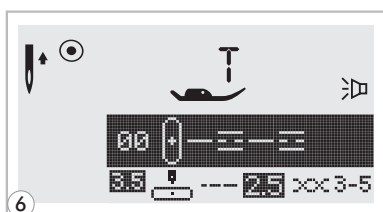

6 Press the " M " button to leave memory mode and return to the normal screen.



WARNING FUNCTIONS

● Warning animation message display

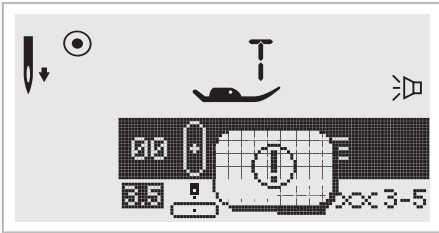

The sewing machine is experiencing a problem

The animation message means that the thread is twisted or jammed and the hand wheel axle cannot move. Please look through the "Trouble shooting guide" on page 73 or 74 to find the solution. After the problem has been solved, the machine will continue to sew.

● Instruction animation message display

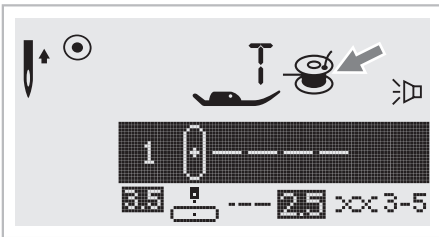

Bobbin winding

The bobbin winder is winding the bobbin.

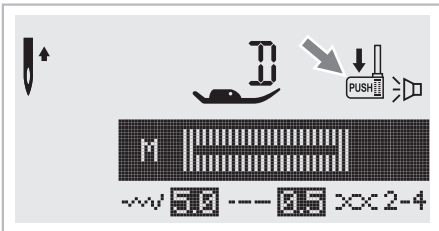

Lower the buttonhole lever

When you select any buttonhole or darning stitch, LCD screen will be demonstrated the figure "↓", it is to remind you to lower the buttonhole lever.



WARNING FUNCTIONS

● Warning beeping sound

- When operating correctly: 1 beep
- When the memory is full 20 units of pattern: 2-short beeps
- When operating incorrectly: 3-short beeps
- When the sewing machine is in trouble and can't sew: 8 seconds short beeps

It means that the thread is twisted or jammed and the hand wheel axle can't move. Please refer to the "Trouble shooting guide" on pages 71 & 72 for solutions. After the problem has been solved, the machine will continue to sew.

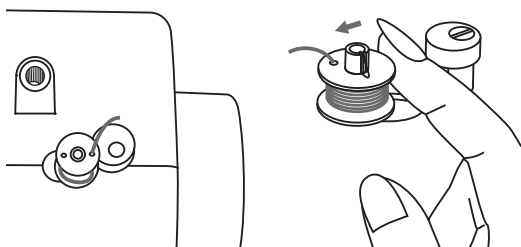

Return bobbin winder shaft to left

If the bobbin winder shaft is positioned to the right (engaged) and any button is pressed a 3-beep warning will be sounded. Move bobbin winder shaft to the left (disengaged) to allow the buttons to be operational.



Please Note: If the problem is not resolved, please contact SINGER at www.singer.com.



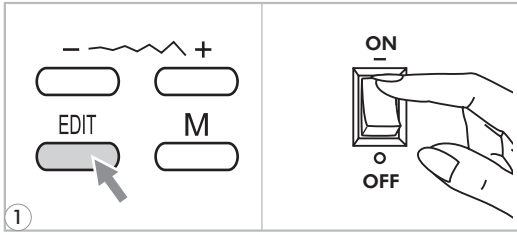

Attention: During the sewing, if the thread get jammed inside the hook stopping the needle from moving and you continue pressing the foot control, the security switch will stop the machine completely. In order to restart the sewing machine, you will have to turn the on/off switch to the OFF position and then ON again.

BUZZER SOUND

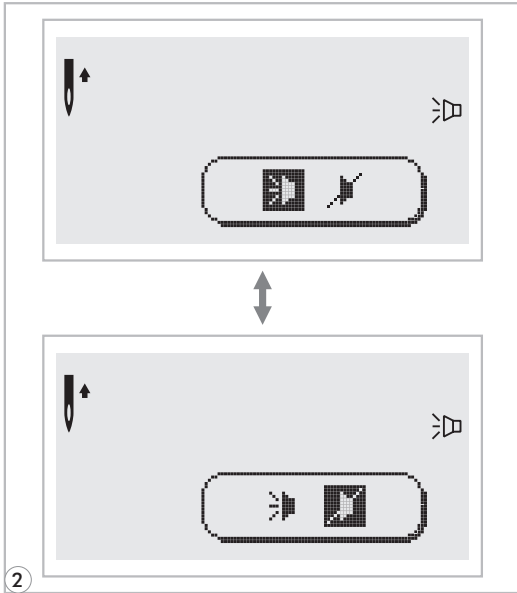

1 Press on the " EDIT " button and turn on the power switch.



2 You can select the mode by pressing the stitch width " + " or " - " button. Select desired mode sound on "  " or sound off "  ".

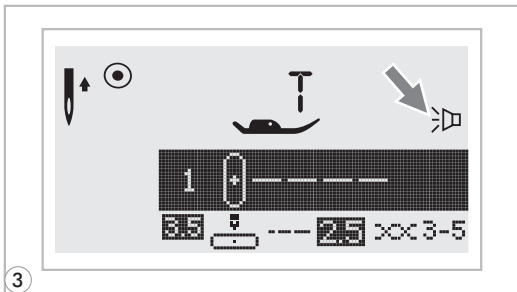

3 Pressing the " EDIT " button. The Buzzer sound setting mark will appear on the LCD screen when you have set it.



MAINTENANCE

⚠ Attention: Disconnect the power cord from the wall socket before cleaning the screen and sewing machine surface, otherwise injury or electrical shock may result.

● Cleaning the screen

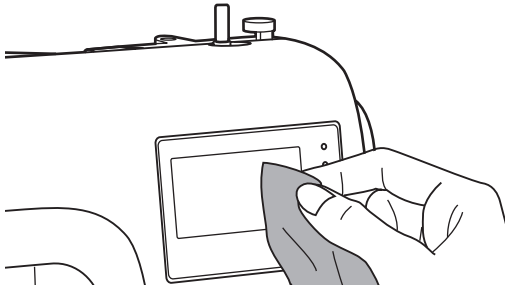

If the front panel is dirty, wipe it gently with a soft, dry cloth.

Do not use any organic solvents or detergents.

● Cleaning the sewing machine surface

If the surface of the sewing machine is dirty, lightly soak a cloth in mild detergent, squeeze it out firmly and then wipe the surface. After cleaning it once in this way, wipe the surface again with a dry cloth.

● Cleaning the hook

If lint and bits of thread accumulate in the hook, this will interfere with the smooth operation of the machine. Check regularly and clean the stitching mechanism when necessary.

⚠ Attention: Disconnect the machine from the wall outlet before carrying out any maintenance.

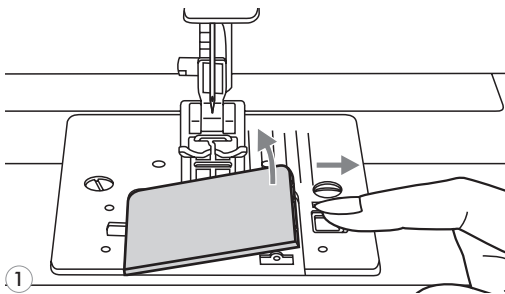

1 Remove the bobbin cover plate and bobbin.

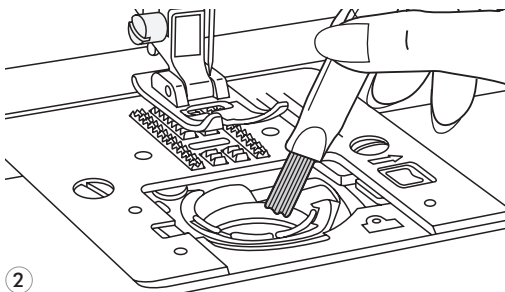

2 Clean the bobbin holder with a brush.

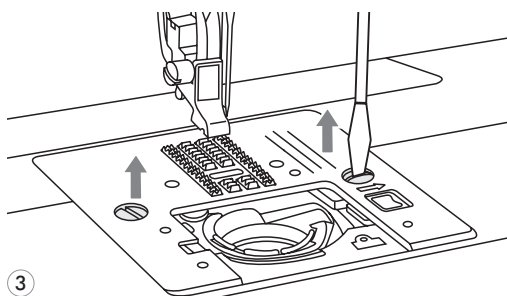

- 3** Remove the needle, presser foot and presser foot holder. Remove the bobbin cover plate and bobbin. Remove the screw holding the needle plate and remove the needle plate.

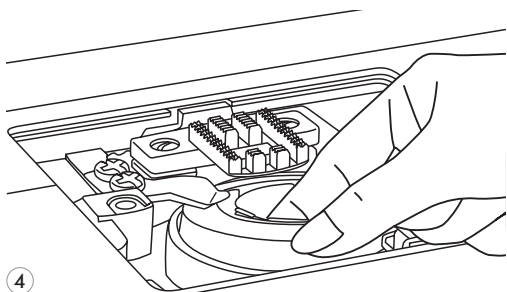

- 4** Lift up the bobbin case and remove it.

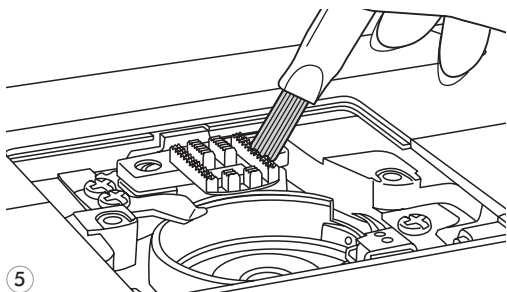

- 5** Clean the hook race, feed dog and bobbin case with a brush. Also clean them, using a soft, dry cloth.

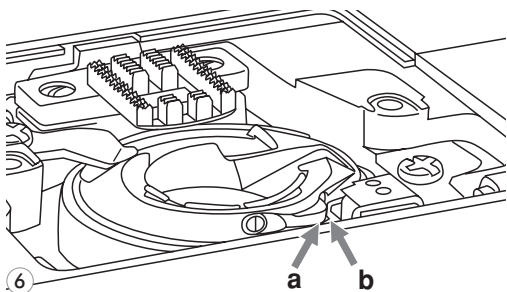

- 6** Replace the bobbin case into the hook race so that the tip (a) fits to the stopper (b) as shown.



TROUBLE SHOOTING GUIDE

Before calling for service, check the following items. If the problem still persists, contact Singer at www.singer.com

Problem	Cause	Correction	Reference
Upper thread breaks	1.The machine is not threaded correctly.	1.Rethread the machine.	Page 18
	2.The thread tension is too tight.	2.Reduce the thread tension (lower number).	Page 21
	3.The thread is too thick for the needle.	3.Select a larger needle.	Page 13
	4.The needle is not inserted correctly.	4.Remove and reinsert the needle (flat side towards the back).	Page 13
	5.The thread is wound around the spool holder pin.	5.Remove the reel and wind thread onto reel.	Page 18
	6.The needle is damaged.	6.Replace the needle.	Page 13
Lower thread breaks	1.The bobbin case is not inserted correctly.	1.Remove and reinsert the bobbin case and pull on the thread. The thread should pull easily.	Page 17
	2.The bobbin case is threaded wrong.	2.Check both bobbin and bobbin case.	Page 17
	3.The lower thread tension is too tight	3.Loosen lower thread tension as described.	Page 21
Skipped stitches	1.The needle is not inserted correctly.	1.Remove and reinsert needle(flat side towards the back).	Page 13
	2.The needle is damaged.	2.Insert a new needle.	Page 13
	3.The wrong size needle has been used.	3.Choose a needle to suit the thread.	Page 13
	4.The foot is not attached correctly.	4.Check and attach correctly.	Page 73
	5.The machine is not threaded correctly.	5.Rethread the machine.	Page 18
Needle breaks	1.The needle is damaged.	1.Insert a new needle.	Page 13
	2.The needle is not correctly inserted.	2.Insert the needle correctly (flat side towards the back).	Page 13
	3.Wrong needle size for the fabric.	3.Choose a needle to suit the thread and fabric.	Page 13
	4.The wrong foot is attached.	4.Select the correct foot.	Page 75
	5.The needle clamp screw is loose.	5.Use the screwdriver to firmly tighten the screw.	Page 11
	6.The presser foot that is used is not appropriate for the type of stitch that you wish to sew.	6.Attach the presser foot that is appropriate for the type of stitch that you wish to sew.	Page 73
	7.The upper thread tension is too tight.	7.Loosen the upper thread tension.	Page 21
Loose stitches	1.The machine is not correctly threaded.	1.Check the threading.	Page 18
	2.The bobbin case is not correctly threaded.	2.Thread the bobbin case as illustrated.	Page 17
	3.Needle/fabric/thread combination is wrong.	3.The needle size must suit the fabric and thread.	Page 13
	4.Thread tension is wrong.	4.Correct the thread tension.	Page 21
Seam gather or pucker	1.The needle is too thick for the fabric.	1.Select a finer needle.	Page 13
	2.The stitch length is adjusted wrong.	2.Readjust the stitch length.	Page 27
	3.The thread tension is too tight.	3.Loosen the thread tension.	Page 21



TROUBLE SHOOTING GUIDE

Problem	Cause	Correction	Reference
Seam puckering	1.The needle thread tension is too tight.	1.Loosen the thread tension.	Page 21
	2.The needle thread is not threaded correctly.	2.Rethread the machine.	Page 18
	3.The needle is too heavy for the fabric being sewn.	3.Choose a needle to suit the thread and fabric.	Page 13
	4.Shorten stitch length is too long for the fabric.	4.Make stitch dense.	Page 27
Patterns are distorted	1.The correct presser foot is not used.	1.Select the correct foot.	Page 73
	2.The needle thread tension is too tight.	2.Loosen the thread tension .	Page 21
	3.The stitch length is not suitable for the fabric being sewn.	3.Make stitch adjustment.	Page 27
The machine jams	1.Thread is caught in the hook.	Remove the upper thread and bobbin case. Turn the handwheel backwards and forwards by hand and remove the thread remnants.	Page 69
	2.The feed dogs are packed with lint.		
The machine is noisy	1.Lint or oil have collected on the hook or needle bar.	1.Clean the hook and feed dog as described.	Page 69
	2.The needle is damaged.	2.Replace the needle.	Page 13
	3.Slight humming sound coming from internal motor.	3.Normal	--
	4.Thread is caught in the hook.	Remove the upper thread and bobbin case. Turn the handwheel backwards and forwards by hand and remove the thread remnants.	Page 69
	5.The feed dogs are packed with lint.		
Uneven stitches, uneven feed	1.Poor quality thread.	1.Select a better quality thread.	Page 13
	2.The bobbin case is threaded wrong.	2.Remove the bobbin case, the thread and reinsert correctly.	Page 13
	3.Fabric has been pulled.	3.Do not pull on the fabric while sewing, let it be taken up by the machine.	--
The sewing machine doesn't operate	1.The machine is not turned on.	1.Turn on the machine.	Page 9
	2.The Start/stop button was not pressed.	2.Press the Start/stop button.	Page 24
	3.The presser foot lever is raised.	3.Lower the presser foot lever.	Page 23
	4.The Start/stop button was pressed, even through the foot controller is connected.	4.Do not use Start/stop button when the foot controller is connected. To use Start/stop button, disconnect the foot controller.	Page 24
	5.A thread is caught in the hook race.	5.Remove the upper thread and bobbin case. Turn the handwheel backwards and forwards by hand and remove the thread remnants.	Page 70
	6.The machine is not plugged in.	6.Connect the power line plug to the electric outlet.	Page 9



STITCH ADJUSTMENT REFERENCE CHART

● Direct patterns-10

Stitch Pattern	Width (mm)		Length (mm)		Presser Foot	Functions						
	Auto	Manual	Auto	Manual		Reverse	Auto-lock	Elongation	Mirror/Presser foot	Twin needle	Memory	
Utility stitches	1	3.5	0.0~7.0	2.5	0.0~4.5	T	*	*		*	*	*
	2	0.0	0.0~7.0	2.5	0.0~4.5	T	*	*		*	*	*
	3	3.5	0.0~7.0	2.5	1.0~3.0	T	*	*		*	*	*
	4	3.5	1.0~6.0	2.5	1.0~3.0	T	*	*		*	*	*
	5	5.0	0.0~7.0	2.0	0.3~4.5	T	*	*		*	*	*
	6	5.0	2.0~7.0	1.0	0.3~4.5	T	*	*		*	*	*
	7	5.0	2.5~7.0	2.5	1.0~3.0	T	*	*		*	*	*
	8	5.0	3.5~7.0	2.5	1.0~3.0	E	*	*		*/T	*	*
	9	3.5	2.5~7.0	2.0	0.5~4.5	F	*	*		*/T	*	*
	0	5.0	2.5~7.0	0.5	0.3~1.0	D						

* : Adjustments can be made.

● A group patterns-100

Stitch Pattern	Width (mm)		Length (mm)		Presser Foot	Functions						
	Auto	Manual	Auto	Manual		Reverse	Auto-lock	Elongation	Mirror/Presser foot	Twin needle	Memory	
Utility stitches	00	3.5	0.0~7.0	2.5	1.5~3.0	T	*	*		*	*	*
	01	2.0	1.0~7.0	2.5	1.0~3.0	T	*	*		*	*	*
	02	5.0	2.5~7.0	2.5	1.0~3.0	T	*	*		*	*	*
	03	3.5	2.5~7.0	1.0	0.5~4.5	F	*	*		*/T	*	*
	04	3.5	2.5~7.0	1.5	0.5~4.5	F	*	*		*/T	*	*
	05	3.5	2.5~7.0	2.5	1.5~3.0	T	*	*		*	*	*
	06	5.0	2.5~7.0	2.5	1.5~3.0	T	*	*		*	*	*
	07	5.0	2.5~7.0	3.0	2.0~3.0	A	*	*		*	*	*
	08	5.0	2.5~7.0	2.5	1.0~3.0	T	*	*		*	*	*
	09	7.0	2.5~7.0	2.5	1.0~3.0	A	*	*		*	*	*
	10	5.0	2.5~7.0	2.5	1.0~3.0	A	*	*		*	*	*
	11	5.0	2.5~7.0	2.0	1.0~3.0	A	*	*		*	*	*
	12	7.0	2.5~7.0	1.5	1.0~3.0	T	*	*		*	*	*
	13	7.0	2.5~7.0	2.5	1.0~4.5	T	*	*		*	*	*
Buttonhole stitches	14	5.0	2.5~5.5	0.5	0.3~1.0	D						
	15	7.0	5.5~7.0	0.5	0.3~1.0	D						
	16	5.0	2.5~5.5	0.5	0.3~1.0	D						
	17	5.0	2.5~5.5	0.5	0.3~1.0	D						
	18	7.0	5.5~7.0	0.5	0.3~1.0	D						
	19	7.0	5.5~7.0	0.5	0.3~1.0	D						
	20	6.0	3.0~7.0	1.0	1.0~2.0	D						
	21	6.0	3.0~7.0	1.5	1.0~3.0	D						



STITCH ADJUSTMENT REFERENCE CHART

Stitch Pattern		Width (mm)		Length (mm)		Presser Foot	Functions					
		Auto	Manual	Auto	Manual		Reverse	Auto-lock	Elongation	Mirror/Presser foot	Twin needle	Memory
Buttonhole stitches	22	2.0	1.0~3.0	0.5	0.5~1.0	D						
	23	7.0	7.0,6.0,5.0			A						
	24	7.0	7.0,6.0,5.0			A						
	25	3.5	2.5~4.5									
Darning stitches	26	7.0	3.5~7.0	2.0	1.5~2.0	D						
	27	7.0	3.5~7.0	2.0	1.5~2.0	D						
Satin stitches	28	7.0	2.5~7.0	0.4	0.3~1.0	A	*	*	*	*	*	*
	29	7.0	2.5~7.0	0.4	0.3~1.0	A	*	*	*	*	*	*
	30	7.0	2.5~7.0	0.4	0.3~1.0	A	*	*	*	*	*	*
	31	7.0	2.5~7.0	0.4	0.3~1.0	A	*	*	*	*	*	*
	32	7.0	2.5~7.0	0.4	0.3~1.0	A	*	*	*	*	*	*
	33	7.0	2.5~7.0	0.4	0.3~1.0	A	*	*	*	*	*	*
	34	7.0	2.5~7.0	0.4	0.3~1.0	A	*	*	*	*	*	*
	35	7.0	2.5~7.0	0.4	0.3~1.0	A	*	*	*	*	*	*
	36	7.0	2.5~7.0	0.4	0.3~1.0	A	*	*	*	*	*	*
	37	7.0	2.5~7.0	0.4	0.3~1.0	A	*	*	*	*	*	*
	38	7.0	2.5~7.0	0.4	0.3~1.0	A	*	*	*	*	*	*
	39	7.0	2.5~7.0	0.4	0.3~1.0	A	*	*	*	*	*	*
	40	7.0	2.5~7.0	0.4	0.3~1.0	A	*	*	*	*	*	*
	41	7.0	2.5~7.0	0.4	0.3~1.0	A	*	*	*	*	*	*
	42	7.0	2.5~7.0	0.4	0.3~1.0	A	*	*	*	*	*	*
	43	7.0	2.5~7.0	0.4	0.3~1.0	A	*	*	*	*	*	*
	44	7.0	2.5~7.0	0.4	0.3~1.0	A	*	*	*	*	*	*
	45	7.0	2.5~7.0	0.4	0.3~1.0	A	*	*	*	*	*	*
	46	7.0	2.5~7.0	0.4	0.3~1.0	A	*	*	*	*	*	*
	47	7.0	2.5~7.0	0.4	0.3~1.0	A	*	*	*	*	*	*
	48	7.0	2.5~7.0	0.4	0.3~1.0	A	*	*	*	*	*	*
	49	7.0	2.5~7.0	0.4	0.3~1.0	A	*	*	*	*	*	*
	50	7.0	2.5~7.0	0.4	0.3~1.0	A	*	*	*	*	*	*
	51	7.0	2.5~7.0	0.4	0.3~1.0	A	*	*	*	*	*	*
	52	7.0	2.5~7.0	0.5	0.3~1.0	A	*	*		*	*	*
	53	7.0	2.5~7.0	0.5	0.4~1.0	A	*	*		*	*	*
	54	7.0	2.5~7.0	1.0	1.0~2.0	A	*	*		*	*	*
	55	7.0	4.0~7.0	0.5	0.5~1.0	A	*	*		*	*	*
	56	7.0	2.5~7.0	1.5	1.5~3.0	A	*	*		*	*	*
	57	7.0	2.5~7.0	0.5	0.5~1.0	A	*	*		*	*	*
	58	7.0	4.0~7.0	0.5	0.5~1.0	A	*	*		*	*	*
	59	7.0	4.0~7.0	0.5	0.5~1.0	A	*	*		*	*	*
60	7.0	5.0~7.0	0.5	0.5~1.0	A	*	*		*	*	*	
Cross stitches	61	5.0	2.5~7.0	2.5	1.0~3.0	A	*	*		*	*	*
	62	6.0	5.0~7.0	1.5	1.5~3.0	A	*	*		*	*	*























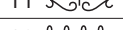

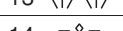
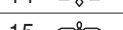
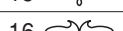
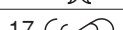
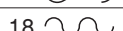
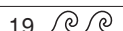







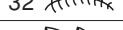

STITCH ADJUSTMENT REFERENCE CHART

Stitch Pattern	Width (mm)		Length (mm)		Presser Foot	Functions							
	Auto	Manual	Auto	Manual		Reverse	Auto-lock	Elongation	Mirror/Presser foot	Twin needle	Memory		
Cross stitches	63	6.0	5.0~7.0	1.5	1.0~3.0	A	*	*		*	*	*	
	64	4.0	3.0~7.0	1.0	1.0~3.0	A	*	*		*	*	*	
	65	4.0	3.0~7.0	1.0	1.0~3.0	A	*	*		*	*	*	
	66	6.0	3.0~7.0	1.5	1.0~3.0	A	*	*		*	*	*	
	67	6.0	3.0~7.0	1.5	1.0~3.0	A	*	*		*	*	*	
	68	6.0	5.0~7.0	1.5	1.0~3.0	A	*	*		*	*	*	
	69	6.0	3.0~7.0	1.5	1.0~3.0	A	*	*		*	*	*	
	70	6.0	3.0~7.0	1.0	1.0~3.0	A	*	*		*	*	*	
	71	6.0	5.0~7.0	1.5	1.0~3.0	A	*	*		*	*	*	
	72	6.0	3.0~7.0	2.0	1.0~3.0	A	*	*		*	*	*	
	73	6.0	5.0~7.0	1.5	1.0~3.0	A	*	*		*	*	*	
	74	6.0	3.0~7.0	1.5	1.0~3.0	A	*	*		*	*	*	
	Decorative stitches	75	6.0	2.5~7.0	1.5	1.0~3.0	T	*	*		*	*	*
		76	5.5	2.5~7.0	2.0	1.0~3.0	T	*	*		*	*	*
77		7.0	2.5~7.0	2.0	1.0~3.0	T	*	*		*	*	*	
78		7.0	2.5~7.0	2.0	1.0~3.0	T	*	*		*	*	*	
79		5.0	2.5~7.0	2.0	1.0~3.0	T	*	*		*	*	*	
80		6.0	2.5~7.0	3.0	1.0~3.0	T	*	*		*	*	*	
81		5.0	2.5~7.0	2.0	1.0~3.0	T	*	*		*	*	*	
82		4.0	2.5~7.0	2.0	1.0~3.0	T	*	*		*	*	*	
83		5.0	2.5~7.0	2.0	1.0~3.0	A	*	*		*	*	*	
84		5.0	4.0~7.0	2.5	1.5~3.0	A	*	*		*	*	*	
85		6.0	3.5~7.0	2.0	1.5~3.0	A	*	*		*	*	*	
86		5.0	2.5~7.0	2.5	1.0~3.0	T	*	*		*	*	*	
87		6.0	4.0~7.0	1.5	1.5~3.0	A	*	*		*	*	*	
88		5.0	4.0~7.0	2.0	1.5~3.0	T	*	*		*	*	*	
89		5.0	2.5~7.0	1.5	1.0~3.0	T	*	*		*	*	*	
90		5.5	2.5~7.0	1.5	1.0~3.0	A	*	*		*	*	*	
91		6.0	3.5~7.0	2.0	1.5~3.0	A	*	*		*	*	*	
92		7.0	4.5~7.0	1.5	1.0~3.0	A	*	*		*	*	*	
93		5.0	3.0~7.0	2.0	2.0~3.0	A	*	*		*	*	*	
94		5.0	4.0~7.0	1.5	1.0~3.0	A	*	*		*	*	*	
95		5.0	2.5~7.0	2.5	1.0~3.0	T	*	*		*	*	*	
96	6.0	2.5~7.0	3.0	1.5~3.0	T	*	*		*	*	*		
97	6.0	3.5~7.0	1.5	1.0~3.0	T	*	*		*	*	*		
98	7.0	3.0~7.0	2.0	1.0~3.0	T	*	*		*	*	*		
99	7.0	4.0~7.0	2.5	1.5~3.0	A	*	*		*	*	*		

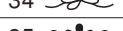







































*: Adjustments can be made.

STITCH ADJUSTMENT REFERENCE CHART

B group patterns-100

Stitch Pattern		Width (mm)		Length (mm)		Presser Foot	Functions					
		Auto	Manual	Auto	Manual		Reverse	Auto-lock	Elongation	Mirror/Presser foot	Twin needle	Memory
Decorative stitches	00 	7.0	3.0~7.0	3.0	1.5~3.0	A	*	*		*	*	*
	01 	7.0	5.0~7.0	2.5	2.0~3.0	A	*	*		*	*	*
	02 	6.0	4.5~7.0	2.5	1.5~3.0	A	*	*		*	*	*
	03 	5.0	3.5~7.0	2.5	1.5~3.0	A	*	*		*	*	*
	04 	7.0	2.5~7.0	2.0	1.0~3.0	T	*	*		*	*	*
	05 	7.0	2.5~7.0	2.5	1.5~3.0	T	*	*		*	*	*
	06 	7.0	2.5~7.0	2.5	1.5~3.0	T	*	*		*	*	*
	07 	5.0	2.5~7.0	2.5	1.5~3.0	T	*	*		*	*	*
	08 	6.0	4.5~7.0	2.0	1.5~3.0	T	*	*		*	*	*
	09 	5.0	2.5~7.0	2.5	1.5~3.0	T	*	*		*	*	*
	10 	6.0	3.5~7.0	1.5	1.5~3.0	A	*	*		*	*	*
	11 	7.0	3.5~7.0	2.5	2.0~3.0	A	*	*		*	*	*
	12 	7.0	3.5~7.0	2.0	1.0~3.0	T	*	*		*	*	*
	13 	5.0	2.5~7.0	2.0	2.0~3.0	A	*	*		*	*	*
	14 	7.0	4.0~7.0	3.0	2.0~3.0	A	*	*		*	*	*
	15 	7.0	4.0~7.0	3.0	2.0~3.0	A	*	*		*	*	*
	16 	7.0	4.0~7.0	3.0	2.5~3.0	A	*	*		*	*	*
	17 	7.0	2.5~7.0	2.0	1.5~3.0	T	*	*		*	*	*
	18 	5.0	2.5~7.0	1.0	1.0~4.5	T	*	*		*	*	*
	19 	7.0	3.5~7.0	1.0	1.0~3.0	A	*	*		*	*	*
	20 	7.0	4.0~7.0	3.0	2.0~3.0	A	*	*		*	*	*
	21 	5.0	3.5~7.0	2.0	2.0~3.0	T	*	*		*	*	*
	22 	5.0	3.0~7.0	1.5	1.5~3.0	T	*	*		*	*	*
	23 	5.0	2.5~7.0	1.5	1.0~3.0	T	*	*		*	*	*
	24 	5.0	2.5~7.0	2.0	1.0~3.0	T	*	*		*	*	*
	25 	5.0	2.5~7.0	1.0	1.0~3.0	T	*	*		*	*	*
	26 	5.0	3.5~7.0	3.0	2.0~3.0	A	*	*		*	*	*
	27 	5.0	3.0~7.0	2.5	1.5~3.0	A	*	*		*	*	*
	28 	5.0	2.5~7.0	2.0	1.5~3.0	T	*	*		*	*	*
	29 	7.0	2.5~7.0	1.5	1.0~3.0	A	*	*		*	*	*
	30 	7.0	2.5~7.0	2.0	1.0~3.0	A	*	*		*	*	*
	31 	7.0	2.5~7.0	3.0	1.5~3.0	A	*	*		*	*	*
	32 	7.0	3.0~7.0	2.0	1.5~3.0	A	*	*		*	*	*
	33 	7.0	3.5~7.0	2.0	1.5~3.0	A	*	*		*	*	*
	34 	6.0	4.0~7.0	2.0	1.5~3.0	A	*	*		*	*	*
	35 	6.0	2.5~7.0	2.5	2.0~3.0	A	*	*		*	*	*
	36 	7.0	2.5~7.0	3.0	2.5~3.0	A	*	*		*	*	*
	37 	7.0	3.0~7.0	3.0	2.5~3.0	A	*	*		*	*	*
38 	7.0	2.5~7.0	2.5	1.5~3.0	A	*	*		*	*	*	





















STITCH ADJUSTMENT REFERENCE CHART

Stitch Pattern	Width (mm)		Length (mm)		Presser Foot	Functions					
	Auto	Manual	Auto	Manual		Reverse	Auto-lock	Elongation	Mirror/Presser foot	Twin needle	Memory
39 	7.0	3.5~7.0	2.5	1.5~3.0	T	*	*		*	*	*
40 	7.0	3.5~7.0	2.0	1.5~3.0	T	*	*		*	*	*
41 	7.0	3.0~7.0	2.5	1.0~3.0	T	*	*		*	*	*
42 	7.0	2.5~7.0	2.0	1.5~3.0	T	*	*		*	*	*
43 	7.0	3.0~7.0	2.5	1.5~3.0	T	*	*		*	*	*
44 	7.0	3.5~7.0	1.5	1.5~3.0	T	*	*		*	*	*
45 	7.0	5.0~7.0	2.5	2.0~3.0	A	*	*		*	*	*
46 	7.0	5.0~7.0	2.0	2.0~3.0	A	*	*		*	*	*
47 	7.0	3.0~7.0	2.0	1.5~3.0	A	*	*		*	*	*
48 	7.0	4.0~7.0	2.0	1.5~3.0	A	*	*		*	*	*
49 	7.0	5.0~7.0	2.5	2.5~3.0	A	*	*		*	*	*
50 	6.0	3.5~7.0	2.0	1.5~3.0	A	*	*		*	*	*
51 	7.0	4.0~7.0	3.0	2.5~3.0	A	*	*		*	*	*
52 	7.0	4.5~7.0	2.0	2.0~3.0	A	*	*		*	*	*
53 	7.0	3.5~7.0	1.5	1.5~3.0	A	*	*		*	*	*
54 	7.0	3.0~7.0	2.5	2.0~3.0	A	*	*		*	*	*
55 	7.0	3.0~7.0	2.0	2.0~3.0	A	*	*		*	*	*
56 	7.0	3.5~7.0	2.5	2.0~3.0	A	*	*		*	*	*
57 	7.0	2.5~7.0	2.0	1.5~3.0	A	*	*		*	*	*
58 	7.0	4.5~7.0	2.0	2.0~3.0	A	*	*		*	*	*
59 	7.0	4.5~7.0	2.0	1.5~3.0	A	*	*		*	*	*
60 	7.0	4.0~7.0	2.0	2.0~3.0	A	*	*		*	*	*
61 	7.0	3.0~7.0	2.0	1.5~3.0	A	*	*		*	*	*
62 	7.0	3.0~7.0	2.0	1.5~3.0	A	*	*		*	*	*
63 	7.0	3.5~7.0	2.0	2.0~3.0	A	*	*		*	*	*
64 	7.0	3.5~7.0	2.0	1.5~3.0	A	*	*		*	*	*
65 	7.0	3.5~7.0	2.0	2.0~3.0	A	*	*		*	*	*
66 	7.0	4.5~7.0	2.0	2.0~3.0	A	*	*		*	*	*
67 	7.0	3.5~7.0	2.0	1.5~3.0	A	*	*		*	*	*
68 	7.0	3.5~7.0	2.5	2.0~3.0	A	*	*		*	*	*
69 	7.0	2.5~7.0	1.5	1.5~3.0	A	*	*		*	*	*
70 	5.0	3.5~7.0	1.0	1.0~3.0	A	*	*		*	*	*
71 	7.0	2.5~7.0	2.0	1.5~3.0	A	*	*		*	*	*
72 	7.0	3.5~7.0	2.0	2.0~3.0	A	*	*		*	*	*
73 	6.0	4.5~7.0	1.0	1.0~3.0	A	*	*		*	*	*
74 	7.0	4.0~7.0	2.0	2.0~2.5	A	*	*		*	*	*
75 	7.0	2.5~7.0	2.0	2.0~2.5	A	*	*		*	*	*
76 	7.0	3.5~7.0	2.0	2.0~3.0	A	*	*		*	*	*
77 	7.0	5.0~7.0	2.0	2.0~3.0	A	*	*		*	*	*
78 	7.0	4.5~7.0	3.0	1.5~3.0	A	*	*		*	*	*

Decorative stitches



STITCH ADJUSTMENT REFERENCE CHART

Stitch Pattern	Width (mm)		Length (mm)		Presser Foot	Functions					
	Auto	Manual	Auto	Manual		Reverse	Auto-lock	Elongation	Mirror/ Presser foot	Twin needle	Memory
79 	7.0	4.0~7.0	2.5	2.0~3.0	A	*	*		*	*	*
80 	7.0	3.5~7.0	2.5	2.0~3.0	A	*	*		*	*	*
81 	7.0	3.0~7.0	2.5	2.0~3.0	A	*	*		*	*	*
82 	7.0	3.5~7.0	2.5	2.0~3.0	T	*	*		*	*	*
83 	6.0	2.5~7.0	2.5	2.0~3.0	T	*	*		*	*	*
84 	6.0	2.5~7.0	2.5	1.0~3.0	T	*	*		*	*	*
85 	6.0	4.0~7.0	2.5	1.5~3.0	T	*	*		*	*	*
86 	6.0	2.5~7.0	2.5	2.0~3.0	T	*	*		*	*	*
87 	5.5	3.5~7.0	2.0	1.5~3.0	A	*	*		*	*	*
88 	6.0	4.5~7.0	2.5	2.0~3.0	A	*	*		*	*	*
89 	6.0	3.5~7.0	3.0	1.5~3.0	A	*	*		*	*	*
90 	7.0	5.0~7.0	3.0	2.0~3.0	A	*	*		*	*	*
91 	6.0	5.0~7.0	2.5	2.0~3.0	A	*	*		*	*	*
92 	5.0	2.5~7.0	3.0	1.5~3.0	A	*	*		*	*	*
93 	5.0	2.5~7.0	2.0	1.5~3.0	T	*	*		*	*	*
94 	5.0	4.5~7.0	2.0	2.0~3.0	T	*	*		*	*	*
95 	7.0	2.5~7.0	2.0	1.5~3.0	T	*	*		*	*	*
96 	5.0	3.5~7.0	2.0	1.5~3.0	T	*	*		*	*	*
97 	5.0	3.5~7.0	2.0	1.0~3.0	T	*	*		*	*	*
98 	6.0	3.5~7.0	2.5	2.0~3.0	T	*	*		*	*	*
99 	5.0	3.0~7.0	2.0	1.0~3.0	T	*	*		*	*	*

*: Adjustments can be made.



Please note that on disposal, this product must be safely recycled in accordance with relevant National legislation relating to electrical/electronic products. If in doubt please contact your retailer for guidance

