

SINGER 4830 & 4832

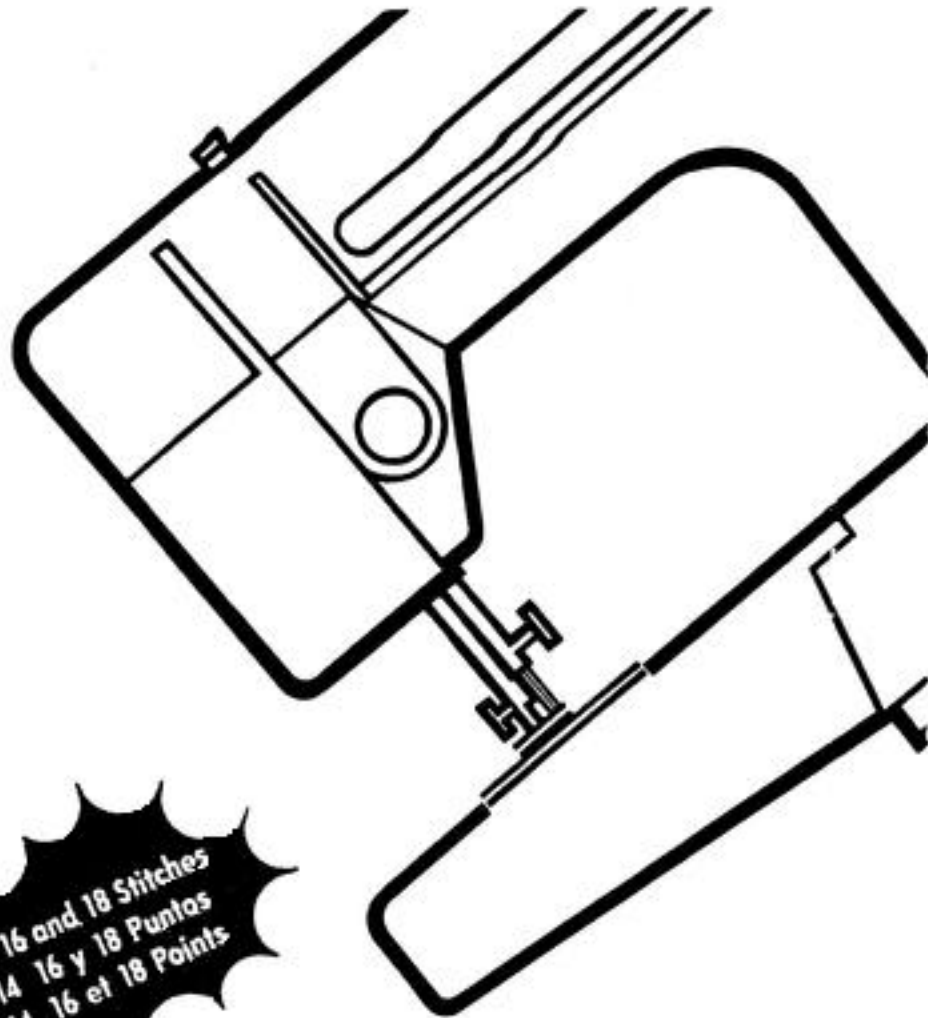

12 14 16 and 18 Stitches
12 14 16 y 18 Puntos
12 14 16 et 18 Points

INSTRUCTION MANUAL

SINGER

4830 & 4832

Table of contents

Important safety instructions	Darning
Getting to know your machine	Inserting a zipper
Principal parts	Zig-Zag Stitching
Accessories	Needle position selector
Connecting the machine	Stitch width Selector
Running the machine	Adjusting stitch length
Choosing and changing the needle	Pattern groups selection
Changing the needle plate	Flexi-stitch patterns
Changing screw-on presser feet	Balancing flexi-stitches
Attaching the bed Cover	Decorative stitch patterns
Changing snap-on presser feet	Flexi-stitch patterns
Fabric thread and needle table	Attaching a button
Inserting a bobbin	Free-arm sewing
Winding a bobbin	Removing the extension table
Threading the machine	Four-step buttonhole
Raising the bobbin thread	Twin needle sewing
Adjusting thread tension	Additional accessories/Accessory storage
Sewing a seam	Caring for your machine
Starting a seam	Removing and replacing bobbin case
Straight stitching	Cleaning the machine
Stitch width selector	Lubricating the machine
Needle position Selector	Changing the light bulb
Stitch length selector	Performance checklist
Reverse stitch button and sewing	
In reverse	

SINGER 4830 & 4832

Congratulations

As the owner of a new Singer sewing machine, you are about to begin an exciting adventure in creativity. From the moment you first use your machine you will know you are sewing one of the easiest to use sewing machines ever made.

May we recommend that, before you start to use your sewing machine you discover the many advantages and the ease of operation by going through this instruction book, step by step, seated at your machine.

To ensure that you are always provided with the most modern sewing capabilities, the manufacturer reserves the right to change the appearance, design or accessories of this sewing machine when considered necessary.

Dear Customer,

We recommend that for future reference you record the Serial Number of Your Sewing Machine in the space provided.

Refer to illustration for location of Serial Number on your machine

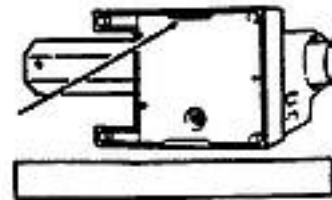

Serial No.

A Trademark of The Singer Company
Copyright (c) 1993 Singer Sewing Machine Company
All rights reserved throughout the world.

SINGER

4830 & 4832

For European Territories:

This product is suppressed for radio and television interference with the international Electrotechnical Commission requirements of the CISPR.

IMPORTANT SAFETY INSTRUCTIONS

When using this machine basic safety precautions should always be followed including the following:

- Read all instructions before using this machine.

DANGER

To reduce the risk of electric shock

- The machine should never be left unattended when plugged in. Always unplug the machine from the electric outlet immediately after using and before cleaning.
- Always unplug before relamping. Replace bulb with the same type rated 15 watts
- Be sure to replace the face plate which covers the light bulb before operating the machine.

WARNING

To reduce the risk of burns, fire, electric shock or injury to persons:

- Be sure that the electrical voltage of the socket outlet (wall receptacle is the same as the rated voltage of the motor).
- Use this machine only for its intended use as described In this Operator's Guide
- Use only attachments recommended by the manufacturer as contained In the Operator's Guide
- To disconnect, turn all controls to the off ("0") position, then remove plug from outlet
- Disconnect the power-line plug from the socket outlet or switch the machine off when making any adjustments in the needle area, such as threading needle changing needle, changing throat plate or changing presser foot, etc
- Always unplug the machine from the electrical outlet when removing covers lubricating, or when making any other user servicing adjustments mentioned in the Operator's Guide.

SINGER

4830 & 4832

WARNING continued...

- Do not attempt to adjust the motor belt. Contact Your nearest Service Center should any adjustment be required.
- Do not unplug by pulling on cord. To unplug, grasp the plug, not the cord.
- Handle the foot controller with care and avoid dropping it on the floor. Be sure not to place anything on top of it.
- Always use the proper throat plate. The wrong plate can cause the needle to break.
- Do not use bent needles.
- When sewing, keep fingers away from all moving parts. Special care is required around the sewing machine needle.
- Do not pull or push fabric while stitching. It may deflect the needle causing it to break.
- Before removing the bobbin case, remove plug from the socket outlet.
- For double insulated machines. when servicing use only identical replacement parts
- Never operate the machine if it has a damaged cord or plug, If it is not working properly, If it has been dropped or damaged; or dropped into the water, return the machine to the nearest authorized dealer or Service Center for examination, repair, electrical, or mechanical adjustment.
- Never operate the machine with any air openings blocked. Keep ventilation openings of the machine and foot controller free from the accumulation of lint, dust, and loose cloth
- Never drop or insert any object into any opening.
- Do not use outdoors
- Do not operate where aerosol aerosol (spray) products are being or oxygen is administered .
- Do not allow to be used as a toy. Close attention is necessary when the machine is used by or near children.

SAVE THESE INSTRUCTIONS

Servicing should be performed by an authorized service representatives.

This product is intended for household use.

SINGER 4830 & 4832

Getting to know your machine

Principal parts

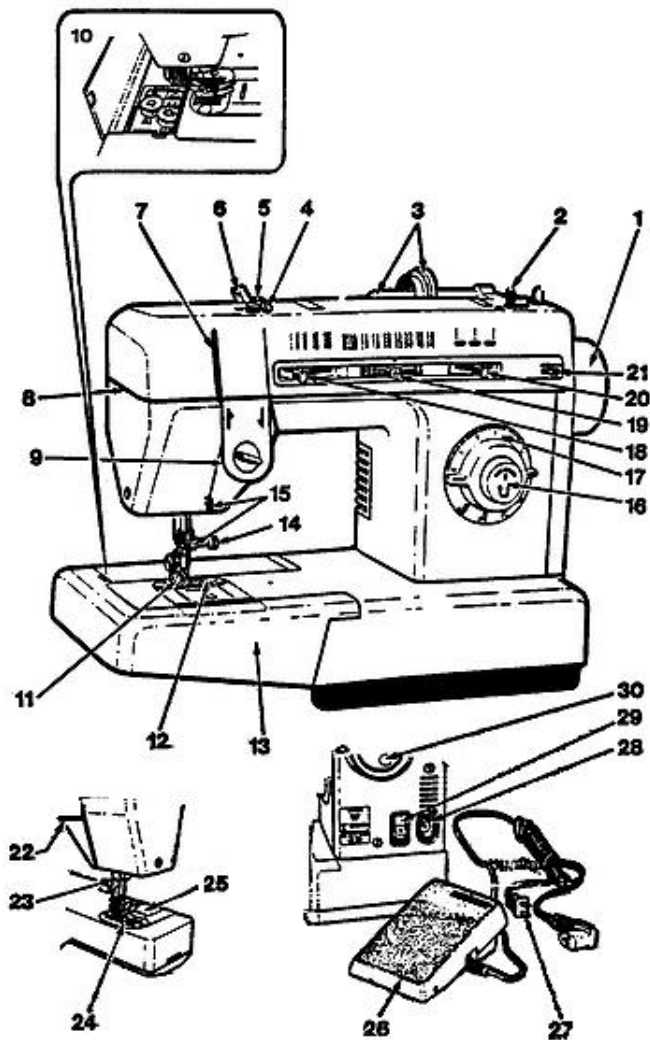

1. Hand wheel
2. Bobbin winder
3. Horizontal spool pin and holder
4. Thread guide
5. Bobbin winder tension disc
6. Snap-in thread guide
7. Take up lever
8. Face plate
9. Needle thread tension dial
10. Accessory storage
11. Snap on presser foot
12. Needle plate
13. Removable extension table
14. One-way needle clamp
15. Thread guides
16. Push button reverse
17. Stitch length dial/four-step buttonhole
18. Stitch width lever
19. Pattern selector dial
20. Needle position selector
21. Stitch balance control
22. Presser foot lifter
23. Thread cutter
24. Feed system
25. Slide plate
26. Foot control
27. Electrical lead
28. Machine plug
29. Power and light switch
30. Bobbin winding Indent

SINGER 4830 & 4832

Accessories

The following accessories furnished with your sewing machine are designed to simplify your sewing projects and increase the versatility of your machine.

The letter in a circle adjacent to the Illustrated part is reproduced on the part itself to help you select the correct attachment for the type of work you are doing.

1. Blindstitch hem presser foot is used to position the hem for blindstitch hemming.
2. Special purpose presser foot (J) is used for decorative and zig-zag sewing.
3. General purpose needle plate (A) and presser foot (B) are on your machine when delivered. Use together for alternating between straight and zigzag stitching.
4. Buttonhole presser foot (1) is used with the General Purpose Needle Plate to make four-step buttonholes.
5. Zipper foot (E) is used for inserting zipper and stitching corded seams.
6. Friction free spool holder is used to hold various size spools and allows thread to unwind smoothly. The spool does not turn.
7. Small thread spool hold (Q) for use with small diameter spools of thread.
8. Needle pack includes an assortment for sewing various types of fabrics.
9. Feed cover (F) is used to prevent the feed from moving the fabric when darning or free motion embroidery.
10. Transparent bobbins for easy viewing of thread supply.

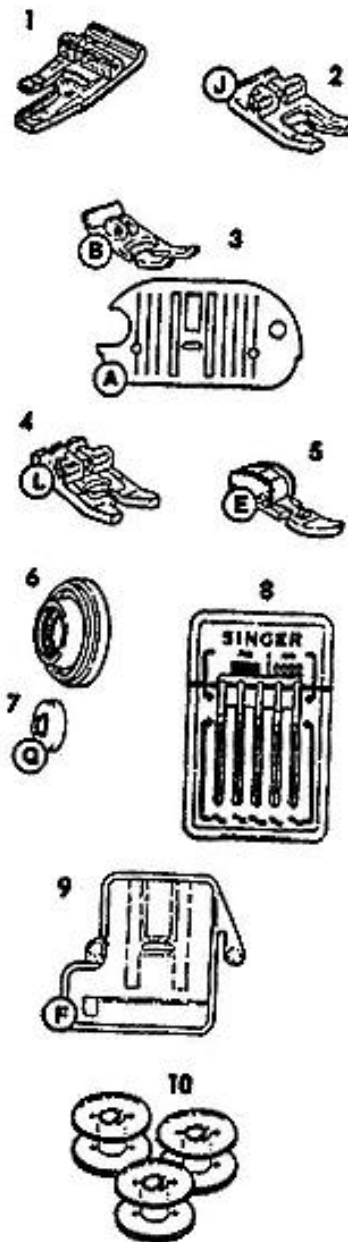

SINGER 4830 & 4832

Connecting the machine

Push plug into the receptacle (1) at the right end of the machine. Then connect plug (2) to your socket outlet.

Running the machine

To turn on machine and sewing light, press upper portion of power switch. To turn off machine and light, press lower portion "D" of power switch.

To run the machine and control speed, press the foot control with your foot. The harder you press, the faster the machine will sew. To stop machine, remove foot from control.

Note: Do not operate machine without fabric under the presser foot as this may damage the feed and the presser foot.

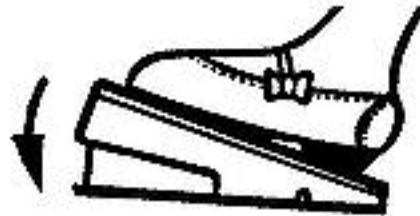

SINGER 4830 & 4832

Choosing and changing needles

- Raise needle to its highest position.
- Loosen needle clamp screw and remove needle.
- With flat side of needle to the back, insert new needle up into clamp as far as it will go.
- Tighten needle clamp screw securely.

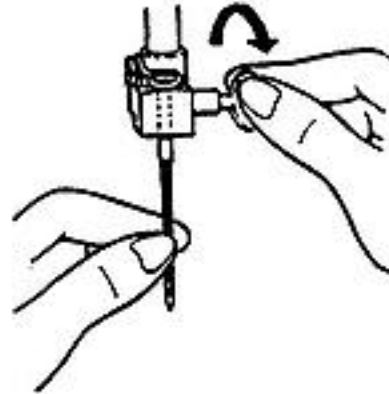

Changing the needle plate (A), (C)

- Raise needle and presser foot.
- Open slide plate.
- Lift up needle plate from right corner and slide out from under foot.
- To replace needle plate slide it under pin (1) and push it firmly to the left.
- Press down until it snaps into place

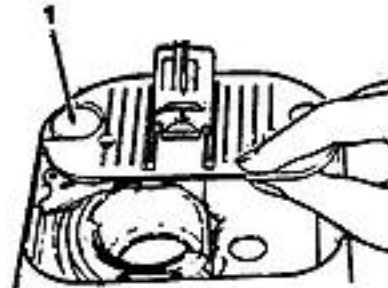

Changing screw-on presser feet (H)

- Raise needle and presser foot.
- Loosen presser foot screw (1) and remove presser foot with shank (2), guiding it toward you and to the right.
- To replace presser foot with shank, hook shank around the presser bar and tighten presser foot screw with the use of a coin.

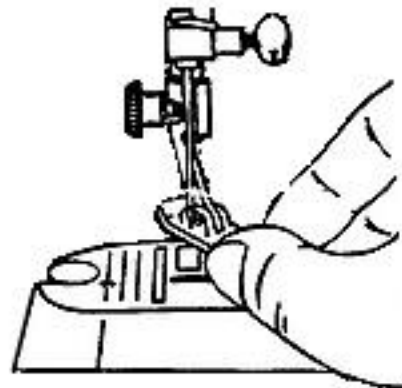

SINGER 4830 & 4832

Attaching the feed cover (F)

The feed cover is used to keep the feed from moving the fabric when attaching a button, darning or sewing free motion embroidery. To attach it, follow the directions below:

- Raise needle and presser foot.
- Open slide plate.
- Slide feed cover on top of needle plate, pressing tabs (1) and (2) into holes.
- Close slide plate.
- To remove open slide plate and lift front edge of cover; pull it away.

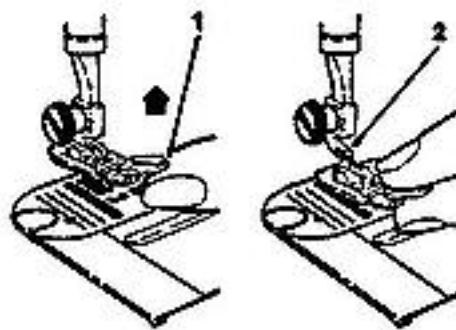
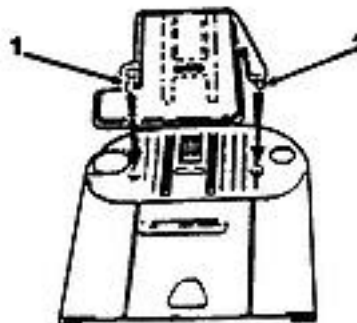

Changing snap-on presser feet (B),(D),(J),(L)

- Raise needle to its highest position by turning hand wheel toward you.
- Raise presser foot using presser foot lifter at back of machine.
- Push top of presser foot (1) up, until it snaps off the shank (2).
- Remove foot from machine.
- Place new foot under centre of shank.
- Lower presser foot lifter, fitting shank over presser foot pin (3).
- Don't turn screw. Instead, push presser foot screw (4) down, firmly until foot snaps into place.

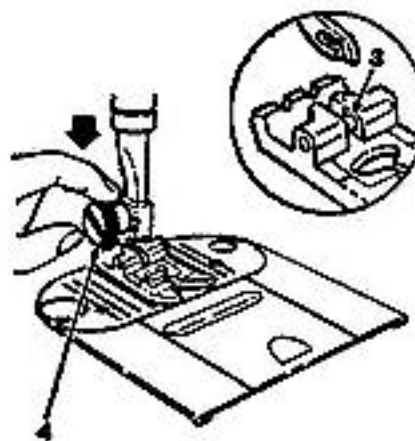

SINGER 4830 & 4832

Fabric, thread and needle table

The needle and thread you choose will depend upon the fabric being sewn, the table below is a practical guide to needle and thread selection. Always refer to it before beginning a sewing project. Be sure to use the same size and type of thread in both needle and bobbin.

The fabrics below can be of any fiber cotton, linen, silk, wool, synthetic rayon, blends. They are listed as examples of weight.			Needles	
	Fabrics	Thread	Type	Size
Light Weight	Batiste Chiffon Crepe Organza Voile	Cotton-wrapped Polyester Core 100% Polyester (Extra Fine) • Mercerized Size 50 Nylon	2020	11/80
Medium Weight	Corduroy Flannel Gabardine Gingham Linen Muslin Wool Crepe	Cotton-wrapped Polyester 100% Polyester • Mercerized Size 50 Nylon	2020	14/90
Medium Heavy	Canvas Coating Denim Duck Sailcloth Upholstery	Cotton wrapped Polyester 100% Polyester • Mercerized Size 40 • "Heavy Duty"	2020 2020	16/100 18/110
Knits	Single Knits Double Knit Jersey Tricot	Cotton-wrapped Polyester 100% Polyester Nylon	Ball-Point 2045 Size 11/80, 14/100, 16/110	

- Not recommended on stretch fabrics.

SINGER 4830 & 4832

Inserting a bobbin

- Raise presser foot.
 - Turn hand wheel toward you until needle is in its highest position.
 - Open slide plate and remove empty bobbin.
1. Pull 4" (10 cm) of thread from replacement bobbin and insert bobbin into case as shown.
 2. Holding bobbin in place guide thread into notch (1) and then down the slot to the left and guide around into notch (2).
 3. Draw several inches of thread diagonally across the bobbin toward the back of the machine.
 4. While holding thread on outside, close the slide plate allowing thread to extend through the slot between the slide plate and needle plate.

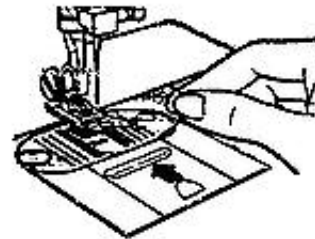
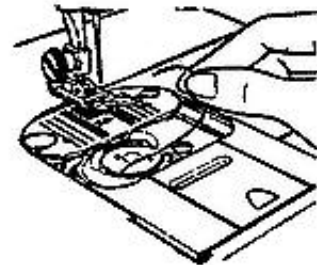
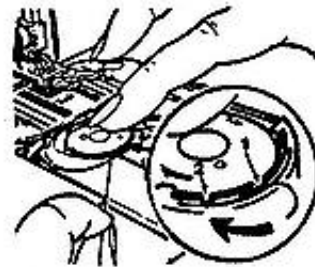
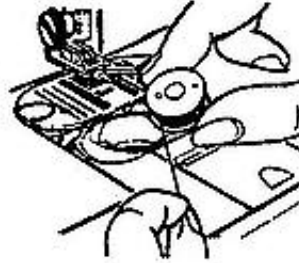

SINGER 4830 & 4832

Winding a bobbin

Winding a bobbin is quick and easy when you follow the directions below. Always wind the bobbin, before threading the machine and needle.

- Push in indent (1) on hand wheel disc. This will stop the needle from moving.
- Place spool of thread on spool pin.
- Slide spool cap (2) firmly over rim of spool to prevent thread tangling.
- Lead thread from spool and snap into thread guide post (3).
- Wind thread clockwise around front of bobbin winder tension disc (4).
- Pass thread end from inside, through small hole in rim of bobbin.
- Place bobbin on spindle and push it to the right
- Holding thread end, step on speed controller to run machine until desired amount of thread is wound. (Winding stops automatically once bobbin is full).
- Cut thread: push bobbin to the left and remove it from spindle.
- Trim thread end from top of bobbin.
- Return hand wheel disc to sewing position by pressing on side opposite indent.

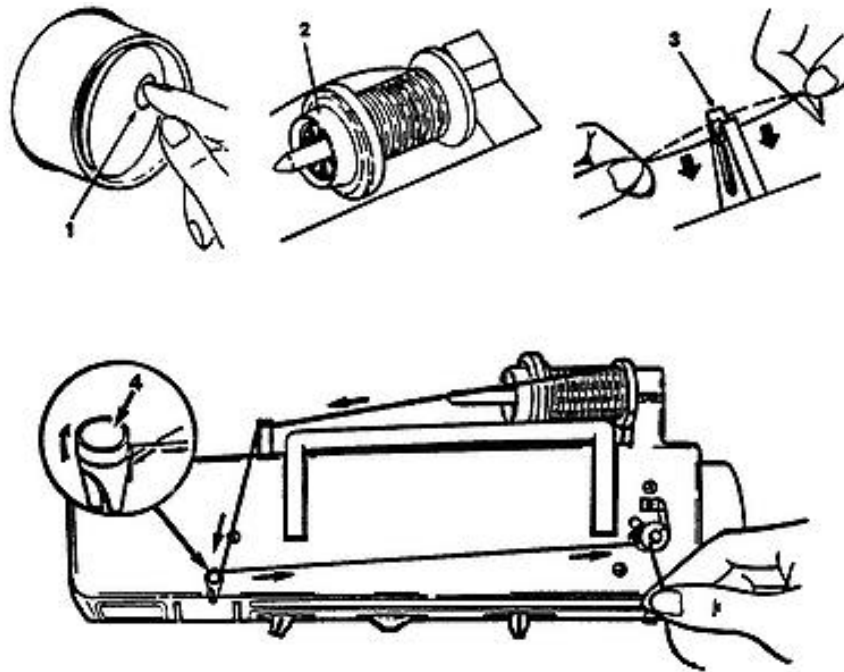

SINGER 4830 & 4832

Threading the machine

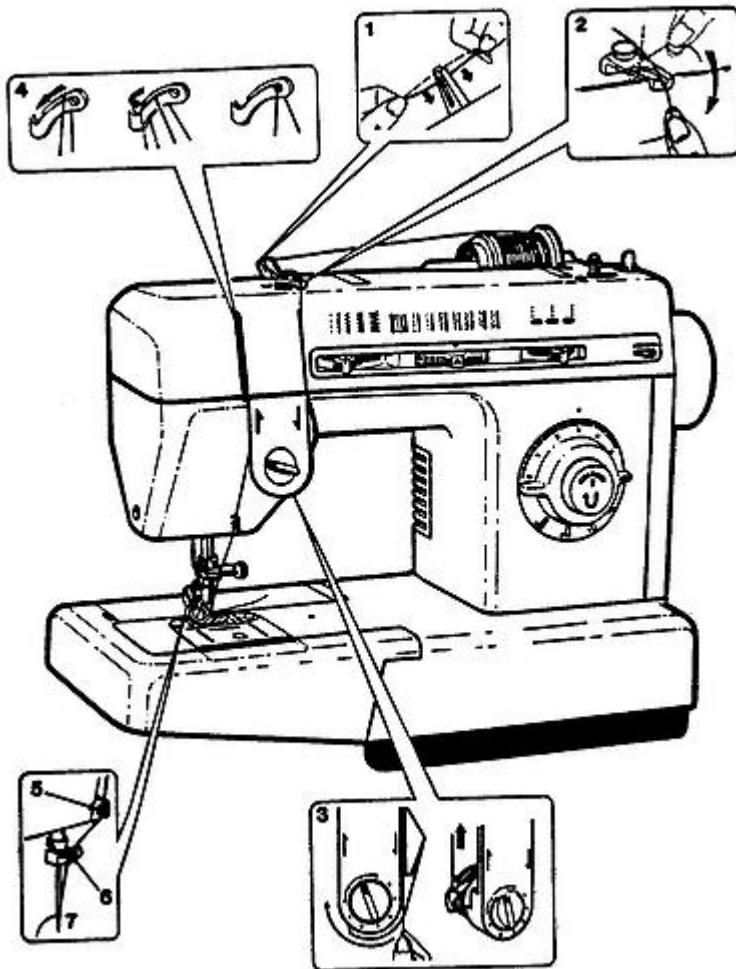

- Raise take-up lever to highest position by turning hand wheel toward you.
- Raise presser foot to release thread tension.
- Place spool of thread on spool pin.
- Slide spool cap firmly over rim of spool to prevent thread tangling.
- Lead thread from spool and snap into thread guide (1) and with only one hand pass the thread under the guide and through the slot, as illustrated (2)
- Thread the tension discs by leading the thread down and around the torsion (3). Hold the spool lightly and pull the thread up, lifting the spring and allowing the thread to dip into thread guard.
- Slip thread into take up lever as illustrated (4).
- Pass thread through guides (5) and (6).
- Thread needle from front to back, pulling 4" (10 cm) of thread through eye (7).

SINGER 4830 & 4832

Raising the bobbin thread

1. Hold needle thread loosely with left hand.
 - Turn hand wheel slowly toward you, lowering needle into hole in plate.
2. Continue to do this until needle rises above needle plate.
 - Pull gently on needle thread and bring up bobbin thread in a loop.
3. Open loop with fingers to find end of bobbin thread.
4. Draw needle thread through left side opening in presser foot.
 - Pull both threads to back machine.

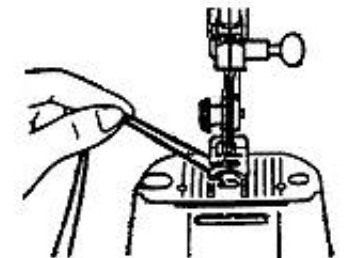
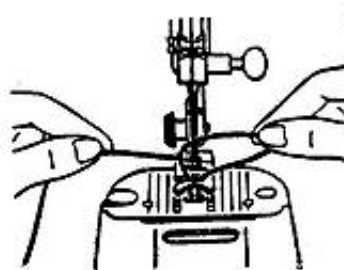
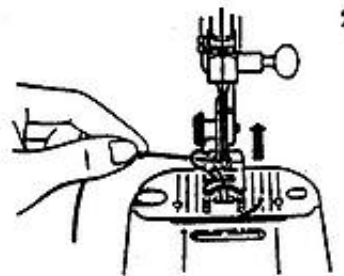
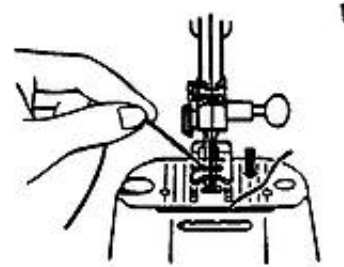

SINGER 4830 & 4832

Adjusting thread tension (For straight stitching)

A perfect, well balanced stitch (1), will have the needle and bobbin threads locked between the two layers of fabric with no loops on top or bottom and no puckering.

Too much tension will produce a tight stitch which will cause the fabric to pucker.

- To decrease tension, turn the dial to a lower number.

Too little tension will produce a loose stitch (3) which will cause loops in your seam.

- To increase tension, turn the dial to a higher number.

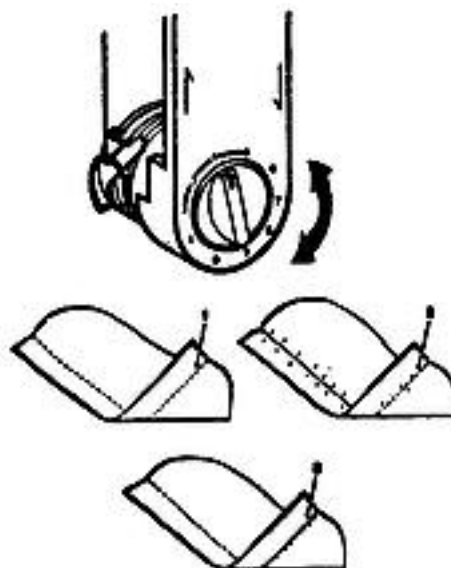

Adjusting thread tension (For zig-zag stitching)

The correct tension setting will produce a smooth even zig-zag stitch (1).

Too much tension will produce a tight zig-zag stitch (2), causing fabric to pucker. Loosen tension by turning dial to a lower number.

Too little tension will produce a loose zig-zag stitch (3), causing loops in your pattern. Tighten tension by turning dial to a higher number.

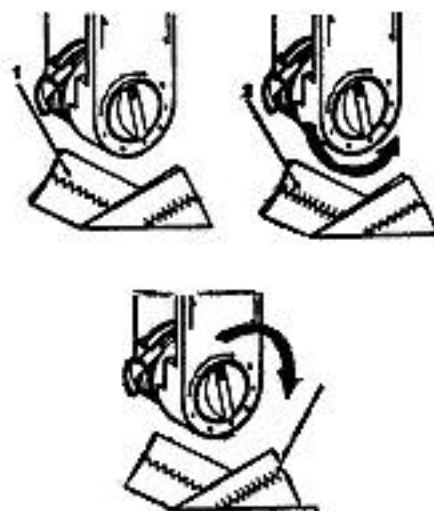

SINGER 4830 & 4832

Sewing a seam

You can sew seams easily and accurately when you follow the suggestions below.

Placing fabric under foot

Most fabrics can be placed under the foot by raising the presser foot lifter (1) to its normal "Up" position (2), where it locks in place.

When using bulky fabric multiple fabric layers or an embroidery hoop, raise the lifter to the high rise position (3), thus increasing the space between the foot and the needle plate.

- Lower presser foot lifter all the way down and you are ready to sew.

Basting

Pin basting and hand basting are easy ways to make temporary seams before machine sewing.

- To pin baste, insert pins at stitching line. **NEVER** place pins on the underside of fabric in contact with the feed. Do not sew over pins; pull them out as you stitch.
- To hand baste, make long stitches that can be easily removed

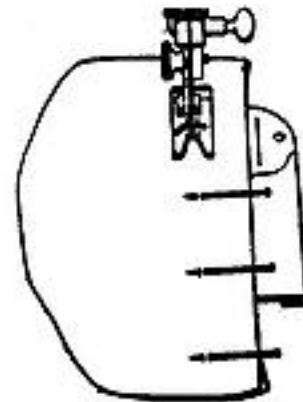
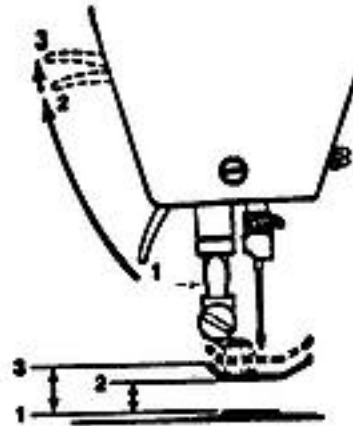

SINGER 4830 & 4832

Keeping seams straight

To keep seams straight, use one of the guidelines on the needle plate.

- The most commonly used line (1), the 5/8 Inch (1.6 cm) seam allowance, is extended onto the slide plate.

Starting seam

Place fabric under presser foot 1/2 Inch (12 mm) from rear of fabric. Align the right edge with one of the seam guidelines on the needle plate. Lower the presser foot.

Backstitch to the edge of the fabric for by pushing in the reverse button boated in centre of the stitch length dial. Hold button in until stitching reaches edge of fabric.

Release push button for forward stitching.

Guiding and supporting fabric

- For tricot, and other similar synthetic knits, apply gentle tension by holding the fabric at the front and back of presser foot as you sew. Do not pull fabric.
- For elasticated fabric, stretch lace, and knits with an unusual amount of elasticity, hold the fabric firmly in front and back of the presser foot to stretch the seam as the stitches are being placed.

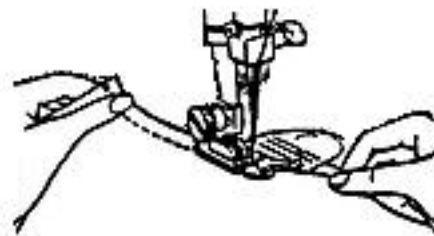
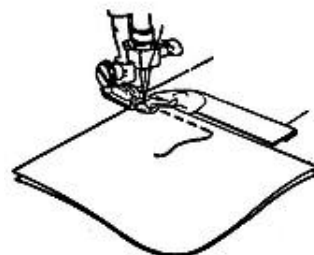
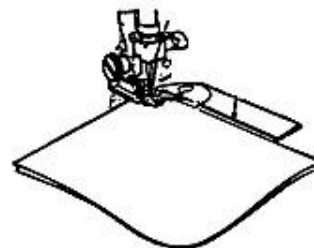

SINGER 4830 & 4832

Straight stitching Stitch width selector

Before you move the selectors to set your machine for straight stitching, turn the hand wheel toward you until needle is at its highest point.

Straight stitching can be performed with pattern selector in any position; stitch width lever must be set at (|) only.



Needle position selector

Needle Position Selector positions the needle in left (|), center (|) or right (|) needle positions.

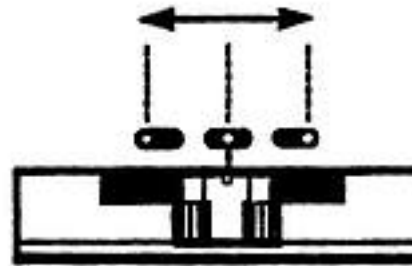

Stitch length selector

To adjust the length of your stitches, turn the dial so that desired stitch length is positioned under (•) symbol.

- To shorten stitch length, turn dial toward a lower number.
- To lengthen stitch length, turn dial toward a higher number.



SINGER 4830 & 4832

Applications with straight stitching

Darning

Recommended settings

Stitch Selection: Straight Stitch

Needle Position: 

Stitch Width: 

Stitch length: 2-5

Foot: General Purpose (B)

Needle Plate: General Purpose (A)

Attach feed cover plate (F)

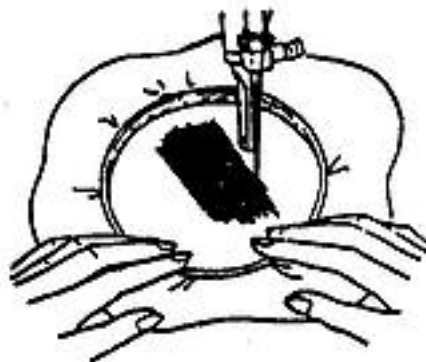

Reverse stitch button

The reverse stitch button, with the () symbol, is located in the centre of the stitch length selector.

- For reverse stitching push in the button and hold in place. The machine will stitch in reverse only as long as you keep the button pushed in.



Sewing in reverse

To neaten the end of a seam, push in the reverse button and backstitch 3-4 stitches

Raise needle and presser foot and remove fabric by drawing it to the back and left. Cut thread on thread cutter on presser bar.

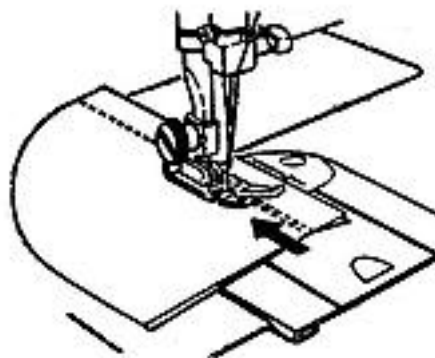

SINGER 4830 & 4832

Inserting a zipper

Preparation

Pattern: ;

Needle position: 

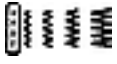
Stitch width: 

Stitch length: 2-5

Foot: Zipper (E)

Needle plate: General Purpose (A)

Adjusting the zipper foot

When the zipper teeth are to the left of the needle (A):

- Slide the adjusting block, (1) which slides on the pin, across to the right.
- Snap-on the foot to the left side of the pin.

When the zipper teeth are to the right of the needle (B):

- Slide the adjusting block (1) across to the left.
- Snap on the foot to the right side of the pin.

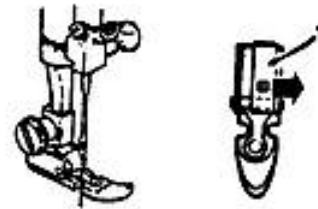

A

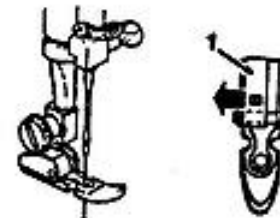
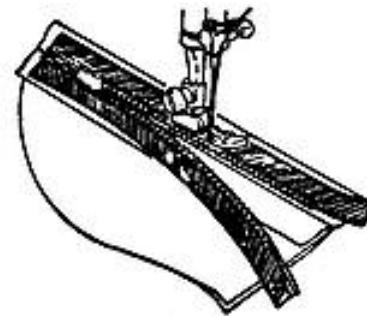

B

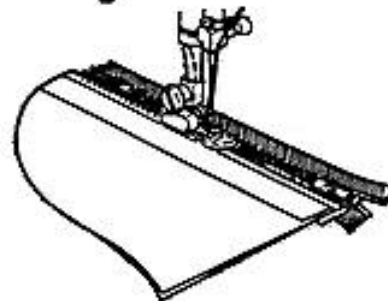



SINGER 4830 & 4832

Zig zag stitching

Before moving selector, make sure needle is fully raised.

Needle position selector

Most of your zig-zag stitching will be done with the needle in the centre () position.

Left () and right () settings are used for special stitch placement.

Stitch width selector

To produce any of the zig-zag stitches, the stitch width selector is moved from its straight position () to any of its other positions. The further you move the selector lever toward the right, the wider your stitch will be.

Adjusting stitch length

Any stitch length setting from 1 to 5 will give you an open zig-zag stitch.

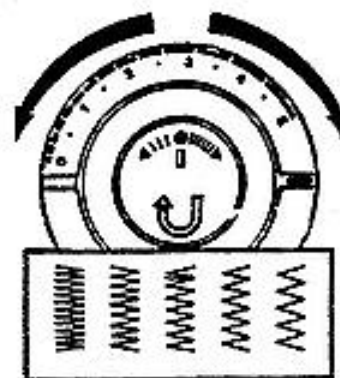
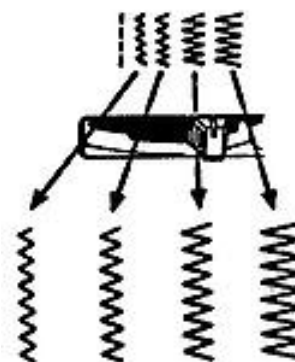
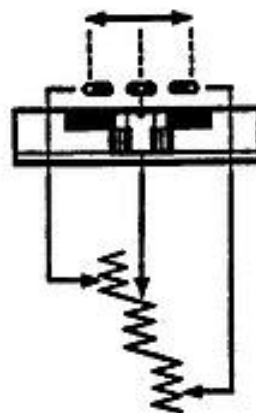

The higher the number, the more open, or further apart your stitches will be.

The area between **0** and **1** on the dial is used for satin stitching, a series of closely spaced plain zig-zag stitches that form a smooth satin-like surface.



SINGER 4830 & 4832

Pattern groups selection

- The dial localized on panel on your machine, lets you choose pattern groups.
- Raise the needle to its highest position.
- Adjust the stitch width selector to straight position ().
- This will see to it that the stitch pattern dial moves far easier.
- In order to single out the desired pattern group, just turn the dial until the corresponding letter to this pattern group appears on the dial, under symbol ().
- After carrying out the embroidery selection, turn back the stitch width selector to the zig-zag position ().
- Adjust the stitch length as indicated on each kind of embroidery (from 1/2 to 2 1/2).

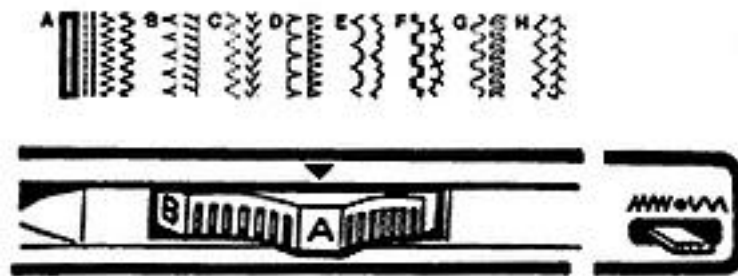

SINGER 4830 & 4832

Flexi stitch patterns

Note: The pattern groups selection, needle position selection on and stitch width selection are similar to zig-zag stitching.

These stitch patterns are used for sewing knits and other stretch fabrics. Flexi Stitch patterns are made by the side to side movement of the needle along with the backward and forward movement of the feed.

The flexi-stitch, only accepts stitches works which on panel, are to the right of each pattern group.

Act upon the following manner:

- Turn the stitch length dial to the left until the dot on the dial lines up with the dot on the machine, as shown.



Notes: If for any reason the machine does not start sewing your desired pattern after aligning the two dot symbols, push in on the reverse stitch button.

SINGER 4830 & 4832

Balancing flexi-stitches

You may need to adjust the Flexi-stitch Balance selector when using a flexi-stitch pattern in order to achieve the correct pattern appearance.





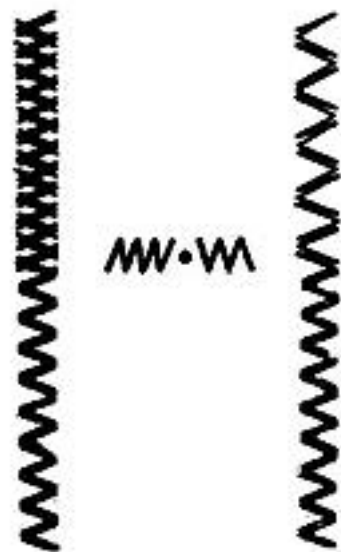





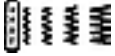

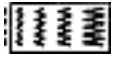

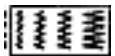

Before you move the stitch balance dial from its neutral position, make a test sample using two layers of scrap fabric if adjustment is required stitch slowly and move the selector you sew.

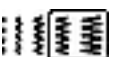
- Move selector to the right to separate stitches of pattern.
- Move selector to the left to bring stitches of the pattern together.













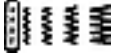





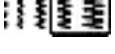



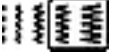

SINGER 4830 & 4832

Decorative stitch patterns

Pattern	Needle position	Stitch width	Stitch length	Foot	Needle plate	Application
Straight stitch 1 -----			Any setting	General purpose	General purpose	General sewing
Zig-zag stitch ~~~~~			Any setting	General purpose	General purpose	Stretch sewing and embroidery
Blind hem stitch ~~~~~			1.5 to 2.5	Special for blindstitch	General purpose	Finishing hems
Multi zig-zag stitch ~~~~~			1.0 to 2.0	Special purpose	General purpose	Bar tacking
Overedge Sttch ~~~~~			1.0 to 2.0	Special purpose	General purpose	Seams in knit and stretch fabric
Crescent stitch ~~~~~			0 to 2.0	Special purpose	General purpose	Ornamental borders
Domino stitch ~~~~~			0 to 2.0	Special purpose	General purpose	Decorative stitching
Rampart stitch ~~~~~			1.0 to 2.0	Special purpose	General purpose	Borders and smocking
Fagotting stitch ~~~~~			1.0 to 2.0	Special purpose	General purpose	Swimsuit seams

SINGER 4830 & 4832

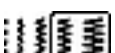
Flexi-stitch patterns

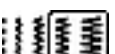
Pattern	Needle position	Stitch width	Stitch length	Foot	Needle plate	Application
Straight stitch 1 -----			(I)	Special purpose	General purpose	Ideal for plain seams that stretch
Ric-rac stitch 			(I)	Special purpose	General purpose	Heavy-duty general purpose sewing
Slant overedge stitch (left) 			(I)	Special purpose	General purpose	Sweater and swimsuit construction
Feather stitch 			(I)	Special purpose	General purpose	Flexible seam in lingerie
Overedge stretch stitch 			(I)	Special purpose	General purpose	Joining and overcasting seams
Mountain stitch 			(I)	Special purpose	General purpose	Hemming and ornamental edges
Crown stitch 			(I)	Special purpose	General purpose	Edge decoration
Chevron stitch 			(I)	Special purpose	General purpose	Classical decorative seams
Thorn stitch 			(I)	Special purpose	General purpose	Ideal for flat-butted seam

SINGER 4830 & 4832

Attaching a button

Recommended settings:

Stitch Selection: Zig-Zag Stitch



Needle Position:   

Stitch Width: To suit Button Sewing (H)
(Additional Accessory)

Needle Plate: General Purpose (A)

Attach Feed Cover (F)

Note: Before you can attach a button, the bobbin thread must be brought up through the hole in the feed cover.

1. Set stitch width at () and needle position selector at (). Position button under foot and lower the needle into the center of the left hole. Lower the foot. Turn hand wheel toward you until needle rises out of button and is above the foot.
2. Move stitch width selector until needle is over the other hole in the button. Then, when you begin to stitch, the needle should enter into the right hole of the button. Take six or more zig-zag stitches to attach button and finish with the needle on the left side.
3. To fasten stitching, adjust width to () and take three or four stitches. Remove work, draw threads to underside, fasten, and trim.

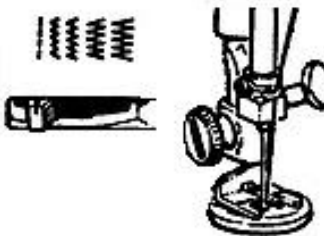
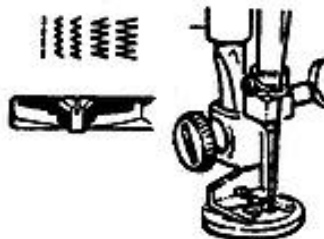
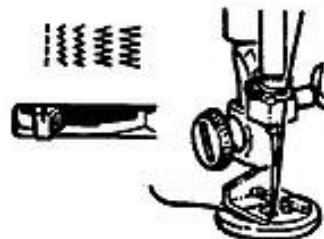
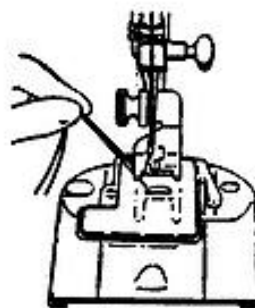

SINGER 4830 & 4832

Free-arm sewing Removing the extension table

To change machine for free arm sewing, lift right edge (1) of extension table. Slide it to the left and off the machine (2).

To replace the extension table, slide it to the right keeping it even with the free-arm, until the tabs on the right lock into place.

Fabric handling, when sewing tubular and hard to reach garment areas, is simplified and made easier when you use the free-arm sewing capability of your sewing machine.

Applications Sleeves

- Free-arm sewing takes the difficulty out of topstitching, sleeves, finishing waistbands and trouser legs rotate smoothly under the needle, around the arm, allowing you to place your stitching accurately.

Buttons

- Sewing buttons on a cuff or neckband is easy with free arm sewing. The sewing arm allows room for cuffs to slip onto without being stretched out of shape, and you can also see and handle the stitching area more easily.

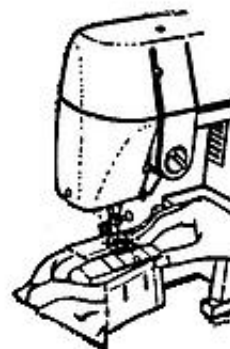
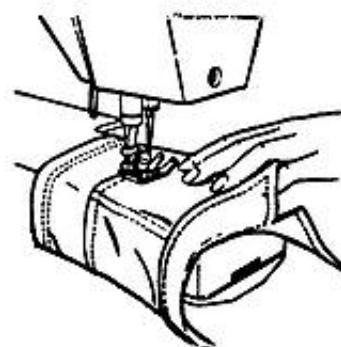

SINGER 4830 & 4832

Bar tacks

- Bar tacks reinforce areas of strain and can be applied to ready-made garments, as well as to those sewn at home. Use the free-arm surface to avoid fabric bulk around the needle when you apply bar tacks to pockets, pleats and waistlines.

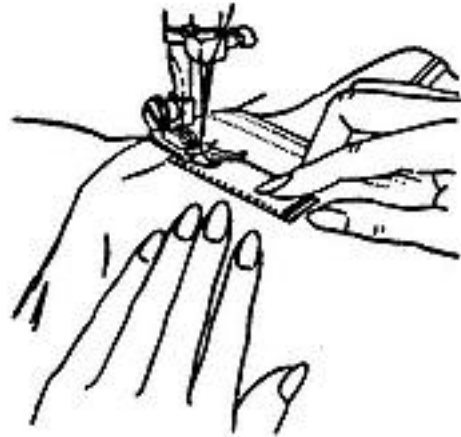

Four step buttonhole

Your machine makes buttonholes to any size you choose in only four easy steps.

- You never need to move the fabric or reposition the needle.
- Always make a practice buttonhole on a sample of your fabric.
- Be sure bobbin contains enough thread.
- When making buttonholes on hard-to-reach areas convert machine bed to free-arm sewing.
- Mark buttonhole position on fabric as indicated in pattern.

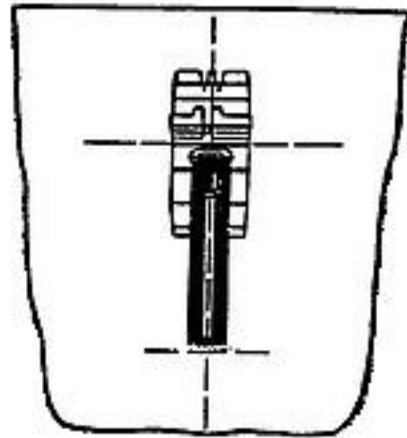

SINGER 4830 & 4832

Buttonholes

Recommended settings:

Stitch Selection: Buttonhole Stitch

Stitch Width: Pre-set

Foot: Buttonhole (L)

Needle Plate: General Purpose (A)

Step 1

- Raise presser foot.
- Place fabric under foot
- Centre **3** red guidelines (**1**) of foot around beginning line of buttonhole.
- Turn buttonhole dial to the buttonhole symbol (**1**) for the first step
- Position needle in fabric at point (**2**) by turning the hand wheel towards you.
- Stitch down to point (**3**).

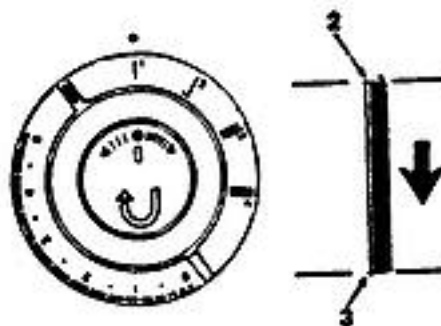
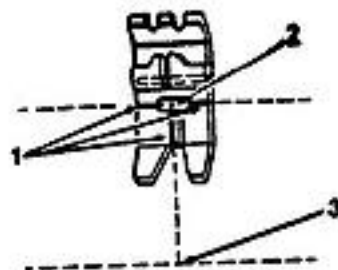

Step 2

- Raise needle out of fabric.
- Turn buttonhole dial to the buttonhole symbol (**2**) for the second step.
- Make at least four stitches ending at point(4).

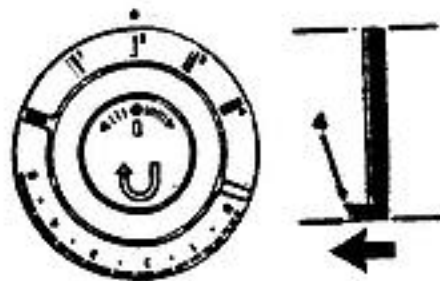

SINGER 4830 & 4832

Step 3

- Raise needle out of fabric.
- Turn buttonhole dial to the buttonhole symbol (3) for the third step.
- Stitch up to point (5).

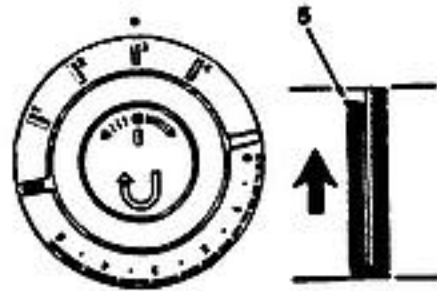

Step 4

- Raise needle out of fabric.
- Turn buttonhole dial to the buttonhole symbol (4) for the fourth step.
- Make at least four stitches, ending at point (6).
- Rake presser foot and remove garment from machine.
- Clip thread ends.
- Carefully cut buttonhole opening with a seam ripper or small, sharp scissors.

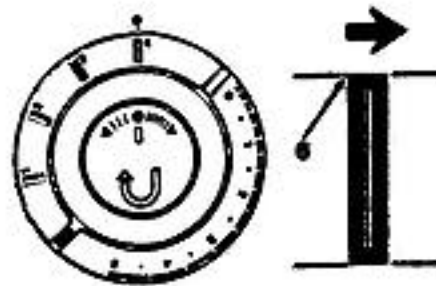

SINGER 4830 & 4832

Balancing the buttonhole

On some kinds of fabrics, there may be a difference in the density of the stitches on the right or the left side of the buttonhole.

This is easily adjusted by turning the balance knob (1), in the center of the stitch length dial to balance the density of the stitching.

A very slight turn of the dial will produce a noticeable change.

- If the stitches on the right side of the buttonhole (I) are too open, turn the balance dial slightly to the right, until the density of the stitches increases.
- If the stitches on the left side of the buttonhole (II) are too open, turn the balance slightly to the left, until the density of the stitches increases.

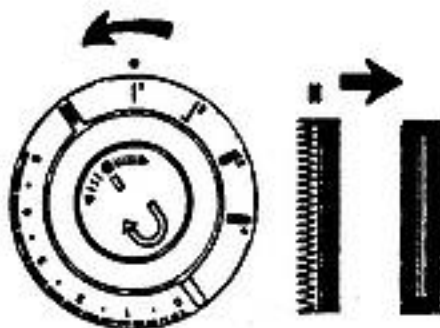
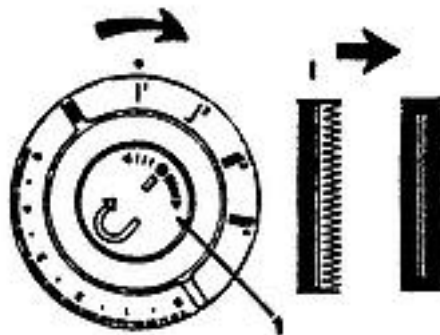

SINGER 4830 & 4832

Twin needle sewing Additional accessory

Caution: Make sure not to use a stitch width greater than that what is recommended when twin needle stitching.

Recommended settings

Stitch Selection: Desired stitch

Needle Position: 

Stitch Width: 

Stitch Length: 2-5

Foot: General Purpose (B)

Needle Plate: General Purpose (A)

Procedure

- Turn the machine off.
- Insert the twin needle with the flat side of the shank toward the rear of the machine.
- Thread the machine as you normally would for single needle stitching, and pass the thread through the left eye of the twin needle
- Insert a second spool pin into the hole on the top cover of the machine as illustrated.
- Thread the machine in the usual way.
- Pass the thread through the remaining point, making certain to omit the thread guide just above the needle and pass thread through right eye of needle.
- Draw both threads under the foot and back along with the bobbin thread.
- Slowly lower the needle into the hole in the needle plate by turning the hand wheel toward you to make sure the needle clear the plate.

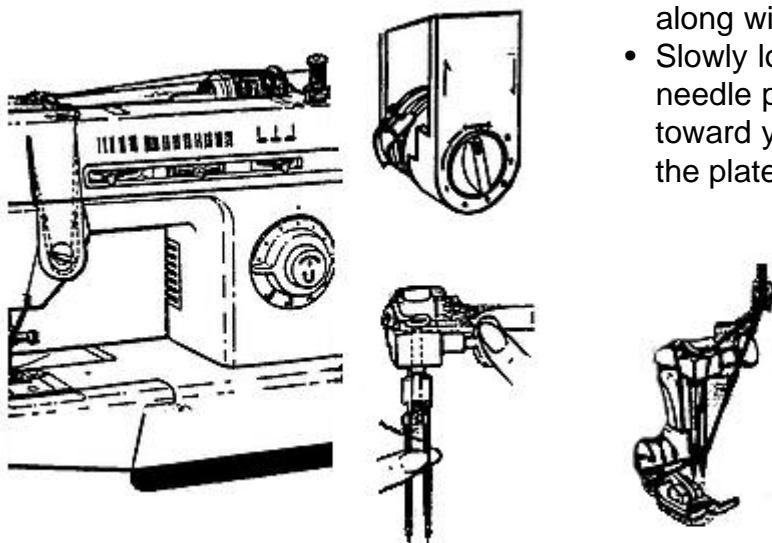

SINGER 4830 & 4832

Additional accessories

Additional Accessories for your sewing machine are available for purchase at your SINGER stockist.

1. Straight stitch presser foot (D) and needle plate (C) are used together when straight stitching lightweight fabric or when your fabric or sewing procedure requires close control.
2. Button sewing foot (H) is used to hold any two-hole or four-hole button securely for stitching.
3. Lint brush is used for cleaning hard to reach areas on your sewing machine.
4. Oil container for machine lubrication.
5. Twin needle and spool pin are used to ditch two parallel rows of decorative stitching simultaneously. When using twin-needle for decorative stitching set stitch width selector no greater than midrange of zig zag graphics.
6. Felt for twin needle spool pin.

Accessory storage

The accessories leave from factory in this area.



SINGER 4830 & 4832

Caring for your machine Removing and replacing bobbin case

Caution: Before cleaning or adjusting the machine, remove plug from the socket outlet.

- Raise presser foot and needle.
- Open slide plate, remove bobbin and remove needle plate.

To remove bobbin case

- With a small screwdriver, turn bobbin case holder (1) to the rear as far as it will go.
- Lifting the left side of the bobbin case, slide it out from machine.

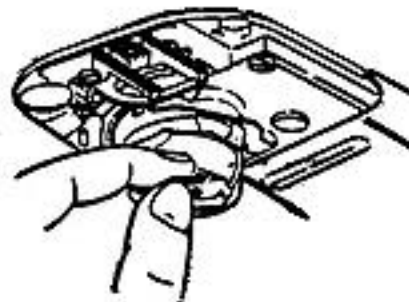

To replace bobbin case

- Guide forked end (2) of bobbin case under feed (3).
- Draw rim of bobbin ease under position plate (4). Be sure bobbin ease is freely seated on hook race.
- Turn bobbin case holder (1) forward as far as it will go, locking bobbin case in place.

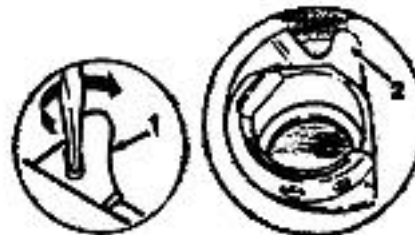

Note: Turn handwheel towards you to check to make sure it is properly replaced.

- Replace needle plate.
- Insert bobbin and close slide plate.



SINGER 4830 & 4832

Cleaning the machine

The machine surfaces and covers can be cleaned when necessary with a damp cloth and a mild soap. Remove lint and fluff from parts and with a flat brush clean these parts:

- Take up lever and thread guide.
- Presser and needle bars.
- Bobbin case and needle plate areas.

Your machine should be periodically checked by your local SINGER dealer for wear.

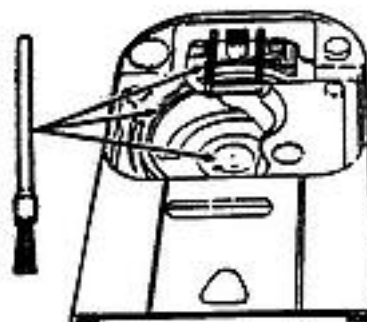
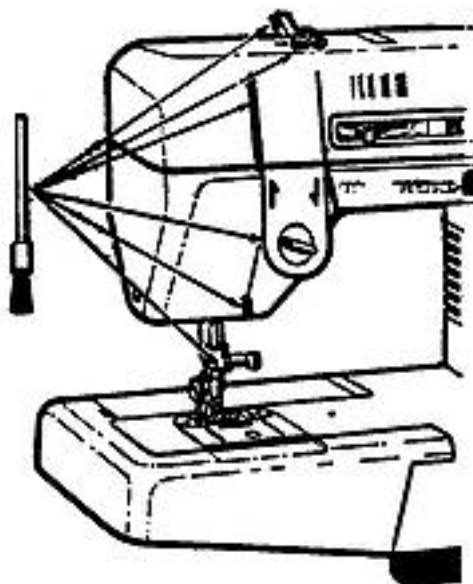

SINGER 4830 & 4832

Lubricating the machine

Approximately once a year, lubricate all moving connections, as shown, to ensure freedom of movement and to protect metal parts from excessive wear.

To determine which connections move and need lubrication, turn the handwheel slowly, by hand, while face plate is removed.

When lubricating, apply only SINGER oil at the points shown. SINGER oil is specially prepared and does not contain harmful deposits that can interfere with the smooth action of precision parts.

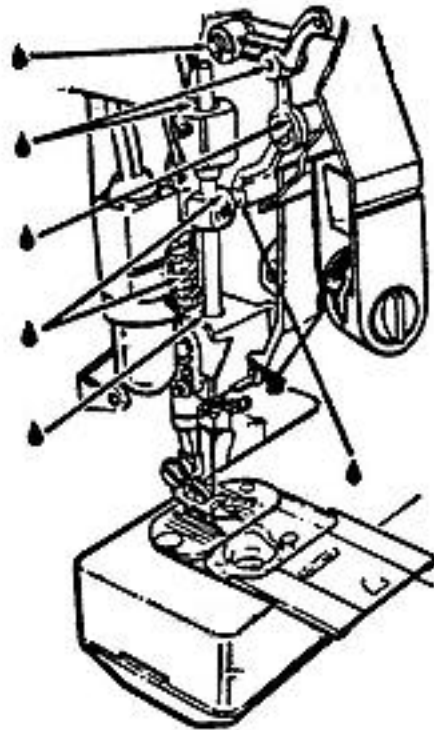

SINGER 4830 & 4832

Changing the light bulb

Caution: Before changing light bulb, make sure you have removed plug from socket outlet and remove face plate which covers the light bulb. Be sure to replace the face plate which covers the light bulb before operating the machine.

This machine is designed to use a 15 watt maximum light bulb with a bayonet fitting.

1. Removing bulb

- Loosen and remove screw (1) located on face plate.
- Remove face plate by grasping it around the bottom edge and pulling toward the left, then down and away from machine.
- Do not attempt to unscrew light bulb.
- Push bulb up into socket and turn in the direction of arrows to unlock bulb pin.
- Pull bulb down and out of socket.

2. Replacing bulb

- Push new bulb up into socket and turn in the direction of arrows until pins lock into position.
- Replace face plate again and tighten screw.

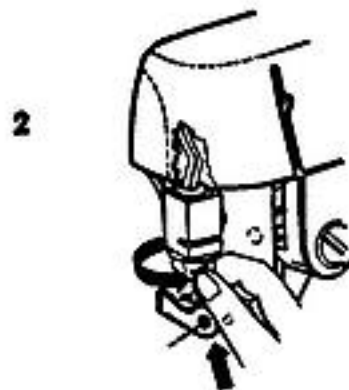
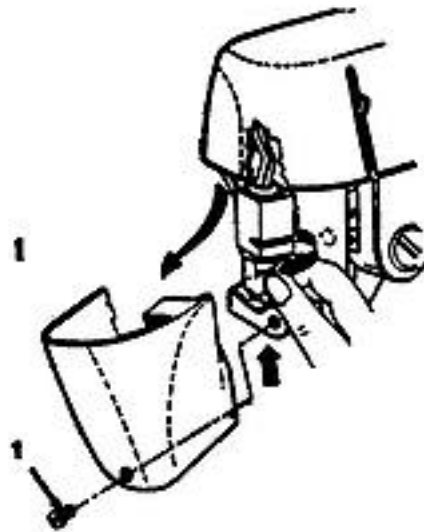

Performance Checklist

When sewing difficulties occur, look back through this manual to make sure you are correctly following the instructions. If you still have a problem, the reminders below may help you to correct it.

Needle does not move

Is machine connected to electrical supply?
Is the power and light switch on?
Is controller connected?
Is the handwheel engaged for bobbin winding?

Needle moves but stitch is not formed

Is needle defective?
Is needle fully inserted into needle clamp?
Are bobbin and needle correctly threaded?
Is bobbin correctly inserted into bobbin case?

Needle breaks

Is needle straight and sharp?
Is needle correct size?
Is needle fully inserted into needle clamp?
Are controls properly set?
Are accessories correct for applications?

Bobbin winding difficulties

Is thread unwinding freely from spool?
Is bobbin winder engaged?
Is thread end securely held at start of wind?
Is thread hanging up on the slit on the thread spool?

Upper thread breaks

Is machine properly threaded?
Is thread freely unwinding from spool?
Is proper spool cap being used?
Is needle correct size for thread?
Is upper thread tension too tight?
Is bobbin case properly inserted?
Is bobbin rim free of nicks?

Lower thread breaks

Is bobbin correctly wound?
Is bobbin correctly inserted into bobbin case?
Is bobbin case correctly threaded?
Is thread hanging up on the slit on the thread spool?

Skipped stitches

Is machine properly threaded?
Is fabric firmly held down?
Is needle correct style and size?
Is needle straight and sharp?

Fabric does not move properly under presser foot

Is presser foot correctly attached to machine?
Is presser foot lowered?
Is stitch length correctly set?