



Digital Still Camera  
DSC-W800  
Cyber-shot



Use this Help Guide when you have any questions on how to use the camera.

## How to use

[Before Use](#)



[Confirming the operation method](#)



[Shooting](#)



[Useful shooting functions](#)



[Viewing](#)



[Changing settings](#)



[Using with your computer](#)



[Precautions/About this camera](#)



## Troubleshooting

[If you have problems](#)



---

[Troubleshooting](#)



---

[Warning indicators and messages](#)



---

[Situations this camera has difficulty handling](#)



---

 List of Topics

---

[How to use](#)



---

[Troubleshooting](#)



---

### Notes on use

4-533-356-11(1)

Copyright 2014 Sony Corporation

Digital Still Camera  
DSC-W800

## Before Use

---

[Names of parts](#)



[List of icons displayed on the screen](#)



[Using the strap](#)



[Using the internal memory](#)



## Notes on use

4-533-356-11(1)

Copyright 2014 Sony Corporation



Digital Still Camera  
DSC-W800

Confirming the operation method

---

[Confirming the operation method](#)



[Notes on use](#)

4-533-356-11(1)

Copyright 2014 Sony Corporation

Digital Still Camera  
DSC-W800

## Shooting

---

[Shooting images](#)



[Selecting the shooting mode based on the subject](#)



### Notes on use

4-533-356-11(1)

Copyright 2014 Sony Corporation

Digital Still Camera  
DSC-W800

## Useful shooting functions

---

[Zoom](#) 

---

[Using the flash](#) 

---

[Selecting image size](#) 

---

[Adjusting the focus](#) 

---

[Advanced shooting](#) 

---

### [Notes on use](#)

4-533-356-11(1)

Copyright 2014 Sony Corporation

Digital Still Camera  
DSC-W800

## Viewing

---

[Viewing still images](#) >

---

[Deleting images](#) >

---

[Viewing movies](#) >

---

[Viewing panorama images](#) >

---

[Printing still images](#) >

---

[Useful viewing functions](#) >

---

[Viewing images on a TV](#) >

---

### [Notes on use](#)

4-533-356-11(1)

Copyright 2014 Sony Corporation

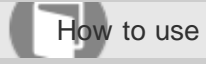

Digital Still Camera  
DSC-W800

Changing settings

---

[Setup menu](#)

---



[Notes on use](#)

4-533-356-11(1)

Copyright 2014 Sony Corporation



Digital Still Camera  
DSC-W800

## Using with your computer

---

[Recommended computer environment](#)



[Using the software](#)



[Connecting the camera to the computer](#)

---



### [Notes on use](#)

4-533-356-11(1)

Copyright 2014 Sony Corporation

Digital Still Camera  
DSC-W800

Precautions/About this camera

---

[Precautions](#)



[On cleaning](#)



[Number of still images and recordable time of movies](#)



[Using the camera abroad](#)



[About this camera](#)



[Trademarks](#)



[Notes on use](#)

4-533-356-11(1)

Copyright 2014 Sony Corporation



Digital Still Camera  
DSC-W800

If you have problems

---

[If you have problems](#)



[Notes on use](#)

4-533-356-11(1)

Copyright 2014 Sony Corporation

Digital Still Camera  
DSC-W800

Troubleshooting

---

[Battery pack and power](#)



[Shooting still images/movies](#)



[Viewing images](#)



[Computers](#)



[Memory card](#)



[Internal memory](#)



[Printing](#)



[Others](#)



[Notes on use](#)

4-533-356-11(1)

Copyright 2014 Sony Corporation



Digital Still Camera  
DSC-W800

Warning indicators and messages

---

[Warning indicators and messages](#)



[Notes on use](#)

4-533-356-11(1)

Copyright 2014 Sony Corporation



Digital Still Camera  
DSC-W800

Situations this camera has difficulty handling

---

[Situations this camera has difficulty handling](#)



[Notes on use](#)

4-533-356-11(1)

Copyright 2014 Sony Corporation

Digital Still Camera  
DSC-W800

## How to use

---

### Before Use

#### Names of parts

- [Names of parts](#)

#### List of icons displayed on the screen

- [List of icons displayed on the screen](#)

#### Using the strap

- [Using the wrist strap](#)

#### Using the internal memory

- [Using internal memory](#)

### Confirming the operation method

#### Confirming the operation method

- [Using the control button](#)
- [Using MENU items \(Shooting\)](#)
- [Using MENU items \(Viewing\)](#)
- [Changing camera settings](#)

### Shooting

#### Shooting images

- [Shooting still images](#)
- [Shooting movies](#)

#### Selecting the shooting mode based on the subject

- [Still Shooting Scene](#)
- [Intelligent Auto](#)
- [Scene Recognition](#)
- [Program Auto](#)
- [Shooting panoramic images](#)
- [Scene Selection](#)
- [Party](#)

### Useful shooting functions

## Zoom

- [Zoom](#)
- [Digital Zoom](#)

## Using the flash

- [Flash](#)

## Selecting image size

- [Image size](#)
- [Image size when shooting Sweep Panorama](#)
- [Image size when shooting movies](#)

## Adjusting the focus

- [Focus](#)
- [TRACKING FOCUS](#)

## Advanced shooting

- [Easy Mode](#)
- [Shooting Direction in Sweep Panorama](#)
- [AF Illuminator](#)
- [Exposure Compensation](#)
- [Metering Mode](#)
- [Cont. Shooting Settings](#)
- [Self-Timer](#)
- [DRO](#)
- [ISO](#)
- [White Balance](#)
- [Picture Effect](#)
- [Color hue](#)
- [Extracted Color](#)
- [Face Detection](#)
- [Red Eye Reduction](#)
- [SteadyShot](#)
- [Write Date](#)
- [Grid Line](#)

## Viewing

### Viewing still images

- [Viewing still images](#)
- [Playback zoom](#)
- [Image Index](#)
- [Easy Mode](#)

### Deleting images

- [Deleting images](#)

### Viewing movies



- [Viewing movies](#)

Viewing panorama images

- [Playing back panoramic images](#)

Printing still images

- [Print \(DPOF\)](#)
- [Printing still images](#)

Useful viewing functions

- [Rotate](#)
- [Protect](#)

Viewing images on a TV

- [Viewing an image on a Standard Definition \(SD\) TV](#)

Changing settings

Setup menu

- [Disp. Resolution](#)
- [Beep](#)
- [Volume](#)
- [Monitor Brightness](#)
- [Language Setting](#)
- [Initialize](#)
- [Function Guide](#)
- [Display Setting](#)
- [Video Out](#)
- [USB Connect Setting](#)
- [USB Power Supply](#)
- [LUN Setting](#)
- [Eye-Fi](#)
- [Power Save](#)
- [Format](#)
- [Create REC.Folder](#)
- [Change REC.Folder](#)
- [Delete REC.Folder](#)
- [Copy](#)
- [File Number](#)
- [Area Setting](#)
- [Date & Time Setting](#)

Using with your computer

Recommended computer environment

- [Recommended computer environment](#)

Using the software

## [PlayMemories Home](#)

- [Installing PlayMemories Home](#)
- [Software for Mac](#)

## Connecting the camera to the computer

- [Connecting the camera to the computer](#)
- [Importing images to a computer](#)
- [Disconnecting the camera from the computer](#)

## Precautions/About this camera

### Precautions

- [Precautions](#)
- [Backup of various settings, date and time](#)
- [Battery pack](#)
- [Notes on charging the battery pack](#)
- [Memory card](#)

### On cleaning

- [On cleaning](#)

### Number of still images and recordable time of movies

- [Number of still images](#)
- [Recordable time of movies](#)

### Using the camera abroad

- [Using the camera abroad](#)
- [On TV color systems](#)

### About this camera

- [License](#)

### Trademarks

- [Trademarks](#)

## [Notes on use](#)

4-533-356-11(1)

Copyright 2014 Sony Corporation

Digital Still Camera  
DSC-W800

## Troubleshooting

---

If you have problems

If you have problems

- [If you have problems](#)

## Troubleshooting

Battery pack and power

- [Cannot insert the battery pack into the camera](#)
- [Cannot turn on the camera](#)
- [Power turns off suddenly](#)
- [Remaining charge indicator is incorrect](#)
- [Charge lamp of the camera flashes while charging the battery](#)
- [Battery is not charged even if the Charge lamp turns off and charging is finished](#)

Shooting still images/movies

- [Cannot record images](#)
- [Image is blurred](#)
- [Image is out of focus](#)
- [Zoom does not work](#)
- [Cannot select the Face Detection function](#)
- [Flash does not work](#)
- [Fuzzy white circular spots appear in images shot using flash](#)
- [Close-up shoot function \(Macro\) does not work](#)
- [Date and time are not displayed on the screen](#)
- [F value and shutter speed flash when you press and hold the shutter button halfway down](#)
- [Image colors are not correct](#)
- [White or purple streaks appear in bright areas of the subject, or the whole screen of the image becomes reddish](#)
- [Noise appears in the image when you view the screen in a dark place](#)
- [Eyes of the subject come out red](#)
- [Dots appear and remain on the screen](#)
- [Cannot shoot images in succession](#)
- [Same image is shot several times](#)

Viewing images

- [Cannot play back images](#)

- [Date and time are not displayed](#)
- [Cannot display images in index mode](#)

## Computers

- [Your computer does not recognize the camera](#)
- [Cannot import images](#)
- [Image and sound are interrupted by noise when you view a movie on a computer](#)
- [Images once exported to a computer cannot be viewed on the camera](#)

## Memory card

- [You have formatted a memory card by mistake](#)
- [Images are recorded on internal memory even when a memory card is inserted into the camera](#)

## Internal memory

- [Cannot play back or record images using internal memory](#)
- [Cannot copy stored data in internal memory to a memory card](#)
- [Cannot copy memory card data or computer data to internal memory](#)

## Printing

- [Images are printed with both edges cut off](#)
- [Cannot print images with date](#)

## Others

- [The lens gets fogged](#)
- [Camera turns off with the lens portion extended](#)
- [Camera becomes warm when you use it for a long time](#)
- [Clock Set screen appears when you turn on the camera](#)
- [Date or time is incorrect](#)

## Warning indicators and messages

### Warning indicators and messages

- [Messages](#)

## Situations this camera has difficulty handling

### Situations this camera has difficulty handling

- [Situations this camera has difficulty handling](#)

## Notes on use

4-533-356-11(1)

Copyright 2014 Sony Corporation



## Before use

To make full use of this content, please read the following notes thoroughly. Please note that they are subject to change without prior notice.

## Recommended system environment

The following system environments are recommended for displaying this content. You may not be able to view the content on other system environments.

### ■ For viewing on a computer

#### Recommended browser

- With Microsoft Windows
  - Microsoft Internet Explorer 8 or later
  - Mozilla Firefox: latest version
  - Google Chrome™ : latest version
- With Apple Mac OS
  - Apple Safari Ver. 5 or later
  - Mozilla Firefox: latest version
  - Google Chrome : latest version

### ■ For viewing on a smartphone or tablet

Basic operation has been confirmed on the standard browser for the noted devices running the following operating systems.

- Android™ 2.3 or later: Xperia series, Walkman running Android
- iOS 4 or later: iPhone, iPod touch, iPad

### ■ JavaScript

JavaScript is used with this content for viewing convenience. If JavaScript is disabled in your web browser settings, the content may not operate properly or it may not be displayed correctly.

### ■ Style Sheets

Cascading Style Sheets are used in designing this content. Page layout may not be as intended if you view the content with style sheets disabled or on a web browser that is not compatible with style sheets. However, operation will not be affected.

### ■ Cookies

This content uses cookies. To use services incorporating cookies, you need to set your browser to allow cookies.

## Handling of personal information obtained from websites

Sony may use cookies, web beacons or similar technologies to make statistical analysis of customers' usage of this content while preserving anonymity.

### Notes on use

4-533-356-11(1)

Copyright 2014 Sony Corporation

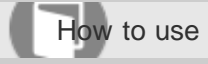

Digital Still Camera  
DSC-W800

Names of parts

---

[Names of parts](#)



[Notes on use](#)

4-533-356-11(1)

Copyright 2014 Sony Corporation



Digital Still Camera  
DSC-W800

List of icons displayed on the screen

---

[List of icons displayed on the screen](#)



[Notes on use](#)

4-533-356-11(1)

Copyright 2014 Sony Corporation





Digital Still Camera  
DSC-W800

## Using the strap

---

### [Using the wrist strap](#)

Attaches the strap and place your hand through the loop to prevent the camera from damage by being dropped.

---



### [Notes on use](#)

4-533-356-11(1)

Copyright 2014 Sony Corporation

Digital Still Camera  
DSC-W800

## Using the internal memory

---

### [Using internal memory](#)

The camera has approximately 29 MB of internal memory.

---



### [Notes on use](#)

4-533-356-11(1)

Copyright 2014 Sony Corporation



Digital Still Camera  
DSC-W800

## Confirming the operation method

---

### [Using the control button](#)



### [Using MENU items \(Shooting\)](#)

You can select various shooting functions easily from the MENU button.



### [Using MENU items \(Viewing\)](#)

You can select various viewing functions easily from the MENU button.



### [Changing camera settings](#)

You can change settings on the [Settings] screen.



## [Notes on use](#)

4-533-356-11(1)

Copyright 2014 Sony Corporation



Digital Still Camera  
DSC-W800

Shooting images

---

[Shooting still images](#)



[Shooting movies](#)

---



[Notes on use](#)

4-533-356-11(1)

Copyright 2014 Sony Corporation



Digital Still Camera  
DSC-W800

## Selecting the shooting mode based on the subject

---

### Still Shooting Scene

You can select the still image shooting mode when the mode is set to [Still Image].

---

### Intelligent Auto

You can shoot still images with settings adjusted automatically.

---

### Scene Recognition

Scene Recognition operates in Intelligent Auto mode.

---

### Program Auto

You can shoot with exposure adjusted automatically (both shutter speed and aperture value).

---

### Shooting panoramic images

You can create a panoramic image from composite images.

---

### Scene Selection

You can shoot with preset settings according to the scene.

---

### Party

You can shoot party scene with bright and vivid tone.

---

## Notes on use

4-533-356-11(1)

Copyright 2014 Sony Corporation



Digital Still Camera  
DSC-W800

## Zoom

---

### Zoom

You can enlarge the image when shooting. The camera's optical zoom function can enlarge images up to 5x. 

---

### Digital Zoom

Selects digital zoom mode. 

---

### Notes on use

4-533-356-11(1)

Copyright 2014 Sony Corporation

Digital Still Camera  
DSC-W800

## Using the flash

---

### Flash

When shooting in low light or backlit conditions, you can brighten the subject by using flash.

---



### Notes on use

4-533-356-11(1)

Copyright 2014 Sony Corporation



Digital Still Camera  
DSC-W800

## Selecting image size

---

### [Image size](#)

Image size determines the size of the image file that is recorded when you take an image.

---

### [Image size when shooting Sweep Panorama](#)

Sets the image size of Sweep Panorama. The image size varies depending on the panorama shooting direction.

---

### [Image size when shooting movies](#)

The larger the size of the movie image, the higher the image quality.

---

## [Notes on use](#)

4-533-356-11(1)

Copyright 2014 Sony Corporation



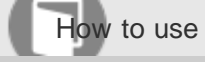

Digital Still Camera  
DSC-W800

## Adjusting the focus

---

### Focus

You can change the focus method. Use the menu when it is difficult to get proper focus in auto focus mode.



### TRACKING FOCUS

Tracks the subject and adjusts focus automatically even when the subject is moving.



### Notes on use

4-533-356-11(1)

Copyright 2014 Sony Corporation

Digital Still Camera  
DSC-W800

## Advanced shooting

[Easy Mode](#) 

Allows you to shoot still images using the minimum necessary functions.

[Shooting Direction in Sweep Panorama](#) 

Sets the direction in which the camera will be panned when shooting in Sweep Panorama mode.

[AF Illuminator](#) 

The AF illuminator supplies fill light to focus more easily on a subject in dark surroundings.

[Exposure Compensation](#) 

You can adjust exposure manually in 1/3 EV steps in a range of -2.0 EV to +2.0 EV.

[Metering Mode](#) 

Selects the metering mode that sets which part of the subject to measure to determine exposure.

[Cont. Shooting Settings](#) 

You can select Single Shooting or Continuous Shooting as the shooting mode.

[Self-Timer](#) 

You can shoot with a 10-second or 2-second delay using the self-timer.

[DRO](#) 

Analyzes the shooting scene and automatically corrects brightness and contrast to improve image quality.

[ISO](#) 

Selects luminous sensitivity when the camera is set to Program Auto. In Movie mode, [ISO] is fixed to [Auto].

[White Balance](#) 

Color tones are adjusted according to surrounding light conditions. Use this function if image color appears unnatural.

## Picture Effect

You can shoot a still image with original texture, according to the desired effect.

---

## Color hue

When you select [Toy camera] in Picture Effect , adjusts color hue.

---

## Extracted Color

When you select [Partial Color] in [Picture Effect], select the color to extract.

---

## Face Detection

When the Face Detection function is used, the camera detects the faces of your subjects and adjusts the focus, flash, exposure, white balance and red-eye reduction settings automatically.

---

## Red Eye Reduction

The flash strobesc two or more times before shooting to reduce the red-eye phenomenon when using flash.

---

## SteadyShot

Selects anti-blur mode.

---

## Write Date

Sets whether to record a shooting date on the still image.

---

## Grid Line

With reference to grid lines, you can easily set a subject in a horizontal/vertical position.

---

### Notes on use

4-533-356-11(1)

Copyright 2014 Sony Corporation

Digital Still Camera  
DSC-W800

## Viewing still images

---

### [Viewing still images](#)

You can play back still images.

---

### [Playback zoom](#)

You can enlarge the image being played back.

---

### [Image Index](#)

When you play back images, you can display multiple images at the same time.

---

### [Easy Mode](#)

When viewing still images in Easy Mode, the playback screen text becomes larger, and the indicators become easier to see.

---

## [Notes on use](#)

4-533-356-11(1)

Copyright 2014 Sony Corporation



Digital Still Camera  
DSC-W800

## Deleting images

---

### Deleting images

You can select and delete unwanted images.

---



### Notes on use

4-533-356-11(1)

Copyright 2014 Sony Corporation

Digital Still Camera  
DSC-W800

## Viewing movies

---

### [Viewing movies](#)

You can play back recorded movies.

---



### [Notes on use](#)

4-533-356-11(1)

Copyright 2014 Sony Corporation



Digital Still Camera  
DSC-W800

## Viewing panorama images

---

### [Playing back panoramic images](#)

You can view an entire panoramic image with automatic scrolling.

---



### [Notes on use](#)

4-533-356-11(1)

Copyright 2014 Sony Corporation

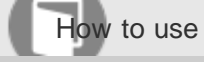

Digital Still Camera  
DSC-W800

## Printing still images

---

### [Print \(DPOF\)](#)

DPOF (Digital Print Order Format) is a function that you can specify the images of the memory card that you want to print out later. 

---

### [Printing still images](#)

You can print still images using the following methods. 

---

### [Notes on use](#)

4-533-356-11(1)

Copyright 2014 Sony Corporation





Digital Still Camera  
DSC-W800

## Useful viewing functions

---

### Rotate

A still image can be rotated. Use this to display a horizontal orientation image in vertical orientation.

---



### Protect

You can protect recorded images against accidental erasure.

---



### Notes on use

4-533-356-11(1)

Copyright 2014 Sony Corporation

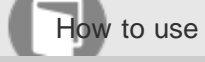

Digital Still Camera  
DSC-W800

## Viewing images on a TV

---

### [Viewing an image on a Standard Definition \(SD\) TV](#)

You can view images recorded on the camera in standard picture quality by connecting the camera to a Standard Definition (SD) TV. 

---

#### [Notes on use](#)

4-533-356-11(1)

Copyright 2014 Sony Corporation

Digital Still Camera  
DSC-W800

## Setup menu

### [Disp. Resolution](#)

Adjusts the image quality on the screen for shooting.



### [Beep](#)

Selects the sound produced when you operate the camera.



### [Volume](#)

Adjusts sound volume from level 1 to 5 for movie playback.



### [Monitor Brightness](#)

Selects screen brightness from level 1 to 5. The screen becomes brighter as the number rises.



### [Language Setting](#)

Selects the language to be used in menu items, warnings and messages.



### [Initialize](#)

Initializes settings to the default setting.



### [Function Guide](#)

You can select whether or not the function guide is displayed when you operate the camera.



### [Display Setting](#)

Sets the display setting mode.



### [Video Out](#)

Sets the video signal output according to the TV color system of the connected video equipment. The TV color systems differ depending on the country and region.



### [USB Connect Setting](#)

Sets how to make a USB connection when connecting the camera to a computer, etc.



## USB Power Supply

Sets whether to use the USB power supply function when the camera is connected to a computer or USB device using the dedicated USB cable (supplied).



## LUN Setting

Sets USB connection mode when connecting the camera to a computer, etc.



## Eye-Fi

You can use the upload function by using a commercially available Eye-Fi card.



## Power Save

Sets the length of time until the screen goes dark and the time until the camera turns off.



## Format

Formats the memory card.



## Create REC.Folder

Creates a folder in a memory card for recording images.



## Change REC.Folder

Changes the folder in the memory card that is currently used for recording images.



## Delete REC.Folder

Deletes a folder for recording images in a memory card.



## Copy

Copies all images in the internal memory to a memory card.



## File Number

Selects the method used to assign file numbers to images.



## Area Setting

Sets the area in which you are using this camera.



## Date & Time Setting

Sets date and time again.





How to use

Digital Still Camera  
DSC-W800

Recommended computer environment

---

[Recommended computer environment](#)



[Notes on use](#)

4-533-356-11(1)

Copyright 2014 Sony Corporation

Digital Still Camera  
DSC-W800

Using the software

---

[PlayMemories Home](#)



[Installing PlayMemories Home](#)



[Software for Mac](#)



[Notes on use](#)

4-533-356-11(1)

Copyright 2014 Sony Corporation



Digital Still Camera  
DSC-W800

## Connecting the camera to the computer

---

[Connecting the camera to the computer](#)



[Importing images to a computer](#)

PlayMemories Home allows you to easily import images.



[Disconnecting the camera from the computer](#)

Disconnects the camera from the computer.



### [Notes on use](#)

4-533-356-11(1)

Copyright 2014 Sony Corporation

Digital Still Camera  
DSC-W800

## Precautions

---

[Precautions](#)



[Backup of various settings, date and time](#)



[Battery pack](#)



[Notes on charging the battery pack](#)



[Memory card](#)



## Notes on use

4-533-356-11(1)

Copyright 2014 Sony Corporation



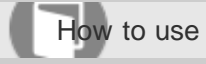

Digital Still Camera  
DSC-W800

On cleaning

---

[On cleaning](#)



[Notes on use](#)

4-533-356-11(1)

Copyright 2014 Sony Corporation

Digital Still Camera  
DSC-W800

Number of still images and recordable time of movies

---

[Number of still images](#)



[Recordable time of movies](#)



[Notes on use](#)

4-533-356-11(1)

Copyright 2014 Sony Corporation

Digital Still Camera  
DSC-W800

Using the camera abroad

---

[Using the camera abroad](#)



[On TV color systems](#)



[Notes on use](#)

4-533-356-11(1)

Copyright 2014 Sony Corporation



Digital Still Camera  
DSC-W800

About this camera

---

[License](#)

---



[Notes on use](#)

4-533-356-11(1)

Copyright 2014 Sony Corporation

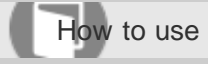

Digital Still Camera  
DSC-W800

Trademarks

---

[Trademarks](#)



[Notes on use](#)

4-533-356-11(1)

Copyright 2014 Sony Corporation



Digital Still Camera  
DSC-W800

If you have problems

---

[If you have problems](#)

If you experience trouble with the camera, try the following solutions.

---



[Notes on use](#)

4-533-356-11(1)

Copyright 2014 Sony Corporation

Digital Still Camera  
DSC-W800

## Battery pack and power

[Cannot insert the battery pack into the camera](#)



[Cannot turn on the camera](#)



[Power turns off suddenly](#)



[Remaining charge indicator is incorrect](#)



[Charge lamp of the camera flashes while charging the battery](#)



[Battery is not charged even if the Charge lamp turns off and charging is finished](#)



### [Notes on use](#)

4-533-356-11(1)

Copyright 2014 Sony Corporation

Digital Still Camera  
DSC-W800

## Shooting still images/movies

- [Cannot record images](#) >
- [Image is blurred](#) >
- [Image is out of focus](#) >
- [Zoom does not work](#) >
- [Cannot select the Face Detection function](#) >
- [Flash does not work](#) >
- [Fuzzy white circular spots appear in images shot using flash](#) >
- [Close-up shoot function \(Macro\) does not work](#) >
- [Date and time are not displayed on the screen](#) >
- [F value and shutter speed flash when you press and hold the shutter button halfway down](#) >
- [Image colors are not correct](#) >
- [White or purple streaks appear in bright areas of the subject, or the whole screen of the image becomes reddish](#) >
- [Noise appears in the image when you view the screen in a dark place](#) >
- [Eyes of the subject come out red](#) >



---

Dots appear and remain on the screen



---

Cannot shoot images in succession



---

Same image is shot several times



### Notes on use

4-533-356-11(1)

Copyright 2014 Sony Corporation

Digital Still Camera  
DSC-W800

## Viewing images

---

[Cannot play back images](#)



[Date and time are not displayed](#)



[Cannot display images in index mode](#)



### [Notes on use](#)

4-533-356-11(1)

Copyright 2014 Sony Corporation

Digital Still Camera  
DSC-W800

## Computers

[Your computer does not recognize the camera](#)



[Cannot import images](#)



[Image and sound are interrupted by noise when you view a movie on a computer](#)



[Images once exported to a computer cannot be viewed on the camera](#)



### Notes on use

4-533-356-11(1)

Copyright 2014 Sony Corporation

Digital Still Camera  
DSC-W800

## Memory card

[You have formatted a memory card by mistake](#)



[Images are recorded on internal memory even when a memory card is inserted into the camera](#)



### [Notes on use](#)

4-533-356-11(1)

Copyright 2014 Sony Corporation

Digital Still Camera  
DSC-W800

## Internal memory

---

[Cannot play back or record images using internal memory](#)



[Cannot copy stored data in internal memory to a memory card](#)



[Cannot copy memory card data or computer data to internal memory](#)



### [Notes on use](#)

4-533-356-11(1)

Copyright 2014 Sony Corporation

Digital Still Camera  
DSC-W800

## Printing

[Images are printed with both edges cut off](#)



[Cannot print images with date](#)



### Notes on use

4-533-356-11(1)

Copyright 2014 Sony Corporation



Digital Still Camera  
DSC-W800

## Others

---

[The lens gets fogged](#)



[Camera turns off with the lens portion extended](#)



[Camera becomes warm when you use it for a long time](#)



[Clock Set screen appears when you turn on the camera](#)



[Date or time is incorrect](#)



## Notes on use

4-533-356-11(1)

Copyright 2014 Sony Corporation



Digital Still Camera  
DSC-W800

## Warning indicators and messages

---

[Messages](#)



[Notes on use](#)

4-533-356-11(1)

Copyright 2014 Sony Corporation





Digital Still Camera  
DSC-W800

Situations this camera has difficulty handling

---

[Situations this camera has difficulty handling](#)



[Notes on use](#)

4-533-356-11(1)

Copyright 2014 Sony Corporation

Digital Still Camera  
DSC-W800

## Names of parts

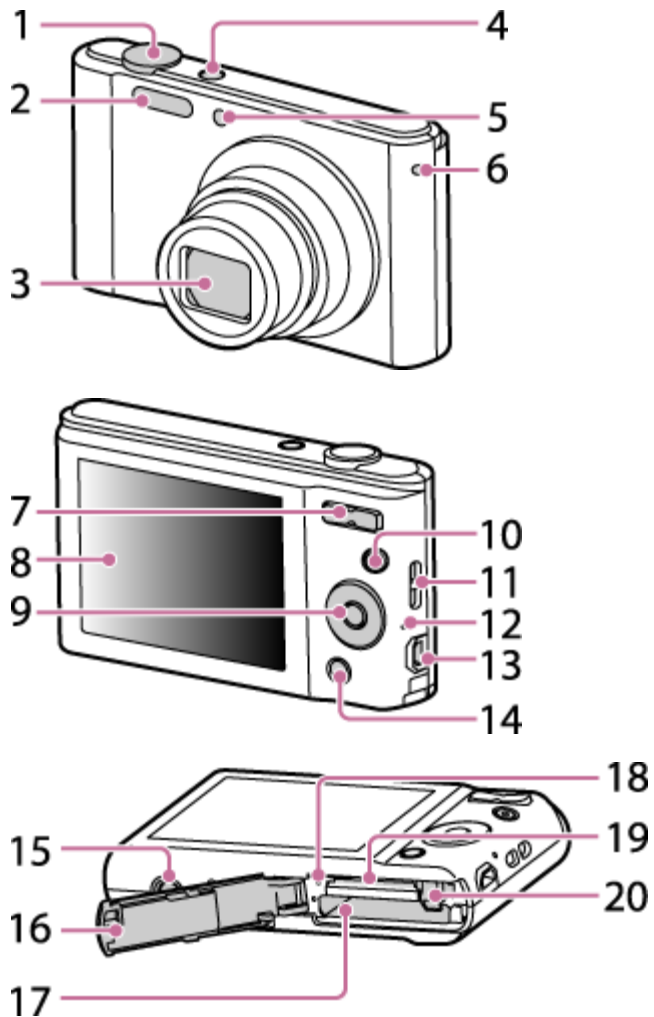

1. Shutter button
2. Flash
3. Lens
4. ON/OFF (Power) button
5. Self-timer lamp/AF illuminator
6. Speaker
7. W/T (Zoom) button
8. LCD screen
9. Control button

10. MOVIE button
11. Hook for wrist strap
12. Charge lamp
13. USB A/V OUT terminal
14. MENU button
15. Tripod receptacle
  - Use a tripod with a screw less than 5.5 mm (7/32 inches) long. Otherwise, you cannot firmly secure the camera, and damage to the camera may occur.
16. Battery/Memory card cover
17. Battery insertion slot
18. Access lamp
19. Memory card slot
20. Battery eject lever

### Notes on use

4-533-356-11(1)

Copyright 2014 Sony Corporation

Digital Still Camera  
DSC-W800

List of icons displayed on the screen

List of shooting mode icons

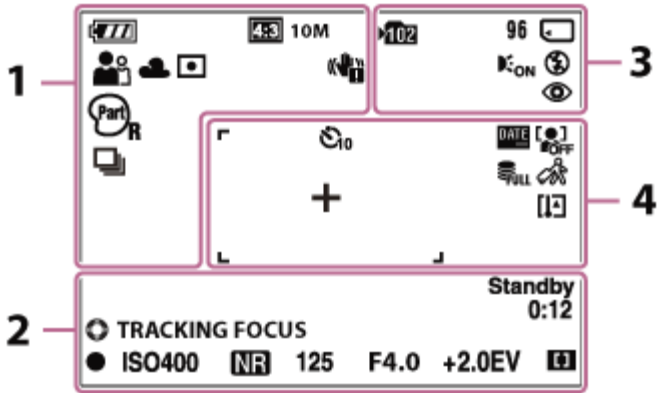

List of viewing mode icons

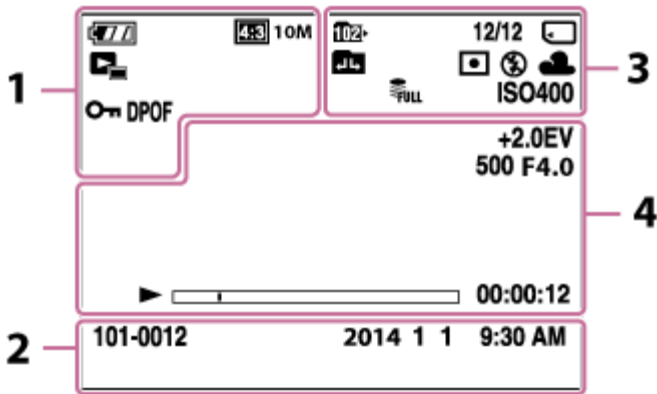

1

Battery charge remaining

Low battery warning

Image size/Panorama image size/Movie size

Picture Effect



Shooting mode



Scene Selection



Scene Recognition icon



White Balance



Metering Mode



Vibration warning



Color hue

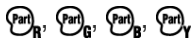

Extracted Color



DRO



Cont. Shooting Settings



Zoom scaling

2



Tracking focus



AE/AF lock

ISO400

ISO number



NR slow shutter

125

Shutter speed

F4.0

Aperture value

+2.0EV

Exposure Compensation



AF range finder frame indicator

REC/Standby

Recording a movie/Movie standby

0:12:00

Recording time (m:s)

101-0012

Folder-file number

2014-1-1

9:30 AM

Recorded date/time of the playback image

3



Recording folder



Playback folder

96

Number of recordable images

100Min

Recordable time



Recording media/Playback media (Memory card, internal memory)



Eye-Fi Mode display



AF Illuminator



Flash mode



Red-eye reduction



Flash charging

12/12

Image number/Number of images recorded in selected date range, folder



Changing folder

4



Self-timer



Face detection



Database file full/Database file error



Destination



Overheating warning

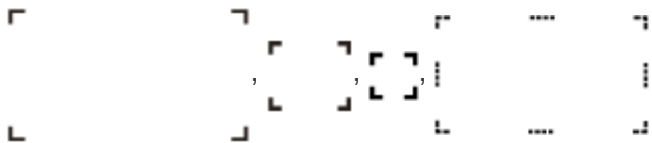

AF range finder frame



Spot metering cross-hairs



Protect



Print order (DPOF)



Playback zoom



Playback



Playback bar

0:00:12

Counter

## Notes on use

4-533-356-11(1)

Copyright 2014 Sony Corporation

Digital Still Camera  
DSC-W800

## Using the wrist strap

Attaches the strap and place your hand through the loop to prevent the camera from damage by being dropped.

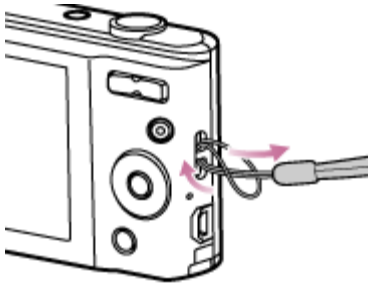

### Notes on use

4-533-356-11(1)

Copyright 2014 Sony Corporation



Digital Still Camera  
DSC-W800

## Using internal memory

The camera has approximately 29 MB of internal memory.

You can record images on internal memory when there is no memory card inserted in the camera.

When a memory card is inserted

[Recording]: Images are recorded on the memory card.

[Playback]: Images on the memory card are played back.

[Menu, Settings, etc.]: Various functions can be performed on images on the memory card.

When there is no memory card inserted

[Recording]: Images are recorded using internal memory.

You cannot record movies to internal memory when the movie image size is [1280x720].

[Playback]: Images stored in internal memory are played back.

[Menu, Settings, etc.]: Various functions can be performed on images in internal memory.

## On image data stored in internal memory

We recommend that you copy (back up) data using one of the following methods.

To copy (back up) data on a hard disk of your computer

Without a memory card inserted in the camera, import the images into a computer.

To copy (back up) data on a memory card

Prepare a memory card with sufficient free capacity, then copy the images in internal memory to the memory card.

**Note**

- You cannot transfer image data on a memory card to internal memory.
- By making a USB connection between the camera and a computer with a USB cable, you can transfer data stored in internal memory to a computer. However you cannot transfer data on a computer to internal memory.

[Notes on use](#)



4-533-356-11(1)

Copyright 2014 Sony Corporation

Digital Still Camera  
 DSC-W800

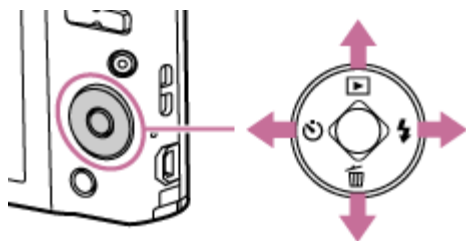
## Using the control button



The following functions are located on the up/down/right/left side of the control button:  (Playback),  (Delete),  (Self-Timer) and  (Flash).

Press the control button toward each icon to enter the setup screen for each function.

## Moving the selection frame on the MENU screen, etc.

Press the up/down/right/left side of the control button to move the selection frame.

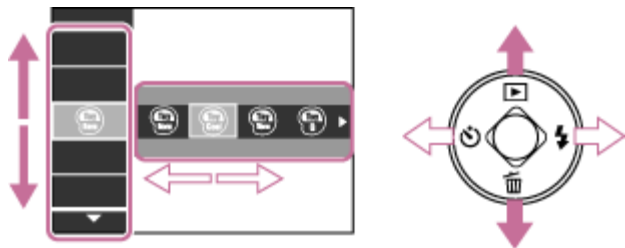

## Selecting an image to be played back

Press the right or left side of the control button to play back the next/previous image.

[Notes on use](#)

4-533-356-11(1)

Copyright 2014 Sony Corporation

Digital Still Camera  
DSC-W800

## Using MENU items (Shooting)

You can select various shooting functions easily from the MENU button.

1. Press the ON/OFF (Power) button and set the camera to shooting mode.
2. Press the MENU button to display the Menu screen.

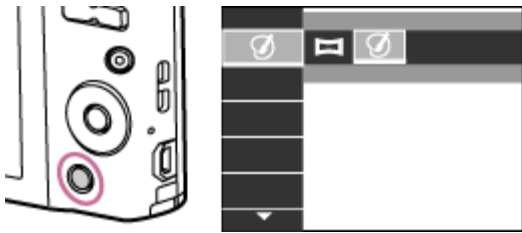

3. Select the desired menu item with ▲ / ▼ / ◀ / ▶ on the control button.

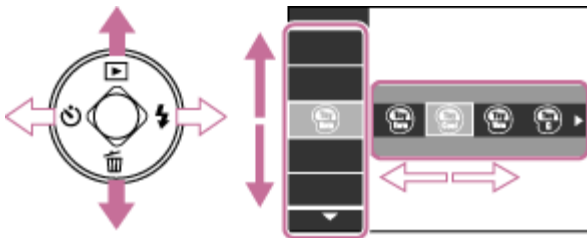

4. Press ● on the control button.

### Notes on use

4-533-356-11(1)

Copyright 2014 Sony Corporation

Digital Still Camera  
 DSC-W800

## Using MENU items (Viewing)

You can select various viewing functions easily from the MENU button.

1. Press  (Playback) on the control button to switch to playback mode.
2. Press the MENU button to display the Menu screen.

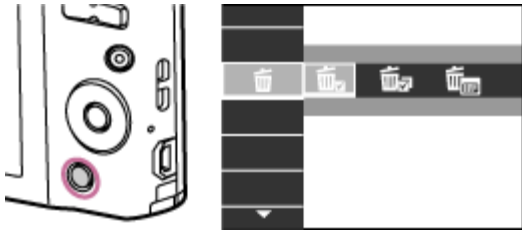

3. Select the desired menu item with  /  /  /  on the control button.

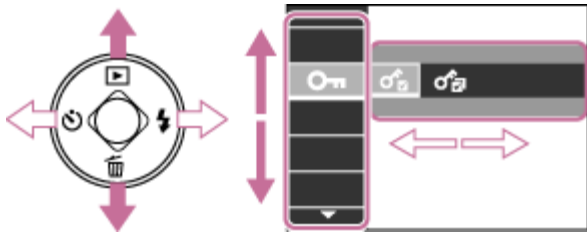

4. Press  on the control button.

[Notes on use](#)

4-533-356-11(1)

Copyright 2014 Sony Corporation

Digital Still Camera  
DSC-W800

## Changing camera settings

You can change settings on the [Settings] screen.

1. Press the MENU button to display the Menu screen.

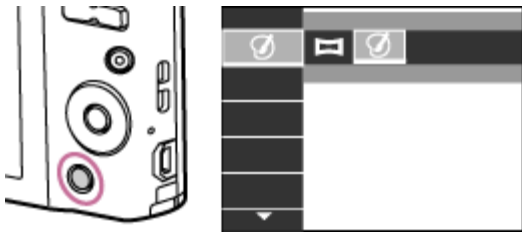

2. Select  (Settings) with  $\blacktriangle/\blacktriangledown$  on the control button, then press  $\bullet$  to display the setup screen.

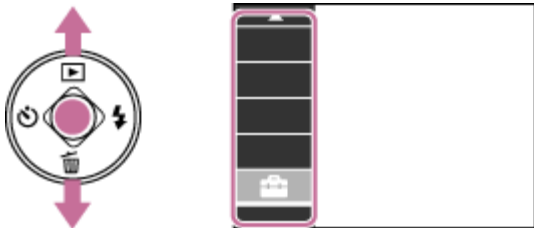

3. Select the desired category by using  $\blacktriangle/\blacktriangledown/\blacktriangleleft/\blacktriangleright$ , then press  $\bullet$  to display the setup screen.

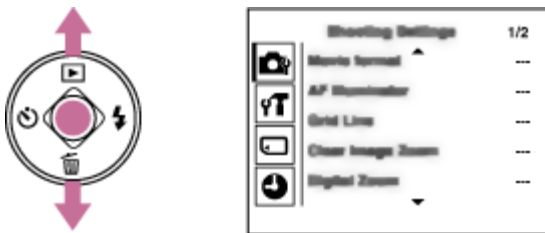

4. Select the desired setting, then press  $\bullet$ .

### Note

- [Shooting Settings] appears only when settings have been entered from shooting mode.
- [Memory Card Tool] appears only when a memory card is inserted in the camera, while [Internal Memory Tool] appears only when a memory card is not inserted.

## Shooting still images

1. Turn on the power, then select the desired still shooting mode from the menu.
2. Hold the camera steady to determine the composition of the still image.
3. Press the shutter button halfway down to focus.  
When the image is in focus, a beep sounds and the ● indicator lights.



- The shortest shooting distance is approximately 5 cm (0.16 ft.) (W), 60 cm (1.96 ft.) (T) (from lens).
  - Macro mode may be automatically set for some shooting conditions.
4. Press the shutter button fully down.
    - Do not put your fingers on the flash or lens when shooting.



### Hint

- When the camera cannot focus automatically, the focus indicator flashes and the beep does not sound. Either recompose the shot or change the focus setting.
- Focusing may be difficult in the following situations:
  - It is dark and the subject is distant.
  - Contrast between the subject and the background is poor.
  - Subject is seen through glass.
  - Subject is moving quickly.
  - There is reflective light or shiny surfaces.
  - Subject is backlit or there is a flashing light.

## Related Topic

- [Zoom](#)
- [Viewing still images](#)

## Notes on use

4-533-356-11(1)

Copyright 2014 Sony Corporation

## Shooting movies

---

1. Turn on the power.
2. Press the MOVIE button to start recording.
3. Press the MOVIE button again to stop recording.

### Note

- The operating sound of the lens may be recorded when the zoom function operates while shooting a movie.
- For details on the continuous shooting, see "[Recordable time of movies](#)".

When shooting stops, you can press the MOVIE button again to restart shooting. Depending on the temperature when shooting, recording may automatically stop to protect the camera.

### Related Topic

- [Zoom](#)
- [Viewing movies](#)
- [Recordable time of movies](#)

### Notes on use

4-533-356-11(1)

Copyright 2014 Sony Corporation





Digital Still Camera  
DSC-W800

## Still Shooting Scene

You can select the still image shooting mode when the mode is set to [Still Image].

1. MENU -  (Still Image) -  (Still Shooting Scene) - desired mode

 (Intelligent Auto)(Default setting):

You can shoot with setting adjusted automatically.

**P** (Program Auto):

You can shoot with exposure adjusted automatically (both shutter speed and aperture value).

Also you can select various settings using the menu.

 (Picture Effect):

You can shoot a still image with original texture, according to the desired effect.

**SCN** (Scene Selection):

You can shoot with preset settings according to the scene.

 (Party):

You can shoot party scene with bright and vivid tone.

 (SteadyShot):

You can shoot beautifully, with reduced blur.

### Related Topic

- [Intelligent Auto](#)
- [Program Auto](#)
- [Picture Effect](#)
- [Scene Selection](#)
- [Shooting panoramic images](#)
- [Shooting movies](#)

### Notes on use



4-533-356-11(1)

Copyright 2014 Sony Corporation

Digital Still Camera  
DSC-W800

## Intelligent Auto

You can shoot still images with settings adjusted automatically.

1. MENU -  (Shooting Mode) -  (Still Shooting Scene) -  (Intelligent Auto) - ● on the control button
2. Shoot with the shutter button.

### Related Topic

● [Scene Recognition](#)

### Notes on use

4-533-356-11(1)

Copyright 2014 Sony Corporation











Digital Still Camera  
DSC-W800

## Scene Recognition

Scene Recognition operates in Intelligent Auto mode. This function lets the camera automatically recognize shooting conditions and shoot the image.



In Scene Recognition, the position of an icon displayed on the screen is different depending on the circumstances. It depends on whether the camera recognizes a scene or condition.

If the camera recognizes a scene, icons and guides such as  (Portrait),  (Night Portrait),  (Night Scene),  (Backlight Portrait),  (Backlight),  (Landscape),  (Macro),  (Spotlight) or  (Low Light), are displayed on the first line. If the camera recognizes a condition, icons such as  (Tripod) or  (Move) are displayed on the second line. The camera may recognize both the scene and condition, or just one.

### Related Topic

[Intelligent Auto](#)

### Notes on use

4-533-356-11(1)

Copyright 2014 Sony Corporation

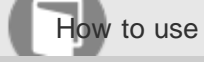





Digital Still Camera  
DSC-W800

## Program Auto

---

You can shoot with exposure adjusted automatically (both shutter speed and aperture value). Also you can select various settings using the menu.

1. MENU -  (Shooting Mode) -   (Still Shooting Scene) - **P** (Program Auto) -  on the control button
2. Shoot with the shutter button.

### [Notes on use](#)

4-533-356-11(1)

Copyright 2014 Sony Corporation

Digital Still Camera  
DSC-W800

## Shooting panoramic images

You can create a panoramic image from composite images.



1. Open the menu and select  (Sweep Panorama) from the shooting modes.
2. Align the camera with the end of the subject to be shot and press the shutter button fully.



3. Pan the camera to the end of the guide (A), following the indicator on the screen.



### Tips for shooting a panoramic image

Pan the camera in an arc at a constant velocity in the direction indicated on the screen.

Subjects at rest are more suited for panoramic shots than moving subjects.

Radius as short as possible.

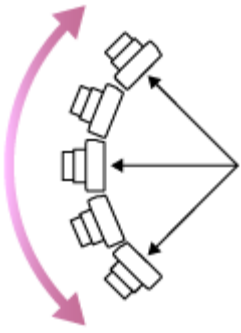

Vertical direction

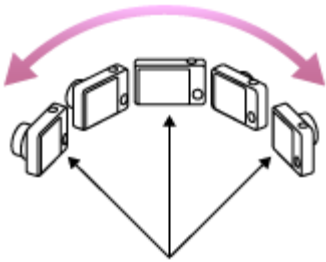

Horizontal direction

- First press the shutter button halfway so that you can lock focus and exposure. Then press the shutter button fully down and pan or tilt the camera.
- If a section with greatly varied shapes or scenery is concentrated along a screen edge, the image composition may fail. In such a case, adjust the frame composition so that the section is in the center of the image, then shoot again.

### To shoot a 360 degree panoramic image

This camera is equipped with a panorama shooting function, capable of shooting a nearly 360 degree panoramic image. Shoot a panoramic image by selecting MENU - set [Panorama Image Size] to [360°]. Recorded panoramic images can be scrolled normally when played on the camera.



Press MENU - [Shooting Direction] - select [Right] or [Left]. [Up] and [Down] cannot be selected for [Shooting Direction] when shooting 360 degree panoramic images.

The image actually recorded may not cover 360 degrees, depending on the subject or the way it is shot.

#### Note

- If you cannot pan the camera across the entire subject within the given time, a gray area occurs in the composite image. If this happens, move the camera faster to record a full panoramic image.
- Since several images are stitched together, the stitched part will not be recorded smoothly.
- When the whole angle of panoramic shooting and the AE/AF locked angle are very different in brightness, color and focus, the shooting will not be successful. If this happens, change the AE/AF locked angle and shoot again.
- You cannot create panoramic images in the following situations:
  - You pan the camera too quickly or too slowly.

– There is too much camera shake.

#### Related Topic

- [Image size when shooting Sweep Panorama](#)
- [Shooting Direction in Sweep Panorama](#)
- [Playing back panoramic images](#)
- [Picture Effect](#)

#### Notes on use





4-533-356-11(1)

Copyright 2014 Sony Corporation



## Scene Selection

You can shoot with preset settings according to the scene.

1. MENU -  (Shooting Mode) -   (Still Shooting Scene) - **SCN** (Scene Selection) -  on the control button - desired mode
  - If you want to select another Scene Selection mode, select from MENU.

 (Portrait):

You can shoot images with a softer atmosphere for portraits and flowers, etc.

 (Landscape):

Allows easy shooting of distant scenes by focusing in the distance. Shoots a clear sky, trees and flowers in vivid colors.

 (Night Portrait):

You can shoot sharp images of people with a night view in the background, without compromising atmosphere.

 (Night Scene):

You can shoot night scenes at far distance without losing the dark atmosphere of the surroundings.

 (High Sensitivity):

You can shoot images without a flash under low light conditions, reducing blur.

 (Gourmet):

You can shoot food arrangements in delicious and bright colors.

 (Pet):

You can shoot images of your pet with the best settings.



 (Beach):

You can shoot scenes on the beach in bright and vivid colors even under sunlight.

 (Snow):

You can record clear images preventing sunken colors in snowy scenes or other places where the whole screen appears white.

### Note

- When you shoot images using  (Night Portrait) or  (Night Scene) modes, the shutter speed is slower and images tend to blur. To prevent blurring, use of a tripod is recommended.

### Notes on use







Digital Still Camera  
DSC-W800

## Party

---

You can shoot party scene with bright and vivid tone.

1. MENU -  (Shooting Mode) -   (Still Shooting Scene) -  (Party) -  on the control button
2. Shoot with the shutter button.

### Note

- The image size is limited to a maximum of [5M].

### [Notes on use](#)

4-533-356-11(1)

Copyright 2014 Sony Corporation

Digital Still Camera  
DSC-W800

## Zoom

You can enlarge the image when shooting. The camera's optical zoom function can enlarge images up to 5x.

1. Press the W/T (zoom) button.

Press the T button to zoom in, and the W button to zoom out.



### Note

- Zoom is locked to the W side in Sweep Panorama mode.
- The operating sound of the lens is recorded when the zoom function operates while shooting a movie.

### Related Topic

[Digital Zoom](#)

### Notes on use

4-533-356-11(1)

Copyright 2014 Sony Corporation

Digital Still Camera  
DSC-W800

## Digital Zoom

Selects digital zoom mode. The camera enlarges the image using optical zoom (up to 5×). When the zoom scale is exceeded, the camera uses either smart or precision digital zoom.

1. Set the camera to shooting mode.
2. MENU -  (Settings) -  (Shooting Settings) - [Digital Zoom] - desired mode - ● on the control button

**S**  (Smart)(Default settings):

Enlarges the image digitally within the range where the image will not be distorted, according to the image size (Smart zoom).

**P**  (Precision):

Enlarges all image sizes by the total zoom scale of approximately 10×, including the optical zoom 5×. However, note that image quality deteriorates when the optical zoom scale is exceeded (Precision digital zoom).

Off:

Does not use digital zoom.

### Note

- [Digital Zoom] is not available in the following situations:
  - In [Sweep Panorama]
  - When [Self-Timer] is set to [Self-portrait One Person] or [Self-portrait Two People].
- Smart zoom is not available when you record movies or the image size is set to [20M] or [16:9 (15M)].
- The Face Detection function does not operate in the range of [Digital Zoom].

Total zoom scale when using Smart zoom (including optical zoom 5×)

The supported zoom ratio differs depending on image size.

Image size and total zoom scale:

10M: Approx. 7.1×

5M: Approx. 9.9×

VGA: Approx. 40×

16:9(2M): Approx. 13×

### Related Topic

[Zoom](#)

Digital Still Camera  
DSC-W800

## Flash

When shooting in low light or backlit conditions, you can brighten the subject by using flash. In addition, the flash helps to reduce camera shake.

1. Press  (Flash) on the control button.
2. Select the desired mode with the control button.

### Adv. (Advanced Flash):

Flashes to a farther distance by increasing the upper limit value of ISO sensitivity.

### AUTO (Auto)(Default setting):

Flashes automatically operates in dark locations or when there is a backlight.

### (On):

Flashes always operates.

### SL (Slow Synchro):

Flashes always operates.

The shutter speed is slow in a dark place to clearly shoot background that is out of flash light.

### (Off):

Flashes does not operate.

## When "White circular spots" appears in flash photos



These spots are caused by particles (dust, pollen, etc.) floating close to the lens. When they are accentuated by the camera's flash, they appear as white circular spots.



## How can the "White circular spots" be reduced?

- Light the room and shoot the subject without flash.
- If you select  (High Sensitivity) mode in Scene Selection, [Flash] is automatically set to [Off].

### Note

- While charging the flash,  is displayed.
- You cannot use flash during burst shooting.
-  Adv. (Advanced Flash) can be selected only in [Intelligent Auto] mode. When  Adv. (Advanced Flash) is selected, the

maximum size of [Still Image Size] is [5M]. If [Still Image Size] is set to larger than [5M], [Still Image Size] is set to [5M] automatically.

- When shooting with flash and zoom is set to W, the shadow of the lens may appear on the screen, depending on shooting conditions. If this happens, set the zoom to T and shoot with flash again.

#### Notes on use

4-533-356-11(1)

Copyright 2014 Sony Corporation

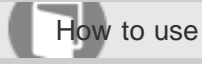

Digital Still Camera  
DSC-W800

## Image size

Image size determines the size of the image file that is recorded when you take an image.

The larger the image size, the more detail will be reproduced when the image is printed on large-format paper. The smaller the image size, the more images can be recorded.

1. MENU -  (Still Image Size) - desired size

### Still Image Size (Horizontal × Vertical) and usage guidelines

 (5152×3864)(Default setting):

For prints up to A3+ size.

 (3648×2736):

For prints up to A3 size.

 (2592×1944):

For prints from 10×15 cm up to A4 size

 (640×480):

For e-mail attachments

 (5152×2896):

For viewing on a high-definition TV and printing up to A3 size

 (1920×1080):

For viewing on a high-definition TV

#### Note

- When you print still images recorded at a 16:9 aspect ratio or panorama images, both edges may be cut off.

### Image size in Easy Mode

1. MENU - [Still Image Size] - desired size

Large (Default setting): Shoots images in [20M] size.

Small: Shoots images in [5M] size.

#### [Notes on use](#)

4-533-356-11(1)

Copyright 2014 Sony Corporation

Digital Still Camera  
DSC-W800

## Image size when shooting Sweep Panorama

Sets the image size of Sweep Panorama. The image size varies depending on the panorama shooting direction.

1. MENU -  (Panorama Image Size) - desired size

 (Standard)(Default setting):

(Horizontal: 4912 × 1080)

(Vertical: 3424 × 1920)

Shoots images using standard size.

 (Wide):

(Horizontal: 7152 × 1080)

(Vertical: 4912 × 1920)

Shoots images using wide size.

 (360°):

(Horizontal: 11520 × 1080)

Shoots 360-degree images.

### Related Topic

- [Shooting panoramic images](#)
- [Shooting Direction in Sweep Panorama](#)

### Notes on use

4-533-356-11(1)

Copyright 2014 Sony Corporation

Digital Still Camera  
DSC-W800

## Image size when shooting movies

The larger the size of the movie image, the higher the image quality.

Movies shot with this camera will be recorded in AVI (Motion JPEG), Approx. 30fps format.

1. MENU -  (Movie Size) - desired size

### Movie size and usage guidelines

 (1280×720)(Default setting):

For viewing on a high-definition TV.

 (VGA(640×480)):

For viewing on a TV screen.

 (QVGA(320×240)):

For sending as an e-mail attachment.

#### Related Topic

 [Shooting movies](#)

#### Notes on use

4-533-356-11(1)

Copyright 2014 Sony Corporation



Digital Still Camera  
DSC-W800

## Focus

You can change the focus method. Use the menu when it is difficult to get proper focus in auto focus mode.

AF stands for "Auto Focus," a function that adjusts focus automatically.

The selected AF range finder frame appears on the screen.

1. MENU -  (Focus) - desired mode

 (Multi AF)(Default setting):

Focuses on a subject in all ranges of the finder frame automatically. When you press the shutter button halfway down in still image shooting mode, a green frame is displayed around the area that is in focus.



- When the Face Detection function is active, AF operates with priority on faces.

 (Center AF):

Focuses on a subject in the center of the finder frame automatically. Using the AF lock function together, you can compose the image the way you want.



Hold the camera steady so as not to misalign the subject and the AF range finder frame.

### Note

- When you use [Digital Zoom] or [AF Illuminator], the AF range finder frame is disabled and appears in a dotted line. In this case, the camera works to focus on the subjects at the center of the screen.
- If tracking focus is activated, the camera focuses with priority on the subject to be tracked.

Focusing on subjects near the edge of the screen

If the subject is out of focus, do as follows:



1. Recompose the shot so that the subject is centered in the AF range finder (A), and press the shutter button halfway to focus on the subject (AF lock).
2. When the AE/AF lock indicator (B) stops flashing and remains on, return to the fully composed shot, and press the shutter button fully down.



#### Notes on use

4-533-356-11(1)

Copyright 2014 Sony Corporation

## TRACKING FOCUS

Tracks the subject and adjusts focus automatically even when the subject is moving.

1. Point the camera at the subject, and press  on the control button.  
The target frame appears.
2. Place the target frame over the subject you want to focus on, and press .  
Tracking begins.
3. Press the shutter button to shoot the image.

### Tracking a face

If you use the tracking focus function while the Face Detection function is activated, you can select a face to be given priority and register that face with the camera.

#### Note

- You cannot use tracking focus in the following situations:
  - Zoom functions other than optical zoom
- Tracking focus will automatically be canceled when the subject disappears from the screen or has failed to be tracked.

#### Related Topic

- [Cannot select the Face Detection function](#)

#### Notes on use

4-533-356-11(1)

Copyright 2014 Sony Corporation

Digital Still Camera  
DSC-W800

## Easy Mode

Allows you to shoot still images using the minimum necessary functions.  
The text size increases and indicators become easier to see.

1. MENU - **EASY** (Easy Mode) - ● on the control button
2. [OK] - ●
3. Shoot with the shutter button.
  - To end Easy Mode, MENU - [Exit Easy Mode].

### Note

- The battery power may decrease faster because the screen brightness increases automatically.

## Scene Recognition

Scene Recognition operates in Easy Mode. This function lets the camera automatically recognize the shooting conditions and shoot an image.



## Shooting functions available in Easy Mode (Shooting)

### Still Image Size

MENU - [Still Image Size] - ● on the control button - desired mode - ●

Select between [Large] or [Small] size.

### Self-Timer

 on the control button - desired mode

Select between [10sec] or [Off] mode.

### Flash

 on the control button - desired mode



## Shooting Direction in Sweep Panorama

Sets the direction in which the camera will be panned when shooting in Sweep Panorama mode.

1. MENU -  (Shooting Direction) - desired direction

 (Right)(Default setting):

Pan from left to right.

 (Left):

Pan from right to left.

 (Up):

Pan from down to up.

 (Down):

Pan from up to down.

### Note

- [Up] and [Down] cannot be selected when [Image Size] is set to [360°].

### Related Topic

- [Shooting panoramic images](#)

### Notes on use

4-533-356-11(1)

Copyright 2014 Sony Corporation

Digital Still Camera  
DSC-W800

## AF Illuminator

The AF illuminator supplies fill light to focus more easily on a subject in dark surroundings.

The AF illuminator emits red light allowing the camera to focus easily when the shutter button is pressed halfway, until focus is locked.

The  ON indicator appears at this time.

1. Set the camera to shooting mode.
2. MENU -  (Settings) -  (Shooting Settings) - [AF Illuminator] - desired mode - ● on the control button



Auto(Default setting):

Sets whether to use the AF illuminator automatically in dark surroundings.

Off:

Does not use the AF illuminator.

### Note

- Focus is achieved as long as the AF illuminator light reaches the subject, regardless of whether light fails to reach the center of the subject.
- You cannot use the AF illuminator in the following situations:
  - In movie mode
  - In [Sweep Panorama]
  - When  (Landscape),  (Night Scene) or  (Pet) mode is selected in Scene Selection.
  - When [Self-Timer] is set to [Self-portrait One Person] or [Self-portrait Two People].
- When you use the AF illuminator, the normal AF range finder frame is disabled and a new AF range finder frame is displayed by a dotted line. AF operates with priority on subjects located near the center of the frame.
- The AF illuminator emits very bright light. Although there is no health hazard, do not look directly into the AF illuminator emitter at close range.

### Notes on use

4-533-356-11(1)

Copyright 2014 Sony Corporation

Digital Still Camera  
DSC-W800

## Exposure Compensation

You can adjust exposure manually in 1/3 EV steps in a range of  $-2.0$  EV to  $+2.0$  EV.

1. MENU - **0EV** (Exposure Compensation) - desired Exposure Compensation - ● on the control button

Adjusting exposure for better looking images



A: Overexposure (too much light)

B: Correct exposure

C: Underexposure (too little light)

- When the image shot is overexposed, adjust [Exposure Compensation] to the minus side.
- When the image shot is underexposed, adjust [Exposure Compensation] to the plus side.

### Note

- If you shoot a subject in extremely bright or dark conditions, or when you use flash, exposure adjustment may not be effective.

### Notes on use

4-533-356-11(1)

Copyright 2014 Sony Corporation

Digital Still Camera  
DSC-W800

## Metering Mode

Selects the metering mode that sets which part of the subject to measure to determine exposure.

1. MENU -  (Metering Mode) - desired mode

 (Multi)(Default setting):

Divides into multiple regions and measures each region. The camera determines a well-balanced exposure (Multi-pattern metering).

 (Center):

Measures the center of the image, and determines exposure based on the brightness of the subject there (Center-weighted metering).

 (Spot):

Align the spot metering cross hairs (A) on the subject to meter one part of the subject (Spot metering). This function is useful when the subject is backlit or when there is strong contrast between the subject and background.



### Notes on use

4-533-356-11(1)

Copyright 2014 Sony Corporation



## Cont. Shooting Settings

---

You can select Single Shooting or Continuous Shooting as the shooting mode.

1. MENU -  (Cont. Shooting Settings) - desired mode

 (Single Shooting)(Default setting):

Shoots a single image.

 (Continuous Shooting):

Shoots up to 100 frames and up to approximately 0.52 frames per second when you continue to hold down the shutter button.

### Note

- [Flash] is set to [Off].
- When recording with the self-timer, a series of up to 5 images is recorded.
- The recording interval becomes longer, depending on the setting for the image size.
- [Focus], [White Balance], and [Exposure Compensation] are adjusted for the first image, and these settings are also used for other images.
- When internal memory or a memory card is full, the burst stops.

### [Notes on use](#)

4-533-356-11(1)

Copyright 2014 Sony Corporation

 Digital Still Camera  
 DSC-W800

 Self-Timer
 

---

You can shoot with a 10-second or 2-second delay using the self-timer.

1. Press  (Self-Timer) on the control button.
2. Select the desired mode with the control button.

 OFF (Off)(Default setting):

Does not use the self-timer.

 10 (10sec):

Sets the self-timer to a 10-second delay.

When you press the shutter button, the self-timer lamp flashes and a beep sounds until the shutter operates.

To cancel, press  again.

 2 (2sec):

Sets the self-timer to a 2-second delay.

 (Self-portrait One Person):



 (Self-portrait Two People):

Sets the self-timer to Self-portrait timer.

When the camera detects the specified number of faces, a beep sounds, and the shutter operates 2 seconds later.

## Tips for preventing blur

If your hands or body move while holding the camera and pressing the shutter button, "Camera shake" occurs.

Camera shake occurs frequently under low-light or slow shutter speed conditions, such as those encountered in  (Night Portrait) or  (Night Scene) mode.



To reduce camera shake, set the self-timer to a 2-second delay and brace your arms against your sides after pressing the shutter button.

## Automatic shooting with Self-portrait timer

Point the lens at yourself so that the selected number of faces is reflected in the screen. The shutter operates automatically. Do not move your camera after the beep sounds.



## Notes on use

4-533-356-11(1)



Copyright 2014 Sony Corporation



## DRO

Analyzes the shooting scene and automatically corrects brightness and contrast to improve image quality.

DRO stands for "Dynamic Range Optimizer," a function that automatically optimizes the difference between light and dark parts of an image.

1. MENU -  (Still Image) -  (Still Shooting Scene) - **P** (Program Auto) -  (DRO) - desired mode

 (Off):

Does not adjust.

 (DRO Standard)(Default setting):

Adjusts brightness and contrast of images automatically.

 (DRO plus):

Adjusts image brightness and contrast automatically and strongly.

### Note

- Depending on shooting conditions, it may not be possible to obtain correction effects.
- Only [ISOAUTO] or values from [ISO 100] to [ISO 800] can be set for the ISO value when [DRO plus] is set.

### Notes on use

4-533-356-11(1)

Copyright 2014 Sony Corporation

Digital Still Camera  
DSC-W800

## ISO

Selects luminous sensitivity when the camera is set to Program Auto. In Movie mode, [ISO] is fixed to [Auto].

1. MENU -  (ISO) - desired mode

 (Auto)(Default setting):

Sets ISO sensitivity automatically.

 /  /  /  /  /  .

You can reduce image blurring in dark locations or with moving subjects by increasing ISO sensitivity (select a larger number).

Adjusting ISO Sensitivity (Recommended Exposure Index)

ISO sensitivity is a speed rating for recording media that incorporates an image sensor that receives light. Even when the exposure is the same, images differ depending on the ISO sensitivity.

High ISO sensitivity



Records a bright image even in dark locations while increasing shutter speed to reduce blur. However, the image tends to be noisy.

Low ISO sensitivity



Records a smoother image.

However, when exposure is insufficient, the image may be darker.

## White Balance

Color tones are adjusted according to surrounding light conditions. Use this function if image color appears unnatural.

1. MENU -  **AUTO** (White Balance) - desired mode

 **AUTO** (Auto) (Default setting):

Adjusts white balance automatically so that colors appear natural.

 (Daylight):

Adjusts for outdoors conditions on a fine day, evening views, night scenes, neon signs, fireworks, etc.

 (Cloudy):

Adjusts for a cloudy sky or a shady location.

 (Fluorescent White Balance 1):

Adjusts for white fluorescent lighting.

 (Fluorescent White Balance 2):

Adjusts for natural white fluorescent lighting.

 (Fluorescent White Balance 3):

Adjusts for daylight fluorescent lighting.

 (Incandescent):

Adjusts for places under incandescent lamp, or under bright lighting, such as in a photo studio.

 **WB** (Flash):

Adjusts for flash conditions.

### Note

- When shooting with a flash in other than [Flash] mode, [White Balance] is set to [Auto].
- When [Flash] is [On] or [Slow Synchro], white balance can only be adjusted to [Auto] or [Flash].



### Notes on use

4-533-356-11(1)

Copyright 2014 Sony Corporation

## Picture Effect

You can shoot a still image with original texture, according to the desired effect.

1. MENU -  (Still Image) -  (Still Shooting Scene) -  (Picture Effect) - ● on the control button.
2. Shoot with the shutter button.

### (Toy camera):

You can shoot images with effects such as tunnel effect, high contrast, or color cast as if they were shot with a toy camera. You can change color hue using MENU - [Color hue].

### (Pop Color):

You can shoot a pop art-like colorful image with emphasis on color tone.

### (Partial Color):

You can shoot an image that makes a strong impression by leaving a specified color on portions of a monochrome image. You can select the color to extract using MENU - [Extracted Color].

### (Soft High-key):

You can shoot soft, clear images with an emphasis on brightness.

#### Related Topic

- [Color hue](#)
- [Extracted Color](#)

#### [Notes on use](#)

4-533-356-11(1)

Copyright 2014 Sony Corporation

Digital Still Camera  
DSC-W800

## Color hue

When you select [Toy camera] in Picture Effect , adjusts color hue.

1. MENU -  (Color hue) - desired mode

 (Normal)(Default setting):

Adds a normal hue and darkens the surroundings.

 (Cool hue):

Adds a cool bluish hue and darkens the surroundings.

 (Warm hue):

Adds a warm reddish hue and darkens the surroundings.

 (Green hue):

Adds a green filter-like hue and darkens the surroundings.

 (Magenta hue):

Adds a magenta filter-like hue and darkens the surroundings.

### Note

- It is recommended that you shoot a test image in advance for some subjects.

### Related Topic

 [Picture Effect](#)

### Notes on use

4-533-356-11(1)

Copyright 2014 Sony Corporation



Digital Still Camera  
DSC-W800

## Extracted Color

When you select [Partial Color] in [Picture Effect], select the color to extract.

1. MENU -  (Extracted Color) - desired mode

 (Red)(Default setting):

Extracts red only.

 (Green):

Extracts green only.

 (Blue):

Extracts blue only.

 (Yellow):

Extracts yellow only.

### Note

- Images may not retain the selected color, depending on the subject.

### Related Topic

 [Picture Effect](#)

### Notes on use

4-533-356-11(1)

Copyright 2014 Sony Corporation



## Face Detection

When the Face Detection function is used, the camera detects the faces of your subjects and adjusts the focus, flash, exposure, white balance and red-eye reduction settings automatically.

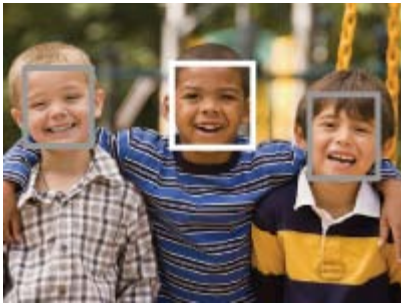

1. MENU -  (Face Detection) - desired mode

 (Off):

Cannot use Face Detection.

 (Auto)(Default setting):

Selects the face the camera is to automatically focus on.

### Note

- [Off] is not available when [Self-Timer] is set to [Self-portrait One Person] or [Self-portrait Two People].
- You can select [Face Detection] only when the focus mode is set to [Multi AF] and the metering mode is set to [Multi].
- The Face Detection function does not operate when you use the digital zoom.
- Up to eight faces of your subjects can be detected.

### Related Topic

 [TRACKING FOCUS](#)

### Notes on use



4-533-356-11(1)

Copyright 2014 Sony Corporation

Digital Still Camera  
DSC-W800

## Red Eye Reduction

The flash strobescs two or more times before shooting to reduce the red-eye phenomenon when using flash.

1. Set the camera to shooting mode.
2. MENU -  (Settings) -  (Shooting Settings) - [Red Eye Reduction] - desired mode - ●

Auto(Default setting):

When the Face Detection function is activated, the flash strobescs automatically to reduce the red-eye phenomenon.

On:

The flash always strobescs to reduce the red-eye phenomenon.

Off:

Does not use Red Eye Reduction.

What causes the red-eye phenomenon?



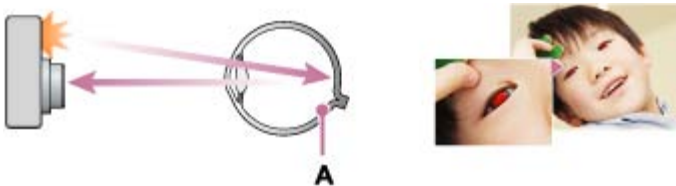

Pupils become dilated in dark environments. Flash light is reflected off blood vessels at the back of the eye (retina) (A), causing the "red-eye" phenomenon.



Other ways to reduce red-eye

Select  (High Sensitivity) mode in Scene Selection. (The flash is set to [Off] automatically.)

### Note

- To avoid blurring of images, hold the camera firmly until the shutter is released. It usually takes a second until the shutter is released, and also be sure not to allow the subject to move during this period.
- Red Eye Reduction may not produce the desired effects. It depends on individual differences and conditions, such as the distance to the subject or if the subject looked away from the pre-strobe.
- If you do not use the Face Detection function, Red Eye Reduction does not work, even when you select [Auto].
- [Red Eye Reduction] is set to [Off] in the following situations:
  - When  (Night Scene),  (High Sensitivity),  (Gourmet) or  (Pet) mode is selected in Scene Selection.

Digital Still Camera  
DSC-W800

## SteadyShot

Selects anti-blur mode.

1. MENU - 📷 (Shooting Mode) - **i**📷 (Still Shooting Scene) - ((👤)) (SteadyShot) - ●

### Tips for preventing blur

The camera moved accidentally when you took the image. This is called "Camera shake." On the other hand, if the subject moved when you took the image, it is called "subject blur." Besides, camera shake and subject blur occur frequently under low-light or slow shutter speed conditions, such as those encountered in 👤 (Night Portrait) or 🌙 (Night Scene) mode. In such case, shoot with the below tips in mind.

#### Camera shake

Your hands or body shake while you hold the camera and press the shutter button, and the entire screen is blurred.



- Use a tripod or place the camera on a flat surface to hold the camera steady.
- If tracking focus is activated, the camera focuses with priority on the subject to be tracked.

#### Subject blur

Even though the camera is steady, the subject moves during the exposure so the subject is shot blurred when the shutter button is pressed. Camera shake is reduced automatically using the anti-blur function. However, the function does not effectively reduce subject blur.



- Select **ISO** (High Sensitivity) mode in Scene Selection.
- Select a high ISO sensitivity to make the shutter speed faster, and press the shutter button before the subject moves.

#### Note

- Time is required for image processing.

- When shooting with a flash, the anti-blur function does not work.

## Notes on use



4-533-356-11(1)

Copyright 2014 Sony Corporation

## Write Date

Sets whether to record a shooting date on the still image.



1. Set the camera to shooting mode.
2. MENU -  (Settings) -  (Shooting Settings) - [Write Date] - desired mode - ●

On(**DATE**):

Records a shooting date.

When [On] is selected, the **DATE** mark will appear on the screen while shooting. However, in some shooting modes that cannot record dates on images, the **DATE** mark will disappear.

Off(Default setting):

Does not record a shooting date.

### Note

- You cannot record dates in the following situations:
  - In movie mode
  - When shooting panoramic images
  - In burst shooting mode
  - In [Easy Mode]
- If you shot images with the date once, you cannot delete the date from the images later.
- Dates are doubly printed, if you set the camera to superimpose the dates when printing.
- The recorded time of the image cannot be superimposed on the image.

### Notes on use

4-533-356-11(1)



Copyright 2014 Sony Corporation

Digital Still Camera  
DSC-W800

## Grid Line

---

With reference to grid lines, you can easily set a subject in a horizontal/vertical position.

1. Set the camera to shooting mode.
2. MENU -  (Settings) -  (Shooting Settings) - [Grid Line] - desired mode - ●

On:

Displays grid lines. The grid lines are not recorded.

Off(Default setting):

Does not display grid lines.

### [Notes on use](#)

4-533-356-11(1)

Copyright 2014 Sony Corporation



## Viewing still images

---

You can play back still images.

1. Set the camera to playback mode.
2. Select the desired image using the control button.

### Hint

#### Viewing images taken with a different camera

If the camera detects images not registered in the Image Database File on the memory card, a registration screen with the message "Files found which were not recognized Import files" will be displayed. To view unregistered images, register them by selecting [OK].

#### [Notes on use](#)

4-533-356-11(1)

Copyright 2014 Sony Corporation



## Playback zoom

You can enlarge the image being played back.

1. Set the camera to playback mode.
2. Press the T button of the W/T (zoom) button during still image playback.
3. Adjust the position using ▲ / ▼ / ◀ / ▶ on the control button.
  - The frame in the lower left of the image shows which part of the total image is being displayed.

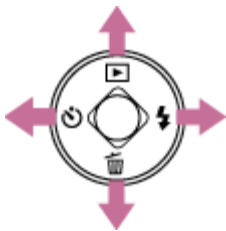

4. Change the zoom scale with the W/T (zoom) button.
  - Press the T button to zoom in, W button to zoom out.

[Notes on use](#)

4-533-356-11(1)

Copyright 2014 Sony Corporation

Digital Still Camera  
DSC-W800

## Image Index

---

When you play back images, you can display multiple images at the same time.

1. Set the camera to playback mode.
2. Press the W button to display the image index screen.  
Press the button again to display an index screen with more images.

### Displaying images of the desired folder

Select the left side bar with the control button, then select the desired folder with ▲ / ▼ .



### [Notes on use](#)

4-533-356-11(1)

Copyright 2014 Sony Corporation



## Easy Mode

---

When viewing still images in Easy Mode, the playback screen text becomes larger, and the indicators become easier to see.

1. Set the camera to playback mode.
2. MENU - **EASY** (Easy Mode) - [OK] - ● on the control button
  - To end Easy Mode, MENU - [Exit Easy Mode].

### Viewing functions available in Easy Mode

In Easy Mode, only the deletion function is available.

 (Delete): You can delete the currently displayed image.

MENU: You can delete the currently displayed image with [1 image], and delete all images in the selected date range or internal memory (if selected) with [All].

Select [Exit Easy Mode] - [OK] to exit Easy Mode.

### [Notes on use](#)

4-533-356-11(1)

Copyright 2014 Sony Corporation

Digital Still Camera  
 DSC-W800

## Deleting images





You can select and delete unwanted images. You can also delete images from the MENU button.

1. Set the camera to playback mode.
2. Press  (Delete) on the control button - operate in accordance with the screen.

All in This Folder:

Deletes all images in the selected date range or folder at once.

Multiple Images:

1. After step 2, select an image to be deleted, then press  .  
To cancel the selection, press  again to cancel the  mark.
2. MENU - [OK] - 

This Image:

Deletes the image in single-image mode.

Cancel:

Cancels the deletion.

Hint

You can switch between index and single-image mode when selecting images

Press the T button of the W/T (zoom) button in index mode to return to single-image mode, and press the W button in single-image mode to return to index mode.

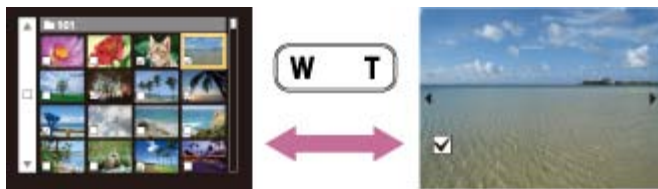

### Note

- In Easy mode, you can select from [1 image] or [All].
- When using internal memory, still images and movies are displayed in the same folder in folder view.

### Notes on use

4-533-356-11(1)

Copyright 2014 Sony Corporation

Digital Still Camera  
DSC-W800



## Viewing movies

You can play back recorded movies.



1. Select the desired movie you want to play back using the control button.
2. Press  to play back.

### Action during movie playback



-  : Pause/Play
-  : Fast forward
-  : Fast rewind

#### Note

- You may not be able to play back some movies shot using other cameras.
- You can adjust the playback volume in MENU -  (Settings) -  (Main Settings) - [Volume].

### Notes on use

4-533-356-11(1)

Copyright 2014 Sony Corporation

Digital Still Camera  
DSC-W800





## Playing back panoramic images

You can view an entire panoramic image with automatic scrolling.

1. Select the desired panoramic image using the control button.
2. Press  to play back.



(A): Shows the displayed area of the whole panorama image

- To pause the playback, press  again.
- Scroll with  /  /  / .
- Return to the full view by the W (Zoom) button.

**Note**

- A panoramic image recorded using another camera may appear in an image size different from the original one, or may not be played back correctly with scrolling.

[Notes on use](#)

4-533-356-11(1)

Copyright 2014 Sony Corporation

Digital Still Camera  
DSC-W800

## Print (DPOF)

DPOF (Digital Print Order Format) is a function that you can specify the images of the memory card that you want to print out later.

The **DPOF** (Print order) mark is displayed for registered images.

1. Set the camera to playback mode.
2. MENU - **DPOF** - desired mode - ● on the control button

 (This Image):

Orders printing the currently displayed image in single-image mode.

 (Multiple Images):

You can select and order multiple images to be printed.

1. After step 2, select an image to be printed, then press ●.  
To cancel the selection, press ● again to cancel the ✓ mark.
2. MENU - [OK] - ●

### Note

- The **DPOF** (Print order) mark cannot be added to the following images:
  - Movies
  - Images in internal memory
- You can add a **DPOF** (Print order) mark to a maximum 999 images.

### Clearing the DPOF mark

Select the image to clear the DPOF registration, then press ● on the control button in the same procedure as when making a **DPOF** mark. The **DPOF** mark disappears and the DPOF registration is cleared.

#### Related Topic

- [Printing still images](#)

#### Notes on use

4-533-356-11(1)

Copyright 2014 Sony Corporation

## Printing still images

You can print still images using the following methods.

- Printing directly using a printer which supports your memory card type.  
For details, see the operating instructions supplied with the printer.
- Printing using a computer  
You can import images to a computer using the PlayMemories Home software and print the images. You can print images with the date.  
For details, see the PlayMemories Home Help Guide.
- Printing at a shop  
You can take a memory card to a photo printing service shop. As long as the shop supports photo printing services conforming to DPOF, you can make a **DPOF** (Print order) mark on images in advance in playback mode so that you do not have to reselect them when you print them out at the shop.  
Before you take image data to a shop, always copy (back up) your data.

### Note

- When you print still images shot in [16:9] mode, both edges may be cut off.
- You cannot print panoramic images, depending on the printer.

### Related Topic

● [Print \(DPOF\)](#)

### Notes on use

4-533-356-11(1)

Copyright 2014 Sony Corporation



## Rotate

---

A still image can be rotated. Use this to display a horizontal orientation image in vertical orientation.

1. Set the camera to playback mode.
2. MENU -  (Rotate) - ● on the control button
3. Press ● on the control button

### Note

- You cannot rotate the following images:
  - Movies
  - Protected still images
- You may not be able to rotate images shot with other cameras.
- When viewing images on a computer, the image rotation information may not be reflected, depending on the software.

### [Notes on use](#)

4-533-356-11(1)

Copyright 2014 Sony Corporation



## Protect

---

You can protect recorded images against accidental erasure.

The  mark is displayed for registered images.

1. Set the camera to playback mode.
2. MENU -  (Protect) - desired mode - ● on the control button

 (This Image):

Protects the currently displayed image in single-image mode.

 (Multiple Images):

You can select and protect multiple images.

1. After step 2, select an image to be protected, then press ● .  
To cancel the selection, press ● again to cancel the  mark.
2. MENU - [OK] - ●

### To cancel protection

Select the image for which you want to cancel protection, and unlock it by pressing ● on the control button as the same procedure to protect it. The  indicator disappears, and the protection is released.

### Notes on use

4-533-356-11(1)

Copyright 2014 Sony Corporation

Digital Still Camera  
DSC-W800

### Viewing an image on a Standard Definition (SD) TV

You can view images recorded on the camera in standard picture quality by connecting the camera to a Standard Definition (SD) TV. Refer also to the operating instructions supplied with the TV.

1. Turn off the power of the camera and the TV.
2. Connect the USB / A/V OUT terminal (A) and audio/video input jacks on the TV (B) using the dedicated A/V cable VMC-15CSR1 (sold separately) (C).

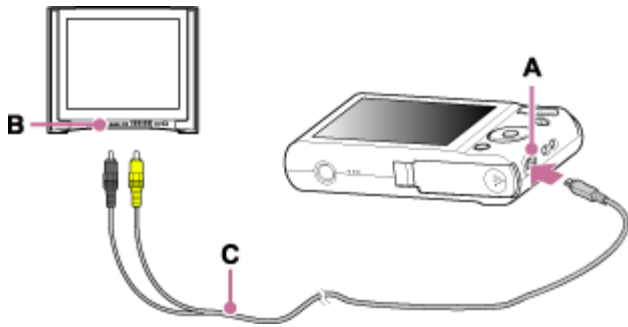

3. Turn on the TV and set the input.
4. Press ON/OFF (Power) button, then set the camera to playback mode.  
Images shot with the camera appear on the TV. Select the desired image with the control button.

**Note**

- When using the camera abroad, it may be necessary to switch [Video Out].

[Notes on use](#)

4-533-356-11(1)

Copyright 2014 Sony Corporation

Digital Still Camera  
DSC-W800

## Disp. Resolution

---

Adjusts the image quality on the screen for shooting.

1. MENU -  (Settings) -  (Shooting Settings) - [Disp. Resolution] - desired mode - ●

High(Default setting):

Displays the image on the screen in high image quality.

Standard:

Displays the image on the screen in standard image quality.

### Note

- In Sweep Panorama and Movie Mode, [Disp. Resolution] is set to [High].

### Notes on use

4-533-356-11(1)

Copyright 2014 Sony Corporation

## Beep

---

Selects the sound produced when you operate the camera.

1. MENU -  (Settings) -  (Main Settings) - [Beep] - desired mode - ●

Shutter:

Turns on the shutter sound when you press the shutter button.

On(Default setting):

Turns on the beep/shutter sound when you press the control button/shutter button.

Off:

Turns off the beep/shutter sound.

### [Notes on use](#)

4-533-356-11(1)

Copyright 2014 Sony Corporation



Digital Still Camera  
DSC-W800

## Volume

---

Adjusts sound volume from level 1 to 5 for movie playback.

1. MENU -  (Settings) -  (Main Settings) - [Volume] - desired mode - ●

### [Notes on use](#)

4-533-356-11(1)



Copyright 2014 Sony Corporation

Digital Still Camera  
DSC-W800

## Monitor Brightness

---

Selects screen brightness from level 1 to 5. The screen becomes brighter as the number rises.  
When you use the camera in bright outside light, select a higher number to see the screen easier.

1. MENU -  (Settings) -  (Main Settings) - [Monitor Brightness] - desired mode - ●

### Note

- The brighter the screen, the faster the battery pack runs out.
- The screen grows dark if you do not operate the camera while the power is on.

### [Notes on use](#)

4-533-356-11(1)

Copyright 2014 Sony Corporation





Digital Still Camera  
DSC-W800

## Language Setting

---

Selects the language to be used in menu items, warnings and messages.

1. MENU -  (Settings) -  (Main Settings) - [Language Setting] - desired mode - ●

### [Notes on use](#)

4-533-356-11(1)

Copyright 2014 Sony Corporation





Digital Still Camera  
DSC-W800

## Initialize

---

Initializes settings to the default setting.

Even if you execute this function, images are retained.

1. MENU -  (Settings) -  (Main Settings) - [Initialize] - [OK] - ●

### Note

- Be sure not to remove the battery pack while initializing.

### [Notes on use](#)

4-533-356-11(1)

Copyright 2014 Sony Corporation

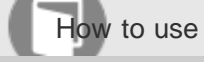

Digital Still Camera  
DSC-W800

## Function Guide

---

You can select whether or not the function guide is displayed when you operate the camera.

1. MENU -  (Settings) -  (Main Settings) - [Function Guide] - desired mode - ●

On(Default setting):

Off:

Sets whether to display the function guide.

### [Notes on use](#)

4-533-356-11(1)

Copyright 2014 Sony Corporation

Digital Still Camera  
DSC-W800

## Display Setting

Sets the display setting mode.

1. MENU -  (Settings) -  (Main Settings) - [Display Setting] - desired mode - ●

 (ON)(Default setting):

Displays the information.



 (Detailed Info):

Displays the information. Exif data for the recorded image are also displayed.



 (OFF):

Displays only images.



### [Notes on use](#)

4-533-356-11(1)

Copyright 2014 Sony Corporation

Digital Still Camera  
DSC-W800

## Video Out

Sets the video signal output according to the TV color system of the connected video equipment. The TV color systems differ depending on the country and region.

To view images on a TV screen, check the TV color system of the country or region of use.

1. MENU -  (Settings) -  (Main Settings) - [Video Out] - desired mode - ●

## NTSC:

Sets the video output signal to NTSC mode (e.g., for the USA, Japan).

## PAL:

Sets the video output signal to PAL mode (e.g., for Europe, China).

## Related Topic

- [On TV color systems](#)

[Notes on use](#)

4-533-356-11(1)

Copyright 2014 Sony Corporation



## USB Connect Setting

---

Sets how to make a USB connection when connecting the camera to a computer, etc.

1. MENU -  (Settings) -  (Main Settings) - [USB Connect Setting] - desired mode - ●

Mass Storage(Default setting):

Establishes a Mass Storage connection between the camera and a computer or other USB device.

PTP/MTP:

When you connect the camera to a computer, the AutoPlay Wizard appears, and still images in the recording folder on the camera are imported to the computer. (with Windows 7, Windows 8, Windows Vista, Windows XP, Mac OS X)

### Note

- When [USB Connect Setting] is set to [PTP/MTP], you cannot export movies to a computer. To export movies to a computer, set [USB Connect Setting] to [Mass Storage].

### [Notes on use](#)

4-533-356-11(1)

Copyright 2014 Sony Corporation

Digital Still Camera  
DSC-W800

## USB Power Supply

---

Sets whether to use the USB power supply function when the camera is connected to a computer or USB device using the dedicated USB cable (supplied).

1. MENU -  (Settings) -  (Main Settings) - [USB Power Supply] - desired mode - ●

On(Default setting):

Uses [USB Power Supply] function when a USB connection is established.

Off:

Does not use [USB Power Supply] function when a USB connection is established.

### [Notes on use](#)

4-533-356-11(1)

Copyright 2014 Sony Corporation



## LUN Setting

---

Sets USB connection mode when connecting the camera to a computer, etc.

1. MENU -  (Settings) -  (Main Settings) - [LUN Setting] - desired mode - ●

Multi(Default setting):

Images both on the memory card and in internal memory are displayed. Select this setting when you connect the camera to a computer.

Single:

When the memory card is inserted into the camera, images on the memory card are displayed; when it is not inserted, images in internal memory are displayed. Select this setting in cases where images of both the memory card and internal memory are not displayed when the camera is connected to a device other than a computer.

### [Notes on use](#)

4-533-356-11(1)

Copyright 2014 Sony Corporation

 Digital Still Camera  
 DSC-W800

 Eye-Fi
 

---

You can use the upload function by using a commercially available Eye-Fi card.

The menu screen of the auto upload function is displayed only when the Eye-Fi card is inserted in the memory card slot of the camera.

1. MENU -  (Settings) -  (Main Settings) - [Eye-Fi] - desired mode - ●

On(Default setting):

Enables the upload function.

The Eye-Fi mode display icon on the screen will change depending on the communication mode of the Eye-Fi card.

: Eye-Fi card is in standby mode. There is no image to be sent.

: Eye-Fi card is in upload standby mode.

: Eye-Fi card is in connecting mode.

: Eye-Fi card is uploading images.

: An error has occurred.

Off:

Disables the upload function.



**Note**

- Eye-Fi cards are sold in the some countries or regions.
- For more information on the Eye-Fi card, contact the manufacturer or seller of Eye-Fi cards directly.
- Eye-Fi cards are permitted only in the countries and regions in which they were purchased. You may be held liable due to local restrictions.
- The Eye-Fi card has a wireless LAN function. Do not insert the Eye-Fi card where wireless LAN is prohibited, such as while aboard an airplane. If the Eye-Fi card is inserted, set [Eye-Fi] to [Off]. When the uploading function of the Eye-Fi card is set to [Off],  is displayed on the screen.

## Transferring image data using the Eye-Fi card

1. Set the wireless LAN access point settings or the transferring direction settings of the Eye-Fi card.  
For details, refer to the operating instructions supplied with the Eye-Fi card.
2. After the settings are finished, insert the Eye-Fi card into the camera, and shoot the images.  
The recorded images are automatically transferred via wireless LAN to a computer, etc.

**Note**

- When uploading image data, [Power Save] is not available.
- If the  (error) icon is displayed, eject and re-insert the Eye-Fi card, or turn the power of the camera off and on again. If the  (error) icon is still displayed, the Eye-Fi card may be corrupted. For details, contact Eye-Fi, Inc.



- Wireless LAN communication may be interrupted by other communication devices. If data reception is insufficient, move the camera closer to the access point.
- Some Eye-Fi cards have an "Endless Memory Mode." This product does not support "Endless Memory Mode." Make sure that Eye-Fi cards that you insert into this product have "Endless Memory Mode" turned off. For details on setting "Endless Memory Mode", refer to the operating instructions supplied with the Eye-Fi card.

### Notes on use

4-533-356-11(1)

Copyright 2014 Sony Corporation

## Power Save

Sets the length of time until the screen goes dark and the time until the camera turns off.

If you do not operate the camera for a certain period of time while the power is on using the battery pack, the screen goes dark and the camera later turns off automatically to prevent wearing down the battery pack (Auto power-off function).

1. MENU -  (Settings) -  (Main Settings) - [Power Save] - desired mode - ●

Max:

Saves battery power better than when set to [Standard]. If the camera is not operated for a certain period of time, the power turns off automatically. In shooting mode, the screen automatically goes dark before the power turns off.

Standard (Default setting):

If the camera is not operated for a certain period of time, the power turns off automatically. In shooting mode, the screen automatically goes dark before the power turns off.

It takes longer before the power turns off than when set to [Max].

Off:

Does not use the Auto power-off function.

### Note

- The camera does not turn off automatically in the following situations:
  - During playing back movies
  - During Eye-Fi connection

### [Notes on use](#)

4-533-356-11(1)



Copyright 2014 Sony Corporation

## Format

---

Formats the memory card.

When you use a memory card with this camera for the first time, it is recommended to format the card using the camera for stable performance of the memory card before shooting. Note that formatting permanently erases all data on the memory card, and is unrecoverable. Save precious data on a computer, etc.

1. MENU -  (Settings) -  (Memory Card Tool) or  (Internal Memory Tool) - [Format] - [OK] - ●

### Note

- Note that formatting permanently erases all data including even protected images.

### [Notes on use](#)

4-533-356-11(1)

Copyright 2014 Sony Corporation

## Create REC.Folder

---

Creates a folder in a memory card for recording images.

Images are recorded in the newly created folder until you create another folder or select another recording folder.

1. MENU -  (Settings) -  (Memory Card Tool) - [Create REC.Folder] - [OK] - ●

### Hint

#### On folders

After a new folder is created, you can change the storage destination folder.

### Note

- This item is not displayed when internal memory is used to record images.
- When you insert a memory card that was used with other equipment into the camera and shoot images, a new folder may be automatically created.
- Up to 4,000 images can be stored in one folder. When the folder capacity is exceeded, a new folder is automatically created.

### Notes on use

4-533-356-11(1)



Copyright 2014 Sony Corporation



## Change REC.Folder

---

Changes the folder in the memory card that is currently used for recording images.

1. MENU -  (Settings) -  (Memory Card Tool) - [Change REC.Folder]
2. Select a folder with ◀ / ▶ on the control button.
3. [OK] - ●

### Note

- This item is not displayed when the internal memory is used to record images.
- You cannot select a folder with a number that has only "□ □ □ MSDCF" or "□ □ □ ANV01" as a recording folder.
- You cannot move recorded images to another folder.

### Notes on use

4-533-356-11(1)



Copyright 2014 Sony Corporation



## Delete REC.Folder

---

Deletes a folder for recording images in a memory card.

1. MENU -  (Settings) -  (Memory Card Tool) - [Delete REC.Folder]
2. Select a folder with ◀ / ▶ on the control button.
3. [OK] - ●

### Note

- This item is not displayed when internal memory is used to record images.
- If you delete the folder set as the recording folder using [Delete REC.Folder], the folder that has the largest folder number is selected as the next recording folder.
- If a folder contains protected images, images other than protected images are deleted and the folder will remain.
- If a folder contains files that cannot be played back by the camera, you cannot delete a folder.

### Notes on use



4-533-356-11(1)

Copyright 2014 Sony Corporation

## Copy

---

Copies all images in the internal memory to a memory card.

1. Insert a memory card with sufficient free capacity into the camera.
2. MENU -  (Settings) -  (Memory Card Tool) - [Copy] - [OK] - ●

### Note

- Make sure there is sufficient battery power. Otherwise, the battery power may run out when you attempt to copy image files, causing the copy to fail and possibly corrupt the data.
- Images cannot be copied individually.
- Original images in internal memory are retained even after copying. To delete contents of internal memory, remove the memory card after copying, then format internal memory ([Format] in [Internal Memory Tool]).
- A new folder is created on the memory card and all data will be copied to it. You cannot choose a specific folder and copy images to it.

### [Notes on use](#)



4-533-356-11(1)

Copyright 2014 Sony Corporation

## File Number

---

Selects the method used to assign file numbers to images.

1. MENU -  (Settings) -  (Memory Card Tool) - [File Number] - desired mode - ●

Series(Default setting):

Assigns sequential numbers to files even if the recording folder or the memory card is changed. (When the replaced memory card contains a file with a number higher than the last assigned number, the higher number is incremented and assigned.)

Reset:

Starts from 0001 each time the folder is changed. (When the recording folder contains a file, a number one higher than the largest number is assigned.)

### [Notes on use](#)

4-533-356-11(1)



Copyright 2014 Sony Corporation



Digital Still Camera  
DSC-W800

## Area Setting

Sets the area in which you are using this camera.

1. MENU -  (Settings) -  (Clock Settings) - [Area Setting] - desired mode - [OK] - ●

Home(Default setting):

Uses the camera in your area. When the currently set area differs from your home area, you must make the Area Setting.

Destination:

Uses the camera set to the time at your destination. Set the destination area.

### Changing Area Setting

Setting a frequently visited destination lets you easily adjust the time when you visit that destination.

1. Select the area part for [Destination], then press ●.

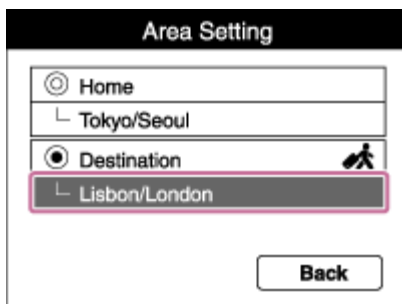

2. Press ◀/▶ on the control button to select the desired area, then select Summer Time using ▲/▼.

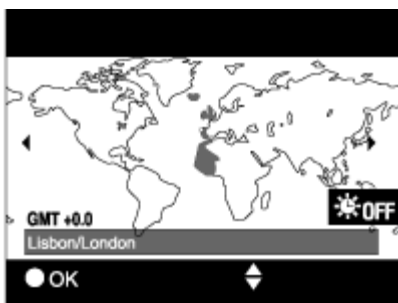

[Notes on use](#)

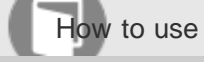



Digital Still Camera  
DSC-W800

## Date & Time Setting

---

Sets date and time again.

1. MENU -  (Settings) -  (Clock Settings) - [Date & Time Setting] - desired mode - ●
2. Set the numeric value and desired setting with ▲/▼/◀/▶ on the control button.
3. [OK] - ●

Date & Time Format:

You can select the date and time display format.

Summer Time:

You can select Summer Time [On]/[Off].

Date & Time:

You can set date and time.

### [Notes on use](#)

4-533-356-11(1)

Copyright 2014 Sony Corporation



Digital Still Camera  
DSC-W800

## Recommended computer environment

---

You can check the system requirements for software at the following URL.

[www.sony.net/pcenv/](http://www.sony.net/pcenv/)

### Notes on use

4-533-356-11(1)

Copyright 2014 Sony Corporation

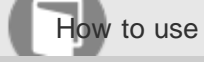

Digital Still Camera  
DSC-W800

## PlayMemories Home

---

Below are examples of functions available when you use PlayMemories Home.

- You can import images recorded on the camera to a computer.
- You can play back images stored on the computer and the camera.
- You can share images using the PlayMemories Online.

Below are examples of functions available when you use Windows.

- You can display images stored on a computer by shooting date in a calendar display.
- You can edit still images, such as resizing (Resize) and cropping (Trimming).
- You can upload images to a network service. (An internet connection environment is required.)
- For other details, refer to the Help of PlayMemories Home.

### [Notes on use](#)

4-533-356-11(1)

Copyright 2014 Sony Corporation

## Installing PlayMemories Home

1. Using the Internet browser on your computer, go to the following URL, then install PlayMemories Home.  
[www.sony.net/pm/](http://www.sony.net/pm/)
  - Follow the instructions on the screen to complete the installation.
  - When the installation is completed, PlayMemories Home will start.
  - If the software PMB (Picture Motion Browser) has already been installed on your computer, it will be overwritten by PlayMemories Home during the installation. Use PlayMemories Home the successor software of PMB.
2. Connect the camera to your computer using the dedicated USB cable (supplied) (A).
  - Some new functions may be added to the PlayMemories Home. Even if PlayMemories Home is already installed, connect the camera to your computer.



A: To a USB jack of the computer

B: To the USB A/V OUT terminal

### Note

- Log on as Administrator.
- It may be necessary to restart your computer. When the restart confirmation message appears, restart the computer following the instructions on the screen.
- DirectX may be installed depending on your computer's system environment.

### Notes on use

4-533-356-11(1)

Copyright 2014 Sony Corporation



Digital Still Camera  
DSC-W800

## Software for Mac

---

For details on software for Mac, access the following URL:

<http://www.sony.co.jp/imsoft/Mac/>

### Note

- The available software varies depending on the area.

### Notes on use

4-533-356-11(1)

Copyright 2014 Sony Corporation

Digital Still Camera  
DSC-W800

## Connecting the camera to the computer

1. Insert the fully charged battery in the camera.
2. Power on the camera and the computer.
3. Connect the camera to your computer using the dedicated USB cable (supplied) (A).

**Note**

- When connecting the camera to a computer using the dedicated USB cable, power feeding from the computer starts if [USB Power Supply] is set to [On]. ([On] is the default setting.)

## Related Topic

- [USB Connect Setting](#)
- [LUN Setting](#)

[Notes on use](#)

4-533-356-11(1)

Copyright 2014 Sony Corporation



## Importing images to a computer

PlayMemories Home allows you to easily import images.

For details on PlayMemories Home functions, see the PlayMemories Home Help Guide.

### Importing images to a Windows computer without using PlayMemories Home

When the AutoPlay Wizard appears after making a USB connection between the camera and a computer, click [Open folder to view files] - [OK] - [DCIM] copy the desired images to the computer.



#### Note

- If the Device Stage screen appears with Windows 7 or Windows 8, double-click [Browse Files] - media icon - folder in which the image you want to import is stored.

### Importing images to a Mac computer without using PlayMemories Home

Connect the camera to your Mac computer. Double-click the newly recognized icon on the desktop - the folder in which the image you want to import is stored. Then drag and drop the image file on to the hard disk icon.

#### Note

- Set MENU -  (Settings) -  (Main Settings) - [USB Connect Setting] to [Mass Storage].

### Notes on use

4-533-356-11(1)

Copyright 2014 Sony Corporation





## Disconnecting the camera from the computer

---

Disconnects the camera from the computer.

Perform procedures from step 1 to 2 below before performing the following operations:

- Disconnecting the cable.
- Removing a memory card.
- Turning off the camera.

1. Click  on the task tray, then click  (disconnect icon).
  - For Windows Vista, click  on the task tray.
2. Click the confirmation message displayed on the screen.

### Note

- Drag and drop the icon of the memory card or the drive icon to the "Trash" icon beforehand when you use a Mac computer, and the camera is disconnected from the computer.
- The disconnect icon may not appear when you use a Windows 7, Windows 8 computer. In this case, you can disconnect the camera from the computer without following the above steps.

### [Notes on use](#)

4-533-356-11(1)

Copyright 2014 Sony Corporation



## Precautions

---

### Internal memory and memory card back up

- Do not turn off the camera, remove the battery pack, or remove the memory card while the access lamp is lit. Otherwise, the internal memory data or the memory card may be damaged. Be sure to make a backup copy to protect your data.

### On database files

When you insert a memory card without a database file into the camera and turn on the power, part of the memory card capacity is used to automatically create a database file. It may take some time until you can perform the next operation. If a database file error occurs, import all the images to a computer using PlayMemories Home, then format the memory card.

### Do not use/store the camera in the following places

- In an extremely hot, cold or humid place  
In places such as in a car parked in the sun, the camera body may become deformed and this may cause a malfunction.
- Storing under direct sunlight and near a heater  
The camera body may become discolored or deformed, and this may cause a malfunction.
- In a location subject to rocking vibration
- Near strongly magnetic place

### On carrying

Do not sit down in a chair or other place with the camera in the back pocket of your trousers or skirt, as this may cause malfunction or damage the camera.

### On operating temperature

Your camera is designed for use under the temperatures between 0°C and 40°C (32°F and 104°F). Shooting in extremely cold or hot places that exceed this range is not recommended.

### On moisture condensation

- If the camera is brought directly from a cold to a warm location, moisture may condense inside or outside the camera. This moisture condensation may cause a malfunction of the camera.
- If moisture condensation occurs, turn off the camera and wait about an hour for the moisture to evaporate. Note that if you attempt to shoot with moisture remaining inside the lens, you will be unable to record clear images.

### On image data compatibility

- The camera conforms with DCF (Design rule for Camera File system) universal standards established by JEITA (Japan Electronics and Information Technology Industries Association).
- Sony does not guarantee that the camera will play back images recorded or edited with other equipment, or that other equipment will play back images recorded with the camera.

#### Notes on the screen and lens

- The screen is manufactured using extremely high-precision technology so over 99.99% of the pixels are operational for effective use. However, some tiny black and/or bright dots (white, red, blue or green) may appear on the screen. These dots are a normal result of the manufacturing process and do not affect the recording.
- Exposing the screen or lens to direct sunlight for long periods may cause malfunctions. Be careful when placing the camera near a window or outdoors.
- Do not press against the screen. The screen may be discolored and that may cause a malfunction.
- Images may trail across on the screen in a cold location. This is not a malfunction.

#### Note on disposal/transfer of the camera

To protect personal data, perform the following when disposing of or transferring the camera.

- Reset all camera settings by performing MENU -  (Settings) -  (Main Settings) - [Initialize].

#### Notes on use

4-533-356-11(1)

Copyright 2014 Sony Corporation



## Backup of various settings, date and time

---

The rechargeable backup battery is continually charged as long as you are using the camera. However, if you use the camera for only short periods, it discharges gradually, and if you do not use the camera at all for about 3 months it becomes completely discharged. In this case, be sure to charge the rechargeable backup battery before using the camera. However, even if the rechargeable backup battery is not charged, you can still use the camera, but the date and time will not be indicated.

If the settings are reset every time the battery is charged, the internal rechargeable backup battery may be exhausted. Contact your dealer or local authorized service facility.

### Charging method of the internal rechargeable backup battery

Insert a charged battery in the camera, or connect the camera to a wall outlet (wall socket) using the AC adapter (supplied) and leave the camera for 24 hours or more while the power of the camera is turned off.

### [Notes on use](#)

4-533-356-11(1)

Copyright 2014 Sony Corporation

Digital Still Camera  
 DSC-W800

## Battery pack

## On charging the battery pack

- Charge the battery pack (supplied) before using the camera for the first time.
- You can charge the battery pack even if it is not completely discharged. In addition, even if the battery pack is not fully charged, you can use the partially charged capacity of the battery pack as is.
- We recommend charging the battery pack in an ambient temperature of between 10°C to 30°C (50°F to 86°F). The battery pack may not be effectively charged in temperatures outside this range.

## Effective use of the battery pack

- Battery performance decreases in low temperature surroundings. So in cold places, the operational time of the battery pack is shorter. We recommend the following to ensure longer battery pack use:  
Put the battery pack in a pocket close to your body to warm it up, and insert it in the camera immediately before you start shooting. (If there are any metal objects such as keys in your pocket, be aware of short-circuits.)
- The battery pack will run out quickly if you use flash or zoom frequently.
- We recommend having spare battery packs handy for two times or three times the expected shooting time, and making trial shots before taking the actual shots.
- Do not expose the battery pack to water. The battery pack is not water-resistant.
- Do not leave the battery pack in extremely hot places, such as in a car or under direct sunlight.
- You may not be able to turn on the camera or the battery pack may not be effectively charged if the terminal section of the battery is dirty. In this case, wipe any dust off lightly using a soft cloth or a cotton swab to clean the battery.

## Remaining battery charge

- A remaining charge indicator appears on the screen.



A: High

B: Low

- It takes about 1 minute until the correct remaining charge indicator appears.
- The remaining charge indicator may not be correct under certain circumstances.
- If you do not operate the camera for a certain period of time while the power is on, the camera turns off automatically. (Auto power-off function)
- If the battery remaining charge is not displayed, change the DISP (Display Setting).

## How to store the battery pack

- Fully discharge the battery pack before storing and store the camera in a cool, dry place. To maintain the battery

- pack's function, charge the battery pack and then fully discharge it in the camera at least once a year while storing.
- To prevent staining the terminal, short-circuiting, etc., be sure to use a plastic bag, etc. to keep away from metal materials when carrying or storing.

### On battery life

- Battery life is limited. Battery capacity decreases over time and through repeated use. If the available time of the battery is shortened significantly, it is probably time to replace it with a new one.
- Battery life varies according to how it is stored and operating conditions and environment in which each battery pack is used.

### Compatible battery pack

The NP-BN (supplied) or NP-BN1 (sold separately) can be used with this model.

### Notes on use

4-533-356-11(1)

Copyright 2014 Sony Corporation



## Notes on charging the battery pack

- The supplied AC Adaptor is dedicated to this camera. Do not connect with other electronic devices. Doing so may cause a malfunction. Also, make sure to use a genuine Sony AC Adaptor.
- If the Charge lamp of the camera flashes during charging, remove the battery pack being charged, and then insert the same battery pack into the camera securely again. If the Charge lamp flashes again, this may indicate a battery error or that a battery pack other than the specified type has been inserted. Check that the battery pack is the specified type. If the battery pack is the specified type, remove the battery pack, replace it with a new or different one and check that the battery is charged correctly. If the battery is charged correctly, a battery error may have occurred.
- If the Charge lamp flashes even if the AC Adaptor is connected to the camera and the wall outlet (wall socket), this indicates that charging has stopped temporarily and is on standby. Charging stops and enters standby status automatically when the temperature is outside of the recommended operating temperature. When the temperature returns to the appropriate range, charging resumes and the Charge lamp lights up again. We recommend charging the battery pack in an ambient temperature of between 10°C to 30°C (50°F to 86°F).
- Using the supplied AC Adaptor, you can charge the battery pack inserted in the camera. In addition, power supply via AC Adaptor in playback mode is also available. However, in shooting mode, power supply via AC Adaptor is not available. You need AC Adaptor AC-UD10 (sold separately) or AC-UD11 (\*) (sold separately) to supply power from a wall outlet (wall socket) while shooting.

\* The AC Adaptor AC-UD11 (sold separately) may not be available in some countries/regions.

### [Notes on use](#)

4-533-356-11(1)

Copyright 2014 Sony Corporation

Digital Still Camera  
DSC-W800

## Memory card

## Memory card

Memory card can be used in the camera is listed below.

Memory Stick PRO Duo media:

(Memory Stick XC-HG Duo media/Memory Stick PRO Duo media/Memory Stick PRO-HG Duo media)

Memory Stick Micro media:

(Memory Stick Micro (M2) media/Memory Stick Micro (Mark2) media)

SD memory card:

(SD memory card/SDHC memory card/SDXC memory card)

microSD memory card:

(microSD memory card/microSDHC memory card/microSDXC memory card)

- Memory Stick PRO Duo media of up to 64 GB and SD memory cards of up to 64 GB have been tested and proven to operate with your camera.
- Memory Stick Micro media of up to 16 GB and microSD memory cards of up to 64 GB have been tested and proven to operate with your camera.
- When recording movies, it is recommended that you use the following memory cards:
  - **MEMORY STICK PRO DUO** (Mark2) (Memory Stick PRO Duo (Mark2) media)
  - **MEMORY STICK XC-HG DUO** (Memory Stick XC-HG Duo media)
  - **MEMORY STICK PRO-HG DUO** (Memory Stick PRO-HG Duo media)
  - **MEMORY STICK MICRO** (Mark2) (Memory Stick Micro (Mark2) media)
  - SD card (Class 4 or faster), microSD memory card (Class 4 or faster)

**Note**

- To ensure stable operation of the memory card, we recommend that you use this camera to format any memory card being used with this camera for the first time. Note that formatting will erase all data recorded on the memory card. This data cannot be restored. Be sure to back up any important data to a PC or other storage location.
- If you repeatedly record/delete images over a long period of time, fragmentation of data may occur on the memory card and movies may not be recorded properly. In such a case, save your images to a computer or other storage location, then [Format].
- A memory card formatted with a computer is not guaranteed to operate with the camera.
- Data read/write speeds differ depending on the combination of the memory card and the equipment used.
- We recommend backing up important data.
- Do not attach a label on the memory card itself nor on a memory card adaptor.
- Do not touch the terminal section of the memory card with your hand or a metal object.



- Do not strike, bend or drop the memory card.
- Do not disassemble or modify the memory card.
- Do not expose the memory card to water.
- Do not leave the memory card within the reach of small children. They might accidentally swallow it.
- Be aware that the memory card will be hot immediately after it has been used for a long time.
- Insert a memory card that fits the memory card slot size. Otherwise, it will cause a malfunction.
- Do not use or store the memory card under the following conditions:
  - High temperature locations such as the hot interior of a car parked in direct sunlight
  - Locations exposed to direct sunlight
  - Humid locations or locations with corrosive substances present
- Images recorded in Memory Stick XC-HG Duo media, SDXC memory cards, or micro SDXC memory cards cannot be transferred or played back on computers or AV devices that are not exFAT-compatible, even when the camera is connected to the computer or AV device using a USB cable. Before connecting, make sure that the device is exFAT-compatible. If connected to a device that is not exFAT-compatible, a format drive request may appear. Do not format the drive, or all data will be lost. (exFAT is the file system used by Memory Stick XC-HG Duo media, SDXC memory cards and microSDXC memory cards.)

#### Note on using the memory card adaptor (sold separately)

- When inserting a memory card into a memory card adaptor, make sure the memory card is inserted facing in the correct direction, then insert it all the way in. Incorrect insertion may result in a malfunction.
- When using Memory Stick Micro media or a microSD memory card, be sure to insert into the dedicated memory card adaptor.

#### Memory Stick media

The types of Memory Stick media that can be used with the camera are listed below. However, proper operation cannot be guaranteed for all Memory Stick media functions.

- Memory Stick PRO Duo media: \*1\*2\*3
- Memory Stick PRO-HG Duo media: \*1\*2
- Memory Stick XC-HG Duo media: \*1\*2
- Memory Stick Micro (M2) media: \*1
- Memory Stick Micro (Mark2) media: \*1

\*1 Memory Stick Duo media, MagicGate Memory Stick Duo media, Memory Stick PRO Duo media, Memory Stick PRO-HG Duo media and Memory Stick Micro media are equipped with MagicGate functions. MagicGate is copyright protection technology that uses encryption technology. Data recording/playback that requires MagicGate functions cannot be performed with the camera.

\*2 High-speed data transfer using a parallel interface is supported.

\*3 [1280x720] size movies can be recorded.

#### Notes on using Memory Stick Micro media (sold separately)

- This product is compatible with Memory Stick Micro media (M2). M2 is an abbreviation for Memory Stick Micro media.
- To use a Memory Stick Micro media with the camera, be sure to insert the Memory Stick Micro media into an M2 Adaptor as large as of Duo size. If you insert a Memory Stick Micro media into the camera without an M2 Adaptor as large as of Duo size, you might not be able to remove it from the camera.
- Do not leave the Memory Stick Micro media within the reach of small children. They might accidentally swallow it.

Digital Still Camera  
DSC-W800

## On cleaning

## Cleaning the lens and flash

Wipe the lens and flash with a soft cloth to remove fingerprints, dust, etc.

## Cleaning the lens

- Do not use any cleaners that contain organic solvents such as benzine or thinner.
- When you need to clean the lens surface, remove dust with a blower (commercially available).
- If the camera is very dirty, moisten a soft cloth or lens tissue with the lens cleaner and wipe the lens gently in a circular motion from the center. Do not spray the lens cleaner onto the lens surface directly.

## Cleaning the flash

Clean the flash surface before use. The heat of the flash emission may cause dirt on the flash surface to start smoking or burning. Wipe the flash surface with a soft cloth to remove dirt or dust, etc.

## Cleaning the camera surface

Clean the camera surface with a soft cloth slightly moistened with water, then wipe the surface with a dry cloth. To prevent damage to the finish or casing:

- Do not expose the camera to chemical products such as thinner, benzine, alcohol, disposable cloths, insect repellent, sunscreen or insecticide.
- Do not touch the camera with any of the above on your hand.
- Do not leave the camera in contact with rubber or vinyl for a long time.

[Notes on use](#)

4-533-356-11(1)

Copyright 2014 Sony Corporation

Digital Still Camera  
DSC-W800

## Number of still images

The number of still images may vary depending on the shooting conditions and the memory card.  
(Units: Images)

## Image Size 20M

Internal memory 29 MB: 3

2 GB: 265

4 GB: 530

8 GB: 1050

16 GB: 2100

32 GB: 4300

64 GB: 8500

## Image Size 10M

Internal memory 29 MB: 6

2 GB: 400

4 GB: 800

8 GB: 1600

16 GB: 3200

32 GB: 6400

64 GB: 12000

## Image Size 5M

Internal memory 29 MB: 11

2 GB: 580

4 GB: 1150

8 GB: 2300

16 GB: 4650

32 GB: 9300

64 GB: 18600

## Image Size VGA

Internal memory 29 MB: 200

2 GB: 11500

4 GB: 23500

8 GB: 47000

16 GB: 94000

32 GB: 185000

64 GB: 370000

Image Size 16:9 (15M)

Internal memory 29 MB: 4

2 GB: 330

4 GB: 660

8 GB: 1300

16 GB: 2600

32 GB: 5250

64 GB: 10000

Image Size 16:9 (2M)

Internal memory 29 MB: 35

2 GB: 1800

4 GB: 3650

8 GB: 7300

16 GB: 14500

32 GB: 29000

64 GB: 58000

**Note**

- Even if the number of remaining shootable images is greater than 9,999, the ">9999" indicator appears.
- When an image shot with other cameras is played back on this camera, the image may not appear in the actual image size.

[Notes on use](#)

4-533-356-11(1)

Copyright 2014 Sony Corporation

Digital Still Camera  
DSC-W800

## Recordable time of movies

The table below shows the approximate maximum recording times. These are the total times for all movie files. Recordable time may vary depending on shooting conditions and the memory card.

(h (hour), m (minute), s (second))

## 1280x720

Internal memory 29 MB: -

2 GB: 10 m

4 GB: 20 m

8 GB: 45 m

16 GB: 1 h 30 m

32 GB: 3 h

64 GB: 6 h

## VGA

Internal memory 29 MB: 20 s

2 GB: 20 m

4 GB: 40 m

8 GB: 1 h 20 m

16 GB: 2 h 40 m

32 GB: 5 h 25 m

64 GB: 10 h 55 m

## QVGA

Internal memory 29 MB: 55 s

2 GB: 1 h 5 m

4 GB: 2 h 10 m

8 GB: 4 h 25 m

16 GB: 8 h 50 m

32 GB: 17 h 50 m

64 GB: 36 h

Continuous shooting is possible for approximately 29 minutes (a product specification limit).

The maximum continuous recording time of [1280x720] movie is about 15 minutes (limited by the 2 GB file size restriction).

**Note**

- You cannot record movies to internal memory when the movie image size is [1280x720].



Digital Still Camera  
DSC-W800

## Using the camera abroad

---

You can use the AC Adaptor (supplied) in any country or region where the power supply is within 100 V to 240 V AC, 50 Hz/60 Hz.

### Note

- An electronic voltage transformer is unnecessary and its use may cause a malfunction.

### [Notes on use](#)

4-533-356-11(1)

Copyright 2014 Sony Corporation



Digital Still Camera  
DSC-W800

## On TV color systems

---

To view movies shot using this camera on a television, the camera and television must use the same color television system.

### NTSC system

Bahama Islands, Bolivia, Canada, Central America, Chile, Colombia, Ecuador, Jamaica, Japan, Korea, Mexico, Peru, Surinam, Taiwan, the Philippines, the U.S.A., Venezuela, etc.

### PAL system

Australia, Austria, Belgium, China, Croatia, Czech Republic, Denmark, Finland, Germany, Holland, Hong Kong, Hungary, Indonesia, Italy, Kuwait, Malaysia, New Zealand, Norway, Poland, Portugal, Romania, Singapore, Slovak Republic, Spain, Sweden, Switzerland, Thailand, Turkey, United Kingdom, Viet Nam, etc.

### PAL-M system

Brazil

### PAL-N system

Argentina, Paraguay, Uruguay

### SECAM system

Bulgaria, France, Greece, Guiana, Iran, Iraq, Monaco, Russia, Ukraine, etc.

### [Notes on use](#)

4-533-356-11(1)

Copyright 2014 Sony Corporation



## License

---

### Notes on the License

This camera comes with software that are used based on licensing agreements with the owners of that software. Based on requests by the owners of copyright of these software applications, we have an obligation to inform you of the following. Please read the following sections.

Licenses (in English) are recorded in the internal memory of your camera. Establish a Mass Storage connection between the camera and a computer to read licenses in the "PMHOME" - "LICENSE" folder.

### On GNU GPL/LGPL applied software

The software that is eligible for the following GNU General Public License (hereinafter referred to as "GPL") or GNU Lesser General Public License (hereinafter referred to as "LGPL") are included in the camera.

This informs you that you have a right to have access to, modify, and redistribute source code for these software programs under the conditions of the supplied GPL/LGPL.

Source code is provided on the web. Use the following URL to download it.

<http://www.sony.net/Products/Linux/>

We would prefer you do not contact us about the contents of source code.

Licenses (in English) are recorded in the internal memory of your camera. Establish a Mass Storage connection between the camera and a computer to read licenses in the "PMHOME" - "LICENSE" folder.

### [Notes on use](#)

4-533-356-11(1)

Copyright 2014 Sony Corporation





## Trademarks

---

- The following marks are trademarks of Sony Corporation.  
**Cyber-shot**, Cyber-Shot, , Memory Stick, **MEMORY STICK PRO**, Memory Stick PRO, **MEMORY STICK DUO**, Memory Stick Duo, **MEMORY STICK PRO DUO**, Memory Stick PRO Duo, **MEMORY STICK PRO-HG DUO**, Memory Stick PRO-HG Duo, **MEMORY STICK XC-HG DUO**, Memory Stick XC-HG Duo, **MEMORY STICK MICRO**, Memory Stick Micro, **MAGIC GATE**, MagicGate, PlayMemories Online, PlayMemories Online logo, PlayMemories Home, PlayMemories Home logo.
- Microsoft, Windows, DirectX and Windows Vista are either registered trademarks or trademarks of Microsoft Corporation in the United States and/or other countries.
- Mac is a trademark or registered trademark of Apple Inc. in the United States and/or other countries.
- SDXC logo is a trademark of SD-3C, LLC.
- Eye-Fi is a trademark of Eye-Fi, Inc.
- In addition, system and product names used in this manual are, in general, trademarks or registered trademarks of their respective developers or manufacturers. However, the <sup>TM</sup> or ® marks may not be described in this manual.

### [Notes on use](#)

4-533-356-11(1)

Copyright 2014 Sony Corporation

Digital Still Camera  
DSC-W800

## If you have problems

If you experience trouble with the camera, try the following solutions.

1. Check items under "Troubleshooting", then check your camera.
2. Remove the battery pack, wait for about one minute, re-insert the battery pack, then turn on the power.
3. Initialize settings.
4. Consult your Sony dealer or local authorized Sony service facility.
  - Be aware that by sending the camera for repair, you give consent that contents of internal memory, music files may be checked.

Additional information on this product and answers to frequently asked questions can be found at our Customer Support Website.

<http://www.sony.net/>

### Related Topic

 [Initialize](#)

### [Notes on use](#)

4-533-356-11(1)

Copyright 2014 Sony Corporation



Digital Still Camera  
DSC-W800

## Cannot insert the battery pack into the camera

---

- Make sure the direction of the battery pack is correct, and insert it until the battery eject lever is locked.

[Notes on use](#)

4-533-356-11(1)

Copyright 2014 Sony Corporation



Digital Still Camera  
DSC-W800

## Cannot turn on the camera

---

- After inserting the battery pack into the camera, it may take a few moments for the camera to power up.
- Make sure that the battery pack is inserted correctly.
- The battery pack will discharge by itself even if you do not use it. Charge the battery pack before use.
- Check that the battery pack type is compatible.

### [Notes on use](#)

4-533-356-11(1)

Copyright 2014 Sony Corporation



## Power turns off suddenly

---

- Depending on the camera and battery temperature, the power may turn off automatically to protect the camera. In this case, a message is displayed on the screen before the power turns off.
- If you do not operate the camera for a certain period of time while the power is on and [Power Save] is set to [Standard] or [Max], the camera turns off automatically to prevent wearing down the battery pack. Turn on the camera again.

### [Notes on use](#)

4-533-356-11(1)

Copyright 2014 Sony Corporation



Digital Still Camera  
DSC-W800

## Remaining charge indicator is incorrect

---

- This is caused when you use the camera in an extremely hot or cold location.
- Battery capacity decreases over time and through repeated use. If decreased usage time between charges becomes significant, it is probably time to replace it with a new one.

### [Notes on use](#)

4-533-356-11(1)

Copyright 2014 Sony Corporation



Digital Still Camera  
DSC-W800

## Charge lamp of the camera flashes while charging the battery

---

- Check that the battery pack type is compatible.
- The Charge lamp of the camera flashes infrequently when you use a battery pack that has not been used for a long time. In such cases, remove the battery pack from the camera and re-insert it.
- For details, see "[Battery pack](#)".

### [Notes on use](#)

4-533-356-11(1)

Copyright 2014 Sony Corporation



Digital Still Camera  
DSC-W800

## Battery is not charged even if the Charge lamp turns off and charging is finished

---

- This happens when you charge the battery pack in an extremely hot or cold location. Charge the battery pack within the proper charging temperature range of between 10°C to 30°C (50°F to 86°F).

### [Notes on use](#)

4-533-356-11(1)

Copyright 2014 Sony Corporation





Digital Still Camera  
DSC-W800

## Cannot record images

---

- Check the free capacity of internal memory or memory card. If it is full, do one of the following:
  - Delete unnecessary images.
  - Change the memory card.
- You cannot record images while charging the flash.

### [Notes on use](#)

4-533-356-11(1)

Copyright 2014 Sony Corporation

Digital Still Camera  
DSC-W800

## Image is blurred

- Shoot images after pressing the shutter button halfway down to activate the Steadyshot function.
- The anti-blur function may not work properly when shooting night scenes. The use of a flash or tripod is recommended since the shutter speed becomes slow.

### Related Topic

 [Flash](#)

### [Notes on use](#)

4-533-356-11(1)

Copyright 2014 Sony Corporation



Digital Still Camera  
DSC-W800

## Image is out of focus

---

- The subject is too close. When shooting, make sure to position the lens farther away from the subject than the shortest shooting distance (approximately 5 cm (0.16 ft.) (W)/60 cm (1.96 ft.) (T) from the lens).

### [Notes on use](#)

4-533-356-11(1)

Copyright 2014 Sony Corporation



Digital Still Camera  
DSC-W800

## Zoom does not work

---

- You cannot use the optical zoom in Sweep Panorama mode.
- You cannot use the Smart zoom depending on the image size.
- You cannot use the digital zoom when:
  - [Self-Timer] is set to [Self-portrait One Person] or [Self-portrait Two People].

### [Notes on use](#)

4-533-356-11(1)

Copyright 2014 Sony Corporation



Digital Still Camera  
DSC-W800

## Cannot select the Face Detection function

---

- You can select Face Detection only when focus mode is set to [Multi AF] and metering mode is set to [Multi].

### [Notes on use](#)

4-533-356-11(1)

Copyright 2014 Sony Corporation

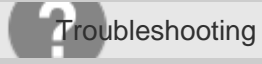

Digital Still Camera  
DSC-W800

## Flash does not work

---

- You cannot use the flash when:
  - [Cont. Shooting Settings] is set to [Continuous Shooting].
  - [Night Scene] mode or [High Sensitivity] mode is selected in Scene Selection.
  - Shooting in [Sweep Panorama]
  - Shooting in Movie Mode
- Set the flash to [On] when Scene Selection mode is set to [Landscape], [Gourmet], [Pet], [Beach] or [Snow] mode.

### [Notes on use](#)

4-533-356-11(1)

Copyright 2014 Sony Corporation



Digital Still Camera  
DSC-W800

## Fuzzy white circular spots appear in images shot using flash

---

- Particles (dust, pollen, etc.) in the air reflected the flash light and appeared in the image. This is not a malfunction.

### [Notes on use](#)

4-533-356-11(1)

Copyright 2014 Sony Corporation



Digital Still Camera  
DSC-W800

## Close-up shoot function (Macro) does not work

---

- The camera automatically adjusts focus. Press and hold the shutter button halfway down. Focus adjustment may take some time when shooting a close subject.
- [Landscape] or [Night Scene] mode is selected in Scene Selection.

### [Notes on use](#)

4-533-356-11(1)

Copyright 2014 Sony Corporation





Digital Still Camera  
DSC-W800

## Date and time are not displayed on the screen

---

- While shooting, date and time are not displayed. They are displayed only during playback.

[Notes on use](#)

4-533-356-11(1)

Copyright 2014 Sony Corporation



Digital Still Camera  
DSC-W800

F value and shutter speed flash when you press and hold the shutter button halfway down

---

- The exposure is incorrect. Correct the exposure.

[Notes on use](#)

4-533-356-11(1)

Copyright 2014 Sony Corporation



Digital Still Camera  
DSC-W800

## Image colors are not correct

---

- Adjust White Balance.

### [Notes on use](#)

4-533-356-11(1)

Copyright 2014 Sony Corporation



White or purple streaks appear in bright areas of the subject, or the whole screen of the image becomes reddish

---

- This phenomenon is called smearing. This is not a malfunction. Smearing is not recorded on still images, but is recorded as streaks or uneven colors on Sweep Panorama images or movies. ("Bright areas" refers to the sun or electric lights which are much brighter than surroundings.)

#### [Notes on use](#)

4-533-356-11(1)

Copyright 2014 Sony Corporation



Digital Still Camera  
DSC-W800

## Noise appears in the image when you view the screen in a dark place

---

- The camera is attempting to increase the visibility of the screen by temporarily brightening the image under conditions of low illumination. There is no effect on the recorded image.

### [Notes on use](#)

4-533-356-11(1)

Copyright 2014 Sony Corporation



Digital Still Camera  
DSC-W800

## Eyes of the subject come out red

---

- Shoot the subject at a distance closer than the flash range using flash.
- Light the room and shoot the subject.

### Related Topic

[Red Eye Reduction](#)

### [Notes on use](#)

4-533-356-11(1)

Copyright 2014 Sony Corporation



Digital Still Camera  
DSC-W800

## Dots appear and remain on the screen

---

- This is not a malfunction. These dots are not recorded.

[Notes on use](#)

4-533-356-11(1)

Copyright 2014 Sony Corporation



Digital Still Camera  
DSC-W800

## Cannot shoot images in succession

---

- Internal memory or memory card is full. Delete unnecessary images.
- The battery level is low. Insert a charged battery pack.

[Notes on use](#)

4-533-356-11(1)

Copyright 2014 Sony Corporation





Digital Still Camera  
DSC-W800

## Same image is shot several times

---

- Set [Cont. Shooting Settings] to [Single Shooting].

### [Notes on use](#)

4-533-356-11(1)

Copyright 2014 Sony Corporation

Digital Still Camera  
DSC-W800

## Cannot play back images

- Make sure that the memory card is fully inserted into the camera.
- The folder/file name has been changed on your computer.
- No guarantees are made for playing back, on this camera, files containing images which were processed on a computer or images which were shot using other cameras.
- The camera is in USB mode. Disconnect the USB connection.
- Use PlayMemories Home to play images stored on a computer with this camera.

### Related Topic

- [Disconnecting the camera from the computer](#)

### Notes on use

4-533-356-11(1)

Copyright 2014 Sony Corporation



Digital Still Camera  
DSC-W800

## Date and time are not displayed

---

- The screen display is set to display images only. Change the setting using MENU - [Display Setting] to display information.

[Notes on use](#)

4-533-356-11(1)

Copyright 2014 Sony Corporation



Digital Still Camera  
DSC-W800

## Cannot display images in index mode

---

- The camera is set to Easy Mode. Cancel Easy Mode.

[Notes on use](#)

4-533-356-11(1)

Copyright 2014 Sony Corporation

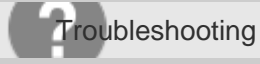

Digital Still Camera  
DSC-W800

## Your computer does not recognize the camera

---

- Set [USB Connect Setting] to [Mass Storage].
- Use the dedicated USB cable (supplied).
- Disconnect the dedicated USB cable from both the computer and the camera, and connect it again firmly.
- Disconnect all equipment other than the camera, keyboard and mouse from the USB connectors of your computer.
- Connect the camera directly to your computer without passing through a USB hub or other device.
- Set [USB Power Supply] to [Off]. Your computer may recognize the camera.

### Related Topic

[USB Connect Setting](#)

### Notes on use

4-533-356-11(1)

Copyright 2014 Sony Corporation



Digital Still Camera  
DSC-W800

## Cannot import images

---

- Connect the camera and your computer correctly making a USB connection.
- When you shoot images with a memory card formatted by a computer, you may not be able to import the images to a computer. Shoot using a memory card formatted by the camera.

### Related Topic

- [Connecting the camera to the computer](#)
- [Format](#)

### [Notes on use](#)

4-533-356-11(1)

Copyright 2014 Sony Corporation



Digital Still Camera  
DSC-W800

## Image and sound are interrupted by noise when you view a movie on a computer

---

- You are playing back the movie directly from the memory card. Import the movie to your computer using PlayMemories Home and play it back.

### [Notes on use](#)

4-533-356-11(1)

Copyright 2014 Sony Corporation



Digital Still Camera  
DSC-W800

## Images once exported to a computer cannot be viewed on the camera

---

- Use PlayMemories Home to copy images stored on a computer into this camera and view them on the camera.

[Notes on use](#)

4-533-356-11(1)

Copyright 2014 Sony Corporation





Digital Still Camera  
DSC-W800

## You have formatted a memory card by mistake

---

- All data on the memory card is deleted by formatting. You cannot restore it.

### [Notes on use](#)

4-533-356-11(1)

Copyright 2014 Sony Corporation



Digital Still Camera  
DSC-W800

Images are recorded on internal memory even when a memory card is inserted into the camera

---

- Make sure that the memory card is fully inserted into the camera.

[Notes on use](#)

4-533-356-11(1)

Copyright 2014 Sony Corporation



Digital Still Camera  
DSC-W800

## Cannot play back or record images using internal memory

---

- There is a memory card inserted in the camera. Remove it.

[Notes on use](#)

4-533-356-11(1)

Copyright 2014 Sony Corporation



Digital Still Camera  
DSC-W800

## Cannot copy stored data in internal memory to a memory card

---

- The memory card is full. Copy to a memory card with sufficient capacity.

### [Notes on use](#)

4-533-356-11(1)

Copyright 2014 Sony Corporation



Digital Still Camera  
DSC-W800

## Cannot copy memory card data or computer data to internal memory

---

- This feature is not available.

[Notes on use](#)

4-533-356-11(1)

Copyright 2014 Sony Corporation

## Images are printed with both edges cut off

---

- Depending on your printer, all edges of the image may be cut off. Especially when you print an image shot with the image size set to [16:9], the lateral end of the image may be cut off.
- When printing images using your printer, cancel the trimming or borderless settings. Consult the printer manufacturer as to whether the printer provides these functions or not.
- When having images printed at a digital print shop, ask the shop whether they can print images without cutting off both edges.



### [Notes on use](#)

4-533-356-11(1)

Copyright 2014 Sony Corporation

Digital Still Camera  
DSC-W800

## Cannot print images with date

- Select MENU -  (Settings) -  (Shooting Settings) - [Write Date] - [On] to insert a date on the image. Make sure that once the date is inserted, you cannot remove that date from the image.
- Using PlayMemories Home, you can insert the date on still images that have been recorded without a date.

### Related Topic

- [Write Date](#)
- [Print \(DPOF\)](#)

### Notes on use

4-533-356-11(1)

Copyright 2014 Sony Corporation



Digital Still Camera  
DSC-W800

## The lens gets fogged

---

- Moisture condensation has occurred. Turn off the camera and leave it for about an hour before using it.

[Notes on use](#)

4-533-356-11(1)

Copyright 2014 Sony Corporation





Digital Still Camera  
DSC-W800

## Camera turns off with the lens portion extended

---

- Do not attempt to force lens that has stopped moving.
- Insert a charged battery pack, then turn the camera on again.

[Notes on use](#)

4-533-356-11(1)

Copyright 2014 Sony Corporation



Digital Still Camera  
DSC-W800

## Camera becomes warm when you use it for a long time

---

- Leave the camera for a while with the power turned off.  
This is not a malfunction.

### [Notes on use](#)

4-533-356-11(1)

Copyright 2014 Sony Corporation

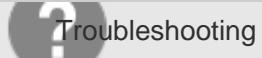

Digital Still Camera  
DSC-W800

## Clock Set screen appears when you turn on the camera

---

- Set the date and time again.
- The internal rechargeable backup battery has discharged. Insert a charged battery, and set aside for 24 hours or more with the power left off.

### Related Topic

[Date & Time Setting](#)

### Notes on use

4-533-356-11(1)

Copyright 2014 Sony Corporation



Digital Still Camera  
DSC-W800

## Date or time is incorrect

---

- The Area Setting is set to a different location than your current location. Change the setting by MENU - (Settings) - (Clock Settings) - [Area Setting].

### [Notes on use](#)

4-533-356-11(1)

Copyright 2014 Sony Corporation

Digital Still Camera  
DSC-W800

## Messages



- The battery level is low. Charge the battery pack immediately. Depending on the conditions of use or the type of battery pack, the indicator may flash even though there are still 5 minutes to 10 minutes of remaining battery time left.

System error. Turn on the device again.

- Turn the power off and then on again.

Internal memory error

- Turn the power off and then on again.

Reinsert the memory card that you were using.

- The inserted memory card cannot be used in the camera.
- The terminal section of the memory card is dirty.
- The memory card is damaged.

Incompatible type of memory card.

- The inserted memory card cannot be used in the camera.

Buffer overflow. Writing to the media was not completed in time.

- If you use a memory card that has been recorded and erased repeatedly, or that was formatted on a different camera, the data writing speed may be too slow. First back up any data on the card to a computer, and then reformat the card before using it.
- The writing speed of the memory card you are using is not sufficient for movie recordings. Use one of the memory cards listed below.
  - Memory Stick PRO Duo (Mark2) media, Memory Stick PRO-HG Duo media, Memory Stick media. Memory Stick XC-HG Duo media or Memory Stick Micro (Mark2) media.
  - SD memory card, SDHC memory card, SDXC memory card, microSD memory card or microSDHC memory card (Class 4 or faster).

Cannot recognize the internal memory. Format and use again.

Cannot recognize this memory card. Format and use again.

- Format the media again.

The memory card is locked. Check the tab.

- You are using the memory card with the write-protect switch, and the switch is set to the LOCK position. Set the

switch to the recording position.

This is a read- only memory card.

- The camera cannot record or delete images on this memory card.

No images

- No images that can be played back have been recorded in internal memory.
- No images that can be played back have been recorded in this folder of the memory card.

No still images

- The selected folder does not contain a file that can be played back in a slideshow.

File found which was not recognized

- You tried to delete a folder containing a file that cannot be played on this camera. Delete the file on a computer and then delete the folder.

Folder error. Cannot record to the selected folder. Please select a different folder.

- A folder with the same first three digit number already exists on the memory card (for example:123MSDCF and 123ABCDE). Select another folder, or create a new folder .

Cannot create more folders

- A folder with a name beginning with "999" exists on the memory card. You cannot create any folders if this is the case.

Folder protected

- You tried to delete a folder that is protected as read-only on a computer.

Cannot display file

- An error occurred while the image was playing back. No guarantees are made for playing back, on this camera, files containing images which were processed on a computer or images which were shot using other cameras.

Read only folder

- You have selected a folder that cannot be set as a recording folder on the camera. Select another folder.

File protected

- Release the protection.

Image size over limit

- You are playing back an image with size that cannot be played back on the camera.

Unable to detect face for retouch

- You may not be able to retouch the image depending on the image.

 (Vibration warning indicator)

- Camera shake may occur due to insufficient light. Use flash, turn on the anti-blur function, or mount the camera on a tripod to secure the camera.

1280x720 is not supported with this memory card.

- For recording movies, it is recommended that you use a memory card of 1 GB or larger.

Turn the power off and on again

- The lens malfunction.

Maximum number of images already selected.

- Up to 100 files can be selected when using [Multiple Images].
- You can add **DPOF** (Print order) marks to up to 999 files.

Operation cannot be executed in Easy Viewing mode.

- Processing and other editing functions of the camera cannot be performed on image files that have been processed using a computer or images that were recorded with other cameras.



- The number of images exceeds that for which date management in a database file by the camera is possible. To register additional images in the Image Database File, delete images in [Date View].



- It is not possible to record to the camera's Image Database File or play back using [Date View]. Use PlayMemories Home to back up all images to a computer and use it to restore the memory card.

Image Database File error Cannot recover

- Import all images to the computer using PlayMemories Home, and format the memory card.  
To view the images again with the camera, export the imported images to the camera with PlayMemories Home.

Recording function unavailable due to high internal temperature.

- The camera temperature has risen. You cannot record images until the temperature has gone down.

Recording has stopped due to increased camera temperature.

- Recording has stopped due to a rise in temperature while recording a movie. Please wait until the temperature goes down.



- When you record movies for a long time, the camera temperature rises. In this case, stop recording movies.

#### Related Topic

- [Memory card](#)
- [Format](#)

#### Notes on use

4-533-356-11(1)

Copyright 2014 Sony Corporation

Digital Still Camera  
DSC-W800

## Situations this camera has difficulty handling

---

The camera cannot take full advantage of some features under certain circumstances.

When shooting under the following conditions, either recompose the shot or change shooting mode, then shoot the images again.

Low light conditions

- [Shooting panoramic images](#)
- [TRACKING FOCUS](#)

Overly bright conditions

- [TRACKING FOCUS](#)

Varying levels of brightness

- [TRACKING FOCUS](#)

Flickering lights

- [Shooting panoramic images](#)

Subjects too close to the camera

- [Shooting panoramic images](#)

Large moving subjects or subjects that move too quickly

- [TRACKING FOCUS](#)
- [Shooting panoramic images](#)

Subjects too small or too large

- [TRACKING FOCUS](#)
- [Shooting panoramic images](#)

Scenes with little contrast, such as the sky or a sandy beach

- [Shooting panoramic images](#)

Scenes changing constantly, such as waterfalls

- [Shooting panoramic images](#)