



AVCHD™

HDMI



<http://www.sony.net/>



Printed on 70% or more recycled paper using VOC (Volatile Organic Compound)-free vegetable oil based ink.

3-287-660-12(1)



1-3287660123

Operating Instructions

Blu-ray Disc / DVD Player

BDP-S350

WARNING

To reduce the risk of fire or electric shock, do not expose this apparatus to rain or moisture.

To avoid electrical shock, do not open the cabinet. Refer servicing to qualified personnel only.

Batteries or batteries installed apparatus shall not be exposed to excessive heat such as sunshine, fire or the like.

CAUTION

The use of optical instruments with this product will increase eye hazard. As the laser beam used in this Blu-ray Disc/DVD player is harmful to eyes, do not attempt to disassemble the cabinet. Refer servicing to qualified personnel only.



This label is located on the laser protective housing inside the enclosure.



This symbol is intended to alert the user to the presence of uninsulated "dangerous voltage"

within the product's enclosure that may be of sufficient magnitude to constitute a risk of electric shock to persons.



This symbol is intended to alert the user to the presence of important operating and maintenance (servicing) instructions in the literature accompanying the appliance.

CAUTION

You are cautioned that any changes or modifications not expressly approved in this manual could void your authority to operate this equipment.

The shielded Interface cable (Network cable) must be used with the equipment in order to comply with the limits for a digital device pursuant to Subpart B of Part 15 of FCC Rules.



This equipment has been tested and found to comply with the limits for a Class B digital device, pursuant to Part 15 of the FCC Rules. These limits are designed to provide reasonable protection against harmful interference in a residential installation. This equipment generates, uses, and can radiate radio frequency energy and, if not installed and used in accordance with the instructions, may cause harmful interference to radio communications. However, there is no guarantee that interference will not occur in a particular installation. If this equipment does cause harmful interference to radio or television reception, which can be determined by turning the equipment off and on, the user is encouraged to try to correct the interference by one or more of the following measures:

- Reorient or relocate the receiving antenna.
- Increase the separation between the equipment and receiver.
- Connect the equipment into an outlet on a circuit different from that to which the receiver is connected.
- Consult the dealer or an experienced radio/TV technician for help.

Precautions

- To prevent fire or shock hazard, do not place objects filled with liquids, such as vases, on the apparatus.
- Install this unit so that the AC power cord can be unplugged from the wall socket immediately in the event of trouble.

Owner's Record

The model and serial numbers are located at the rear of the unit. Record the serial number in the space provided below. Refer to them whenever you call upon your Sony dealer regarding this product.

Model No. BDP-S350

Serial No. _____

For customers in the U.S.A

If this product is not working properly, please call 1-800-222-7669.

For Customers in Canada

If this product is not working properly, please call 1-877-602-2008 for **Peace of Mind Warranty Replacement service**.

For other product related questions please contact our **Customer Information Service Center** at 1-877-899-7669 or write to us at: Customer Information Service 115 Gordon Baker Road, Toronto, Ontario, M2H 3R6

Notes About the Discs

- To keep the disc clean, handle the disc by its edge. Do not touch the surface. Dust, fingerprints, or scratches on the disc may cause it to malfunction.

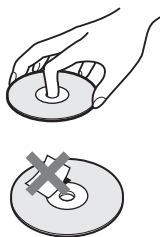

- Do not expose the disc to direct sunlight or heat sources such as hot air ducts, or leave it in a car parked in direct sunlight as the temperature may rise considerably inside the car.
- After playing, store the disc in its case.
- Clean the disc with a cleaning cloth. Wipe the disc from the center out.



- Do not use solvents such as benzene, thinner, commercially available disc/lens cleaners, or anti-static spray intended for vinyl LPs.
- If you have printed the disc's label, dry the label before playing.
- Do not use the following discs.
 - A disc that has a non-standard shape (e.g., card, heart).
 - A disc with a label or sticker on it.
 - A disc that has cellophane tape or sticker adhesive on it.
- Do not resurface the playing side of a disc to remove surface scratches.

Precautions

On safety

- To prevent fire or shock hazard, do not place objects filled with liquids, such as vases, on the player, or place the player near water, such as near a bathtub or shower room. Should any solid object or liquid fall into the cabinet, unplug the player and have it checked by qualified personnel before operating it any further.
- Do not touch the AC power cord with wet hands. Doing so may cause an electric shock.

On placement

- Place the player in a location with adequate ventilation to prevent heat build-up in the player.
- Do not place the player on a soft surface such as a rug that might block the ventilation holes.
- Do not install this player in a confined space, such as a bookshelf or similar unit.
- Do not place the player in a location near heat sources, or in a place subject to direct sunlight, excessive dust, or mechanical shock.
- If the player is brought directly from a cold to a warm location, or is placed in a very damp room, moisture may condense on the lenses inside the player. Should this occur, the player may not operate properly. In this case, remove the disc and leave the player turned on for about half an hour until the moisture evaporates.
- Do not install the player in an inclined position. It is designed to be operated in a horizontal position only.
- Keep the player and the discs away from equipment with strong magnets, such as microwave ovens, or large loudspeakers.

- Do not place heavy or unstable objects on the player.
- Do not place any objects other than discs on the disc tray. Doing so may cause damage to the player or the object.
- When you move the player, take out any discs. If you don't, the disc may be damaged.
- When you move the player, disconnect the AC power cord and all other cables from the player.

On power sources

- The player is not disconnected from the AC power source as long as it is connected to the wall outlet, even if the player itself has been turned off.
- If you are not going to use the player for a long time, be sure to disconnect the player from the wall outlet. To disconnect the AC power cord, grasp the plug itself; never pull the cord.
- Observe following points to prevent the AC power cord being damaged. If the AC power cord is damaged, it may result in a fire or an electric shock.
 - Do not pinch the AC power cord between the player and wall, shelf, etc.
 - Do not put anything heavy on the AC power cord or pull on the AC power cord itself.

On adjusting volume

Do not turn up the volume while listening to a section with very low level inputs or no audio signals. If you do, the speakers may be damaged when a peak level section is played.

On cleaning

Clean the cabinet, panel, and controls with a soft cloth slightly moistened with a mild detergent solution. Do not use any type of abrasive pad, scouring powder or solvent such as alcohol or benzene.

On cleaning discs, disc/lens cleaners

Do not use cleaning discs or disc/lens cleaners (including wet or spray types). These may cause the apparatus to malfunction.

On replacement of parts

In the events that this player is repaired, repaired parts may be collected for reuse or recycling purposes.

Copyrights and Trademarks

- This product incorporates copyright protection technology that is protected by U.S. patents and other intellectual property rights. Use of this copyright protection technology must be authorized by Macrovision, and is intended for home and other limited viewing uses only unless otherwise authorized by Macrovision. Reverse engineering or disassembly is prohibited.
- “AVCHD” and the “AVCHD” logo are trademarks of Matsushita Electric Industrial Co., Ltd. and Sony Corporation.
- Java and all Java-based trademarks and logos are trademarks or registered trademarks of Sun Microsystems, Inc.
- “XMB,” “XMB,” and “xross media bar” are trademarks of Sony Corporation and Sony Computer Entertainment Inc.
- This Blu-ray Disc/DVD player incorporates High-Definition Multimedia Interface (HDMI™) technology. HDMI, the HDMI logo and High-Definition Multimedia Interface are trademarks or registered trademarks of HDMI Licensing LLC.
- “Blu-ray Disc” is a trademark.
- “Blu-ray Disc,” “DVD+RW,” “DVD-RW,” “DVD+R,” “DVD-R,” “DVD VIDEO,” and “CD” logos are trademarks.

- “x.v.Color” and “x.v.Color” logo are trademarks of Sony Corporation.
- “BRAVIA Sync” is a trademark of Sony Corporation.
- “PhotoTV HD” and the “PhotoTV HD” logo are trademarks of Sony Corporation.
- Other system and product names are generally trademarks or registered trademarks of the manufacturers. ™ and ® marks are not indicated in this document.

IMPORTANT NOTICE

Caution: This player is capable of holding a still video image or on-screen display image on your television screen indefinitely. If you leave the still video image or on-screen display image displayed on your TV for an extended period of time you risk permanent damage to your television screen. Plasma display panel televisions and projection televisions are susceptible to this.

If you have any questions or problems concerning your player, please consult your nearest Sony dealer.

Important Safety Instructions

- 1) Read these instructions.
- 2) Keep these instructions.
- 3) Heed all warnings.
- 4) Follow all instructions.
- 5) Do not use this apparatus near water.
- 6) Clean only with dry cloth.
- 7) Do not block any ventilation openings. Install in accordance with the manufacturer’s instructions.
- 8) Do not install near any heat sources such as radiators, heat registers, stoves, or other apparatus (including amplifiers) that produce heat.
- 9) Do not defeat the safety purpose of the polarized or grounding-type plug. A polarized plug has two blades with one wider than the other. A grounding type plug has two blades and a third grounding prong. The wide blade or the third prong are provided for your safety. If the provided plug does not fit into your outlet, consult an electrician for replacement of the obsolete outlet.
- 10) Protect the power cord from being walked on or pinched particularly at plugs, convenience receptacles, and the point where they exit from the apparatus.
- 11) Only use attachments/accessories specified by the manufacturer.
- 12) Use only with the cart, stand, tripod, bracket, or table specified by the manufacturer, or sold with the apparatus. When a cart is used, use caution when moving the cart/apparatus combination to avoid injury from tip-over.
- 13) Unplug this apparatus during lightning storms or when unused for long periods of time.



- 14) Refer all servicing to qualified service personnel. Servicing is required when the apparatus has been damaged in any way, such as power-supply cord or plug is damaged, liquid has been spilled or objects have fallen into the apparatus, the apparatus has been exposed to rain or moisture, does not operate normally, or has been dropped.

About this manual



- In this manual, “disc” is used as a general reference for the BDs, DVDs, or CDs unless otherwise specified by the text or illustrations.
- Icons, such as , listed at the top of each explanation indicate what kind of media can be used with the function being explained.
For details, see “Playable Discs” (page 58).
- Instructions in this manual describe the controls on the remote. You can also use the controls on the player if they have the similar symbols as those on the remote.
- The on-screen display illustrations used in this manual may not match the graphics displayed on your TV screen.
- NEED-to-know information (to prevent incorrect operation) is listed under the  icon. NICE-to-know information (tips and other useful information) is listed under the  icon.

Table of Contents

WARNING	2
Precautions	3
Guide to Parts and Controls	8

Hookups and Settings

Hooking Up the Player	13
Step 1: Connecting to Your TV	14
Connecting to an HDMI jack	15
About the BRAVIA Sync features (for HDMI connections only)	16
Connecting to component video jacks (Y, Pb, Pr)	17
Connecting to an audio/video or S VIDEO jack	18
Step 2: Connecting to Your AV Amplifier (Receiver)	19
Connecting to an HDMI jack	20
Connecting to digital jacks (OPTICAL/COAXIAL)	21
Connecting to audio L/R jacks	22
Step 3: Inserting the External Memory	23
Step 4: Connecting to the Network	24
When connecting to a broadband router directly	24
When connecting via a wireless LAN router	25
Step 5: Connecting the AC Power Cord	25
Step 6: Preparing the Remote	26
Controlling TVs with the remote	26
Step 7: Easy Setup	27

Playback

Playing BDs/DVDs	30
Using the BD's or DVD's menu	32
Enjoying BonusView	32
Searching for a scene quickly (Scene Search)	33
Searching for a Title/Chapter	33
Displaying the playing time and play information	34
Adjusting pictures and sound for videos	34
Playing CDs	36
Playing Photo Files	37

Settings and Adjustments

Using the Settings Displays	39
Network Update	40
Video Settings	41
Audio Settings	44
BD/DVD Viewing Settings	46
Photo Settings	48
System Settings	49
Network Settings	50
Easy Setup	52
Resetting	52

Additional Information

Troubleshooting	53
Self-Diagnosis Function	57
Playable Discs	58
Video Output Resolution	61
Audio Output Signals	62
Specifications	63
Language Code List	64
Parental Control/Area Code	64
Terms and Conditions of Use and End User License Agreement	65
Software License Information	67
Glossary	76
Index	78

Before operating the player, please read “Terms and Conditions of Use and End User License Agreement” (page 65).

Guide to Parts and Controls

For more information, see the pages in parentheses.

Remote

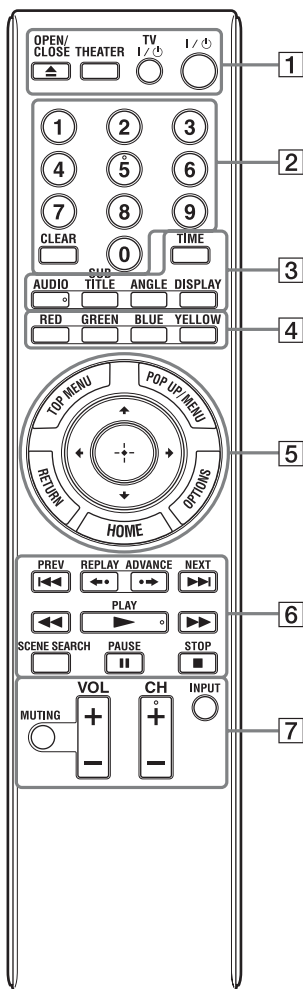

Number 5, AUDIO, CH +, and ► PLAY buttons have a tactile dot. Use the tactile dot as a reference when operating the player.

1 **▲ OPEN/CLOSE (page 30)**

Opens or closes the disc tray.

THEATER (page 16)

Switches to the optimum video mode for watching movies automatically. When connected with an AV amplifier (receiver) using the HDMI cable, the speaker output also switches automatically. Press the button again to return to the original setting.

When connected with a Theater Mode-compatible TV using the HDMI cable, the TV's video mode switches to Theater Mode.



The THEATER button functions only when connected to a Theater Mode-compatible TV.

TV I/O (on/standby) (page 26)

Turns on the TV, or sets to standby mode.

I/O (on/standby) (page 27)

Turns on the player, or sets to standby mode.

2 **Number buttons (page 33, 51)**

Enters the title/chapter numbers, etc.

CLEAR

Clears the entry field.

3 **TIME (page 11)**

Displays the elapsed/remaining playback time in the front panel display. Each time you press the button, the display switches between elapsed playback time and remaining playback time.

AUDIO (page 46)

Selects the language track when multi-lingual tracks are recorded on BD-ROMs/DVD VIDEOS.

Selects the sound track on CDs.

SUBTITLE (page 46)

Selects the subtitle language when multi-lingual subtitles are recorded on BD-ROMs/DVD VIDEOS.

ANGLE

Switches to other viewing angles when multi-angles are recorded on BD-ROMs/DVD VIDEOS.

DISPLAY (page 34)

Displays the playback information on the screen.

4 Color buttons (RED/GREEN/BLUE/YELLOW)

Short cut keys for selecting items on some BD's menus (can also be used for BD's Java interactive operations).

5 TOP MENU (page 32)

Opens or closes the BD's or DVD's Top Menu.

POP UP/MENU (page 32)

Opens or closes the BD-ROM's Pop-up Menu, or the DVD's menu.

OPTIONS (page 32, 37)

The options menu that can be selected appears on the screen.

HOME (page 39)

Enters or exits the player's home menu.

RETURN

Returns to the previous display.



Moves the highlight to select a displayed item.

Center button (ENTER)

Enters the selected item.

6 ◀◀ PREV/NEXT ▶▶ (previous/next)

Skips to the previous/next chapter, track, or file.

To go to the beginning of the previous track, press ◀◀ PREV twice.

◀◀ REPLAY/ADVANCE ▶▶ (instant replay/instant advance)

Replays the scene/briefly fast forwards the scene.



(fast reverse/fast forward)

Fast reverses/fast forwards the disc when pressed during playback.

Each time you press the button, search speed changes as follows*:

Playback direction

▶▶ 1 (x10) → ▶▶ 2 (x30) → ▶▶ 3 (x120)

Reverse direction

◀◀ 1 (x1) → ◀◀ 1 (x10) → ◀◀ 2 (x30) → ◀◀ 3 (x120)

When you press and hold the button, fast forward/fast reverse continues at the selected speed until you release the button.

* Search speed does not change when playing CDs.

Speed multiple values are approximate.

– To resume normal playback, press ▶ PLAY.

▶ PLAY (page 30)

Starts or re-starts playback.

Resumes playback from the point where you press ■ STOP (Resume Play).

Plays a slideshow when a disc containing JPEG image files is inserted.

SCENE SEARCH (page 33)

Switches to Scene Search mode that lets you move quickly between scenes within the title currently being played back.

|| PAUSE

Pauses or re-starts playback.

■ STOP

Stops playback and remembers the stop point (resume point) (page 31, 36).

The resume point for a title/track is the last point you played or the last photo for a photo folder.

7 For TVs operable with the following buttons, see page 26.

MUTING

Mutes the TV sound.

VOL (volume) +/-

Adjusts the TV volume.

CH (channel) +/-

Selects the TV channels up and down.

INPUT (input select)

Switches between TV and other input sources.

Front panel

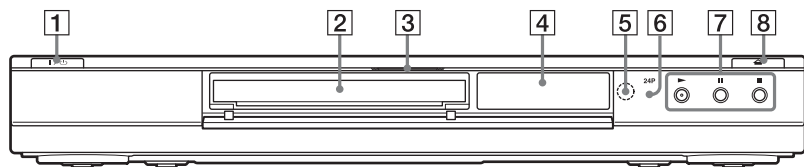

1 I/O (on/standby) (page 27)

Turns on the player, or sets to standby mode.

2 Disc tray (page 30)

3 Blu-ray Disc indicator

Lights up when a BD is recognized.



When the player is turned on for the first time, the Blu-ray Disc indicator lights up, then turns off when Easy Setup is complete.

4 Front panel display (page 11)

5 Remote sensor (page 26)

6 24P indicator (page 43)

Lights up when outputting 1080p/24 Hz video signals of BD-ROMs.

7 ► (play), II (pause), ■ (stop) (page 30)

Starts, pauses, or stops playback.

8 ≡ (open/close) (page 30)

Opens or closes the disc tray.

To lock the disc tray (Child Lock)

You can lock the disc tray to prevent it being opened by mistake.

When the player is turned on, hold down **II** on the player for more than 10 seconds until “LOCKED” appears in the front panel display. The disc tray is locked.

To unlock the disc tray, hold down **II** on the player until “UNLOCK” appears in the front panel display.

Front panel display

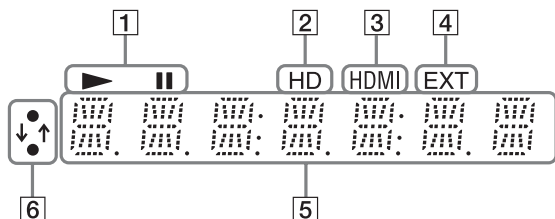

1 ▶, ||

Lights up during playback or pause.

2 HD (page 42)

Lights up when outputting 720p/1080i/1080p video signals from the HDMI OUT jack or 720p/1080i video signals from the COMPONENT VIDEO OUT jacks.

3 HDMI (page 16)

Lights up when an HDMI device is connected.

4 EXT (page 23)

Lights up when the external memory is recognized.

5 Playback information

You can check the time information. Press TIME repeatedly during playback. The display changes as follows.

When playing a BD-ROM/DVD VIDEO

Elapsed time of the current title



Remaining time of the current title

When playing a CD

Elapsed time of the current track



Remaining time of the current track



Elapsed time of the current disc



Remaining time of the current disc



“T” (Title or Track), “C” (Chapter), or “D” (Disc) may be displayed depending on the disc.

6 Network connection indicator

Lights up when downloading the player’s software.

For details on downloading the player’s software, see page 40.

Rear panel

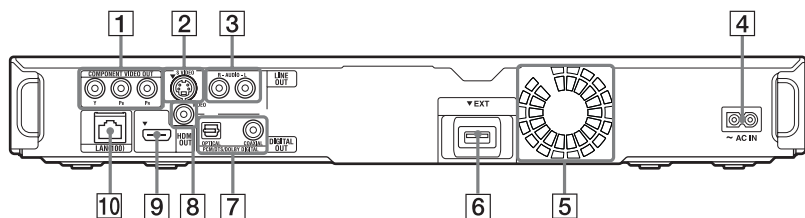

1 COMPONENT VIDEO OUT (Y, P_B, P_R) jacks (page 17)

2 LINE OUT (S VIDEO) jack (page 18)

3 LINE OUT (R-AUDIO-L) jacks (page 18, 22)

4 AC IN terminal (page 25)

5 Ventilation holes

The ventilation fan is inside the player.

6 EXT slot (page 23)

7 DIGITAL OUT (OPTICAL/ COAXIAL) jacks (page 21)

8 LINE OUT (VIDEO) jack (page 18)

9 HDMI OUT jack (page 15, 20)

10 LAN (100) terminal (page 24)

Hookups and Settings

Hooking Up the Player

Check that you have the following items.

- Audio/video cable (phono plug x3) (1)
- AC power cord (1)
- Remote commander (remote) (1)
- Size AA (R6) batteries (2)

Follow steps 1 through 7 to hook up and adjust the settings of the player. Do not connect the AC power cord until you reach “Step 5: Connecting the AC Power Cord” (page 25).

Step 1: Connecting to Your TV

About video/HDMI OUT jacks

The player has the following video jacks. Connect the player to your TV according to the input jack on your TV.

When connecting the player to your TV using the HDMI cable, you can enjoy high quality digital pictures and sound through the HDMI OUT jack.

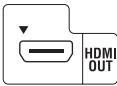
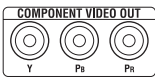
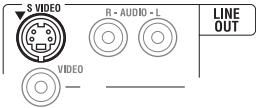
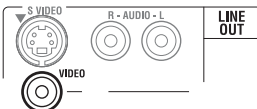
Jack type	Video resolution	Hookup
High quality Digital 	High Definition: 1080/24p, 1080p, 1080i, 720p Standard Definition: 480p, 480i	See "Connecting to an HDMI jack" (page 15).
Analog 	High Definition: 1080i, 720p Standard Definition: 480p, 480i	See "Connecting to component video jacks (Y, Pb, Pr)" (page 17).
	Standard Definition: 480i	See "Connecting to an audio/video or S VIDEO jack" (page 18).
	Standard Definition: 480i	See "Connecting to an audio/video or S VIDEO jack" (page 18).
Standard quality		

- ⚡ Plug in cables securely to prevent unwanted noise.
- Refer to the instructions supplied with the components to be connected.
- You cannot connect this player to a TV that does not have a video input jack.
- Do not apply too much pressure on the connecting cables. Pushing against the cabinet wall, etc., may damage the cable.

To connect to a TV with DVI input

Use an HDMI-DVI converter cable (not supplied). The DVI jack will not accept any audio signals, so you have to use another audio connection in addition to this connection (page 19).

Furthermore, you cannot connect the HDMI OUT jack to DVI jacks that are not HDCP compliant (e.g., DVI jacks on PC displays).

Connecting to an HDMI jack

Connect the player and your TV using an HDMI cable to enjoy high quality digital pictures and sound through the HDMI OUT jack.

If you connect a Sony TV that is compatible with the “Control for HDMI” function (page 16), refer to the operating instructions supplied with the TV.

If you connect a 1080/24p- or 1080p-compatible TV, use a High Speed HDMI cable.

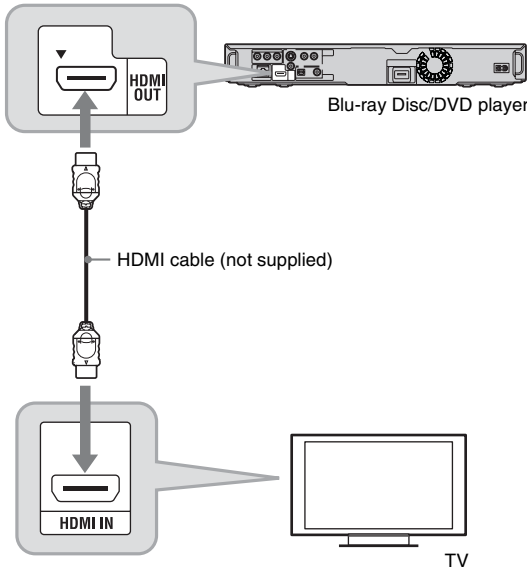

Notes on connecting to the HDMI OUT jack

Observe the following as improper handling may damage the HDMI OUT jack and the connector.

- Carefully align the HDMI OUT jack on the rear of the player and the HDMI connector by checking their shapes. Make sure the connector is not upside down or tilted.

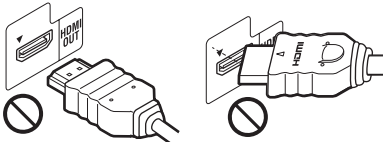

- Be sure to disconnect the HDMI cable when moving the player.



- If you place the player on a cabinet with the HDMI cable connected, do not apply too much pressure to the cabinet wall. It may damage the HDMI OUT jack or the HDMI cable.
- When connecting or disconnecting, do not screw in or rotate the HDMI connector.

About indicators for HDMI connection

When connecting an HDMI compatible component, the HDMI indicator lights up in the front panel display.



- Consumers should note that not all high definition television sets are fully compatible with this product and may cause artifacts to be displayed in the picture. In the case of 480p/720p/1080i/1080p scan picture problems, it is recommended that the user switch the connection to the 'standard definition' output. If there are questions regarding our TV set compatibility with this model 480p/720p/1080i/1080p Blu-ray Disc/DVD player, please contact our customer service center.
- If the picture is not clear, not natural or not to your satisfaction, change the video output resolution in step 3 of "Output Video Format" under the "Video Settings" setup (page 42).
- Be sure to use only an HDMI cable that bears the HDMI logo.

About the BRAVIA Sync features (for HDMI connections only)

By connecting Sony components that are compatible with the "Control for HDMI" function with an HDMI cable (not supplied), operation is simplified as below:

- One-Touch Play
With one touch of the following buttons, the connected TV turns on and the input selector on the TV is switched to the player automatically.
 - HOME: The home menu appears automatically (page 39).
 - PLAY: Playback starts automatically (page 31).
- System Power-Off
When you turn off the TV using the power button on the TV's remote, the player and HDMI-compatible components turn off automatically.

- Theater

When you press THEATER, the player automatically switches to the optimum video mode for watching movies. When connected with an AV amplifier (receiver) using the HDMI cable, the speaker output also switches automatically. When connected with a Theater Mode-compatible TV using the HDMI cable, the TV's video mode switches to Theater Mode. Press the button again to return to the original setting.

- Language Follow

When you change the language for the on-screen display on your TV, the player's language for the on-screen display is also changed after turning the player off and on.

To prepare for the BRAVIA Sync features

Set "Control for HDMI" to "On" in the "System Settings" setup (page 49).

For details on settings of your TV or other connected components, refer to the operating instructions supplied with the TV or components.



- When connecting the Sony TV that is compatible with the "Control for HDMI" Easy Setting function using the HDMI cable, the "Control for HDMI" setting of the player automatically switches to "On" if the "Control for HDMI" setting on the connected TV is set to "On." Refer to the operating instructions supplied with the TV.
- When connecting the Sony TV that is compatible with the BRAVIA Sync features using the HDMI cable, you can control the basic functions of the player with the TV's remote if the "Control for HDMI" setting on the connected TV is set to "On." Refer to the operating instructions supplied with the TV.



Depending on the connected component, the "Control for HDMI" function may not work. Refer to the operating instructions supplied with the component.

Connecting to component video jacks (Y, P_B, P_R)

Connect the COMPONENT VIDEO OUT jacks of the player and your TV using a component video cable or three video cables (not supplied) of the same kind and length. You can enjoy high-quality pictures.

Be sure to connect to the LINE OUT (R-AUDIO-L) jacks using the audio/video cable.

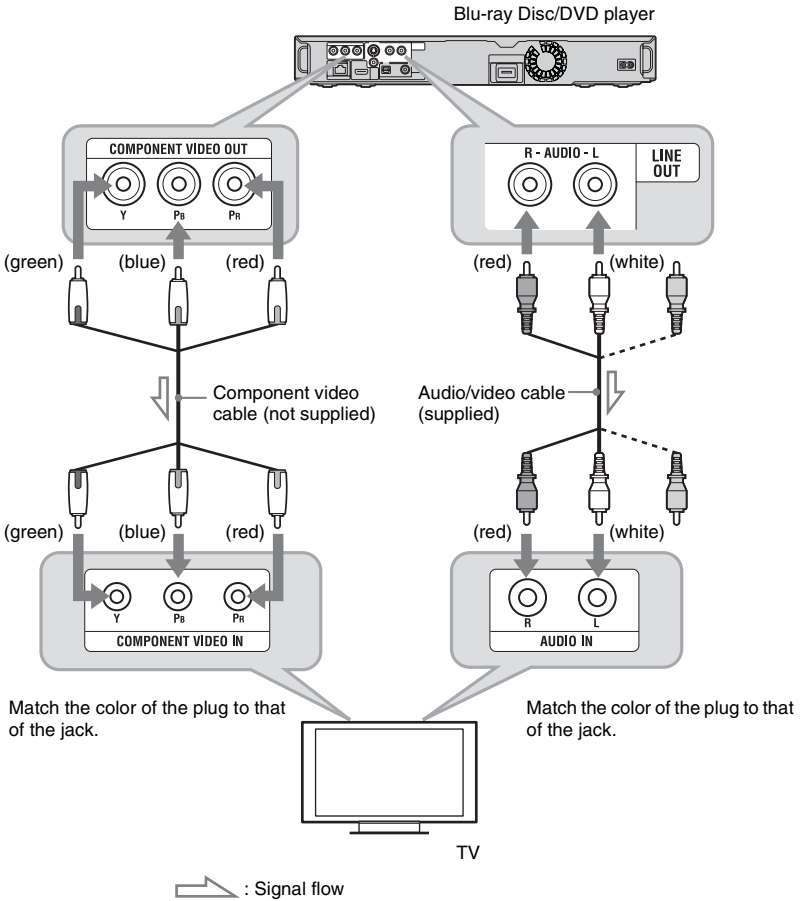

⚡ When you connect the player and TV using a component video cable, disconnect the video plug (yellow) of the audio/video cable.

Connecting to an audio/video or S VIDEO jack

Connect the LINE OUT (VIDEO, R-AUDIO-L) jacks of the player and your TV using the audio/video cable. You can enjoy standard quality pictures and sound.

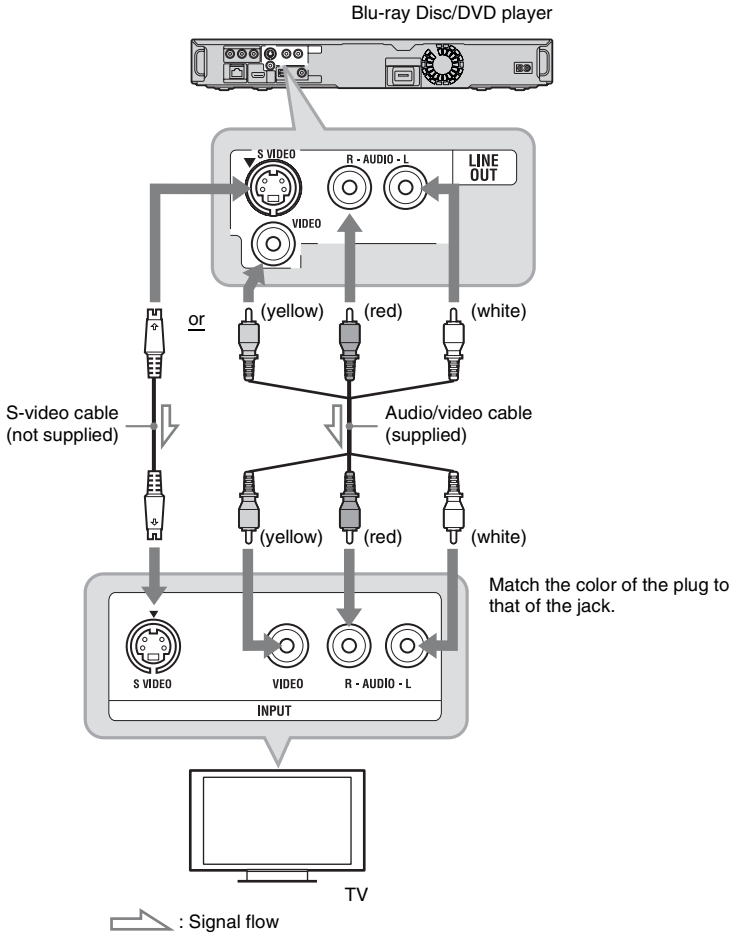



When you connect the player and TV using an S-video cable, disconnect the video plug (yellow) of the audio/video cable.

Step 2: Connecting to Your AV Amplifier (Receiver)

About audio/HDMI OUT jacks

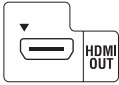
The player has the following audio jacks. Connect the player to your AV amplifier (receiver) according to the input jack on your AV amplifier (receiver).

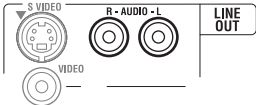
Jack type		Hookup
Digital		See “Connecting to an HDMI jack” (page 20).
		See “Connecting to digital jacks (OPTICAL/COAXIAL)” (page 21).
Analog		See “Connecting to audio L/R jacks” (page 22).



For correct speaker location, refer to the operating instructions supplied with the connected components.



- When you connect the player to your AV amplifier (receiver) using an HDMI cable, do one of the following:
 - Connect your AV amplifier (receiver) to your TV using an HDMI cable, or
 - Connect the player to your TV using a video cable other than an HDMI cable (component video cable, S-video cable, or audio/video cable).
- If you connect a component that does not conform to the selected audio signal, a loud noise (or no sound) will come from the speakers, which could damage your ears or the speakers.

Connecting to an HDMI jack

If your AV amplifier (receiver) has an HDMI input, you can enjoy surround sound. If you connect a Sony AV amplifier (receiver) that is compatible with the “Control for HDMI” function (page 16), refer to the operating instructions supplied with the AV amplifier (receiver).

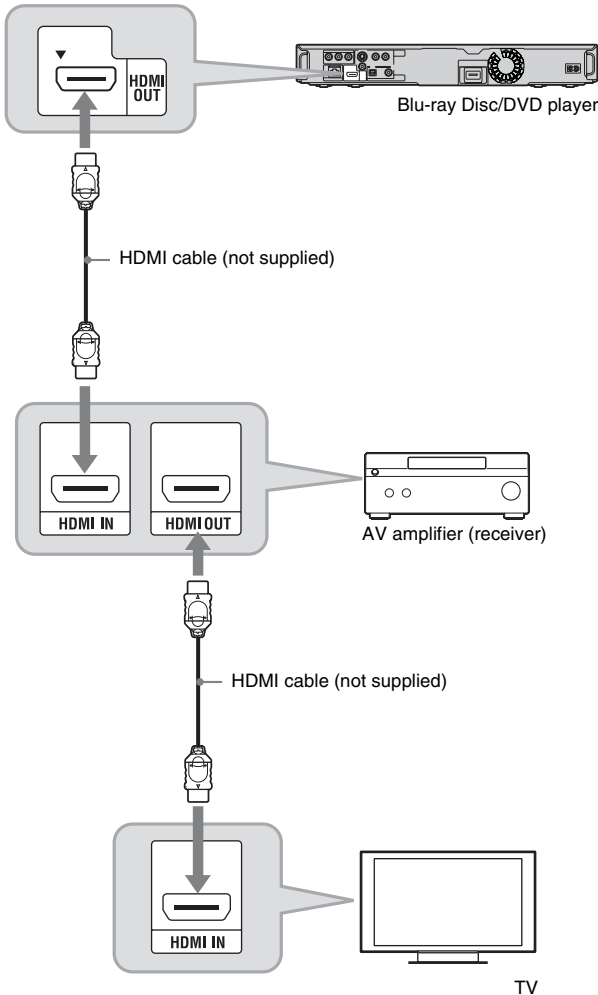

Set the following settings and you can enjoy higher quality sound from the connected AV amplifier (receiver).

- Set “Audio Output Priority” to “HDMI” in the “Audio Settings” setup (page 44).
- Set “Audio (HDMI)” to “Auto” in the “Audio Settings” setup (page 44).
- Set “BD Audio Setting” to “Direct” in the “Audio Settings” setup (page 44).



Not all HDMI-compatible AV amplifiers (receivers) accept 8ch Linear PCM signals. Refer as well to instructions supplied with the connected AV amplifier (receiver).

Connecting to digital jacks (OPTICAL/COAXIAL)

If your AV amplifier (receiver) has a Dolby^{*1} Digital, Dolby Pro Logic, or DTS^{*2} decoder and a digital input jack, you can enjoy Dolby Digital (5.1ch), Dolby Pro Logic (4.0ch), or DTS (5.1ch) surround effects.

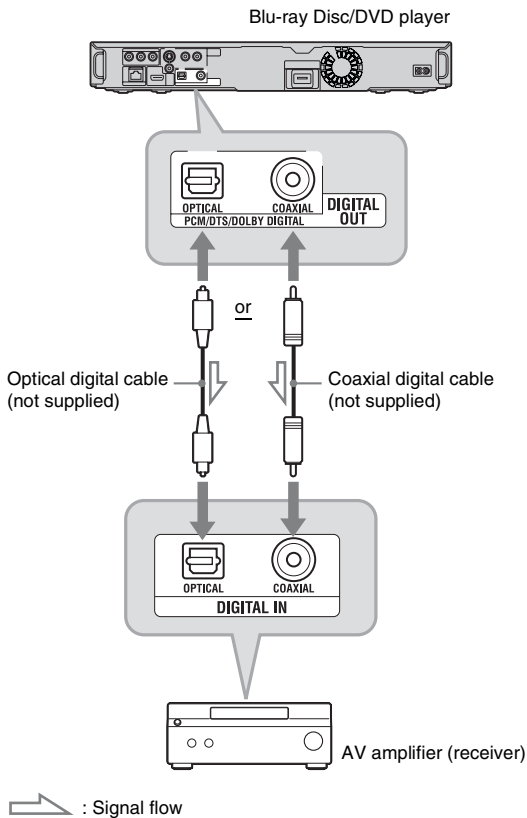

1 Connect the digital jack of the player and your AV amplifier (receiver).

2 Set “Audio Output Priority” to “Coaxial/Optical” in the “Audio Settings” setup (page 44).

3 Make the appropriate settings in “Dolby Digital” and “DTS” under the “Audio Settings” setup (page 45).

Otherwise, no sound or a loud noise will come from your speakers.

^{*1} Manufactured under license from Dolby Laboratories. Dolby, Pro Logic, and the double-D symbol are trademarks of Dolby Laboratories.

^{*2} Manufactured under license under U.S. Patent #s: 5,451,942; 5,956,674; 5,974,380; 5,978,762; 6,487,535 & other U.S. and worldwide patents issued & pending. DTS is a registered trademark and the DTS logos, Symbol, DTS-HD and DTS-HD Advanced Digital Out are trademarks of DTS, Inc. © 1996-2007 DTS, Inc. All Rights Reserved.

Connecting to audio L/R jacks

If your AV amplifier (receiver) only has L and R audio input jacks, use this connection.

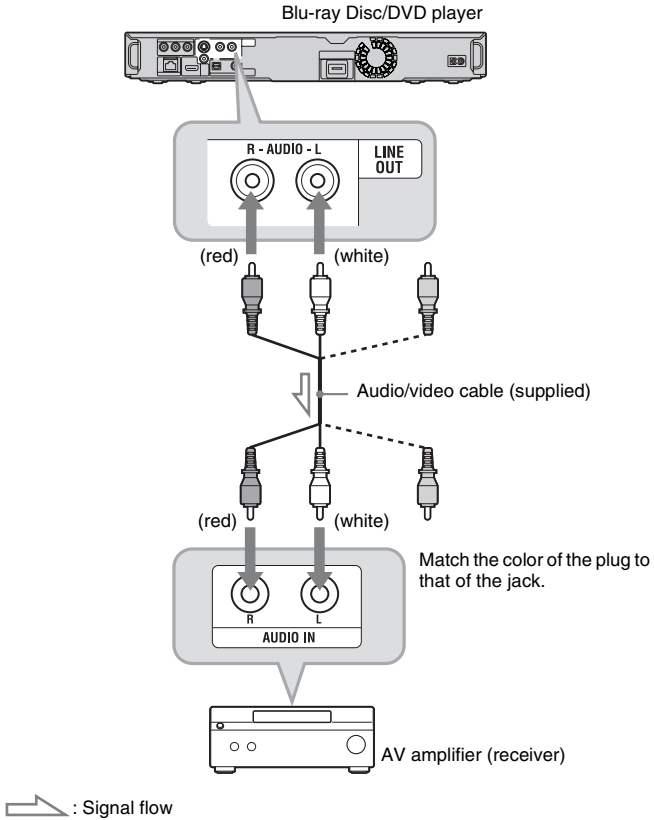

Step 3: Inserting the External Memory

To enjoy additional content (such as BonusView) on certain Blu-ray Disc titles, you will need to use external memory. Insert the external memory device (1 GB or larger USB flash memory, such as Sony USM1GH) into the EXT slot as your local storage.

Insert the external memory in the ▼ direction into the EXT slot as far as it will go.

Check that the EXT indicator lights up in the front panel display when turning the player on.

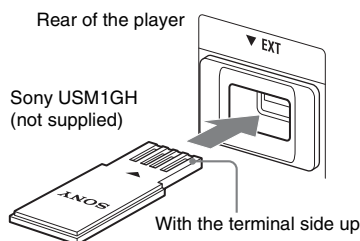

- Do not connect anything other than a USB flash memory, such as an HDD, etc., to the EXT slot.
- Insert the external memory straight. If you force the external memory into the slot, this will cause damage to both the external memory and the player.
- Keep the external memory away from small children to prevent them from accidentally swallowing the external memory.
- Do not apply too much pressure to the external memory in the slot, as it may cause a malfunction.
- We recommend use of the Sony USM1GH available as of April 2008.
- Other USB flash devices may support this function. However we cannot guarantee compatibility with all USB flash memories.
- When inserting a USB flash memory other than Sony USM1GH, check the insertion direction before inserting it.
- Depending on the USB flash memory, it may stick out from the EXT slot. Do not force into the slot or apply pressure to the protruding portion of the USB flash memory.
- To avoid data corruption or damage to the external memory, turn the player off when inserting or removing the external memory.
- When the EXT indicator does not light up, turn the player off, remove and re-insert the external memory, then turn the player on again.
- Do not insert the external memory that contains photo or music files to avoid corrupting the external memory data.

To enjoy BonusView

See “Enjoying BonusView” (page 32).

To remove the external memory

- 1 Press to turn the player off.
- 2 Pull out the external memory from the EXT slot.

Step 4: Connecting to the Network

Connect the LAN (100) terminal of the player to your Internet source using a network cable to update the player's software using the network.

1 Connect the LAN (100) terminal of the player to your Internet source.

Methods to connect to your Internet source include:

- Connecting to a broadband router directly
 - Connecting via a wireless LAN router
- Refer also to the instructions supplied with the broadband router or the wireless LAN router.

2 Make the appropriate settings in "Internet Settings" under the "Network Settings" setup (page 50).

To update the player's software using the network

See "Network Update" (page 40) and "Software Update Notification" (page 49).



Do not connect a phone line to the LAN (100) terminal, as it may cause a malfunction.

When connecting to a broadband router directly

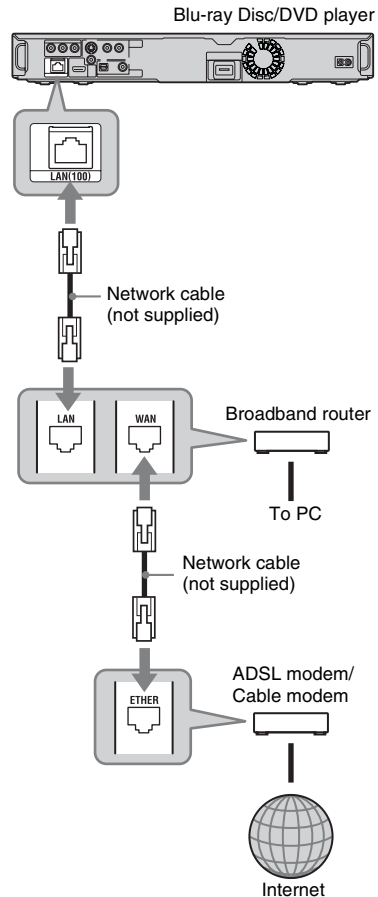

About network (LAN) cables

Depending on the modem or router, the type of network (LAN) cable, straight or crossing, differs. For details on the network (LAN) cables, refer to the operating instructions supplied with the modem or router.

When connecting via a wireless LAN router

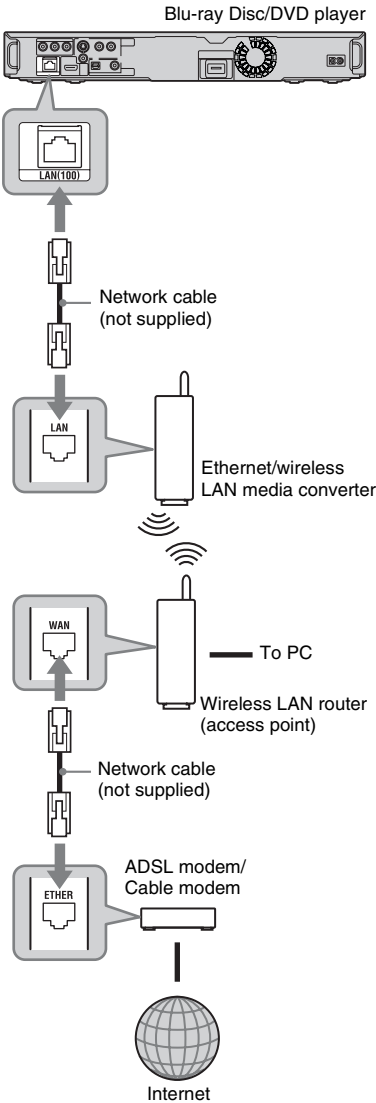

Step 5: Connecting the AC Power Cord

After all of the other connections are complete, connect the supplied AC power cord to the AC IN terminal of the player. Then plug the player and TV power cords into the AC outlet.

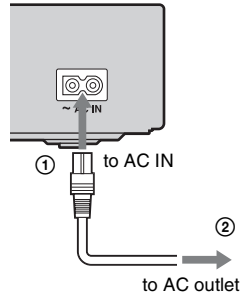

Do not connect the LAN terminal of the player to the LAN terminal of the PC.

Step 6: Preparing the Remote

You can control the player using the supplied remote. Insert two Size AA (R6) batteries by matching the ⊕ and ⊖ ends on the batteries to the markings inside the battery compartment. When using the remote, point it at the remote sensor  on the player (page 10).

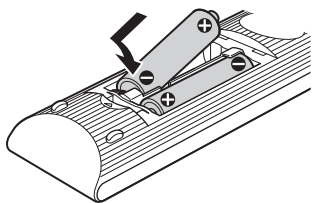

- Use the batteries correctly to avoid possible leakage and corrosion. Should leakage occur, do not touch the liquid with bare hands. Observe the following:
 - Do not use a new battery with an old battery, or batteries of different manufacturers.
 - Do not attempt to recharge the batteries.
 - If you do not intend to use the remote for an extended period of time, remove the batteries.
 - If battery leakage occurs, wipe out any liquid inside the battery compartment, and insert new batteries.
- Do not expose the remote sensor (marked  on the front panel) to strong light, such as direct sunlight or a lighting apparatus. The player may not respond to the remote.

Controlling TVs with the remote

You can control the volume, input source, channel, and power switch of your Sony TV with the supplied remote.



When you replace the batteries of the remote, the code number may be reset to the default setting. Set the appropriate code number again.

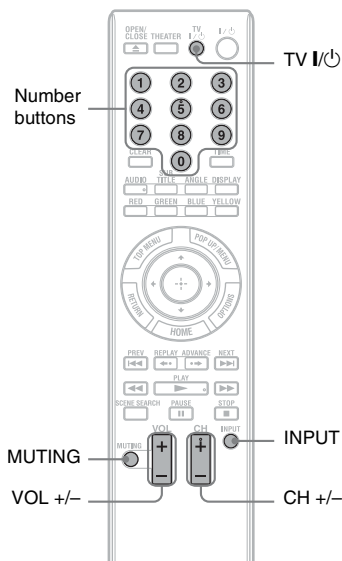

Available buttons

Depending on the connected unit, you may not be able to control your TV with some or all of the buttons (TV I/O, CH +/-, VOL +/-, MUTING, or number buttons).

Buttons	Operations
TV I/O	Turns your TV on or off.
VOL (volume) +/-	Adjusts the volume of your TV.
CH (channel) +/-	Selects the channel on your TV.
INPUT (input select)	Switches your TV's input source between the TV and other input sources.
MUTING	Mutes the sound.

To control other TVs with the remote

You can control the volume, input source, channel, and power switch of non-Sony TVs as well.

If your TV is listed in the table below, set the appropriate manufacturer's code.



If you enter a new code number, the code number previously entered will be erased.

- While holding down TV I/⏻, enter the TV's manufacturer code using the number buttons.
For instance, to enter "09," press "0" then "9."

Code numbers of controllable TVs

If more than one code number is listed, try entering them one at a time until you find the one that works with your TV.

Manufacturer	Code number
Sony	01 (default)
Hitachi	02, 04
LG/Goldstar	04
Mitsubishi/MGA	13, 04
NEC	04
Panasonic	19
Philips	21
Pioneer	16
RCA	10, 04
Samsung	20, 04
Sharp	18
Toshiba	07, 18

- Release TV I/⏻.

Step 7: Easy Setup

Follow the steps below to make the minimum number of basic adjustments for using the player. If you do not complete Easy Setup, it will appear each time you turn on your player.

Make the settings below in the following order.

When turned on for the first time

Wait for a short while before the player turns on and starts Easy Setup.

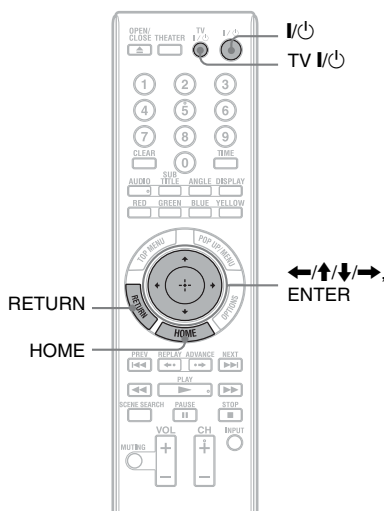

- Turn on the TV.
- Press I/⏻ to turn on the player.
The player turns on after a moment.
- Switch the input selector on your TV so that the signal from the player appears on your TV screen.
The display for OSD language selection appears.
 - If the display for OSD language selection does not appear Press HOME, and select "Easy Setup" in the "Setup" setup (page 52). Then, select "Start," and press ENTER.

4 Select a language for the on-screen displays using \uparrow/\downarrow , and press ENTER.

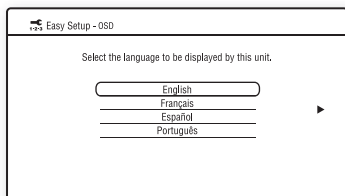

The initial settings message appears.

5 Select "Start," and press ENTER.

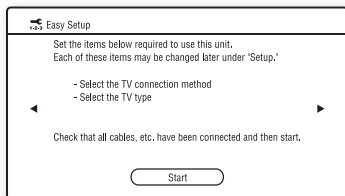

6 Select the cable type used to connect the player and your TV, and press ENTER.

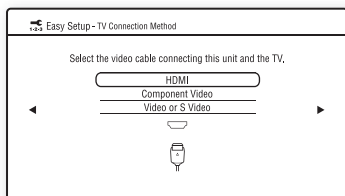

Select "HDMI" when connecting your TV using the HDMI cable, and go to step 7.



When connecting the HDMI OUT jack and other video output jacks at the same time, select "Component Video."

Select "Component Video" when connecting your TV using the component video cable, and go to step 7.

Select "Video or S Video" when connecting your TV using the video cable or S-video cable, and go to step 8.

7 Select a video output resolution for the connected TV, and press ENTER.

For details about the video output resolution, see page 43.

When you select "HDMI" in step 6

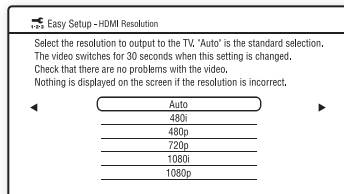

Select from "Auto," "480i," "480p," "720p," "1080i," or "1080p."

When connecting the HDMI OUT jack and other video output jacks at the same time, video signals may not output from the jacks, other than from the HDMI OUT jack, when "Auto" or "1080p" is selected.

When connecting other equipment at the same time, press RETURN to return to step 6 and change the "TV Connection Method" setting.

When you select "Component Video" in step 6

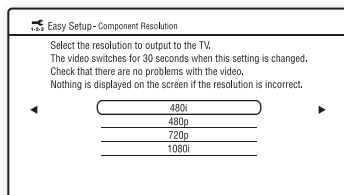

Select from "480i," "480p," "720p," or "1080i."

When you change the video output resolution, a picture is displayed in the selected resolution for about 30 seconds, then the display asks for confirmation. Follow the on-screen instructions and go to the next step.



If the picture is distorted or no picture appears, wait for about 30 seconds without pressing any buttons. The display returns to the resolution setting screen.

If the selected video output resolution is incorrect, no picture appears on the screen when you press any button in 30 seconds. In this case, press **■** on the player for more than 10 seconds to reset the video output resolution to the lowest resolution. To change the video output resolution, set "Output Video Format" in the "Video Settings" setup (page 42).

8 Select an aspect ratio that matches your TV, and press ENTER.

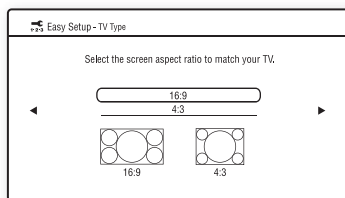

Select "16:9" when connecting to a wide-screen TV or a TV with a wide mode function.

Select "4:3" when connecting to a 4:3 screen TV without a wide mode function.

9 (Only when connecting your TV using the HDMI cable)

Set the "Control for HDMI" function to "On" or "Off," and press ENTER.

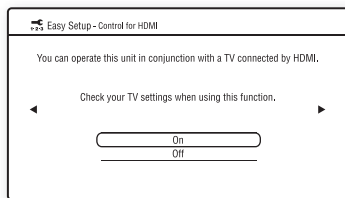

Select "On" to use the "Control for HDMI" function when connecting Sony components that are compatible with the "Control for HDMI" function (page 16). If you do not use the "Control for HDMI" function, select "Off."

10 Select "Finish," and press ENTER.

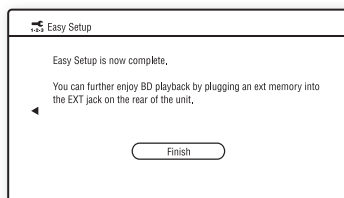

- You can reset settings to their factory settings (page 52).
- You can run "Easy Setup" again from "Easy Setup" in "Setup" (page 52).

Playing BDs/DVDs

BD **DVD**

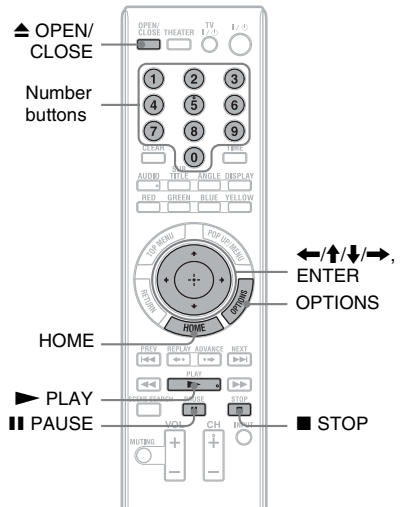

Playback

- 1 Switch the input selector on your TV so that the signal from the player appears on your TV screen.
- 2 Press ▲ OPEN/CLOSE, and place a disc on the disc tray.

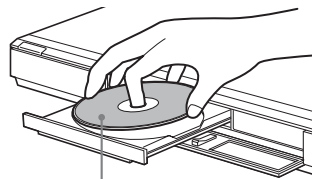

Playing side facing down

- 3 Press ▲ OPEN/CLOSE to close the disc tray.
 - When you insert a commercially available BD-ROM or DVD VIDEO, playback automatically starts depending on the disc.
- ⚡ Playback does not start by pressing ▶ PLAY while the disc tray is open.

- 4 Press HOME.
- 5 Select "Video" using ←/→.
- 6 Select  using ↑/↓, and press ► PLAY or ENTER.

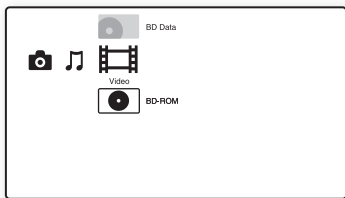

For commercially available BD-ROMs or DVD VIDEOS, playback starts. For BDs or DVDs recorded on other equipment, the title list appears. Select a title using ↑/↓, and press ► PLAY or ENTER. Playback starts.

To stop playback

Press ■ STOP.

To pause playback

Press ■ PAUSE.



In the title list, "PL" (Playlist) is displayed next to the name of titles that are created and edited from their originals.



- Depending on the disc you may not be able to do some of the playback operations. Refer to the instruction manual supplied with the disc.
- Depending on BDs or DVDs recorded on other equipment, title lists or title names may not be displayed.

To resume playback from the point where you stopped (Resume Play)

After stopping playback, select  using ↑/↓, and press ► PLAY or ENTER.

The player resumes playback from the point where you pressed ■ STOP.

To start from the beginning, press OPTIONS to select "Play from beginning," and press ENTER. Playback starts from the beginning of the title.



- The point where you stopped playing is cleared from memory when:
 - you open the disc tray,
 - you play another title,
 - you change the settings on the player, or
 - you remove the external memory (for BD-ROMs).
- The player may not resume playback depending on the disc or stop point.

To play restricted BDs or DVDs (Parental Control)

When you play a restricted BD, change the "BD Parental Control" setting in the "BD/DVD Viewing Settings" setup (page 46). When you play a restricted DVD, the display for entering your password appears on the screen.

Enter your four-digit password using the number buttons, and press ENTER. Playback starts.

To register or change the password, see "Password" (page 48).

To play restricted BD-REs or BD-Rs (Disc Lock)

When you play a BD-RE or BD-R restricted by the Disc Lock function, the display for entering your password appears on the screen.

- 1 Enter the four-digit password that has been registered when creating the disc using the number buttons, and press ENTER.
- 2 Select a title, and press ► PLAY or ENTER. Playback starts.

One-Touch Play (for HDMI connection only)

Press ► PLAY.

The player and the connected TV turn on and the input selector on the TV is switched to the player, then playback starts automatically.



- When using the HDMI connection, there may be a delay before the playback picture appears on the screen, and the beginning portion of the playback picture may not be displayed.
- To use the One-Touch Play function, set "Control for HDMI" to "On" in the "System Settings" setup (page 49).

Available OPTIONS

- 1 Press **OPTIONS**.
The options menu appears.
- 2 Select an item using **↑/↓**, and press **ENTER**.
The available items differ depending on the disc type or player situation.

Items	Details
A/V Settings	Adjusts settings for picture and sound. <ul style="list-style-type: none">• Video Settings (page 34)• Audio Settings (page 35)
Title List	Displays the title list.
Play	Plays the title from the point where you pressed ■ STOP .
Play from beginning	Plays the title from the beginning.
Top Menu	Displays the disc's Top Menu (page 32).
Menu/Popup Menu	Displays the BD-ROM's Pop-up Menu or DVD's menu (page 32).
Stop	Stops playback.
Title Search	Searches for a title and starts playback from the beginning (page 33).
Chapter Search	Searches for a chapter and starts playback from the beginning (page 33).

Using the BD's or DVD's menu

BD DVD

To display Top Menu

When you play a BD or DVD, you can display the Top Menu.

- 1 Press **TOP MENU** during playback.
The Top Menu appears.
- 2 Select an item using **←/↑/↓/→**.

To display Pop-up Menus

Some BD-ROMs contain Pop-up Menus that appear without interrupting playback.

- 1 Press **POP UP/MENU** during playback.
The Pop-up Menu appears.
- 2 Select an item using **←/↑/↓/→**, color buttons, or the number buttons, and follow the on-screen instructions.

Enjoying BonusView

BD

Some BD-ROMs have bonus contents and other data that can be downloaded to the external memory (local storage) for enjoyment.

- 1 Turn the player off.
- 2 Insert the external memory (not supplied) into the **EXT** slot on the rear of the player.

The external memory is used as the local storage.

Make sure that the external memory is properly inserted into the player (page 23).

- 3 Turn the player on.
- 4 Insert a **BD-ROM with BonusView**.

The operation method differs depending on the disc. Refer to the instruction manual supplied with the disc.

To delete data in the external memory

You can delete all unnecessary data at once.

- 1 Press HOME.
- 2 Select "Video" using \leftarrow/\rightarrow .
- 3 Select "BD Data" using \uparrow/\downarrow , and press OPTIONS.
- 4 Select "Erase," and press ENTER.
- 5 Select "OK," and press ENTER.

Searching for a scene quickly (Scene Search)

BD DVD

You can move quickly between scenes within the title currently being played back.

- 1 Press **SCENE SEARCH** during playback or in pause mode.

Playback pauses and a bar with a scene indicator (square-shaped – indicates the current point) appears at the bottom of the screen.

- 2 Move the scene indicator to the scene you are searching for using \leftarrow/\rightarrow or \ll/\gg .

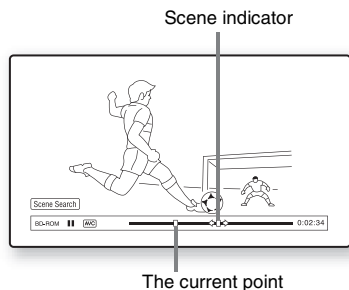

The current point

The scene indicator on the bar is displayed around the playing point.

- 3 Release the button at the point you want to watch.

The scene at which you released the button is displayed in pause mode. To search for a scene again, move the scene indicator using \leftarrow/\rightarrow or \ll/\gg .

- 4 Press **SCENE SEARCH**, **ENTER**, \blacktriangleright **PLAY**, or \parallel **PAUSE**.

Playback starts.

To cancel Scene Search mode

Press **SCENE SEARCH**, **ENTER**,

- \blacktriangleright **PLAY**, or \parallel **PAUSE**.

Playback starts from the point you pressed the button.



The Scene Search function is available for titles longer than 100 seconds and shorter than 100 hours.

Searching for a Title/Chapter

BD DVD

You can search for a chapter if the title contains chapter marks.

- 1 Press **OPTIONS** during playback or in pause mode.

The options menu appears.

- 2 Select a search method using \uparrow/\downarrow , and press **ENTER**.

"Title Search" (for BD-ROMs/DVD VIDEOS)

"Chapter Search"

The display for entering the number appears.

Example: Chapter Search

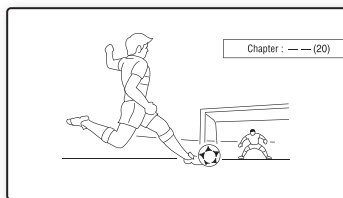

- 3 Enter the number of the title or chapter using the number buttons.

If you make a mistake, press **CLEAR**, and re-enter another number.

- 4 Press **ENTER**.

After a while, the player starts playback from the selected number.

Displaying the playing time and playback information

BD DVD

You can check the title information, including the video transmission rate, etc.

Press DISPLAY.

The displayed information differs depending on the disc type and player status.

Example: When playing a BD-ROM

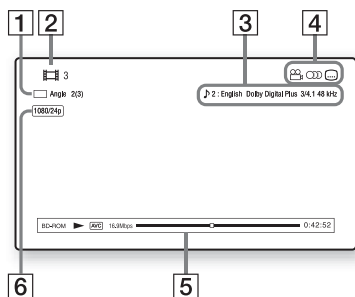

- 1 The current selected angle
- 2 Title number or name
- 3 The currently selected audio or subtitle setting
- 4 Available functions (ANGLE angle/⏏ audio/⏏ subtitle)
- 5 Playback information
Displays Disc type/Play mode/Video codec/Bit rate/Playing status bar/Playing time (Remaining time*)
- 6 Output resolution/Video frequency

* Displayed when you press TIME repeatedly.



- You can also check the playback information in the front panel display (page 11).
- Press SUBTITLE, AUDIO, or ANGLE, and you can check each type of information.

Adjusting pictures and sound for videos

BD DVD

To adjust the picture

- 1 Press **OPTIONS** during playback. The options menu appears.
- 2 Select “A/V Settings” using **↑/↓**, and press **ENTER**.
- 3 Select “Video Settings” using **↑/↓**, and press **ENTER**. The “Video Settings” screen appears.

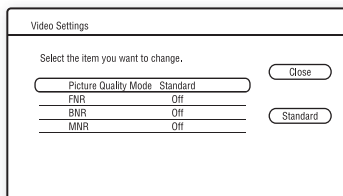

- 4 Select an item using **↑/↓**, and press **ENTER**. The default settings are underlined.

Items	Details
Picture Quality Mode (Standard/ Brighter Room/Theater Room)	Optimizes the picture settings for different lighting environments.
FNR (Off/Auto)	Reduces random noise appearing in the picture.
BNR (Off/Auto)	Reduces mosaic-like block noise in the picture.
MNR (Off/Auto)	Reduces minor noise around the picture outlines (mosquito noise).

- 5 Select or adjust the settings using **←/↑/↓/→**, and press **ENTER**. To adjust any other items, repeat steps 4 and 5.

- ⚡ Set the picture setting of your TV to 'Standard' before changing the "Picture Quality Mode" setting.
 - "Video Settings" is not available when the connected TV is set to Theater Mode (page 16).
 - Depending on the disc or the scene being played, "FNR," "BNR" or "MNR" effects may be hard to discern.
- ⚡ The "Audio Filter" function does not work for digital audio signals output from the HDMI OUT/ DIGITAL OUT (OPTICAL/COAXIAL) jacks.
 - There may be little effect by changing the "Audio Filter" setting depending on the disc or playback environment.

To adjust the audio characteristics

- 1 Press **OPTIONS** during playback. The options menu appears.
- 2 Select "A/V Settings" using **↑/↓**, and press **ENTER**.
- 3 Select "Audio Settings" using **↑/↓**, and press **ENTER**. The "Audio Settings" screen appears.

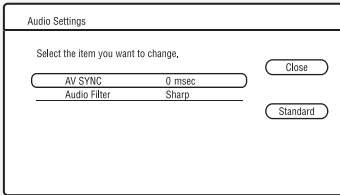

- 4 Select an item using **↑/↓**, and press **ENTER**. The default settings are underlined.

Items	Details
AV SYNC (short) <u>0</u> ~ 120 msec (long)	Adjusts the gap between picture and sound, by delaying the sound output in relation to the picture output (0 to 120 milliseconds).
Audio Filter (for analog audio signals only)	<ul style="list-style-type: none"> • <u>Sharp</u>: Provides a wide frequency range and spatial feeling. Normally select this. • Slow: Provides smooth and warm sound.

- 5 Select or adjust the settings using **←/↑/↓/→**, and press **ENTER**. To adjust any other items, repeat steps 4 and 5.

Playing CDs

CD

- 1 **Insert a CD.**
The Music Player screen appears.
- 2 **Press ► PLAY.**
Playback starts.

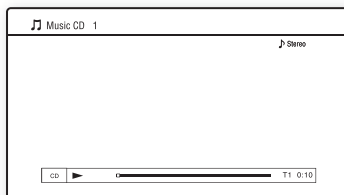

To select a track

- 1 Press HOME.
- 2 Select (Music) using .
- 3 Select , and press ENTER.
The music list appears.
- 4 Select a track using .
To play the selected track, press PLAY or ENTER.

Available OPTIONS

- 1 Press OPTIONS.
The options menu appears.
- 2 Select an item using , and press ENTER.
The available items differ depending on the situation.

Items	Details
Play	Plays the selected track.
Play from beginning	Plays the current track from the beginning.
Stop	Stops playing the track.

Various music playback operations

Buttons	Operations
PLAY	Starts playback from the point where you pressed STOP.
STOP	Stops playback.
PAUSE	Pauses playback.
PREV/ NEXT	Skips to the beginning of the current or next track. To go to the previous track press PREV twice.
	Fast reverse/fast forwards when pressed during playback.
TIME	Switches time information on the screen and the front panel display (page 11).



The point where you stopped playing (resume point) is cleared from memory when:
– you open the disc tray, or
– you turn off the player.

Playing Photo Files

BD *1 **DATA DVD** *2 **DATA CD** *3

- *1 BD-REs/BD-Rs containing JPEG image files
- *2 DVD+RWs/DVD+Rs/DVD-RWs/DVD-Rs containing JPEG image files
- *3 CD-RWs/CD-Rs containing JPEG image files

- 1 Press **HOME**.
- 2 Select **📷 (Photo)** using **←/→**.

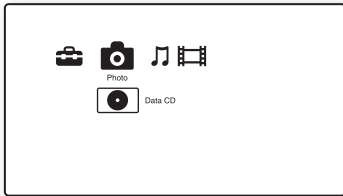

- 3 Select **📷**, and press **ENTER**.
The file list or folder list appears.

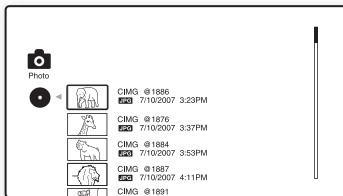

- 4 Select a file or folder using **↑/↓**, and press **ENTER**.
When you select a folder, select a file in the folder using **↑/↓**, and press **ENTER**.
The selected photo file is displayed.
• To play a slideshow, press **▶ PLAY**.

Available OPTIONS during playback

- 1 Press **OPTIONS** during playback.
The options menu appears.
- 2 Select an item using **↑/↓**, and press **ENTER**.
The available items differ depending on the situation.

Items	Details
Slideshow Speed	Changes the slideshow speed. • Fast • Normal • Slow
Stop	Stops a slideshow.
Rotate Left	Rotates the photo counterclockwise by 90 degrees.
Rotate Right	Rotates the photo clockwise by 90 degrees.

Various photo playback operations

Buttons	Operations
■ STOP RETURN	Stops a slideshow.
 PAUSE	Pauses a slideshow.
◀◀ PREV/ NEXT ▶▶	Displays the previous or next photo.
DISPLAY	Displays the file information.



- When you attempt to play the following photo files, the  mark appears on the screen and they cannot be played.
 - photo files larger than 8,192 pixels (width or height)
 - photo files smaller than 15 pixels (width or height)
 - photo files exceeding 32 MB
 - photo files with extreme aspect ratios (greater than 50:1 or 1:50)
 - photo files in Progressive JPEG format
 - photo files that have a “.jpeg” or “.jpg” extension, but not in JPEG format
 - photo files that have an extremely long name
- The following photo files cannot be played.
 - photo files recorded on BD-Rs in any format other than UDF (Universal Disk Format) 2.6
 - photo files recorded on BD-REs in any format other than UDF (Universal Disk Format) 2.5
- The following photo files or folders cannot be displayed in the file list or folder list.
 - photo files that have an extension other than “.jpeg” or “.jpg”
 - photo files that have an extremely long name
 - photo files in the 5th tree or lower
 - 501th or more folders when the total number of folders and files in a single tree exceeds 500
- Photo files edited on a PC may not be played.
- Thumbnail images of some photo files may not be displayed.
- Large photo files may take some time to display or to start a slideshow.

To view best quality images



If you have a Sony TV compatible with “PhotoTV HD,” you can enjoy best quality images by the following connection and setting.

- 1** Connect the player to the TV using an HDMI cable (not supplied).
- 2** Set the TV’s video setting to [VIDEO-A] mode.
For details on [VIDEO-A], refer to the operating instructions supplied with the TV.

Settings and Adjustments

Using the Settings Displays

Select  (Setup) on the home menu when you need to change the settings of the player.

- 1 Press HOME.
- 2 Select  (Setup) using / .

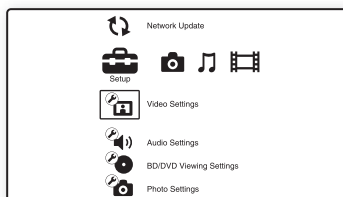

- 3 Select the setup category icon to change using / , and press ENTER.

For details on setting options and setup category icons, see “Setting list” (page 40).



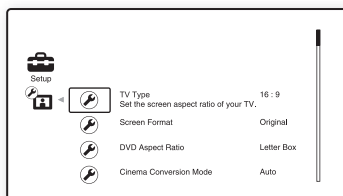





Example: Video Settings



- 4 Set the options.

Setting list

You can setup the following options.

Icon	Explanation
	Network Update (page 40) Updates the software of the player.
	Video Settings (page 41) Makes the video settings according to the type of connecting jacks.
	Audio Settings (page 44) Makes the audio settings according to the type of connecting jacks.
	BD/DVD Viewing Settings (page 46) Makes detailed settings for BD/DVD playback.
	Photo Settings (page 48) Makes the photo-related settings.
	System Settings (page 49) Makes the player-related settings.
	Network Settings (page 50) Makes detailed settings for Internet and network.
 1-2-3	Easy Setup (page 52) Re-runs the Easy Setup to make the basic settings.
	Resetting (page 52) Resets the player to the factory settings.

Network Update

You can update and improve the functions of the player.

For information about update functions, refer to the following website;

<http://www.sony.net/>

1 Select “Network Update” using , and press ENTER.

The player connects to the network, and the display asks for confirmation.

2 Select “OK” using , and press ENTER.

The player starts downloading, then updating the software automatically.

When updating finishes, “FINISH” appears for 5 seconds in the front panel display, then the player automatically turns off.

3 Press to turn on the player.

The player starts up with the updated software.



- The “VUP */9” counter (“*” indicates update step) in the front panel display also shows progress of the update.
- You can check the current software version by selecting “System Information” in the “System Settings” setup (page 49).
- The “Setup” settings remain after updating.
- The player informs you of newer software version information when “Software Update Notification” is set to “On” (default) (page 49).



- Do not disconnect the AC power cord or network cable while downloading or updating software.
- Any operations, including opening the disc tray, are not available while updating.
- Downloading times may differ depending on the server provider or line status.
- When error messages on network connections appear, check the network connections using “Network Diagnostic” of “Internet Settings” in the “Network Settings” setup (page 50).

To update the software using an update disc

You can update and improve the functions of the player using an update disc provided by Sony dealer or local authorized Sony service facility.

- 1 Insert the update disc.
The display asks for confirmation.
- 2 Select "OK," and press ENTER.
Software update starts.
When updating finishes, "FINISH" appears for 5 seconds in the front panel display, then the disc tray automatically opens.
- 3 Remove the disc.
The player automatically turns off.
- 4 Press **I/⏻** to turn the player on.
The player starts up with the updated software.



- The "VUP */9" counter ("*" indicates update step) in the front panel display also shows progress of the update.
- You can check the current software version by selecting "System Information" in the "System Settings" setup (page 49).
- The "Setup" settings remain after updating.
- For information about other software update methods, refer to the following website or consult your nearest Sony dealer or local authorized Sony Service facility;
<http://www.sony.net/>



- Do not disconnect the AC power cord while updating.
- Any operations, including opening the disc tray, are not available while updating.



Video Settings

The default settings are underlined.

TV Type

Selects your TV type.

<u>16:9</u>	Select this when connecting to a wide-screen TV or a TV with a wide mode function.
4:3	Select this when connecting to a 4:3 screen TV without a wide mode function.

Screen Format

Selects the display configuration for a 4:3 screen picture on a 16:9 wide screen TV.

<u>Original</u>	Select this when connecting to a TV with a wide mode function. Displays a 4:3 screen picture in 16:9 aspect ratio even on a wide-screen TV.
Fixed Aspect Ratio	Changes the picture size to fit the screen size with the original picture aspect ratio.

DVD Aspect Ratio

Selects the display configuration for playback of 16:9 screen pictures on a 4:3 screen TV (selectable when “TV Type” is set to “4:3” and “Screen Format” is set to “Fixed Aspect Ratio”).

<u>Letter Box</u>	Displays a wide picture with black bands on the top and bottom.
Pan & Scan	Displays a full-height picture on the entire screen, with trimmed sides.

Letter Box



Pan & Scan



Cinema Conversion Mode

Sets the video conversion method for 480p, 720p, 1080i, or 1080p* signals from the HDMI OUT jack or the COMPONENT VIDEO OUT jacks.

* HDMI only

<u>Auto</u>	Normally select this. The player automatically detects whether the material is video-based or film-based, and switches to the appropriate conversion method.
Video	The conversion method suited for video-based material will always be selected regardless of the material.

Output Video Format

Selects the jack type to output video signals (“TV Connection Method”) and output resolution (“HDMI Resolution”/“Component Resolution”).

- 1 Select “Output Video Format” in “Video Settings,” and press ENTER.
- 2 Select the jack type to output video signals using \uparrow/\downarrow , and press ENTER.



When connecting the HDMI OUT jack and other video output jacks at the same time, select “Component Video.”

TV Connection Method

HDMI	Outputs signals from the HDMI OUT jack according to the “HDMI Resolution” setting below.
Component Video	Outputs signals from the COMPONENT VIDEO OUT jacks according to the “Component Resolution” setting below.
<u>Video or S Video</u>	Outputs signals from the LINE OUT VIDEO or S VIDEO jack.

- 3 (When you select “HDMI” or “Component Video” only)
Select the signal type for the HDMI OUT jack or COMPONENT VIDEO OUT jacks using \uparrow/\downarrow , and press ENTER.
When you change the video output resolution, a picture is displayed in the selected resolution for about 30 seconds, then the display asks for confirmation. Follow the on-screen instructions.

The HD indicator lights up when outputting 720p/1080i/1080p video signals.



- If the picture is distorted or no picture appears, wait for about 30 seconds without pressing any buttons. The display returns to the resolution setting screen.
If the selected video output resolution is incorrect, no picture appears on the screen when you press any button in 30 seconds. In this case, press **■** on the player for more than 10 seconds to reset the video output resolution to the lowest resolution.
- When connecting the HDMI OUT jack and other video output jacks at the same time, video signals may not output from the jacks, other than from the HDMI OUT jack, when “Auto” or “1080p” is selected.
When connecting other equipment at the same time, press RETURN to return to step 2 and change the “TV Connection Method” setting.

HDMI Resolution/Component Resolution

Auto (HDMI only)	Normally select this. The player outputs signals starting from the highest resolution acceptable to the TV: 1080p > 1080i > 720p > 480p > 480i If the resulting image format is undesirable, try another setting that suits your TV.
480i	Outputs 480i video signals.
480p	Outputs 480p video signals.
720p	Outputs 720p video signals.
1080i	Outputs 1080i video signals.
1080p (HDMI only)	Outputs 1080p video signals.

BD-ROM 1080/24p Output

Sets to output 1920 × 1080p/24 Hz video signals when playing film-based materials on BD-ROMs (720p/24 Hz or 1080p/24 Hz). 1920 × 1080p/24 Hz video signals can be output when all of the following conditions are met.

- You connect a 1080/24p-compatible TV using the HDMI OUT jack,
- “Output Video Format” is set to “HDMI,” and
- “HDMI Resolution” is set to “Auto” or “1080p.”

The 24P indicator lights up when outputting 1920 × 1080p/24 Hz video signals.

Auto	Outputs 1920 × 1080p/24 Hz video signals only when connecting a 1080/24p-compatible TV using the HDMI OUT jack.
On	Outputs 1920 × 1080p/24 Hz video signals regardless of the connected TV type.
Off	Select this when your TV is not compatible with 1080/24p video signals.



No BD-ROM picture appears when the connected TV is non-compatible with 1080/24p and “BD-ROM 1080/24p Output” is set to “On.” In this case, press HOME to display the home menu, and change the “BD-ROM 1080/24p Output” setting.

YCbCr/RGB (HDMI)

Sets the color setting for video signals output from the HDMI OUT jack. Select the setting that matches the connected TV type.

<u>Auto</u>	Automatically detects the type of external device, and switches to the matching color setting.
YCbCr (4:2:2)	Outputs YCbCr 4:2:2 video signals.
YCbCr (4:4:4)	Outputs YCbCr 4:4:4 video signals.
RGB (16-235)	Select this when connecting to a device with an HDCP-compliant DVI jack.
RGB (0-255)	Select this when connecting to an RGB (0-255) device.

x.v.Color Output

Sets whether to send xvYCC information to the connected TV.

Combining xvYCC-compatible video with a TV that supports x.v.Color display makes it possible to more accurately reproduce object colors present in the natural world.

<u>Auto</u>	Normally select this.
Off	Select this when the picture is unstable or colors appear unnatural.

Pause Mode

Sets the picture mode for DVD playback pause status. For BD-ROMs or discs containing AVCHD files, "Pause Mode" automatically switches to "Auto."

<u>Auto</u>	Normally select this. Dynamic moving pictures appear without blurring.
Frame	Displays static pictures at high resolution.

Audio Settings

The default settings are underlined.

Audio Output Priority

Selects the jack type to output audio signals. 2-channel linear PCM signals are output at 48 kHz maximum from output jacks other than the priority jacks.

<u>HDMI</u>	Outputs audio signals from the HDMI OUT jack.
Coaxial/ Optical	Outputs audio signals from the DIGITAL OUT (OPTICAL/COAXIAL) jack.
Stereo Analog	Outputs audio signals from the LINE OUT (R-AUDIO-L) jacks.

Audio (HDMI)

Selects the signal type for the HDMI OUT jack.

<u>Auto</u>	Normally select this. Outputs audio signals according to the status of the connected HDMI device.
2ch PCM	Downmixes to 2-channel Linear PCM signals before outputting from the HDMI OUT jack.



Select "2ch PCM" when connecting a TV or an AV amplifier (receiver) that does not support Dolby Digital or DTS, otherwise noise or no sound may result.

BD Audio Setting

Selects whether to mix or not mix interactive audio and secondary audio (commentary) when playing a BD that contains such audio.

<u>Mix</u>	Outputs the audio obtained by mixing the interactive audio and secondary audio to the primary audio.
Direct	Outputs the primary audio only.

Audio ATT

Lowers the audio output level to prevent sound distortion.

On	Enables Audio Attenuation.
Off	Disables Audio Attenuation.



“Audio ATT” does not affect the output from the HDMI OUT jack and the DIGITAL OUT (OPTICAL/COAXIAL) jack.

Dolby Digital

Selects the audio signals output when playing Dolby Digital discs.

This setting affects the output from the DIGITAL OUT (COAXIAL/OPTICAL) jack.

Downmix PCM	Converts to output Linear PCM signals. Select this when connecting an audio device without a built-in Dolby Digital decoder.
Dolby Digital	Select this when connecting an audio device with a built-in Dolby Digital decoder.

DTS

Selects the audio signals output when playing DTS discs. This setting affects the output from the DIGITAL OUT (COAXIAL/OPTICAL) jack.

Downmix PCM	Converts to output Linear PCM signals. Select this when connecting to an audio device without a built-in DTS decoder.
DTS	Select this when connecting to an audio device with a built-in DTS decoder.

48kHz/96kHz PCM

Selects the maximum sampling frequency for the PCM signals output from the DIGITAL OUT (OPTICAL/COAXIAL) jack.

48kHz/16bit	Outputs audio signals of 96 kHz sampling as 48 kHz/16 bit.
96kHz/24bit	Outputs audio signals of 96 kHz sampling as 96 kHz/24 bit. However, the signals will be output as 48 kHz/16 bit if the source is copy-protected.



- If you select “96kHz/24bit” when an AV amplifier (receiver) that does not support 96 kHz is connected, no sound or a loud sound may result.
- “48kHz/96kHz PCM” is not effective when “Audio Output Priority” is set to “HDMI” or “Stereo Analog.”

Audio DRC

Selects the dynamic range (compression level of the sound) setting when playing a BD or DVD that conforms to “Audio DRC.”

Auto	Performs playback at the dynamic range specified by the disc (BD-ROM only). Other discs are played back at the “Standard” level.
Standard	Performs playback at a compression level between “TV Mode” and “Wide Range.”
TV Mode	Sounds are compressed heavily. Low sounds are easier to hear.
Wide Range	No compression works. A more dynamic sound is produced.



- “Audio DRC” is effective only when playing Dolby Digital, Dolby Digital Plus, and Dolby TrueHD audio signals.
- When “Dolby Digital” is set to “Dolby Digital” in the “Audio Settings” setup (page 45), “Audio DRC” has no effect on the audio output from the DIGITAL OUT (OPTICAL/COAXIAL) jack. However, this excludes the following cases.
 - when “BD Audio Setting” is set to “Mix” when playing a BD.
 - when “Audio Output Priority” is set to “HDMI” or “Stereo Analog.”

Downmix

Sets the downmix method of multi-channel to two-channel sound.

<u>Dolby Surround</u>	Outputs the Dolby Surround (Pro Logic) signals in 2 channels. Select this when connecting an audio device that supports Dolby Surround (Pro Logic).
Normal	Outputs audio signals without Dolby Surround (Pro Logic) effect. Select this when connecting an audio device that does not support Dolby Surround (Pro Logic).



“Downmix” has no effect on the bitstream audio output from the DIGITAL OUT (OPTICAL/COAXIAL)/HDMI OUT jack.



BD/DVD Viewing Settings

The default settings are underlined.

BD/DVD Menu

Selects the default menu language for BD-ROMs or DVD VIDEOS.
When you select “Select Language Code,” the display for entering the language code appears. Enter the code for your language by referring to “Language Code List” (page 64).

Audio

Selects the default track language for BD-ROMs or DVD VIDEOS.
When you select “Original,” the language given priority in the disc is selected.
When you select “Select Language Code,” the display for entering the language code appears. Enter the code for your language by referring to “Language Code List” (page 64).

Subtitle

Selects the default subtitle language for BD-ROMs or DVD VIDEOS.
When you select “Select Language Code,” the display for entering the language code appears. Enter the code for your language by referring to “Language Code List” (page 64).

BD Parental Control

Playback of some BD-ROMs can be limited according to the age of the users. Scenes may be blocked or replaced with different scenes.

- 1** Select “BD Parental Control” in “BD/DVD Viewing Settings,” and press **ENTER**.
- 2** Enter your four-digit password using the number buttons.
- 3** Select “OK,” and press **ENTER**.

4 Select the age restriction, and press ENTER.

The lower the value, the stricter the limitation.

If you select “Select Age Restriction,” you can enter the age from “0” to “255” using /// or the number buttons.

- To cancel the Parental Control setting, select “No Restrictions.”



You can change the password (see “Password” on page 48).



- If you forget the password, reset the player (page 52) and set a new password (see “Password” on page 48).
- When you play discs which do not have the Parental Control function, playback cannot be limited on this player.
- Depending on the disc, you may be asked to change the Parental Control level while playing the disc. In this case, enter your password, then change the level.
- When “255” is selected in “Select Age Restriction,” the Parental Control setting is canceled.

DVD Parental Control

Playback of some DVD VIDEOS can be limited according to the age of the users. Scenes may be blocked or replaced with different scenes.

1 Select “DVD Parental Control” in “BD/DVD Viewing Settings,” and press ENTER.

2 Enter your four-digit password using the number buttons.

3 Select “OK,” and press ENTER.

4 Select a level, and press ENTER.

The lower the value, the stricter the limitation.

- To cancel the Parental Control setting, select “No Restrictions.”



You can change the password (see “Password” on page 48).



- If you forget the password, reset the player (page 52) and set a new password (see “Password” on page 48).
- When you play discs which do not have the Parental Control function, playback cannot be limited on this player.
- Depending on the disc, you may be asked to change the Parental Control level while playing the disc. In this case, enter your password, then change the level.

Parental Control Region Code

Playback of some BD-ROMs or DVD VIDEOS can be limited according to the geographic area. Scenes may be blocked or replaced with different scenes.

1 Select “Parental Control Region Code” in “BD/DVD Viewing Settings,” and press ENTER.

2 Enter your four-digit password using the number buttons.

3 Select “OK,” and press ENTER.

4 Select the area restriction, and press ENTER.

When you select “Select Region Code,” the display for entering the region code appears. Enter the code for the area restriction by referring to “Parental Control/Area Code” (page 64).



You can change the password (see “Password” on page 48).



- If you forget the password, reset the player (page 52) and set a new password (see “Password” on page 48).
- When you play discs which do not have the Parental Control function, playback cannot be limited on this player.
- Depending on the disc, you may be asked to change the Parental Control level while playing the disc. In this case, enter your password, then change the level.

Password

Sets or changes the password for the Parental Control function. A password allows you to set a restriction on BD-ROM or DVD VIDEO playback. If necessary, you can differentiate the restriction levels for BD-ROMs and DVD VIDEOS.

- 1 Select “Password” in “BD/DVD Viewing Settings,” and press ENTER.
- 2 Enter your four-digit password using the number buttons.
- 3 Select “OK,” and press ENTER.

To change the password

- 1 After step 3, enter a new password using the number buttons.
- 2 Select “OK,” and press ENTER.

Hybrid Disc Playback Layer

Selects the layer priority when playing a Hybrid Disc. To change the setting, turn the player off and on again.

<u>BD</u>	Plays BD layer.
DVD/CD	Plays DVD or CD layer.



Photo Settings

The default setting is underlined.

Slideshow Speed

Changes the slideshow speed.

Fast	Photos change rapidly.
<u>Normal</u>	Photos change at normal speed.
Slow	Photos change slowly.



System Settings

The default settings are underlined.

OSD

Selects your language for the player on-screen displays.

Dimmer

Adjusts the lighting of the front panel display.

<u>Bright</u>	Bright lighting.
Dark	Low lighting.
Off	Turns off the lighting during playback. Low lighting other than during playback.

Control for HDMI

On	Allows you to use the “Control for HDMI” function (page 16).
<u>Off</u>	Turns off the function.

Standby Mode

Quick Start	Shortens the startup time from standby mode. You can operate the player quickly after turning it on.
<u>Normal</u>	The default setting.



- When “Standby Mode” is set to “Quick Start,”
- power consumption will be higher than when “Standby Mode” is set to “Normal” and
 - the ventilation fan may turn on depending on the surrounding temperature.

Auto Display

<u>On</u>	Automatically displays information on the screen when changing the viewing titles, picture modes, audio signals, etc.
Off	Displays information only when you press DISPLAY.

Screen Saver

The screen saver image appears when you do not use the player for more than 15 minutes while an on-screen display, such as the home menu, is displayed on your TV screen. The screen saver image helps prevent your display device from becoming damaged (ghosting).

<u>On</u>	Turns on the screen saver function.
Off	Turns off the function.

Software Update Notification

Informs you of newer software version information. Network connections and settings are required when using this function (page 50).

<u>On</u>	Sets the player to inform you of newer software version information (page 40).
Off	Turns off the function.

System Information

Displays the player’s software version information and the MAC address.



Network Settings

Internet Settings

These items are necessary when you connect to the Internet via a network cable. Enter the respective (alphanumeric) values for your broadband router or Wireless LAN router. The items that need to be set may differ, depending on the Internet service provider or the router. For details, refer to the instruction manuals that have been provided by your Internet service provider or supplied with the router.

- 1** Select “Internet Settings” in “Network Settings,” and press ENTER.
- 2** Select “IP Address Acquisition,” and press ENTER.
- 3** Select an item, and press ENTER.

Use DHCP	Select this when DHCP (Dynamic Host Configuration Protocol) server settings are available from your Internet service provider. The network settings necessary for the player will be assigned automatically.
Use Static IP Address	Set the IP address manually according to your network environment.

- When you select “Use DHCP”
If you set “DNS Server Auto Acquisition” to “Off,” set the following item:
– DNS Server (Primary)/DNS Server (Secondary)
- When you select “Use Static IP Address”
Set the following items:
– IP Address
– Subnet Mask
– Default Gateway
– DNS Server (Primary)/DNS Server (Secondary)



When you set the “DNS Server (Primary)”/“DNS Server (Secondary)” addresses manually, enter the “DNS Server (Primary)” address. Otherwise, the “Internet Settings” will be set incorrectly.

- 4** If your ISP has a specific proxy server setting, select “Proxy Settings” using **↑/↓**, and press ENTER.

The “Proxy Settings” display appears. If the proxy server does not have a specific setting, go to step 8.

- 5** Set “Use of Proxy Server” to “On.”
- 6** Select “Proxy Server” and “Port,” and enter the settings.

To enter the proxy server, see “To enter characters” (page 51).

- 7** Press RETURN.
- 8** Select “Network Diagnostic” using **↑/↓**, and press ENTER.
- 9** Select “Start,” and press ENTER.

- 10** Check that the message “Network connections are correct.” appears.

The setup is finished. If the message does not appear, follow the on-screen messages.

To enter characters

The display for entering characters appears when you select “Proxy Server” in “Proxy Settings.”

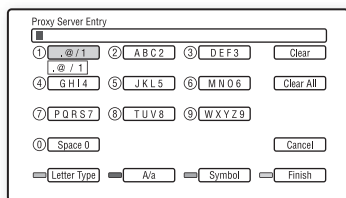

- 1 Press a number button repeatedly to select a character.
Example:
Press the number 3 button once to enter “D.”
Press the number 3 button three times to enter “F.”
- 2 Press \rightarrow , and enter the next character.
- 3 Press the yellow button (“Finish”) to finish.

◆ Available buttons

Buttons	Details
Red button (Letter Type)	Switches the keyboard between alphabet and numbers.
Green button (A/a)	Switches the keyboard between upper case and lower case.
Blue button (Symbol)	Displays the keyboard for symbols.
Yellow button (Finish)	The input is entered, and the player returns to the previous display.
CLEAR (Clear/Clear All)	Erases the selected character. To erase all displayed characters, press and hold CLEAR for 2 seconds or more.
RETURN (Cancel)	Returns to the previous display, canceling the input.
$\leftarrow/\uparrow/\downarrow/\rightarrow$, ENTER	<ul style="list-style-type: none"> • Select an input function using $\leftarrow/\uparrow/\downarrow/\rightarrow$, and press ENTER. • Enter characters as follows: ①Select a character selection panel using $\leftarrow/\uparrow/\downarrow/\rightarrow$, and press ENTER. ②Select a character using \leftarrow/\rightarrow, and press ENTER.

Easy Setup

Re-runs the Easy Setup to make the basic settings.

- 1** Select “Easy Setup,” and press ENTER.
- 2** Select “Start” using **←/→**, and press ENTER.
- 3** Follow the instructions for “Step 7: Easy Setup” (page 27) from step 4.

Resetting

You can reset the player settings to the factory default by selecting the group of settings. All the settings within the group will be reset.

- 1** Select “Resetting,” and press ENTER.
- 2** Select “Reset to Factory Default Settings,” and press ENTER.
- 3** Select the settings you want to reset to default, and press ENTER.
The display asks for confirmation.
You can reset the following settings:
 - Video Settings
 - Audio Settings
 - BD/DVD Viewing Settings
 - Photo Settings
 - System Settings
 - Network Settings
 - All Settings
- 4** Select “Start” using **←/→**, and press ENTER.



When “All Settings” is selected in step 3, the Blu-ray Disc indicator lights up, then turns off when Easy Setup is complete.

Additional Information

Troubleshooting

If you experience any of the following difficulties while using the player, use this troubleshooting guide to help remedy the problem before requesting repairs. Should any problem persist, consult your nearest Sony dealer.

Power

The power does not turn on.

- ➔ Check that the AC power cord is connected securely.
- ➔ It takes a short while before the player turns on.

The message “A new software version has been found on the network.” appears on the screen when turning the player on.

- ➔ See “Network Update” (page 40) to update the player to a newer software version.

Disc

The disc does not play.

- ➔ The disc is dirty.
- ➔ The disc is upside down. Insert the disc with the playback side facing down.
- ➔ The disc is skewed.
- ➔ You are attempting to play a disc with a format that cannot be played back by this player (page 59).
- ➔ The region code on the BD or DVD does not match the player.
- ➔ The player cannot play a recorded disc that is not correctly finalized (page 59).

Picture

See also “Connecting to an HDMI jack” (page 15) when connecting equipment using the HDMI cable.

There is no picture/picture noise appears.

- ➔ Check that all the connecting cables are securely connected.
- ➔ Check whether the connecting cables are damaged.

- ➔ Check the connection to your TV (page 14) and switch the input selector on your TV so that the signal from the player appears on the TV screen.
- ➔ When playing a double-layer DVD, the video and audio may be momentarily interrupted at the point where the layers switch.

No picture appears when the video output resolution selected in “Output Video Format” is incorrect.

- ➔ Press ■ on the player for more than 10 seconds to reset the video output resolution to the lowest resolution.

The picture does not fill the screen, even though the aspect ratio is set in “DVD Aspect Ratio” under “Video Settings.”

- ➔ The aspect ratio of the disc is fixed on your DVD (page 42).

Video signals are not output from the jacks, other than from the HDMI OUT jack, when connecting the HDMI OUT jack and other video output jacks at the same time.

- ➔ Set “Output Video Format” to “Component Video” in the “Video Settings” setup (page 42).

The dark area of the picture is too dark/the bright area is too bright or unnatural.

- ➔ Set “Picture Quality Mode” to “Standard” (default) (see “Adjusting pictures and sound for videos” on page 34).

The picture is not output correctly.

- ➔ Check the “Output Video Format” settings in the “Video Settings” setup (page 42).

No BD-ROM picture appears.

- ➔ Check the “BD-ROM 1080/24p Output” setting in the “Video Settings” setup (page 43).

Sound

See also “Connecting to an HDMI jack” (page 20) when connecting equipment using the HDMI cable.

There is no sound.

- ➔ Check that all the connecting cables are securely connected.
- ➔ Check whether the connecting cables are damaged.
- ➔ Check the connection to your AV amplifier (receiver) (page 19) and switch the input selector on your AV amplifier (receiver) so that the audio signals of the player are output from your AV amplifier (receiver).
- ➔ The player is in scan mode.
- ➔ If the audio signal does not come through the DIGITAL OUT (OPTICAL/COAXIAL)/HDMI OUT jack, check the audio settings (page 44).

The sound is not output correctly.

- ➔ Check the “Audio Output Priority” setting in the “Audio Settings” setup (page 44).

The sound volume is low.

- ➔ The sound volume is low on some BDs or DVDs.
- ➔ Try setting “Audio DRC” to “TV Mode” in the “Audio Settings” setup (page 45).
- ➔ Set “Audio ATT” to “Off” in the “Audio Settings” setup (page 45).

The HD Audio (Dolby digital Plus, Dolby TrueHD, DTS-HD High Resolution Audio, and DTS-HD Master Audio) is not output by bitstream.

- ➔ Set “BD Audio Setting” to “Direct” in the “Audio Settings” setup (page 44).
- ➔ Check that the connected AV amplifier (receiver) is compatible with each HD Audio format.

The interactive audio is not output.

- ➔ Set “BD Audio Setting” to “Mix” in the “Audio Settings” setup (page 44).

HDMI

There is no picture or no sound when connected to the HDMI OUT jack.

- ➔ Try the following: ① Turn the player off and on again. ② Turn the connected equipment off and on again. ③ Disconnect and then reconnect the HDMI cable.

There is no picture or picture noise appears when connected to the HDMI OUT jack.

- ➔ The HDMI OUT jack is connected to a DVI device that does not support copyright protection technology.
- ➔ If the HDMI OUT jack is used for video output, changing the video output resolution may solve the problem (page 42).

No sound is output from the HDMI OUT jack.

- ➔ The HDMI OUT jack is connected to a DVI device (DVI jacks do not accept audio signals).

The sound is not output correctly when connected to the HDMI OUT jack.

- ➔ The device connected to the HDMI OUT jack does not support the audio format of the player. Check the audio settings (page 44).

The display language on the screen switches automatically when connected to the HDMI OUT jack.

- ➔ When “Control for HDMI” is set to “On” (page 49), the display language on the screen automatically switches according to the language setting of the connected TV (if you change the setting on your TV, etc.).

The “Control for HDMI” function does not work (BRAVIA Sync).

- ➔ Check that the AC power cord of the connected component is securely connected.
- ➔ If the HDMI indicator does not appear in the front panel display, check the HDMI connection (page 15, 20).
- ➔ Set “Control for HDMI” to “On” (page 49).

- ➔ Make sure that the connected component is compatible with the “Control for HDMI” function. For details, refer to the operating instructions supplied with the component.
- ➔ Check the connected component’s setting for the “Control for HDMI” function. For details, refer to the operating instructions supplied with the component.
- ➔ If you change the HDMI connection, turn the player off and on again.
- ➔ If power failure occurs, set “Control for HDMI” to “Off,” then set “Control for HDMI” to “On” (page 49).
- ➔ For details on the “Control for HDMI” function, see “About the BRAVIA Sync features (for HDMI connections only)” (page 16).
- ➔ If you connect the player to a TV through an AV amplifier (receiver) that is not compatible with the “Control for HDMI” function, you may be unable to control the TV from the player.

External memory (local storage)

The external memory is not recognized.

- ➔ Try the following: ① Turn the player off. ② Align the ▼ mark of the EXT slot with the ▼ mark on the external memory, and insert the external memory (page 23). ③ Turn the player on. ④ Check that the EXT indicator lights up in the front panel display.

Bonus contents or other data that are contained in a BD-ROM cannot be played.

- ➔ Try the following: ① Remove the disc. ② Turn the player off. ③ Remove and re-insert the external memory (page 23). ④ Turn the player on. ⑤ Check that the EXT indicator lights up in the front panel display. ⑥ Insert the BD-ROM with BonusView.

A message indicating that the local storage does not have enough space appears on the screen.

- ➔ Delete unnecessary data in the external memory (page 33).

Operation

The remote does not function.

- ➔ The batteries in the remote are weak (page 26).
- ➔ The distance between the remote and the player is too far.
- ➔ The remote is not pointed at the remote sensor on the player.

The file name is not correctly displayed.

- ➔ The player can only display ISO 8859-1-compliant character formats. Other character formats may be displayed differently.
- ➔ Depending on the writing software used, the input characters may be displayed differently.

The disc does not start playing from the beginning.

- ➔ Resume Play is on (page 31).

Some functions such as Stop or Search cannot be performed.

- ➔ Depending on the disc, you may not be able to do some of the operations above. Refer to the operating manual supplied with the disc.

The language for the soundtrack/subtitle or angles cannot be changed.

- ➔ Try using the BD's or DVD's menu instead of the direct selection button on the remote (page 32).
- ➔ Multi-lingual tracks/subtitles or multi-angles are not recorded on the BD or DVD being played.
- ➔ The BD or DVD prohibits the changing of the language for the sound track/subtitle or angles.

The disc tray does not open and "LOCKED" or "TLK ON" appears in the front panel display.

- ➔ When "LOCKED" appears, the player is locked. To cancel the Child Lock, hold down **II** on the player until "UNLOCK" appears in the front panel display (page 10).
- ➔ When "TLK ON" appears, contact your Sony dealer or local authorized Sony service facility.

The disc tray does not open and you cannot remove the disc even after you press **⏏**.

- ➔ Try the following: ① Turn the player off, and disconnect the AC power cord. ② Reconnect the AC power cord while pressing down **⏏** on the player. ③ Keep pressing down **⏏** on the player until the tray opens. ④ Remove the disc. ⑤ When "WAIT" appears in the front panel display, hold down **I/⏏** on the player for more than 10 seconds until the player turns on again.

The player does not respond to any button.

- ➔ Moisture has condensed inside the player (page 3).
- ➔ Hold down **I/⏏** on the player for more than 10 seconds until the indicators in the front panel display turn off.
If the player still does not respond to any button, disconnect then reconnect the AC power cord.

Self-Diagnosis Function

When the self-diagnosis function is activated to prevent the player from malfunctioning, an error code appears in the front panel display, or just  appears without any messages on the entire screen.

In these cases, check the following.















When an error code appears in the front panel display

Error code	Corrective action
Exxxx SYS ERR	Contact your nearest Sony dealer or local authorized Sony service facility and give the error code.
FAN ERR	<ul style="list-style-type: none">• Check that the ventilation holes on the rear of the player are not blocked.• Place the player in a location with adequate ventilation to prevent heat build-up in the player.

When just appears without any messages on the entire screen

Contact your nearest Sony dealer or local authorized Sony service facility.

Playable Discs

Type	Disc Logo	Icon used in this manual	Characteristics
Blu-ray Disc			BD-ROMs and BD-REs/BD-Rs in BDMV and BDAV mode, including 8 cm discs (single layer) and DL discs
DVD VIDEO			Discs such as movies that can be purchased or rented
DVD	 		DVD+RWs/DVD+Rs in +VR mode or DVD-RWs/DVD-Rs in video and VR mode, including 8 cm discs (single layer) and DVD+R DL/DVD-R DL discs
DATA DVD	  		DVD+RWs/DVD+Rs/DVD-RWs/DVD-Rs containing JPEG* image files
CD			Music CDs or CD-Rs/CD-RWs in music CD format
DATA CD	—		CD-Rs/CD-RWs containing JPEG* image files

* JPEG format conforming to UDF (Universal Disk Format).

Notes about BD-ROM compatibility

Since the Blu-ray Disc specifications are new and evolving, some discs may not be playable depending on the disc type and the version. The audio output differs depending on the source, connected output jack, and selected audio settings. For details, see page 62.

Discs that cannot be played

- BDs with cartridge
- DVD-RAMs
- HD DVDs
- DVD Audio discs
- PHOTO CDs
- Data part of CD-Extras
- VCDs/Super VCDs
- HD layer on Super Audio CDs
- BD-ROMs/DVD VIDEOS with a different region code (page 59).
- A disc recorded in a color system other than NTSC, such as PAL (this player conforms to the NTSC color system).

Note on playback operations of BDs/DVDs

Some playback operations of BDs/DVDs may be intentionally set by software producers. Since this player plays BDs/DVDs according to the disc contents the software producers designed, some playback features may not be available. Refer to the instructions supplied with the BDs/DVDs.

Region code (BD-ROM/DVD VIDEO only)

Your player has a region code printed on the rear of the unit and will only play BD-ROMs/DVD VIDEOS (playback only) labeled with identical region codes. This system is used to protect copyrights.

DVD VIDEOS labeled  will also play on this player.

Depending on the BD-ROM/DVD VIDEO, no region code may be indicated even though playing the BD-ROM/DVD VIDEO is prohibited by area restrictions.

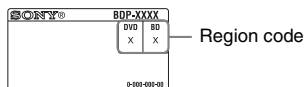

Notes about BD-REs/BD-Rs, DVD+RWs/DVD+Rs, DVD-RWs/DVD-Rs, or CD-Rs/CD-RWs

Some BD-REs/BD-Rs, DVD+RWs/DVD+Rs, DVD-RWs/DVD-Rs, or CD-Rs/CD-RWs cannot be played on this player due to the recording quality or physical condition of the disc, or the characteristics of the recording device and authoring software.

A DVD disc will not play if it has not been correctly finalized. For more information, refer to the operating instructions supplied with the recording device. Note that some playback functions may not work with some DVD+RWs/DVD+Rs, even if they have been correctly finalized. In this case, view the disc using normal playback.

Music discs encoded with copyright protection technologies

This product is designed to play back discs that conform to the Compact Disc (CD) standard. Various music discs encoded with copyright protection technologies are being marketed by some record companies. Please be aware that among those discs, there are some that do not conform to the CD standard and may not be playable by this product.

Note on DualDiscs

A DualDisc is a two sided disc product which mates DVD recorded material on one side with digital audio material on the other side.

However, since the audio material side does not conform to the Compact Disc (CD) standard, playback on this product is not guaranteed.

Note about double-layer DVDs

The playback pictures and sound may be momentarily interrupted when the layers switch.

Note about 8 cm BD-REs/8 cm BD-Rs

Some 8 cm BD-REs/8 cm BD-Rs cannot be played on this player.

Note about BD-REs/BD-Rs

This player supports Ver. 2.1 BD-RE and Ver. 1.1 and 1.2 BD-R including organic pigment type BD-R (LTH type).

Note about DTS 5.1 MUSIC DISCS

This player can play DTS 5.1 MUSIC DISCS. Audio signals are output in the formats specified under the "Audio Output Signals" table on page 62.

About playback of discs recorded in AVCHD format

This player can play AVCHD format discs.



◆ What is the AVCHD format?

The AVCHD format is a high-definition digital video camera format used to record SD (standard definition) or HD (high definition) signals of either the 1080i specification^{*1} or the 720p specification^{*2} on DVDs, using efficient data compression coding technology. The MPEG-4 AVC/H.264 format is adopted to compress video data, and the Dolby Digital or Linear PCM system is used to compress audio data. The MPEG-4 AVC/H.264 format is capable of compressing images at higher efficiency than that of the conventional image compressing format. The MPEG-4 AVC/H.264 format enables a high definition (HD) video signal shot on a digital video camera recorder to be recorded on DVD discs, in the same way as it would be for a standard definition (SD) television signal.

^{*1} A high-definition specification which utilizes 1080 effective scanning lines and the interlace system.

^{*2} A high-definition specification which utilizes 720 effective scanning lines and the progressive system.



- Some AVCHD format discs may not play, depending on the recording condition.
- The AVCHD format disc will not play if it has not been correctly finalized.

Video Output Resolution

Output resolution differs depending on the “Output Video Format” setting in the “Video Settings” setup (page 41).

Resolution setting	When “Output Video Format” is set to “HDMI”			When “Output Video Format” is set to “Component Video”		
	LINE OUT VIDEO/S VIDEO jack	COMPONENT VIDEO jack	HDMI OUT jack	LINE OUT VIDEO/S VIDEO jack	COMPONENT VIDEO jack	HDMI OUT jack
480i	480i	480i	480i	480i	480i	480i
480p	480i	480i	480p	480i	480p	480p
720p	480i	480i	720p	480i	720p*	720p*
1080i	480i	480i	1080i	480i	1080i*	1080i*
1080p	no picture	no picture	1080p	unselectable	unselectable	unselectable

* Protected contents on DVDs are output at 480p resolution.

◆ When “Output Video Format” is set to “Video or S Video”

480i video signals are output from the LINE OUT VIDEO/S VIDEO or COMPONENT VIDEO jack, and 480p video signals are output from the HDMI OUT jack.

Audio Output Signals

The audio output differs as follows, depending on the source, output jack, and the selected settings.

Disc/source		Digital				Analog
		HDMI OUT jack ^{*2}		DIGITAL OUT (OPTICAL/COAXIAL) jacks ^{*2}		LINE OUT (R-AUDIO-L) jacks
		Auto ^{*3}	2ch PCM ^{*3}	Bitstream ^{*4}	PCM	
BD	LPCM 2ch	LPCM 2ch	LPCM 2ch	LPCM 2ch	LPCM 2ch	2ch
	LPCM 5.1ch	LPCM 5.1ch	LPCM 2ch	LPCM 2ch	LPCM 2ch	2ch
	LPCM 7.1ch	LPCM 7.1ch	LPCM 2ch	LPCM 2ch	LPCM 2ch	2ch
	Dolby Digital	LPCM 5.1ch ^{*5}	LPCM 2ch	Dolby Digital/LPCM 2ch ^{*6}	LPCM 2ch	2ch
	Dolby Digital Plus	LPCM 7.1ch ^{*5}	LPCM 2ch	Dolby Digital/LPCM 2ch ^{*6}	LPCM 2ch	2ch
	Dolby TrueHD	LPCM 7.1ch ^{*5}	LPCM 2ch	Dolby Digital/LPCM 2ch ^{*6}	LPCM 2ch	2ch
	DTS	LPCM 5.1ch ^{*5}	LPCM 2ch	DTS/LPCM 2ch ^{*6}	LPCM 2ch	2ch
	DTS-HD High Resolution Audio	LPCM 5.1ch ^{*5} (DTS core)	LPCM 2ch	DTS/LPCM 2ch ^{*6}	LPCM 2ch	2ch
	DTS-HD Master Audio	LPCM 5.1ch ^{*5} (DTS core)	LPCM 2ch	DTS/LPCM 2ch ^{*6}	LPCM 2ch	2ch
DVD	LPCM	LPCM 2ch	LPCM 2ch	LPCM 2ch	LPCM 2ch	2ch
	Dolby Digital	Dolby Digital	LPCM 2ch	Dolby Digital	LPCM 2ch	2ch
	DTS	DTS	LPCM 2ch	DTS	LPCM 2ch	2ch
CD	LPCM	LPCM	LPCM 2ch	LPCM 2ch	LPCM 2ch	2ch
DTS 5.1 MUSIC DISC		DTS	LPCM 2ch	DTS	LPCM 2ch	2ch

^{*1} When “Audio Output Priority” is set to “Stereo Analog,” LPCM 2ch signals are output from each jack.

^{*2} When “Audio Output Priority” is set to “HDMI” or “Coaxial/Optical,” LPCM 2ch signals are output from jacks other than the selected jack.

^{*3} Auto: when “Audio (HDMI)” is set to “Auto” in the “Audio Settings” setup (page 44).

2ch PCM: when “Audio (HDMI)” is set to “2ch PCM” in the “Audio Settings” setup (page 44).

^{*4} Bitstream: when “Dolby Digital” is set to “Dolby Digital” or “DTS” is set to “DTS” in the “Audio Settings” setup (page 44).

^{*5} When “BD Audio Setting” is set to “Direct,” audio recorded by the source is output by bitstream. However, this audio may be output as follows depending on the audio formats supported by the AV amplifier (receiver).

– When the AV amplifier (receiver) does not support HD Audio (Dolby Digital Plus, Dolby TrueHD, DTS-HD High Resolution Audio and DTS-HD Master Audio) but supports Multi-ch LPCM, up to LPCM 7.1ch is output.

– When the AV amplifier (receiver) does not support HD Audio or Multi-ch LPCM but supports Dolby Digital/DTS, a Dolby Digital or DTS bitstream is output.

– When the AV amplifier (receiver) does not support HD Audio, Multi-ch LPCM or Dolby Digital/DTS, LPCM 2ch is output.

^{*6} The 2-channel or less-channel primary/secondary audio signals are output as LPCM 2ch signals.



When outputting 480i/480p video signals from the HDMI OUT jack, Dolby TrueHD and DTS-HD Master Audio are output as LPCM, Dolby Digital, or DTS bitstream signals even if “BD Audio Setting” is set to “Direct” in the “Audio Settings” setup (page 44).

Specifications

System

Laser: Semiconductor laser

Inputs and outputs

(Jack name:

Jack type/Output level/Load impedance)

LINE OUT R-AUDIO-L:

Phono jack/2 V_{rms}/10 kilohms

DIGITAL OUT (OPTICAL):

Optical output jack/-18 dBm
(wave length 660 nm)

DIGITAL OUT (COAXIAL):

Phono jack/0.5 V_p-p/75 ohms

HDMI OUT:

HDMI 19-pin standard connector

COMPONENT VIDEO OUT (Y, P_B, P_R):

Phono jack/Y: 1.0 V_p-p/
P_B, P_R: 0.7 V_p-p/75 ohms

LINE OUT VIDEO:

Phono jack/1.0 V_p-p/75 ohms

LINE OUT S VIDEO:

4-pin mini DIN/
Y: 1.0 V_p-p, C: 0.286 V_p-p/75 ohms

LAN (100):

100BASE-TX Terminal

EXT:

External memory slot (For connecting the
external memory)
DC output: 5 V 500 mA Max

General

Power requirements:

120 V AC, 60 Hz

Power consumption:

26 W

Dimensions (approx.):

430 mm × 220 mm × 60 mm
(17 in. × 8 3/4 in. × 2 3/8 in.)
(width/depth/height) incl. projecting parts

Mass (approx.):

2.9 kg (6 3/8 lb)

Operating temperature:

5 °C to 35 °C (41 °F to 95 °F)

Operating humidity:

25 % to 80 %

Supplied accessories

See page 13.

Specifications and design are subject to
change without notice.

Language Code List

For details, see page 46.

The language spellings conform to the ISO 639: 1988 (E/F) standard.

Number, Language (BD Language Code/DVD Language Code)

1027, Afar (aar/aa)	1194, Galician (glg/gl)	1350, Malayalam (mal/ml)	1506, Slovenian (slv/sl)
1028, Abkhazian (abk/ab)	1196, Guarani (grn/gn)	1352, Mongolian (mon/mn)	1507, Samoan (smo/sm)
1032, Afrikaans (afr/af)	1203, Gujarati (gu/gu)	1353, Moldavian (mol/mo)	1508, Shona (sna/sn)
1039, Amharic (amh/am)	1209, Hausa (hau/ha)	1356, Marathi (mar/mr)	1509, Somali (som/so)
1044, Arabic (ara/ar)	1217, Hindi (hin/hi)	1357, Malay (msa/ms)	1511, Albanian (sqi/sq)
1045, Assamese (asm/as)	1226, Croatian (hrv/hr)	1358, Malese; Maltese (mlt/mt)	1512, Serbian (srp/sr)
1051, Aymara (aym/ay)	1229, Hungarian (hun/hu)	1363, Burmese (mya/my)	1513, Siswati; Swati (ssw/ss)
1052, Azerbaijani (aze/az)	1233, Armenian (hye/hy)	1365, Nauru (nau/na)	1514, Sesotho; Sotho southern (sot/st)
1053, Bashkir (bak/ba)	1235, Interlingua (ina/ia)	1369, Nepali (nep/ne)	1515, Sundanese (sun/su)
1057, Byelorussian (bel/be)	1239, Interlingue (ile/ie)	1376, Dutch (nld/nl)	1516, Swedish (swe/sv)
1059, Bulgarian (bul/bg)	1248, Indonesian (ind/id)	1379, Norwegian (nor/no)	1517, Swahili (swa/sw)
1060, Bihari (bih/bh)	1253, Icelandic (isl/is)	1393, Occitan (oci/oc)	1521, Tamil (tam/ta)
1061, Bislama (bis/bi)	1254, Italian (ita/it)	1403, Oromo (orm/om)	1525, Telugu (tel/te)
1066, Bengali (ben/bn)	1257, Hebrew (heb/he)	1408, Oriya (ori/or)	1527, Tajik (tgk/tg)
1067, Tibetan (bod/bo)	1261, Japanese (jpn/ja)	1417, Punjabi; Panjabi (pan/pa)	1528, Thai (tha/th)
1070, Breton (bre/br)	1269, Yiddish (yid/yi)	1428, Polish (pol/pl)	1529, Tigrinya (tir/ti)
1079, Catalan (cat/ca)	1283, Javanese (jav/jv)	1435, Pashto; Pushto (pus/ps)	1531, Turkmen (tuk/tk)
1093, Corsican (cos/co)	1287, Georgian (kat/ka)	1436, Portuguese (por/pt)	1532, Tagalog (tgl/tl)
1097, Czech (ces/cs)	1297, Kazakh (kaz/kk)	1463, Quechua (que/qu)	1534, Setswana; Tswana (tsn/tn)
1103, Welsh (cym/cy)	1298, Greenlandic; Kalaallisut (kal/kl)	1481, Rhaeto-Romance (roh/rm)	1535, Tonga; Tonga islands (ton/to)
1105, Danish (dan/da)	1299, Cambodian; Khmer (khm/km)	1482, Kirundi; Rundi (run/rn)	1538, Turkish (tur/tr)
1109, German (deu/de)	1300, Kannada (kan/kn)	1483, Romanian (ron/ro)	1539, Tsonga (tso/ts)
1130, Bhutani; Dzongkha (dzo/dz)	1301, Korean (kor/ko)	1489, Russian (rus/ru)	1540, Tatar (tat/tt)
1142, Greek (ell/el)	1305, Kashmiri (kas/ks)	1491, Kinyarwanda (kin/rw)	1543, Twi (twi/tw)
1144, English (eng/en)	1307, Kurdish (kur/ku)	1495, Sanskrit (san/sa)	1557, Ukrainian (ukr/uk)
1145, Esperanto (epo/eo)	1311, Kirghiz (kir/ky)	1498, Sindhi (snd/sd)	1564, Urdu (urd/ur)
1149, Spanish (spa/es)	1313, Latin (lat/la)	1501, Sangho; Sango (sag/sg)	1572, Uzbek (uzb/uz)
1150, Estonian (est/et)	1326, Lingala (lin/ln)	1502, Serbo-Croatian (scr/hr)	1581, Vietnamese (vie/vi)
1151, Basque (eus/eu)	1327, Laothian; Lao (lao/lo)	1503, Sinhalese; Sinhalese (sin/si)	1587, Volapük (vol/vo)
1157, Persian (fas/fa)	1332, Lithuanian (lit/lt)	1505, Slovak (slk/sk)	1613, Wolof (wol/wo)
1165, Finnish (fin/fi)	1334, Latvian (lav/lv)		1632, Xhosa (xho/xh)
1166, Fiji (fij/fj)	1345, Malagasy (mlg/mg)		1665, Yoruba (yor/yr)
1171, Faroese (fao/fo)	1347, Maori (mri/mi)		1684, Chinese (zho/zh)
1174, French (fra/fr)	1349, Macedonian (mkd/mk)		1697, Zulu (zul/zu)
1181, Frisian (fry/fy)			1703, not specified
1183, Irish (gle/ga)			
1186, Scots Gaelic (gla/gd)			

Parental Control/Area Code

For details, see page 46.

Number, Area (Code)

2044, Argentina (ar)	2200, Greece (gr)	2379, Norway (no)
2047, Australia (au)	2219, Hong Kong (hk)	2427, Pakistan (pk)
2046, Austria (at)	2248, India (in)	2424, Philippines (ph)
2057, Belgium (be)	2238, Indonesia (id)	2428, Poland (pl)
2070, Brazil (br)	2239, Ireland (ie)	2436, Portugal (pt)
2079, Canada (ca)	2254, Italy (it)	2489, Russia (ru)
2090, Chile (cl)	2276, Japan (jp)	2501, Singapore (sg)
2092, China (cn)	2304, Korea (kr)	2149, Spain (es)
2093, Colombia (co)	2333, Luxembourg (lu)	2499, Sweden (se)
2115, Denmark (dk)	2363, Malaysia (my)	2086, Switzerland (ch)
2165, Finland (fi)	2362, Mexico (mx)	2543, Taiwan (tw)
2174, France (fr)	2376, Netherlands (nl)	2528, Thailand (th)
2109, Germany (de)	2390, New Zealand (nz)	2184, United Kingdom (gb)

Terms and Conditions of Use and End User License Agreement

The Sony Blu-ray Disc player ("Product") and associated software ("Software") are provided and maintained by Sony Electronics Inc. and its affiliates ("Sony"). Sony also provides and maintains associated service (the "Service"), including any subsite accessible through the Service's Internet homepage (the "Site"). The Software includes software embedded in the Product; stored on any media, bundled with the Product or otherwise provided by Sony; downloaded from the Site or otherwise made accessible or provided by Sony; any such media and any printed or "on-line" or electronic documentation associated with the Product and all updates and upgrades thereto.

WHEN YOU ACCESS, BROWSE, OR USE THE SERVICE, PRODUCT, SOFTWARE, AND/OR SITE, YOU ACCEPT, WITHOUT LIMITATION OR QUALIFICATION, THE TERMS AND CONDITIONS SET FORTH HEREIN, SONY'S PRIVACY POLICY POSTED ON THE SITE, AND ANY ADDITIONAL TERMS AND CONDITIONS OF USE SET FORTH IN ANY PORTION OF THE SERVICE AND SITE (COLLECTIVELY THE "AGREEMENT"). IF YOU DO NOT AGREE WITH THE TERMS AND CONDITIONS OF THIS AGREEMENT, SONY DOES NOT GRANT THE LIMITED RIGHTS HEREIN, AND PLEASE DO NOT USE THE SERVICE, PRODUCT, SOFTWARE, AND/OR SITE.

1. Ownership

The Software and all materials on the Service and/or Site, including but not limited to images, software and text (the "Content") are protected by copyright under U.S. copyright law, international conventions, and other copyright laws. You cannot use the Software, Service, Product, Content, and Site except as specified herein. There may be proprietary logos, service marks, and trademarks found on this Service or Site. By making them available on the Service and/or Site, Sony is not granting you any license to utilize those proprietary logos, service marks, or trademarks. Any unauthorized use of the Service, Site, Content or Software may violate copyright laws, trademark laws, the laws of privacy and publicity, and civil and criminal statutes. All title and copyright in and to the Software or materials on the Service/Site and any copies of the Software, are owned by Sony, its licensors, or suppliers. All rights not specifically granted under this Agreement are reserved by Sony, its licensors, and suppliers.

2. Your Rights & Limited License

The Service, Site, Software, Content, and Product are only for your personal use. You are responsible for all your activities hereunder, including all legal liability incurred from your use of the Service or others who use the Service via your Product or Account (as defined below). You may use the Service, Site, Software, Content and Product for lawful purposes only. You may not distribute, exchange, modify, sell, or transmit anything you may copy from the Service or Site, including but not limited to any text, images, audio, and video, for any business, commercial, or public purpose. As long as you comply with the terms of this Agreement, Sony grants you a non-exclusive, non-transferable, limited right to enter, display, and use the Service, Site, and Software as set forth in this Agreement. You agree not to interrupt/disrupt or attempt to interrupt/disrupt the operation of this Service, Site or Software in any way.

3. User Account & Privacy

As part of your usage of the Product, Service, Site, and/or Software, Sony may require that you establish a user account ("Account") for which you must provide Sony true, accurate, current, and complete information about yourself and maintain/promptly update such information. You are responsible for maintaining the confidentiality of any and all of your passwords associated with the Account. You agree to notify Sony immediately of any unauthorized use of your password or any

other breach of security related to the Service, Site, and/or Software.

Sony's Privacy Policy is posted on the Site and at <http://products.sel.sony.com/SEL/legal/privacy.html>, the terms of which are incorporated herein, and applies to your use of the Account, Product, Service, Site, and Software.

4. Automatic Update

The Software contains a functionality by which it is updated automatically when the Product is connected to a server belonging to Sony or to a third party designated by Sony. When you specify your intention not to use this automatic update functionality, or when the setting asking whether you wish to update automatically is activated and you decline to execute updates, it is assumed that you agree that the security functionality improvements, error corrections, other functional updates or any other changes offered by Sony through such updates would not be made to the Software and that your current and further use of the Software may be affected thereby.

When the automatic update functionality described in the previous paragraph is activated, it is assumed that you agree (a) that the Software will be automatically updated as necessary to improve security functionality, to correct errors, to improve update functionality, or for other purposes, and (b) that this updating of the Software may be accompanied by the augmenting, modifying, or removing of functionality of the Software.

5. Additional Terms Governing Product Software

You may use the Software solely in conjunction with the Product that accompanied the Software. The Software is licensed, not sold. In addition to the terms set forth in other portions of this Agreement, the Software is subject to the following:

Use of Software. You may use the Software in conjunction with the Product for personal use.

Limitation on Reverse Engineering, Decompilation and Disassembly. You may not modify, reverse engineer, decompile, or disassemble the Software in whole or in part. Separation of Components. The Software is licensed as a single product. Its component parts may not be separated for use on more than one device unless expressly authorized by Sony.

Data Files. The Software may create data files automatically for use with the Software. Any such data files will be deemed as part of the Software.

Rental. You may not rent or lease the Software.

Software Transfer. You may permanently transfer all of your rights under this Agreement only as part of a sale or transfer of Software accompanying the sale or transfer of your Product, provided you retain no copies, transfer all of the Software (including all copies, component parts, the media and printed materials, all versions and any upgrades of the Software and this Agreement), and the recipient agrees to the terms of this Agreement.

Dependent Software. The software, network services or other products other than Software upon which the Software's performance depends on might be interrupted or discontinued at the discretion of the suppliers (software suppliers, service providers or Sony).

High Risk Activities. The Software is not fault-tolerant and is not designed, manufactured or intended for use or resale as on-line control equipment in hazardous environments requiring fail-safe performance, such as in the operation of nuclear facilities, aircraft navigation or communication systems, air traffic control, direct life support machines, or weapons systems, in which the failure of the Software could lead to death, personal injury, or severe physical or environmental damage ("High Risk Activities"). Sony and its suppliers specifically disclaim any express or implied warranty of fitness for High Risk Activities.

U.S. Government Restricted Rights. The Software is provided with RESTRICTED RIGHTS. Use, duplication, or disclosure by the United States Government is subject to restriction as set forth in subparagraph (c) (1) and (2) of the Commercial Computer Software-Restricted Rights at 48 CFR 52.227-19, as applicable. Manufacturer is Sony Electronics Inc., 16530 Via Esprillo, San Diego, CA 92127.

GNU General Public, Lesser General Public, & Other Licenses.

Notwithstanding terms in this Agreement, certain portions of the Software are governed by the GNU Lesser General Public License, Version 2.1 (LGPL), GNU General Public License Version 2 (GPL), and other open source code licenses ("Open Source Licenses"), copies of which are attached hereto and incorporated herein. For such portions of the Software, to the extent there is any conflict between this Agreement and the Open Source Licenses, the Open Source Licenses shall govern as applicable.

Certain Source Code Availability. Sony is making available the source code of certain portions of the SOFTWARE per the GPL/LGPL LICENSES. Please see <http://www.sony.com/linux> for access to and instructions on obtaining such source code.

6. Changes to Service

Sony reserves the right to discontinue one, some, or all of the features of the Service you receive at any time at its discretion. Sony may, at its discretion and from time to time change, add or remove features and functionality, upgrade or modify the Service, Site and/or Software without notice. You may, at Sony's discretion, receive messages regarding these changes and new features/functionality. Any new text, content, file, data, product, services, information, software, software tool or other feature provided by Sony (through the network or by CD-ROM or other means) (including, but not limited to, any update to Software provided to you automatically pursuant to Section 4 of this Agreement) will be subject to this Agreement; provided that, if separate terms and conditions applicable to such feature are provided to you, such terms and conditions shall apply to such feature in priority to this Agreement.

7. Confidentiality

You shall maintain the confidentiality of any information with regard to the Product and Documentation that is provided under this Agreement and is not publicly known. You agree not to disclose such information to any third party without the prior written consent.

8. Sony's Right to Terminate or Modify Terms or Conditions of this Agreement

Sony may add to, change, or remove any part, term, or condition of this Agreement at any time, without prior notice. Any changes to this Agreement or any terms posted on the Service and/or Site apply as soon as they are posted. By continuing to use the Service, Product, Software and/or Site after any changes are posted, you are indicating your acceptance of those changes. SONY MAY ADD, CHANGE, DISCONTINUE, REMOVE, OR SUSPEND ANY OTHER CONTENT POSTED ON THE SERVICE AND/OR SITE, INCLUDING FEATURES AND SPECIFICATIONS OF PRODUCTS DESCRIBED OR DEPICTED ON THE SERVICE AND/OR SITE, TEMPORARILY OR PERMANENTLY, AT ANY TIME, WITHOUT NOTICE AND WITHOUT LIABILITY. WITHOUT PREJUDICE TO ANY OTHER RIGHTS, SONY MAY SUSPEND OR TERMINATE THIS AGREEMENT IMMEDIATELY UPON NOTICE IF YOU FAIL TO COMPLY WITH THE TERMS AND CONDITIONS OF THIS AGREEMENT. Upon termination, you shall destroy the Software within fourteen (14) days after the date of such termination, and upon Sony's request, provide Sony with the certification of such destruction. Sony may take any legal and technical remedies to prevent the violation of and/or to enforce this Agreement, including without limitation, immediate termination of your access to the Service if we believe in our discretion you are violating this Agreement.

9. Indemnification

You agree to indemnify, defend, and hold Sony and all of its agents, directors, employees, information providers, licensors and licensees, affiliates, content providers, officers, and parent (collectively, "Indemnified Parties"), harmless from and against any and all liability and costs (including, without limitation, attorneys' fees and costs), incurred by the Indemnified Parties in connection with any claim arising out of (i) any breach or alleged breach by you of this Agreement in any manner, (ii) any information you submit to Sony hereunder, (iii) any breach or alleged breach by you of a third party's rights or (iv) any damage caused by or alleged to have been caused by you to the Service. You will cooperate as fully as reasonably required in Indemnified Party(s) defense of any claim. Sony and/or Indemnified Parties reserve the right, at its own expense, to assume the exclusive defense and control of any matter otherwise subject to indemnification by you and you shall not in any event settle any matter without the written consent of Sony and/or Indemnified Parties.

10. DISCLAIMER OF WARRANTIES AND DAMAGES; LIMITATION OF LIABILITY

YOU UNDERSTAND THAT USAGE OF THE PRODUCT AND SERVICE REQUIRES INTERNET SERVICE PROVIDED BY YOU, FOR WHICH YOU ARE SOLELY RESPONSIBLE. OPERATION OF THE PRODUCT AND/OR SERVICE MAY BE LIMITED OR RESTRICTED DEPENDING UPON THE CAPABILITIES OR TECHNICAL LIMITATIONS OF YOUR INTERNET SERVICE.

YOUR USE OF THE SOFTWARE, SERVICE, PRODUCT, CONTENT AND/OR SITE IS AT YOUR OWN RISK. THE SOFTWARE, SERVICE, CONTENT AND SITE ARE PROVIDED "AS IS" AND, TO THE FULLEST EXTENT PERMISSIBLE BY LAW, SONY MAKES NO REPRESENTATIONS OR WARRANTIES OF ANY KIND WHATSOEVER (1) FOR THE ACCURACY, MERCHANTABILITY, FITNESS FOR A PARTICULAR PURPOSE, OR NON-INFRINGEMENT ASSOCIATED WITH THE SERVICE, SITE, AND/OR SOFTWARE; (2) THAT THE SERVER(S) THAT MAKES THE SERVICE, SOFTWARE, AND/OR SITE AVAILABLE ARE FREE OF VIRUSES OR OTHER COMPONENTS THAT MAY INFECT, HARM, OR CAUSE DAMAGE TO YOUR COMPUTER, TELEVISION, OTHER EQUIPMENT, OR ANY OTHER PROPERTY. FURTHERMORE, SONY DOES NOT WARRANT OR MAKE ANY REPRESENTATIONS REGARDING THE USE OR THE RESULTS OF THE USE OF THE SOFTWARE, SERVICE, AND/OR SITE IN TERMS OF ITS CORRECTNESS, ACCURACY, RELIABILITY, OR OTHERWISE. NO ORAL OR WRITTEN INFORMATION OR ADVICE GIVEN BY SONY OR A SONY AUTHORIZED REPRESENTATIVE SHALL CREATE A WARRANTY OR IN ANY WAY INCREASE THE SCOPE OF THIS WARRANTY. SHOULD THE SOFTWARE, SERVICE, AND/OR SITE PROVE DEFECTIVE YOU (AND NOT SONY OR A SONY AUTHORIZED REPRESENTATIVE) ASSUME THE ENTIRE COST OF ALL NECESSARY SERVICING, REPAIR OR CORRECTION.

UNDER NO CIRCUMSTANCES, INCLUDING BUT NOT LIMITED TO SONY'S NEGLIGENCE OR ISSUES RELATED TO THIRD PARTY CONTENT PROVIDERS, SHALL SONY BE LIABLE FOR ANY CONSEQUENTIAL, DIRECT, INCIDENTAL, INDIRECT, PUNITIVE, OR SPECIAL DAMAGES RELATED TO (A) THE USE OF, (B) THE INABILITY TO USE, OR (C) ERRORS OR OMISSIONS IN THE SOFTWARE, SERVICE, PRODUCT, AND/OR SITE, EVEN IF SONY OR AN AUTHORIZED REPRESENTATIVE THEREOF HAS BEEN ADVISED OF THE POSSIBILITY OF SUCH DAMAGES. SOME STATES DO NOT ALLOW THE EXCLUSION OR LIMITATION OF CONSEQUENTIAL OR INCIDENTAL DAMAGES, SO THE ABOVE LIMITATION OR EXCLUSION MAY NOT APPLY TO YOU. IN NO EVENT SHALL SONY'S TOTAL LIABILITY TO YOU FOR ALL DAMAGES, LOSSES, AND CAUSES OF ACTION (WHETHER IN CONTRACT OR TORT, INCLUDING, BUT NOT LIMITED TO, NEGLIGENCE OR OTHERWISE) EXCEED \$100.00.

11. General Provisions

This Agreement, the limited warranty accompanying the Product, plus any additional terms posted on the Service or Site, together constitute the entire agreement between Sony and you with respect to your use of the Product, Service, Site, Content, and Software. Any notice by Sony hereunder may be made by letter, email, or posting on the Service or Site. Any cause of action you may have with respect to your use of this Site must be commenced within one (1) year after the claim or cause of action arises. If for any reason a court of competent jurisdiction finds any provision of this Agreement, or portion thereof, to be unenforceable, that provision shall be enforced to the maximum extent permissible so as to affect the intent of this Agreement, and the remaining terms and conditions of the Agreement shall continue in full force and effect. This Agreement shall be governed by and construed in accordance with the laws of the State of Delaware, United States of America, without reference to its conflicts of law rules. You agree to submit to the personal and exclusive jurisdiction of federal or state courts in Delaware.

Software License Information

Required public statement & License for GPL/LGPL licensed software used in this product

This product contains software that is subject to the following GNU General Public License ("GPL") or GNU Lesser General Public License ("LGPL"). These establish that customers have the right to acquire, modify, and redistribute the source code of said software in accordance with the terms of the GPL or the LGPL.

Package List

```
linux-kernel.tar.gz
pump
lrzsz
busybox
gcc
glibc
netbase
dosfstools
lzo
mkcramfs
hostname
scfs
```

The source code for the above-listed software is available on the Web.

To download, please access the following URL:

<http://www.sony.net/Products/Linux>

Please note that Sony cannot answer or respond to any inquiries regarding the content of this source code.

GNU GENERAL PUBLIC LICENSE

Version 2, June 1991

Copyright (C) 1989, 1991 Free Software Foundation, Inc.

51 Franklin Street, Fifth Floor, Boston, MA 02110-1301 USA

Everyone is permitted to copy and distribute verbatim copies of this license document, but changing it is not allowed.

Preamble

The Licenses for most software are designed to take away your freedom to share and change it. By contrast, the GNU General Public License is intended to guarantee your freedom to share and change free software—to make sure the software is free for all its users. This General Public License applies to most of the Free Software Foundation's software and to any other program whose authors commit to using it. (Some other Free Software Foundation software is covered by the GNU Lesser General Public License instead.) You can apply it to your programs, too.

When we speak of free software, we are referring to freedom, not price. Our General Public Licenses are designed to make sure that you have the freedom to distribute copies of free software (and charge for this service if you wish), that you receive source code or can get it if you want it, that you can change the software or use pieces of it in new free programs; and that you know you can do these things.

To protect your rights, we need to make restrictions that forbid anyone to deny you these rights or to ask you to surrender the rights. These restrictions translate to certain responsibilities for you if you distribute copies of the software, or if you modify it.

For example, if you distribute copies of such a program, whether gratis or for a fee, you must give the recipients all the rights that you have. You must make sure that they, too, receive or can get the source code. And you must show them these terms so they know their rights.

We protect your rights with two steps: (1) copyright the software, and (2) offer you this license which gives you legal permission to copy, distribute and/or modify the software.

Also, for each author's protection and ours, we want to make certain that everyone understands that there is no warranty for this free software. If the software is modified by someone else and passed on, we want its recipients to know that what they have is not the original, so that any problems introduced by others will not reflect on the original authors' reputations.

Finally, any free program is threatened constantly by software patents. We wish to avoid the danger that redistributors of a free program will individually obtain patent licenses, in effect making the program proprietary. To prevent this, we have made it clear that any patent must be licensed for everyone's free use or not licensed at all.

The precise terms and conditions for copying, distribution and modification follow.

GNU GENERAL PUBLIC LICENSE TERMS AND CONDITIONS FOR COPYING, DISTRIBUTION AND MODIFICATION

0. This License applies to any program or other work which contains a notice placed by the copyright holder saying it may be distributed under the terms of this General Public License. The "Program", below, refers to any such program or work, and a "work based on the Program" means either the Program or any derivative work under copyright law: that is to say, a work containing the Program or a portion of it, either verbatim or with modifications and/or translated into another language. (Hereinafter, translation is included without limitation in the term "modification".) Each licensee is addressed as "you".

Activities other than copying, distribution and modification are not covered by this License; they are outside its scope. The act of running the Program is not restricted, and the output from the Program is covered only if its contents constitute a work based on the Program (independent of having been made by running the Program). Whether that is true depends on what the Program does.

1. You may copy and distribute verbatim copies of the Program's source code as you receive it, in any medium, provided that you conspicuously and appropriately publish on each copy an appropriate copyright notice and disclaimer of warranty; keep intact all the notices that refer to this License and to the absence of any warranty; and give any other recipients of the Program a copy of this License along with the Program.

You may charge a fee for the physical act of transferring a copy, and you may at your option offer warranty protection in exchange for a fee.

2. You may modify your copy or copies of the Program or any portion of it, thus forming a work based on the Program, and copy and distribute such modifications or work under the terms of Section 1 above, provided that you also meet all of these conditions:

- a) You must cause the modified files to carry prominent notices stating that you changed the files and the date of any change.
- b) You must cause any work that you distribute or publish, that in whole or in part contains or is derived from the Program or any part thereof, to be licensed as a whole at no charge to all third parties under the terms of this License.
- c) If the modified program normally reads commands interactively when run, you must cause it, when started running for such interactive use in the most ordinary way, to print or display an announcement including an appropriate copyright notice and a notice that there is no warranty (or else, saying that you provide a warranty) and that users may redistribute the program under these conditions, and telling the user how to view a copy of this License. (Exception: if the Program itself is interactive but does not normally print such an announcement, your work based on the Program is not required to print an announcement.)

These requirements apply to the modified work as a whole. If identifiable sections of that work are not derived from the Program, and can be reasonably considered independent and separate works in themselves, then this License, and its terms, do not apply to those sections when you distribute them as separate works. But when you distribute the same sections as part of a whole which is a work based on the Program, the distribution of the whole must be on the terms of this License, whose permissions for other licensees extend to the entire whole, and thus to each and every part regardless of who wrote it.

Thus, it is not the intent of this section to claim rights or contest your rights to work written entirely by you; rather, the intent is to exercise the right to control the distribution of derivative or collective works based on the Program.

In addition, mere aggregation of another work not based on the Program with the Program (or with a work based on the Program) on a volume of a storage or distribution medium does not bring the other work under the scope of this License.

3. You may copy and distribute the Program (or a work based on it, under Section 2) in object code or executable form under the terms of Sections 1 and 2 above provided that you also do one of the following:
 - a) Accompany it with the complete corresponding machine-readable source code, which must be distributed under the terms of Sections 1 and 2 above on a medium customarily used for software interchange; or,
 - b) Accompany it with a written offer, valid for at least three years, to give any third party, for a charge no more than your cost of physically performing source distribution, a complete machine-readable copy of the corresponding source code, to be distributed under the terms of Sections 1 and 2 above on a medium customarily used for software interchange; or,
 - c) Accompany it with the information you received as to the offer to distribute corresponding source code. (This alternative is allowed only for noncommercial distribution and only if you received the program in object code or executable form with such an offer, in accord with Subsection b above.)

The source code for a work means the preferred form of the work for making modifications to it. For an executable work, complete source code means all the source code for all modules it contains, plus any associated interface definition files, plus the scripts used to control compilation and installation of the executable. However, as a special exception, the source code distributed need not include anything that is normally distributed (in either source or binary form) with the major components (compiler, kernel, and so on) of the operating system on which the executable runs, unless that component itself accompanies the executable.

If distribution of executable or object code is made by offering access to copy from a designated place, then offering equivalent access to copy the source code from the same place counts as distribution of the source code, even though third parties are not compelled to copy the source along with the object code.

4. You may not copy, modify, sublicense, or distribute the Program except as expressly provided under this License. Any attempt otherwise to copy, modify, sublicense or distribute the Program is void, and will automatically terminate your rights under this License. However, parties who have received copies, or rights, from you under this License will not have their licenses terminated so long as such parties remain in full compliance.
5. You are not required to accept this License, since you have not signed it. However, nothing else grants you permission to modify or distribute the Program or its derivative works. These actions are prohibited by law if you do not accept this License. Therefore, by modifying or distributing the Program (or any work based on the Program), you indicate your acceptance of this License to do so, and all its terms and conditions for copying, distributing or modifying the Program or works based on it.

6. Each time you redistribute the Program (or any work based on the Program), the recipient automatically receives a license from the original licensor to copy, distribute or modify the Program subject to these terms and conditions. You may not impose any further restrictions on the recipients' exercise of the rights granted herein. You are not responsible for enforcing compliance by third parties with this License.
7. If, as a consequence of a court judgment or allegation of patent infringement or for any other reason (not limited to patent issues), conditions are imposed on you (whether by court order, agreement or otherwise) that contradict the conditions of this License, they do not excuse you from the conditions of this License. If you cannot distribute so as to satisfy simultaneously your obligations under this License and any other pertinent obligations, then as a consequence you may not distribute the Program at all. For example, if a patent license would not permit royalty-free redistribution of the Program by all those who receive copies directly or indirectly through you, then the only way you could satisfy both it and this License would be to refrain entirely from distribution of the Program.

If any portion of this section is held invalid or unenforceable under any particular circumstance, the balance of the section is intended to apply and the section as a whole is intended to apply in other circumstances.

It is not the purpose of this section to induce you to infringe any patents or other property right claims or to contest validity of any such claims; this section has the sole purpose of protecting the integrity of the free software distribution system, which is implemented by public license practices. Many people have made generous contributions to the wide range of software distributed through that system in reliance on consistent application of that system; it is up to the author/donor to decide if he or she is willing to distribute software through any other system and a licensee cannot impose that choice.

This section is intended to make thoroughly clear what is believed to be a consequence of the rest of this License.

8. If the distribution and/or use of the Program is restricted in certain countries either by patents or by copyrighted interfaces, the original copyright holder who places the Program under this License may add an explicit geographical distribution limitation excluding those countries, so that distribution is permitted only in or among countries not thus excluded. In such case, this License incorporates the limitation as if written in the body of this License.
9. The Free Software Foundation may publish revised and/or new versions of the General Public License from time to time. Such new versions will be similar in spirit to the present version, but may differ in detail to address new problems or concerns.

Each version is given a distinguishing version number. If the Program specifies a version number of this License which applies to it and "any later version", you have the option of following the terms and conditions either of that version or of any later version published by the Free Software Foundation. If the Program does not specify a version number of this License, you may choose any version ever published by the Free Software Foundation.

10. If you wish to incorporate parts of the Program into other free programs whose distribution conditions are different, write to the author to ask for permission. For software which is copyrighted by the Free Software Foundation, write to the Free Software Foundation; we sometimes make exceptions for this. Our decision will be guided by the two goals of preserving the free status of all derivatives of our free software and of promoting the sharing and reuse of software generally.

NO WARRANTY

11. BECAUSE THE PROGRAM IS LICENSED FREE OF CHARGE, THERE IS NO WARRANTY FOR THE PROGRAM, TO THE EXTENT PERMITTED BY APPLICABLE LAW. EXCEPT WHEN OTHERWISE STATED IN WRITING THE COPYRIGHT HOLDERS AND/OR OTHER PARTIES PROVIDE THE PROGRAM "AS IS" WITHOUT WARRANTY OF ANY KIND, EITHER EXPRESSED OR IMPLIED, INCLUDING, BUT NOT LIMITED TO, THE IMPLIED WARRANTIES OF MERCHANTABILITY AND FITNESS FOR A PARTICULAR PURPOSE. THE ENTIRE RISK AS TO THE QUALITY AND PERFORMANCE OF THE PROGRAM IS WITH YOU. SHOULD THE PROGRAM PROVE DEFECTIVE, YOU ASSUME THE COST OF ALL NECESSARY SERVICING, REPAIR OR CORRECTION.
12. IN NO EVENT UNLESS REQUIRED BY APPLICABLE LAW OR AGREED TO IN WRITING WILL ANY COPYRIGHT HOLDER, OR ANY OTHER PARTY WHO MAY MODIFY AND/OR REDISTRIBUTE THE PROGRAM AS PERMITTED ABOVE, BE LIABLE TO YOU FOR DAMAGES, INCLUDING ANY GENERAL, SPECIAL, INCIDENTAL OR CONSEQUENTIAL DAMAGES ARISING OUT OF THE USE OR INABILITY TO USE THE PROGRAM (INCLUDING BUT NOT LIMITED TO LOSS OF DATA OR DATA BEING RENDERED INACCURATE OR LOSSES SUSTAINED BY YOU OR THIRD PARTIES OR A FAILURE OF THE PROGRAM TO OPERATE WITH ANY OTHER PROGRAMS), EVEN IF SUCH HOLDER OR OTHER PARTY HAS BEEN ADVISED OF THE POSSIBILITY OF SUCH DAMAGES.

END OF TERMS AND CONDITIONS

How to Apply These Terms to Your New Programs

If you develop a new program, and you want it to be of the greatest possible use to the public, the best way to achieve this is to make it free software which everyone can redistribute and change under these terms.

To do so, attach the following notices to the program. It is safest to attach them to the start of each source file to most effectively convey the exclusion of warranty; and each file should have at least the "copyright" line and a pointer to where the full notice is found.

<one line to give the program's name and an idea of what it does.>

Copyright (C) <year> <name of author>

This program is free software; you can redistribute it and/or modify it under the terms of the GNU General Public License as published by the Free Software Foundation; either version 2 of the License, or (at your option) any later version.

This program is distributed in the hope that it will be useful, but WITHOUT ANY WARRANTY; without even the implied warranty of MERCHANTABILITY or FITNESS FOR A PARTICULAR PURPOSE. See the GNU General Public License for more details.

You should have received a copy of the GNU General Public License along with this program; if not, write to the Free Software Foundation, Inc., 59 Temple Place - Suite 330, Boston, MA 02111-1307, USA.

Also add information on how to contact you by electronic and paper mail.

If the program is interactive, make it output a short notice like this when it starts in an interactive mode:

Gnomovision version 69, Copyright (C) year name of author
Gnomovision comes with ABSOLUTELY NO WARRANTY;
for details type 'show w'. This is free software, and you are
welcome to redistribute it under certain conditions; type 'show
c' for details.

The hypothetical commands 'show w' and 'show c' should show the appropriate parts of the General Public License. Of course, the commands you use may be called something other than 'show w' and 'show c'; they could even be mouse-clicks or menu items--whatever suits your program.

You should also get your employer (if you work as a programmer) or your school, if any, to sign a "copyright disclaimer" for the program, if necessary. Here is a sample; alter the names:

Yoodyne, Inc., hereby disclaims all copyright interest in the program 'Gnomovision' (which makes passes at compilers) written by James Hacker.

<signature of Ty Coon>, 1 April 1989
Ty Coon, President of Vice

This General Public License does not permit incorporating your program into proprietary programs. If your program is a subroutine library, you may consider it more useful to permit linking proprietary applications with the library. If this is what you want to do, use the GNU Lesser General Public License instead of this License.

GNU LESSER GENERAL PUBLIC LICENSE

Version 2.1, February 1999

Copyright (C) 1991, 1999 Free Software Foundation, Inc.
51 Franklin Street, Fifth Floor, Boston, MA 02110-1301 USA
Everyone is permitted to copy and distribute verbatim copies of this license document, but changing it is not allowed.

[This is the first released version of the Lesser GPL. It also counts as the successor of the GNU Library Public License, version 2, hence the version number 2.1.]

Preamble

The licenses for most software are designed to take away your freedom to share and change it. By contrast, the GNU General Public Licenses are intended to guarantee your freedom to share and change free software--to make sure the software is free for all its users.

This license, the Lesser General Public License, applies to some specially designated software packages--typically libraries--of the Free Software Foundation and other authors who decide to use it. You can use it too, but we suggest you first think carefully about whether this license or the ordinary General Public License is the better strategy to use in any particular case, based on the explanations below.

When we speak of free software, we are referring to freedom of use, not price. Our General Public Licenses are designed to make sure that you have the freedom to distribute copies of free software (and charge for this service if you wish); that you receive source code or can get it if you want it; that you can change the software and use pieces of it in new free programs; and that you are informed that you can do these things.

To protect your rights, we need to make restrictions that forbid distributors to deny you these rights or to ask you to surrender these rights. These restrictions translate to certain responsibilities for you if you distribute copies of the library or if you modify it.

For example, if you distribute copies of the library, whether gratis or for a fee, you must give the recipients all the rights that we gave you. You must make sure that they, too, receive or can get the source code. If you link other code with the library, you must provide complete object files to the recipients, so that they can relink them with the library after making changes to the library and recompiling it. And you must show them these terms so they know their rights.

We protect your rights with a two-step method: (1) we copyright the library, and (2) we offer you this license, which gives you legal permission to copy, distribute and/or modify the library. To protect each distributor, we want to make it very clear that there is no warranty for the free library. Also, if the library is modified by someone else and passed on, the recipients should know that what they have is not the original version, so that the original author's reputation will not be affected by problems that might be introduced by others.

Finally, software patents pose a constant threat to the existence of any free program. We wish to make sure that a company cannot effectively restrict the users of a free program by obtaining a restrictive license from a patent holder. Therefore, we insist that any patent license obtained for a version of the library must be consistent with the full freedom of use specified in this license.

Most GNU software, including some libraries, is covered by the ordinary GNU General Public License. This license, the GNU Lesser General Public License, applies to certain designated libraries, and is quite different from the ordinary General Public License. We use this license for certain libraries in order to permit linking those libraries into non-free programs.

When a program is linked with a library, whether statically or using a shared library, the combination of the two is legally speaking a combined work, a derivative of the original library. The ordinary General Public License therefore permits such linking only if the entire combination fits its criteria of freedom. The Lesser General Public License permits more lax criteria for linking other code with the library.

We call this license the "Lesser" General Public License because it does Less to protect the user's freedom than the ordinary General Public License. It also provides other free software developers Less of an advantage over competing non-free programs. These disadvantages are the reason we use the ordinary General Public License for many libraries. However, the Lesser license provides advantages in certain special circumstances.

For example, on rare occasions, there may be a special need to encourage the widest possible use of a certain library, so that it becomes a de-facto standard. To achieve this, non-free programs must be allowed to use the library. A more frequent case is that a free library does the same job as widely used non-free libraries. In this case, there is little to gain by limiting the free library to free software only, so we use the Lesser General Public License.

In other cases, permission to use a particular library in non-free programs enables a greater number of people to use a large body of free software. For example, permission to use the GNU C Library in non-free programs enables many more people to use the whole GNU operating system, as well as its variant, the GNU/Linux operating system.

Although the Lesser General Public License is Less protective of the users' freedom, it does ensure that the user of a program that is linked with the Library has the freedom and the wherewithal to run that program using a modified version of the Library.

The precise terms and conditions for copying, distribution and modification follow. Pay close attention to the difference between a "work based on the library" and a "work that uses the library". The former contains code derived from the library, whereas the latter must be combined with the library in order to run.

GNU GENERAL PUBLIC LICENSE TERMS AND CONDITIONS FOR COPYING, DISTRIBUTION AND MODIFICATION

0. This License Agreement applies to any software library or other program which contains a notice placed by the copyright holder or other authorized party saying it may be distributed under the terms of this Lesser General Public License (also called "this License"). Each licensee is addressed as "you".

A "library" means a collection of software functions and/or data prepared so as to be conveniently linked with application programs (which use some of those functions and data) to form executables.

The “Library”, below, refers to any such software library or work which has been distributed under these terms. A “work based on the Library” means either the Library or any derivative work under copyright law: that is to say, a work containing the Library or a portion of it, either verbatim or with modifications and/or translated straightforwardly into another language. (Hereinafter, translation is included without limitation in the term “modification”.)

“Source code” for a work means the preferred form of the work for making modifications to it. For a library, complete source code means all the source code for all modules it contains, plus any associated interface definition files, plus the scripts used to control compilation and installation of the library.

Activities other than copying, distribution and modification are not covered by this License; they are outside its scope. The act of running a program using the Library is not restricted, and output from such a program is covered only if its contents constitute a work based on the Library (independent of the use of the Library in a tool for writing it). Whether that is true depends on what the Library does and what the program that uses the Library does.

1. You may copy and distribute verbatim copies of the Library’s complete source code as you receive it, in any medium, provided that you conspicuously and appropriately publish on each copy an appropriate copyright notice and disclaimer of warranty; keep intact all the notices that refer to this License and to the absence of any warranty; and distribute a copy of this License along with the Library.

You may charge a fee for the physical act of transferring a copy, and you may at your option offer warranty protection in exchange for a fee.

2. You may modify your copy or copies of the Library or any portion of it, thus forming a work based on the Library, and copy and distribute such modifications or work under the terms of Section 1 above, provided that you also meet all of these conditions:

- a) The modified work must itself be a software library.
- b) You must cause the files modified to carry prominent notices stating that you changed the files and the date of any change.
- c) You must cause the whole of the work to be licensed at no charge to all third parties under the terms of this License.
- d) If a facility in the modified Library refers to a function or a table of data to be supplied by an application program that uses the facility, other than as an argument passed when the facility is invoked, then you must make a good faith effort to ensure that, in the event an application does not supply such function or table, the facility still operates, and performs whatever part of its purpose remains meaningful.

(For example, a function in a library to compute square roots has a purpose that is entirely well-defined independent of the application. Therefore, Subsection 2d requires that any application-supplied function or table used by this function must be optional: if the application does not supply it, the square root function must still compute square roots.)

These requirements apply to the modified work as a whole. If identifiable sections of that work are not derived from the Library, and can be reasonably considered independent and separate works in themselves, then this License, and its terms, do not apply to those sections when you distribute them as separate works. But when you distribute the same sections as part of a whole which is a work based on the Library, the distribution of the whole must be on the terms of this License, whose permissions for other licensees extend to the entire whole, and thus to each and every part regardless of who wrote it.

Thus, it is not the intent of this section to claim rights or contest your rights to work written entirely by you; rather, the intent is to exercise the right to control the distribution of derivative or collective works based on the Library.

In addition, mere aggregation of another work not based on the Library with the Library (or with a work based on the Library) on a volume of a storage or distribution medium does not bring the other work under the scope of this License.

3. You may opt to apply the terms of the ordinary GNU General Public License instead of this License to a given copy of the Library. To do this, you must alter all the notices that refer to this License, so that they refer to the ordinary GNU General Public License, version 2, instead of to this License. (If a newer version than version 2 of the ordinary GNU General Public License has appeared, then you can specify that version instead if you wish.) Do not make any other change in these notices.

Once this change is made in a given copy, it is irreversible for that copy, so the ordinary GNU General Public License applies to all subsequent copies and derivative works made from that copy.

This option is useful when you wish to copy part of the code of the Library into a program that is not a library.

4. You may copy and distribute the Library (or a portion or derivative of it, under Section 2) in object code or executable form under the terms of Sections 1 and 2 above provided that you accompany it with the complete corresponding machine-readable source code, which must be distributed under the terms of Sections 1 and 2 above on a medium customarily used for software interchange.

If distribution of object code is made by offering access to copy from a designated place, then offering equivalent access to copy the source code from the same place satisfies the requirement to distribute the source code, even though third parties are not compelled to copy the source along with the object code.

5. A program that contains no derivative of any portion of the Library, but is designed to work with the Library by being compiled or linked with it, is called a “work that uses the Library”. Such a work, in isolation, is not a derivative work of the Library, and therefore falls outside the scope of this License.

However, linking a “work that uses the Library” with the Library creates an executable that is a derivative of the Library (because it contains portions of the Library), rather than a “work that uses the library”. The executable is therefore covered by this License. Section 6 states terms for distribution of such executables.

When a “work that uses the Library” uses material from a header file that is part of the Library, the object code for the work may be a derivative work of the Library even though the source code is not. Whether this is true is especially significant if the work can be linked without the Library, or if the work is itself a library. The threshold for this to be true is not precisely defined by law.

If such an object file uses only numerical parameters, data structure layouts and assessors, and small macros and small inline functions (ten lines or less in length), then the use of the object file is unrestricted, regardless of whether it is legally a derivative work. (Executables containing this object code plus portions of the Library will still fall under Section 6.)

Otherwise, if the work is a derivative of the Library, you may distribute the object code for the work under the terms of Section 6. Any executables containing that work also fall under Section 6, whether or not they are linked directly with the Library itself.

6. As an exception to the Sections above, you may also combine or link a “work that uses the Library” with the Library to produce a work containing portions of the Library, and distribute that work under terms of your choice, provided that the terms permit modification of the work for the customer’s own use and reverse engineering for debugging such modifications.

You must give prominent notice with each copy of the work that the Library is used in it and that the Library and its use are covered by this License. You must supply a copy of this License. If the work during execution displays copyright notices, you must include the copyright notice for the Library among them, as well as a reference directing the user to the copy of this License. Also, you must do one of these things:

- a) Accompany the work with the complete corresponding machine-readable source code for the Library including whatever changes were used in the work (which must be distributed under Sections 1 and 2 above); and, if the work is an executable linked with the Library, with the complete machine-readable "work that uses the Library", as object code and/or source code, so that the user can modify the Library and then relink to produce a modified executable containing the modified Library. (It is understood that the user who changes the contents of definitions files in the Library will not necessarily be able to recompile the application to use the modified definitions.)
- b) Use a suitable shared library mechanism for linking with the Library. A suitable mechanism is one that (1) uses at run time a copy of the library already present on the user's computer system, rather than copying library functions into the executable, and (2) will operate properly with a modified version of the library, if the user installs one, as long as the modified version is interface-compatible with the version that the work was made with.
- c) Accompany the work with a written offer, valid for at least three years, to give the same user the materials specified in Subsection 6a, above, for a charge no more than the cost of performing this distribution.
- d) If distribution of the work is made by offering access to copy from a designated place, offer equivalent access to copy the above specified materials from the same place.
- e) Verify that the user has already received a copy of these materials or that you have already sent this user a copy.

For an executable, the required form of the "work that uses the Library" must include any data and utility programs needed for reproducing the executable from it. However, as a special exception, the materials to be distributed need not include anything that is normally distributed (in either source or binary form) with the major components (compiler, kernel, and so on) of the operating system on which the executable runs, unless that component itself accompanies the executable.

It may happen that this requirement contradicts the license restrictions of other proprietary libraries that do not normally accompany the operating system. Such a contradiction means you cannot use both them and the Library together in an executable that you distribute.

7. You may place library facilities that are a work based on the Library side-by-side in a single library together with other library facilities not covered by this License, and distribute such a combined library, provided that the separate distribution of the work based on the Library and of the other library facilities is otherwise permitted, and provided that you do these two things:
 - a) Accompany the combined library with a copy of the same work based on the Library, uncombined with any other library facilities. This must be distributed under the terms of the Sections above.
 - b) Give prominent notice with the combined library of the fact that part of it is a work based on the Library, and explaining where to find the accompanying uncombined form of the same work.
8. You may not copy, modify, sublicense, link with, or distribute the Library except as expressly provided under this License. Any attempt otherwise to copy, modify, sublicense, link with, or distribute the Library is void, and will automatically terminate your rights under this License. However, parties who have received copies, or rights, from you under this License will not have their licenses terminated so long as such parties remain in full compliance.

9. You are not required to accept this License, since you have not signed it. However, nothing else grants you permission to modify or distribute the Library or its derivative works. These actions are prohibited by law if you do not accept this License. Therefore, by modifying or distributing the Library (or any work based on the Library), you indicate your acceptance of this License to do so, and all its terms and conditions for copying, distributing or modifying the Library or works based on it.
10. Each time you redistribute the Library (or any work based on the Library), the recipient automatically receives a license from the original licensor to copy, distribute, link with or modify the Library subject to these terms and conditions. You may not impose any further restrictions on the recipients' exercise of the rights granted herein. You are not responsible for enforcing compliance by third parties with this License.
11. If, as a consequence of a court judgment or allegation of patent infringement or for any other reason (not limited to patent issues), conditions are imposed on you (whether by court order, agreement or otherwise) that contradict the conditions of this License, they do not excuse you from the conditions of this License. If you cannot distribute so as to satisfy simultaneously your obligations under this License and any other pertinent obligations, then as a consequence you may not distribute the Library at all. For example, if a patent license would not permit royalty-free redistribution of the Library by all those who receive copies directly or indirectly through you, then the only way you could satisfy both it and this License would be to refrain entirely from distribution of the Library.

If any portion of this section is held invalid or unenforceable under any particular circumstance, the balance of the section is intended to apply, and the section as a whole is intended to apply in other circumstances.

It is not the purpose of this section to induce you to infringe any patents or other property right claims or to contest validity of any such claims; this section has the sole purpose of protecting the integrity of the free software distribution system which is implemented by public license practices. Many people have made generous contributions to the wide range of software distributed through that system in reliance on consistent application of that system; it is up to the author/donor to decide if he or she is willing to distribute software through any other system and a licensee cannot impose that choice.

This section is intended to make thoroughly clear what is believed to be a consequence of the rest of this License.

12. If the distribution and/or use of the Library is restricted in certain countries either by patents or by copyrighted interfaces, the original copyright holder who places the Library under this License may add an explicit geographical distribution limitation excluding those countries, so that distribution is permitted only in or among countries not thus limited. In such case, this License incorporates the limitation as if written in the body of this License.
 13. The Free Software Foundation may publish revised and/or new versions of the Lesser General Public License from time to time. Such new versions will be similar in spirit to the present version, but may differ in detail to address new problems or concerns.
- Each version is given a distinguishing version number. If the Library specifies a version number of this License which applies to it and "any later version", you have the option of following the terms and conditions either of that version or of any later version published by the Free Software Foundation. If the Library does not specify a license version number, you may choose any version ever published by the Free Software Foundation.

14. If you wish to incorporate parts of the Library into other free programs whose distribution conditions are incompatible with these, write to the author to ask for permission. For software which is copyrighted by the Free Software Foundation, write to the Free Software Foundation; we sometimes make exceptions for this. Our decision will be guided by the two goals of preserving the free status of all derivatives of our free software and of promoting the sharing and reuse of software generally.

NO WARRANTY

15. BECAUSE THE LIBRARY IS LICENSED FREE OF CHARGE, THERE IS NO WARRANTY FOR THE LIBRARY, TO THE EXTENT PERMITTED BY APPLICABLE LAW. EXCEPT WHEN OTHERWISE STATED IN WRITING THE COPYRIGHT HOLDERS AND/OR OTHER PARTIES PROVIDE THE LIBRARY "AS IS" WITHOUT WARRANTY OF ANY KIND, EITHER EXPRESSED OR IMPLIED, INCLUDING, BUT NOT LIMITED TO, THE IMPLIED WARRANTIES OF MERCHANTABILITY AND FITNESS FOR A PARTICULAR PURPOSE. THE ENTIRE RISK AS TO THE QUALITY AND PERFORMANCE OF THE LIBRARY IS WITH YOU. SHOULD THE LIBRARY PROVE DEFECTIVE, YOU ASSUME THE COST OF ALL NECESSARY SERVICING, REPAIR OR CORRECTION.

16. IN NO EVENT UNLESS REQUIRED BY APPLICABLE LAW OR AGREED TO IN WRITING WILL ANY COPYRIGHT HOLDER, OR ANY OTHER PARTY WHO MAY MODIFY AND/OR REDISTRIBUTE THE LIBRARY AS PERMITTED ABOVE, BE LIABLE TO YOU FOR DAMAGES, INCLUDING ANY GENERAL, SPECIAL, INCIDENTAL OR CONSEQUENTIAL DAMAGES ARISING OUT OF THE USE OR INABILITY TO USE THE LIBRARY (INCLUDING BUT NOT LIMITED TO LOSS OF DATA OR DATA BEING RENDERED INACCURATE OR LOSSES SUSTAINED BY YOU OR THIRD PARTIES OR A FAILURE OF THE LIBRARY TO OPERATE WITH ANY OTHER SOFTWARE), EVEN IF SUCH HOLDER OR OTHER PARTY HAS BEEN ADVISED OF THE POSSIBILITY OF SUCH DAMAGES.

END OF TERMS AND CONDITIONS

How to Apply These Terms to Your New Libraries

If you develop a new library, and you want it to be of the greatest possible use to the public, we recommend making it free software that everyone can redistribute and change. You can do so by permitting redistribution under these terms (or, alternatively, under the terms of the ordinary General Public License).

To apply these terms, attach the following notices to the library. It is safest to attach them to the start of each source file to most effectively convey the exclusion of warranty; and each file should have at least the "copyright" line and a pointer to where the full notice is found.

```
<one line to give the library's name and an idea of what it does.>
Copyright (C) <year> <name of author>
```

This library is free software; you can redistribute it and/or modify it under the terms of the GNU Lesser General Public License as published by the Free Software Foundation; either version 2.1 of the License, or (at your option) any later version.

This library is distributed in the hope that it will be useful, but WITHOUT ANY WARRANTY; without even the implied warranty of MERCHANTABILITY or FITNESS FOR A PARTICULAR PURPOSE. See the GNU Lesser General Public License for more details.

You should have received a copy of the GNU Lesser General Public License along with this library; if not, write to the Free Software Foundation, Inc., 59 Temple Place, Suite 330, Boston, MA 02111-1307 USA

Also add information on how to contact you by electronic and paper mail.

You should also get your employer (if you work as a programmer) or your school, if any, to sign a "copyright disclaimer" for the library, if necessary. Here is a sample; alter the names:

Yoyodyne, Inc., hereby disclaims all copyright interest in the library "Frob" (a library for tweaking knobs) written by James Random Hacker.

signature of Ty Coon, 1 April 1990
Ty Coon, President of Vice

That's all there is to it!

Required statements for OpenSSL project used in this product

This product contains OpenSSL (including the library Original SSLeay), which Sony uses under license with the copyright holder. In compliance with a request by the copyright holder of said software, Sony conveys the following notice and asks that you read it.

Package name: sony-target-grel-openssl-0.9.8g-020201.src.rpm

OpenSSL

Copyright (c) 1998-2006 The OpenSSL Project. All rights reserved.

Redistribution and use in source and binary forms, with or without modification, are permitted provided that the following conditions are met:

1. Redistributions of source code must retain the above copyright notice, this list of conditions and the following disclaimer.
2. Redistributions in binary form must reproduce the above copyright notice, this list of conditions and the following disclaimer in the documentation and/or other materials provided with the distribution.
3. All advertising materials mentioning features or use of this software must display the following acknowledgment: "This product includes software developed by the OpenSSL Project for use in the OpenSSL Toolkit. (<http://www.openssl.org/>)"
4. The names "OpenSSL Toolkit" and "OpenSSL Project" must not be used to endorse or promote products derived from this software without prior written permission. For written permission, please contact openssl-core@openssl.org.
5. Products derived from this software may not be called "OpenSSL" nor may "OpenSSL" appear in their names without prior written permission of the OpenSSL Project.
6. Redistributions of any form whatsoever must retain the following acknowledgment: "This product includes software developed by the OpenSSL Project for use in the OpenSSL Toolkit (<http://www.openssl.org/>)"

THIS SOFTWARE IS PROVIDED BY THE OpenSSL PROJECT "AS IS" AND ANY EXPRESSED OR IMPLIED WARRANTIES, INCLUDING, BUT NOT LIMITED TO, THE IMPLIED WARRANTIES OF MERCHANTABILITY AND FITNESS FOR A PARTICULAR PURPOSE ARE DISCLAIMED. IN NO EVENT SHALL THE OpenSSL PROJECT OR ITS CONTRIBUTORS BE LIABLE FOR ANY DIRECT, INDIRECT, INCIDENTAL, SPECIAL, EXEMPLARY, OR CONSEQUENTIAL DAMAGES (INCLUDING, BUT NOT LIMITED TO, PROCUREMENT OF SUBSTITUTE GOODS OR SERVICES; LOSS OF USE, DATA, OR PROFITS; OR BUSINESS INTERRUPTION) HOWEVER CAUSED AND ON ANY THEORY OF LIABILITY, WHETHER IN CONTRACT, STRICT LIABILITY, OR TORT (INCLUDING NEGLIGENCE OR OTHERWISE) ARISING IN ANY WAY OUT OF THE USE OF THIS SOFTWARE, EVEN IF ADVISED OF THE POSSIBILITY OF SUCH DAMAGE.

This product includes cryptographic software written by Eric Young (eay@cryptsoft.com). This product includes software written by Tim Hudson (tjh@cryptsoft.com).

Original SSLeay License

Original SSLeay

Copyright (C) 1995-1998 Eric Young (eay@cryptsoft.com)
All rights reserved.

This package is an SSL implementation written by Eric Young (eay@cryptsoft.com).

The implementation was written so as to conform with Netscapes SSL.

This library is free for commercial and non-commercial use as long as the following conditions are adhered to. The following conditions apply to all code found in this distribution, be it the RC4, RSA, lhash, DES, etc., code; not just the SSL code. The SSL documentation included with this distribution is covered by the same copyright terms except that the holder is Tim Hudson (tjh@cryptsoft.com).

Copyright remains Eric Young's, and as such any Copyright notices in the code are not to be removed.

If this package is used in a product, Eric Young should be given attribution as the author of the parts of the library used.

This can be in the form of a textual message at program startup or in documentation (online or textual) provided with the package.

Redistribution and use in source and binary forms, with or without modification, are permitted provided that the following conditions are met:

1. Redistributions of source code must retain the copyright notice, this list of conditions and the following disclaimer.
2. Redistributions in binary form must reproduce the above copyright notice, this list of conditions and the following disclaimer in the documentation and/or other materials provided with the distribution.
3. All advertising materials mentioning features or use of this software must display the following acknowledgement:
"This product includes cryptographic software written by Eric Young (eay@cryptsoft.com)"
The word "cryptographic" can be left out if the routines from the library being used are not cryptographic related :-).
4. If you include any Windows specific code (or a derivative thereof) from the apps directory (application code) you must include an acknowledgement:
"This product includes software written by Tim Hudson (tjh@cryptsoft.com)"

THIS SOFTWARE IS PROVIDED BY ERIC YOUNG "AS IS" AND ANY EXPRESS OR IMPLIED WARRANTIES, INCLUDING, BUT NOT LIMITED TO, THE IMPLIED WARRANTIES OF MERCHANTABILITY AND FITNESS FOR A PARTICULAR PURPOSE ARE DISCLAIMED. IN NO EVENT SHALL THE AUTHOR OR CONTRIBUTORS BE LIABLE FOR ANY DIRECT, INDIRECT, INCIDENTAL, SPECIAL, EXEMPLARY, OR CONSEQUENTIAL DAMAGES (INCLUDING, BUT NOT LIMITED TO, PROCUREMENT OF SUBSTITUTE GOODS OR SERVICES; LOSS OF USE, DATA, OR PROFITS; OR BUSINESS INTERRUPTION) HOWEVER CAUSED AND ON ANY THEORY OF LIABILITY, WHETHER IN CONTRACT, STRICT LIABILITY, OR TORT (INCLUDING NEGLIGENCE OR OTHERWISE) ARISING IN ANY WAY OUT OF THE USE OF THIS SOFTWARE, EVEN IF ADVISED OF THE POSSIBILITY OF SUCH DAMAGE.

The licence and distribution terms for any publically available version or derivative of this code cannot be changed. i.e. this code cannot simply be copied and put under another distribution licence [including the GNU Public Licence.]

FreeType

The FreeType Project is copyright (C) 1996-2000 by David Turner, Robert Wilhelm, and Werner Lemberg. All rights reserved except as specified below.

THE FREETYPE PROJECT IS PROVIDED 'AS IS' WITHOUT WARRANTY OF ANY KIND, EITHER EXPRESS OR IMPLIED, INCLUDING, BUT NOT LIMITED TO, WARRANTIES OF MERCHANTABILITY AND FITNESS FOR A PARTICULAR PURPOSE. IN NO EVENT WILL ANY OF THE AUTHORS OR COPYRIGHT HOLDERS BE LIABLE FOR ANY DAMAGES CAUSED BY THE USE OR THE INABILITY TO USE, OF THE FREETYPE PROJECT.

Notice about NetBSD Software

BSD License

Copyright (c) 1994-2004 The NetBSD Foundation, Inc. All rights reserved.

Redistribution and use in source and binary forms, with or without modification, are permitted provided that the following conditions are met:

1. Redistributions of source code must retain the above copyright notice, this list of conditions and the following disclaimer.
2. Redistributions in binary form must reproduce the above copyright notice, this list of conditions and the following disclaimer in the documentation and/or other materials provided with the distribution.
3. All advertising materials mentioning features or use of this software must display the following acknowledgement:
This product includes software developed by the NetBSD Foundation, Inc. and its contributors.
4. Neither the name of The NetBSD Foundation nor the names of its contributors may be used to endorse or promote products derived from this software without specific prior written permission.

THIS SOFTWARE IS PROVIDED BY THE REGENTS AND CONTRIBUTORS "AS IS" AND ANY EXPRESS OR IMPLIED WARRANTIES, INCLUDING, BUT NOT LIMITED TO, THE IMPLIED WARRANTIES OF MERCHANTABILITY AND FITNESS FOR A PARTICULAR PURPOSE ARE DISCLAIMED. IN NO EVENT SHALL THE REGENTS OR CONTRIBUTORS BE LIABLE FOR ANY DIRECT, INDIRECT, INCIDENTAL, SPECIAL, EXEMPLARY, OR CONSEQUENTIAL DAMAGES (INCLUDING, BUT NOT LIMITED TO, PROCUREMENT OF SUBSTITUTE GOODS OR SERVICES; LOSS OF USE, DATA, OR PROFITS; OR BUSINESS INTERRUPTION) HOWEVER CAUSED AND ON ANY THEORY OF LIABILITY, WHETHER IN CONTRACT, STRICT LIABILITY, OR TORT (INCLUDING NEGLIGENCE OR OTHERWISE) ARISING IN ANY WAY OUT OF THE USE OF THIS SOFTWARE, EVEN IF ADVISED OF THE POSSIBILITY OF SUCH DAMAGE.

The following notices are required to satisfy the license terms of the software that we have mentioned in this document:

This product includes software developed by Adam Glass.

This product includes software developed by Bill Paul.

This product includes software developed by Charles M.

Hannum.

This product includes software developed by Christian E.

Hopps.

This product includes software developed by Christopher G. Demetriou.

This product includes software developed by Christopher G. Demetriou for the NetBSD Project.

This product includes software developed by Christos Zoulas.

This product includes software developed by Gardner

Buchanan.

This product includes software developed by Gordon W. Ross

This product includes software developed by Jonathan Stone for the NetBSD Project.

This product includes software developed by Manuel Bouyer. This product includes software developed by Rolf Grossmann. This product includes software developed by Tool.S GmbH. This product includes software developed by the NetBSD Foundation, Inc. and its contributors.

This product includes software developed by the University of California, Berkeley and its contributors.

This product includes software developed by the University of California, Lawrence Berkeley Laboratory and its contributors. This product includes software developed by the University of California, Lawrence Berkeley Laboratory.

This product includes software developed for the NetBSD Project by Wasabi Systems, Inc.

This product includes software developed for the NetBSD Project by Matthias Drochner.

Notice about JPEG

Parts of this product utilize the research results of the Independent JPEG Group.

Package name `sony-target-grel-libjpeg-6b-020201.src.rpm`.

In plain English:

1. We don't promise that this software works. (But if you find any bugs, please let us know!)
2. You can use this software for whatever you want. You don't have to pay us.
3. You may not pretend that you wrote this software. If you use it in a program, you must acknowledge somewhere in your documentation that you've used the IJG code.

In legalese:

The authors make NO WARRANTY or representation, either express or implied, with respect to this software, its quality, accuracy, merchantability, or fitness for a particular purpose.

This software is provided "AS IS", and you, its user assume the entire risk as to its quality and accuracy.

This software is copyright (c) 1991-1998, Thomas G. Lane. All Rights Reserved except as specified below.

Permission is hereby granted to use, copy, modify, and distribute this software (or portions thereof) for any purpose, without fee, subject to these conditions:

- (1) If any part of the source code for this software is distributed, then this README file must be included, with this copyright and no-warranty notice unaltered; and any additions, deletions, or changes to the original files must be clearly indicated in accompanying documentation.
- (2) If only executable code is distributed, then the accompanying documentation must state that "this software is based in part on the work of the Independent JPEG Group".
- (3) Permission for use of this software is granted only if the user accepts full responsibility for any undesirable consequences; the authors accept NO LIABILITY for damages of any kind.

These conditions apply to any software derived from or based on the IJG code, not just to the unmodified library. If you use our work, you ought to acknowledge us.

Permission is NOT granted for the use of any IJG author's name or company name in advertising or publicity relating to this software or products derived from it. This software may be referred to only as "the Independent JPEG Group's software".

We specifically permit and encourage the use of this software as the basis of commercial products, provided that all warranty or liability claims are assumed by the product vendor.

Notice about PuTTY Software

This product contains some code of the application PuTTY.

Source package: `putty-0.58.tar.gz`

License text: <http://www.chiark.greenend.org.uk/~sgtatham/putty/licence.html>

PuTTY is copyright 1997-2006 Simon Tatham.

Portions copyright Robert de Bath, Joris van Rantwijk, Delian Delchev, Andreas Schultz, Jeroen Massar, Wez Furlong,

Nicolas Barry, Justin Bradford, Ben Harris, Malcolm Smith, Ahmad Khalifa, Markus Kuhn, and CORE SDI S.A.

Permission is hereby granted, free of charge, to any person obtaining a copy of this software and associated documentation files (the "Software"), to deal in the Software without restriction, including without limitation the rights to use, copy, modify, merge, publish, distribute, sublicense, and/or sell copies of the Software, and to permit persons to whom the Software is furnished to do so, subject to the following conditions:

The above copyright notice and this permission notice shall be included in all copies or substantial portions of the Software.

THE SOFTWARE IS PROVIDED "AS IS", WITHOUT WARRANTY OF ANY KIND, EXPRESS OR IMPLIED, INCLUDING BUT NOT LIMITED TO THE WARRANTIES OF MERCHANTABILITY, FITNESS FOR A PARTICULAR PURPOSE AND NONINFRINGEMENT. IN NO EVENT SHALL SIMON TATHAM BE LIABLE FOR ANY CLAIM, DAMAGES OR OTHER LIABILITY, WHETHER IN AN ACTION OF CONTRACT, TORT OR OTHERWISE, ARISING FROM, OUT OF OR IN CONNECTION WITH THE SOFTWARE OR THE USE OR OTHER DEALINGS IN THE SOFTWARE.

Notice about fdlbm Software

@(#)fdlibm.h 1.5 95/01/18

Copyright (C) 1993 by Sun Microsystems, Inc. All rights reserved.

Developed at SunSoft, a Sun Microsystems, Inc. business. Permission to use, copy, modify, and distribute this software is freely granted, provided that this notice is preserved.

Notice about Root Certificates

In addition, the Runtimes and Runtime Components may contain one or more root certificates (herein referred to as "Root Certificates"). You may not modify the Root Certificates.

Notice about Nano-XML

Copyright (C) 2000-2002 Marc De Scheemaekker, All Rights Reserved.

This software is provided 'as-is', without any express or implied warranty. In no event will the authors be held liable for any damages arising from the use of this software.

Permission is granted to anyone to use this software for any purpose, including commercial applications, and to alter it and redistribute it freely, subject to the following restrictions:

1. The origin of this software must not be misrepresented; you must not claim that you wrote the original software. If you use this software in a product, an acknowledgment in the product documentation would be appreciated but is not required.
2. Altered source versions must be plainly marked as such, and must not be misrepresented as being the original software.
3. This notice may not be removed or altered from any source distribution.

Glossary

AACS

“Advanced Access Content System” is a specification for managing digital entertainment contents stored on the next generation of prerecorded and recorded optical media. The specification enables consumers to enjoy digital entertainment content, including high-definition content.

AVCHD (page 60)

The AVCHD format is a high definition digital video camera format used to record SD (standard definition) or HD (high definition) signals of either the 1080i specification*¹ or the 720p specification*² on DVDs, using efficient data compression coding technology. The MPEG-4 AVC/H.264 format is adopted to compress video data, and the Dolby Digital or Linear PCM is used to compress audio data. The MPEG-4 AVC/H.264 format is capable of compressing images at higher efficiency than that of the conventional image compression format. The MPEG-4 AVC/H.264 format enables a high definition (HD) video signal shot on a digital video camera recorder to be recorded on DVDs in the same way as for a standard definition (SD) television signal.

*¹ A high definition specification that utilizes 1080 effective scanning lines and the interlace format.

*² A high definition specification that utilizes 720 effective scanning lines and the progressive format.

BD-J application

The BD-ROM format supports Java for interactive functions.

“BD-J” offers content providers almost unlimited functionality when creating interactive BD-ROM titles.

BD-R (page 58)

BD-R (Blu-ray Disc Recordable) is a recordable, write-once Blu-ray Disc, available in the same capacities as the BD below. Since contents can be recorded and cannot be overwritten, a BD-R can be used to archive valuable data or storing and distributing video material.

BD-RE (page 58)

BD-RE (Blu-ray Disc Rewritable) is a recordable and rewritable Blu-ray Disc, available in the same capacities as the BD below. The re-recordable feature makes extensive editing and time-shifting applications possible.

BD-ROM (page 58)

BD-ROMs (Blu-ray Disc Read-Only Memory) are commercially produced discs and are available in the same capacities as the BD below. Other than conventional movie and video contents, these discs have enhanced features such as interactive content, menu operations using pop-up menus, selection of subtitle display, and slideshow. Although a BD-ROM may contain any form of data, most BD-ROM discs will contain movies in High Definition format, for playback on Blu-ray Disc/DVD players.

Blu-ray Disc (BD) (page 58)

A disc format developed for recording/playing high-definition (HD) video (for HDTV, etc.), and for storing large amounts of data. A single layer Blu-ray Disc holds up to 25 GB, and a dual-layer Blu-ray Disc holds up to 50 GB of data.

Dolby Digital Plus (page 62)

Developed as an extension to Dolby Digital, the audio coding technology supports 7.1 multi-channel surround sound.

Dolby TrueHD (page 62)

Dolby TrueHD is a lossless coding technology that supports up to 8 channels of multi-channel surround sound for the next generation optical discs. The reproduced sound is true to the original source bit-for-bit.

DTS-HD High Resolution Audio (page 62)

Developed as an extension to DTS Digital Surround format. It supports a maximum sampling frequency of 96 kHz, and 7.1 multi-channel surround.

DTS-HD High Resolution Audio has a maximum transmission rate of 6 Mbps, with lossy compression (Lossy).

DTS-HD Master Audio (page 62)

DTS-HD Master Audio has a maximum transmission rate of 24.5 Mbps, and uses lossless compression (Lossless), and DTS-HD Master Audio corresponds to a maximum sampling frequency of 192 kHz, and maximum of 7.1ch.

HDMI (High-Definition Multimedia Interface) (page 15)

HDMI is an interface that supports both video and audio on a single digital connection. The HDMI connection carries standard- to high-definition video signals and multi-channel audio signals to AV components such as HDMI equipped TVs, in digital form without degradation.

The HDMI specification supports HDCP (High-bandwidth Digital Contents Protection), a copy protection technology for digital entertainment contents for HDMI.

LTH (Low to High) (page 59)

LTH is a recording system that supports organic pigment type BD-R.

PhotoTV HD (page 38)

“PhotoTV HD” allows for a highly-detailed pictures, and photo-like expression of subtle textures and colors. By connecting Sony “PhotoTV HD” compatible devices using an HDMI cable, whole new world of photos can be enjoyed in breathtaking Full HD quality. For instance, the delicate texture of the human skin, flowers, sand and waves can now be displayed on a large screen in beautiful photo-like quality.

Pop-up menu (page 32)

An enhanced menu operation available on BD-ROMs. The pop-up menu appears when POP UP/MENU is pressed during playback, and can be operated while playback is in progress.

x.v.Color (page 44)

x.v.Color is a familiar term for the xvYCC standard proposed by Sony. xvYCC is an international standard for Color space in video.

This standard can express a wider color range than the currently used broadcast standard.

24p True Cinema (page 43)

Movies shot with a film camera consist of 24 frames per second.

Since conventional televisions (both CRT and flat panels) display frames either at 1/60 or 1/50 second intervals, the 24 frames do not appear at an even pace.

When connected to a TV with 24p capabilities, the player displays each frame at 1/24 second intervals — the same interval originally shot with the film camera, thus faithfully reproducing the original cinema image.

Index

Words in quotations appear in the on-screen displays.

Numerics

24p True Cinema 77

A

“A/V Settings” 34
AACs 76
ANGLE 8
AUDIO 8
“Audio Output Priority” 44
Audio output signals 62
“Audio Settings” 35, 44
AVCHD 60, 76

B

Batteries 26
“BD Data” 33, 55
“BD/DVD Viewing Settings” 46
BD-DAV 58
BDMV 58
BD-R 58, 76
BD-RE 58, 76
Bitstream 62
Blu-ray Disc 58, 76
BonusView 23, 32
BRAVIA Sync 16, 55

C

CD 58
Chapter 33
Child Lock 10, 56
Color buttons 9
Connecting
 AV amplifier (receiver) 19
 TV 14
“Control for HDMI” 16, 31, 49, 55

D

“Dimmer” 49
Disc information 34
Disc Lock 31
DISPLAY 8
Dolby Digital 21, 45
Dolby Digital Plus 62, 76
Dolby TrueHD 62, 76
DTS 21, 45
DTS-HD 62, 76
DVD 58

E

Easy Setup 27, 52
Enter characters 51
External memory 23, 32, 55

F

Front panel display 11

H

HDMI 15, 20, 28, 42, 44, 55, 77
HOME 9
Home menu 36, 37, 39

L

Language Follow 16
Local storage 23, 32, 55
LTH 77

M

“Music” 36

N

“Network Diagnostic” 50
“Network Settings” 50
“Network Update” 24, 40

O

One-Touch Play 16, 31
OPTIONS 9, 32, 36, 37
“OSD” 49

P

Parental Control 31, 46
“Photo” 37
“Photo Settings” 48
PhotoTV HD 38, 77
Playable discs 58
POP UP/MENU 9, 32

Q

“Quick Start” 49

R

Region code 59
Remote 8, 26, 27
“Resetting” 52
Resetting the player 52
Resume 9, 31, 36

S

SCENE SEARCH 9
Searching 33
Self-diagnosis function 57
“Setup” 39
Slideshow 37
Software update 24, 40, 49
“Standby Mode” 49
SUBTITLE 8
System Power-Off 16
“System Settings” 49

T

THEATER 8, 16
Title 33
TOP MENU 9
Troubleshooting 53
“TV Type” 41

U

Update 24, 40

V

“Video” 30
Video output resolution 61
“Video Settings” 34, 41

X

x.v.Color 44, 77

