

FM Stereo FM-AM Receiver

Operating Instructions

Owner's Record

The model and serial numbers are located on the rear panel. Record the serial number in the space provided below. Refer to them whenever you call upon your Sony dealer regarding this product.

Model No. _____ Serial No. _____

***STR-DB1070
STR-DB870***

WARNING

To prevent fire or shock hazard, do not expose the unit to rain or moisture.

To prevent fire, do not cover the ventilation of the apparatus with news papers, table-cloths, curtains, etc. And don't place lighted candles on the apparatus.

To prevent fire or shock hazard, do not place objects filled with liquids, such as vases, on the apparatus.



Don't throw a battery, dispose it as the injurious wastes.

Do not install the appliance in a confined space, such as a bookcase or built-in cabinet.

For customers in the United States

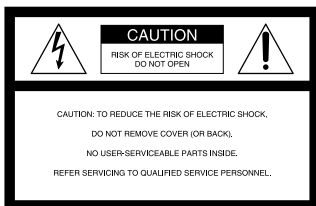

This symbol is intended to alert the user to the presence of uninsulated "dangerous voltage" within the product's enclosure that may be of sufficient magnitude to constitute a risk of electric shock to persons.



This symbol is intended to alert the user to the presence of important operating and maintenance (servicing) instructions in the literature accompanying the appliance.

WARNING

This equipment has been tested and found to comply with the limits for a Class B digital device, pursuant to Part 15 of the FCC Rules. These limits are designed to provide reasonable protection against harmful interference in a residential installation. This equipment generates, uses, and can radiate radio frequency energy and, if not installed and used in accordance with the instructions, may cause harmful interference to radio communications. However, there is no guarantee that interference will not occur in a particular installation. If this equipment does cause harmful interference to radio or television reception, which can be determined by turning the equipment off and on, the user is encouraged to try to correct the interference by one or more of the following measures:

- Reorient or relocate the receiving antenna.
- Increase the separation between the equipment and receiver.
- Connect the equipment into an outlet on a circuit different from that to which the receiver is connected.
- Consult the dealer or an experienced radio/TV technician for help.

CAUTION

You are cautioned that any changes or modification not expressly approved in this manual could void your authority to operate this equipment.

Note to CATV system installer:

This reminder is provided to call CATV system installer's attention to Article 820-40 of the NEC that provides guidelines for proper grounding and, in particular, specifies that the cable ground shall be connected to the grounding system of the building, as close to the point of cable entry as practical.



ENERGY STAR® is a U.S. registered mark.

As an ENERGY STAR® partner, Sony Corporation has determined that this product meets the ENERGY STAR® guidelines for energy efficiency.

For customers in Canada

CAUTION

TO PREVENT ELECTRIC SHOCK, DO NOT USE THIS POLARIZED AC PLUG WITH AN EXTENSION CORD, RECEPTACLE OR OTHER OUTLET UNLESS THE BLADES CAN BE FULLY INSERTED TO PREVENT BLADE EXPOSURE.

This receiver incorporates Dolby* Digital and Pro Logic Surround and the DTS** Digital Surround System.

* Manufactured under license from Dolby Laboratories.

"Dolby", "Pro Logic" and the double-D symbol are trademarks of Dolby Laboratories.

** "DTS" and "DTS Digital Surround" are registered trademarks of Digital Theater Systems, Inc.

Table of Contents

Parts Identification

Main unit	5
-----------------	---

Hooking Up the Components

Required cords	6
Antenna hookups	7
Audio component hookups	8
Video component hookups	10
Digital component hookups	11
Multi channel input hookups	13
Other hookups	14

Hooking Up and Setting Up the Speaker System

Speaker system hookups	17
Performing initial setup operations	18
Multi channel surround setup	19
Checking the connections	24

Basic Operations

Selecting the component	25
Listening to the sound in another room	27
Changing the display	27

Enjoying Surround Sound

Selecting a sound field	28
Understanding the multi channel surround displays	32
Customizing sound fields	33

Receiving Broadcasts

Storing FM stations automatically (AUTOBETICAL)*	38
Direct tuning	38
Automatic tuning	39
Preset tuning	39
Using the Radio Data System (RDS)* ...	41

Other Operations

Naming preset stations and program sources	43
Recording	43
Using the Sleep Timer	44
Adjustments using the SET UP button	45
CONTROL A1II control system	47

Additional Information

Precautions	49
Troubleshooting	49
Specifications	52
Tables of settings using SURR, LEVEL, EQ, and SET UP buttons	55
Adjustable parameters for each sound field	58
Remote button description**	63
Changing the factory setting of a function button**	66

* Models of area code CEL only.

** STR-DB870 area code CEL only.

Demonstration Mode

The demonstration will activate the first time you turn on the power. When the demonstration starts, the following message appears in the display twice:

"Now Demonstration Mode!! To finish the demonstration, please press POWER KEY while this message appears in the display. Thank you!"

To cancel the demonstration

Press I/⏻ to turn the receiver off during the previous message. The next time you turn the receiver on, the demonstration will not appear.

To view the demonstration

Hold down SET UP and press I/⏻ to turn on the power.

Note

Running the demonstration will clear the receiver's memory. For details on what will be cleared, see "Clearing the receiver's memory" on page 18.

About This Manual

The instructions in this manual are for models STR-DB1070 and STR-DB870. Check your model number by looking at the lower right corner of the front panel. In this manual, the STR-DB1070 (area code U) is used for illustration purposes unless stated otherwise. Any difference in operation is clearly indicated in the text, for example, “STR-DB1070 only”.

Type of differences

Feature	DB1070	DB870
5 audio inputs	●	
4 audio inputs		●

About area codes

The area code of the receiver you purchased is shown on the lower portion of the rear panel (see the illustration below).

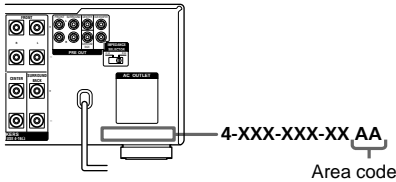

Any differences in operation, according to the area code, are clearly indicated in the text, for example, “Models of area code AA only”.

Tip

The instructions in this manual describe the controls on the receiver. You can also use the controls on the supplied remote if they have the same or similar names as those on the receiver. For details on the use of your remote, see pages 63–66 (for STR-DB870 area code CEL) or refer to the separate operating instructions supplied with the remote.

Note for the supplied remote

For STR-DB870 area code U, CA

The 2ND ROOM button and the ON SCREEN button on the remote are not available.

The items are arranged in alphabetical order.

Refer to the pages indicated in parentheses () for details.

Main unit

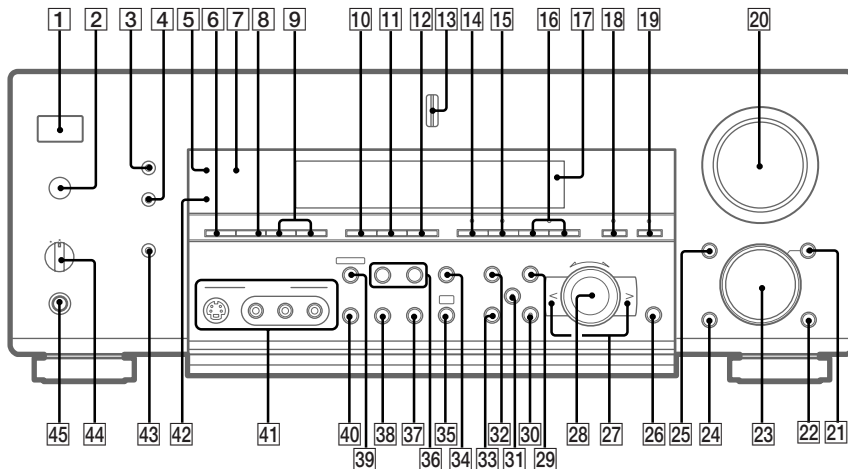

2CH **15** (30)
 2ND ROOM (STR-DB1070 only)
35 (27)
 6.1CH DECODING **10** (31)
 6.1CH DECODING indicator **7**
 (31)
 A.F.D. **14** (30)
 AUDIO SPLIT **21** (25)
 CINEMA STUDIO EX **11** (28)
 Cursor buttons (</>) **27** (19,
 33, 35, 36, 43, 45)
 Digital Cinema Sound indicator
5 (28)
 DIGITAL CONCERT HALL **12**
 (29)
 DIMMER **4** (27)
 DIMMER indicator **42** (27)
 Display **17** (32)
 DISPLAY **3** (27, 41)
 DOOR OPEN **25**

ENTER **26** (43)
 EQ **30** (36)
 EQUALIZER **34** (36)
 FM/AM **6** (38, 39)
 FM MODE **40** (39)
 FUNCTION **23** (24, 25, 38, 39,
 40, 43)
 INPUT MODE **24** (26)
 IR receptor **2**
 Jog dial **28** (19, 33, 35, 36, 43,
 45)
 LEVEL **29** (35)
 MASTER VOLUME **20** (24, 26)
 MEMORY **39** (38, 40)
 MODE +/- **16** (28, 37)
 MULTI/2CH A. DIRECT **18** (26,
 30)
 MULTI CHANNEL DECODING
 indicator **13**
 MUTING **22** (26)

NAME **33** (43)
 NIGHT MODE **19** (31)
 ON SCREEN (STR-DB1070
 only) **43** (10)
 PHONES jack **45** (26)
 PRESET TUNING +/- **9** (40)
 PTY SELECT +/- (Models of
 area code CEL only) **36** (41)
 RDS/PTY (Models of area code
 CEL only) **38** (41)
 SET UP **32** (19, 45)
 SHIFT **8** (40)
 SLEEP (Except for models of area
 code CEL) **38** (44)
 SPEAKERS switch **44** (26)
 STREAM INFO (STR-DB870
 only) **35** (27)
 SURR **31** (33)
 TEST TONE **37** (24)
 TUNING +/- **36** (39)
 VIDEO 3 INPUT jacks **41** (10)
 I/⏻ (power) **1** (18, 23, 24, 37,
 38)

Required cords

Before you get started

- Turn off the power to all components before making any connections.
- Do not connect the AC power cord until all of the connections are completed.
- Be sure to make connections firmly to avoid hum and noise.
- When connecting an audio/video cord, be sure to match the color-coded pins to the appropriate jacks on the components: yellow (video) to yellow; white (left, audio) to white; and red (right, audio) to red.
- When connecting optical digital cords, take the caps off the connectors and insert the cord plugs straight in until they click into place.
- Do not bend or tie the optical digital cord.

A Audio cord (not supplied)



B Audio/video cord (not supplied)

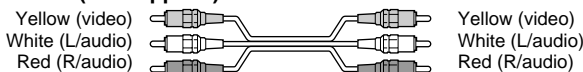

C Video cord (not supplied)

For models of area code U, CA, you can use the video cord of the supplied audio/video/control S cord.



D Optical digital cord (not supplied)

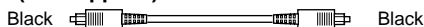

E Coaxial digital cord (not supplied)



F Monaural audio cord (not supplied)



G Audio/video/control S cord (1 for models of area code U, CA)

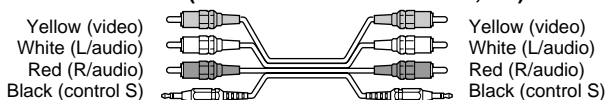

H Control S cord (mini jack) (1 for models of area code U, CA)



Antenna hookups

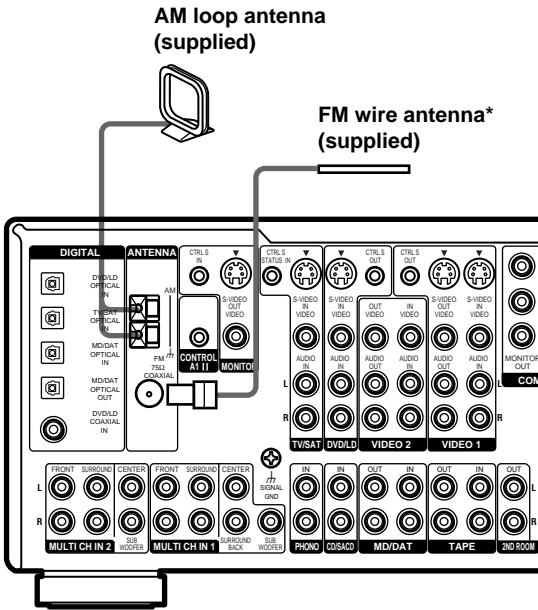

Notes on antenna hookups

- To prevent noise pickup, keep the AM loop antenna away from the receiver and other components.
- Be sure to fully extend the FM wire antenna.
- After connecting the FM wire antenna, keep it as horizontal as possible.
- Do not use the \hbar SIGNAL GND terminal for grounding the receiver.

* The shape of the connector varies depending on the area code.

Audio component hookups

STR-DB1070

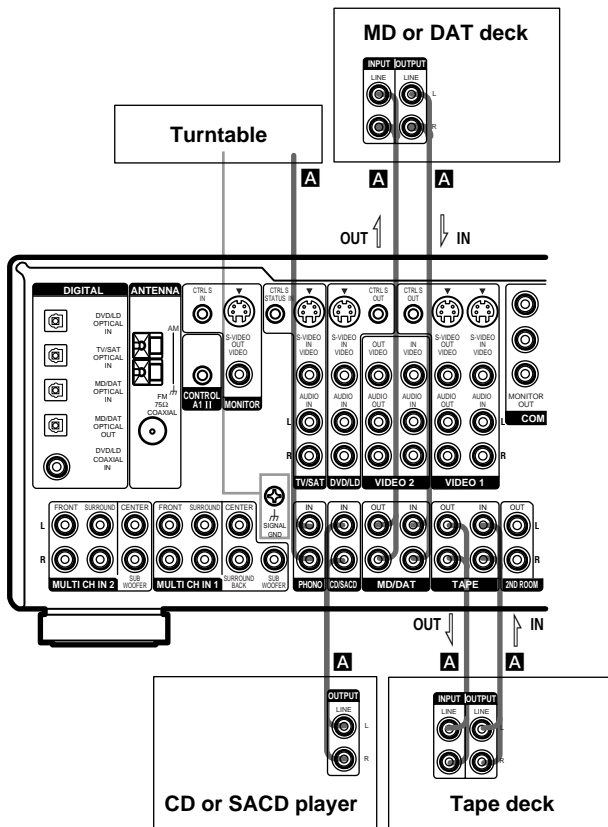

Note on audio component hookups

If your turntable has a ground wire, connect it to the \hbar SIGNAL GND terminal.

STR-DB870

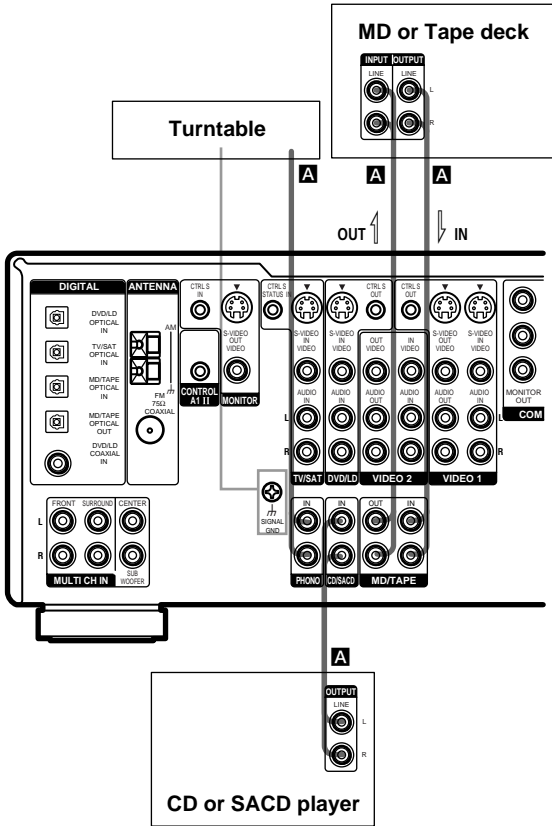

Note on audio component hookups

If your turntable has a ground wire, connect it to the \hbar SIGNAL GND terminal.

Video component hookups

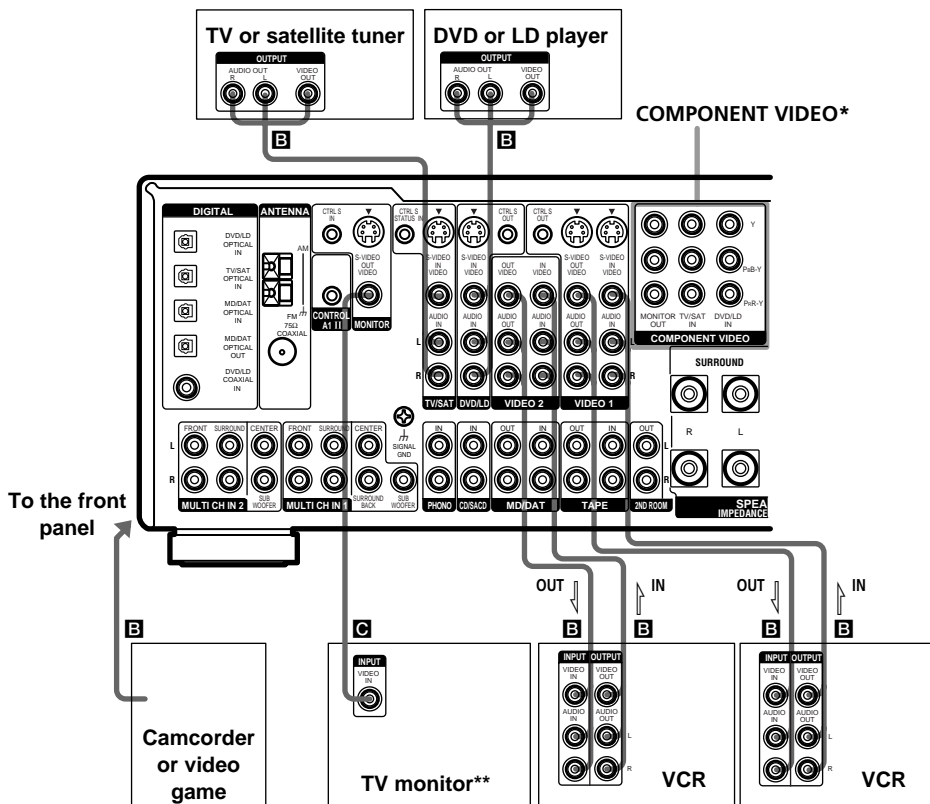

* Models of area code U, CA only.

** For STR-DB1070, you can display the SET UP, SURR, LEVEL, and EQ parameters and selected sound field by pressing ON SCREEN.

Note on video component hookups

You can connect your TV's audio output jacks to the TV/SAT AUDIO IN jacks on the receiver and apply sound effects to the audio from the TV. In this case, do not connect the TV's video output jack to the TV/SAT VIDEO IN jack on the receiver. If you are connecting a separate TV tuner (or satellite tuner), connect both the audio and video output jacks to the receiver as shown above.

If you have a TV, satellite tuner, DVD player, or LD player with COMPONENT VIDEO (Y, B-Y, R-Y) output jacks and a monitor with COMPONENT VIDEO input jacks, use a video cord (not supplied) to connect to the receiver.

Tip

When using the S-video jacks instead of the video jacks, your monitor must also be connected via an S-video jack. S-video signals are on a separate bus from the video signals and will not be output through the video jacks.

Notes

- If you make COMPONENT VIDEO connections, nothing is displayed on the on-screen display.
- On this receiver, the component video signals are not compatible with S-video signals nor video signals.

Digital component hookups

Connect the digital output jacks of your DVD player and satellite tuner (etc.) to the receiver's digital input jacks. To fully enjoy multi channel surround sound, five speakers (two front speakers, two surround speakers, and a center speaker) and a sub woofer are required. For 6.1 channel surround sound (STR-DB1070 only), you will also need a surround back speaker. You can also connect an LD player with an RF OUT jack via an RF demodulator, like the Sony MOD-RF1 (not supplied).

Note

You cannot connect an LD player's DOLBY DIGITAL RF OUT jack directly to this unit's digital input jacks. You must first convert the RF signal to either an optical or coaxial digital signal. For details, see "Troubleshooting" on page 49.

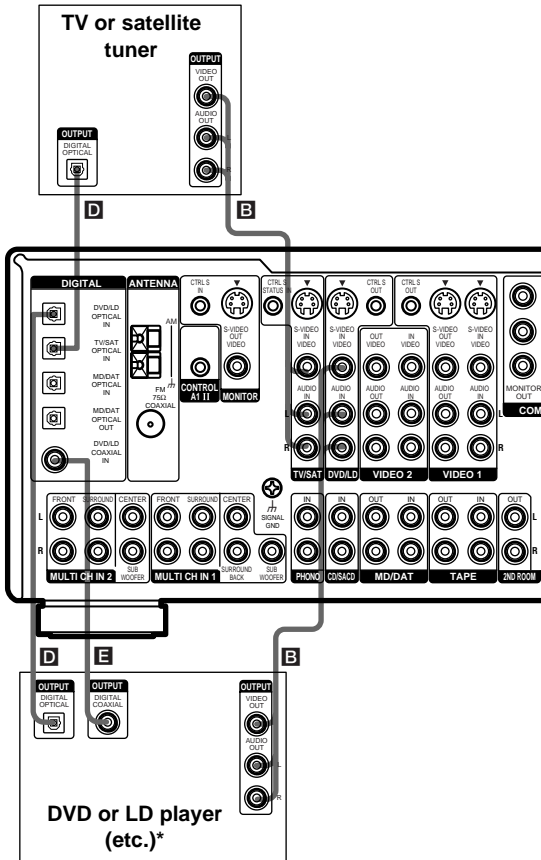

* Make either coaxial or optical connections. We recommend making coaxial connections instead of optical connections.

Digital component hookups (continued)

Connect the digital output jacks of your MD or DAT deck to the receiver's digital input jack and connect the digital input jacks of your MD or DAT deck to the receiver's digital output jack. These connections allow you to make digital recordings of TV broadcasts, etc.

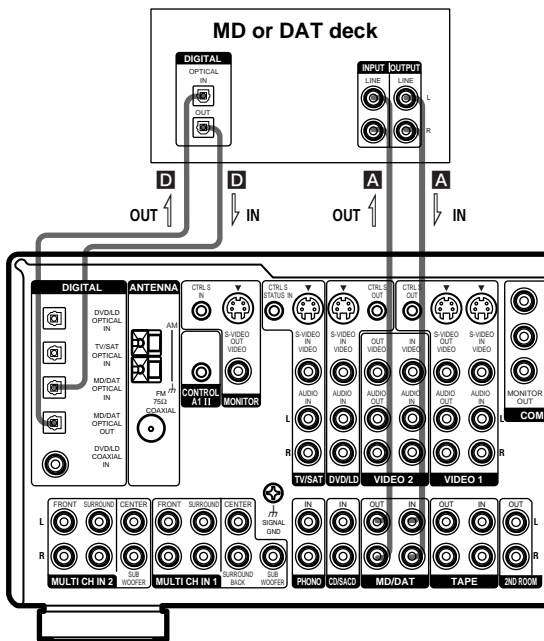

Notes

- You cannot make a digital recording of digital multi channel surround signals.
- To make a digital recording from your CD or SACD player, connect the CD or SACD player's digital output directly to the digital input on your MD or DAT deck. Refer to the operating instructions supplied with your CD or SACD player and MD or DAT deck for details.
- The DVD/LD OPTICAL IN and COAXIAL jacks are compatible with 96 kHz, 48 kHz, 44.1 kHz and 32 kHz sampling frequencies. The other OPTICAL jacks are compatible with 48 kHz, 44.1 kHz and 32 kHz sampling frequencies.
- It is not possible to record analog signals to the components connected to TAPE and VIDEO jacks with only digital connections. To record analog signals, make analog connections. To record digital signals, make analog and digital connections.
- To input signals with 96 kHz sampling frequencies, connect to the DVD/LD OPTICAL IN or COAXIAL jacks. Using other jacks may result in intermittent sound.
- The MD/DAT OPTICAL OUT jack is compatible with 48 kHz, 44.1 kHz and 32 kHz sampling frequencies. Outputting signals with 96 kHz sampling frequencies from this jack may result in intermittent sound.

Multi channel input hookups

Although this receiver incorporates a multi channel decoder, it is also equipped with multi channel input jacks. These connections allow you to enjoy multi channel software encoded in formats other than Dolby Digital and DTS. If your DVD player is equipped with multi channel output jacks, you can connect them directly to the receiver to enjoy the sound of the DVD player's multi channel decoder. Alternatively, the multi channel input jacks can be used to connect an external multi channel decoder.

To fully enjoy multi channel surround sound, five speakers (two front speakers, two surround speakers, and a center speaker) and a sub woofer are required. For 6.1 channel surround sound (STR-DB1070 only), you will also need a surround back speaker. Refer to the operating instructions supplied with your DVD player, multi channel decoder, etc., for details on the multi channel hookups.

Notes

- When using the connections described below, adjust the level of the surround speakers and sub woofer from the DVD player or multi channel decoder.
- See page 17 for details on speaker system hookup.
- (For STR-DB1070) When you set the center and surround back speakers to use as the surround back right and left speakers in the speaker settings, the signal input at the MULTI CH IN CENTER jack is directly output from the surround back right speaker and the signal input at the MULTI CH IN SURROUND BACK jack is directly output from the surround back left speaker.
(For STR-DB870) When you set the center speaker to use as the surround back speaker in the speaker settings, the signal input at the MULTI CH IN CENTER jack is directly output from the surround back speaker.
For details about the speaker settings, refer to "Multi channel surround setup" on page 19.

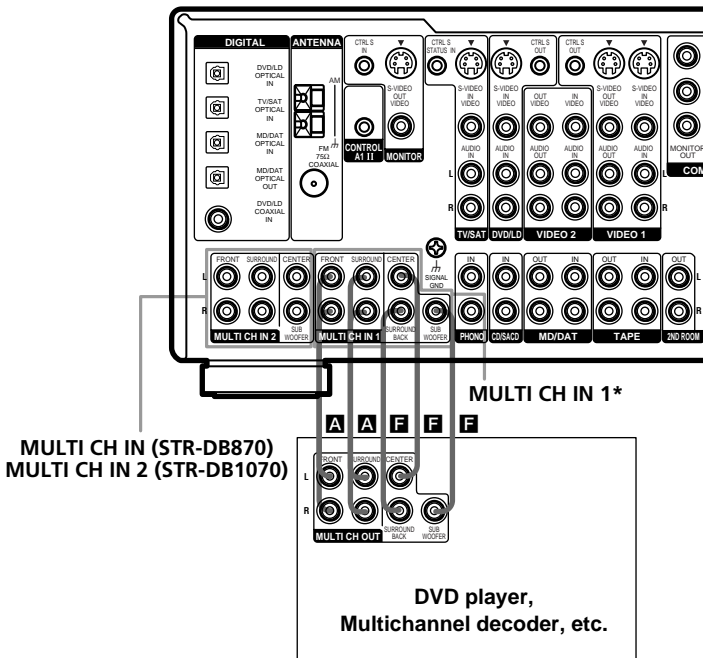

* STR-DB1070 only.

Other hookups

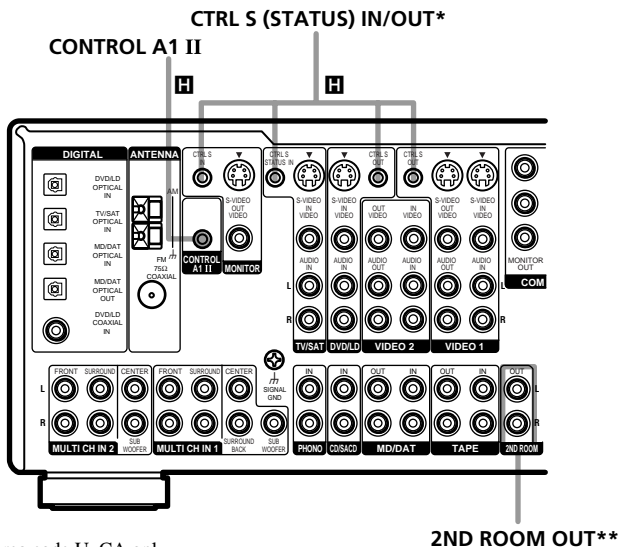

* Models of area code U, CA only.

** STR-DB1070 only.

CONTROL A1 II hookup

- If you have a CONTROL A1 II compatible Sony CD player, SACD player, tape deck, or MD deck

Use a CONTROL A1 cord (mini jack) (not supplied) to connect the CONTROL A1 II jack on the CD player, SACD player, tape deck, or MD deck to the CONTROL A1 II jack on the receiver. Refer to “CONTROL A1 II control system” on page 47 and the operating instructions supplied with your CD player, SACD player, tape deck, or MD deck for details.

Note

If you make CONTROL A1 II connections from the receiver to an MD deck that is also connected to a computer, do not operate the receiver while using the “Sony MD Editor” software. This may cause a malfunction.

- If you have a Sony CD changer with a COMMAND MODE selector

If your CD changer’s COMMAND MODE selector can be set to CD 1, CD 2, or CD 3, be sure to set the command mode to “CD 1” and connect the changer to the CD jacks on the receiver.

If, however, you have a Sony CD changer with VIDEO OUT jacks, set the command mode to “CD 2” and connect the changer to the VIDEO 2 jacks on the receiver.

S-LINK CONTROL S hookup

(Models of area code U, CA only)

If you have a S-LINK CONTROL S-compatible Sony TV, satellite tuner, monitor, DVD player or VCR, use an audio/video/control S connecting cord (supplied) or a control S connecting cord (supplied) to connect the CTRL S (STATUS) IN (for TV, satellite tuner, or monitor) or OUT (for VCR, etc.) jack on the receiver to the appropriate S-LINK jack on the respective component. Refer to the operating instructions supplied with your TV, satellite tuner, monitor, VCR, etc., for details.

The following illustration is an example of S-LINK CONTROL S hookups between the receiver, a TV, a VCR, and a DVD player. When your TV is connected to the receiver as shown below, the TV input mode will change to video input whenever you turn on the receiver. When you connect the receiver as shown below, input mode of the receiver changes to VIDEO 1 or DVD/LD whenever you play your VCR or DVD.

The following connections also change the input mode of the receiver to TV whenever you operate your TV.

TV

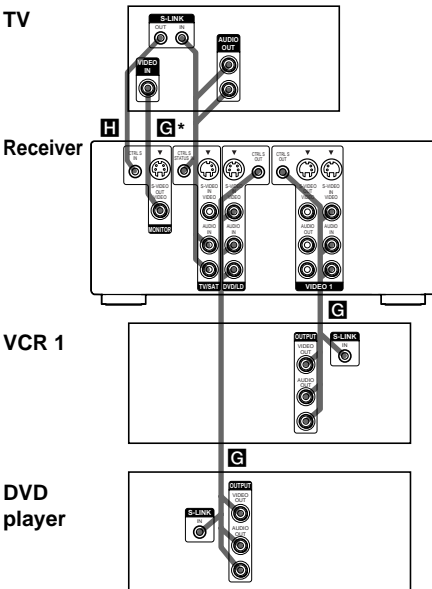

* Pull the video cord away from the supplied audio/video/control S cable.

Note

Refer to the operating instructions supplied with your TV for details regarding the operations you can control from your TV.

2ND ROOM hookup

(STR-DB1070 only)

You can use the 2ND ROOM OUT jacks to output the audio signals of the selected component to a stereo amplifier located in another room (see page 27).

Setting the voltage selector

If your receiver has a voltage selector on the rear panel, check that the voltage selector is set to the local power supply voltage. If not, use a screwdriver to set the selector to the correct position before connecting the AC power cord to a wall outlet.

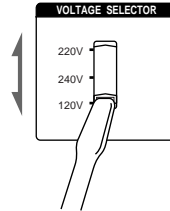

continued

Other hookups (continued)

Connecting the AC power cord

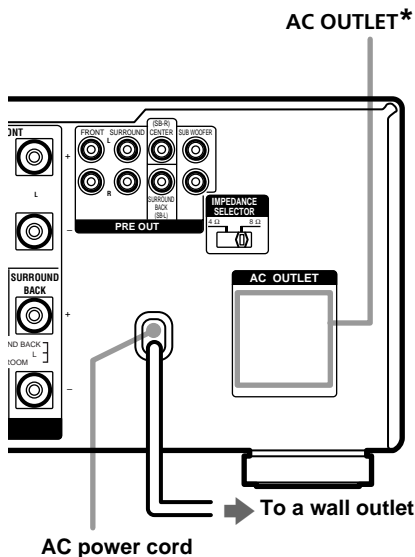

Caution

Make sure that the total power consumption of the component(s) connected to the receiver's AC OUTLET(s) does not exceed the wattage stated on the rear panel. Do not connect high-wattage electrical home appliances such as electric irons, fans, or TVs to this outlet.

* The configuration, shape, and number of AC outlets vary according to the model and country to which the receiver is shipped.

Before connecting the AC power cord of this receiver to a wall outlet, connect the speaker system to the receiver (see page 17).

Connect the AC power cord(s) of your audio/video components to a wall outlet.

If you connect other audio/video components to the AC OUTLET(s) on the receiver, the receiver will supply power to the connected component(s), allowing you to turn the whole system on or off when you turn the receiver on or off.

Speaker system hookups

Required cords

A Speaker cords (not supplied)

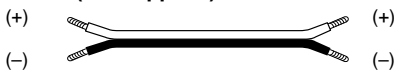

B Monaural audio cord (not supplied)

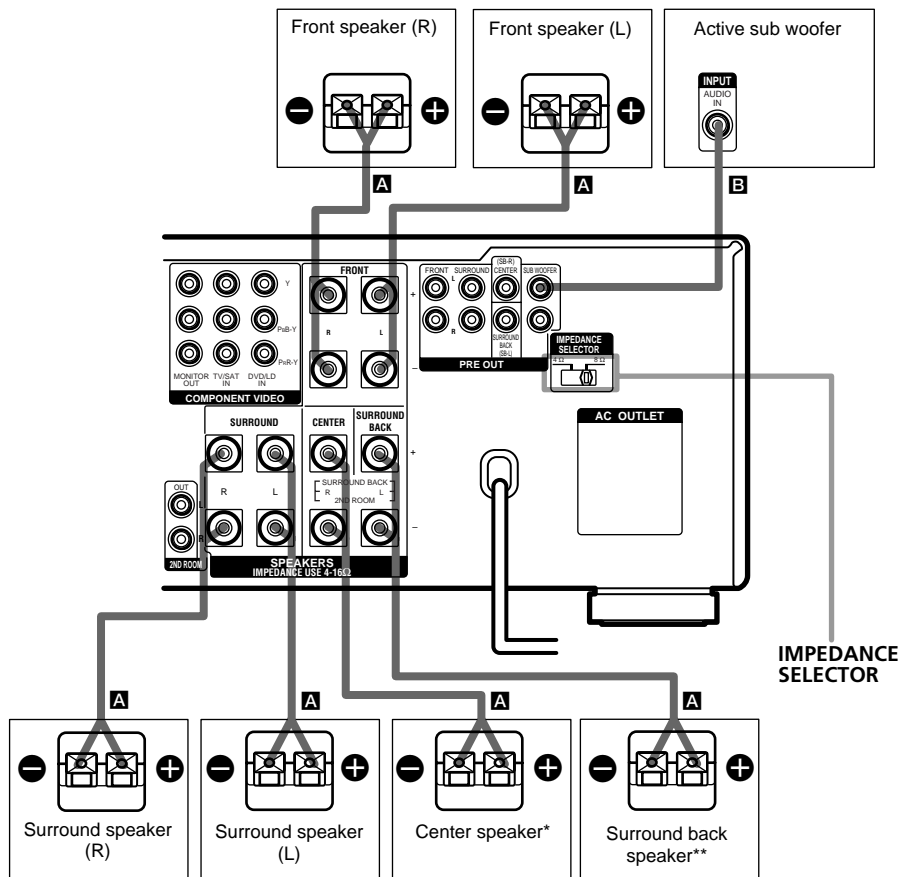
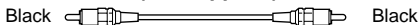

* For STR-DB870, you can connect a surround back speaker.

** STR-DB1070 only. For STR-DB1070, you can use the connected center and surround back speakers as surround back right and left speakers. (See page 21.) Make sure to connect correctly as indicated on the rear panel. You can also use the center and surround back speakers as right and left speakers in the 2nd room. See the next page.

Speaker system hookup (continued)

Tips

- You can connect an active sub woofer to either of the two jacks. The remaining jack can be used to connect a second active sub woofer.
- To connect certain speakers to another power amplifier, use the PRE OUT jacks. The same signal is output from both the SPEAKERS jacks and the PRE OUT jacks. For example, if you want to connect just the front speakers to another amplifier, connect that amplifier to the PRE OUT FRONT L and R jacks.

2ND ROOM hookup (STR-DB1070 area code U, CA only)

You can use the center and surround back speakers as right and left speakers in the 2nd room (See page 27). Make sure to connect correctly as indicated on the rear panel.

Tip

When outputting the sound in the 2nd room, the source signal for the 2nd room is output from PRE OUT CENTER and SURROUND BACK jacks.

Speaker impedance

To enjoy multi channel surround, connect front, center, surround, and surround back speakers with a nominal impedance of 8 ohms or higher, and set the IMPEDANCE SELECTOR to “8Ω”. Check the operating instructions supplied with your speakers if you’re not sure of their impedance. (This information is usually printed on a label on the back of the speaker.)

You may connect a pair of speakers with a nominal impedance between 4 and 8 ohms to all of the speaker terminals. However, even if one speaker within this range is connected, set the IMPEDANCE SELECTOR to “4Ω”.

Note

Be sure to turn the power off when setting the IMPEDANCE SELECTOR.

Performing initial setup operations

Once you have hooked up the speakers and turned on the power, clear the receiver’s memory. Then specify the speaker parameters (size, position, etc.) and perform any other initial setup operations necessary for your system.

Tip

To check the audio output during settings (to set up while outputting the sound), check the connection (see page 24).

Clearing the receiver’s memory

Before using your receiver for the first time, or when you want to clear the receiver’s memory, do the following.

This procedure is not necessary if the demonstration activates when you turn on the power.

1 Turn off the receiver.

2 Hold down I/⏻ for 5 seconds.

The demonstration starts (see page 3) and all of the following items are reset or cleared:

- All preset stations are reset or cleared.
- All sound field parameters are reset to their factory settings.
- All index names (of preset stations and program sources) are cleared.
- All SET UP parameters are reset to their factory settings.
- The sound field memorized for each program source and preset stations are cleared.
- The master volume is set to $-\infty$ dB.

Performing initial setup operations

Before using your receiver for the first time, adjust SET UP parameters so that the receiver correspond to your system. For the adjustable parameters, see the table on page 57. See pages 19–24 for speaker settings and pages 45–46 for other settings.

Multi channel surround setup

For the best possible surround sound, all speakers should be the same distance from the listening position (A).

However, the receiver lets you to place the center speaker up to 1.5 meters (5 feet) closer (B), the surround speakers up to 4.5 meters (15 feet) closer (C) and the surround back speakers up to 4.5 meters (15 feet) closer (D) to the listening position.

The front speakers can be placed from 1.0 to 12.0 meters (3 to 40 feet) from the listening position (A).

You can place the surround speakers either behind you or to the side, depending on the shape of your room (etc.).

You can use the center speaker as a surround back speaker (STR-DB870) or use the center and surround back speakers as surround back left and right speakers (STR-DB1070).

When placing surround speakers to your side (STR-DB1070)

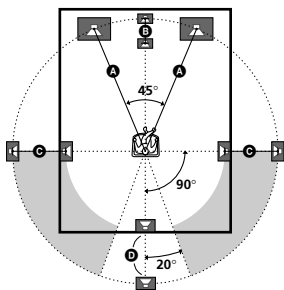

When placing surround speakers behind you

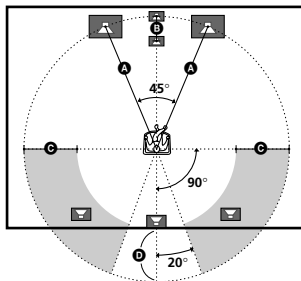

Note

Do not place the center speaker farther away from the listening position than the front speakers.

Tip

When setting up the surround back speaker, set the speaker at least 1 meter behind the listening position. It is recommended to place the speaker at an equal distance from the surround left and right speakers. If there is no space behind the listening position, set the speaker above the listening position by placing it on a stand or hanging it from the ceiling. To prevent speaker damage or injury in case the speaker falls, make sure that it is properly fixed in place.

Specifying the speaker parameters

- 1** Press SET UP.
- 2** Press the cursor buttons (< or >) to select the parameter you want to adjust.
- 3** Turn the jog dial to select the setting you want.
The setting is entered automatically.
- 4** Repeat steps 2 and 3 until you have set all of the parameters that follow.

continued

Multi channel surround setup (continued)

Initial settings

Parameter	Initial setting
FRONT	LARGE
CENTER	LARGE
SURROUND	LARGE
SURR BACK*	LARGE
SURR BACK L/R**	NO
SUB WOOFER	YES
FRONT XX.X meter	5.0 meter
CENTER XX.X meter	5.0 meter
SURROUND XX.X meter	3.5 meter
SURR BACK XX.X meter	3.5 meter
SUB WOOFER XX.X meter	5.0 meter
S.W PHASE	NORMAL
DISTANCE UNIT	METER***
SURR POSI.	SIDE
SURR HEIGHT	LOW
SURR BACK HGT.	LOW
FRONT SP > XXX Hz	STD (120 Hz)
CENTER SP > XXX Hz	STD (120 Hz)
SURROUND SP > XXX Hz	STD (120 Hz)
SURR BACK SP > XXX Hz	STD (120 Hz)
LFE HIGH CUT > XXX Hz	STD (120 Hz)

* For STR-DB870, you can set this parameter only when the center speaker is set to “NO”.

** STR-DB1070 only.

***Except for models of area code U, CA.

■ Front speaker size (FRONT)

- If you connect large speakers that will effectively reproduce bass frequencies, select “LARGE”. Normally, select “LARGE”.
- If the sound is distorted, or you feel a lack of surround effects when using multi channel surround sound, select “SMALL” to activate the bass redirection circuitry and output the front channel bass frequencies from the sub woofer.
- When the front speakers are set to “SMALL”, the center, surround, and surround back speakers are also automatically set to “SMALL” (unless previously set to “NO”).

■ Center speaker size (CENTER)

- If you connect a large speaker that will effectively reproduce bass frequencies, select “LARGE”. Normally, select “LARGE”. However, if the front speakers are set to “SMALL”, you cannot set the center speaker to “LARGE”.
- If the sound is distorted, or you feel a lack of surround effects when using multi channel surround sound, select “SMALL” to activate the bass redirection circuitry and output the center channel bass frequencies from the front speakers (if set to “LARGE”) or sub woofer.*1
- If you do not connect a center speaker, select “NO”. The sound of the center channel will be output from the front speakers.*2
- If you use the center speaker in the 2nd room, select “2ND ROOM”. When the center speaker is set to “2ND ROOM”, the surround back speaker is also automatically set to “2ND ROOM” (unless previously set to “NO”) (STR-DB1070 area code U, CA only).

■ Surround speaker size (SURROUND)

- If you connect large speakers that will effectively reproduce bass frequencies, select “LARGE”. Normally, select “LARGE”. However, if the front speakers are set to “SMALL”, you cannot set the surround speakers to “LARGE”.
- If the sound is distorted, or you feel a lack of surround effects when using multi channel surround sound, select “SMALL” to activate the bass redirection circuitry and output the surround channel bass frequencies from the sub woofer or other “LARGE” speakers.
- If you do not connect surround speakers, select “NO”.*3

Tip

*1–*3 correspond to the following Dolby Pro Logic modes

*1 NORMAL

*2 PHANTOM

*3 3 STEREO

■ **Surround back speaker size (SURR BACK)**

For STR-DB870, you can set this parameter only when the center speaker is set to “NO”.

- If you connect a large speaker that will effectively reproduce bass frequencies, select “LARGE”. Normally, select “LARGE”. However, if the front speakers are set to “SMALL”, you cannot set the surround back speaker to “LARGE”.
- If the sound is distorted, or you feel a lack of surround effects when using multi channel surround sound, select “SMALL” to activate the bass redirection circuitry and output the center channel bass frequencies from the front speakers (if set to “LARGE”) or sub woofer.
- If you do not connect a surround back speaker, select “NO”.
- If you use the surround back speaker in the 2nd room, select “2ND ROOM”. When the surround back speaker is set to “2ND ROOM”, the center speaker is also automatically set to “2ND ROOM” (unless previously set to “NO”) (STR-DB1070 area code U, CA only).

Tip

Internally, the LARGE and SMALL settings for each speaker determine whether or not the internal sound processor will cut the bass signal from that channel. When the bass is cut from a channel, the bass redirection circuitry sends the corresponding bass frequencies to the sub woofer or other “LARGE” speakers.

However, since bass sounds have a certain amount of directionality, it best not to cut them, if possible. Therefore, even when using small speakers, you can set them to “LARGE” if you want to output the bass frequencies from that speaker. On the other hand, if you are using a large speaker, but prefer not to have bass frequencies output from that speaker, set it to “SMALL”.

If the overall sound level is lower than you prefer, set all speakers to “LARGE”. If there is not enough bass, you can use the equalizer to boost the bass levels. To adjust the equalizer, see page 36.

■ **Surround back speaker single or double (SURR BACK L/R) (STR-DB1070 only)**

- When the center speaker is set to “NO” and you use the center speaker as a surround back right speaker and use the surround back speaker as a surround back left speaker, select “YES”.
- If you use only a surround back speaker, select “NO”.

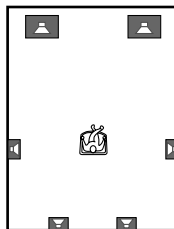

■ **Sub woofer selection (SUB WOOFER)**

- If you connect a sub woofer, select “YES”.
- If you do not connect a sub woofer, select “NO”. This activates the bass redirection circuitry and outputs the LFE signals from other speakers.
- In order to take full advantage of the Dolby Digital bass redirection circuitry, we recommend setting the sub woofer’s cut off frequency as high as possible.

■ **Front speaker distance (FRONT)**

Set the distance from your listening position to the front speakers (A on page 19).

■ **Center speaker distance (CENTER)**

Set the distance from your listening position to the center speaker. Center speaker distance should be set from a distance equal to the front speaker distance (A on page 19) to a distance 1.5 meters (5 feet) closer to your listening position (B on page 19). When this range is exceeded, the display blinks. If you make the setting while the display blinks, you cannot fully enjoy the surround effect.

continued

Multi channel surround setup (continued)

■ Surround speaker distance (SURROUND)

Set the distance from your listening position to the surround speakers. Surround speaker distance should be set from a distance equal to the front speaker distance (A on page 19) to a distance 4.5 meters (15 feet) closer to your listening position (C on page 19). When this range is exceeded, the display blinks. If you make the setting while the display blinks, you cannot fully enjoy the surround effect.

■ Surround back speaker distance (SURR BACK)

Set the distance from your listening position to the surround back speaker(s). Surround back speaker distance should be set from a distance equal to the front speaker distance (A on page 19) to a distance 4.5 meters (15 feet) closer to your listening position (D on page 19). When this range is exceeded, the display blinks. If you make the setting while the display blinks, you cannot fully enjoy the surround effect.

■ Sub woofer distance (SUB WOOFER)

Set the distance from your listening position to the sub woofer.

Tip

The receiver allows you to input the speaker position in terms of distance. However, it is not possible to set the center speaker further than the front speakers. Also, the center speaker cannot be set more than 1.5 meters closer than the front speakers.

Likewise, the surround and surround back speakers can not be set farther away from the listening position than the front speakers. And they can be no more than 4.5 meters closer.

This is because incorrect speaker placement is not conducive to the enjoyment of surround sound.

Please note that, setting the speaker distance closer than the actual location of the speakers will cause a delay in the output of the sound from that speaker. In other words, the speaker will sound like it is farther away.

For example, setting the center speaker distance 1~2 m closer than the actual speaker position will create a fairly realistic sensation of being “inside” the screen. If you cannot obtain a satisfactory surround effect because the surround speakers are too close, setting the surround speaker distance closer (shorter) than the actual distance will create a larger sound stage.

Adjusting these parameter while listening to the sound often results in much better surround sound. Give it a try!

■ Sub woofer phase polarity (S.W PHASE)

Set the sub woofer phase polarity. There is usually no problem when the sub woofer phase polarity is set to “NORMAL”. However, depending on the type of front speakers, the position of the sub woofer, and the cut-off frequency of the sub woofer, setting the phase polarity to “REVERSE” may produce better bass. Besides bass reproduction, the richness and tightness of the overall sound may also be affected. While listening from the main listening position, select the setting that best suits your environment.

■ Distance unit (DISTANCE UNIT)

Lets you select either feet or meters as the receiver of measure for setting distances.

■ Surround speaker position (SURR POSI.)*

This parameter lets you specify the location of your surround speakers for proper implementation of the Digital Cinema Sound surround modes in the “VIRTUAL” sound fields. Refer to the illustration below.

- Select “SIDE” if the location of your surround speakers corresponds to section **A**.
- Select “MIDDLE” if the location of your surround speakers corresponds to section **B**.
- Select “BEHIND” if the location of your surround speakers corresponds to section **C**. This parameter is available only when the surround back speaker size is set to “NO”.

This setting only effects the surround modes in the “VIRTUAL” sound fields.

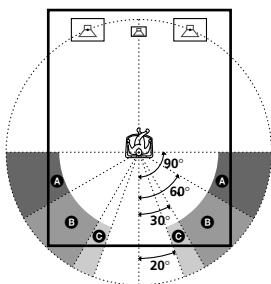

■ Surround speaker height (SURR HEIGHT)*/Surround back speaker height (SURR BACK HGT.)**

This parameter lets you specify the height of your surround and surround back speaker(s) for proper implementation of the Digital Cinema Sound surround modes in the “VIRTUAL” sound fields. Refer to the illustration below.

This setting only effects the surround modes in the “VIRTUAL” sound fields.

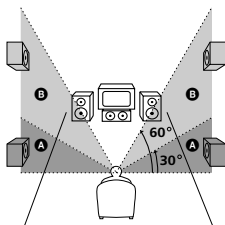

* These parameters are not available when “Surround speaker size (SURROUND)” is set to “NO”.

** This parameter is not available when “Surround back speaker size (SURR BACK)” is set to “NO” or “2ND ROOM”.

Tip

The surround/surround back speaker position parameter is designed specifically for implementation of the Digital Cinema Sound modes in the “VIRTUAL” sound fields.

With the Digital Cinema Sound modes, speaker position is not as critical as other modes. All of the modes in the “VIRTUAL” sound fields were designed under the premise that the surround speaker would be located behind the listening position, but presentation remains fairly consistent even with the surround speakers positioned at a rather wide angle. However, if the speakers are pointing toward the listener from the immediate left and right of the listening position, the “VIRTUAL” sound fields will not be effective unless the surround speaker position parameter is set to “SIDE”.

Nevertheless, each listening environment has many variables, like wall reflections, and you may obtain better results using “BEHIND” or “MIDDLE” if your speakers are located high above the listening position, even if they are to the immediate left and right.

Therefore, although it may result in a setting contrary to the “Surround speaker position” explanation, we recommend that you playback multi channel surround encoded software and listen to the effect each setting has on your listening environment. Choose the setting that provides a good sense of spaciousness and that best succeeds in forming a cohesive space between the surround sound from the surround speakers and the sound of the front speakers. If you are not sure which sounds best, select “BEHIND” and then use the speaker distance parameter and speaker level adjustments to obtain proper balance.

■ Front speaker crossover frequency (FRONT SP >)

Lets you adjust the front speaker bass crossover frequency when the front speakers are set to “SMALL”.

■ Center speaker crossover frequency (CENTER SP >)

Lets you adjust the center speaker bass crossover frequency when the center speaker is set to “SMALL”.

■ Surround speaker crossover frequency (SURROUND SP >)

Lets you adjust the surround speaker bass crossover frequency when the surround speakers are set to “SMALL”.

continued

Multi channel surround setup (continued)

■ Surround back speaker crossover frequency (SURR BACK SP >)

Lets you adjust the surround back speaker bass crossover frequency when the surround back speaker is set to "SMALL".

Note

You can set the FRONT, CENTER, SURROUND and SURR BACK parameters when the speaker size is set to "SMALL".

■ LFE high cut filter (LFE HIGH CUT >)

Lets you select the cut off frequency of the LFE channel high cut filter. Normally, select "STD". When using a passive sub woofer powered by a separate power amplifier, it may be better to change the cut off frequency.

Adjusting the speaker level

Use the remote while seated in your listening position to adjust the level of each speaker.

Note

The receiver incorporates a new test tone with a frequency centered at 800 Hz for easier speaker level adjustment.

1 Press I/⏻ to turn on the receiver.

2 Press TEST TONE on the remote.

"TEST TONE" appears in the display and you will hear the test tone from each speaker in sequence.

3 To change the test tone mode, press the cursor buttons* (←/→ or </>) to select the mode you want.

Mode	The test tone output
NORMAL	The test tone is output from each speaker in sequence.
PHASE	The test tone is output from two speakers at a time in sequence. (There is no sound output from the sub woofer.) You can also adjust the balance between speakers.

2CH SWAP** You can adjust the speaker levels while listening to the source (not the test tone). Turn on the connected component, start playback, then turn FUNCTION to select the component (except when connected to the MULTI CH IN jacks). The sound for the front L/R speakers is output from the surround R/L speakers. You can adjust the level of surround speakers from the listening position.

* MENU +/- buttons on the remote for STR-DB870 area code CEL.

** You cannot select "2CH SWAP" when "2CH ANALOG DIRECT" is selected (page 26).

4 Adjust the LEVEL parameters so that the level of the test tone from each speaker sounds the same when you are in your main listening position.

Press LEVEL to adjust the balance and level of speakers. For details on the LEVEL menu, see page 35.

While adjusting, the test tone is output from the speaker whose adjustment is performed.

5 Press TEST TONE again to turn off the test tone.

Tips

- You can adjust the level of all speakers at the same time. Turn MASTER VOLUME on the main unit or press MASTER VOLUME +/- on the remote.
- In step 3, you can select the mode using the jog dial on the receiver.

Notes

- The adjusted value are shown in the display during adjustment.
- Although these adjustments can also be made via the front panel using the LEVEL menu (when the test tone is output, the receiver switches to the LEVEL menu automatically), we recommend you follow the procedure described above and adjust the speaker levels from your listening position using the remote.

Checking the connections

After connecting all of your components to the receiver, do the following to verify that the connections were made correctly.

1 Press I/⏻ to turn on the receiver.

2 Turn on the component that you connected (e.g., CD player or tape deck).

3 Rotate FUNCTION to select the component (program source).

4 Start playing.

If you do not obtain normal sound output after performing this procedure, see "Troubleshooting" on page 49 and take the appropriate measures to correct the problem.

Selecting the component

FUNCTION control

Turn FUNCTION control to select the component you want to use.

To select	Rotate to light
VCR	VIDEO 1 or VIDEO 2
Camcorder or video game	VIDEO 3
DVD or LD player	DVD/LD
TV or satellite tuner	TV/SAT
Tape deck	TAPE (STR-DB1070)
MD or Tape deck	MD/TAPE (STR-DB870)
MD or DAT deck	MD/DAT (STR-DB1070 only)
CD or SACD player	CD/SACD
Built in tuner	TUNER
Turntable	PHONO

After turning on the component you selected, select the component and play the program source.

- After selecting VCR, camcorder, video game, DVD player, or LD player, turn on the TV and set the TV's video input to match the component you selected.

AUDIO SPLIT

Press AUDIO SPLIT to assign the audio input for each function. This function is convenient when you are using a number of digital components. You can select the audio input assigned by this function using INPUT MODE (page 26).

You cannot assign the audio input for TUNER.

1 Turn FUNCTION to select the source for audio input assignment.

2 Press AUDIO SPLIT.

3 Turn FUNCTION to select the audio input.

The audio input you can assign differs depending on the function.

DVD/LD

NO ASSIGN → DIGITAL: ONLY COAX → DIGITAL: ONLY OPT → ONLY ANALOG INPUT

TV/SAT, MD/DAT (MD/TAPE)

NO ASSIGN → DVD/LD (COAXIAL) → ONLY ANALOG INPUT

Analog functions except for PHONO

NO ASSIGN → DVD/LD (COAXIAL) →

DVD/LD (OPTICAL) → TV/SAT (OPTICAL)

→ MD/DAT (OPTICAL)

PHONO

NO ASSIGN → VIDEO 1 → VIDEO 2 →

VIDEO 3 → DVD/LD (ANALOG) →

TV/SAT (ANALOG) → TAPE → MD/DAT (ANALOG) → CD/SACD

4 Press AUDIO SPLIT.

If you do not press AUDIO SPLIT within

4 seconds, the receiver automatically assigns the selected audio input.

Tips

- If you do not assign, select "NO ASSIGN".
- If you select "DIGITAL: ONLY COAX" or "DIGITAL: ONLY OPT" for DVD/LD, only coaxial or optical digital input is automatically selected for DVD/LD.

continued

Selecting the component (continued)

INPUT MODE

Press INPUT MODE to select the input mode for your digital components. You can also select the COAXIAL or OPTICAL audio input of other functions assigned by AUDIO SPLIT. Each time you press the button, the input mode of the currently selected component switches.

Select	To
AUTO 2CH	Give priority to the analog audio signals input to the AUDIO IN (L/R) jacks when there is no digital signals.
COAXIAL FIXED	Specify the digital audio signals input to the DIGITAL COAXIAL input jacks.
OPTICAL FIXED	Specify the digital audio signals input to the DIGITAL OPTICAL input jacks.
ANALOG 2CH FIXED	Specify the analog audio signals input to the AUDIO IN (L/R) jacks.

When the MULTI CH (for STR-DB1070, MULTI CH 1 or 2) is assigned to a specific function using SET UP menu (page 45), the followings are displayed instead of “AUTO 2CH” and “ANALOG 2CH FIXED”.

Select	To
AUTO MULTI CH (1* or 2*)	Give priority to the analog audio signals input to the MULTI CH IN (for STR-DB1070, MULTI CH IN 1 or 2) jacks when there is no digital signals.
MULTI CH 1 or 2 FIXED	Specify the analog audio signals input to the MULTI CH IN (for STR-DB1070, MULTI CH IN 1 or 2) jacks.

* STR-DB1070 only.

MULTI/2CH A. DIRECT

Press MULTI/2CH A. DIRECT to enjoy the audio source connected to the MULTI CH IN (for STR-DB1070, MULTI CH IN 1 or 2) jacks or analog 2 channel input jacks. Only volume control and the front speaker balance can be adjusted when set to 2CH ANALOG DIRECT. When set to MULTI DIRECT (for STR-DB1070, MULTI 1 or 2 DIRECT), you can adjust balance and level of all the speakers. When this function is on, the surround effects are turned off.

Select	To
MULTI (for STR-DB1070, MULTI 1 or 2 DIRECT)	Enjoy the audio source connected to the MULTI CH IN (for STR-DB1070, MULTI CH IN 1 or 2) jacks. MULTI CH IN (1 or 2) indicator lights up in the display. This mode is suitable for enjoying high quality analog source.
2CH ANALOG DIRECT	Enjoy the audio source connected to analog 2 channel jacks. This mode is suitable for enjoying high quality analog source.

SPEAKERS switch

Select	To
ON	Output the sound from the speakers connected to the SPEAKERS terminals.
OFF	No speaker output.

MUTING

Press MUTING to mute the sound. The muting function is canceled when turning the power on or off, disconnecting the power cord, or turning the MASTER VOLUME clockwise to turn the volume up.

PHONES

Use to connect headphones.

- When the headphones are connected, speaker output is automatically cancelled and “SP. OFF” lights up in the display.
- When the headphones are connected, selectable sound fields are HEADPHONE (2CH), HEADPHONE (DIRECT), and HEADPHONE THEATER (see page 30).

Listening to the sound in another room

(STR-DB1070 only)

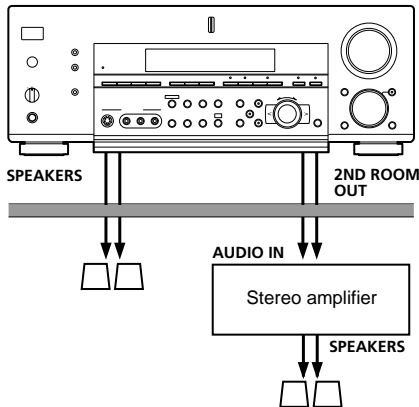

Press 2ND ROOM repeatedly to select the analog audio signals for output to a stereo amplifier or speakers*¹ in another room. For details on the connection, see pages 15 and 17.

*¹ Models of area code U, CA only.

Each time you press the button, the audio source changes cyclically as follows:

SOURCE*² → TAPE → MD/DAT → CD/SACD → TUNER

*² The audio signals of the current function is output.

- Even if 2ND ROOM is set to “SOURCE”, the sound from front speakers is not output when MULTI/2CH A. DIRECT is set to MULTI 1 or 2 DIRECT.
- Only signals from components connected to the analog input jacks are output through the 2ND ROOM OUT jacks. No signals are output from components connected to only the digital input jacks.
- When you use AUDIO SPLIT to assign a digital audio input (for example, DVD OPTICAL) to the main function and set 2ND ROOM to “SOURCE”, the analog audio signals of the assigned audio (for example, analog audio input of DVD) is output from the 2ND ROOM OUT jacks.

To output the sound using SPEAKER terminals

(Models of area code U, CA only)

Set 2nd room speaker parameter in the SET UP menu (see page 46).

Use the remote to adjust the volume in the 2nd room. Set the mode of the supplied remote to the 3rd room mode. Refer to the operating instructions supplied with the remote.

Note

The 2nd room speaker setting is automatically set to “OFF” whenever you turn off the receiver.

Changing the display

DISPLAY

Each time you press DISPLAY, the display changes cyclically as follows:

Index name of the component* → Selected component → Sound field applied to the program source

When the tuner is selected

Index name of the preset station* or program station name** → Frequency → Program type indication** → Radio text** → Current time** → Sound field applied to the band or the preset station

* Index name appears only when you have assigned one to the component or preset station (see page 43). Index name does not appear when only blank spaces have been entered, or it is the same as the function.

** During RDS reception only. (Models of area code CEL only. See page 41).

DIMMER

Press DIMMER repeatedly to adjust the brightness of the display (5 steps). DIMMER indicator lights when the dimmer function is activated.

When set to the dimmest setting, the display and the blue LED are turned off.

However, when you press any button, the display becomes the brightest setting temporary.

STREAM INFO (STR-DB870 only)

Press STREAM INFO. The current stream information is displayed for about 4 seconds.

You can take advantage of surround sound simply by selecting one of the receiver's pre-programmed sound fields. They bring the exciting and powerful sound of movie theaters and concert halls into your home. You can also customize the sound fields to obtain the sound you want by changing the various surround parameters.

To fully enjoy surround sound, you must register the number and location of your speakers. See "Multi channel surround setup" starting from page 19 to set the speaker parameters before enjoying surround sound.

Selecting a sound field

You can enjoy surround sound simply by selecting one of the pre-programmed sound fields according to the program you want to listen to.

Press MODE +/- repeatedly to select the sound field you want.

The current sound field is indicated in the display. See pages 28–30 for information on each sound field.

To turn the surround effect off

Press A.F.D., 2CH or MULTI/2CH A, DIRECT (page 30).

Tips

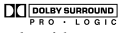
- You can identify the encoding format of program software by looking at its packaging. Dolby Digital discs are labeled with the  logo, and Dolby Surround encoded programs are labeled with the  logo.
- When sound signals with a sampling frequency of 96 kHz are input, the sound signals are output in stereo automatically, and the sound field is turned off.

About DCS (Digital Cinema Sound)

The sound fields with DCS marks use DCS technology. When these sound fields are selected, "Digital Cinema Sound" indicator in the display lights up.

DCS is the concept name of the surround technology for home theater developed by Sony. DCS uses the DSP (Digital Signal Processor) technology to reproduce the sound characteristics of an actual cinema cutting studio in Hollywood.

As the Director's "visual and audio united" effect can be fully reproduced at home, You can much satisfy by enjoying movies at home reproducing powerful theater effect.

■ NORMAL SURROUND

Software with multi channel surround audio signals is played back according to the way it was recorded. Software with 2 channel audio signals is decoded with Dolby Pro Logic to create surround effects.

■ CINEMA STUDIO EX A-C⁽¹⁾⁽²⁾

Uses 3D sound imaging of V. MULTI DIMENSION (page 29) to create 5 sets of virtual speakers surrounding the listener from a single pair of actual surround speakers. (For STR-DB1070) Though this receiver incorporates the 6.1 channel amplifier, you can reproduce the 6.1 channel surround sound with the 5.1 channel speaker settings by creating the virtual surround back speaker through the "VIRTUAL MATRIX 6.1" playback function (page 31).

(For STR-DB870) You can reproduce the 6.1 channel surround sound by creating the virtual surround back speaker through the "VIRTUAL MATRIX 6.1" playback function (page 31).

- CINEMA STUDIO EX A reproduces the sound characteristics of Sony Pictures Entertainment's classic editing studio.
- CINEMA STUDIO EX B reproduces the sound characteristics of Sony Pictures Entertainment's mixing studio which is one of the most up-to-date facilities in Hollywood.
- CINEMA STUDIO EX C reproduces the sound characteristics of Sony Pictures Entertainment's BGM recording studio.

■ **SEMI CINEMA STUDIO EX A–C¹⁾ DCS**

Uses 3D sound imaging of V. SEMI M. DIMENSION to create 5 sets of virtual speakers surrounding the listener from the sound of the front speakers (without using actual rear speakers). You can reproduce the 6.1 channel surround sound by creating the virtual surround back speaker through the “VIRTUAL MATRIX 6.1” playback function (page 31).

- SEMI CINEMA STUDIO EX A reproduces the sound characteristics of Sony Pictures Entertainment’s classic editing studio.
- SEMI CINEMA STUDIO EX B reproduces the sound characteristics of Sony Pictures Entertainment’s mixing studio which is one of the most up-to-date facilities in Hollywood.
- SEMI CINEMA STUDIO EX C reproduces the sound characteristics of Sony Pictures Entertainment’s BGM recording studio.

■ **NIGHT THEATER**

Allows you to retain a theater like environment while listening at low volume levels, such as late at night.

■ **MONO MOVIE**

Creates a theater like environment from movies with monaural soundtracks.

■ **STEREO MOVIE**

Creates a theater like environment from movies recorded with stereo soundtracks.

■ **V. MULTI DIMENSION¹⁾ (Virtual Multi Dimension) DCS**

Uses 3D sound imaging to create an array of virtual surround speakers positioned higher than the listener from a single pair of actual surround speakers. This mode creates 5 sets of virtual speakers surrounding the listener at approximately a 30° angle of elevation.

■ **VIRTUAL MULTI REAR¹⁾ (Virtual Multi Rear) DCS**

Uses 3D sound imaging to create 3 sets of virtual surround speakers from 1 set of actual surround speakers.

■ **V. SEMI M. DIMENSION¹⁾ (Virtual Semi Multi Dimension) DCS**

Uses 3D sound imaging to create virtual surround speakers from the sound of the front speakers without using actual surround speakers. This mode creates 5 sets of virtual speakers surrounding the listener at a 30° angle of elevation.

■ **VIRTUAL ENHANCED A¹⁾ (Virtual Enhanced Surround A) DCS**

Uses 3D sound imaging to create 3 sets of virtual surround speakers from the sound of the front speakers without using actual surround speakers.

■ **VIRTUAL ENHANCED B¹⁾ (Virtual Enhanced Surround B) DCS**

Uses 3D sound imaging to create 1 set of virtual surround speakers from the sound of the front speakers without using actual surround speakers.

■ **DIGITAL CONCERT HALL A, B²⁾**

Reproduces the acoustics of a concert hall using multi-speaker system and 3D sound imaging for software with 2 channel signals like CDs.

- DIGITAL CONCERT HALL A reproduces the sonic character of the CONCERTGEBOUW in Amsterdam, which is famous for its large sound stage due to its reflectivity.
- DIGITAL CONCERT HALL B reproduces the sonic character of the MUSIKVEREIN in Vienna, which is famous for its hall resonance and unique reverberative sound.

■ **CHURCH**

Reproduces the acoustics of a stone church.

■ **OPERA HOUSE**

Reproduces the acoustics of an opera house.

■ **JAZZ CLUB**

Reproduces the acoustics of a jazz club.

continued

Selecting a sound field (continued)

■ DISCO/CLUB

Reproduces the acoustics of a discotheque/dance club.

■ LIVE HOUSE

Reproduces the acoustics of a 300-seat live house.

■ ARENA

Reproduces the acoustics of a 1000-seat concert hall.

■ STADIUM

Reproduces the feeling of a large open-air stadium.

■ GAME

Obtains maximum audio impact from video game software.

When headphones are connected, you can select the following sound fields only:

■ HEADPHONE (2CH)

Outputs the sound in 2 channel (stereo). Standard 2 channel (stereo) sources completely bypass the sound field processing. Multi channel surround formats are downmixed to 2 channel.

■ HEADPHONE (DIRECT)

Outputs the analog signals without digital processing by the equalizer, sound field, etc.

■ HEADPHONE THEATER

Allows you to experience a theater like environment while listening through a pair of headphones.

- 1) "VIRTUAL" sound field: Sound field with virtual speakers. However, setting the SURR menu "VIR. SPEAKERS" parameter to "OFF" when using "CINEMA STUDIO EX A-C" or "SEMI CINEMA STUDIO EX A-C" reproduces the sound characteristics of each cinema production studio without virtual speakers.
- 2) You can select directly by pressing the buttons on the front panel.

Notes

- The effects provided by the virtual speakers may cause increased noise in the playback signal.
- When listening with sound fields that employ the virtual speakers, you will not be able to hear any sound coming directly from the surround speakers.

Use the buttons on the front panel to operate the following modes.

A.F.D. (Auto Format Decoding)

Automatically detects the type of audio signal being input (Dolby Digital, DTS, Dolby Pro Logic, or standard 2 channel stereo) and performs the proper decoding if necessary. This mode presents the sound as it was recorded/encoded, without adding any effects (ex. reverberation).

2CH (2 Channel)

Outputs the sound from the front left and right speakers only. Standard 2 channel (stereo) sources completely bypass the sound field processing. Multi channel surround formats are downmixed to 2 channel.

MULTI/2CH A. DIRECT (Multi/2ch Analog Direct)

The analog input signal is not digitally processed. You can enjoy high quality analog source. Only volume control and the front speaker balance can be adjusted when set to 2CH ANALOG DIRECT. When set to MULTI DIRECT (for STR-DB1070, MULTI 1 or 2 DIRECT), you can adjust balance and level of all the speakers. When this function is on, the equalizer, sound field (etc.) are turned off.

6.1CH DECODING

Press 6.1CH DECODING to adjust the 6.1 channel matrix parameter in the SET UP menu (page 45).

This function works only for the multi channel format [3/2].

This function is effective for the following sound fields.

- A.F.D.*
- NORMAL SURROUND
- CINEMA STUDIO EX A–C
- SEMI CINEMA STUDIO EX A–C
- NIGHT THEATER
- MONO MOVIE
- STEREO MOVIE
- V. MULTI DIMENSION
- VIRTUAL MULTI REAR
- V. SEMI M. DIMENSION
- VIRTUAL ENHANCED A, B

* You can select “AUTO” only.

About the “VIRTUAL MATRIX 6.1” playback

(For STR-DB1070) You can reproduce the 6.1 channel surround sound of the sources encoded in 6.1 channel (see below) in the 5.1 channel speaker settings.

(For STR-DB870) Though this receiver incorporates the 5.1 channel amplifier, you can reproduce the 6.1 channel surround sound of the sources encoded in 6.1 channel (see below).

To enjoy the “VIRTUAL MATRIX 6.1” playback most effectively, use the 6.1CH DECODING function when you select “CINEMA STUDIO EX A–C” or “SEMI CINEMA STUDIO EX A–C”. The sound characteristics of CINEMA STUDIO and the 3D sound imaging create the virtual surround back speaker, and you can enjoy the surround effect as if in the real theater. You can select AUTO/ON/OFF using the 6.1CH DECODING button (page 45).

About 6.1 channel matrix decoding

Some movies released after summer 1999 added a new channel to the preexisting 5.1 channels. The new channel added speakers behind the listening position. In the movie theaters, these speakers are placed on the rear wall, on each side of the projection room’s window.

The 6.1 channel system used in the movie theaters is called Dolby Surround EX system. However, to record on movie film, this 6.1 channel is converted to 5.1 channel using matrix encoding, and the same number of channels are used as Dolby Digital and DTS recordings. Recordings on DVD also use the same signals.

A lot of movie theaters screen movies with matrix encoded 5.1 channel signals and this is not unnatural to the ears. However, when a matrix decoder is used to create surround back speaker signals it simulates the same 6.1 channel sound as Dolby Surround EX system in the movie theaters.

This unit is equipped with a matrix decoder allowing for 6.1 channel sound production.

For STR-DB870, with Virtual 3D technology, the surround back signals can be enjoyed even without an actual surround back speaker. When the center speaker is not used, it is possible to use this channel to output surround back signals.

NIGHT MODE

Allows you to retain a theater like environment, at low volume levels even late at night. Even at a low volume level, you can clearly hear the dialogues and adjust the volume in small steps. This function can be used with other sound field (pages 28–30).

While this function is on, BASS, TREBLE, and EFFECT level rises, and D.RANGE COMP. is automatically set to “MAX”.

This function does not work while MULTI/2CH A. DIRECT is on.

Note

No sound is output from the sub woofer when “2CH” is selected. To listen to 2 channel (stereo) sources using the front left and right speakers and a sub woofer, select “A.F.D.”.

Understanding the multi channel surround displays

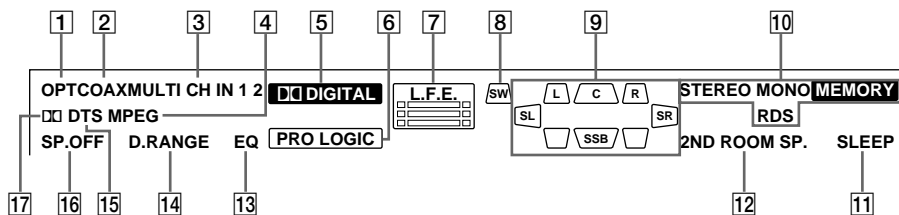

- 1** **OPT**: Lights up when the source signal is a digital signal being input through the OPTICAL terminal.
- 2** **COAX**: Lights up when the source signal is a digital signal being input through the COAXIAL terminal.
- 3** **MULTI CH IN (1/2)**: Lights up when MULTI CH IN (for STR-DB1070, MULTI CH IN 1 or 2) is selected.
- 4** **MPEG**: Lights up when MPEG signals are input.

Note

Only the front 2 channels are compatible with MPEG format. Multi channel surround sound is downmixed and output from the front 2 channels.

- 5** **DIGITAL**: Lights up when the receiver is decoding signals recorded in the Dolby Digital format.
- 6** **PRO LOGIC**: Lights up when the receiver applies Pro Logic processing to 2 channel signals in order to output the center and surround channel signals. However, this indicator does not light if the center and surround speakers are set to “NO”, and “A.F.D.” or “NORMAL SURROUND” is selected.

Note

Pro Logic decoding does not function for MPEG format signals.

- 7** **L.F.E.**: Lights up when the disc being played back contains the LFE (Low Frequency Effect) channel. When the sound of the LFE channel signal is actually being reproduced, the bars underneath the letters lights up to indicate the level. Since the LFE signal is not recorded in all parts of the input signal the bar indication will fluctuate (and may turn off) during playback.

- 8** **SW**: Lights up when sub woofer selection is set to “YES” (page 21) and the audio signal is output from the SUB WOOFER jacks.

- 9** **Playback channel indicators**: The letters (L, C, R, etc.) indicate the channels being played back. The boxes around the letters vary to show how the receiver downmixes the source sound (based on the speakers settings). When using sound fields like “DIGITAL CONCERT HALL”, the receiver adds reverberation based on the source sound.

L (Front Left), R (Front Right), C (Center (monaural)), SL (Surround Left), SR (Surround Right), S (Surround (monaural) or the surround components obtained by Pro Logic processing), SB (Surround Back (the surround back components obtained by 6.1 matrix decoding))

Example:

Recording format (Front /Rear): 3/2
 Output channel: Rear speakers absent
 Sound Field: A.F.D.

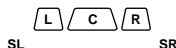

- 10 **Tuner indicators:** Lights up when using the receiver to tune in radio stations, etc. See pages 38–42 for tuner operations.
- 11 **SLEEP:** Lights up when sleep timer is activated.
- 12 **2ND ROOM SP.:** Lights up when the audio signal is output from the 2ND ROOM SPEAKERS (STR-DB1070 area code U, CA only).
- 13 **EQ:** Lights up when the equalizer functions.
- 14 **D.RANGE:** Lights up when dynamic range compression is activated. See page 36 to adjust the dynamic range compression.
- 15 **DTS:** Lights up when DTS signals are input.
- 16 **SP.OFF:** Lights up when headphones are inserted or the SPEAKERS switch is set to OFF.
- 17 **DD:** Lights up when Dolby Digital signals are input.

Customizing sound fields

By adjusting the surround parameters and the equalization of the front, center, surround, and surround back speakers, you can customize the sound fields to suit your particular listening situation.

Once you customize a sound field, the changes are stored in the memory indefinitely. You can change a customized sound field any time by making new adjustments to the parameters.

See the tables starting from page 58 for the parameters available in each sound field.

To get the most from multi channel surround sound

Position your speakers and do the procedures described in “Multi channel surround setup” starting from page 19 before you customize a sound field.

Adjusting the surround parameters

The SURR menu contains parameters that let you customize various aspects of the current sound field. The settings are stored individually for each sound field.

1 Start playing a program source encoded with multi channel surround sound.

2 Press SURR.

The button lights up and the first parameter is displayed.

3 Press the cursor buttons (< or >) to select the parameter you want to adjust.

4 Turn the jog dial to select the setting you want.

The setting is entered automatically.

continued

Customizing sound fields (continued)

Initial settings

Parameter	Initial setting
PRO LOGIC	AUTO
EFFECT	(depends on the sound field)
WALL S_I_H	Midpoint
REVERB S_I_L	Midpoint
FRONT REVERB	STD (STANDARD)
SCREEN DEPTH	MID
VIR. SPEAKERS	ON

Pro Logic (PRO LOGIC)

Lets you specify the Pro Logic decoding setting.

- To set the receiver to perform Pro Logic decoding if Dolby surround encoded flag is ON or if Pro Logic decoding produces a better sound field, select “AUTO”.
- To set the receiver to perform Pro Logic decoding on rear signals, regardless of the Dolby surround encoded flag, select “ON”.
- To set the receiver not to perform Pro Logic decoding, select “NO”.

Note

Pro Logic decoding does not function for MPEG format signals.

Effect level (EFFECT)

Lets you adjust the “presence” of the current surround effect.

Wall type (WALL)

Lets you control the level of the high frequencies to alter the sonic character of your listening environment by simulating a softer (S) or harder (H) wall. The midpoint designates a neutral wall (made of wood).

Reverberation (REVERB)

Lets you control the spacing of the early reflections to simulate a sonically longer (L) or shorter (S) room. The midpoint designates a standard room with no adjustment.

Front reverberation (FRONT REVERB)

This parameter can be used when “DIGITAL CONCERT HALL A, B” is selected. This parameter lets you adjust the amount of reverberations to add to the front signals according to the original reverberations in the source.

- To increase front reverberations, select “WET”.
- To decrease front reverberations, select “DRY”.

Screen depth (SCREEN DEPTH)

In a movie theater, sound seems to come from inside the image reflected on the movie screen. This parameter lets you create the same sensation in your listening room by shifting the sound of the front speakers “into” the screen. “DEEP” provides the greatest amount of screen depth.

Virtual speakers (VIR. SPEAKERS)

Allows you turn the virtual speakers created by “CINEMA STUDIO EX A, B, C” and “SEMI CINEMA STUDIO EX A, B, C” off or on.

Adjusting the level parameters

The LEVEL menu contains parameters that let you adjust the balance and volumes of each speaker. The settings are applied to all sound fields.

- 1** Start playing a program source encoded with multi channel surround sound.
- 2** Press LEVEL.
The button lights up and the first parameter is displayed.
- 3** Press the cursor buttons (< or >) to select the parameter you want to adjust.
- 4** Turn the jog dial to select the setting you want.
The setting is entered automatically.

Initial settings

Parameter	Initial setting
FRONT L_I_R	Center
SURROUND L_I_R	Center
SUR.BACK L_I_R*	Center
CENTER LEVEL XXX dB	0 dB
SURROUND LEVEL XXX dB	0 dB
SURR BACK LEVEL XXX dB	0 dB
S. WOOFER LEVEL XXX dB	0 dB
LFE MIX XXX dB	0 dB
D. RANGE COMP.	OFF

* STR-DB1070 only.

Front balance (FRONT)

Lets you adjust the balance between front left and right speakers.

Surround balance (SURROUND)

Lets you adjust the balance between surround left and right speakers.

Surround back balance (SUR.BACK) (STR-DB1070 only)

Lets you adjust the balance between surround back left and right speakers when surround back L/R speakers are set to "YES".

Center level (CENTER LEVEL)

Lets you adjust the level of the center speaker.

Surround level (SURROUND LEVEL)

Lets you adjust the level of the surround left and right speakers.

Surround back level (SURR BACK LEVEL)

Lets you adjust level of the surround back (left and right) speaker(s).

Sub woofer level (S. WOOFER LEVEL)

Lets you adjust the level of the sub woofer.

LFE (Low Frequency Effect) mix level (LFE MIX)

Lets you attenuate the level of the LFE (Low Frequency Effect) channel output from the sub woofer without effecting the level of the bass frequencies sent to the sub woofer from the front, center or surround channels via the Dolby Digital or DTS bass redirection circuitry.

- For LFE mix level, "0 dB" outputs the full LFE signal at the mix level determined by the recording engineer.
- To mute the sound of the LFE channel from the sub woofer, select "OFF". However, the low frequency sounds of the front, center, or surround speakers are output from the sub woofer according to the settings made for each speaker in the speaker setup (page 19–21).

continued

Customizing sound fields (continued)

Dynamic range compressor (D. RANGE COMP.)

Lets you compress the dynamic range of the sound track. This may be useful when you want to watch movies at low volumes late at night. We recommend using the “MAX” setting.

- To reproduce the sound track with no compression, select “OFF”.
- To reproduce the sound track with the dynamic range intended by the recording engineer, select “STD”.
- To compress the dynamic range in small steps to achieve the sound you desire, select “0.1”–“0.9”.
- To reproduce a dramatic compression of the dynamic range, select “MAX”.

Notes

- Dynamic range compression is possible with Dolby Digital sources only.
- While NIGHT MODE is activated, D.RANGE COMP. is automatically set to MAX and is not displayed in the LEVEL menu.

Adjusting the equalizer

The EQ menu lets you adjust the equalization of the front, center, surround, and surround back speakers. The settings are stored individually for each sound field.

1 Start playing a program source encoded with multi channel surround sound.

2 Press EQ.

The button lights up and the first parameter is displayed.

3 Press the cursor buttons (< or >) to select the parameter (gain (dB), frequency (Hz)) you want to adjust.

4 Turn the jog dial to select the setting you want.

The setting is entered automatically.

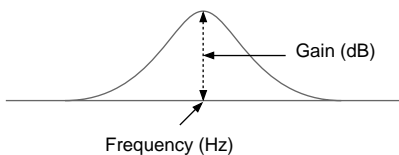

To turn on/off the equalizer

Press EQUALIZER. The EQ indicator in the display lights up when the equalizer is turned on. When you adjust the equalizer using the EQ parameters, the settings are stored separately for each sound field and can be reproduced whenever you turn on the equalizer.

Front speaker bass adjustment (Gain/Frequency)

Lets you adjust the gain and frequency of bass.

Front speaker midrange adjustment (Gain/Frequency)

Lets you adjust the gain and frequency of midrange.

Front speaker treble adjustment (Gain/Frequency)

Lets you adjust the gain and frequency of treble.

Center speaker bass adjustment (Gain/Frequency)

Lets you adjust the gain and frequency of bass.

Center speaker midrange adjustment (Gain/Frequency)

Lets you adjust the gain and frequency of midrange.

Center speaker treble adjustment (Gain/Frequency)

Lets you adjust the gain and frequency of treble.

**Surround speaker bass adjustment
(Gain/Frequency)**

Lets you adjust the gain and frequency of bass.

**Surround speaker treble adjustment
(Gain/Frequency)**

Lets you adjust the gain and frequency of treble.

**Surround back speaker bass
adjustment (Gain/Frequency)**

Lets you adjust the gain and frequency of bass.

**Surround back speaker treble
adjustment (Gain/Frequency)**

Lets you adjust the gain and frequency of treble.

**Resetting customized sound
fields to the factory settings**

- 1** If the power is on, press I/⏻ to turn off the power.
- 2** Hold down MODE + and press I/⏻.
“S.F Initialize” appears in the display and all sound fields are reset at once.

Before receiving broadcasts, make sure you have connected FM and AM antennas to the receiver (see page 7).

Storing FM stations automatically (AUTOBETICAL)

(Models of area code CEL only)

This function lets you store up to 30 FM and FM RDS stations in alphabetical order without redundancy. Additionally, it only stores the stations with the clearest signals.

If you want to store FM or AM stations one by one, see “Presetting radio stations” on page 40.

1 Press I/⏻ to turn off the receiver.

2 Hold down MEMORY and press I/⏻ to turn the receiver back on.

“Autobetel select” appears in the display and the receiver scans and stores all the FM and FM RDS stations in the broadcast area.

For RDS stations, the tuner first checks for stations broadcasting the same program, then stores only the one with the clearest signal. The selected RDS stations are sorted alphabetically by their Program Service name, then assigned a 2-character preset code. For more details on RDS, see page 41.

Regular FM stations are assigned 2-character preset codes and stored after the RDS station.

When done, “Autobetel finish” appears in the display momentarily and the receiver returns to the normal operation.

Notes

- Do not press any button on the receiver or supplied remote during autobetel operation.
- If you move to another area, repeat this procedure to store stations in your new area.
- For details on tuning the stored stations, see page 40.
- The FM MODE setting is also stored along with the station.
- If you move the antenna after storing stations with this procedure, the stored settings may no longer be valid. If this happens, repeat this procedure to store the stations again.

Direct tuning

You can enter a frequency of the station you want directly by using the numeric buttons on the supplied remote. For details on the buttons used in this section, see the operating instructions for the supplied remote.

1 Rotate FUNCTION to select TUNER.

The last received station is tuned in.

2 Press FM/AM to select the FM or AM band.

3 Press D. TUNING.

4 Press the numeric buttons to enter the frequency.

Example 1: FM 102.50 MHz

① → ② → ⑤ → ①

Example 2: AM 1350 kHz

(You don't have to enter the last “0” when the tuning scale is set to 10 kHz.)

① → ③ → ⑤ → ①

If you cannot tune in a station and the entered numbers flash

Make sure you've entered the right frequency. If not, repeat steps 3 and 4.

If the entered numbers still flash, the frequency is not used in your area.

5 If you've tuned in an AM station, adjust the direction of the AM loop antenna for optimum reception.

6 Repeat steps 2 to 5 to receive another station.

Tip

- If you do not remember the precise frequency, press TUNING + or TUNING – after entering the value close to the frequency you want. The receiver automatically tunes in the station you want. If the frequency seems to be higher than the entered value, press TUNING +, and if the frequency seems to be lower than the entered value, press TUNING –.
- If “STEREO” flashes in the display and the FM stereo reception is poor, press FM MODE to improve the sound. You will not be able to enjoy the stereo effect, but the sound will be less distorted.

Note

If “STEREO” does not appear at all when an FM broadcast is received normally, press FM MODE to turn on the “STEREO” indication.

The tuning scale for direct tuning differs depending on the area code as shown in the following table. For details on area codes, see page 4.

Area code	FM	AM
U, CA	100 kHz	10 kHz*
AU, CN, SP, CEL	50 kHz	9 kHz
E	50 kHz	9 kHz*

* The AM tuning scale can be changed (see page 53).

Automatic tuning

If you don't know the frequency of the station you want, you can let the receiver scan all available stations in your area.

1 Rotate FUNCTION to select TUNER.

The last received station is tuned in.

2 Press FM/AM to select the FM or AM band.

3 Press TUNING + or TUNING –.

Press TUNING + to scan from low to high; press TUNING – to scan from high to low.

The receiver stops scanning whenever a station is received.

When the receiver reaches either end of the band

Scanning is repeated in the same direction.

4 To continue scanning, press TUNING + or TUNING – again.

Preset tuning

After you have tuned in stations using Direct Tuning or Automatic Tuning, you can preset them to the receiver. Then you can tune in any of the stations directly by entering its 2-character preset code using the supplied remote. Up to 30 FM or AM stations can be preset. The receiver will also scan all the stations that you have preset.

Before tuning to preset stations, be sure to preset them by performing steps on “Presetting radio stations” (page 40).

continued

Preset tuning (continued)

Presetting radio stations

- 1 Rotate FUNCTION to select TUNER.**
The last received station is tuned in.
- 2 Tune in the station that you want to preset using Direct Tuning (page 38) or Automatic Tuning (page 39).**
- 3 Press MEMORY.**
“MEMORY” appears in the display for a few seconds.
Do steps 4 to 6 before “MEMORY” goes out.
- 4 Press SHIFT to select a memory page (A, B or C).**
Each time you press SHIFT, the letter “A”, “B”, or “C” appears in the display.
- 5 Press PRESET TUNING + or PRESET TUNING – to select a preset number.**
If “MEMORY” goes out before you press the preset number, start again from step 3.
- 6 Press MEMORY again to store the station.**
If “MEMORY” goes out before you press the preset number, start again from step 3.
- 7 Repeat steps 2 to 6 to preset another station.**

To change a preset number to another station

Do steps 1 to 6 to preset a new station to the number.

Tuning to preset stations

You can tune the preset stations by either of the following two ways.

Scanning the preset stations

- 1 Rotate FUNCTION to select TUNER.**
The last received station is tuned in.
- 2 Press PRESET TUNING + or PRESET TUNING – repeatedly to select the preset station you want.**
Each time you press the button, the receiver tunes in one preset station at a time, in the corresponding order and direction as follows:

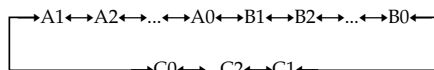

Using the preset codes

Use the supplied remote to perform the following operations. For details on the buttons used in this section, see the operating instructions for the supplied remote.

- 1 Rotate FUNCTION to select TUNER.**
The last received station is tuned in.
- 2 For remotes without a display: Press SHIFT to select a memory page (A, B, or C), then press the preset number of the station you want using the numeric buttons.**

For remotes with a display: Select the preset station you want from the list displayed on the supplied remote.

Using the Radio Data System (RDS)

(Models of area code CEL only)

This receiver also allows you to use RDS (Radio Data System), which enables radio stations to send additional information along with the regular program signal. You can use the following convenient RDS features:

- Displaying RDS information
- Scanning preset stations by program type

Note that RDS is operable only for FM stations.*

* Not all FM stations provide RDS service, nor do they provide the same types of services. If you are not familiar with the RDS services in your area, check with your local radio stations for details.

Receiving RDS broadcasts

Simply select a station on the FM band using direct tuning (page 38), automatic tuning (page 39), or preset tuning (page 39).

When you tune in a station that provides RDS services, the RDS indicator lights up and the program station name appears in the display.

Note

RDS may not work properly if the station you tuned to is not transmitting the RDS signal properly or if the signal strength is weak.

Displaying RDS information

While receiving an RDS station, press **DISPLAY**.

Each time you press the button, RDS information on the display changes cyclically as follows:

PS (Program Station name)^{a)} → Frequency^{a)}
→ PTY (Program TYpe) indication^{b)} →
RT (Radio Text) indication^{c)} → CT (Current Time) indication (in 24-hour system) → Sound field currently applied

- a) This information also appears for non-RDS FM stations.
- b) Type of program being broadcast (see page 42).
- c) Text messages sent by the RDS station.

Notes

- If there is an emergency announcement by government authorities, “Alarm-Alarm!” flashes in the display.
- If a station does not provide a particular RDS service, “No XX” (such as “No Clock Time”) appears in the display.
- When a station broadcasts radio text data, it is displayed at the same rate at which it is sent from the station. Any change in this rate is reflected in the display rate of the data.

Scanning preset stations by program type

You can tune in preset stations according to a program type that you specify. The receiver scans for stations in its preset memory currently broadcasting the specified program type.

1 Press **RDS PTY**.

2 Press **PTY SELECT +** or **PTY SELECT –** to select the program type.

See the table below for the information on each program type.

3 Press **RDS PTY**.

While the receiver is scanning stations, “PTY SEARCH” appears in the display window.

When the receiver finds a station, the receiver stops scanning. When the receiver could not find any preset stations currently broadcasting the specified program type, “PTY not found” appears in the display.

continued

**Using the Radio Data System (RDS)
(continued)**

Description of program types

Program type indication	Description
News	News programs
Current Affairs	Topical programs that expand on current news
Information	Programs offering information on a wide spectrum of subjects, including consumer affairs and medical advice
Sport	Sports programs
Education	Educational programs, such as “how-to” and advice programs
Drama	Radio plays and serials
Cultures	Programs about national or regional culture, such as language and social concerns
Science	Programs about the natural sciences and technology
Varied Speech	Other types of programs such as celebrity interviews, panel games, and comedy
Pop Music	Popular music programs
Rock Music	Rock music programs
Easy Listening	Easy Listening
Light Classics M	Instrumental, vocal, and choral music
Serious Classics	Performances of major orchestras, chamber music, opera, etc.
Other Music	Music that does not fit into any categories above, such as Rhythm & Blues and Reggae
Weather & Metr	Weather information
Finance	Stock market reports and trading, etc.
Children’s Progs	Programs for children
Social Affairs	Programs about people and the things that affect them
Religion	Programs of religious content
Phone In	Programs where members of the public express their views by phone or in a public forum
Travel & Touring	Programs about travel. Not for announcements that are located by TP/TA.

Program type indication	Description
Leisure & Hobby	Programs on recreational activities such as gardening, fishing, cooking, etc.
Jazz Music	Jazz programs
Country Music	Country music programs
National Music	Programs featuring the popular music of the country or region
Oldies Music	Programs featuring oldies music
Folk Music	Folk music programs
Documentary	Investigative features
None	Any programs not defined above

Naming preset stations and program sources

You can enter a name of up to 8 characters for preset stations and program sources. These names (for example, “VHS”) appear in the receiver’s display when a station or program source is selected. Note that no more than one name can be entered for each preset station or program source.

This function is useful for distinguishing components of the same kind. For example, two VCRs can be specified as “VHS” and “8mm”, respectively. It is also handy for identifying components connected to jacks meant for another type of component, for example, a second CD player connected to the MD/DAT jacks.

1 To index a preset station

Rotate **FUNCTION** to select **TUNER**, then tune in the preset station you want to create an index name for.

The last station you received is tuned in. If you are not familiar with how to tune in preset stations, see “Tuning to preset stations” on page 40.

To index a program source

Select the program source (component) to be named.

2 Press **NAME**.

3 Create an index name by using the jog dial and cursor buttons:

Turn the jog dial to select a character, then press **>** to move the cursor to the next position.

To insert a space

Turn the jog dial until a blank space appears in the display.

If you've made a mistake

Press **<** or **>** repeatedly until the character to be changed flashes, then turn the jog dial to select the right character.

4 Press **ENTER**.

5 Repeat steps 2 to 4 to assign index name for another station or program source.

Note

(Models of area code CEL only)

You cannot change the name of an RDS station.

Recording

Before you begin, make sure you’ve connected all components properly.

Recording on an audio tape or MiniDisc

You can record on a cassette tape or MiniDisc using the receiver. See the operating instructions of your cassette deck or MD deck if you need help.

1 Select the component to be recorded.

2 Prepare the component for playing.

For example, insert a CD into the CD player.

3 Insert a blank tape or MD into the recording deck and adjust the recording level, if necessary.

4 Start recording on the recording deck, then start playback on the playback component.

continued

Recording (continued)

Notes

- You cannot record a digital audio signal using a component connected to the analog TAPE OUT or MD/DAT OUT jacks (STR-DB1070) or the analog MD/TAPE OUT jacks (STR-DB870). To record a digital audio signal, connect a digital component to the DIGITAL MD/DAT OUT jacks (STR-DB1070) or the DIGITAL MD/TAPE OUT jacks (STR-DB870).
- Sound adjustments do not affect the signal output from the TAPE OUT or MD/DAT OUT jacks (STR-DB1070) or the MD/TAPE OUT jacks (STR-DB870).
- The analog audio signals of the current function is output from the REC OUT jacks. When you use AUDIO SPLIT to assign a digital audio input (for example, MD/DAT OPTICAL), the analog audio signals of the assigned audio (for example, MD/DAT ANALOG) is output.
- When MULTI/2CH A. DIRECT is set to MULTI DIRECT (for STR-DB1070, MULTI 1 or 2 DIRECT), audio signals are not output from REC OUT jacks.
- No signals output from DIGITAL OUT jacks (MD/DAT OPT OUT) when you set MULTI/2CH A. DIRECT to 2CH ANALOG DIRECT. The digital circuitry power is cut off to ensure a superior sound quality.

Recording on a video tape

You can record from a VCR, a TV, or an LD player using the receiver. You can also add audio from a variety of audio sources when editing a video tape. See the operating instructions of your VCR or LD player if you need help.

- 1 Select the program source to be recorded.**
- 2 Prepare the component for playing.**
For example, insert the laser disc you want to record into the LD player.
- 3 Insert a blank video tape into the VCR (VIDEO 1 or VIDEO 2) for recording.**
- 4 Start recording on the recording VCR, then start playing the video tape or laser disc you want to record.**

Tip

You can record the sound from any audio source onto a video tape while copying from a video tape or laser disc. Locate the point where you want to start recording from another audio source, select the program source, then start playback. The audio from that source will be recorded onto the audio track of the video tape instead of the audio from the original medium. To resume audio recording from the original medium, select the video source again.

Notes

- Make sure to make both digital and analog connections to the TV/SAT and DVD/LD inputs. Analog recording is not possible if you make only digital connections.
- Some sources contain copy guards to prevent recording. In this case, you may not be able to record from the sources.
- The analog audio signals of the current function is output from the REC OUT jacks. When you use AUDIO SPLIT to assign a digital audio input (for example, MD/DAT OPTICAL), the analog audio signals of the assigned audio (for example, MD/DAT ANALOG) is output.
- When MULTI/2CH A. DIRECT is set to MULTI DIRECT (for STR-DB1070, MULTI 1 or 2 DIRECT), audio signals are not output from REC OUT jacks.

Using the Sleep Timer

You can set the receiver to turn off automatically at a specified time.

Press SLEEP on the front panel (except for models of area code CEL) or on the remote while the power is on.

Each time you press the button, the display changes cyclically as follows:

2:00:00 → 1:30:00 → 1:00:00 → 0:30:00 → OFF

The display dims after you have specified the time. While using Sleep Timer, "SLEEP" lights up in the display.

Tip

- You can freely specify the time. After pressing SLEEP, specify the time you want using the jog dial and cursor buttons (< or >) on the receiver. The sleep time changes in 1 second intervals. You can specify up to 5 hours.
- To check the remaining time before the receiver turns off, press SLEEP. The remaining time appears in the display.

Adjustments using the SET UP button

The SET UP button allows you to make the following adjustments.

- 1 Press SET UP.**
- 2 Press the cursor buttons (< or >) to select the parameter you want to adjust.**
- 3 Turn the jog dial to select the setting you want.**
The setting is entered automatically.
- 4 Repeat steps 2 and 3 until you have set all of the parameters that follow.**

Initial settings

Parameter	Initial setting
6.1CH DECODING	AUTO
MULTI CH (1 or 2)	NONE
D.POWER	ALWAYS ON
V.POWER	AUTO OFF
S.FIELD LINK	ON
A1 AUTO POWER	ON
AUTO FUNCTION	ON
2ND ROOM SP ¹⁾	OFF
COMMAND MODE ²⁾	AV1
COLOR SYSTEM ³⁾	PAL
OSD ⁴⁾	COLOR
OSD H.POSITION ⁴⁾	4
OSD V.POSITION ⁴⁾	4

- 1) Only when the center or surround back speaker is set to "2ND ROOM" (STR-DB1070 area code U, CA only).
- 2) Except for STR-DB870 area code CEL.
- 3) STR-DB1070 of area code other than U, CA only.
- 4) STR-DB1070 only.

■ 6.1ch Matrix (6.1CH DECODING)

You can set this parameter using 6.1CH DECODING on the front panel.

- When set to "AUTO", the receiver performs 6.1 channel matrix decoding only if 6.1 channel signals decode flag is ON.
- When set to "ON", the receiver performs 6.1 channel matrix decoding only if the surround signals are 2 channel, regardless of the 6.1 channel decode flag.
- When set to "OFF", the receiver does not perform 6.1 channel matrix decoding.
- During "A.F.D.", this parameter is always set to "AUTO", and you cannot change the setting.
- When the 6.1 channel matrix decoding is performed and the surround back speaker is set to "NO", you can enjoy the surround back signals with virtual 3D technology, even without an actual surround back speaker (the box around SB does not light up). If the surround back speaker is set to "YES", the surround back signals are output through the actual speaker (SB and the box lights up). (For STR-DB870) Please note that you can set the surround back speaker only when the center speaker is set to "NO" (page 20).

■ Multi channel assignment (MULTI CH (for STR-DB1070, MULTI CH 1 or 2))

Lets you assign a function to MULTI CH (for STR-DB1070, MULTI CH 1 or 2). You cannot assign TUNER or PHONO.

For STR-DB1070, you cannot assign the same function to both MULTI CH 1 and 2.

continued

Adjustments using the SET UP button (continued)

■ Digital power management (D.POWER)

Lets you enjoy the analog source without the influence of digital circuits.

- “AUTO OFF” turns off the power of the unnecessary digital circuits automatically when you use analog inputs or functions that bypass digital processing when MULTI/2CH A. DIRECT function is used.
- “ALWAYS ON” keeps the power of digital circuits on. Select if you do not like the time lag that occurs with the “AUTO OFF” setting when digital circuits are turned on, etc.

■ Video power management (V.POWER)

Lets you enjoy the sound without the influence of the video circuits.

- “AUTO OFF” turns off the power of video circuits automatically when there are unnecessary.
- “ALWAYS ON” keeps the power of video circuits on. Depending on the monitor, noise may be produced or the picture may be distorted when the power of the video circuits is turned on. In this case, select “ALWAYS ON”.

■ Sound field link (S.FIELD LINK)

Lets you apply the last selected sound field to a program source whenever it is selected. For example, if you listen to CD with STADIUM as the sound field, change to a different program source, then return to CD, STADIUM will be applied again.

■ CONTROL A1 II auto power on (A1 AUTO POWER)

Lets you turn on the receiver automatically when the component connected via CONTROL A1 cords (see page 14) is turned on and the playback is started.

When set to “OFF”, you can save the power consumption of the receiver during standby mode.

■ CONTROL A1 II auto function (AUTO FUNCTION)

Lets you switch the function of this receiver to the Sony components connected via CONTROL A1 cords (see page 14) automatically when the connected component is set to play mode.

■ 2nd room speaker (2ND ROOM SP) (STR-DB1070 area code U, CA only)

Lets you set whether you would output the sound to the 2nd room or not.

■ Selecting the command mode of the remote (COMMAND MODE)

Lets you select the command mode of the remote. Change the command mode when you use 2 Sony receivers in the same room.

■ Monitor color system (COLOR SYSTEM) (STR-DB1070 area code other than U, CA)

Lets you select the color system of your TV monitor.

■ Color of the on-screen display (OSD) (STR-DB1070 only)

Lets you select the color of the on-screen display.

■ OSD horizontal position (OSD H.POSITION) (STR-DB1070 only)

Lets you adjust the position of the on-screen display horizontally.

■ OSD vertical position (OSD V.POSITION) (STR-DB1070 only)

Lets you adjust the position of the on-screen display vertically.

CONTROL A1II control system

Getting Started

This section explains the basic functions of the CONTROL A1II Control System. Certain components have special functions, like “CD Synchro Dubbing” on cassette decks, that require CONTROL A1II connections. For detailed information regarding specific operations, be sure to also refer to the Operating Instructions supplied with your component(s).

The CONTROL A1II Control System was designed to simplify the operation of audio systems composed of separate Sony components. CONTROL A1II connections provide a path for the transmission of control signals which enable automatic operation and control features usually associated with integrated systems.

Currently, CONTROL A1II connections between a Sony CD player, amplifier (receiver), MD deck and cassette deck provide automatic function selection and synchronized recording.

In the future, the CONTROL A1II connection will work as a multifunction bus allowing you to control various functions for each component.

Notes

- The CONTROL A1II Control System is designed to maintain upward compatibility as the Control System is upgraded to handle new functions. In this case, however, older components will not be compatible with the new functions.
- Do not operate a 2 way remote control unit when the CONTROL A1II jacks are connected via a PC interface kit to a personal computer running “MD Editor” or similar application. Also, do not operate the connected component in a manner contrary to the functions of the application, as this may cause the application to operate incorrectly.

CONTROL A1II and CONTROL A1 compatibility

The CONTROL A1 control system has been updated to the CONTROL A1II which is the standard system in the Sony 300 disc CD changer and other recent Sony components. Components with CONTROL A1 jacks are compatible with components with CONTROL A1II, and can be connected to each other. Basically, the majority of the functions available with the CONTROL A1 control system will be available with the CONTROL A1II control system.

However, when making connections between components with CONTROL A1 jacks and components with CONTROL A1II jacks, the number of functions that can be controlled may be limited depending on the component. For detailed information, refer to the operating instructions supplied with the component(s).

Connections

Connect monaural (2P) mini-plug cords in series to the CONTROL A1II jacks on the back of each component. You can connect up to 10 CONTROL A1II compatible components in any order. However, you can connect only one of each type of component (i.e., 1 CD player, 1 MD deck, 1 tape deck and 1 receiver). (You may be able to connect more than one CD player or MD deck, depending on the model. Refer to the operating instructions supplied with the respective component for details.)

Example

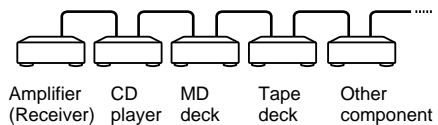

In the CONTROL A1II control system, the control signals flow both ways, so there is no distinction of IN and OUT jacks. If a component has more than one CONTROL A1II jack, you can use either one, or connect different components to each jack.

continued

CONTROL A1II control system (continued)

Jacks and connection examples

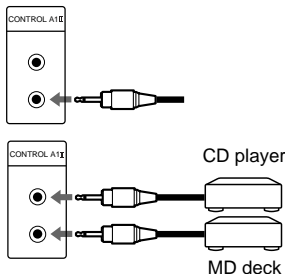

On CONTROL A1 jacks and connections

It is possible to make connections between CONTROL A1 and CONTROL A1II jacks. For details regarding particular connections or set up options, refer to the operating instructions supplied with the component(s).

About the connecting cord

Some CONTROL A1 compatible components are supplied with a connecting cord as an accessory. In this case, use the connecting cord for your connection.

When using a commercially available cord, use a monaural (2P) mini-plug cord less than 2 meters long, with no resistance (like the Sony RK-G69HG).

Basic Functions

The CONTROL A1II functions will operate as long as the component you want to operate is turned on, even if all of the other connected components are not turned on.

Automatic function selection

When you connect a CONTROL A1II compatible Sony amplifier (or receiver) to other Sony components using monaural mini-plug cords, the function selector on the amplifier (or receiver) automatically switches to the correct input when you press the play button on one of the connected components.

Notes

- You must connect a CONTROL A1 compatible amplifier (receiver) using a monaural mini-plug cord in order to take advantage of the automatic function selection feature.
- This function only works when the components are connected to the amplifier (or receiver) inputs according to the names on the function buttons. Certain receivers allow you to switch the names of the function buttons. In this case, refer to the operating instructions supplied with the receiver.
- When recording, do not play any components other than the recording source. It will cause the automatic function selection to operate.

Synchronized recording

This function lets you conduct synchronized recording between the selected source and recorder components.

- 1 Set the function selector on the amplifier (or receiver) to the source component.**
- 2 Set the source component to pause mode (make sure both the ► and II indicators light together).**
- 3 Set the recorder component to the REC-PAUSE mode.**
- 4 Press PAUSE on the recorder component.**
The source component is released from the pause mode, and recording begins shortly thereafter.
When playback ends from the source component, recording stops.

Notes

- Do not set more than one component to the pause mode.
- Certain recorder components may be equipped with a special synchronized recording function that uses the CONTROL A1II Control System, like "CD Synchro Dubbing". In this case, refer to the operating instructions supplied with the recorder component.

Precautions

For customers in Europe

To avoid electrical shock, do not open the cabinet. Refer servicing to qualified personnel only.

On safety

Should any solid object or liquid fall into the cabinet, unplug the receiver and have it checked by qualified personnel before operating it any further.

On power sources

- Before operating the unit, check that the operating voltage is identical with your local power supply. The operating voltage is indicated on the nameplate at the rear of the receiver.
- The unit is not disconnected from the AC power source (mains) as long as it is connected to the wall outlet, even if the receiver itself has been turned off.
- If you are not going to use the receiver for a long time, be sure to disconnect the receiver from the wall outlet. To disconnect the AC power cord, grasp the plug itself; never pull the cord.
- (Models of area code U, CA only)
One blade of the plug is wider than the other for the purpose of safety and will fit into the wall outlet only one way. If you are unable to insert the plug fully into the outlet, contact your dealer.
- AC power cord must be changed only at the qualified service shop.

On heat buildup

Although the unit heats up during operation, this is not a malfunction. If you continuously use this unit at a large volume, the cabinet temperature of the top, side and bottom rises considerably. To avoid burning yourself, do not touch the cabinet.

On placement

- Place the receiver in a location with adequate ventilation to prevent heat buildup and prolong the life of the receiver.
- Do not place the receiver near heat sources, or in a place subject to direct sunlight, excessive dust or mechanical shock.
- Do not place anything on top of the cabinet that might block the ventilation holes and cause malfunctions.

On operation

Before connecting other components, be sure to turn off and unplug the receiver.

On cleaning

Clean the cabinet, panel and controls with a soft cloth slightly moistened with a mild detergent solution. Do not use any type of abrasive pad, scouring powder or solvent such as alcohol or benzine.

If you have any question or problem concerning your receiver, please consult your nearest Sony dealer.

Troubleshooting

If you experience any of the following difficulties while using the receiver, use this troubleshooting guide to help you remedy the problem. Also, see “Checking the connections” on page 24 to verify that the connections are correct. Should any problem persist, consult your nearest Sony dealer.

There is no sound no matter which component is selected.

- Check that both the receiver and all components are turned on.
- Check that the MASTER VOLUME control is not set at $-\infty$ dB.
- Check that the SPEAKERS switch is not set to OFF (see page 26).
- Check that all speaker cords are connected correctly.
- Press MUTING to cancel the muting function.

There is no sound from a specific component.

- Check that the component is connected correctly to the audio input jacks for that component.
- Check that the cord(s) used for the connection is (are) fully inserted into the jacks on both the receiver and the component.

continued

Troubleshooting (continued)

There is no sound from one of the front speakers.

- Connect a pair of headphones to the PHONES jack to verify that sound is output from the headphones (see page 26).

If only one channel is output from the headphones, the component may not be connected to the receiver correctly. Check that all the cords are fully inserted into the jacks on both the receiver and the component.

If both channels are output from the headphones, the front speaker may not be connected to the receiver correctly. Check the connection of the front speaker which is not outputting any sound.

There is no sound or only a very low-level sound is heard.

- Check that the speakers and components are connected securely.
 - Check that you have selected the correct component on the receiver.
 - Check that the SPEAKERS switch is set to ON (see page 26).
 - Check that the headphones are not connected.
 - Press MUTING if muting function is activated.
 - The protective device on the receiver has been activated because of a short circuit. Turn off the receiver, eliminate the short-circuit problem and turn on the power again.
 - When only a very low-level sound is heard, check to see if NIGHT MODE is activated (see page 31).
-

The left and right sounds are unbalanced or reversed.

- Check that the speakers and components are connected correctly and securely.
 - Adjust balance parameters in the LEVEL menu.
-

There is severe hum or noise.

- Check that the speakers and components are connected securely.
 - Check that the connecting cords are away from a transformer or motor, and at least 3 meters away from a TV set or fluorescent light.
 - Move your TV away from the audio components.
 - Make sure you have grounded \hbar SIGNAL GND terminal (only when a turntable is connected).
 - The plugs and jacks are dirty. Wipe them with a cloth slightly moistened with alcohol.
-

There is intermittent sound from a digital source.

- Check to see if signals with 96 kHz sampling frequencies are input to the DVD/LD OPTICAL IN or COAXIAL jacks.
-

There is no sound from the center speaker.

- Make sure the sound field function is on (press MODE +/-).
 - Select a sound field containing the word "CINEMA" or "VIRTUAL" (see page 28–30).
 - Adjust the speaker level (see page 35).
 - Make sure the center speaker size parameter is set to either "SMALL" or "LARGE" (see page 20).
-

There is no sound or only a very low-level sound is heard from the surround/surround back speakers.

- Make sure the sound field function is on (press MODE +/-).
 - Select a sound field containing the word "CINEMA" or "VIRTUAL" (see page 28–30).
 - Adjust the speaker level (see page 35).
 - Make sure the surround/surround back speaker size parameter is set to either "SMALL" or "LARGE" (see pages 20–21).
-

There is no sound from the active sub woofer.

- There is no sound output from the SUB WOOFER terminal depending on the sound field (see page 59).
-

The surround effect cannot be obtained.

- Make sure the sound field function is on (press MODE +/-).
-

Dolby Digital or DTS multi channel sound is not reproduced.

- Check that the playing DVD, etc. is recorded in Dolby Digital or DTS format.
 - When connecting the DVD player, etc. to the digital input jacks of this receiver, check the audio setting (settings for the audio output) of the connected component.
-

Recording cannot be done.

- Check that the components are connected correctly.
- Select the source component with FUNCTION control.
- When recording from a digital component, make sure the INPUT MODE is set to ANALOG 2CH FIXED (see page 26) before recording with a component connected to the analog MD/DAT or TAPE terminals (STR-DB1070) or the analog MD/TAPE terminals (STR-DB870).
- When recording from a digital component, make sure the INPUT MODE is set to COAXIAL FIXED or OPTICAL FIXED (see page 26) before recording with the component connected to the DIGITAL MD/DAT OUT terminals (STR-DB1070) or the DIGITAL MD/TAPE OUT terminals (STR-DB870).

To connect an LD player via an RF demodulator.

- Connect the LD player to the RF demodulator, then connect the RF demodulator's optical or coaxial digital output to the receiver's DVD/LD OPTICAL IN or COAXIAL jack. When making this connection, be sure to set INPUT MODE manually (see page 26). The receiver may not operate correctly if INPUT MODE is set to AUTO 2CH.
For details on DOLBY DIGITAL RF hookups, see the operating instructions supplied with your RF demodulator.

The FM reception is poor.

- Use a 75-ohm coaxial cable (not supplied) to connect the receiver to an outdoor FM antenna as shown below. If you connect the receiver to an outdoor antenna, ground it against lightning. To prevent a gas explosion, do not connect the ground wire to a gas pipe.

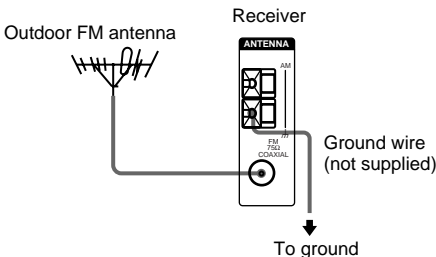

Radio stations cannot be tuned in.

- Check that the antennas are connected securely. Adjust the antennas and connect an external antenna if necessary.
- The signal strength of the stations is too weak (when tuning in with automatic tuning). Use direct tuning.
- Make sure you set the tuning interval correctly (when tuning in AM stations with direct tuning).
- No stations have been preset or the preset stations have been cleared (when tuning by scanning preset stations). Preset the stations (see page 40).
- Press DISPLAY so that the frequency appears in the display.

RDS does not work.*

- Make sure that you're tuned to an FM RDS station.
- Select a stronger FM station.

The RDS information that you want does not appear.*

- Contact the radio station and find out whether or not they actually provide the service in question. If so, the service may be temporarily out of order.

There is no picture or an unclear picture appears on the TV screen or monitor.

- Select the appropriate function on the receiver.
- Set your TV to the appropriate input mode.
- Move your TV away from the audio components.

The remote does not function.

- (For STR-DB870 area code U, CA)
The 2ND ROOM button and the ON SCREEN button on the remote are not available.
- Point the remote at the remote sensor  on the receiver.
- Remove any obstacles in the path between the remote and the receiver.
- Replace both batteries in the remote with new ones, if they are weak.
- Make sure you select the correct function on the remote.
- If the remote is set to operate the TV only, use the remote to select a source or component other than TV before operating the receiver or other component.

* Models of area code CEL only.

Troubleshooting (continued)

Reference sections for clearing the receiver's memory

To clear	See
All memorized settings	page 18
Customized sound fields	page 37

Specifications

AUDIO POWER SPECIFICATIONS

POWER OUTPUT AND TOTAL HARMONIC DISTORTION:

With 8 ohm loads, both channels driven, from 20 – 20,000 Hz; rated 100 watts per channel minimum RMS power, with no more than 0.09 % total harmonic distortion from 250 milliwatts to rated output (Models of area code U only).

Amplifier section

POWER OUTPUT

Models of area code U, CA

Rated Power Output at Stereo Mode

(8 ohms 20 Hz – 20 kHz, THD 0.09 %)
100 W + 100 W
(4 ohms 20 Hz – 20 kHz, THD 0.09 %)
90 W + 90 W

Reference Power Output

(8 ohms 20 Hz – 20 kHz, THD 0.09 %)
STR-DB1070: FRONT¹⁾: 100 W + 100 W
CENTER¹⁾: 100 W
SURR¹⁾: 100 W + 100 W
SURR BACK¹⁾: 100 W
STR-DB870: FRONT¹⁾: 100 W + 100 W
CENTER¹⁾: 100 W
SURR¹⁾: 100 W + 100 W
(4 ohms 20 Hz – 20 kHz, THD 0.09 %)
STR-DB1070: FRONT¹⁾: 90 W + 90 W
CENTER¹⁾: 90 W
SURR¹⁾: 90 W + 90 W
SURR BACK¹⁾: 90 W
STR-DB870: FRONT¹⁾: 90 W + 90 W
CENTER¹⁾: 90 W
SURR¹⁾: 90 W + 90 W

Models of other area code

Rated Power Output at Stereo Mode

(8 ohms 1 kHz, THD 0.7 %)
STR-DB1070: 100 W + 100 W²⁾
90 W + 90 W³⁾
STR-DB870: 100 W + 100 W²⁾
(4 ohms 1 kHz, THD 0.7 %)
STR-DB1070: 90 W + 90 W²⁾
80 W + 80 W³⁾
STR-DB870: 100 W + 100 W²⁾

Reference Power Output²⁾

(8 ohms 1 kHz, THD 0.7 %)
STR-DB1070: FRONT¹⁾: 100 W + 100 W
CENTER¹⁾: 100 W
SURR¹⁾: 100 W + 100 W
SURR BACK¹⁾: 100 W
STR-DB870: FRONT¹⁾: 100 W + 100 W
CENTER¹⁾: 100 W
SURR¹⁾: 100 W + 100 W
(4 ohms 1 kHz, THD 0.7 %)
STR-DB1070: FRONT¹⁾: 90 W + 90 W
CENTER¹⁾: 90 W
SURR¹⁾: 90 W + 90 W
SURR BACK¹⁾: 90 W
STR-DB870: FRONT¹⁾: 100 W + 100 W
CENTER¹⁾: 100 W
SURR¹⁾: 100 W + 100 W
(8 ohms 20 Hz – 20 kHz, THD 0.09 %)
STR-DB1070: FRONT¹⁾: 90 W + 90 W
CENTER¹⁾: 90 W
SURR¹⁾: 90 W + 90 W
SURR BACK¹⁾: 90 W
STR-DB870: FRONT¹⁾: 90 W + 90 W
CENTER¹⁾: 90 W
SURR¹⁾: 90 W + 90 W
(4 ohms 20 Hz – 20 kHz, THD 0.09 %)
STR-DB1070: FRONT¹⁾: 80 W + 80 W
CENTER¹⁾: 80 W
SURR¹⁾: 80 W + 80 W
SURR BACK¹⁾: 80 W
STR-DB870: FRONT¹⁾: 90 W + 90 W
CENTER¹⁾: 90 W
SURR¹⁾: 90 W + 90 W

- 1) Depending on the sound field settings and the source, there may be no sound output.
- 2) Measured under the following conditions:

Area code	Power requirements
E	240 V AC, 50 Hz
CN, SP, CEL	230 V AC, 50 Hz
TW	110 V AC, 60 Hz

- 3) Measured under the following conditions:

Area code	Power requirements
CN	220 V AC, 50 Hz

Frequency response

PHONO	RIAA equalization curve ±0.5 dB
CD/SACD, TAPE, MD/DAT, MD/TAPE, TV/SAT, DVD/LD, VIDEO 1, 2, 3	10 Hz – 100 kHz ±3 dB (with sound field, equalizer, and bass boost bypassed)

Inputs (Analog)

PHONO	Sensitivity: 2.5 mV Impedance: 50 kilohms S/N ⁹⁾ : 86 dB (A, 2.5 mV ⁵⁾)
MULTI CH IN (1, 2), CD/SACD, TAPE, MD/DAT, MD/TAPE, DVD/LD, TV/SAT, VIDEO 1, 2, 3	Sensitivity: 150 mV Impedance: 50 kilohms S/N ⁹⁾ : 96 dB (A, 150 mV ⁵⁾)

4) INPUT SHORT.

5) Weighted network, input level.

Inputs (Digital)

DVD/LD (Coaxial)	Sensitivity: – Impedance: 75 ohms S/N: 100 dB (A, 20 kHz LPF)
DVD/LD, TV/SAT, MD/DAT, MD/TAPE (Optical)	Sensitivity: – Impedance: – S/N: 100 dB (A, 20 kHz LPF)

Outputs

TAPE, MD/DAT, MD/ TAPE (REC OUT), VIDEO 1, 2 (AUDIO OUT)	Voltage: 150 mV Impedance: 1 kilohms
FRONT L/R, CENTER, SURROUND L/R, SURROUND BACK, SUB WOOFER	Voltage: 2 V Impedance: 1 kilohms

EQ

BASS:	99 Hz~1.0 kHz (21 steps)
MID:	198 Hz~10 kHz (37 steps)
TREBLE:	1.0 kHz~10 kHz (23 steps)
Gain levels:	±10 dB, 1 dB step

FM tuner section

Tuning range	87.5 – 108.0 MHz
Antenna terminals	75 ohms, unbalanced
Sensitivity	
Mono:	18.3 dBf, 2.2 μV/75 ohms
Stereo:	38.3 dBf, 22.5 μV/75 ohms
Usable sensitivity	11.2 dBf, 1 μV/75 ohms

S/N

Mono:	76 dB
Stereo:	70 dB

Harmonic distortion at 1 kHz

Mono:	0.3%
Stereo:	0.5%

Separation 45 dB at 1 kHz

Frequency response 30 Hz – 15 kHz,
+0.5/-2 dB

Selectivity 60 dB at 400 kHz

AM tuner section

Tuning range

Models of area code U, CA

With 10-kHz tuning scale: 530 – 1710 kHz⁶⁾

With 9-kHz tuning scale: 531 – 1710 kHz⁶⁾

Models of area code E

With 10-kHz tuning scale: 530 – 1610 kHz⁶⁾

With 9-kHz tuning scale: 531 – 1602 kHz⁶⁾

Models of area code CN, SP, CEL, TW

With 9-kHz tuning scale: 531 – 1602 kHz

Antenna Loop antenna

Usable sensitivity 50 dB/m (at 1,000 kHz or
999 kHz)

S/N 54 dB (at 50 mV/m)

Harmonic distortion 0.5 % (50 mV/m,
400 kHz)

Selectivity

At 9 kHz:	35 dB
At 10 kHz:	40 dB

6) You can change the AM tuning scale to 9 kHz or 10 kHz. After tuning in any AM station, turn off the receiver. Hold down PRESET TUNING + and press I/⏻. All preset stations will be erased when you change the tuning scale. To reset the scale to 10 kHz (or 9 kHz), repeat the procedure.

continued

Specifications (continued)

Video section

Inputs

Video:	1 Vp-p, 75 ohms
S-video:	Y: 1 Vp-p, 75 ohms C: 0.286 Vp-p, 75 ohms

Outputs

Video:	1 Vp-p, 75 ohms
S-video:	Y: 1 Vp-p, 75 ohms C: 0.286 Vp-p, 75 ohms

General

Power requirements

Area code	Power requirements
U, CA	120 V AC, 60 Hz
CEL	230 V AC, 50/60 Hz
CN, SP	220 – 230 V AC, 50/60 Hz
E	120/220/240 V AC, 50/60 Hz
TW	110 V AC, 60 Hz

Power consumption

Area code	Power consumption
U	STR-DB1070: 300 W STR-DB870: 300 W
CA	STR-DB1070: 420 VA STR-DB870: 390 VA
CEL	STR-DB1070: 240 W STR-DB870: 230 W
CN, SP, E, TW	STR-DB1070: 240 W

Power consumption (during standby mode)

0.8 W (when "A1 AUTO POWER" in the SET UP menu is set to "ON")/0.5 W ("OFF")

AC outlets

Area code	AC outlets
U, CA	2 switched, 120 W/1A MAX
SP, CEL	1 switched, 100 W MAX
CN, E, TW	2 switched, 100 W MAX

Dimensions	430 × 161 × 401 mm including projecting parts and controls
-------------------	--

Mass (Approx.)	16.0 kg
-----------------------	---------

Supplied accessories

- FM wire antenna (1)
- AM loop antenna (1)
- Models of area code U, CA
 - Audio/video/control S connecting cord (1)
 - Control S connecting cord (1)
- STR-DB1070 only
 - Models of area code U, CA
 - Remote commander RM-PP505L (1)
 - R6 (size-AA) batteries (2)
 - Models of other area codes
 - Remote commander RM-LP205 (1)
 - R6 (size-AA) batteries (3)
- STR-DB870 only
 - Models of area code U, CA
 - Remote commander RM-PP505 (1)
 - R6 (size-AA) batteries (2)
 - Models of area code CEL
 - Remote commander RM-U305A (1)
 - R6 (size-AA) batteries (2)

For details on the area code of the component you are using, see page 4.

Design and specifications are subject to change without notice.

Tables of settings using SURR, LEVEL, EQ, and SET UP buttons

You can make various settings using the LEVEL, SURR, EQ, SET UP buttons, jog dial, and cursor buttons. The tables below show each of the settings that these buttons can make.

Press	Press < or >	Turn jog dial	Page
SURR	PRO LOGIC	AUTO, ON, OFF	33
	EFFECT	depends on the sound field (21 steps)	
	WALL S_I_H	-8 to +8 (1 increment steps)	
	REVERB S_I_L	-8 to +8 (1 increment steps)	
	FRONT REVERB	DRY, WET, STD	
	SCREEN DEPTH	DEEP, MID, OFF	
	VIR. SPEAKERS	ON, OFF	
LEVEL	FRONT L_I_R	-8 dB to 8 dB (1 dB steps)	35
	SURROUND L_I_R	-8 dB to 8 dB (1 dB steps)	
	SUR.BACK L_I_R ¹⁾	-8 dB to 8 dB (1 dB steps)	
	CENTER LEVEL XXX dB	-10 dB to +10 dB (1 dB steps)	
	SURROUND LEVEL XXX dB	-10 dB to +10 dB (1 dB steps)	
	SURR BACK LEVEL XXX dB	-10 dB to +10 dB (1 dB steps)	
	S. WOOFER LEVEL XXX dB	-10 dB to +10 dB (1 dB steps)	
	LFE MIX XXX dB	OFF, -20 dB to 0 dB (1 dB steps)	
D.RANGE COMP.	OFF, 0.1 to 0.9 (0.1 steps), STD, MAX		

¹⁾ STR-DB1070 only.

continued

Tables of settings using SURR, LEVEL, EQ, and SET UP buttons (continued)

Press	Press < or >	Turn jog dial	Page
EQ	FRONT BASS GAIN	-10 dB to +10 dB (1 dB steps)	36
	FRONT BASS FREQUENCY	99 Hz to 1.0 kHz (21 steps)	
	FRONT MID GAIN	-10 dB to +10 dB (1 dB steps)	
	FRONT MID FREQUENCY	198 Hz to 10 kHz (37 steps)	
	FRONT TREBLE GAIN	-10 dB to +10 dB (1 dB steps)	
	FRONT TREBLE FREQUENCY	1.0 kHz to 10 kHz (23 steps)	
	CENTER BASS GAIN	-10 dB to +10 dB (1 dB steps)	
	CENTER BASS FREQUENCY	99 Hz to 1.0 kHz (21 steps)	
	CENTER MID GAIN	-10 dB to +10 dB (1 dB steps)	
	CENTER MID FREQUENCY	198 Hz to 10 kHz (37 steps)	
	CENTER TREBLE GAIN	-10 dB to +10 dB (1 dB steps)	
	CENTER TREBLE FREQUENCY	1.0 kHz to 10 kHz (23 steps)	
	SURROUND BASS GAIN	-10 dB to +10 dB (1 dB steps)	
	SURROUND BASS FREQUENCY	99 Hz to 1.0 kHz (21 steps)	
	SURROUND TREBLE GAIN	-10 dB to +10 dB (1 dB steps)	
	SURROUND TREBLE FREQUENCY	1.0 kHz to 10 kHz (23 steps)	
	SURROUND BACK BASS GAIN	-10 dB to +10 dB (1 dB steps)	
	SURROUND BACK BASS FREQUENCY	99 Hz to 1.0 kHz (21 steps)	
SURROUND BACK TREBLE GAIN	-10 dB to +10 dB (1 dB steps)		
SURROUND BACK TREBLE FREQUENCY	1.0 kHz to 10 kHz (23 steps)		

Press	Press < or >	Turn jog dial	Page
SET UP	FRONT	LARGE, SMALL	19
	CENTER	LARGE, SMALL, NO, 2ND ROOM ³⁾	
	SURROUND	LARGE, SMALL, NO	
	SURR BACK	LARGE, SMALL, NO, 2ND ROOM ³⁾	
	SURR BACK L/R ¹⁾	YES, NO	
	SUB WOOFER	YES, NO	
	FRONT XX.X meter	1.0 meter to 12.0 meters (0.1 meter steps) ⁵⁾	
	CENTER XX.X meter	1.0 meter to 12.0 meters (0.1 meter steps) ⁵⁾	
	SURROUND XX.X meter	1.0 meter to 12.0 meters (0.1 meter steps) ⁵⁾	
	SURR BACK XX.X meter	1.0 meter to 12.0 meters (0.1 meter steps) ⁵⁾	
	SUB WOOFER XX.X meter	1.0 meter to 12.0 meters (0.1 meter steps) ⁵⁾	
	S.W PHASE	NORMAL, REVERSE	
	DISTANCE UNIT	METER, FEET	
	SURR POSI.	SIDE, MIDDLE, BEHIND	
	SURR HEIGHT	HIGH, LOW	
	SURR BACK HGT.	HIGH, LOW	
	FRONT SP > XXX Hz ²⁾	40 Hz to 200 Hz (10 Hz steps)	
	CENTER SP > XXX Hz ²⁾	40 Hz to 200 Hz (10 Hz steps)	
	SURROUND SP > XXX Hz ²⁾	40 Hz to 200 Hz (10 Hz steps)	
	SURR BACK SP > XXX Hz ²⁾	40 Hz to 200 Hz (10 Hz steps)	
	LFE HIGH CUT > XXX Hz	40 Hz to 200 Hz (10 Hz steps)	
	6.1CH DECODING	AUTO, ON, OFF	45
	MULTI CH (1/2)	NONE, Every functions (except for TUNER and PHONO)	
	D.POWER	AUTO OFF, ALWAYS ON	
	V.POWER	AUTO OFF, ALWAYS ON	
	S.FIELD LINK	ON, OFF	
	A1 AUTO POWER	ON, OFF	
	AUTO FUNCTION	ON, OFF	
	2ND ROOM SP ³⁾	ON, OFF	
	COMMAND MODE	AV1, AV2	
	COLOR SYSTEM ⁴⁾	NTSC, PAL	
	OSD ¹⁾	COLOR, MONOCHROME	
	OSD H.POSITION ¹⁾	0 to 64 (1 steps)	
	OSD V.POSITION ¹⁾	0 to 32 (1 steps)	

1) STR-DB1070 only.

2) When the speakers are set to SMALL only.

3) STR-DB1070 area code U, CA only.

4) STR-DB1070 area code other than U, CA only.

5) For models of area code U, CA: 3 feet to 40 feet (1 foot steps)

Adjustable parameters for each sound field

The adjusted SURR and EQ parameters are stored in each sound field. The adjusted LEVEL parameters are applied to all the sound fields.

	SURR								
	<	PRO LOGIC	EFFECT LEVEL	WALL TYPE	REVERB TIME	FRONT REVERB	SCREEN DEPTH	>	VIRTUAL SPEAKERS
2CH									
A.F.D.		AUTO							
NORMAL SURROUND		●							
CINEMA STUDIO EX A		●	●				●		●
CINEMA STUDIO EX B		●	●				●		●
CINEMA STUDIO EX C		●	●				●		●
SEMI CINEMA STUDIO EX A		●	●				●		●
SEMI CINEMA STUDIO EX B		●	●				●		●
SEMI CINEMA STUDIO EX C		●	●				●		●
NIGHT THEATER		●	●	●	●				
MONO MOVIE		●	●	●	●				
STEREO MOVIE		●	●	●	●				
V. MULTI DIMENSION		●							
VIRTUAL MULTI REAR		●							
V. SEMI M. DIMENSION		●							
VIRTUAL ENHANCED A		●							
VIRTUAL ENHANCED B		●							
DIGITAL CONCERT HALL A		●	●				●		
DIGITAL CONCERT HALL B		●	●				●		
CHURCH		●	●	●	●				
OPERA HOUSE		●	●	●	●				
JAZZ CLUB		●	●	●	●				
DISCO/CLUB		●	●	●	●				
LIVE HOUSE		●	●	●	●				
ARENA		●	●	●	●				
STADIUM		●	●	●	●				
GAME		●	●	●	●				
HEADPHONE (2CH)									
HEADPHONE (DIRECT)									
HEADPHONE THEATER		●	●						
MULTI CH IN (1/2)									
2CH ANALOG DIRECT									
PCM96K									

	LEVEL									
	FRONT BAL	SURR BAL	SURR BACK BAL	CENTER LEVEL	SURR LEVEL	SURR BACK LEVEL	S. WOOFER LEVEL	LFE MIX ¹⁾	D.RANGE COMP ¹⁾	
2CH	●							●	●	
A.F.D.	●	●	●	●	●	●	●	●	●	
NORMAL SURROUND	●	●	●	●	●	●	●	●	●	
CINEMA STUDIO EX A	●	●	●	●	●	●	●	●	●	
CINEMA STUDIO EX B	●	●	●	●	●	●	●	●	●	
CINEMA STUDIO EX C	●	●	●	●	●	●	●	●	●	
SEMI CINEMA STUDIO EX A	●			●			●	●	●	
SEMI CINEMA STUDIO EX B	●			●			●	●	●	
SEMI CINEMA STUDIO EX C	●			●			●	●	●	
NIGHT THEATER	●	●	●	●	●	●	●	●	●	
MONO MOVIE	●	●	●	●	●	●	●	●	●	
STEREO MOVIE	●	●	●	●	●	●	●	●	●	
V. MULTI DIMENSION	●	●	●	●	●	●	●	●	●	
VIRTUAL MULTI REAR	●	●	●	●	●	●	●	●	●	
V. SEMI M. DIMENSION	●			●			●	●	●	
VIRTUAL ENHANCED A	●			●			●	●	●	
VIRTUAL ENHANCED B	●			●			●	●	●	
DIGITAL CONCERT HALL A	●	●	●	●	●	●	● ²⁾	●	●	
DIGITAL CONCERT HALL B	●	●	●	●	●	●	● ²⁾	●	●	
CHURCH	●	●	●	●	●	●	● ²⁾	●	●	
OPERA HOUSE	●	●	●	●	●	●	● ²⁾	●	●	
JAZZ CLUB	●	●	●	●	●	●	● ²⁾	●	●	
DISCO/CLUB	●	●	●	●	●	●	●	●	●	
LIVE HOUSE	●	●	●	●	●	●	● ²⁾	●	●	
ARENA	●	●	●	●	●	●	● ²⁾	●	●	
STADIUM	●	●	●	●	●	●	● ²⁾	●	●	
GAME	●	●	●	●	●	●	●	●	●	
HEADPHONE (2CH)	●								●	
HEADPHONE (DIRECT)	●								●	
HEADPHONE THEATER	●								●	
MULTI CH IN 1	●	●		●	●	●	●			
MULTI CH IN 2	●	●		●	●		●			
2CH ANALOG DIRECT	●									
PCM96K	●									

¹⁾ These parameters may not operate depending on the source or adjustments. For details, see each item in “Adjusting the level parameters” (page 35).

²⁾ When these sound fields are selected, there is no sound output from the sub woofer if the front speaker size is set to “LARGE”. However, sound will be output from the sub woofer if the digital input signal contains L.F.E. signals.

continued

Adjustable parameters for each sound field (continued)

	EQ					
	<	FRONT				>
	BASS GAIN	BASS FREQ	MID GAIN	MID FREQ	TREBLE GAIN	TREBLE FREQ
2CH	●	●	●	●	●	●
A.F.D.	●	●	●	●	●	●
NORMAL SURROUND	●	●	●	●	●	●
CINEMA STUDIO EX A	●	●	●	●	●	●
CINEMA STUDIO EX B	●	●	●	●	●	●
CINEMA STUDIO EX C	●	●	●	●	●	●
SEMI CINEMA STUDIO EX A	●	●	●	●	●	●
SEMI CINEMA STUDIO EX B	●	●	●	●	●	●
SEMI CINEMA STUDIO EX C	●	●	●	●	●	●
NIGHT THEATER	●	●	●	●	●	●
MONO MOVIE	●	●	●	●	●	●
STEREO MOVIE	●	●	●	●	●	●
V. MULTI DIMENSION	●	●	●	●	●	●
VIRTUAL MULTI REAR	●	●	●	●	●	●
V. SEMI M. DIMENSION	●	●	●	●	●	●
VIRTUAL ENHANCED A	●	●	●	●	●	●
VIRTUAL ENHANCED B	●	●	●	●	●	●
DIGITAL CONCERT HALL A	●	●	●	●	●	●
DIGITAL CONCERT HALL B	●	●	●	●	●	●
CHURCH	●	●	●	●	●	●
OPERA HOUSE	●	●	●	●	●	●
JAZZ CLUB	●	●	●	●	●	●
DISCO/CLUB	●	●	●	●	●	●
LIVE HOUSE	●	●	●	●	●	●
ARENA	●	●	●	●	●	●
STADIUM	●	●	●	●	●	●
GAME	●	●	●	●	●	●
HEADPHONE (2CH)	●	●	●	●	●	●
HEADPHONE (DIRECT)						
HEADPHONE THEATER	●	●	●	●	●	●
MULTI CH IN (1/2)						
2CH ANALOG DIRECT						
PCM96K						

	EQ					
	<		CENTER			>
	BASS GAIN	BASS FREQ	MID GAIN	MID FREQ	TREBLE GAIN	TREBLE FREQ
2CH						
A.F.D.	●	●	●	●	●	●
NORMAL SURROUND	●	●	●	●	●	●
CINEMA STUDIO EX A	●	●	●	●	●	●
CINEMA STUDIO EX B	●	●	●	●	●	●
CINEMA STUDIO EX C	●	●	●	●	●	●
SEMI CINEMA STUDIO EX A	●	●	●	●	●	●
SEMI CINEMA STUDIO EX B	●	●	●	●	●	●
SEMI CINEMA STUDIO EX C	●	●	●	●	●	●
NIGHT THEATER	●	●	●	●	●	●
MONO MOVIE	●	●	●	●	●	●
STEREO MOVIE	●	●	●	●	●	●
V. MULTI DIMENSION	●	●	●	●	●	●
VIRTUAL MULTI REAR	●	●	●	●	●	●
V. SEMI M. DIMENSION	●	●	●	●	●	●
VIRTUAL ENHANCED A	●	●	●	●	●	●
VIRTUAL ENHANCED B	●	●	●	●	●	●
DIGITAL CONCERT HALL A	●	●	●	●	●	●
DIGITAL CONCERT HALL B	●	●	●	●	●	●
CHURCH	●	●	●	●	●	●
OPERA HOUSE	●	●	●	●	●	●
JAZZ CLUB	●	●	●	●	●	●
DISCO/CLUB	●	●	●	●	●	●
LIVE HOUSE	●	●	●	●	●	●
ARENA	●	●	●	●	●	●
STADIUM	●	●	●	●	●	●
GAME	●	●	●	●	●	●
HEADPHONE (2CH)						
HEADPHONE (DIRECT)						
HEADPHONE THEATER						
MULTI CH IN (1/2)						
2CH ANALOG DIRECT						
PCM96K						

continued

Adjustable parameters for each sound field (continued)

	EQ			
	<	SURROUND/SURROUND BACK		>
	BASS GAIN	BASS FREQ	TREBLE GAIN	TREBLE FREQ
2CH				
A.F.D.	●	●	●	●
NORMAL SURROUND	●	●	●	●
CINEMA STUDIO EX A	●	●	●	●
CINEMA STUDIO EX B	●	●	●	●
CINEMA STUDIO EX C	●	●	●	●
SEMI CINEMA STUDIO EX A				
SEMI CINEMA STUDIO EX B				
SEMI CINEMA STUDIO EX C				
NIGHT THEATER	●	●	●	●
MONO MOVIE	●	●	●	●
STEREO MOVIE	●	●	●	●
V. MULTI DIMENSION	●	●	●	●
VIRTUAL MULTI REAR	●	●	●	●
V. SEMI M. DIMENSION				
VIRTUAL ENHANCED A				
VIRTUAL ENHANCED B				
DIGITAL CONCERT HALL A	●	●	●	●
DIGITAL CONCERT HALL B	●	●	●	●
CHURCH	●	●	●	●
OPERA HOUSE	●	●	●	●
JAZZ CLUB	●	●	●	●
DISCO/CLUB	●	●	●	●
LIVE HOUSE	●	●	●	●
ARENA	●	●	●	●
STADIUM	●	●	●	●
GAME	●	●	●	●
HEADPHONE (2CH)				
HEADPHONE (DIRECT)				
HEADPHONE THEATER				
MULTI CH IN (1/2)				
2CH ANALOG DIRECT				
PCM96K				

Remote button description

For STR-DB870 area code CEL

You can use the remote RM-U305A to operate the components in your system. The tables below show the settings of each button.

Remote Button	Operations	Function
SLEEP	Receiver	Activates the sleep function and the duration which the receiver turns off automatically.
AV I/⏻	TV/VCR/ CD player/ DVD player/ MD deck/ VCD player/ LD player/ DAT deck	Turns the audio and video components on or off.
I/⏻	Receiver	Turns the receiver on or off.
VIDEO/ VIDEO 1	Receiver	To watch VCR. (VTR mode 3)
VIDEO 2	Receiver	To watch VCR. (VTR mode 1)
VIDEO 3	Receiver	To watch VCR. (VTR mode 2)
DVD/LD	Receiver	To watch DVD or laser disc.
TV/SAT	Receiver	To watch TV programs or satellite receiver.
MD/TAPE	Receiver	To listen to Minidisc or audio tape.
CD/SACD	Receiver	To listen to compact disc.
TUNER	Receiver	To listen to radio programs.
PHONO	Receiver	To listen to turn table.
AUX	Receiver	To listen to an audio equipment.
FN SHIFT*	Remote	Use simultaneously to select other function.

Remote Button	Operations	Function
0-9	Receiver	Use with "SHIFT" button to select tuner preset station numeric input during DIRECT TUNING or MEMORY mode.
	CD player/ MD deck/ VCD player/ LD player/ DAT deck	Selects track numbers. 0 selects track 10.
	TV/VCR/SAT	Selects channel numbers.
>10	CD player/ MD deck/ Tape deck/ LD player/ VCD player	Selects tracks numbers over 10.
ENTER	TV/VCR/SAT/ Tape deck/ LD player/ VCD player/ MD deck/ DAT deck	After selecting a channel, disc or track using the numeric buttons, press to enter the value.

* VIDEO 1, VIDEO 2, VIDEO 3, PHONO and MD/TAPE function is a 2-key operation. To select the above function, press FN SHIFT (function shift) and the function key you want simultaneously. For example, press FN SHIFT and CD/SACD to select MD/TAPE function.

continued

Remote button description (continued)

Remote Button	Operations	Function
SHIFT	Receiver	Press repeatedly to select a memory page for presetting radio stations or tuning to preset stations.
-/--	TV	Selects the channel entry mode, either one or two digit.
D.TUNING	Receiver	Tuner station direct key-in mode.
◀◀/▶▶	CD player/ MD deck/ DVD player/ LD player/ VCD player/ Tape deck/VCR/ DAT deck	Skips tracks.
◀◀/▶▶	CD player/ DVD player/ VCD player	Searches tracks (forward or backward).
	MD deck/ Tape deck/ VCR/ LD player/ DAT deck	Fastforwards or rewinds.
◀	Tape deck	Starts play on the reverse side.
▶	CD player/ MD deck/Tape deck/VCR/ DVD player/ VCD player/ LD player/ DAT deck	Starts play.
	CD player/ MD deck/Tape deck/VCR/ DVD player/ VCD player/ LD player/ DAT deck	Pauses play or record. (Also starts recording with components in record standby.)

Remote Button	Operations	Function
■	CD player/ MD deck/Tape deck/VCR/ DVD player/ VCD player/ LD player/ DAT deck	Stops play.
POSITION**	TV	Changes the position of the small picture.
SWAP**	TV	Swaps the small and the large picture.
DISC	CD player	Select discs (Mega storage CD player only).
SUB CH +/-**	TV	Selects preset channels for the small picture.
D. SKIP/CH/ PRESET +/-	Receiver	Scans and selects preset stations.
	TV/VCR/SAT	Selects preset channels.
	CD player/ MD deck/ DVD player/ VCD player	Skips discs (multi-disc changer only).
DISPLAY	TV/VCR/ LD player/ DVD player/ VCD player	Selects information displayed on the TV screen.
P IN P**	TV	Activates the picture-in-picture function.
JUMP	TV	Toggles between the previous and the current channels.
WIDE	TV	Selects the wide picture mode.

** Only for Sony TVs with the picture-in-picture function.

Notes

- Some functions explained in this section may not work depending on the model of the receiver.
- The above explanation is intended to serve as an example only.
Therefore, depending on the component the above operation may not be possible or may operate differently than described.
- The VIDEO 1, VIDEO 2, VIDEO 3 and PHONO functions are not available for set operation.

Remote Button	Operations	Function
ANT TV/VTR	VCR	Selects output signal from the aerial terminal: TV signal or VCR program.
TV/VIDEO	TV/VCR	Selects input signal: TV input or video input.
A. F. D.	Receiver	Auto Format Decoding.
2CH/OFF	Receiver	Turns off sound field or selects 2CH mode.
MODE +/-	Receiver	Selects sound field mode.
MULTI/2CH A. DIRECT	Receiver	Selects MULTI CH IN source.
MUTING	Receiver	Mutes the sound from the receiver.
TEST TONE	Receiver	Press to output test tone.
MAIN MENU	Receiver	Press this button repeatedly to select one of the two cursor modes: LEVEL and SURROUND.
MASTER VOL +/-	Receiver	Adjusts the master volume of the receiver.
MENU </>	Receiver	Selects a menu item.
MENU +/-	Receiver	Makes adjustment or change the setting.
MENU	DVD player	Displays DVD menu.
⬆/⬇/⬅/⬆	DVD player	Selects a menu item.
ENTER	DVD player	Enters the selection.
RETURN	DVD player	Returns to the previous menu or exits the menu.
TITLE	DVD player	Displays DVD title.

Changing the factory setting of a function button

If the factory settings of the FUNCTION buttons do not match your system components, you can change them. For example, if you have an MD player and a tape deck and you do not have a CD player, you can assign the CD/SACD button to your tape deck.

Note that the settings of the TUNER and FN SHIFT functions (VIDEO 1, VIDEO 2, VIDEO 3, PHONO and MD/TAPE) button cannot be changed.

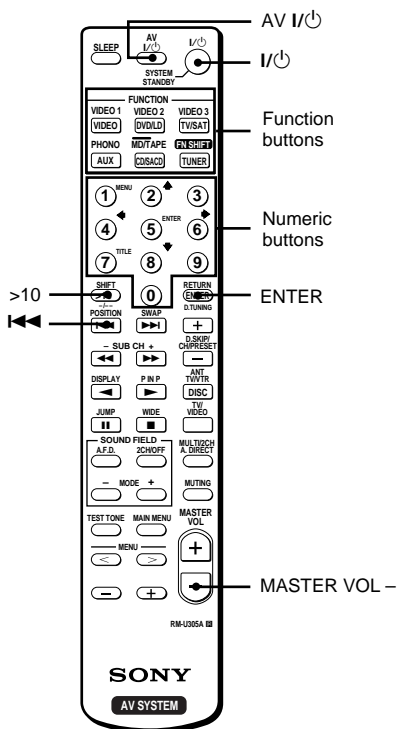

1 Hold down the Function button whose function you want to change (for example, CD/SACD).

2 Press the corresponding button of the component you want to assign to the Function button (for example, 4 – Tape deck).

The following buttons are assigned to select the functions:

To operate	Press
CD player	1
DAT deck	2
MD deck	3
Tape deck A	4
Tape deck B	5
LD player	6
VCR (command mode VTR 1*)	7
VCR (command mode VTR 2*)	8
VCR (command mode VTR 3*)	9
TV	0
DSS (Digital Satellite Receiver)	>10
DVD	ENTER
VCD player	◀◀

* Sony VCRs are operated with a VTR 1, 2 or 3 setting. These correspond to Beta, 8mm and VHS respectively.

Now you can use the CD/SACD button to control the tape deck.

To reset a button to its factory setting

Repeat the above procedure.

To reset all the function buttons to their factory setting

Press I/O, AV I/O and MASTER VOL – at the same time.

