

SONY

2-319-523-11(1)

Digital Video Camera Recorder

HANDYCAM®

Operating Guide

DCR-HC38

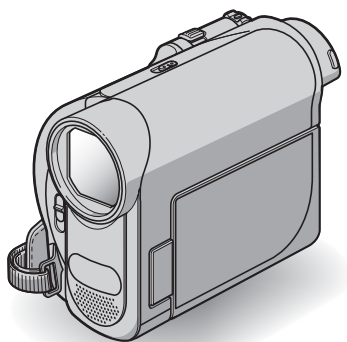

Getting Started 10



Recording/
Playback 17

Using the Menu 27

Dubbing/Editing 42

Using a Computer 46

Troubleshooting 50

Additional Information 57

Quick Reference 67

Spanish Quick Guide/
Guía rápida en español 74

Mini DV Digital
Video
Cassette

InfoLITHIUM™ H
SERIES

WARNING

To reduce fire or shock hazard, do not expose the unit to rain or moisture.

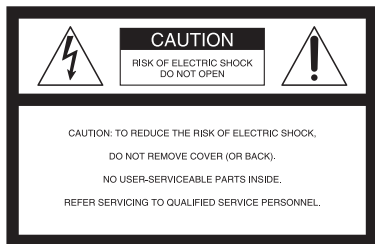

This symbol is intended to alert the user to the presence of uninsulated “dangerous voltage” within the product’s enclosure that may be of sufficient magnitude to constitute a risk of electric shock to persons.



This symbol is intended to alert the user to the presence of important operating and maintenance (servicing) instructions in the literature accompanying the appliance.

IMPORTANT SAFEGUARDS

For your protection, please read these safety instructions completely before operating the appliance, and keep this manual for future reference.

Carefully observe all warnings, precautions and instructions on the appliance, or the one described in the operating instructions and adhere to them.

Use

Power Sources

This set should be operated only from the type of power source indicated on the marking label. If you are not sure of the type of electrical power supplied to your home, consult your dealer or local power company. For those sets designed to operate from battery power, or other sources, refer to the operating instructions.

Polarization

This set may be equipped with a polarized ac power cord plug (a plug having one blade wider than the other).

This plug will fit into the power outlet only one way. This is a safety feature. If you are unable to insert the plug fully into the outlet, try reversing the plug. If the plug should still fail to fit, contact your electrician to have a suitable outlet installed. Do not defeat the safety purpose of the polarized plug by forcing it in.

Overloading

Do not overload wall outlets, extension cords or convenience receptacles beyond their capacity, since this can result in fire or electric shock.

Object and Liquid Entry

Never push objects of any kind into the set through openings as they may touch dangerous voltage points or short out parts that could result in a fire or electric shock. Never spill liquid of any kind on the set.

Attachments

Do not use attachments not recommended by the manufacturer, as they may cause hazards.

Cleaning

Unplug the set from the wall outlet before cleaning or polishing it. Do not use liquid cleaners or aerosol cleaners. Use a cloth lightly dampened with water for cleaning the exterior of the set.

Installation

Water and Moisture

Do not use power-line operated sets near water – for example, near a bathtub, washbowl, kitchen sink, or laundry tub, in a wet basement, or near a swimming pool, etc.

Power-Cord Protection

Route the power cord so that it is not likely to be walked on or pinched by items placed upon or against them, paying particular attention to the plugs, receptacles, and the point where the cord exits from the appliance.

Accessories

Do not place the set on an unstable cart, stand, tripod, bracket, or table. The set may fall, causing serious injury to a child or an adult, and serious damage to the set. Use only a cart, stand, tripod, bracket, or table recommended by the manufacturer.

Ventilation

The slots and openings in the cabinet are provided for necessary ventilation. To ensure reliable operation of the set, and to protect it from overheating, these slots and openings must never be blocked or covered.

- Never cover the slots and openings with a cloth or other materials.
- Never block the slots and openings by placing the set on a bed, sofa, rug, or other similar surface.
- Never place the set in a confined space, such as a bookcase, or built-in cabinet, unless proper ventilation is provided.
- Do not place the set near or over a radiator or heat register, or where it is exposed to direct sunlight.

IMPORTANT SAFEGUARDS (Continued)

Lightning

For added protection for this set during a lightning storm, or when it is left unattended and unused for long periods of time, unplug it from the wall outlet and disconnect the antenna or cable system. This will prevent damage to the set due to lightning and power-line surges.

Service

Damage Requiring Service

Unplug the set from the wall outlet and refer servicing to qualified service personnel under the following conditions:

- When the power cord or plug is damaged or frayed.
- If liquid has been spilled or objects have fallen into the set.
- If the set has been exposed to rain or water.
- If the set has been subject to excessive shock by being dropped, or the cabinet has been damaged.
- If the set does not operate normally when following the operating instructions. Adjust only those controls that are specified in the operating instructions. Improper adjustment of other controls may result in damage and will often require extensive work by a qualified technician to restore the set to normal operation.
- When the set exhibits a distinct change in performance – this indicates a need for service.

Servicing

Do not attempt to service the set yourself as opening or removing covers may expose you to dangerous voltage or other hazards.

Refer all servicing to qualified service personnel.

Replacement parts

When replacement parts are required, be sure the service technician has used replacement parts specified by the manufacturer that have the same characteristics as the original parts.

Unauthorized substitutions may result in fire, electric shock, or other hazards.

Safety Check

Upon completion of any service or repairs to the set, ask the service technician to perform routine safety checks (as specified by the manufacturer) to determine that the set is in safe operating condition.

Read this first

Before operating the unit, please read this manual thoroughly, and retain it for future reference.

CAUTION

Replace the battery with the specified type only. Otherwise, fire or injury may result.

For customers in the U.S.A. and CANADA

RECYCLING LITHIUM-ION BATTERIES

Lithium-Ion batteries are recyclable. You can help preserve our environment by returning your used rechargeable batteries to the collection and recycling location nearest you.

For more information regarding recycling of rechargeable batteries, call toll free 1-800-822-8837, or visit <http://www.rbrcc.org/>

Caution: Do not handle damaged or leaking Lithium-Ion batteries.

Battery pack

This device complies with Part 15 of the FCC Rules. Operation is subject to the following two conditions:

(1) This device may not cause harmful interference, and (2) this device must accept any interference received, including interference that may cause undesired operation.

This Class B digital apparatus complies with Canadian ICES-003.



For customers in the U.S.A.

If you have any questions about this product, you may call:
Sony Customer Information Center 1-800-222-SONY (7669).
The number below is for the FCC related matters only.

Regulatory Information

Declaration of Conformity

Trade Name: SONY
Model No.: DCR-HC38
Responsible Party: Sony Electronics Inc.
Address: 16530 Via Esprillo, San Diego, CA 92127 U.S.A.
Telephone Number: 858-942-2230
This device complies with Part 15 of the FCC Rules.

Operation is subject to the following two conditions:

(1) This device may not cause harmful interference, and (2) this device must accept any interference received, including interference that may cause undesired operation.

CAUTION

You are cautioned that any changes or modifications not expressly approved in this manual could void your authority to operate this equipment.

Note

This equipment has been tested and found to comply with the limits for a Class B digital device, pursuant to Part 15 of the FCC Rules. These limits are designed to provide reasonable protection against harmful interference in a residential installation. This equipment generates, uses, and can radiate radio frequency energy and, if not installed and used in accordance with the instructions, may cause harmful interference to radio communications.

However, there is no guarantee that interference will not occur in a particular installation. If this equipment does cause harmful interference to radio or television reception, which can be determined by turning the equipment off and on,

Read this first (Continued)

the user is encouraged to try to correct the interference by one or more of the following measures:

- Reorient or relocate the receiving antenna.
- Increase the separation between the equipment and receiver.
- Connect the equipment into an outlet on a circuit different from that to which the receiver is connected.
- Consult the dealer or an experienced radio/TV technician for help.

The supplied interface cable must be used with the equipment in order to comply with the limits for a digital device pursuant to Subpart B of Part 15 of FCC Rules.

Owner's Record

The model and serial numbers are located on the bottom. Record the serial number in the space provided below. Refer to these numbers whenever you call your Sony dealer regarding this product.

Model No. DCR-HC38

Serial No.

Model No. AC-

Serial No.

For the State of California, USA only

Perchlorate Material - special handling may apply, See

www.dtsc.ca.gov/hazardouswaste/perchlorate

Perchlorate Material: Lithium battery contains perchlorate.

Notes on use

Your camcorder is supplied with two kinds of manuals

- “Operating Guide” (This manual)
- “First Step Guide” for connecting the camcorder to a computer and using the supplied software (stored on the supplied CD-ROM)

Type of cassette you can use in your camcorder

- You can use mini DV cassettes marked with . Your camcorder is not

compatible with the Cassette Memory function (p. 58).

Using the camcorder

- Do not hold the camcorder by the following parts.



Viewfinder



Battery pack



LCD panel

- The camcorder is not dustproof, dripproof or waterproof.
See “On use and care” (p. 61).
- Before connecting your camcorder to another device with a USB or i.LINK cable, be sure to insert the connector plug the correct way, and not forcibly, to avoid damaging the terminal or cause a malfunction of your camcorder.

About menu items, LCD panel, viewfinder, and lens

- A menu item that is grayed out is not available under the current recording or playback conditions.
- The LCD screen and the viewfinder are manufactured using extremely high-precision technology, so over 99.99% of the pixels are operational for effective use. However, there may be some tiny black points and/or bright points (white, red, blue, or green in color) that appear constantly on the LCD screen and the viewfinder. These points are normal

results of the manufacturing process and do not affect the recording in any way.

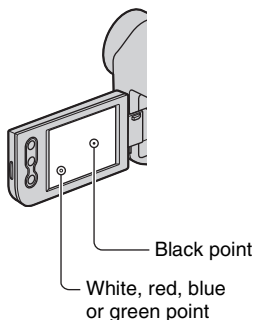

- Exposing the LCD screen, the viewfinder, or the lens to direct sunlight for long periods of time may cause malfunctions.
- Do not aim at the sun. Doing so might cause your camcorder to malfunction. Take pictures of the sun only in low light conditions, such as at dusk.

About the language setting

- The on-screen displays in each local language are used for illustrating the operating procedures. Change the screen language before using your camcorder if necessary (p. 14).

On recording

- Before starting to record, test the recording function to make sure the picture and sound are recorded without any problems.
- Compensation for the contents of recordings cannot be provided, even if recording or playback is not possible due to a malfunction of the camcorder, storage media, etc.
- TV color systems differ depending on the country/region. To view your recordings on a TV, you need a NTSC system-based TV.

- Television programs, films, video tapes, and other materials may be copyrighted. Unauthorized recording of such materials may be contrary to the copyright laws.

About this manual

- The images of the LCD screen and the viewfinder used in this manual for illustration purposes are captured using a digital still camera, and therefore may appear different.
- Design and specifications of recording media and accessories are subject to change without notice.

About the Carl Zeiss lens

Your camcorder is equipped with a Carl Zeiss lens, which was developed jointly by Carl Zeiss, in Germany, and Sony Corporation, and produces superior images. It adopts the MTF* measurement system for video cameras and offers a quality typical of a Carl Zeiss lens.

* MTF stands for Modulation Transfer Function. The number value indicates the amount of light from a subject coming into the lens.

Table of Contents

IMPORTANT SAFEGUARDS	3
Read this first	5

Getting Started

Step 1: Checking supplied items	10
Step 2: Charging the battery pack	11
Step 3: Turning the power on and setting the date and time	14
Changing the language setting	14
Step 4: Making setting adjustments before recording	15
Step 5: Inserting a Cassette	16



Recording/Playback

Easy Recording/Playback (Easy Handycam)	17
Recording	19
Zooming	20
Recording in dark places (NightShot plus)	20
Adjusting the exposure for backlit subjects	21
Recording in mirror mode	21
Playback	22
Using the guide functions (USAGE GUIDE)	23
Searching for the starting point	24
Searching for the last scene of the most recent recording (END SEARCH)	24
Searching manually (EDIT SEARCH)	24
Reviewing the most recently recorded scenes (Rec review)	24
Playing the picture on a TV	26

Using the Menu

Using the menu items	27
Operation button items	28
Menu items	35
MANUAL SET menu	36
– P EFFECT	
CAMERA SET menu	37
– D ZOOM/WIDE SEL/STEADYSHOT, etc.	
VCR SET menu	38
– AUDIO MIX	
LCD/VF SET menu	39
– LCD B.L./LCD COLOR/VF B.L., etc.	
TAPE SET menu	40
– REC MODE/AUDIO MODE/REMAIN	
SETUP MENU menu	40
– USB STREAM/LANGUAGE, etc.	
OTHERS menu	41
– WORLD TIME, etc.	

Dubbing/Editing

Dubbing to VCR or DVD/HDD recorders	42
Recording pictures from a TV or VCR, etc.	44

Using a Computer

What you can do with Windows computer	46
Installing the “First Step Guide” and software	47
Viewing “First Step Guide”	49

Troubleshooting

Troubleshooting	50
Warning indicators and messages	55

Additional Information

Using your camcorder abroad	57
Maintenance and precautions	58
Usable cassette tapes	58
About the "InfoLITHIUM" battery pack	59
About i.LINK	60
On using your camcorder	61
Specifications	64

Quick Reference

Identifying parts and controls	67
Indicators displayed during recording/playback	70
Index	72

Spanish Quick Guide/ Guía rápida en español 74

Step 1: Checking supplied items

Make sure that you have following items supplied with your camcorder. The number in the parentheses indicates the number of that item supplied.

AC Adaptor (1) (p. 11)

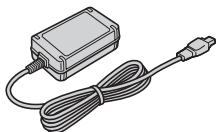

Power cord (1) (p. 11)



A/V connecting cable (1) (p. 26, 42)



Rechargeable battery pack NP-FH30 (1)
(p. 11, 59)

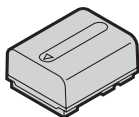

CD-ROM "Handycam Application Software" (1) (p. 46)

Operating Guide (This manual) (1)

Step 2: Charging the battery pack

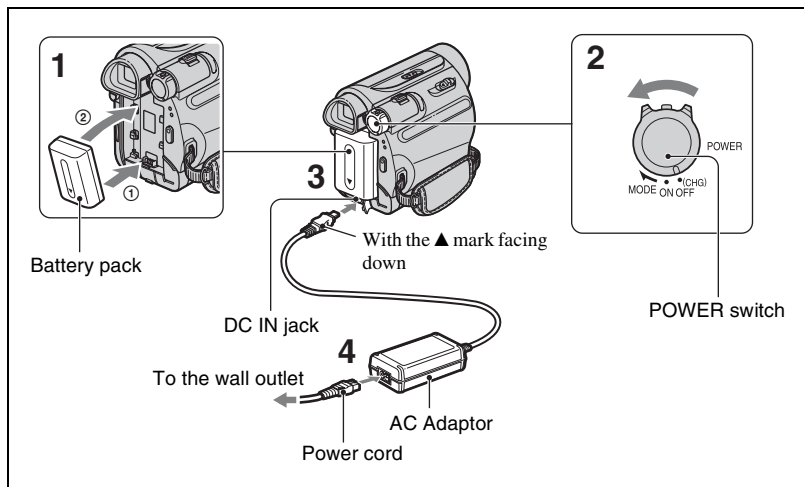

You can charge the “InfoLITHIUM” battery pack (H series) (p. 59) after attaching it to your camcorder.

⚙ Notes

- You cannot attach any “InfoLITHIUM” battery pack other than the H series to your camcorder.

1 Align the terminals of the battery pack and your camcorder ①, then attach the battery pack and click it into place ②.

2 Slide the POWER switch in the direction of the arrow to OFF(CHG) (The default setting).

3 Connect the AC Adaptor to the DC IN jack on your camcorder.

4 Connect the power cord to the AC Adaptor and the wall outlet.

CHG (charge) lamp

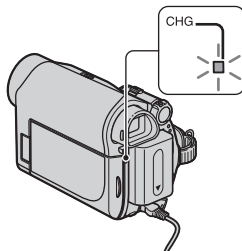

The CHG (charge) lamp lights up and charging starts.

Step2: Charging the battery pack (Continued)

5 The CHG (charge) lamp turns off when the battery is fully charged. Disconnect the AC Adaptor from the DC IN jack.

Disconnect the AC Adaptor from the DC IN jack holding both the camcorder and the DC plug.

To use an outside power source

You can operate your camcorder using the power from the wall outlet by making the same connections as you do when charging the battery pack. The battery pack will not lose its charge in this case.

To remove the battery pack

- 1 Turn off the power, then press PUSH.
- 2 Remove the battery pack in the direction of the arrow.

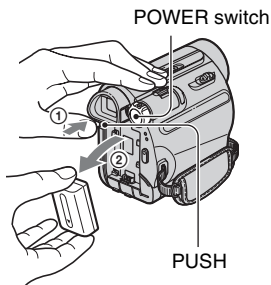

When storing the battery pack

Fully discharge the battery before storing it for an extended period (p. 59).

To check the remaining battery (Battery Info)

Set the POWER switch to OFF(CHG), then press DISP/BATT INFO.

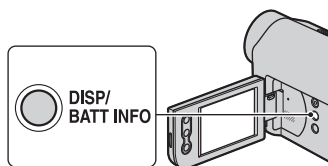

After a while, the approximate recordable time and battery information appear for about 7 seconds. You can view the battery information for up to 20 seconds by pressing DISP/BATT INFO again while the information is displayed.

Remaining battery (approx.)

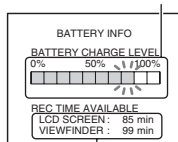

Recording capacity (approx.)

You can check the remaining battery charge on the LCD screen.

Indicator	Status
	Sufficient power remaining
	Battery low, recording/playback will stop soon.
	Replace the battery with a fully charged one, or charge the battery.

Charging time

Approximate time (min.) required when you fully charge a fully discharged battery pack.

Battery pack	Charging time
NP-FH30 (supplied)	115
NP-FH50	135
NP-FH70	170
NP-FH100	390

Recording time

Approximate time (min.) available when you use a fully charged battery pack.

Battery pack	Continuous recording time	Typical recording time*
NP-FH30 (supplied)	95	45
	110	55
NP-FH50	155	75
	180	90
NP-FH70	330	165
	395	195
NP-FH100	760	380
	890	445

* Typical recording time shows the time when you repeat recording start/stop, turning the power on/off and zooming.

Notes

- All times measured under the following conditions:
Top: Recording with LCD screen.
Bottom: Recording with viewfinder while the LCD panel closed.

Playing time

Approximate time (min.) available when you use a fully charged battery pack.

Battery pack	LCD panel opened	LCD panel closed
NP-FH30 (supplied)	105	135
NP-FH50	170	220
NP-FH70	370	465
NP-FH100	845	1065

On the battery pack

- Before changing the battery pack, slide the POWER switch to OFF(CHG).
- The CHG (charge) lamp flashes during charging, or the Battery Info (p. 12) will not be correctly displayed under the following conditions.
 - The battery pack is not attached correctly.
 - The battery pack is damaged.

– The battery pack is worn-out (for Battery Info only).

- The power will not be supplied from the battery as long as the AC Adaptor is connected to the DC IN jack of your camcorder, even when the power cord is disconnected from the wall outlet.

On the charging/recording/playback time

- Times measured with the camcorder at 25 °C (77 °F). (10 °C to 30 °C (50 °F to 86 °F) is recommended.)
- The recording and playback time will be shorter when you use your camcorder in low temperatures.
- The recording and playback time will be shorter depending on the conditions under which you use your camcorder.

On the AC Adaptor

- Use the nearby wall outlet when using the AC Adaptor. Disconnect the AC Adaptor from the wall outlet immediately if any malfunction occurs while using your camcorder.
- Do not use the AC Adaptor placed in a narrow space, such as between a wall and furniture.
- Do not short-circuit the DC plug of the AC Adaptor or battery terminal with any metallic objects. This may cause a malfunction.
- Even if your camcorder is turned off, AC power (house current) is still supplied to it while connected to the wall outlet via the AC Adaptor.

Step 3: Turning the power on and setting the date and time

Set the date and time when using this camcorder for the first time. If you do not set the date and time, the [CLOCK SET] screen appears every time you turn on your camcorder or change the POWER switch position.

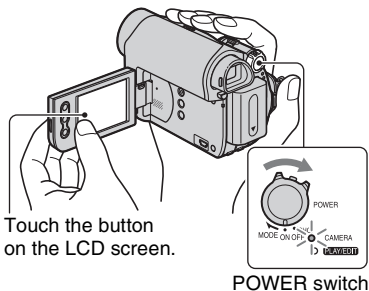

Touch the button on the LCD screen.

POWER switch

1 While pressing the green button, slide the POWER switch in the direction of the arrow to turn on the respective lamp.

CAMERA: To record on a tape.
PLAY/EDIT: To play or edit pictures.

The [CLOCK SET] screen appears.

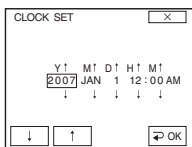

2 Set [Y] (year) with / , then touch .

You can set any year up to the year 2079.

3 Set [M] (month), then touch and repeat for [D] (day), [H] (hour) and [M] (minute).

For midnight, set it to 12:00 AM.
For midday, set it to 12:00 PM.

The clock starts.

To turn off the power

Slide the POWER switch to OFF(CHG).

To reset the date and time

You can set the desired date and time by touching → [PAGE2] → [CLOCK SET] (p. 27).

Notes

- If you do not use your camcorder for **about 3 months**, the built-in rechargeable battery gets discharged and the date and time settings may be cleared from the memory. In that case, charge the rechargeable battery and then set the date and time again (p. 64).
- At the time of purchase, the power is set to turn off automatically if you leave your camcorder without any operation attempted for approximately 5 minutes, to save battery power ([A.SHUT OFF], p. 41).

Tips

- The date and time are not displayed while recording, but they are automatically recorded on the tape, and can be displayed during playback (see page 32 for [DATA CODE] (During Easy Handycam operation, you can set only [DATE/TIME])).
- If the buttons on the touch panel do not work correctly, adjust the touch panel (CALIBRATION) (p. 62).

Changing the language setting

You can change the on-screen displays to show messages in a specified language.

Touch → [MENU] → (SETUP MENU) → [LANGUAGE], then select the desired language.

Step 4: Making setting adjustments before recording

Opening the lens cover

Slide the LENS COVER switch to OPEN.

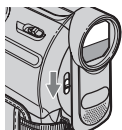

After recording, set the LENS COVER switch to CLOSE, to close the lens cover.

The LCD panel

Open the LCD panel 90 degrees to the camcorder (①), then rotate it to the best angle to record or play (②).

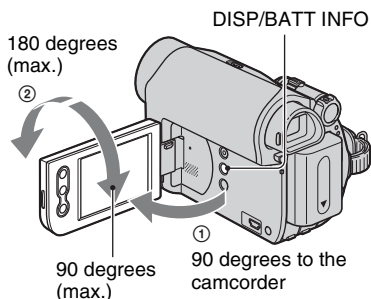

Notes

- Do not press the buttons on the LCD frame accidentally when you open or adjust the LCD panel.

Tips

- If you rotate the LCD panel 180 degrees to the lens side, you can close the LCD panel with the LCD screen facing out. This is convenient during playback operations.
- See [LCD BRT] (p. 32) to adjust the brightness of the LCD screen.
- Press DISP/BATT INFO to toggle the screen indicators (such as Battery Info) on or off.

The viewfinder

You can view pictures using the viewfinder to avoid wearing down the battery, or when the picture seen on the LCD screen is poor.

Viewfinder

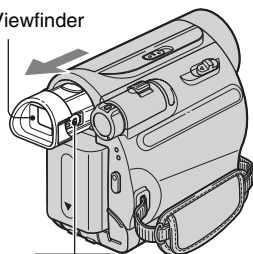

Viewfinder lens adjustment lever
Move it until the picture is clear.

Tips

- You can adjust the brightness of the viewfinder backlight by selecting [] (LCD/VF SET) - [VF B.L.] (p. 39).

The grip belt

Fasten the grip belt and hold your camcorder correctly.

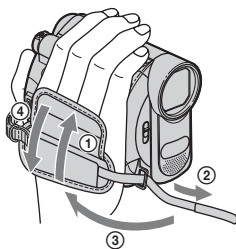

Step 5: Inserting a Cassette

You can use mini DV **Mini DV** cassettes only (p. 58).

- 1** Slide and hold the **OPEN/EJECT** lever in the direction of the arrow and open the lid.

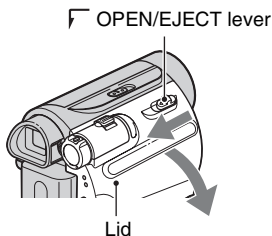

The cassette compartment automatically comes out and opens up.

- 2** Insert a cassette with its window facing outwards, then press **PUSH**.

Push the center of the back of the cassette lightly.

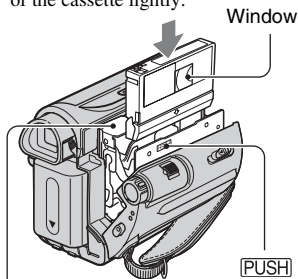

Cassette compartment

The cassette compartment automatically slides back in.

Notes

- Do not force the cassette compartment closed by pressing the

portion marked **DO NOT PUSH** while it is sliding in. It may cause a malfunction.

- 3** Close the lid.

To eject the cassette

Open the lid following the same procedure as described in step 1 and remove the cassette.

Tips

- The recordable time varies depending on [REC MODE] (p. 40).



Easy Recording/Playback (Easy Handycam)

With this Easy Handycam operation, most of the camera settings are automatically optimally adjusted, which frees you from detailed adjustments. The screen font size increases for easy viewing.

Open the lens cover (p. 15)

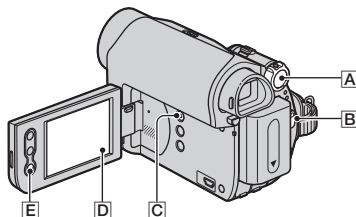
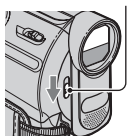

Recording

- Slide the POWER switch **A** in the direction of the arrow repeatedly to turn on the CAMERA lamp.

If the POWER switch **A** is set to OFF(CHG), slide it while pressing the green button.

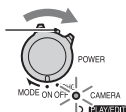

- Press EASY **C**.



EASY

EASY appears on the screen **D**.

- Press REC START/STOP **B** (or **E**) to start recording.*

The indicator **A** changes from [STBY] to [REC]. To stop recording, press REC START/STOP again.

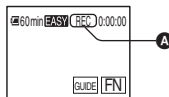

* During Easy Handycam operation, you can only record in the SP mode.

Playback

Slide the **POWER** switch **A** in the direction of the arrow repeatedly to turn on the **PLAY/EDIT** lamp. Touch the buttons on the screen **D** as follows.

If the **POWER** switch is set to **OFF(CHG)**, slide it while pressing the green button.

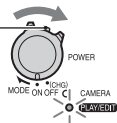

Touch **◀◀(B)**, then touch **▶▶(D)** to start playback.

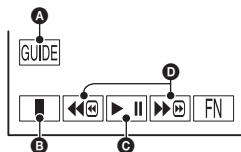

- A** GUIDE (p. 23)
- B** Stop
- C** Play/Pause toggles as you touch it
- D** Rewind/Fast forward

■ To cancel Easy Handycam operation

Press **EASY** **C** again. **EASY** disappears from the screen **D**.

■ Adjustable menu settings during Easy Handycam operation

Touch **FN** to display adjustable menu settings. See page 27 for details on setting.

- Almost all the settings return to their defaults automatically (p. 35).
- Cancel Easy Handycam operation if you want to add any effects or settings to the images.

■ Unavailable button during Easy Handycam

During Easy Handycam operation, the **BACK LIGHT** button (p. 21) is unavailable. [Invalid during Easy Handycam operation.] appears if an attempted operation is not available in Easy Handycam mode.

Recording

Open the lens cover (p. 15).

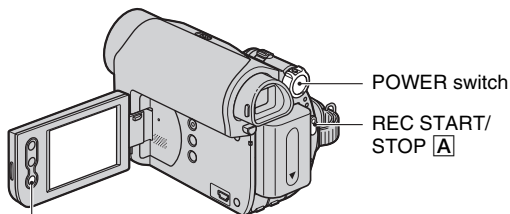
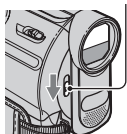

REC START/STOP [B]

- 1 Slide the **POWER** switch in the direction of the arrow repeatedly to turn on the **CAMERA** lamp.

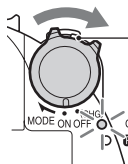

If the **POWER** switch is set to **OFF(CHG)**, slide it while pressing the green button.

- 2 Press **REC START/STOP** [A] (or [B]).

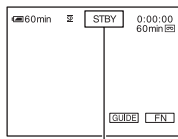

[STBY]

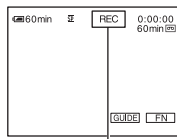

[REC]

To stop recording, press **REC START/STOP** again.

Recording (Continued)

Zooming

You can magnify images up to 40 times the original size with the power zoom lever or the zoom buttons on the LCD frame.

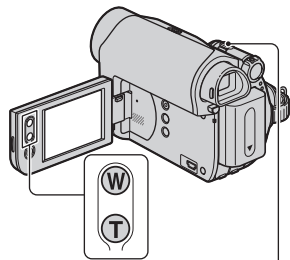

Wider range of view:
(Wide angle)

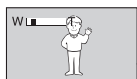

Close view: (Telephoto)

Move the power zoom lever slightly for a slower zoom. Move it further for a faster zoom.

Notes

- [STEADYSHOT] may not reduce image blurring as desired when the power zoom lever is set to the T (Telephoto) side.
- Be sure to keep your finger on the power zoom lever. If you move your finger off the power zoom lever, the operation sound of the power zoom lever may also be recorded.
- You cannot change the zoom speed with the zoom buttons on the LCD frame.
- The minimum possible distance between camcorder and subject while maintaining sharp focus is about 1 cm (about 13/32 in.) for wide angle and about 80 cm (about 2 5/8 feet) for telephoto.

Tips

- You can set [D ZOOM] (p. 37) if you want to zoom to a level greater than 40x.

Recording in dark places (NightShot plus)

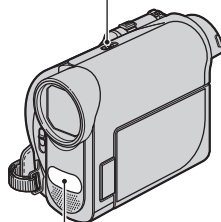
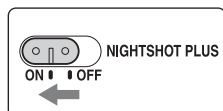

Infrared port

Set the NIGHTSHOT PLUS switch to ON. (📹 and ["NIGHTSHOT PLUS"] appear.)

Notes

- The NightShot plus function uses infrared light. Therefore, do not cover the infrared port with your fingers or other objects. Remove the conversion lens (optional) if it is attached.
- Adjust the focus manually ([FOCUS], p. 28) when it is hard to focus automatically.
- Do not use the NightShot plus function in bright places. This may cause a malfunction.

Adjusting the exposure for backlit subjects

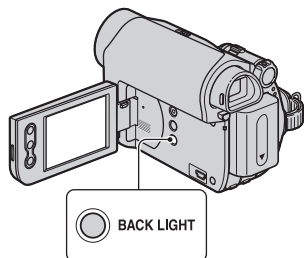

To adjust the exposure for backlit subjects, press BACK LIGHT to display . To cancel the back light function, press BACK LIGHT again.

Recording in mirror mode

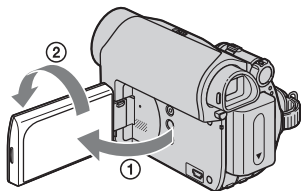

Open the LCD panel 90 degrees to the camcorder (①), then rotate it 180 degrees to the lens side (②).

Tips

- A mirror-image of the subject appears on the LCD screen, but the image will be normal when recorded.

Playback

- 1 Slide the **POWER** switch in the direction of the arrow repeatedly to turn on the **PLAY/EDIT** lamp.

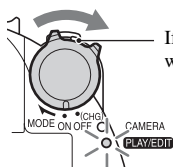

If the **POWER** switch is set to **OFF(CHG)**, slide it while pressing the green button.

- 2 Start playing back.

Touch to rewind the tape to the desired point, then touch to start playback.

Play/Pause* toggles as you touch it

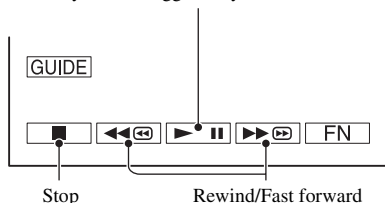

* Playback automatically stops if pause is engaged for more than 3 minutes.

To adjust the volume

Touch → [PAGE1] → [VOL], then / to adjust the volume.

To search for a scene during playback

Touch and hold / during playback (Picture Search), or / while fast forwarding or rewinding the tape (Skip Scan).

💡 Tips

- You can play back in various modes ([V SPD PLAY], p. 32).

Using the guide functions (USAGE GUIDE)

You can easily select the desired setting screens by using the guide functions (USAGE GUIDE).

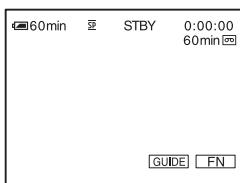

Your camcorder has 2 guide functions as shown below.

- | | |
|---------------------|---|
| SHOOT GUIDE: | Takes you to the setting screens related to recording. |
| DISP GUIDE: | Enables you to check the meaning of each indicator that appears on the LCD screen. See page 71 for details. |

1 Touch [GUIDE].

2 Select the desired item.

e.g., to record night views

Touch [SHOOT GUIDE] → [SELECT SCENE] → [PAGE ↓]/[PAGE ↑] to display [To keep the mood of a night view].

3 Touch [SET].

The desired setting screen appears.

Adjust the settings according to your purpose.

Unavailable settings during Easy Handycam

During Easy Handycam operation, some items are unavailable. If an attempted setting is not available, but still desired, touch [SET] to display an on-screen instruction. Follow the instruction to cancel Easy Handycam operation and then select the setting.

💡 Tips

- If [SET] is not displayed in step 3, follow the instruction on the screen.

Searching for the starting point

Make sure that the CAMERA lamp lights up (p. 19).

Searching for the last scene of the most recent recording (END SEARCH)

[END SCH] (END SEARCH) will not work once you eject the cassette after you have recorded on the tape.

Touch **[FN]** → **[PAGE1]**, then touch **[END SCH]**.

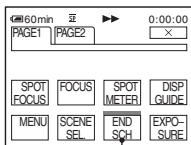

Touch here again to cancel the operation.

The last scene of the most recent recording is played back for about 5 seconds, and the camcorder enters the standby mode at the point where the last recording has finished.

Notes

- [END SCH] will not work correctly when there is a blank section between recorded sections on the tape.

Tips

- This operation is also available when the POWER switch is set to PLAY/EDIT.

Searching manually (EDIT SEARCH)

You can search for the start point to start the next recording while viewing the pictures on the screen. The sound is not played back during the search.

1 Touch **[FN]** → **[PAGE1]** → **[MENU]**.

2 Select **[CAMERA SET]** with **[↓]** / **[↑]**, then touch **[EXEC]**.

3 Select **[EDITSEARCH]** with **[↓]** / **[↑]**, then touch **[EXEC]**.

4 Select **[ON]** with **[↓]** / **[↑]**, then touch **[EXEC]** → **[X]**.

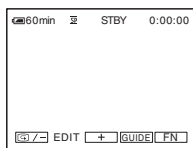

5 Touch and hold **[←]** (to go backward) / **[→]** (to go forward) and release it at the point where you want the recording to start.



Reviewing the most recently recorded scenes (Rec review)

You can view a few seconds of the scene recorded just before you stopped the tape.

1 Touch **[FN]** → **[PAGE1]** → **[MENU]**.

2 Select **[CAMERA SET]** with **[↓]** / **[↑]**, then touch **[EXEC]**.

3 Select [EDITSEARCH] with  / , then touch [EXEC].

4 Select [ON] with  / , then touch [EXEC] → .

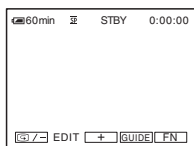

5 Touch  / .

The last few seconds of the most recently recorded scene are played back. Then, your camcorder is set to standby.

Playing the picture on a TV

You can connect your camcorder to the input jack of a TV or a VCR using the A/V connecting cable (1) or the A/V connecting cable with S VIDEO (2). Connect your camcorder to the wall outlet using the supplied AC Adaptor for this operation (p. 11). Refer also to the instruction manuals supplied with the devices to be connected.

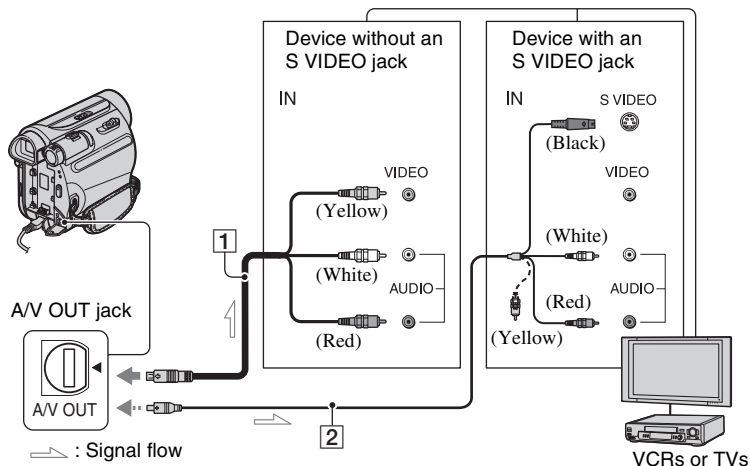

1 A/V connecting cable (supplied)

2 A/V connecting cable with S VIDEO (optional)

When connecting to another device via the S VIDEO jack, by using the A/V connecting cable with an S VIDEO cable, pictures can be reproduced more faithfully than with the supplied A/V cable connection.

Connect the white and red plugs (left/right audio) and S VIDEO plug (S VIDEO channel) of an A/V connecting cable. In this case, the yellow (standard video) plug connection is not necessary. S VIDEO connection only will not output audio.

💡 Tips

- You can display the time code on the TV screen by setting [DISP OUT] to [V-OUT/LCD] (p. 41).

When connecting your camcorder to a TV through a VCR

Connect your camcorder to the LINE IN input on the VCR. Set the input selector on the VCR to LINE (VIDEO 1, VIDEO 2, etc.), if the VCR has an input selector.

When your TV is monaural (Only one audio input jack)

Connect the yellow plug of the A/V connecting cable to the video input jack and connect the white (left channel) or the red (right channel) plug to the audio input jack of your TV or VCR.

Using the menu items

1 Slide the POWER switch in the direction of the arrow repeatedly to turn on the respective lamp.

CAMERA lamp: settings for recording on a tape

PLAY/EDIT lamp: settings for viewing/editing

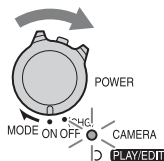

2 Touch the LCD screen to select the menu item.

Unavailable items will be grayed out.

■ To use the operation buttons on PAGE1/PAGE2/PAGE3

For details of the button items, see page 28.

- ① Touch .
- ② Touch the desired page.
- ③ Touch the desired button.
- ④ Select the desired setting, then touch → (Close).

⚡ Notes

- With some settings, you do not have to touch .

■ To use menu items

For details of the items, see page 35.

- ① Touch → [MENU] on [PAGE1].
The menu index screen appears.

- ② Select the desired menu.

Touch / to select the item, then touch [EXEC]. (The process in step ③ and ④ is the same as that in step ②.)

- ③ Select the desired item.

- ④ Customize the item.

After finishing the settings, touch

(close) to hide the menu screen.

Each touch of [RET.] takes you to the previous screen.

■ To use menu items during Easy Handycam operation

- ① Touch .
- ② Select the desired button.
- ③ Change your item setting.

After finishing the settings, touch

(close).

⚡ Notes

- Cancel Easy Handycam operation to use menu items normally.

Operation button items

Available operation buttons vary depending on the position of the lamp and the display (PAGE).

The default settings are marked with ►.

The indicators in parentheses appear when the items are selected.

The available functions during Easy Handycam operation are marked with “***”.

See page 27 for details on selecting button items.

When the CAMERA lamp lights up

[PAGE1]

SPOT FOCUS

You can select and adjust the focal point to a subject not located in the center of the screen.

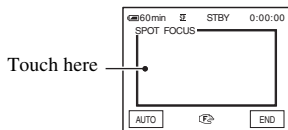

Touch the point where you want to focus on in the frame.

 appears.

To adjust the focus automatically, touch [AUTO] or set [FOCUS] to [AUTO].

Notes

- If you set [SPOT FOCUS], [FOCUS] is automatically set to [MANUAL].





FOCUS

You can adjust the focus manually. You can select this function also when you want to focus on a certain subject intentionally.



① Touch [MANUAL].

 appears.

② Touch  (focusing on close subjects)/  (focusing on distant subjects) to sharpen the focus.  appears when the focus cannot be adjusted any closer, and  appears when the focus cannot be adjusted farther away.

To adjust the focus automatically, touch [AUTO] in step ①.

Notes

- The minimum possible distance between camcorder and subject while maintaining sharp focus is about 1 cm (about 13/32 in.) for wide angle and about 80 cm (about 2 5/8 feet) for telephoto.

Tips

- It is easier to focus on the subject by moving the power zoom lever towards T (telephoto) to adjust the focus, then towards W (wide angle) to adjust the zoom for recording. When you want to record a subject at close range, move the power zoom lever to W (wide angle), then adjust the focus.

SPOT METER (Flexible spot meter)

You can adjust and fix the exposure to the subject, so that it is recorded in suitable brightness even when there is strong contrast between the subject and the background, such as subjects in the spotlight on stage.

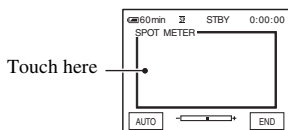

Touch the point where you want to fix and adjust the exposure on the screen.

↔ appears.

To return the setting to automatic exposure, touch [AUTO] or set [EXPOSURE] to [AUTO].

Notes

- If you set [SPOT METER], [EXPOSURE] is automatically set to [MANUAL].

DISP GUIDE (Display Guide)*

See page 71.

MENU

See page 35.

SCENE SEL.

You can record pictures effectively in various situations with the SCENE SEL. function.

► AUTO

Select to automatically record pictures effectively without the [SCENE SEL.] function.

TWILIGHT* (☾)

Select to maintain the darkening atmosphere of the distant surroundings in twilight scenes.



SUNR/SUNST* (Sunrise & Sunset) (☀)

Select to maintain the atmosphere of situations such as sunsets and sunrises.



LANDSCAPE* (🏞)

Select to shoot distant subjects clearly. This setting also prevents your camcorder from focusing on glass or metal mesh in windows between the camcorder and the subject.



PORTRAIT (Soft portrait) (👤)

Select to bring out the subject such as people or flowers while creating a soft background.



SPOTLIGHT** (🎤)

Select to prevent people's faces from appearing excessively white when subjects are lit by strong light.



Operation button items (Continued)

SPORT** (Sports lesson) (人)

Select to minimize shake when shooting fast moving subjects.



SNOW** (人)

Select this when shooting in very bright, white conditions, such as on a ski slope; otherwise pictures may appear too dark.



BEACH** (人)

Select to prevent people's faces from appearing dark in strong light or reflected light, such as at a beach in midsummer.



* Adjusted to focus on subjects farther away only.

** Adjusted not to focus on subjects a short distance away.

END SCH (END SEARCH)

See page 24.

EXPOSURE

You can fix the brightness of a picture manually. Adjust the brightness when the subject is too bright or too dark.

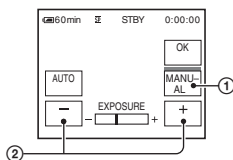

① Touch [MANUAL].

← → appears.

② Adjust the exposure by touching [-] / [+].

To return the setting to automatic exposure, touch [AUTO].

[PAGE2]

FADER

You can add the following effects to currently recording pictures.

① Select the desired effect in standby mode (to fade in) or recording mode (to fade out), then touch [OK] → [X].

② Press REC START/STOP.

The fader indicator stops flashing and disappears when the fade is complete.

To cancel [FADER] before starting the operation, touch [OFF] in step ①. If you press REC START/STOP once, the setting is canceled.



WHITE



BLACK**MOSC. FADER****MONOTONE**

When fading in, the picture gradually changes from black and white to color. When fading out, it gradually changes from color to black and white.

WHT BAL (White balance)

You can adjust the color balance to the brightness of the recording environment.

► AUTO

The white balance is adjusted automatically.

OUTDOOR (☀)

The white balance is appropriately adjusted for the following recording conditions:

- Outdoors
- Night views, neon signs and fireworks
- Sunrise or sunset
- Under daylight fluorescent lamps

INDOOR (☼)

The white balance is appropriately adjusted for the following recording conditions:

- Indoors
- At party scenes or studios where the lighting conditions change quickly
- Under video lamps in a studio, or under sodium lamps or incandescent-like color lamps

ONE PUSH (☑)

The white balance will be adjusted according to the ambient light.



- ① Touch [ONE PUSH].

- ② Frame a white object such as a piece of paper, to fill the screen under the same lighting conditions as you will shoot the subject.

- ③ Touch .

 flashes quickly. When the white balance has been adjusted and stored in the memory, the indicator stops flashing.

⚙ Notes

- Set [WHT BAL] to [AUTO] or [ONE PUSH] under white or cool white fluorescent lamps.
- When you select [ONE PUSH], keep framing white object while  is flashing quickly.
-  flashes slowly if [ONE PUSH] could not be set.
- When [ONE PUSH] was selected, if  keeps flashing after touching [OK], set [WHT BAL] to [AUTO].

💡 Tips

- If you have changed the battery pack while [AUTO] was selected, or taken your camcorder outdoors after inside use with the [EXPOSURE] set (or vice versa), select [AUTO] and aim your camcorder at a nearby white object for about 10 seconds for better color balance adjustment.
- When the white balance has been set with [ONE PUSH], if you change the [SCENE SEL.] settings, or bring your camcorder outdoors from inside the house, or vice versa, you need to redo the [ONE PUSH] procedure to readjust the white balance.

BEEP***► ON**

A beeping sound starts when you start/stop recording, or operate the touch panel.

OFF

Cancels the beeping sound and shutter sound.

CLOCK SET*

See page 14.

Operation button items (Continued)

LCD BRT (LCD bright)

You can adjust the brightness of the LCD screen. The recorded picture will not be affected by this operation.

Adjust the brightness with / .

When the PLAY/EDIT lamp lights up

You can use the video operation buttons (, , ,) on every PAGE.

[PAGE1]

MENU

See page 35.

VOL* (Volume)

See page 22.

END SCH (END SEARCH)

See page 24.

DISP GUIDE (Display Guide)*

See page 71.

[PAGE2]

DATA CODE*

During playback, displays information (data code) recorded automatically at the time of recording.

▶ OFF

Data code is not displayed.

CAM DATA (below)

Displays camera setting data.

DATE/TIME

Displays the date and time.

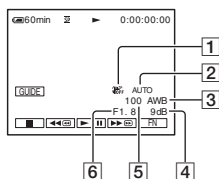

- 1 SteadyShot off
- 2 Exposure
- 3 White balance
- 4 Gain
- 5 Shutter speed
- 6 Aperture value

ⓘ Notes

- In the [DATE/TIME] data display, the date and time are displayed in the same area. If you record a picture without setting the clock, [--- --] and [---:--:--] will appear.
- During Easy Handycam operation, you can set [DATE/TIME] only.

BEEP*

See page 31.

CLOCK SET

See page 14.

[PAGE3]

V SPD PLAY (Various speed playback)

You can play back in various modes while viewing movies.

- ① Touch the following buttons during playback.

To	Touch
change the playback direction*	(frame)

To	Touch
play back slowly**	[▶▶SLOW] To reverse direction: ◀◀ < (frame) → [▶▶SLOW]
play back 2 times faster (double speed)	[×2] (double speed) To reverse direction: ◀◀ < (frame) → [×2] (double speed)
play back frame by frame	[>▶▶] (frame) during playback pause. To reverse direction: ◀◀ < (frame) during frame playback.

* Horizontal lines may appear at the top, bottom, or in the center of the screen. This is not a malfunction.

Pictures output from the **i DV Interface (i.LINK) cannot be played back smoothly in slow mode.

② Touch [↶ RET.] → [×] .

To return to the normal playback mode, touch [▶▶] (Play/Pause) twice (once from frame playback).

Notes

- You will not hear the recorded sound. You may see mosaic-like images of the previously played picture.

A DUB CTRL (Audio dubbing)

Using the internal stereo microphone (p. 67), you can add sound to a tape already recorded in 12-bit mode (p. 40) without erasing the original sound.

Notes

- You cannot record additional audio:
 - When the tape has been recorded in the 16-bit mode (p. 40).
 - When the tape has been recorded in the LP mode.
 - When your camcorder is connected via an i.LINK cable.

- When the tape has been recorded in 4CH MIC mode on other camcorders.
- On blank sections of the tape.
- When the tape has been recorded in a TV color system other than that of your camcorder (p. 57).
- When the write-protect tab of the cassette is set to SAVE (p. 58).
- On sections recorded in HDV format.
- When you add sound, the picture will not be output from the A/V OUT jack. Check the picture on the LCD screen or the viewfinder.
- You can only record additional audio over a tape recorded on your camcorder. The sound may deteriorate when you dub audio on a tape recorded on other camcorders (including other DCR-HC38 camcorders).

Recording sound

Insert a recorded cassette into your camcorder beforehand.

- Slide the POWER switch repeatedly to turn on the PLAY/EDIT lamp.
- Touch [▶▶] (Play/Pause) to play back the tape, then touch it again at the point where you want to start recording the sound.
- Touch [FN] → [PAGE3] → [A DUB CTRL] → [AUDIO DUB].

● appears.

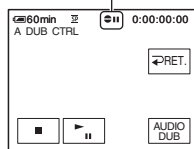

- Touch [▶▶] (Play).
Your camcorder starts audio recording via the internal stereo microphone.
● appears while recording the new sound in stereo 2 (ST2) during the playback of the tape.
- Touch [■] (Stop) when you want to stop recording.
To dub on other scenes, repeat step ② to select scenes, then touch [AUDIO DUB].
- Touch [↶ RET.] → [×] .

Operation button items (Continued)

To check the recorded sound

- ① Play back the tape on which you have recorded audio (p. 22).
- ② Touch **[FN]** → [PAGE1] → [MENU].
- ③ Select **[V]** (VCR SET), then touch **[↓]** / **[↑]** to select [AUDIO MIX], then touch [EXEC].

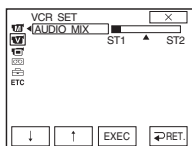

- ④ Touch **[↓]** / **[↑]** to adjust the balance of the original sound (ST1) and the new sound (ST2), then touch [EXEC].

🔊 Notes

- The original sound (ST1) is output at the default setting.

REC CTRL (Recording control)

See page 44.

LCD BRT (LCD bright)

See page 32.

Menu items

- Available menu items (●) vary depending on which lamp is lit.
- During Easy Handycam operation, the following settings are automatically applied (p. 17).

	CAMERA	PLAY/EDIT	Easy Handycam
MANUAL SET menu (p. 36)			
P EFFECT	●	●	OFF
CAMERA SET menu (p. 37)			
D ZOOM	●	–	OFF
WIDE SEL	●	–	4:3
STEADYSHOT	●	–	ON
EDITSEARCH	●	–	OFF
N.S.LIGHT	●	–	ON
VCR SET menu (p. 38)			
AUDIO MIX	–	●	–
LCD/VF SET menu (p. 39)			
LCD B.L.	●	●	BRT NORMAL
LCD COLOR	●	●	–
VF B.L.	●	●	BRT NORMAL
WIDE DISP	●	●	–
TAPE SET menu (p. 40)			
REC MODE	●	●	SP
AUDIO MODE	●	–	12BIT
REMAIN	●	●	AUTO
SETUP MENU menu (p. 40)			
USB STREAM	●	●	OFF
LANGUAGE	●	●	●
DEMO MODE	●	–	ON
OTHERS menu (p. 41)			
WORLD TIME	●	●	–*
A.SHUT OFF	●	●	5min
DISP OUT	●	●	LCD

* The value set before Easy Handycam operation will be retained during Easy Handycam operation.

- P EFFECT

The default setting is marked with ►.
The indicators in parentheses appear when the items are selected.

See page 27 for details on selecting menu items.

P EFFECT (Picture effect)

You can add special effects to a picture during recording or playback.  appears.

► OFF

Does not use [P EFFECT] setting.

NEG.ART

The color and brightness are reversed.



SEPIA

Pictures appear in sepia.

B&W

Pictures appear in black and white.

SOLARIZE

Pictures appear as an illustration with strong contrast.



PASTEL *

Pictures appear as a pale pastel drawing.



MOSAIC*

Pictures appear mosaic-patterned.



* Not available during playback.

Notes

- Effects added to the playback pictures are not output via the  DV Interface (i.LINK). Only the original pictures can be output.
- You cannot add effects to externally input pictures.

Tips

- You can record pictures edited with special effects on another VCR/DVD device, etc. (p. 42).

CAMERA SET

menu

– D ZOOM/WIDE SEL/STEADYSHOT, etc.

The default settings are marked with ►.
The indicators in parentheses appear when the items are selected.

See page 27 for details on selecting menu items.

D ZOOM (Digital zoom)

You can select the maximum zoom level in case you want to zoom to a level greater than 40× (the default setting) while recording on a tape. Note that the image quality decreases when you are using the digital zoom.

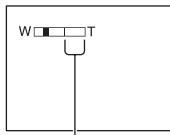

The right side of the bar shows the digital zooming factor. The zooming zone appears when you select the zooming level.

► OFF

Up to 40× zoom is performed optically.

80 ×

Up to 40× zoom is performed optically, and after that, up to 80× zoom is performed digitally.

2000 ×

Up to 40× zoom is performed optically, and after that, up to 2,000× zoom is performed digitally.

WIDE SEL (Wide select)

You can record a picture in a ratio suitable for the screen on which it will be displayed. Refer also to the operating instructions supplied with your TV for details.

► 4:3

Standard setting (to record pictures to be played back on a 4:3 TV).

16:9 WIDE (16:9)

Records pictures to be played back on a 16:9 wide TV in full screen mode.

When viewed on the LCD screen/viewfinder with [16:9 WIDE] selected.

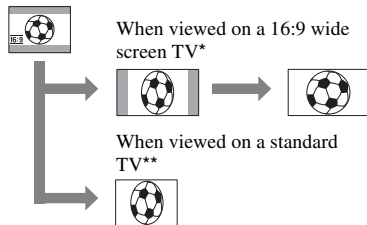

* Picture appears in full screen mode when the wide-screen TV switches to full mode.

** Played in 4:3 mode. When you play a picture in the wide mode, it appears as you saw it on the LCD screen or in the viewfinder.

STEADYSHOT



You can compensate for camera shake (the default setting is [ON]). Set [STEADYSHOT] to [OFF] () when using a tripod (optional) or the conversion lens (optional), then the image becomes natural.

EDITSEARCH

► OFF

Does not display  or  on the LCD screen.

ON

Displays  and  on the LCD screen, and enables the EDIT SEARCH function and Rec review (p. 24).

N.S.LIGHT (NightShot Light)

When using the NightShot plus (p. 20) function to record, you can record clearer pictures by setting [N.S.LIGHT], which emits infrared light (invisible), to [ON] (the default setting).

Notes

- Do not cover the infrared port with your fingers or other objects (p. 67).
- Remove the conversion lens (optional) if it is attached.
- The maximum shooting distance using [N.S.LIGHT] is about 3 m (10 feet).

Tips

- If you record subjects in dark places, such as night scenes or in moonlight, set [N.S.LIGHT] to [OFF]. You can make the image color deeper this way.

AUDIO MIX

See page 34.

LCD/VF SET menu

– LCD B.L./LCD COLOR/VF B.L., etc

The default settings are marked with ►.
See page 27 for details on selecting menu items.

LCD B.L. (LCD back light)

You can adjust the brightness of the LCD screen's backlight. The recorded picture will not be affected by this operation.

► BRT NORMAL

Standard brightness.



BRIGHT

Brightens the LCD screen.

Notes

- When you connect your camcorder to outside power sources, [BRIGHT] is automatically selected for the setting.
- When you select [BRIGHT], battery life is slightly reduced during recording.

LCD COLOR

You can adjust the color on the LCD screen with  / . The recorded picture will not be affected by this operation.

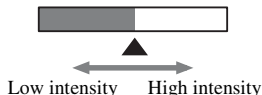

VF B.L. (Viewfinder back light)

You can adjust the brightness of the viewfinder. The recorded picture will not be affected by this operation.

► BRT NORMAL

Standard brightness.

BRIGHT

Brightens the viewfinder screen.

Notes

- When you connect your camcorder to outside power sources, [BRIGHT] is automatically selected for the setting.
- When you select [BRIGHT], battery life is slightly reduced during recording.

WIDE DISP (Wide display)

You can select how a 16:9 aspect ratio picture appears in the viewfinder and the LCD screen by setting [WIDE SEL] to [16:9 WIDE]. The recorded picture will not be affected by this operation.

► LETTER BOX

Normal setting (standard type of display)

SQUEEZE

Expands the picture vertically if black bands at the top and bottom in 16:9 aspect ratio are undesirable.

TAPE SET menu

– REC MODE/AUDIO MODE/REMAIN

The default settings are marked with ►. The indicators in parentheses appear when the items are selected.

See page 27 for details on selecting menu items.

REC MODE (Recording mode)

► SP (SP)

Records in the SP (Standard Play) mode on a cassette.

LP (LP)

Increases the recording time to 1.5 times the SP mode (Long Play).

Notes

- If you record in the LP mode, pictures may appear mosaic-like or sound may be interrupted when you play back the tape on other camcorders or VCRs.
- When you mix recordings in the SP mode and in the LP mode on one tape, the playback picture may be distorted or the time code may not be written properly between the scenes.

AUDIO MODE

► 12BIT

Records in the 12-bit mode (2 stereo sounds).

16BIT (16b)

Records in the 16-bit mode (1 stereo sound with high quality).

REMAIN

► AUTO

Displays the remaining tape indicator for about 8 seconds in situations such as those described below.

- When you set the POWER switch to PLAY/EDIT or CAMERA with a cassette inserted.
- When you touch  (Play/Pause).

ON

Always displays the remaining tape indicator.

SETUP MENU menu

– USB STREAM/LANGUAGE, etc.

See page 27 for details on selecting menu items.

USB STREAM

You can view the pictures displayed on the screen of your camcorder on your computer (USB Streaming) via the USB cable. See “First Step Guide” in the supplied CD-ROM for details (p. 49).

LANGUAGE

You can select the language to be used on the LCD screen.

- Your camcorder offers [ENG[SIMP]] (simplified English) for when you cannot find your native tongue among the options.

DEMO MODE

The default setting is [ON], allowing you to view the demonstration about 10 minutes after you have removed a cassette from your camcorder, and slide the POWER switch repeatedly to turn on the CAMERA lamp.

Tips



- The demonstration will be suspended in situations such as those described below.
 - When you touch the screen during the demonstration. (The demonstration starts again after about 10 minutes.)
 - When a cassette is inserted.
 - When the POWER switch is set to other than CAMERA.

ETC OTHERS menu

– WORLD TIME, etc.

The default settings are marked with ►.
See page 27 for details on selecting menu items.

WORLD TIME

When using your camcorder abroad, you can set the time difference by touching  / , the clock will be adjusted in accordance with the time difference.

If you set the time difference to 0, the clock returns to the originally set time.

A.SHUT OFF (Auto shut off)

► 5min

The camcorder is automatically turned off when you do not operate your camcorder for more than approximately 5 minutes.

NEVER

The camcorder is not automatically turned off.

🔌 Notes

- When you connect your camcorder to a wall outlet, [A.SHUT OFF] is automatically set to [NEVER].

DISP OUT (Display output)

► LCD

Shows displays such as the time code on the LCD screen and in the viewfinder.

V-OUT/LCD

Shows displays such as the time code on the TV screen, LCD screen, and in the viewfinder.

Dubbing to VCR or DVD/HDD recorders

You can dub images played back on your camcorder to other recording devices, such as VCRs or DVD/HDD recorders.

You can connect your camcorder to VCRs or DVD/HDD recorders, using the A/V connecting cable (1), the A/V connecting cable with S VIDEO (2), or the i.LINK cable (3).

Connect your camcorder to the wall outlet using the supplied AC Adaptor for this operation (p. 11). Refer also to the instruction manuals supplied with the devices to be connected.

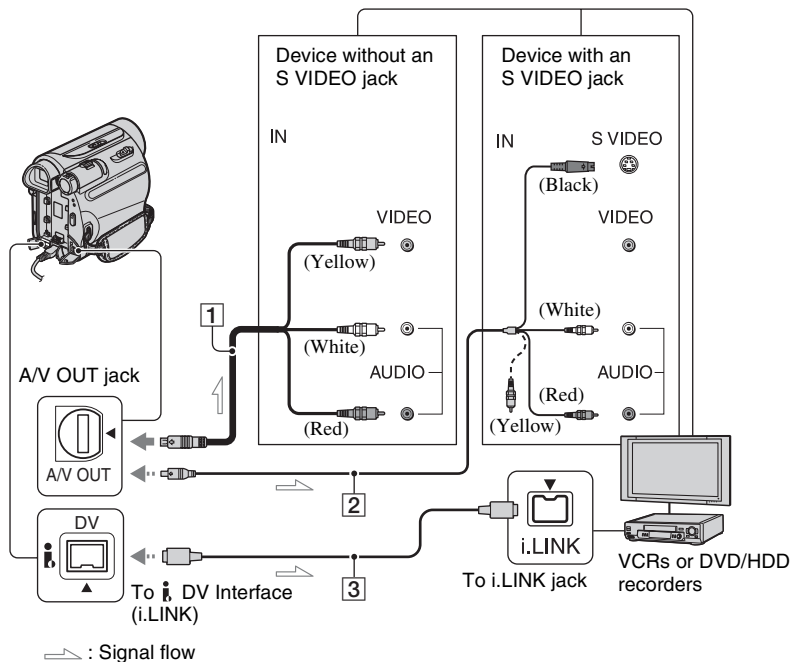

1 A/V connecting cable (supplied)

2 A/V connecting cable with S VIDEO (optional)

When connecting to another device via the S VIDEO jack, by using the A/V connecting cable with an S VIDEO cable, pictures can be reproduced more faithfully than with the supplied A/V cable connection. Connect the white and red plugs (left/right audio) and S VIDEO plug (S VIDEO channel) of an A/V connecting cable. In this case, the yellow (standard video) plug connection is not

necessary. S VIDEO connection only will not output audio.

3 i.LINK cable (optional)

Use an i.LINK cable to connect your camcorder to another device equipped with an i.LINK jack. The video and audio signals are transmitted digitally, producing high quality pictures and sound. Note that you cannot output picture and sound separately.

Notes

- When you are connecting your camcorder to a monaural device, connect the yellow plug of the

A/V connecting cable to the video input jack, and the red (right channel) or the white (left channel) plug to the audio input jack on the device.

- When you connect a device via an A/V connecting cable, set [DISP OUT] to [LCD] (the default setting) (p. 41).

1 Prepare your camcorder for playback.

Insert the recorded cassette.

Slide the POWER switch repeatedly to turn on the PLAY/EDIT lamp.

2 Insert the recording media in the recording device.

If your recording device has an input selector, set it to the appropriate input (such as video input1, video input2).

3 Connect your camcorder to the recording device (VCR or DVD/HDD recorder) with the A/V connecting cable (supplied) ①, an A/V connecting cable with S VIDEO (optional) ② or an i.LINK cable (optional) ③.

Connect your camcorder to the input jacks of the recording device.

4 Start playback on the camcorder, and recording on the recording device.

Refer to the operating instructions supplied with your recording device for details.

5 When dubbing is complete, stop your camcorder and the recording device.

Notes

- To record the date/time and camera settings data when connected by the A/V connecting cable, display them on the screen (p. 32).
- The following cannot be output via the DV Interface (i.LINK):
 - Indicators
 - Pictures edited using [P EFFECT] (p. 36)
- When connected using an i.LINK cable, the recorded picture becomes rough when a picture is paused on your camcorder while recording.
- When connected using an i.LINK cable, data code (date/time/camera settings data) may not be displayed or recorded depending on the device or application.

Recording pictures from a TV or VCR, etc.

Using an i.LINK cable (optional), you can record pictures or TV programs from a TV or VCR, etc., on a tape.

Be sure to insert a cassette for recording in your camcorder beforehand.

You can connect your camcorder to a TV, VCR or an i.LINK-compatible device using the i.LINK cable (optional).

Connect your camcorder to the wall outlet using the supplied AC Adaptor for this operation (p. 11). Refer also to the instruction manuals supplied with the devices to be connected.

⚡ Notes

- You cannot record pictures on your camcorder from a TV or VCR that does not have an i.LINK jack.
- You cannot input picture and sound separately.

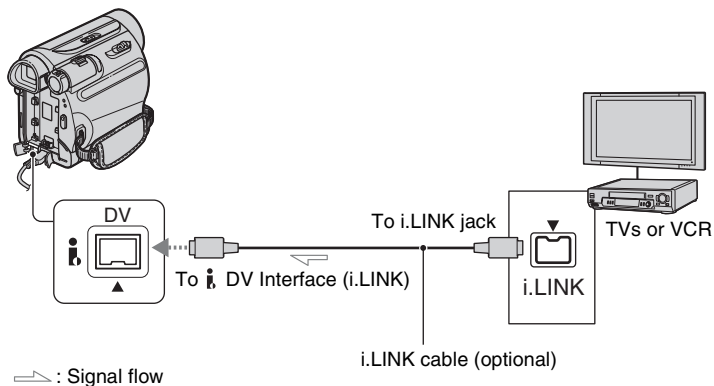

When connecting your camcorder to another device using an i.LINK cable, the video and audio signals are transmitted digitally, producing high quality pictures and sound. Note that you cannot output picture and sound separately.

1 Connect your TV or VCR to your camcorder with an i.LINK cable.

2 If you are recording from a VCR, insert a cassette.

3 Slide the **POWER** switch repeatedly to turn on the **PLAY/EDIT** lamp.

4 Set your camcorder to recording pause mode.

Touch **FN** → [PAGE3] → [REC CTRL] → [REC PAUSE].

5 When recording pictures from a VCR:

Start playing the cassette on the VCR.

When recording pictures from a TV:

Select a TV program.

The picture played on the connected device appears on the LCD screen of your camcorder.

6 Touch [REC START] at the point you want to start recording.

7 Stop recording.

Touch  (Stop) or [REC PAUSE].

8 Touch [RET.] → .

Notes

- The DV_{IN} indicator appears when you connect your camcorder and other devices via an i.LINK cable. (This indicator may also appear on the connected device.)

What you can do with Windows computer

When you install the “Picture Motion Browser” on a Windows computer from the supplied CD-ROM, you can enjoy the following operations.

Notes

- You cannot install the supplied software, “Picture Motion Browser”, on a Macintosh computer.

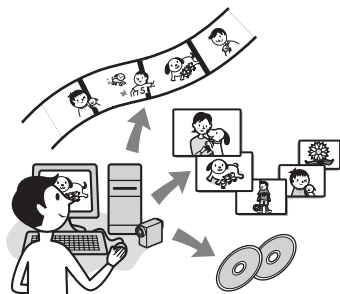

Main functions

■ Importing/Viewing movies taken with your camcorder

You can manage movies by date and time of shooting, and select movies you want to view as thumbnails. These thumbnails can be enlarged and played in a slide show.

■ Editing movies imported to a computer

You can edit imported movies on a computer.

■ Exporting movies from your computer to your camcorder

You can export movies that have been imported to a computer from your camcorder, back to your camcorder.

About “First Step Guide”

The “First Step Guide” is an instruction manual you can refer to on your computer. This describes basic operations, from initial hookup of your camcorder and computer and making settings, to general operation the first time you use the software “Picture Motion Browser” stored on the CD-ROM (supplied).

Referring to “Installing the “First Step Guide”” (p. 47), start the “First Step Guide”, then follow the instructions.

About the help function of the software

The Help guide explains all the functions of all the software applications. Refer to the Help guide for further detailed operations after reading the “First Step Guide” thoroughly.

To display the Help guide, click the [?] mark on the screen.

System requirements

When using “Picture Motion Browser”

OS: Microsoft Windows 2000 Professional, Windows XP Home Edition, Windows XP Professional or Windows XP Media Center Edition Standard installation is required. Operation is not assured if the above OS has been upgraded or in a multi-boot environment.

CPU: Intel Pentium III 800 MHz or faster

Application: DirectX 9.0c or later (This product is based on DirectX technology. It is necessary to have DirectX installed.)

Sound system: Direct Sound compatible sound card

Memory: 256 MB or more

Hard disk: Disc volume required for installation: Approximately 350 MB

Display: DirectX 7 or later-compatible video card, Minimum 1024 × 768 dots, High Color (16 bit color)

Others: ψ USB port (This must be provided as standard), DV Interface (IEEE1394, i.LINK) (to connect via an i.LINK cable), disc drive (You need a CD-ROM drive to install the “Picture Motion Browser”).)

⚡ Notes

- Operations are not guaranteed on all the recommended environments. For example, other open or background applications running on currently may limit product performance.

Installing the “First Step Guide” and software

You need to install the “First Step Guide” and software to your Windows computer **before connecting your camcorder to the computer**. The installation is required only for the first time. Contents to be installed and procedures may differ depending on your OS.

Installing the “First Step Guide”

1 Confirm that your camcorder is not connected to the computer.

2 Turn on the computer.

- Log on as an Administrator for installation.
- Close all applications running on the computer before installing the software.

3 Place the supplied CD-ROM in the disc drive of your computer.

The installation screen appears.



If the screen does not appear

- ① Click [Start], then click [My Computer]. (For Windows 2000, double-click [My Computer].)
- ② Double-click [SONYPICUTIL (E:)] (CD-ROM) (disc drive).*

* Drive names (such as (E:)) may vary depending on the computer.

4 Click [FirstStepGuide].

- 5 Select the desired language and the model name of your camcorder from the pull-down menu.



- 6 Click [FirstStepGuide(HTML)].

Installation starts.

When [Save is complete] appears, click [OK] to finish the installation.

To view the “First Step Guide” in PDF

In step 6, click [FirstStepGuide(PDF)].

To install the software “Adobe Reader” to display the PDF file

In step 6, click [Adobe(R) Reader(R)].

Installing the software

- 1 Perform steps 1 to 3 in “Installing the “First Step Guide”” (p. 47).

- 2 Click [Install].

- 3 Select the language for the application to be installed, then click [Next].

- 4 Check your country/region, then click [Next].

- 5 Read [License Agreement], select [I accept the terms of the license agreement] when you agree, then click [Next].

- 6 Follow the on-screen instructions to install the software.

Depending on the computer, you may need to install third party software (shown below). If the installation screen appears, follow the instructions to install the required software.

■ Microsoft DirectX 9.0c

Software required to handle movies

Restart the computer if required to complete the installation.

The short-cut icons, such as [] (Picture Motion Browser), appear on the desktop.



- 7 Remove the CD-ROM from the disc drive of your computer.



After you install the software, a shortcut icon for the customers registration website is created on the desktop.

- Once you register on the website, you can get secure and useful customer support.
<http://www.sony.net/registration/di/>

Viewing “First Step Guide”

To view “First Step Guide” on your computer, Microsoft Internet Explorer Ver.6.0 or later is recommended. Double-click the short-cut icon for “First Step Guide” on the desktop.

Tips

- You can also start by selecting [Start] → [Programs] ([All Programs] for Windows XP) → [Sony Picture Utility] → [FirstStepGuide] → Your camcorder's folder → “First Step Guide” in HTML.
- To view “First Step Guide” in HTML without installing, copy the desired language folder from the [FirstStepGuide] folder on the CD-ROM, and then double-click [Index.html].
- Refer to the “First Step Guide” in PDF in the following cases:
 - When printing the desired topics of “First Step Guide”
 - When “First Step Guide” is not displayed correctly due to the browser setting even in recommended environment.
 - When the HTML version of “First Step Guide” cannot be installed.

Troubleshooting

If you run into any problems using your camcorder, use the following table to troubleshoot the problem. If the problem persists, disconnect the power source and contact your Sony dealer.

• Overall operations/Easy Handycam	50
• Batteries/Power sources	50
• LCD screen/viewfinder	51
• Cassette tapes	51
• Recording	52
• Playback	53
• Dubbing/Editing/Connecting to other devices	53
• Connecting to a computer	54
• Functions that cannot be used together	54

Overall operations/Easy Handycam

The power does not turn on.

- Attach a charged battery pack to the camcorder (p. 11).
- Use the AC Adaptor to connect to a wall outlet (p. 11).

The camcorder does not operate even when the power is set to on.

- Disconnect the AC Adaptor from the wall outlet or remove the battery pack, then reconnect it after about 1 minute.
- Press the RESET button (p. 68) using a sharp-pointed object. (If you press the RESET button, all settings are reset.)

Buttons do not work.

- During Easy Handycam operation, not all buttons are functional (p. 18).

Settings change during Easy Handycam operation.

- During Easy Handycam operation, the settings of the functions that are not displayed on the screen return to their defaults (p. 17, 35).

The menu item settings have changed unexpectedly.

- The following settings return to the default settings automatically when you set the POWER switch to OFF(CHG) for more than 12 hours.
 - BACK LIGHT
 - [SPOT FOCUS]
 - [FOCUS]
 - [SPOT METER]
 - [SCENE SEL.]
 - [EXPOSURE]
 - [WHT BAL]
 - [AUDIO MIX]

The camcorder gets warm.

- The camcorder may get warmer while you use it. This is not a malfunction.

Batteries/Power sources

The power abruptly turns off.

- When approximately 5 minutes have elapsed while you do not operate your camcorder, the camcorder is automatically turned off [A.SHUT OFF]. Change the setting of [A.SHUT OFF] (p. 41), or turn on the power again (p. 14), or use the AC Adaptor.
- Charge the battery pack (p. 11).
- The battery is fully discharged, or almost discharged.

The CHG (charge) lamp does not light while the battery pack is being charged.

- Slide the POWER switch to OFF(CHG) (p. 11).

- Attach the battery pack to the camcorder correctly (p. 11).
- Connect the power cord to the wall outlet properly (p. 11).
- The battery charge is completed (p. 12).

The CHG (charge) lamp flashes while the battery pack is being charged.

- Attach the battery pack to the camcorder correctly (p. 11). If the problem persists, disconnect the AC Adaptor from the wall outlet and contact your Sony dealer. The battery pack may be worn-out.

The remaining battery time indicator does not indicate the correct time.

- Ambient temperature is too high or too low, or the battery pack has not been charged enough. This is not a malfunction.
- Fully charge the battery again. If the problem persists, the battery may be worn-out. Replace it with a new one (p. 11, 59).
- The indicated time may not be correct in certain circumstances. For example, when you open or close the LCD panel, it takes about 1 minute to display the correct remaining battery time.

The battery pack discharges too quickly.

- Ambient temperature is too high or too low, or the battery pack has not been charged enough. This is not a malfunction.
- Fully charge the battery again. If the problem persists, the battery may be worn-out. Replace it with a new one (p. 11, 59).

LCD screen/viewfinder

A rippling effect appears on the LCD screen when you touch it.

- This is not a malfunction. Do not press hard on the LCD screen.

The buttons do not appear on the touch panel.

- Touch the LCD screen lightly.
- Press DISP/BATT INFO on your camcorder (p. 68).

The buttons on the touch panel do not work correctly or do not work at all.

- Adjust the touch panel ([CALIBRATION]) (p. 62).

Menu items are grayed out.

- You cannot select grayed items in the current recording/playback situation.

The picture in the viewfinder is not clear.

- Move the viewfinder lens adjustment lever until the picture appears clearly (p. 15).

The picture in the viewfinder has disappeared.

- Close the LCD panel. The picture is not displayed in the viewfinder when the LCD panel is open (p. 15).

Dots in lines appear on the LCD screen.

- This is not a malfunction. These dots are not recorded.

Cassette tapes

The cassette cannot be ejected from the compartment.

- Make sure the power source (battery pack or AC Adaptor) is connected correctly (p. 11).
- Moisture condensation has occurred inside the camcorder (p. 61).

The Cassette Memory indicator or title display does not appear while using a cassette with Cassette Memory.

- This camcorder does not support Cassette Memory, so the indicator does not appear.

The remaining tape indicator is not displayed.

- Set [REMAIN] to [ON] to always display the remaining tape indicator (p. 40).

The cassette is noisier during rewinding or fast-forwarding.

- When using the AC Adaptor, rewind/fast forward speed increases (compared with battery operation) and therefore increases noise. This is not a malfunction.

Recording

The tape does not start when you press REC START/STOP.

- Slide the POWER switch repeatedly to turn on the CAMERA lamp (p. 19).
- The tape has reached the end. Rewind it, or insert a new cassette.
- Set the write-protect tab to REC or insert a new cassette (p. 58).
- The tape is stuck to the drum due to moisture condensation. Remove the cassette and leave your camcorder for at least 1 hour, then re-insert the cassette (p. 61).

You cannot record a smooth transition on a tape from the last recorded scene to the next.

- Perform [END SCH] (p. 24).
- Do not remove the cassette. (The picture will be recorded continuously without a break even when you turn the power off.)
- Do not record pictures in SP mode and LP mode on the same tape.

- Avoid stopping then recording a movie in the LP mode.

[END SCH] does not work.

- Do not eject the cassette after recording (p. 24).
- There is nothing recorded on the cassette.
- There is a blank section between recorded sections of the tape. This is not a malfunction.

The auto focus does not function.

- Set [FOCUS] to [AUTO] (p. 28).
- The recording conditions are not suitable for auto focus. Adjust the focus manually (p. 28).

[STEADYSHOT] does not function.

- Set [STEADYSHOT] to [ON] (p. 37).

The BACK LIGHT function does not function.

- In the following settings, the BACK LIGHT function is canceled.
 - [MANUAL] of [EXPOSURE]
 - [SPOT METER]
- The BACK LIGHT function does not work during Easy Handycam operation (p. 18).

A vertical band appears when recording candlelight or electric light in the dark.

- This occurs when the contrast between the subject and the background is too high. This is not a malfunction.

A vertical band appears when recording a bright subject.

- This phenomenon is called the smear effect. This is not a malfunction.

The color of the picture is not correctly displayed.

- Deactivate the NightShot plus function (p. 20).

The screen picture is bright, and the subject does not appear on the screen.

- Deactivate the NightShot plus function (p. 20), or cancel the BACK LIGHT function (p. 21).

Undesirable flicker occurs.

- This anomaly may occur when recording pictures under the discharge tube, such as a fluorescent lamp, sodium lamp, or mercury lamp, with [PORTRAIT] or [SPORT]. This is not a malfunction.

Black bands appear when you record a TV screen or computer screen.

- Set [STEADYSHOT] to [OFF] (p. 37).

[The lens cover might be closed. Check the cover.] appears on the screen when the lens cover is open.

- There is not enough light, or the lens is covered by your finger or other object.

Playback

You cannot play back a tape.

- Slide the POWER switch repeatedly to turn on the PLAY/EDIT lamp (p. 22).
- Rewind the tape (p. 22).

Horizontal lines appear on the picture. The displayed pictures are not clear or do not appear.

- Clean the head using the cleaning cassette (optional) (p. 62).

No sound or only a low sound is heard.

- Turn up the volume (p. 22).
- Adjust [AUDIO MIX] until the sound is heard appropriately (p. 34).
- If you are using an S VIDEO plug, make sure the red and white plugs of the A/V connecting cable are also connected (p. 26).

The sound breaks off.

- Clean the head using the cleaning cassette (optional) (p. 62).

“---” is displayed on the screen.

- The tape you are playing was recorded without setting the date and time.
- A blank section on the tape is being played.
- The data code on a tape with a scratch or noise cannot be read.

Noises appear and [P] is displayed on the screen.

- The tape was recorded in a TV color system other than that of your camcorder (NTSC). This is not a malfunction (p. 57).

4ch-12b is displayed on the screen.

- The tape you are playing was recorded on another device with a 4ch microphone (4CH MIC REC). Your camcorder is not compatible with 4ch microphone recording.

Dubbing/Editing/Connecting to other devices

Time code and other information appear on the display of the connected device.

- Set [DISP OUT] to [LCD] while connected with an A/V connecting cable (p. 41).

You cannot dub correctly using the A/V connecting cable.

- The A/V connecting cable is not connected properly. Make sure that the A/V connecting cable is connected to the input jack of another device for dubbing a picture from your camcorder (p. 42).

New sound added to a recorded tape is not heard.

- Adjust [AUDIO MIX] until the sound is heard appropriately (p. 34).

Pictures from connected devices are not displayed correctly.

- The input signal is not NTSC (p. 57).

Connecting to a computer

The computer does not recognize your camcorder.

- Install the “Picture Motion Browser” (p. 47).
- The computer may not recognize your camcorder for a few moments after you connect it. Wait for a while.
- Disconnect USB devices other than the keyboard, the mouse, and the camcorder from the Ψ (USB) jack on the computer.
- Disconnect the cable from the computer and camcorder, restart the computer, then connect them again correctly.

You cannot install the supplied software, “Picture Motion Browser,” on a Macintosh computer.

- You can install “Picture Motion Browser” only on a Windows computer.

Functions that cannot be used together

Depending on the functions, you may not be able to use them together. The following list shows examples of functions that cannot be used at the same time.

Not available	If this function is set
BACK LIGHT	[SPOT METER], [EXPOSURE]
[SPOT FOCUS]	[SCENE SEL.]
[SPOT METER]	NightShot plus
[SCENE SEL.]	NightShot plus
[EXPOSURE]	NightShot plus
[WHT BAL]	NightShot plus

Warning indicators and messages

Self-diagnosis display/Warning indicators

If indicators appear on the LCD screen or in the viewfinder, check the following. Some symptoms you can fix by yourself. If the problem persists even after you have tried a couple of times, contact your Sony dealer or local authorized Sony service facility.

C:(or E:) □□:□□ (Self-diagnosis display)

C:04:□□

- The battery pack is not an “InfoLITHIUM” battery pack (H series). Use an “InfoLITHIUM” battery pack (H series) (p. 59).
- Connect the DC plug of the AC Adaptor to the DC IN jack of your camcorder securely (p. 11).

C:21:□□

- Moisture condensation has occurred. Remove the cassette and leave your camcorder for at least 1 hour, then re-insert the cassette (p. 61).

C:22:□□

- Clean the head using a cleaning cassette (optional) (p. 62).

C:31:□□ / C:32:□□

- Symptoms that are not described above have occurred. Remove and insert the cassette, then operate your camcorder again. Do not perform this procedure if moisture condensation has occurred (p. 61).
- Remove the power source. Reconnect it and operate your camcorder again.
- Change the cassette. Press RESET (p. 68), and operate your camcorder again.

E:61:□□ / E:62:□□

- Contact your Sony dealer or local authorized Sony service facility. Inform

them of the 5-digit code, which starts from “E.”

(Battery level warning)

- The battery pack is nearly used up.
- Depending on the operating environment, or battery conditions,  may flash, even if there are approximately 5 to 10 minutes remaining.

(Moisture condensation warning)*

- Eject the cassette, remove the power source, and then leave it for about 1 hour with the cassette lid open (p. 61).

(Warning indicators pertaining to the tape)

Slow flashing:

- There is less than 5 minutes remaining on the tape.
- No cassette is inserted.*
- The write-protect tab on the cassette is set to lock (p. 58).*

Fast flashing:

- The tape has run out.*

(Eject cassette warning)*

Slow flashing:

- The write-protect tab on the cassette is set to lock (p. 58).

Fast flashing:

- Moisture condensation has occurred (p. 61).
- The self-diagnosis display code is displayed (p. 55).

* You hear a melody when the warning indicators appear on the screen (p. 31).

Warning indicators and messages (Continued)

Examples of warning messages

If messages appear on the screen, follow the instructions.

 **Moisture condensation. Eject the cassette** (p. 61)

 **Moisture condensation. Turn off for 1H.** (p. 61)

 **Reinsert the cassette.** (p. 16)

- Check if the cassette is damaged.

  **The tape is locked - check the tab.** (p. 58)

Using your camcorder abroad

Power supply

You can use your camcorder in any country/region using the AC Adaptor supplied with your camcorder within the AC 100 V to 240 V, 50/60 Hz range. Use a commercially available AC plug adaptor [a], if necessary, depending on the design of the wall outlet [b].



On TV color systems

Your camcorder is NTSC system, so its picture can only be viewed on a NTSC system TV with an AUDIO/VIDEO input jack.

System	Used in
NTSC	Bahama Islands, Bolivia, Canada, Central America, Chile, Colombia, Ecuador, Guyana, Jamaica, Japan, Korea, Mexico, Peru, Surinam, Taiwan, the Philippines, the U.S.A., Venezuela, etc.
PAL	Australia, Austria, Belgium, China, Czech Republic, Denmark, Finland, Germany, Holland, Hong Kong, Hungary, Italy, Kuwait, Malaysia, New Zealand, Norway, Poland, Portugal, Singapore, Slovak Republic, Spain, Sweden, Switzerland, Thailand, United Kingdom, etc.
PAL - M	Brazil
PAL - N	Argentina, Paraguay, Uruguay.
SECAM	Bulgaria, France, Guiana, Iran, Iraq, Monaco, Russia, Ukraine, etc.

Simple setting of the clock by time difference

You can easily set the clock to the local time abroad by entering the time difference between where you live and where you are. Select [WORLD TIME] in the **ETC** (OTHERS) menu, then set the time difference (p. 41).

Maintenance and precautions

Usable cassette tapes

You can use mini DV format cassettes only. Use a cassette with the **Mini DV** mark. Your camcorder is not compatible with the Cassette Memory function.

To prevent a blank section from being created on the tape

Go to the end of the recorded section using END SEARCH (p. 24) before you begin the next recording in the following cases:

- You have played back the tape.
- You have used EDIT SEARCH.

Copyright signal

■ When you play back

If the cassette you play back on your camcorder contains copyright signals, you cannot copy it to a tape in another video camera connected to your camcorder.

■ When you record

You cannot record software on your camcorder that contains copyright control signals for copyright protection of software. [Cannot record due to copyright protection.] appears on the LCD screen, or on the viewfinder if you try to record such software. Your camcorder does not record copyright control signals on the tape when it records.

Notes on use

■ When not using your camcorder for a long time

Remove the cassette and store it.

■ To prevent accidental erasure

Slide the write-protect tab on the cassette to set it to SAVE.



REC: The cassette can be recorded.

SAVE: The cassette cannot be recorded (write-protected).



■ When labeling the cassette

Be sure to place the label only on the locations shown in the following illustration so as not to cause a malfunction of your camcorder.

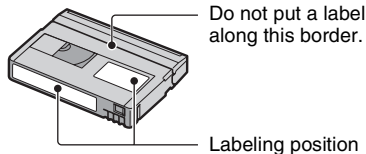

■ After using the cassette

Rewind the tape to the beginning to avoid distortion of the picture or the sound. The cassette should then be put in its case, and stored in an upright position.

■ When cleaning the gold-plated connector

Generally, clean the gold-plated connector on a cassette with a cotton-wool swab after every 10 times it has been ejected. If the gold-plated connector on the cassette is dirty or dusty, the remaining tape indicator may not show correctly.

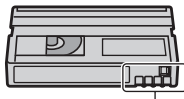

Gold-plated connector

About the “InfoLITHIUM” battery pack

This unit is compatible with an “InfoLITHIUM” battery pack (H series). Your camcorder operates only with an “InfoLITHIUM” battery pack. “InfoLITHIUM” H series battery packs have the  mark.

What is an “InfoLITHIUM” battery pack?

An “InfoLITHIUM” battery pack is a lithium-ion battery pack that has functions for communicating information related to operating conditions between your camcorder and an optional AC Adaptor/charger.

The “InfoLITHIUM” battery pack calculates the power consumption according to the operating conditions of your camcorder, and displays the remaining battery time in minutes.

To charge the battery pack

- Be sure to charge the battery pack before you start using your camcorder.
- We recommend charging the battery pack in an ambient temperature of between 10 °C to 30 °C (50 °F to 86 °F) until the CHG (charge) lamp turns off. If you charge the battery pack outside of this temperature range, you may not be able to charge it efficiently.
- When charging the battery pack while the AC Adaptor is connected to your camcorder, after charging is complete, disconnect the cable from the DC IN jack on your camcorder or remove the battery pack.

To use the battery pack effectively

- Battery pack performance decreases when the surrounding temperature is 10 °C (50 °F) or below, and the length of time you can use the battery pack becomes shorter. In that case, do one of the following to use the battery pack for a longer time.
 - Put the battery pack in a pocket to warm it up, and insert it in your camcorder right before you start taking shots.

- Use a large capacity battery pack: NP-FH70/FH100 (optional).
- Frequent use of the LCD screen or a frequent playback, fast forward or rewind operation wears out the battery pack faster. We recommend using a large capacity battery pack: NP-FH70/FH100 (optional).
- Be sure to set the POWER switch to OFF(CHG) when not recording or playing back on your camcorder. The battery pack is also consumed when your camcorder is in recording standby or playback pause.
- Have spare battery packs ready for two or three times the expected recording time, and make trial recordings before making the actual recording.
- Do not expose the battery pack to water. The battery pack is not water resistant.

About the remaining battery time indicator

- When the power goes off even though the remaining battery time indicator indicates that the battery pack has enough power to operate, charge the battery pack fully again. Remaining battery time will be indicated correctly. Note, however, that the battery indication will not be restored if it is used in high temperatures for a long time, or if left in a fully charged state, or when the battery pack is frequently used. Use the remaining battery time indication as a rough guide only.
- The  mark that indicates low battery flashes even if there are still 5 to 10 minutes of battery time remaining, depending on the operating conditions or ambient temperature.

About storage of the battery pack

- If the battery pack is not used for a long time, fully charge the battery pack and use it up on your camcorder once a year to maintain proper function. To store the battery pack, remove it from your camcorder and put it in a dry, cool place.
- To discharge the battery pack on your camcorder completely, set [A.SHUT OFF] to [NEVER] on the  (OTHERS) menu and leave your camcorder in tape recording standby until the power goes off (p. 41).

About battery life

- Battery capacity decreases over time and through repeated use. If decreased usage time between charges becomes significant, it is probably time to replace it with a new one.
- Each battery's life is governed by storage, operating and environmental conditions.

About i.LINK

The DV Interface on this unit is an i.LINK-compliant DV Interface. This section describes the i.LINK standard and its features.

What is i.LINK?

i.LINK is a digital serial interface for transferring digital video, digital audio, and other data to other i.LINK-compatible devices. You can also control other devices using the i.LINK.

i.LINK-compatible devices can be connected using an i.LINK cable. Possible applications are operations and data transactions with various digital AV devices.

When two or more i.LINK-compatible devices are daisy-chained with the unit, operation becomes possible from any device in the chain. Note that operation method may vary, or data transactions may not be possible, depending on specifications and characteristics of the connected devices.

- Normally, only one device can be connected to this unit with an i.LINK cable. When connecting this unit to an i.LINK-compatible device having two or more DV Interfaces, refer to the operating instructions of the device to be connected.
- i.LINK is a more familiar term for the IEEE 1394 data transport bus proposed by Sony, and is a trademark approved by many corporations.
- IEEE 1394 is an international standard standardized by the Institute of Electrical and Electronics Engineers.

About the i.LINK Baud rate

i.LINK's maximum baud rate varies according to the device. There are 3 types.

S100 (approx. 100Mbps*)

S200 (approx. 200Mbps)

S400 (approx. 400Mbps)

The baud rate is listed under "Specifications" in the operating instructions of each piece of equipment. It is also indicated near the i.LINK interface on some devices.

The baud rate may differ from the indicated value when the unit is connected to a device with a different maximum baud rate.

* What is Mbps?

Mbps stands for "megabits per second," or the amount of data that can be sent or received in one second. For example, a baud rate of 100 Mbps means that 100 megabits of data can be sent in one second.

To use i.LINK functions on this unit

For details on how to dub when this unit is connected to other video devices having a DV Interface, see page 42, 44.

This unit can also be connected to other i.LINK (DV Interface) compatible devices made by Sony (e.g. a VAIO series personal computer) as well as to video devices. Some i.LINK compatible video devices, such as Digital Televisions, DVD, MICROMV or HDV recorders/players are not compatible with DV devices. Before connecting to other devices, be sure to confirm whether the device is compatible with a DV device or not. For details on precautions and compatible application software, refer also to the operating instructions for the device to be connected.

⚠ Notes

- When connecting your camcorder to another i.LINK-compatible device, be sure to turn off the power of the device and disconnect the AC Adaptor from the wall outlet before connecting or disconnecting the i.LINK cable.

About the required i.LINK cable

Use the Sony i.LINK 4-pin-to-4-pin cable (during DV dubbing).

On using your camcorder

On use and care



- Do not use or store the camcorder and accessories in the following locations.
 - Anywhere extremely hot, cold or humid. Never leave them exposed to temperatures above 60 °C (140 °F), such as under direct sunlight, near heaters or in a car parked in the sun. They may malfunction or become deformed.
 - Near strong magnetic fields or mechanical vibration. The camcorder may malfunction.
 - Near strong radio waves or radiation. The camcorder may not be able to record properly.
 - Near AM receivers and video equipment. Noise may occur.
 - On a sandy beach or anywhere dusty. If sand or dust gets in your camcorder, it may malfunction. Sometimes this malfunction cannot be repaired.
 - Near windows or outdoors, where the LCD screen, the viewfinder, or the lens may be exposed to direct sunlight. This damages the inside of the viewfinder or the LCD screen.
- Operate your camcorder on DC 6.8 V/7.2 V (battery pack) or DC 8.4 V (AC Adaptor).
- For DC or AC operation, use the accessories recommended in these operating instructions.
- Do not let your camcorder get wet, for example, from rain or sea water. If your camcorder gets wet, it may malfunction. Sometimes this malfunction cannot be repaired.
- If any solid object or liquid gets inside the casing, unplug your camcorder and have it checked by a Sony dealer before operating it any further.
- Avoid rough handling, disassembling, modifying, physical shock, or impact such as hammering, dropping or stepping on the product. Be particularly careful of the lens.
- Keep the POWER switch setting to OFF(CHG) when you are not using your camcorder.
- Do not wrap your camcorder with a towel, for example, and operate it. Doing so might cause heat to build up inside.

- When disconnecting the power cord, pull it by the plug and not the cord.
- Do not damage the power cord such as by placing anything heavy on it.
- Keep metal contacts clean.
- If the battery electrolytic liquid has leaked,
 - consult your local authorized Sony service facility.
 - wash off any liquid that may have contacted your skin
 - if any liquid gets in your eyes, wash with plenty of water and consult a doctor.

■ When not using your camcorder for a long time



- Periodically turn on the camcorder and play a cassette for about 3 minutes.
- Use up the battery pack completely before storing it.

Moisture condensation

If your camcorder is brought directly from a cold place to a warm place, moisture may condense inside your camcorder, on the surface of the tape, or on the lens. In this state, the tape may stick to the head drum and be damaged or your camcorder may not operate correctly. If there is moisture inside your camcorder, [] Moisture condensation. Eject the cassette] or [] Moisture condensation. Turn off for 1H.] appears. The indicator will not appear when the moisture condenses on the lens.

■ If moisture condensation has occurred

None of the functions except cassette ejection will work. Eject the cassette, turn off your camcorder, and leave it for about one hour with the cassette lid open. Your camcorder can be used again when both of the following conditions are met:

- The warning message does not appear when the power is turned on.
- Neither [] or [] flash when a cassette is inserted and video operation buttons are touched.

If moisture starts to condense, your camcorder sometimes cannot detect condensation. If this happens, the cassette is sometimes not ejected for 10 seconds after the cassette lid is opened. This is not a

Maintenance and precautions (Continued)

malfunction. Do not close the cassette lid until the cassette is ejected.

■ Note on moisture condensation

Moisture may condense when you bring your camcorder from a cold place into a warm place (or vice versa) or when you use your camcorder in a humid place as shown below.

- When you bring your camcorder from a ski slope into a place warmed up by a heating device.
- When you bring your camcorder from an air conditioned car or room into a hot place outside.
- When you use your camcorder after a squall or a shower.
- When you use your camcorder in a hot and humid place.

■ How to avoid moisture condensation

When you bring your camcorder from a cold place into a warm place, put your camcorder in a plastic bag and seal it tightly. Remove the bag when the air temperature inside the plastic bag has reached the surrounding temperature (after about one hour).

Video head

- If the video heads are dirty, video or sound distortion may be apparent.
- If the following problem occurs, clean the video heads for 10 seconds with the Sony DVM-12CLD cleaning cassette (optional).
 - Mosaic-pattern noise appears on the playback picture or the screen is displayed in blue.



- Playback pictures do not move.
- Playback pictures do not appear or the sound breaks off.
- [⊗] Dirty video head. Use a cleaning cassette. appears on the screen during recording/playback.
- The video heads will wear after long use. If you cannot obtain a clear image even after using a cleaning cassette (optional), it might be because the video heads are worn. Please contact your

Sony dealer or local authorized Sony service facility to have the video heads replaced.

LCD screen

- Do not exert excessive pressure on the LCD screen, as it may cause damage.
- If your camcorder is used in a cold place, a residual image may appear on the LCD screen. This is not a malfunction.
- While using your camcorder, the back of the LCD screen may heat up. This is not a malfunction.

■ To clean the LCD screen

If fingerprints or dust make the LCD screen dirty, it is recommended you use a soft cloth to clean it. When you use the LCD Cleaning Kit (optional), do not apply the cleaning liquid directly to the LCD screen. Use cleaning paper moistened with the liquid.

■ On adjustment of the touch panel (CALIBRATION)

The buttons on the touch panel may not work correctly. If this happens, follow the procedure below. It is recommended you connect your camcorder to the wall outlet using the supplied AC Adaptor during the operation.

- ① Turn off the power, then slide the POWER switch repeatedly to turn on the PLAY/EDIT lamp while pressing DISP/BATT INFO on your camcorder, and keep pressing down DISP/BATT INFO for about 5 seconds.
- ② Touch the “x” displayed on the screen with the corner of the “Memory Stick” or the like.

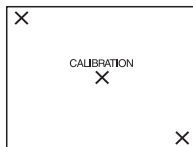

The position of the “x” changes. If you did not press the right spot, start from step ② again.

- You cannot calibrate the LCD screen if it is rotated.

On handling the casing

- If the casing is soiled, clean the camcorder body with a soft cloth lightly moistened with water, and then wipe the casing with a dry soft cloth.
- Avoid the following to avoid damage to the finish.
 - Using chemicals such as thinner, benzene, alcohol, chemical cloths, repellent, insecticide and sunscreen.
 - Handling with above substances on your hands.
 - Leaving the casing in contact with rubber or vinyl objects for a long period of time.

About care and storage of the lens

- Wipe the surface of the lens clean with a soft cloth in the following instances:
 - When there are fingerprints on the lens surface.
 - In hot or humid locations
 - When the lens is exposed to salty air such as at the seaside.
- Store in a well-ventilated location subject to little dirt or dust.
- To prevent mold, periodically clean the lens as described above. It is recommended that you operate your camcorder about once a month to keep it in optimum state for a long time.

To remove dust from inside the viewfinder

- ① Pull out the viewfinder.
- ② While pushing in the tab on the side with a fine-tipped implement such as a ball point pen, pull the eyecup block in the direction of the arrow to remove.

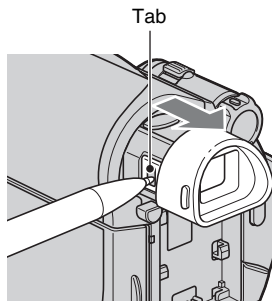

- ③ Remove dust from the eyecup block with a camera blower, etc.

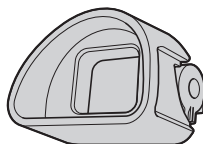

- ④ Press the viewfinder onto the body of the camcorder.
- ⑤ Remove dust from the inside area where the eyecup block was attached with a camera blower, etc.

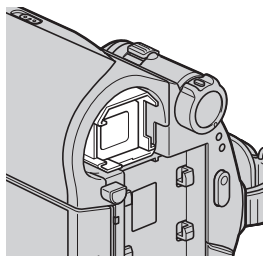

Maintenance and precautions (Continued)

- ⑥ Attach the eyecup block to the viewfinder, pushing it straight on until it clicks.

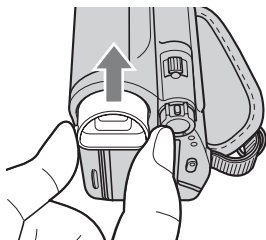

⚡ Notes

- The eyecup block is a precision part. Do not disassemble it further.
- Do not touch the lens of the eyecup block.

On charging the pre-installed rechargeable battery

Your camcorder has a pre-installed rechargeable battery to retain the date, time, and other settings even when the POWER switch is set to OFF(CHG). The pre-installed rechargeable battery is always charged while your camcorder is connected to the wall outlet via the AC Adaptor or while the battery pack is attached. The rechargeable battery will be fully discharged in about **3 months** if you do not use your camcorder at all without the AC Adaptor connected or the battery pack attached. Use your camcorder after charging the pre-installed rechargeable battery.

However, even if the pre-installed rechargeable battery is not charged, the camcorder operation will not be affected as long as you are not recording the date.

■ Procedures

Connect your camcorder to a wall outlet using the supplied AC Adaptor, and leave it with the POWER switch set to OFF(CHG) for more than 24 hours.

Specifications

System

Video recording system

2 rotary heads, Helical scanning system

Audio recording system

Rotary heads, PCM system

Quantization: 12 bits (Fs 32 kHz, stereo 1, stereo 2), 16 bits (Fs 48 kHz, stereo)

Video signal

NTSC color, EIA standards

Usable cassette

Mini DV cassette with the ^{Mini}DV mark printed

Tape speed

SP: Approx. 18.81 mm/s

LP: Approx. 12.56 mm/s

Recording/playback time

SP: 60 min (using a DVM60 cassette)

LP: 90 min (using a DVM60 cassette)

Fast forward/rewind time

Approx. 2 min 40 s (using a DVM60 cassette and rechargeable battery pack)

Approx. 1 min 45 s (using a DVM60 cassette and AC Adaptor)

Viewfinder

Electric viewfinder (color)

Image device

3.0 mm (1/6 type) CCD (Charge Coupled Device)

Gross: Approx. 680 000 pixels

Effective (movie): Approx. 340 000 pixels

Lens

Carl Zeiss Vario-Tessar

40 × (Optical), 2 000 × (Digital)

Focal length

f=1.9 ~ 76 mm (3/32 ~ 3 in.)

When converted to a 35 mm still camera

In CAMERA: 36 ~ 1 440 mm (1 7/16 ~ 56 3/4 in.)

F1.8 ~ 4.1

Filter diameter: 30 mm (1 3/16 in.)

Color temperature

[AUTO], [ONE PUSH], [INDOOR]
(3 200 K), [OUTDOOR] (5 800 K)

Minimum illumination

5 lx (lux) (F 1.8)

0 lx (lux) (during NightShot plus
function)

Input/Output connectors

Audio/Video output

10-pin connector

Video signal: 1 Vp-p, 75 Ω (ohms)

Luminance signal: 1 Vp-p, 75 Ω (ohms)

Chrominance signal: 0.286 Vp-p, 75 Ω
(ohms)

Audio signal: 327 mV (at load
impedance 47 k Ω (kilohms)), Output
impedance with less than 2.2 k Ω
(kilohms)

USB jack

mini-B

DV input/output

i.LINK Interface (IEEE1394, 4-pin
connector S100)

LCD screen

Picture

6.2 cm (2.5 type)

Total dot number

123 200 (560 \times 220)

General

Power requirements

DC 6.8 V/7.2 V (battery pack)

DC 8.4 V (AC Adaptor)

Average power consumption

During camera recording using the
viewfinder 1.8 W

During camera recording using the
LCD 2.1 W

Operating temperature

0 $^{\circ}$ C to 40 $^{\circ}$ C (32 $^{\circ}$ F to 104 $^{\circ}$ F)

Storage temperature

-20 $^{\circ}$ C to + 60 $^{\circ}$ C (-4 $^{\circ}$ F to + 140 $^{\circ}$ F)

Dimensions (approx.)

63 \times 85 \times 114 mm

(2 1/2 \times 3 3/8 \times 4 1/2 in.) (w/h/d)

including the projecting parts

63 \times 85 \times 115 mm

(2 1/2 \times 3 3/8 \times 4 5/8 in.) (w/h/d)

including the projecting parts with

supplied battery pack NP-FH30
attached

Mass (approx.)

390 g (13 oz) main unit only

450 g (15 oz) including the NP-FH30
rechargeable battery pack and DVM60
cassette.

Supplied accessories

See page 10.

AC Adaptor AC-L200/L200B

Power requirements

AC 100 - 240 V, 50/60 Hz

Current consumption

0.35 - 0.18 A

Power consumption

18 W

Output voltage

DC 8.4 V*

Operating temperature

0 $^{\circ}$ C to 40 $^{\circ}$ C (32 $^{\circ}$ F to 104 $^{\circ}$ F)

Storage temperature

-20 $^{\circ}$ C to + 60 $^{\circ}$ C (-4 $^{\circ}$ F to + 140 $^{\circ}$ F)

Dimensions (approx.)

48 \times 29 \times 81 mm (1 15/16 \times 1 3/16 \times

3 1/4 in.) (w/h/d) excluding the

projecting parts

Mass (approx.)

170 g (6.0 oz) excluding the power cord

* See the label on the AC Adaptor for
other specifications.

Specifications (Continued)

Rechargeable battery pack (NP-FH30)

Maximum output voltage

DC 8.4 V

Output voltage

DC 7.2 V

Capacity

3.6 Wh (500 mAh)

Dimensions (approx.)

31.8 × 18.5 × 45.0 mm

(1 5/16 × 3/4 × 1 13/16 in) (w/h/d)

Mass (approx.)

40 g (1.5 oz)

Operating temperature



0 °C to 40 °C (32 °F to 104 °F)

Type

Lithium ion

Design and specifications are subject to change without notice.

On trademarks

- “Handycam” and **HANDYCAM** are registered trademarks of Sony Corporation.
- “InfoLITHIUM” is a trademark of Sony Corporation.
- i.LINK and  are trademarks of Sony Corporation.
- Mini  ^{Digital Video} _{Cassette} is a trademark.
- Microsoft, Windows, and Windows Media are trademarks or registered trademarks of U.S. Microsoft Corporation in the U.S. and other countries.
- Macintosh is a registered trademark of Apple Computer, Inc in the U.S. and other countries.
- Pentium is a trademark or registered trademark of Intel Corporation.
- Adobe and Adobe Reader are either registered trademarks or trademarks of Adobe Systems Incorporated in the United States and/or other countries.

All other product names mentioned herein may be the trademarks or registered trademarks of their respective companies. Furthermore, TM and “®” are not mentioned in each case in this manual.

Identifying parts and controls

The numbers in () are reference pages.

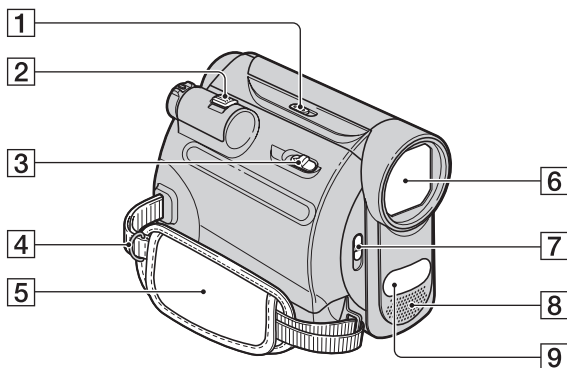

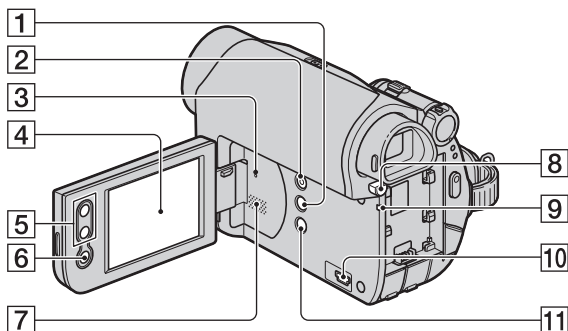

- 1** NIGHTSHOT PLUS switch (20)
- 2** Power zoom lever (20)
- 3**  OPEN/EJECT lever (16)
- 4** Hooks for a shoulder belt
Attach a shoulder belt (optional).
- 5** Grip belt (15)
- 6** Lens (Carl Zeiss Lens) (7)
- 7** LENS COVER switch (15)
- 8** Internal stereo microphone (33)
- 9** Infrared port (20)

Identifying parts and controls (Continued)

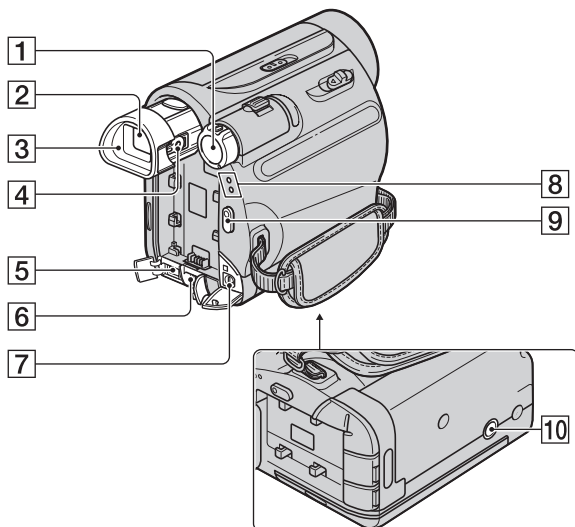

- 1** DISP/BATT INFO button (12, 15)
- 2** EASY button (17)
- 3** RESET button
Initializes all the settings, including the setting of the date and time.
- 4** LCD screen/touch panel (15, 70)
- 5** Zoom buttons (20)
- 6** REC START/STOP button (17, 19)
- 7** Speaker
Playback sounds comes out from the speaker. For how to adjust the volume, see page 22.
- 8** BATT (battery release) PUSH button (12)
- 9** CHG (charge) lamp (11)
- 10** Ψ (USB) jack
- 11** BACK LIGHT button (21)



- 1** POWER switch (14)
- 2** Viewfinder (15)
- 3** Eyecup (63)
- 4** Viewfinder lens adjustment lever (15)
- 5**  DV interface (42, 44)
- 6** DC IN jack (11)
- 7** A/V OUT jack (26, 42)
- 8** CAMERA, PLAY/EDIT lamp (14)
- 9** REC START/STOP button (17, 19)
- 10** Tripod receptacle
Attach the tripod (optional: the length of the screw must be less than 5.5 mm (7/32 in.)) to the tripod receptacle using a tripod screw.

Indicators displayed during recording/playback

Recording

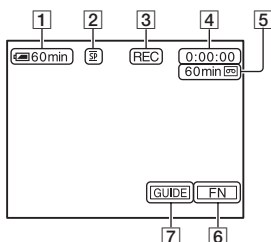

- 1 Remaining battery (approx.)
- 2 Recording mode (SP or LP) (40)
- 3 Recording status ([STBY] (standby) or [REC] (recording))
- 4 Recording: Tape counter (hour: minute: second)
Playback: Time code (hour: minute: second: frame)
- 5 Recording capacity of the tape (approx.) (40)
- 6 Function button (27)
- 7 Guide button (23)

Viewing

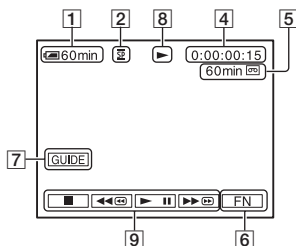

- 8 Tape transport indicator
- 9 Video operation buttons (22)

Indicators when you made changes

You can use [DISP GUIDE] (p. 71) to check the function of each indicator that appears on the LCD screen.

Notes

- Some of the indicators may not appear when you use [DISP GUIDE].

Upper left

Upper right

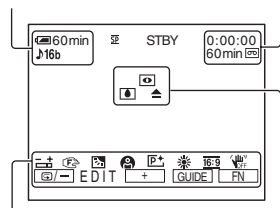

Bottom

Center

Upper left

Indicator	Meaning
16b	AUDIO MODE (40)

Upper right

Indicator	Meaning
DVIN	DV input (44)

Center

Indicator	Meaning
NightShot plus	NightShot plus (20)
Warning	Warning (55)

Bottom

Indicator	Meaning
Flexible spot meter	Flexible spot meter (29)/ Manual exposure (30)
Manual focus	Manual focus (28)
Backlight	Backlight (21)

Indicator	Meaning
	SCENE SEL. (29)
	Picture effect (36)
	White balance (31)
	Wide select (37)
	SteadyShot off (37)
	EDITSEARCH (37)

Tips

- You can also operate by touching → [DISP GUIDE].

Data code during recording

The date/time during recording and the camera setting data will be recorded automatically. They do not appear on the screen during recording, but you can check them as [DATA CODE] during playback (p. 32).

Checking the screen indicators (Display guide)

You can easily check the meaning of each indicator that appears on the LCD screen.

- Touch [GUIDE] → [DISP GUIDE].

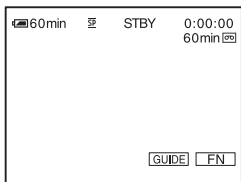

- Touch the area including the indicator that you want to check.

The meanings of the indicators in the area are listed on the screen. If you cannot find the indicator you want to check, touch [PAGE ↓]/[PAGE ↑] to toggle.

To finish the operation, touch [END].

Index

Numeric

12BIT.....	40
16BIT.....	40
16:9 WIDE.....	37
4:3.....	37

A

A DUB CTRL (Audio dubbing).....	33
AC Adaptor.....	11
AUDIO MIX.....	34
AUDIO MODE.....	40
A.SHUT OFF (Auto shut off).....	41
A/V connecting cable.....	26, 42

B

BACK LIGHT.....	21, 52
Battery.....	11, 59
BEACH.....	30
BEEP.....	31
BLACK.....	31
B&W.....	36

C

CALIBRATION.....	62
CAM DATA.....	32
CAMERA SET menu.....	37
Cassette.....	16, 58
CD-ROM.....	46
Charging time.....	12
Cleaning cassette.....	62
CLOCK SET.....	14
Computer.....	46

D

D ZOOM (Digital zoom).....	37
DATA CODE.....	32, 71
DATE/TIME.....	14, 32, 71
DEMO MODE.....	40

DISP GUIDE (Display guide).....	71
DISP OUT (Display output).....	41
Display indicators.....	70
Dubbing.....	42

E

Easy Handycam.....	17, 27
EDITSEARCH.....	24, 37
END SCH (END SEARCH).....	24, 52
EXPOSURE.....	30

F

FADER.....	30
First Step Guide.....	46, 49
Flexible spot meter.....	29
FOCUS.....	28, 52
Frame-by-frame Playback....	33

G

Getting started.....	10
----------------------	----

I

INDOOR.....	31
"InfoLITHIUM" battery pack	59
Install.....	47
i.LINK.....	60
i.LINK cable.....	42, 44

L

LANDSCAPE.....	29
LANGUAGE.....	40
LCD.....	41
LCD BRT (LCD bright).....	32
LCD B.L. (LCD back light).....	39
LCD COLOR.....	39
LCD screen.....	15
LCD/VF SET menu.....	39

LETTER BOX.....	39
LP (Long Play).....	40

M

MANUAL SET menu.....	36
Menu.....	27, 35
Mirror mode.....	21
Moisture condensation.....	61
MONOTONE.....	31
MOSAIC.....	36
MOSC. FADER.....	31

N

NEG.ART.....	36
NightShot plus.....	20
NTSC.....	53, 57
N.S.LIGHT (NightShot Light).....	38

O

ONE PUSH.....	31
Operation button.....	27
OTHERS menu.....	41
OUTDOOR.....	31

P

P EFFECT (Picture effect)....	36
PAL.....	57
PASTEL.....	36
Picture Motion Browser.....	46
Playback.....	18, 22, 53
Playing time.....	13
PORTRAIT (Soft portrait)....	29

R

REC CTRL (Recording control).....	44
REC MODE (Recording mode).....	40
Rec review.....	24
Recording.....	17, 19, 52

Recording time	13
REMAIN	40
Reversal Playback.....	32

S

S VIDEO cable	26, 42
SCENE SEL.	29
Searching for the starting point	24
SEPIA	36
SETUP MENU menu	40
SNOW	30
SOLARIZE	36
SP (Standard Play).....	40
Specifications.....	64
SPORT (Sports lesson).....	30
SPOT FOCUS.....	28
SPOT METER	See Flexible spot meter
SPOTLIGHT	29
SQUEEZE	39
STEADYSHOT	37, 52
SUNRSSUNST (Sunrise & Sunset).....	29

T

Tape counter	70
TAPE SET menu	40
Time code	70
Tripod	69
TV	26
TV color systems	57
TWILIGHT.....	29

U

USAGE GUIDE.....	23
USB STREAM	40
Using abroad.....	57

V

V SPD PLAY (Various speed playback)	32
---	----

VCR SET menu	38
VF B.L. (Viewfinder back light)	39
VOL (Volume).....	22
V-OUT/LCD	41

W

Warning indicators	55
Warning messages.....	56
WHITE.....	30
WHT BAL (White balance)	31
WIDE DISP (Wide display)	39
WIDE SEL (Wide select).....	37
WORLD TIME	41
Write-protect tab	58

Z

Zoom	20
------------	----

Paso 1: Comprobación de los elementos suministrados

Asegúrese de que su videocámara contiene los siguientes elementos.

El número entre paréntesis indica la cantidad del elemento.

Adaptador de alimentación de ca (1)

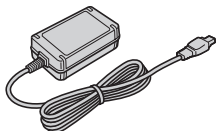

Cable de alimentación (1)

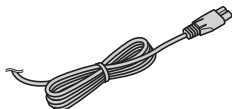

Cable de conexión A/V (1)



Batería recargable NP-FH30 (1)

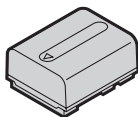

CD-ROM "Handycam Application Software" (1)

Guía de operaciones (Este manual) (1)

Paso 2: Carga de la batería

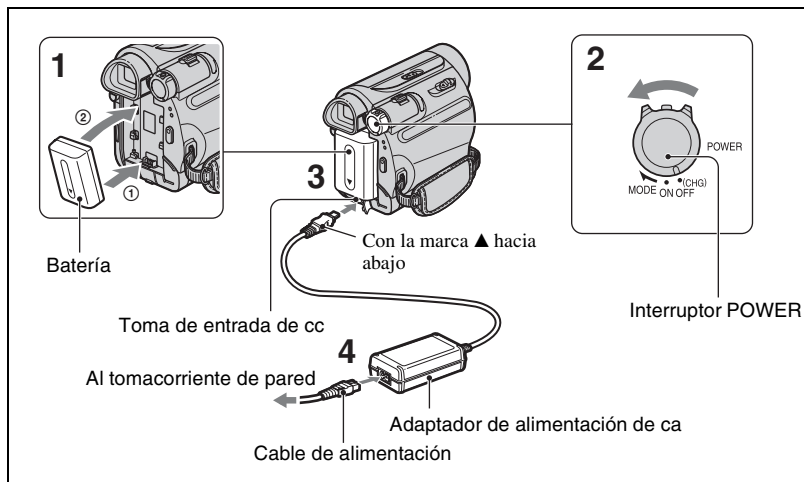

Para cargar la batería “InfoLITHIUM” (serie H), conéctela a la videocámara.

Notas

- No puede conectar ninguna batería “InfoLITHIUM” que no sea de la serie H a la videocámara.

1 Alinee los terminales de la batería y de su videocámara ①, luego coloque la batería y cárcela en su lugar ②.

2 Deslice el interruptor POWER en el sentido de la flecha hasta la posición OFF(CHG) (Ajuste predeterminado).

3 Conecte el adaptador de alimentación de ca a la toma de entrada de cc de la videocámara.

4 Conecte el cable de alimentación al adaptador de alimentación de ca y al tomacorriente de pared.

El indicador CHG (carga)

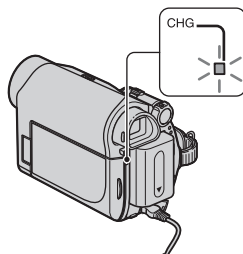

El indicador CHG (carga) se enciende y se inicia el proceso de carga.

Paso 2: Carga de la batería (Continuación)

- 5** El indicador CHG (carga) se apaga cuando la batería está completamente cargada. **Desconecte el adaptador de alimentación de ca de la toma de entrada de cc**

Desconecte el adaptador de alimentación de ca de la toma de entrada de cc sujetando a la vez la videocámara y la clavija de cc

Para utilizar una fuente de alimentación externa

Puede utilizar la cámara mediante la alimentación del tomacorriente de pared realizando las mismas conexiones que cuando carga la batería. La batería no perderá la carga en este caso.

Para retirar la batería

- 1 Apague la alimentación y presione PUSH.
- 2 Extraiga la batería en el sentido de la flecha.

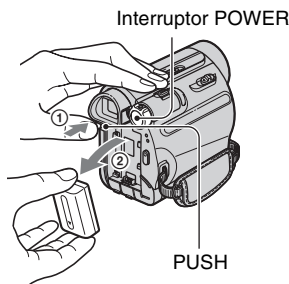

Cuando guarde la batería

Descargue completamente la batería antes de guardarla durante un período prolongado.

Para comprobar la carga restante de la batería (Información sobre la batería)

Ajuste el interruptor POWER en OFF(CHG) y, a continuación, presione DISP/BATT INFO.

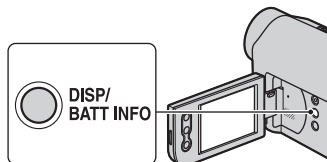

Después de cierto tiempo, el tiempo disponible para grabación y la información sobre la batería aparecen durante aproximadamente 7 s (segundo). Puede ver la información sobre la batería durante 20 s (segundo) presionando nuevamente DISP/BATT INFO mientras se visualiza la información.

Batería restante (aprox.)

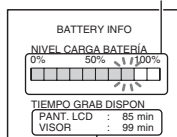

Capacidad de grabación (aprox.)

Puede comprobar la carga restante de la batería en la pantalla LCD.

Indicador	Estado
	Suficiente energía restante
	Batería baja, la grabación/reproducción se detendrá pronto.
	Sustituya la batería por una completamente cargada, o cargue la batería.

Tiempo de carga

Tiempo aproximado (min) necesario para cargar totalmente una batería descargada por completo.

Batería	Tiempo de carga
NP-FH30 (suministrado)	115
NP-FH50	135
NP-FH70	170
NP-FH100	390

Tiempo de grabación

Tiempo aproximado (min) disponible cuando utiliza una batería completamente cargada.

Batería	Tiempo de grabación continua	Tiempo de grabación normal*
NP-FH30 (suministrado)	95 110	45 55
NP-FH50	155 180	75 90
NP-FH70	330 395	165 195
NP-FH100	760 890	380 445

* El tiempo de grabación normal muestra la hora cuando se repite la operación de inicio/detención de la grabación, al conectar y desconectar la alimentación y al usar la función de zoom.

Notas

- Todo el tiempo calculado en las siguientes condiciones:
Parte superior: Grabación con pantalla LCD.
Parte inferior: Grabación con el visor mientras el panel LCD se encuentra cerrado.

Tiempo de reproducción

Tiempo aproximado (min) disponible cuando utiliza una batería completamente cargada.

Batería	Panel LCD abierto	Panel LCD cerrado
NP-FH30 (suministrado)	105	135
NP-FH50	170	220
NP-FH70	370	465
NP-FH100	845	1 065

Acerca de la batería

- Antes de cambiar la batería, deslice el interruptor POWER a la posición OFF(CHG).
- El indicador CHG (carga) parpadeará durante la carga o la información de la batería no se mostrará correctamente en las siguientes condiciones.
 - La batería no está correctamente conectada.
 - La batería está dañada.
 - La batería está agotada (sólo para la información de la batería).
- Cuando el adaptador de alimentación de ca esté conectado a la toma de entrada de cc de la videocámara, la batería no suministrará alimentación, incluso si el cable de alimentación está desconectado del tomacorriente de pared.

Acerca del tiempo de carga/grabación/reproducción

- Tiempo calculado con la videocámara a 25 °C (Se recomienda de 10 a 30 °C)
- El tiempo de grabación y de reproducción será más corto cuando use la videocámara a bajas temperaturas.
- El tiempo de grabación y de reproducción será más corto en función de las condiciones de uso de la videocámara.

Acerca del adaptador de alimentación de ca

- Si utiliza el adaptador de alimentación de ca conéctelo a un tomacorriente de pared cercano. Si se produce alguna falla de funcionamiento al utilizar la videocámara, desconecte el adaptador de alimentación de ca del tomacorriente de inmediato.

Paso 2: Carga de la batería (Continuación)

- No utilice el adaptador de alimentación de ca colocado en un espacio angosto, tal como entre una pared y los muebles.
- Evite la formación de cortocircuitos en la clavija de cc del adaptador de alimentación de ca o en el terminal de la batería con objetos metálicos. Esto podría provocar una falla de funcionamiento.
- Aunque la videocámara esté apagada, seguirá recibiendo alimentación de ca (corriente doméstica) mientras esté conectada a la toma de pared mediante el adaptador de alimentación de ca

Paso 3: Encendido y ajuste de la fecha y la hora

Ajuste la fecha y la hora cuando use la videocámara por primera vez. De lo contrario, la pantalla [AJ. RELOJ] aparecerá cada vez que encienda la videocámara o cambie la posición del interruptor POWER.

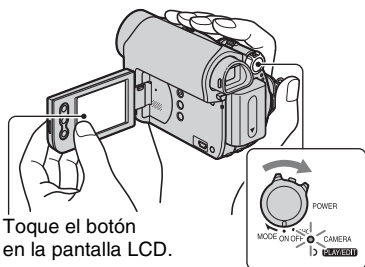

Toque el botón en la pantalla LCD.

Interruptor POWER

- 1** Mientras presiona el botón verde, deslice el interruptor POWER en el sentido de la flecha para que se encienda el indicador correspondiente.

CAMERA: Para grabar en una cinta.

PLAY/EDIT: Para reproducir o editar imágenes.

Aparecerá la pantalla [AJ. RELOJ].

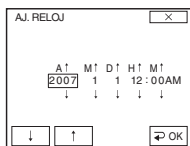

- 2** Ajuste [A] (año) con  / , luego toque .

Puede seleccionar cualquier año hasta el año 2079.



3 Ajuste [M] (mes), luego toque y repita el procedimiento para [D] (día), [H] (hora) y [M] (minuto).

Ajuste la medianoche a las 12:00 AM.

Ajuste el mediodía a las 12:00 PM.

El reloj se pone en funcionamiento.

Cambio de los ajustes de idioma

Puede cambiar las indicaciones en pantalla para mostrar mensajes en un idioma en particular. Toque  → [MENU] →  (AJUS. MENÚ) →  [LANGUAGE], y luego seleccione el idioma deseado.

Para apagar la videocámara

Deslice el interruptor POWER hasta la posición OFF(CHG).

Para restablecer la fecha y la hora

Para ajustar la fecha y la hora deseadas, toque  → [PÁG.2] → [AJ. RELOJ].

Notas

- Si no usa la videocámara durante **aproximadamente 3 meses**, la batería recargable incorporada se descarga y es posible que los ajustes de la fecha y la hora se borren de la memoria. En este caso, cargue la batería recargable y ajuste la fecha y la hora nuevamente.
- Al momento de la compra, la alimentación se ajusta para desconectarse automáticamente si no se opera la videocámara durante unos 5 min (minuto) para ahorrar energía de la batería ([APAG. AUTO]).

Sugerencias

- La fecha y hora no aparecen durante la grabación, pero se graban automáticamente en la cinta y pueden visualizarse durante la reproducción ([CÓD. DATOS] (Durante el funcionamiento de Easy Handycam, sólo puede ajustar [FECHA HORA])).
- Si los botones del panel sensible al tacto no funcionan correctamente, ajuste el panel sensible al tacto (CALIBRACIÓN).

Paso 4: Ajustes antes de grabar

Apertura de la tapa del objetivo

Deslice el interruptor LENS COVER a OPEN.



Después de grabar, ajuste el interruptor LENS COVER a CLOSE para cerrar la tapa del objetivo.

El panel LCD

Abra el panel LCD a 90 grados con respecto a la videocámara (1), luego gírelo hacia el mejor ángulo para grabar o reproducir (2).

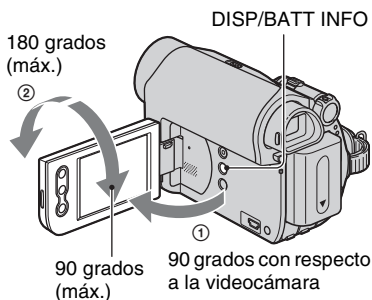

Notas

- No presione los botones en el marco del panel LCD por error al abrirlo o ajustarlo.

Sugerencias

- Si gira el panel LCD 180 grados hacia el lado del objetivo, podrá cerrarlo con la pantalla LCD hacia afuera. Esto resulta conveniente durante operaciones de reproducción.
- Consulte [BRIL LCD] para ajustar el brillo de la pantalla LCD.
- Presione DISP/BATT INFO para activar o desactivar los indicadores de pantalla (como la información sobre la batería).

El visor

Puede ver imágenes utilizando el visor para evitar el desgaste de la batería o cuando la imagen en la pantalla LCD es mala.

Visor

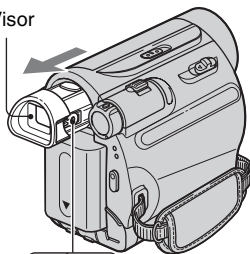

Palanca de ajuste del objetivo del visor
Muévela hasta que la imagen se aclare.

Sugerencias

- Puede ajustar el brillo de fondo del visor seleccionando (AJ LCD/VIS) - [LUZ F. VIS].

La correa de sujeción

Ajuste la correa de sujeción y sostenga la cámara correctamente.

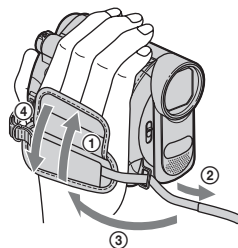

Paso 5: Inserción de un videocasete

Solamente puede utilizar videocasetes mini DV^{Mini DV}.

- 1** Deslice y sostenga la palanca **OPEN/EJECT** en el sentido de la flecha y abra la tapa.

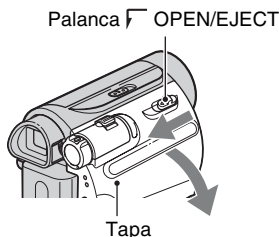

El compartimento del videocasete sale automáticamente y se abre.

- 2** Inserte un videocasete con la cara de la ventanilla hacia afuera y, a continuación, presione **PUSH**.

Presione ligeramente el centro de la parte posterior del videocasete.

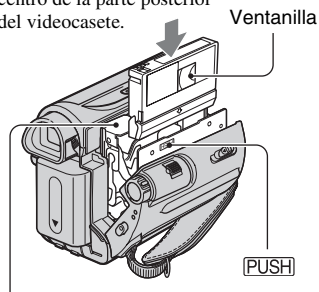

Compartimento del videocasete

El compartimento del videocasete se desliza automáticamente hacia adentro.

Notas

- No fuerce el compartimento del videocasete presionando la parte con la marca **DO NOT PUSH** mientras se desliza hacia adentro. Podría provocar una falla de funcionamiento.

- 3** Cierre la tapa.

Para expulsar el videocasete

Abra la tapa realizando el mismo procedimiento como se describe en el paso 1 y extraiga el videocasete.

Sugerencias

- El tiempo disponible para grabación varía en función del [MOD GRB].

Grabación

Abra la tapa del objetivo.

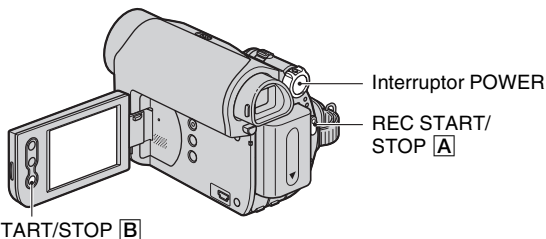
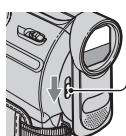

- 1 **Deslice el interruptor POWER varias veces en el sentido de la flecha para que se encienda el indicador CAMERA.**

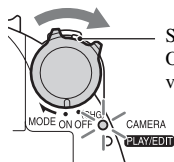

Si el interruptor POWER está en la posición OFF(CHG), deslícelo mientras presiona el botón verde.

- 2 **Presione REC START/STOP [A] (o [B]).**



Para detener la grabación, presione REC START/STOP nuevamente.

Reproducción

1

Deslice el interruptor POWER en el sentido de la flecha varias veces para encender el indicador PLAY/EDIT.

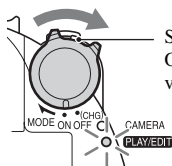

Si el interruptor POWER está en la posición OFF(CHG), deslícelo mientras presiona el botón verde.

2

Inicie la reproducción.

Toque para rebobinar la cinta al punto deseado y luego presione para iniciar la reproducción.

Reproducir/Pausa* se alterna cada vez que toca el botón

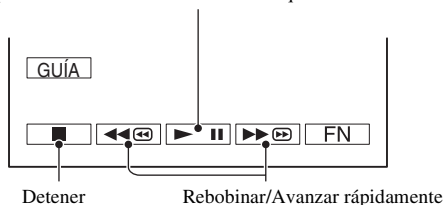

* La reproducción se detiene automáticamente si se acciona la pausa durante más de 3 min (minuto).

Para ajustar el volumen

Toque → [PÁG.1] → [VOL], luego / para ajustar el volumen.

Para buscar una escena durante la reproducción

Mantenga presionado / durante la reproducción (Búsqueda de imágenes), o / durante el avance rápido o rebobinado de la cinta (Exploración con salto).

Sugerencias

- Puede reproducir en diversos modos ([REP VEL V]).

Additional information on this product and answers to frequently asked questions can be found at our Customer Support Website.

<http://www.sony.net/>



Printed on 70% or more recycled paper using VOC (Volatile Organic Compound)-free vegetable oil based ink.

Printed in Japan



2319523110