



# Wide Screen Projection TV

Operating Instructions

© 2002 Sony Corporation

## WARNING

To reduce the risk of fire or shock hazard, do not expose the projection TV to rain or moisture.



This symbol is intended to alert the user to the presence of uninsulated "dangerous voltage" within the product's enclosure that may be of sufficient magnitude to constitute a risk of electric shock to persons.



This symbol is intended to alert the user to the presence of important operating and maintenance (servicing) instructions in the literature accompanying the appliance.

## CAUTION

To prevent electric shock, do not use this polarized AC plug with an extension cord, receptacle or other outlet unless the blades can be fully inserted to prevent blade exposure.

## CAUTION

**When using TV games, computers, and similar products with your projection TV, or viewing a TV station whose logo always stays on the screen, keep the brightness and contrast functions at low settings. If a fixed (non-moving) pattern such as a station logo is left on the screen for long periods of time, especially at a high brightness or contrast setting, the image can be permanently imprinted onto the screen. These types of imprints are not covered by your warranty.**

## Note on Caption Vision

This television receiver provides display of television closed captioning in accordance with §15.119 of the FCC rules.

## Note on Convergence Adjustment

Before you use your projection TV, make sure to adjust convergence. For details, see "Adjusting the Convergence Automatically (Flash Focus)" on page 44.

## Note to CATV System Installer

This reminder is provided to call the CATV system installer's attention to Article 820-40 of the National Electrical Code (NEC) that provides guidelines for proper grounding and, in particular, specifies that the cable ground shall be connected to the grounding system of the building, as close to the point of cable entry as practical.

Use of this television receiver for other than private viewing of programs broadcast on UHF or VHF or transmitted by cable companies for the use of the general public may require authorization from the broadcaster/cable company and/or program owner.

## NOTIFICATION

This equipment has been tested and found to comply with the limits for a Class B digital device pursuant to Part 15 of the FCC Rules. These limits are designed to provide reasonable protection against harmful interference in a residential installation. This equipment generates, uses, and can radiate radio frequency energy and, if not installed and used in accordance with the instructions, may cause harmful interference with radio communications. However, there is no guarantee that interference will not occur in a particular installation. If this equipment does cause harmful interference to radio or television reception, which can be determined by turning the equipment off and on, the user is encouraged to try to correct the interference by one or more of the following measures:

- Reorient or relocate the receiving antennas.
- Increase the separation between the equipment and receiver.
- Connect the equipment into an outlet on a circuit different from that to which the receiver is connected.
- Consult the dealer or an experienced radio/TV technician for help.

You are cautioned that any changes or modifications not expressly approved in this manual could void your authority to operate this equipment.

## Safety

- Operate the projection TV only on 120 V AC.
- The plug is designed, for safety purposes, to fit into the wall outlet only one way. If you are unable to insert the plug fully into the outlet, contact your dealer.
- If any liquid or solid object should fall inside the cabinet, unplug the projection TV immediately and have it checked by qualified service personnel before operating it further.
- If you will not be using the projection TV for several days, disconnect the power by pulling the plug itself. Never pull on the cord.
- For details concerning safety precautions, see "Important Safeguards" on page 3.

## Installing

- ❑ To prevent internal heat buildup, do not block the ventilation openings.
- ❑ Do not install the projection TV in a hot or humid place, or in a place subject to excessive dust or mechanical vibration.
- ❑ Avoid operating the projection TV at temperatures below 5°C (41°F).
- ❑ If the projection TV is transported directly from a cold to a warm location, or if the room temperature changes suddenly, the picture may be blurred or show poor color due to moisture condensation. In this case, please wait a few hours to let the moisture evaporate before turning on the projection TV.
- ❑ To obtain the best picture, do not expose the screen to direct illumination or direct sunlight. It is recommended to use spot lighting directed down from the ceiling or to cover the windows that face the screen with opaque drapery. It is desirable to install the projection TV in a room where the floor and walls are not of a reflective material.

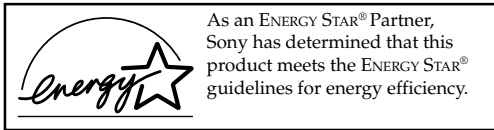

ENERGY STAR® is a U.S. registered mark.

## Trademark Information

TruSurround and the  symbol are trademarks of SRS Labs, Inc. TruSurround technology is incorporated under license from SRS Labs, Inc.

BBE and BBE Symbol are trademarks of BBE Sound, Inc. and are licensed by BBE Sound, Inc. under U.S. Patent No. 4,638,258 and 4,482,866.

Steady Sound, Digital Reality Creation, Caption Vision, CineMotion, Memory Stick, and Twin View are registered trademarks of Sony Corporation. ClearEdge VM, HD Detailer, and Uniform Brightness Screen are trademarks of Sony Corporation.

## Owner's Record

The model and serial numbers are located at the rear of the projection TV, below the Sony logo, on the sticker, and also on the TV box (white label). Record these numbers in the spaces provided below. Refer to them whenever you call upon your Sony dealer regarding this product.

Model No. \_\_\_\_\_

Serial No. \_\_\_\_\_

## CAUTION

### How to reduce the risk of "Image Retention" on your Projection TV

Bright, stationary images such as TV station logos displayed on your TV can cause permanent damage to your TV, resulting in retention of the image in the picture. Please take the following steps to reduce the risk of causing image retention:

View a variety of program sources or programming material.

Image retention can occur when bright stationary images such as TV station logos are viewed. Changing the program material viewed reduces the possibility that a single image will become imprinted on the picture tubes in your TV.

When viewing programs with stationary images, adjust the picture setting to reduce the "Picture" and "Brightness" levels. Image retention is accelerated by higher "Brightness" and higher "Picture" settings.

Please see page 72 for instructions on adjusting picture settings.

This will help you reduce the risk of causing image retention.

**IMAGE RETENTION IS NOT COVERED BY YOUR WARRANTY**

# IMPORTANT SAFEGUARDS

For your protection, please read these instructions completely, and keep this manual for future reference.

Carefully observe and comply with all warnings, cautions and instructions placed on the set or described in the operating instructions or service manual.

## WARNING

To guard against injury, the following basic safety precautions should be observed in the installation, use and servicing of the set.

## Use

### Power Sources

This set should be operated only from the type of power source indicated on the serial/model plate. If you are not sure of the type of electrical power supplied to your home, consult your dealer or local power company. For those sets designed to operate from battery power, refer to the operating instructions.



### Grounding or Polarization

This set is equipped with a polarized AC power cord plug (a plug having one blade wider than the other), or with a three-wire grounding type plug (a plug having a third pin for grounding). Follow the instructions below:

#### For the set with a polarized AC power cord plug

This plug will fit into the power outlet only one way. This is a safety feature. If you are unable to insert the plug fully into the outlet, try reversing the plug. If the plug still fails to fit, contact your electrician to have a suitable outlet installed. Do not defeat the safety purpose of the polarized plug by forcing it in.



#### For the set with a three-wire grounding type AC plug

This plug will only fit into a grounding-type power outlet. This is a safety feature. If you are unable to insert the plug into the outlet, contact your electrician to have a suitable outlet installed. Do not defeat the safety purpose of the grounding plug.

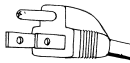

## Overloading

Do not overload wall outlets, extension cords or convenience receptacles beyond their capacity, since this can result in fire or electric shock.

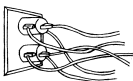

Always turn the set off when it is not being used. When the set is left unattended and unused for long periods of time, unplug it from the wall outlet as a precaution against the possibility of an internal malfunction that could create a fire hazard.



If a snapping or popping sound from a TV set is continuous or frequent while the TV is operating, unplug the TV and consult your dealer or service technician. It is normal for some TV sets to make occasional snapping or popping sounds, particularly when being turned on or off.

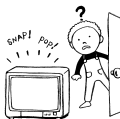

## Object and Liquid Entry

Never push objects of any kind into the set through the cabinet slots as they may touch dangerous voltage points or short out parts that could result in a fire or electric shock. Never spill liquid of any kind on the set.



## Cleaning

Clean the cabinet of the projection TV with a dry soft cloth. To remove dust from the screen, wipe it gently with a soft cloth. Stubborn stains may be removed with a cloth slightly dampened with a solution of mild soap and warm water. Never use strong solvents such as thinner or benzene for cleaning.



If the picture becomes dark after using the projection TV for a long period of time, it may be necessary to clean the inside of the projection TV. Consult qualified service personnel.

## Attachments

Do not use attachments not recommended by the manufacturer, as they may cause hazards.



## Installation

### Water and Moisture

Do not use power-line operated sets near water — for example, near a bathtub, washbowl, kitchen sink, or laundry tub, in a wet basement, or near a swimming pool, etc.



## Accessories

Do not place the set on an unstable cart, stand, table or shelf. The set may fall, causing serious injury to a child or an adult and serious damage to the set. Use only a cart or stand recommended by Sony for the specific model of TV. No part of the TV set should overhang any edge of the TV cart or stand; any overhanging edge is a safety hazard. An appliance and cart combination should be moved with care. Quick stops, excessive force, and uneven surfaces may cause the appliance and cart combination to overturn.



## Ventilation

The slots and openings in the cabinet and in the back or bottom are provided for necessary ventilation. To ensure reliable operation of the set, and to protect it from overheating, these slots and openings must never be blocked or covered.

- ❑ Never cover the slots and openings with a cloth or other materials.
- ❑ Never block the slots and openings by placing the set on a bed, sofa, rug or other similar surface.
- ❑ Never place the set in a confined space, such as a bookcase or built-in cabinet, unless proper ventilation is provided.
- ❑ Do not place the set near or over a radiator or heat register, or where it is exposed to direct sunlight.



## Power-Cord Protection

Do not allow anything to rest on or roll over the power cord, and do not place the set where the power cord is subject to wear or abuse.



## Antennas

### Outdoor Antenna Grounding

If an outdoor antenna is installed, follow the precautions below. An outdoor antenna system should not be located in the vicinity of overhead power lines or other electric light or power circuits, or where it can come in contact with such power lines or circuits.

WHEN INSTALLING AN OUTDOOR ANTENNA SYSTEM, EXTREME CARE SHOULD BE TAKEN TO KEEP FROM CONTACTING SUCH POWER LINES OR CIRCUITS AS CONTACT WITH THEM IS ALMOST INVARIABLY FATAL.

Be sure the antenna system is grounded so as to provide some protection against voltage surges and built-up static charges.

Section 810 of the National Electrical Code (NEC) in USA and Section 54 of the Canadian Electrical Code in Canada provides information with respect to proper grounding of the mast and supporting structure, grounding of the lead-in wire to an antenna discharge unit, size of grounding conductors, location of antenna discharge unit, connection to grounding electrodes, and requirements for the grounding electrode.

### Antenna Grounding According to the National Electrical Code, ANSI/NFPA 70

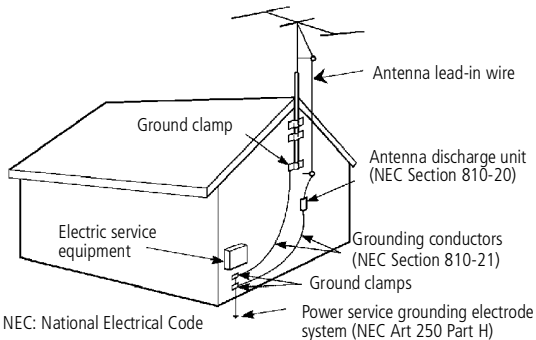

## Lightning

For added protection for this television receiver during a lightning storm, or when it is left unattended and unused for long periods of time, unplug it from the wall outlet and disconnect the antenna. This will prevent damage to the receiver due to lightning and power-line surges.

## Service

### Damage Requiring Service

Unplug the set from the wall outlet and refer servicing to qualified service personnel under the following conditions:

- ❑ When the power cord or plug is damaged or frayed.
- ❑ If liquid has been spilled into the set.
- ❑ If the set has been exposed to rain or water.
- ❑ If the set has been subject to excessive shock by being dropped, or the cabinet has been damaged.
- ❑ If the set does not operate normally when following the operating instructions. Adjust only those controls that are specified in the operating instructions. Improper adjustment of other controls may result in damage and will often require extensive work by a qualified technician to restore the set to normal operation.
- ❑ When the set exhibits a distinct change in performance, it indicates a need for service.

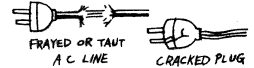

### Servicing

Do not attempt to service the set yourself since opening the cabinet may expose you to dangerous voltage or other hazards. Refer all servicing to qualified service personnel.



### Replacement Parts

When replacement parts are required, be sure the service technician certifies in writing that he has used replacement parts specified by the manufacturer that have the same characteristics as the original parts.

Unauthorized substitutions may result in fire, electric shock or other hazards.



### Safety Check

Upon completion of any service or repairs to the set, ask the service technician to perform routine safety checks (as specified by the manufacturer) to determine that the set is in safe operating condition, and to so certify. When the set reaches the end of its useful life, improper disposal could result in a picture tube implosion. Ask a qualified service technician to dispose of the set.



## For Safety

### Be careful when moving the projection TV

When you place the projection TV in position, be careful not to drop it on your foot or fingers.

Watch your footing while installing the projection TV.

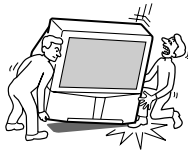

### Carry the projection TV in the specified manner

If you carry the projection TV in a manner other than the specified manner and without the specified number of persons, it may drop and a serious injury may be caused. Be sure to follow the instructions mentioned below.

- Carry the projection TV with the specified number of persons (see “Carrying Your Projection TV” on page 12).
- Do not carry the projection TV holding the speaker grill.
- Hold the projection TV tightly when carrying it.

The projection TV includes handles that you can use to carry the unit.



# Contents

## **Introducing the Projection TV**

<b>Welcome</b> .....	<b>9</b>
Package Contents.....	9
Features .....	9

## **Setting Up the TV**

<b>Overview</b> .....	<b>11</b>
<b>Carrying Your Projection TV</b> .....	<b>12</b>
<b>Installing the TV</b> .....	<b>12</b>
<b>TV Controls and Connectors</b> .....	<b>13</b>
Front Video Controls .....	13
KP-57/65WV600 Front Panel .....	14
KP-57/65WV700 Front Panel .....	15
Rear Panel .....	16
<b>Basic Connections: Connecting a Cable or Antenna</b> .....	<b>18</b>
Cable or Antenna Only .....	19
Cable and Antenna Only .....	20
Cable Box and Cable Only .....	22
Cable Box Only .....	24
<b>Connecting Optional Equipment</b> .....	<b>25</b>
About Using S VIDEO .....	25
VCR and Cable .....	26
VCR and Cable Box .....	28
Two VCRs for Tape Editing .....	30
Satellite Receiver .....	32
Satellite Receiver and VCR .....	34
DVD Player with Component Video Connectors.....	36
DVD Player with S VIDEO and Audio Connectors .....	38
Digital TV Set-Top Box with Component Video Connectors.....	39
Camcorder .....	40
Audio Receiver .....	41
<b>Using the CONTROL S Feature</b> .....	<b>42</b>
<b>Setting Up the Channel List</b> .....	<b>43</b>
Using Auto Setup .....	43
<b>Adjusting the Convergence Automatically (Flash Focus)</b> .....	<b>44</b>
<b>Adjusting the Convergence Manually</b> .....	<b>45</b>
Notes on Adjusting the Convergence Manually.....	46

## **Using the Remote Control**

<b>Overview</b> .....	<b>47</b>
<b>Inserting Batteries</b> .....	<b>47</b>
<b>Button Descriptions</b> .....	<b>48</b>
<b>Programming the Remote Control</b> .....	<b>51</b>
<b>Using Other Equipment with Your TV Remote Control</b> .....	<b>53</b>



## Using the Features

<b>Overview</b> .....	<b>55</b>
<b>Watching TV</b> .....	<b>56</b>
<b>Using the Scrolling Index</b> .....	<b>57</b>
<b>Using Wide Mode</b> .....	<b>58</b>
<b>Using Twin View</b> .....	<b>59</b>
Displaying Twin Pictures .....	59
Factors Affecting Twin View .....	59
Activating the Picture .....	60
Changing the Picture Size .....	61
<b>Using Favorite Channels</b> .....	<b>62</b>
Creating a List of Favorite Channels .....	62
Displaying a List of Favorite Channels .....	62
<b>Using the Freeze Function</b> .....	<b>63</b>
<b>Using the Memory Stick Picture Viewer</b> .....	<b>64</b>
About Memory Stick .....	64
Supported Image Types .....	64
Unsupported Image Types .....	65
Inserting and Removing a Memory Stick .....	66
Displaying the Memory Stick Menu .....	67
Using the Memory Stick Index .....	68
Using the Memory Stick Slideshow .....	69
Changing the Memory Stick Setup Options .....	69
Using the Rotate Picture Screen .....	70

## Using the Menus

<b>Overview</b> .....	<b>71</b>
<b>Navigating Through Menus</b> .....	<b>71</b>
<b>Using the Video Menu</b> .....	<b>72</b>
<b>Using the Audio Menu</b> .....	<b>74</b>
<b>Using the Screen Menu</b> .....	<b>76</b>
<b>Using the Channel Menu</b> .....	<b>78</b>
<b>Using the Parent Menu</b> .....	<b>80</b>
<b>Using the Setup Menu</b> .....	<b>83</b>

## Other Information

<b>Overview</b> .....	<b>87</b>
<b>Glossary</b> .....	<b>88</b>
<b>Notes on Using Memory Stick Media</b> .....	<b>89</b>
<b>Contacting Sony</b> .....	<b>90</b>
<b>Troubleshooting</b> .....	<b>90</b>
<b>Specifications</b> .....	<b>95</b>
<b>Optional Accessories</b> .....	<b>96</b>
<b>Index</b> .....	<b>97</b>

# Introducing the Projection TV

## Welcome

Thank you for purchasing the Sony Projection TV. This manual is to be used with the following models:

- ❑ KP-57WV600
- ❑ KP-65WV600
- ❑ KP-57WV700
- ❑ KP-65WV700

---

## Package Contents

Along with your new projection TV, the package contains a remote control and two AA batteries. No additional cables are included. These items are all you need to set up and operate the projection TV in its basic configuration.

Most components (VCRs, DVD players, etc.) come with the necessary cables to connect them. If you want to set up a complex system, you may need to buy extra cables, connectors, etc. Be sure to have these on hand before you start to connect your system.

---

## Features

Some of the features that you will enjoy with your new TV include:

- ❑ **Wide Screen Mode:** Watch conventional 4:3 aspect ratio broadcasts in wide screen (16:9) mode.
- ❑ **DRC® (Digital Reality Creation) Multifunction V1:** Unlike conventional line doublers, the DRC Multifunction feature replaces the signal's NTSC waveform with the near-HD equivalent, while doubling the number of vertical and horizontal lines. This results in four times the density for quality sources, such as DVD, satellite, and digital camcorders. The Video Menu allows you to select interlaced, progressive, or CineMotion™ output. The DRC Palette option lets you customize the level of detail (Reality) and smoothness (Clarity) to create up to three custom palettes.
- ❑ **Scrolling Index:** Lets you preview and select programs from a scrolling index of video pictures.
- ❑ **Favorite Channels:** Allows you to preview and select from eight of your favorite channels.

- ❑ **Twin View™**: Using the Multi-Image Driver (MIDX), Twin View allows you to watch two programs side by side, with the ability to zoom in one picture. You can watch pictures from two different sources (1080i, 720p, 480p, and 480i) simultaneously. (Only the left Twin View window can display 1080i, 720p, and 480p sources.)
- ❑ **ClearEdge VM™ Velocity Modulation**: Sharpens picture definition by enhancing vertical lines.
- ❑ **Uniform Brightness Screen™** (*KP-57/65WV700 only*): Special optical technology expands the vertical viewing angle to nearly double that of other rear projection televisions.
- ❑ **Steady Sound®**: Equalizes volume levels so there is consistent output between programs and commercials.
- ❑ **Memory Stick® Picture Viewer**: Allows you to view on your TV screen digital images that are stored on Memory Stick media.
- ❑ **Component Video Inputs**: Offers the best video quality for DVD (480p, 480i), and digital set-top box (HD1080i, 720p) connections.
- ❑ **HD Detailer™**: Wideband video amplifier has a high bandwidth frequency rating, which allows it to send more video information to the screen, resulting in finer picture quality, especially for HD sources.
- ❑ **CineMotion™**: Reverse 3-2 pulldown processing provides optimal picture quality for film-based sources (media originally shot in 24 frames-per-second format).
- ❑ **Parental Control**: V-Chip technology allows parents to block unsuitable programming from younger viewers.
- ❑ **Digital Visual Interface (DVI)**: Can accommodate a copy-protected digital connection (HDCP\*) to other devices (such as digital set-top boxes) that have compatible interfaces. The DVI-HDTV input terminal is compliant with the EIA-861 standard and is not intended for use with personal computers.

---

\*High-bandwidth Digital Content Protection

# Setting Up the TV

## Overview

This chapter includes illustrated instructions for setting up your TV.

<i>Topic</i>	<i>Page(s)</i>
Carrying Your Projection TV	12
Installing the TV	12
TV Controls and Connectors	13-17
Basic Connections: Connecting a Cable or Antenna	18-24
Connecting Optional Equipment	
VCR and Cable	26
VCR and Cable Box	28
Two VCRs for Tape Editing	30
Satellite Receiver	32
Satellite Receiver and VCR	34
DVD Player with Component Video Connectors	36
DVD Player with S VIDEO and Audio Connectors	38
Digital TV Set-Top Box with Component Video Connectors	39
Camcorder	40
Audio Receiver	41
Using the CONTROL S Feature	42
Setting Up the Channel List	43
Adjusting the Convergence Automatically (Flash Focus)	44
Adjusting the Convergence Manually	45

## Carrying Your Projection TV

Carrying the TV requires four or more people. The TV is equipped with casters for easy movement on a hard surface. Be sure to move your projection TV using the casters. The TV includes handles that you can use to carry the unit.

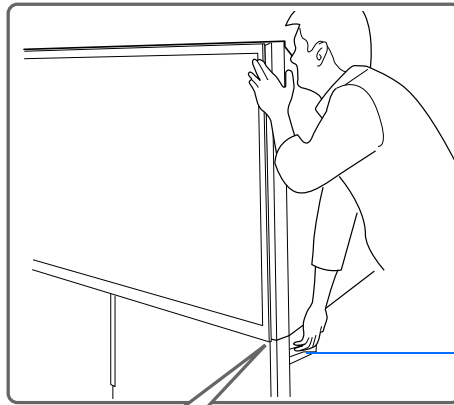

Handle (one on each side)

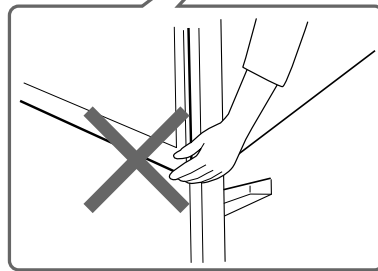

Do not carry the TV by placing hands under the front screen

## Installing the TV

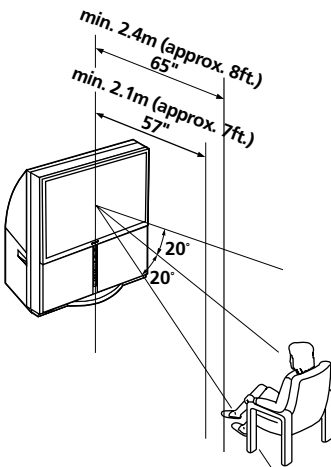

Recommended Vertical Viewing Angle

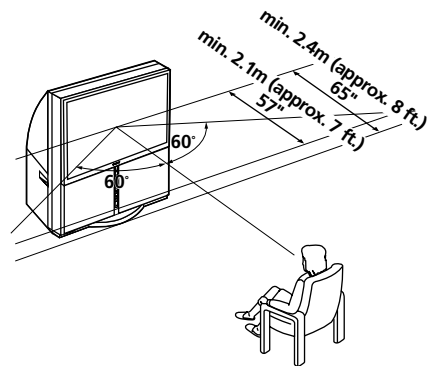

Recommended Horizontal Viewing Angle

## TV Controls and Connectors

To access the front video panel, push up and then release. The panel drops down automatically (KP-57/65WV700 shown).

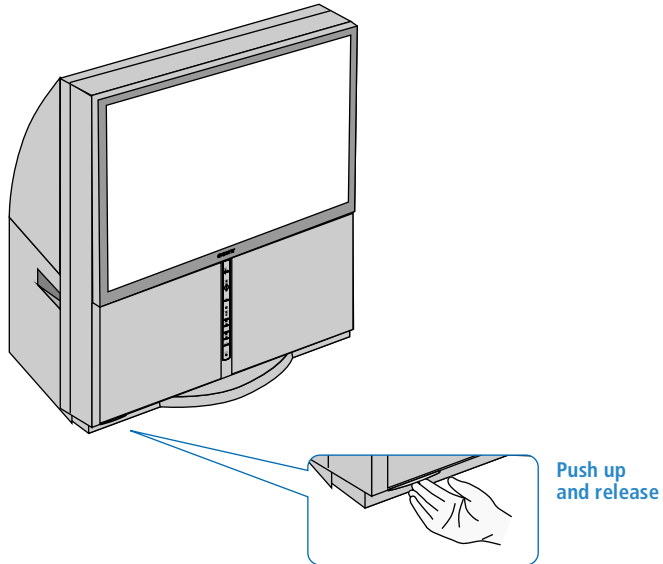

### Front Video Controls

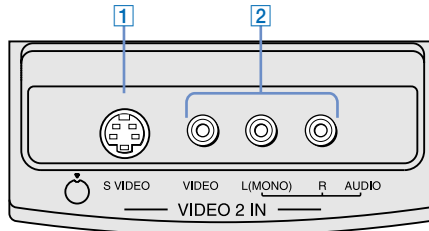

- |   |  |
|---|--|
| <b>1</b> S VIDEO<br>VIDEO 2 INPUT                   | Connects to the S VIDEO OUT jack on your camcorder or other video equipment that has S VIDEO. Provides better picture quality than composite video ( <b>2</b> ). |
| <b>2</b> VIDEO/L(MONO)-<br>AUDIO-R<br>VIDEO 2 INPUT | Connects to the composite A/V output jacks on your camcorder or other video equipment.   |

## KP-57/65WV600 Front Panel

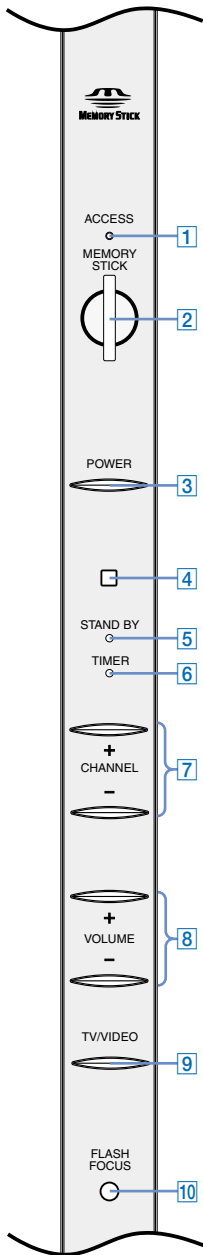

Item	Description
<b>1</b> MEMORY STICK ACCESS LED	When lit, indicates that the Memory Stick is being read. (Do not remove the Memory Stick when the indicator is lit.)
<b>2</b> MEMORY STICK	Memory Stick insertion slot. For details, see “Inserting and Removing a Memory Stick” on page 66.
<b>3</b> POWER	Press to turn on and off the TV.
<b>4</b> Infrared Receiver (IR)	Receives IR signals from the TV’s remote control.
<b>5</b> STAND BY LED	Blinks when the TV is turned on, then shuts off when the picture is displayed. If the LED blinks continuously, this may indicate the TV needs service (see “Contacting Sony” on page 90).
<b>6</b> TIMER LED	When lit, indicates one of the timers is set. When the timer is set, this LED will remain lit even if the TV is turned off. For details, see page 84.
<b>7</b> -CHANNEL+	Press to scan through channels. To scan quickly through channels, press and hold down either CHANNEL button.
<b>8</b> -VOLUME +	Press to adjust the volume.
<b>9</b> TV/VIDEO	Press repeatedly to cycle through the video equipment connected to the TV’s video inputs.
<b>10</b> FLASH FOCUS	Press to adjust the convergence (see page 44).

## KP-57/65WV700 Front Panel

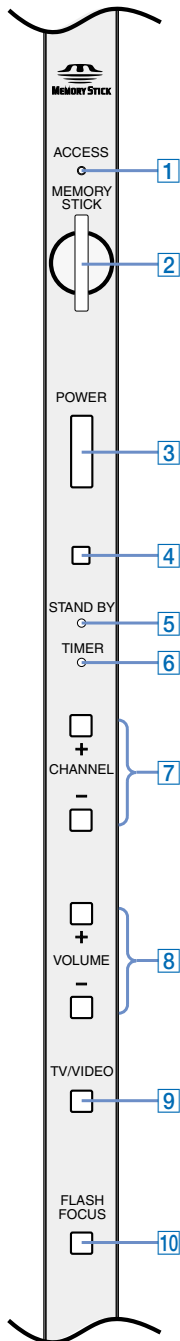

Item	Description
<b>1</b> MEMORY STICK ACCESS LED	When lit, indicates that the Memory Stick is being read. (Do not remove the Memory Stick when the indicator is lit.)
<b>2</b> MEMORY STICK	Memory Stick insertion slot. For details, see “Inserting and Removing a Memory Stick” on page 66.
<b>3</b> POWER	Press to turn on and off the TV.
<b>4</b> Infrared Receiver (IR)	Receives IR signals from the TV’s remote control.
<b>5</b> STAND BY LED	Blinks when the TV is turned on, then shuts off when the picture is displayed. If the LED blinks continuously, this may indicate the TV needs service (see “Contacting Sony” on page 90).
<b>6</b> TIMER LED	When lit, indicates one of the timers is set. When the timer is set, this LED will remain lit even if the TV is turned off. For details, see page 84.
<b>7</b> -CHANNEL+	Press to scan through channels. To scan quickly through channels, press and hold down either CHANNEL button.
<b>8</b> -VOLUME +	Press to adjust the volume.
<b>9</b> TV/VIDEO	Press repeatedly to cycle through the video equipment connected to the TV’s video inputs.
<b>10</b> FLASH FOCUS	Press to adjust the convergence (see page 44).



# Rear Panel

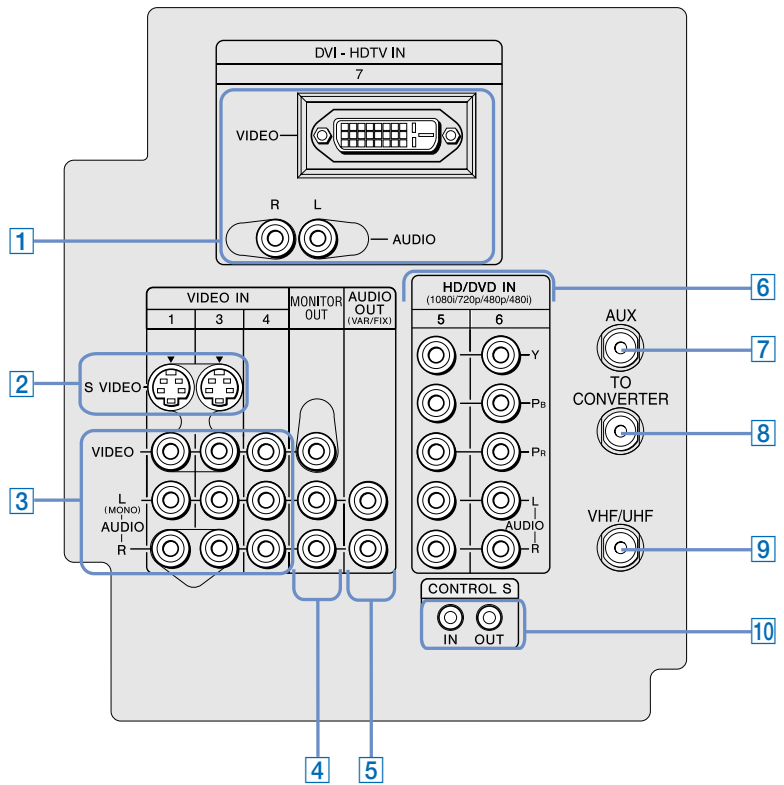

Jack	Description
<a href="#">1</a> DVI-HDTV VIDEO AUDIO R/L (VIDEO 7 IN)	Can accommodate a copy-protected digital connection (HDCP*) to other devices (such as digital set-top boxes) that have compatible interfaces. The DVI-HDTV input terminal is compliant with the EIA-861 standard and is not intended for use with personal computers. See the instruction manual that came with your equipment for details about connecting and using it with the TV.
<a href="#">2</a> S VIDEO IN 1/3	Connects to the S VIDEO OUT jack of your VCR or other video equipment that has S VIDEO. S VIDEO provides better picture quality than either composite video ( <a href="#">3</a> ) or VHF/UHF ( <a href="#">9</a> ) connections.
<a href="#">3</a> VIDEO IN 1/3/4 VIDEO/L(MONO) -AUDIO-R	Connect to the composite A/V output jacks on your VCR or other video component. A fourth component A/V input jack (VIDEO 2) is located on the front panel of the TV. These video connections provide better picture quality than the VHF/UHF ( <a href="#">9</a> ) connections.
<a href="#">4</a> MONITOR OUT	Lets you record the program you are watching to a VCR. When two VCRs are connected, you can use the TV as a monitor for tape-to-tape editing (not available with 480p, 720p, or 1080i when the input is set to VIDEO 5-7).
<a href="#">5</a> AUDIO OUT (VAR/FIX) L (MONO)/R	Connects to the left and right audio input jacks of your audio or video equipment. You can use these outputs to listen to your TV's audio through your stereo system.
<a href="#">6</a> HD/DVD IN 5/6 (1080i/720p/480p/480i)	Connect to your DVD player's or digital set-top box's component video (Y, PB, PR) and audio (L/R) jacks. Component video provides better picture quality than <a href="#">2</a> , <a href="#">3</a> , or <a href="#">9</a> .
<a href="#">7</a> AUX	Auxiliary RF input that connects to your antenna, CATV cable, or cable box output jack. This is convenient if you are using two VHF/UHF sources (antenna, CATV cable, or cable box). For details, see pages 20 to 23.
<a href="#">8</a> TO CONVERTER	Connects to your cable box input jack. This VHF/UHF output jack lets you set up your TV to switch between scrambled channels (coming through a cable box) and unscrambled cable channels. Use this jack instead of a splitter to get better picture quality when you need to switch between scrambled and unscrambled cable channels. For details, see pages 22 to 23.
<a href="#">9</a> VHF/UHF	Primary RF input that connects to your VHF/UHF antenna or cable.
<a href="#">10</a> CONTROL S IN/OUT	Allows the TV to receive (IN) and send (OUT) remote control signals to other Sony infrared-controlled audio or video equipment that has the CONTROL S function.

\*High-bandwidth Digital Content Protection

## Basic Connections: Connecting a Cable or Antenna

The way in which you will connect your TV varies, depending on how your home receives a signal (cable, cable box, antenna) and whether or not you plan to connect a VCR.

<i>If You Are Connecting</i>	<i>See Page</i>
<b>Cable or Antenna Only</b>	19
<input type="checkbox"/> No cable box or VCR	
<b>Cable and Antenna Only</b>	20
<input type="checkbox"/> No cable box or VCR	
<b>Cable Box and Cable Only</b>	22
<input type="checkbox"/> Cable box unscrambles only some channels (usually premium channels)	
<input type="checkbox"/> No VCR	
<b>Cable Box Only</b>	24
<input type="checkbox"/> Cable box unscrambles all channels	
<input type="checkbox"/> No VCR	

### If you are connecting a VCR

- See the connections described on pages 26 and 28.

## Cable or Antenna Only

For best results, use one of the following connections if you are connecting a cable or an antenna and you:

- ❑ Do not need a cable box to unscramble channels. (If you have a cable box, see pages 22-24.)
- ❑ Do not intend to connect a VCR. (If you have a VCR, see pages 26 and 28.)

The connection you choose depends on the cable type you have in your home, as described below.

### 75-ohm coaxial cable (usually found in newer homes)

**Cable Type**

**Connect As Shown**

VHF Only or combined VHF/UHF or Cable

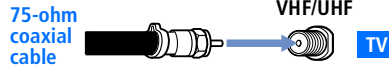

### 300-ohm twin lead cable (usually found in older homes)

**Cable Type**

**Connect As Shown**

VHF Only or UHF Only or combined VHF/UHF

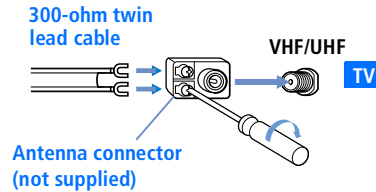

### 75-ohm coaxial and 300-ohm twin lead cable (found in some homes)

**Cable Type**

**Connect As Shown**

VHF and UHF

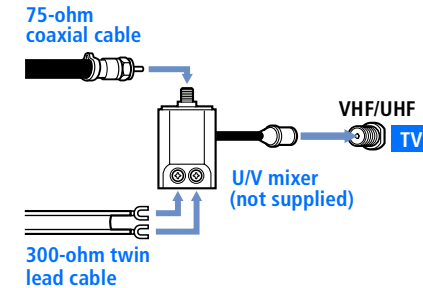

**Cable and Antenna Only**

For best results, use this connection if you:

- ❑ Have a cable and an antenna.  
(This is convenient if you are using a separate rooftop antenna to receive additional channels that are not provided by your cable company.)
- ❑ Do not have a cable box or VCR. (If you have a cable box, see pages 22 to 24. If you have a VCR, see pages 26 and 28.)

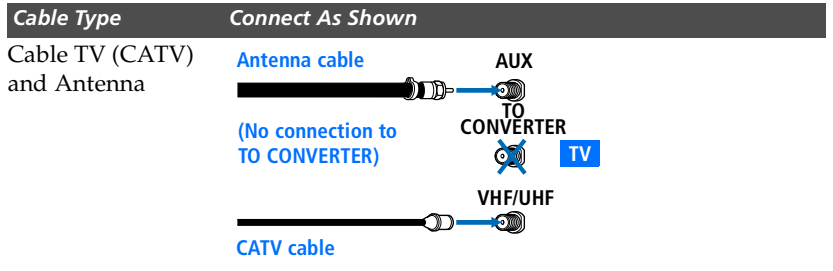

**About Using This Connection with Dual Picture (Twin View, etc.) Features**

With this connection, you cannot view antenna channels in the right dual picture window.

## Notes on Using This Connection

To Do This ...	Do This ...
Switch the TV's input between the cable and antenna	Press <b>ANT</b> to switch back and forth between the TV's VHF/UHF and AUX inputs.
Receive channels using an antenna, instead of the cable	<ol style="list-style-type: none"><li>1 Press <b>ANT</b> to switch to the AUX input.</li><li>2 Set the <b>Cable</b> option to <b>Off</b>. For details, see "Selecting Channel Options" on page 78.</li><li>3 Run the Auto Setup program, as described in "Using Auto Setup" on page 43.</li></ol>

## **Cable Box and Cable Only**

### **For best results, use this connection if:**

- ❑ Your cable company scrambles some channels, such as premium channels (which requires you to use a cable box), but does not scramble all channels.
- ❑ You do not have a VCR. (If you have a VCR, see pages 26 and 28.)

### **With this connection you can:**

- ❑ Use the TV remote control to change channels coming through the cable box to the TV's AUX input jack. (You must first program the remote control for your specific cable box; see "Programming the Remote Control" on page 51.)
- ❑ Use the TV remote control to change channels coming directly into the TV's VHF/UHF input. (The TV's tuner provides a better signal than the cable box.)

### ***About Using This Connection with Dual Picture (Twin View, etc.) Features***

With this connection, you can use all the dual picture features for unscrambled channels coming directly into the TV's VHF/UHF input jack.

However, you can use only some of the dual picture features for channels coming through the cable box to the TV's AUX input jack. For example, when you switch the TV's input to AUX — to select the cable box input — the picture displays only in the left window. For example, if you turn on Twin View, you can watch cable channels coming into the VHF/UHF jack in the right window, but you cannot swap the pictures between the left and right windows.

### To connect the cable box and cable

- 1 Connect the cable from your cable company to the TV's VHF/UHF jack.
- 2 Use a coaxial cable to connect the TV's TO CONVERTER jack to the cable box's input jack. (The TV's internal converter lets you switch between unscrambled signals coming straight into the TV and scrambled signals coming in through the cable box, eliminating the need for an external splitter.)
- 3 Use a coaxial cable to connect the cable box's output jack to the TV's AUX jack.
- 4 Run the Auto Setup program, as described in "Setting Up the Channel List" on page 43.

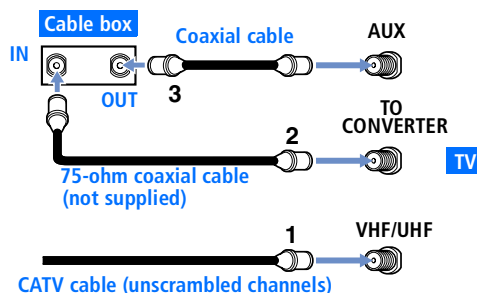

### Notes on Using This Connection

To Do This ...	Do This ...
Use the cable box	Tune the TV to the channel the cable box is set to (usually channel 3 or 4) and then use the cable box to switch channels.
Set up the TV remote control to operate the cable box	Program the remote control. See "Programming the Remote Control" on pages 51-52.
Activate the remote control to operate the cable box	Press <b>SAT/CABLE FUNCTION</b> .
Prevent the accidental switching of TV channels	When using the cable box, you need the TV to stay on the channel the cable box is set to (usually channel 3 or 4). You can use the TV's Channel Fix feature to lock in a specific channel. For details, see "Using the Channel Menu" on page 78.
Switch the TV's input between the cable box and cable	Press <b>ANT</b> to switch back and forth between the TV's VHF/UHF (unscrambled channels) and AUX (scrambled) inputs.



## Cable Box Only

### For best results, use this connection if:

- ❑ Your cable company scrambles all channels, which requires you to use a cable box.
- ❑ You do not have a VCR. (If you have a VCR, see pages 26 and 28.)

### With this connection you can:

- ❑ Use the TV remote control to change channels coming through the cable box to the TV's VHF/UHF jack. (You must first program the remote control for your specific cable box.)

### About Using This Connection with Dual Picture (Twin View, etc.) Features

With this connection, all channels come to the TV through your cable box and only one unscrambled signal is sent to the TV, so you cannot use the dual picture features. If some of your channels are scrambled, but others are not, consider using the "Cable Box and Cable" connection on page 22 instead.

### To connect the cable box

- 1 Connect the CATV cable to the cable box's input jack.
- 2 Use a coaxial cable to connect the cable box's output jack to the TV's VHF/UHF jack.
- 3 Run the Auto Setup program, as described in "Setting Up the Channel List" on page 43.

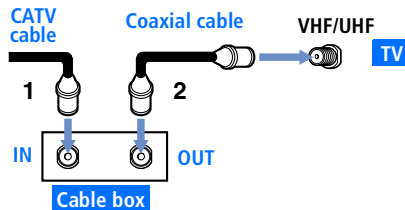

### Notes on Using This Connection

To Do This ...	Do This ...
Use the cable box	Tune the TV to the channel the cable box is set to (usually channel 3 or 4) and then use the cable box to switch channels.
Set up the TV remote control to operate the cable box	Program the remote control. See "Programming the Remote Control" on pages 51-52.
Activate the remote control to operate the cable box	Press <b>SAT/CABLE FUNCTION</b> .
Prevent the accidental switching of TV channels	When using the cable box, you need the TV to stay on the channel the cable box is set to (usually channel 3 or 4). You can use the TV's Channel Fix feature to lock in a specific channel. For details, see "Using the Channel Menu" on page 78.

## Connecting Optional Equipment

Use the directions in this section to connect the following optional equipment:

<i>If You Are Connecting</i>	<i>See Page</i>
VCR and Cable	26
VCR and Cable Box	28
Two VCRs for Tape Editing	30
Satellite Receiver	32
Satellite Receiver and VCR	34
DVD Player with Component Video Connectors	36
DVD Player with S VIDEO and Audio Connectors	38
Camcorder	40
Audio Receiver	41

### About Using S VIDEO



If the optional equipment you are connecting has an S VIDEO jack (shown at left), you can use an S VIDEO cable for improved picture quality (compared to an A/V cable). Because S VIDEO carries only the video signal, you also need to connect audio cables for sound, as shown below.

#### Example of an S VIDEO Connection

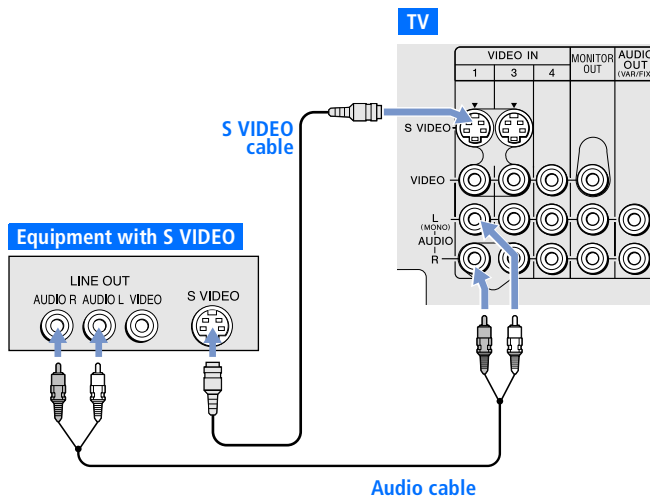

Cables are often color-coded to connectors. Connect red to red, white to white, etc.

## VCR and Cable

For best results, use this connection if:

- ❑ Your cable company does not require you to use a cable box.

### About Using This Connection with Dual Picture (Twin View, etc.) Features

With this connection, you can use all the dual picture features.

#### To connect the VCR and cable

- 1 Connect the CATV cable to the VCR's VHF/UHF input jack.
- 2 Use a coaxial cable to connect the VCR's VHF/UHF output jack to the TV's VHF/UHF jack.
- 3 Use an A/V cable to connect the VCR's A/V output jacks to the TV's A/V input jacks.
- 4 Run the Auto Setup program, as described in "Setting Up the Channel List" on page 43.



Using  
S VIDEO jacks?  
See page 25.

TV

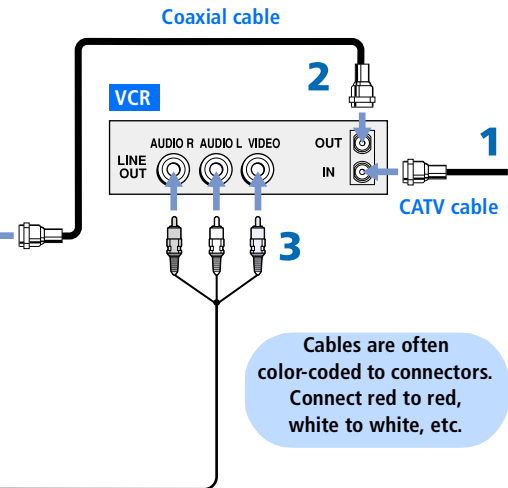
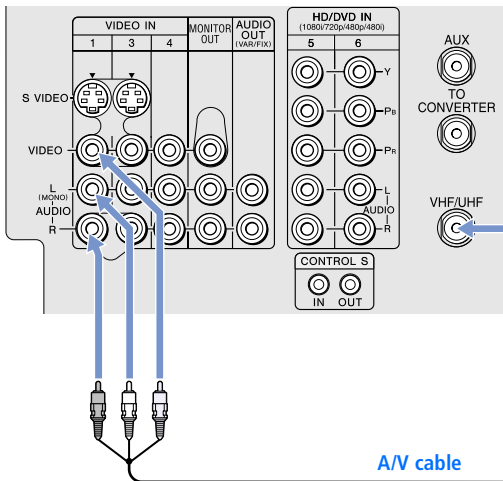

Cables are often  
color-coded to connectors.  
Connect red to red,  
white to white, etc.

## Notes on Using This Connection

<i>To Do This ...</i>	<i>Do This ...</i>
Watch the VCR	Press <b>TV/VIDEO</b> repeatedly to select the VCR input (VIDEO 1 in the illustration).
Watch cable channels	Press <b>TV/VIDEO</b> repeatedly to select the cable input (VHF/UHF in the illustration).
Set up the TV remote control to operate the VCR	If you have a non-Sony VCR, you must program the remote control. See “Programming the Remote Control” on pages 51-52.
Activate the TV remote control to operate the VCR	Open the outside cover, as shown on page 50. Then set the A/V slide switch to the position you programmed for the VCR.
Control VCR functions with the TV remote control	See “Operating a VCR” on page 53.
Label video inputs to easily identify equipment connected to the TV	See the instructions for setting up Video Labels on pages 83-84.

## VCR and Cable Box

### For best results, use this connection if:

- ❑ Your cable company scrambles some channels, such as premium channels (which requires you to use a cable box), but does not scramble all channels.

### About Using This Connection with Dual Picture (Twin View, etc.) Features

With this connection, you can use all the dual picture features.

### With this connection you can:

- ❑ Use the TV remote control to change channels coming through the cable box. (You must first program the remote control for your specific cable box; see “Programming the Remote Control” on page 51.)
- ❑ Use the TV remote control to change channels coming directly into the TV’s VHF/UHF jack. (The TV’s tuner provides a better signal than the cable box.)
- ❑ Record channels coming through the cable box and channels coming directly into the TV.

### To connect a VCR and cable box, you need:

- ❑ A splitter, which is a small, inexpensive device that you can purchase at your local electronics store.
- ❑ Three coaxial cables.
- ❑ One A/V cable or one S VIDEO cable with audio cables.

### To connect the VCR and cable box

- 1 Connect the CATV cable to the single (input) jack of the splitter.
- 2 Use a coaxial cable to connect one of the splitter’s two output jacks to the TV’s VHF/UHF jack.
- 3 Use a coaxial cable to connect the splitter’s other output jack to the cable box’s input jack.
- 4 Use a coaxial cable to connect the cable box’s output jack to the VCR’s RF input jack.
- 5 Use an A/V cable to connect the VCR’s A/V output jacks to the TV’s A/V input jacks.
- 6 Run the Auto Setup program, as described in “Setting Up the Channel List” on page 43.



Using  
S VIDEO jacks?  
See page 25.

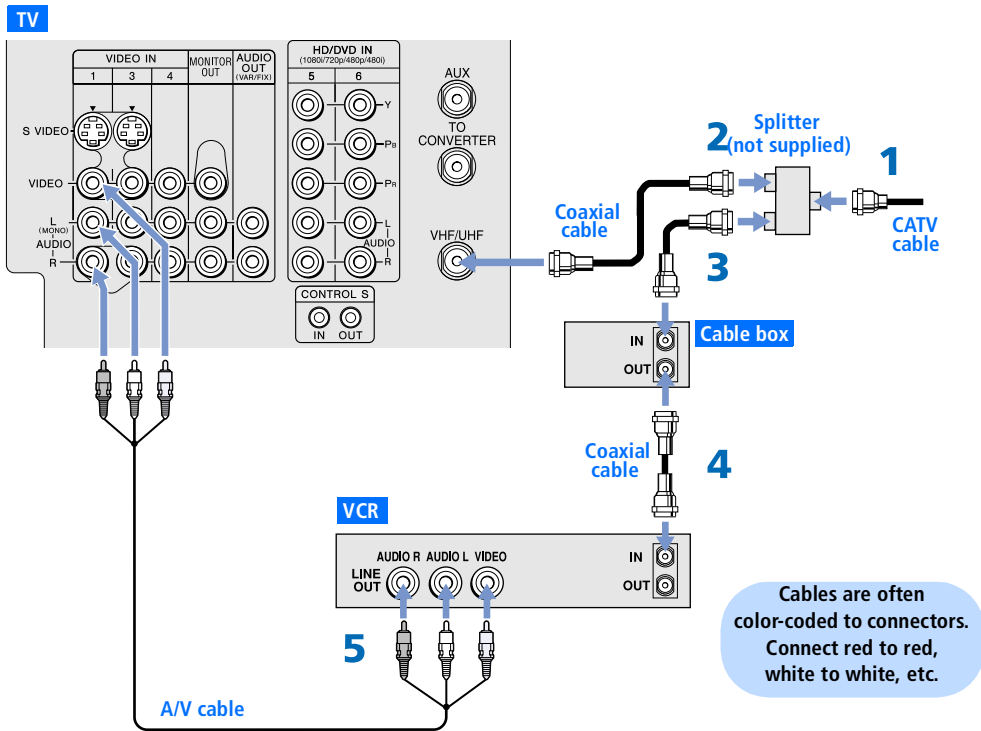

### Notes on Using This Connection

To Do This ...	Do This ...
Watch cable (unscrambled) channels	Press <b>TV/VIDEO</b> repeatedly to select the cable input (UHF/VHF in the illustration).
Watch cable box (scrambled) channels	Turn on the VCR and tune it to the channel the cable box is set to (usually channel 3 or 4). Press <b>TV/VIDEO</b> repeatedly to select the VCR input (VIDEO 1 in the illustration). Use the cable box to change channels.
Watch the VCR	Press <b>TV/VIDEO</b> repeatedly to select the VCR input (VIDEO 1 in the illustration).
Set up the TV remote control to operate the cable box or VCR	If you have a non-Sony VCR, you must program the remote control. See "Programming the Remote Control" on pages 51-52.
Activate the remote control to operate the cable box or VCR	For the cable box, press <b>SAT/CABLE FUNCTION</b> . For the VCR, open the outside cover, as shown on page 50. Then set the A/V slide switch to the position you programmed for the VCR.
Control specific cable box and VCR functions with the TV remote control	See "Operating a Cable Box" on page 54 and "Operating a VCR" on page 53.
Label video inputs to easily identify equipment connected to the TV	See the instructions for setting up Video Labels on pages 83-84.

## Two VCRs for Tape Editing



Using  
S VIDEO jacks?  
See page 25.

Connecting two VCRs lets you record from one VCR to the other. By connecting them as shown below, you can view (monitor) what is being recorded.

### To connect two VCRs for tape editing

- 1 Use an A/V cable to connect the playback VCR's A/V output jacks to the TV's A/V input jacks.
- 2 Use an A/V cable to connect the recording VCR's A/V input jacks to the TV's MONITOR OUT jacks.

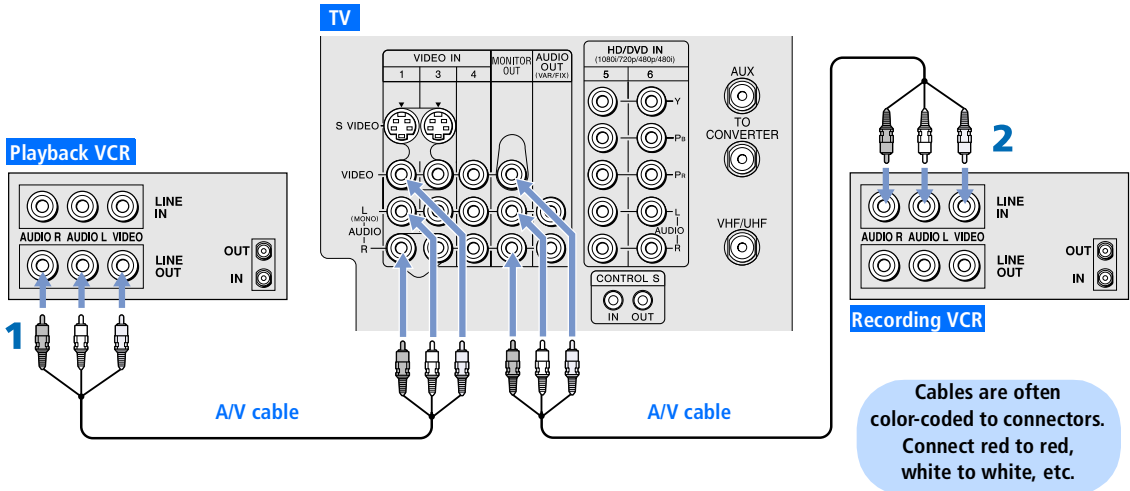

## Notes on Using This Connection

<i>To Do This ...</i>	<i>Do This ...</i>
View (monitor) what is being recorded	Press <b>TV/VIDEO</b> repeatedly to select the VCR input (VIDEO 1 in the illustration above).
Set up the TV remote control to operate the VCR(s)	If you have a non-Sony VCR, you must program the remote control. See "Programming the Remote Control" on pages 51-52.
Activate the TV remote control to operate the VCR(s)	Open the outside cover, as shown on page 50. Then set the A/V slide switch to the position you programmed for the VCR.
Control VCR functions with the TV remote control	See "Operating a VCR" on page 53.
Label video inputs to easily identify equipment connected to the TV	See the instructions for setting up Video Labels on pages 83-84.



## Satellite Receiver



Using  
S VIDEO jacks?  
See page 25.

### To connect a satellite receiver

- 1 Connect the satellite antenna cable to the satellite receiver's satellite input jack.
- 2 Use an A/V cable to connect the satellite receiver's A/V output jacks to the TV's A/V input jacks.
- 3 Connect a CATV cable from your cable or antenna to the TV's VHF/UHF jack.
- 4 Run the Auto Setup program, as described in "Setting Up the Channel List" on page 43.

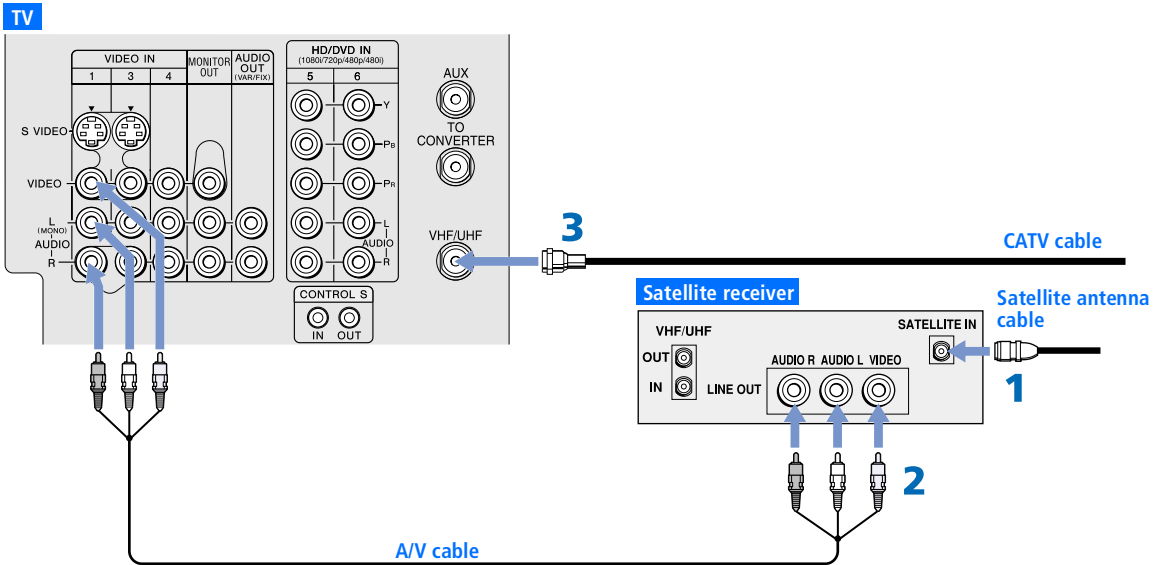

Cables are often color-coded to connectors. Connect red to red, white to white, etc.

## Notes on Using This Connection

<i>To Do This ...</i>	<i>Do This ...</i>
Watch the satellite receiver	Press <b>TV/VIDEO</b> repeatedly to select the satellite receiver input (VIDEO 1 in the illustration).
Set up the TV remote control to operate the satellite receiver	If you have a non-Sony satellite receiver, you must program the remote control. See "Programming the Remote Control" on pages 51-52.
Activate the TV remote control to operate the satellite receiver	Press <b>SAT/CABLE FUNCTION</b> .
Control satellite receiver functions with the TV remote control	See "Operating a Satellite Receiver" on page 53.
Label video inputs to easily identify equipment connected to the TV	See the instructions for setting up Video Labels on pages 83-84.

## Satellite Receiver and VCR



Using S VIDEO jacks?  
See page 25.

### To connect a satellite receiver and VCR

- 1 Connect the satellite antenna cable to the satellite receiver's satellite input jack.
- 2 Connect the CATV cable to the VCR's VHF/UHF input jack.
- 3 Use a coaxial cable to connect the VCR's VHF/UHF output jack to the TV's VHF/UHF jack.
- 4 Use an A/V cable to connect the satellite receiver's A/V output jacks to the VCR's A/V input jacks.
- 5 Use an A/V cable to connect the VCR's A/V output jacks to the TV's A/V input jacks.
- 6 Run the Auto Setup program, as described in "Setting Up the Channel List" on page 43.

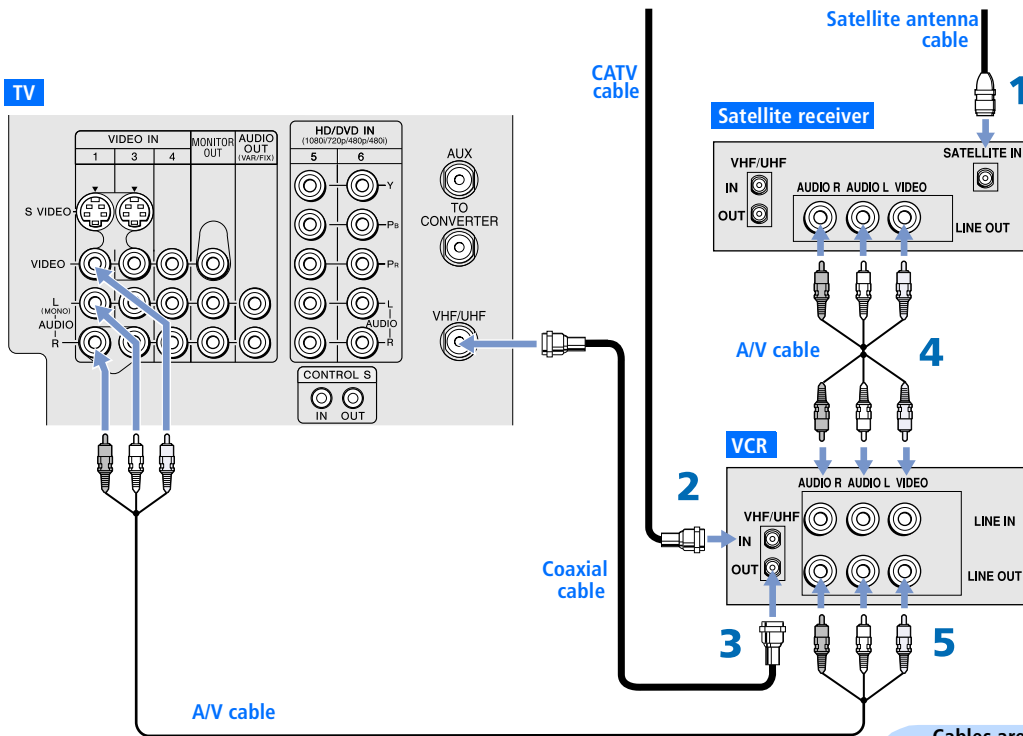

Cables are often color-coded to connectors. Connect red to red, white to white, etc.

## Notes on Using This Connection

To Do This ...	Do This ...
Watch the satellite receiver	Press <b>TV/VIDEO</b> repeatedly to select the VCR input (VIDEO 1 in the illustration). The VCR may need to be turned on and set to the satellite receiver input.
Watch the VCR	Press <b>TV/VIDEO</b> repeatedly to select the input to which the VCR is connected (VIDEO 1 in the illustration).
Set up the TV remote control to operate the satellite receiver or VCR	If you have a non-Sony VCR or satellite receiver, you must program the remote control. See "Programming the Remote Control" on pages 51-52.
Activate the TV remote control to operate the satellite receiver or VCR	For the satellite receiver, press <b>SAT/CABLE FUNCTION</b> . For the VCR, open the outside cover, as shown on page 50. Then set the A/V slide switch to the position you programmed for the VCR.
Control satellite receiver and VCR functions with the TV remote control	See "Operating a Satellite Receiver" on page 53 and "Operating a VCR" on page 53.
Label video inputs to easily identify equipment connected to the TV	See the instructions for setting up Video Labels on pages 83-84.

## DVD Player with Component Video Connectors

For best results, use this connection if your DVD player has component video (Y, P<sub>B</sub>, P<sub>R</sub>) jacks.

### To connect a DVD player with component video connectors

- 1 Use a component video cable, or three composite video cables, to connect the DVD player's Y, P<sub>B</sub> and P<sub>R</sub> jacks to the Y, P<sub>B</sub> and P<sub>R</sub> jacks (VIDEO 5) on the TV.

 The Y, P<sub>B</sub> and P<sub>R</sub> jacks on your DVD player are sometimes labeled Y, C<sub>B</sub> and C<sub>R</sub>, or Y, B-Y and R-Y. If so, connect the cables to like colors.

- 2 Use an audio cable to connect the DVD player's audio output jacks to the TV's VIDEO 5 audio input jacks.

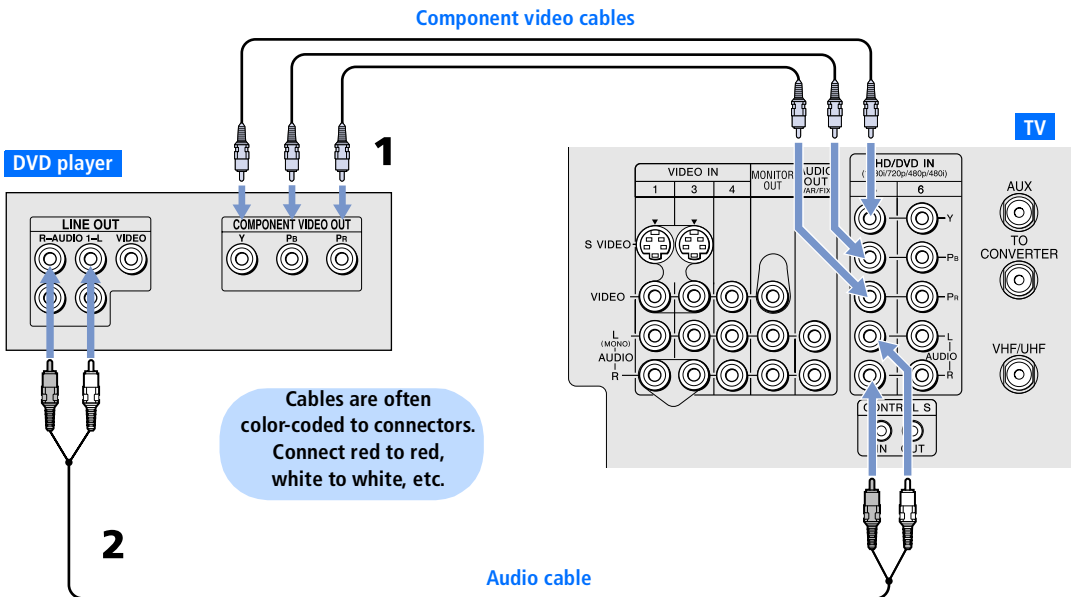

## Notes on Using This Connection

To Do This ...	Do This ...
Watch the DVD player	Press <b>TV/VIDEO</b> repeatedly to select the DVD input (VIDEO 5 in the illustration).
Set up the TV remote control to operate the DVD player	If you have a non-Sony DVD player, you must program the remote control. See "Programming the Remote Control" on pages 51-52.
Activate the TV remote control to operate the DVD player	Open the outside cover, as shown on page 50. Then set the A/V slide switch to the position you programmed for the DVD player.
Control DVD functions with the TV remote control	See "Operating a DVD Player" on page 54.
Label video inputs to easily identify equipment connected to the TV	See the instructions for setting up Video Labels on pages 83-84.

 **You cannot record the signal from any equipment connected into the Y, PB, PR jacks.**

## DVD Player with S VIDEO and Audio Connectors

Use this connection if your DVD player does not have component video (Y, PB, PR) jacks.

### To connect a DVD player with A/V connectors

- 1 Use an audio cable to connect the DVD player's audio output jacks to the TV's audio input jacks.
- 2 Use an S VIDEO cable to connect the DVD player's S VIDEO jack to the TV's S VIDEO jack.

Cables are often color-coded to connectors. Connect red to red, white to white, etc.

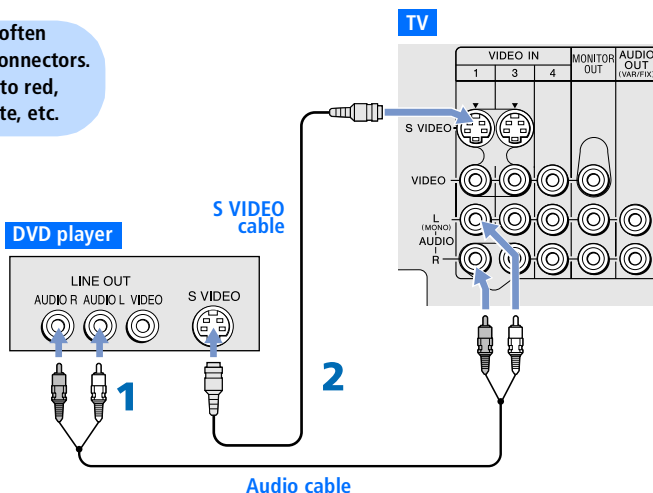

### Notes on Using This Connection

To Do This ...	Do This ...
Watch the DVD player	Press <b>TV/VIDEO</b> repeatedly to select the DVD input (VIDEO 1 in the illustration).
Set up the TV remote control to operate the DVD player	If you have a non-Sony DVD player, you must program the remote control. See "Programming the Remote Control" on pages 51-52.
Activate the TV remote control to operate the DVD player	Open the outside cover, as shown on page 50. Then set the A/V slide switch to the position you programmed for the DVD player.
Control DVD functions with the TV remote control	See "Operating a DVD Player" on page 54.
Label video inputs to easily identify equipment connected to the TV	See the instructions for setting up Video Labels on pages 83-84.

## Digital TV Set-Top Box with Component Video Connectors

To connect a digital TV set-top box with component video connectors

- 1 Use three separate component video cables to connect the DVD player's Y, PB and PR jacks to the Y, PB and PR jacks (VIDEO 5) on the TV.

 The Y, PB and PR jacks on your DVD player are sometimes labeled Y, CB and CR, or Y, B-Y and R-Y. If so, connect the cables to like colors.

- 2 Use an audio cable to connect the set-top box's audio output jacks to the TV's VIDEO 5 audio input jacks.

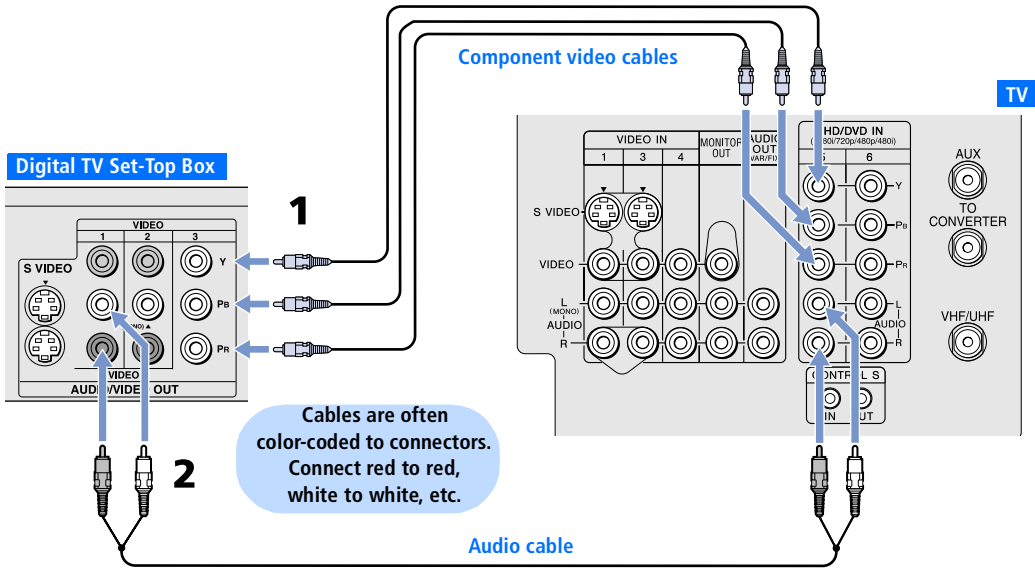

### Notes on Using This Connection

To Do This ...	Do This ...
Watch the digital TV set-top box	Press <b>TV/VIDEO</b> repeatedly to select the digital TV set-top box input (VIDEO 5 in the illustration).
Label video inputs to easily identify equipment connected to the TV	See the instructions for setting up Video Labels on pages 83-84.

 You cannot record the signal from any equipment connected into the Y, PB, PR jacks.



## Camcorder

For easy connection of a camcorder, the TV has front A/V input jacks. If you prefer, however, you can connect the camcorder to the TV's rear A/V input jacks.



Using  
S VIDEO jacks?  
See page 25.

### To connect a camcorder

- 1 Open the front video panel, as shown on page 13.
- 2 Use A/V cables to connect the camcorder's A/V output jacks to the TV's A/V input jacks.

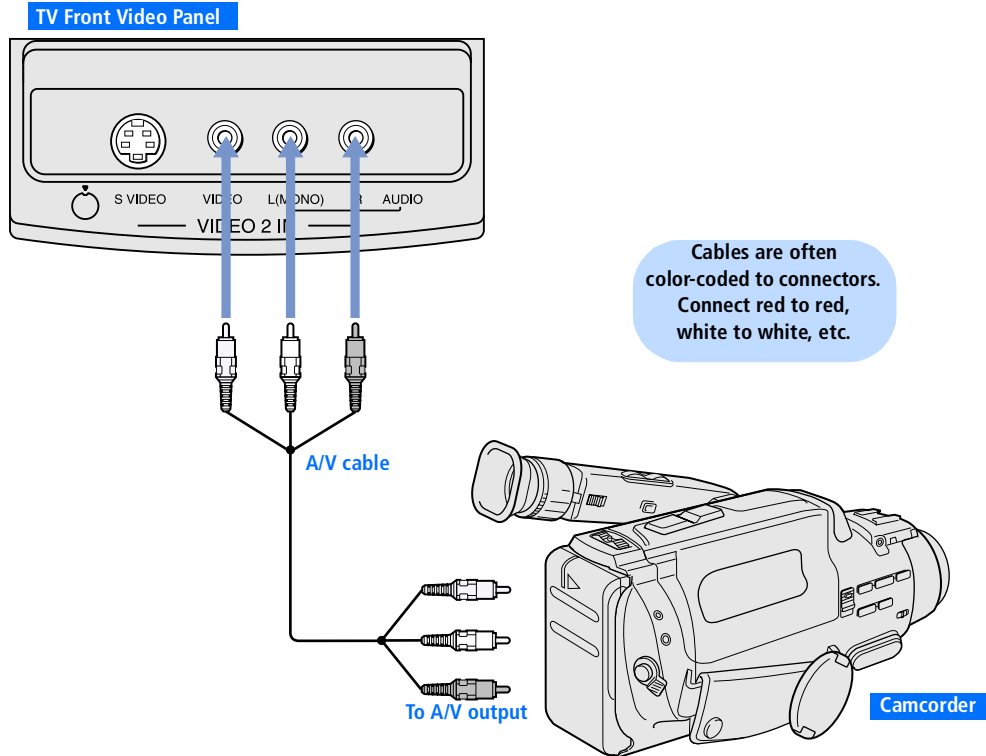

If you have a mono camcorder, connect its audio output jack to the TV's L MONO audio jack.

### Notes on Using This Connection

To Do This ...	Do This ...
Watch the camcorder	Press <b>TV/VIDEO</b> repeatedly to select the camcorder input (VIDEO 2 in the illustration).
Label video inputs to easily identify equipment connected to the TV	See the instructions for setting up Video Labels on pages 83-84.

## Audio Receiver

For improved sound quality, you may want to play the TV's audio through your stereo system.

### To connect an audio system

- 1 Use an audio cable to connect the TV's audio output jacks to the audio receiver's line input jacks.

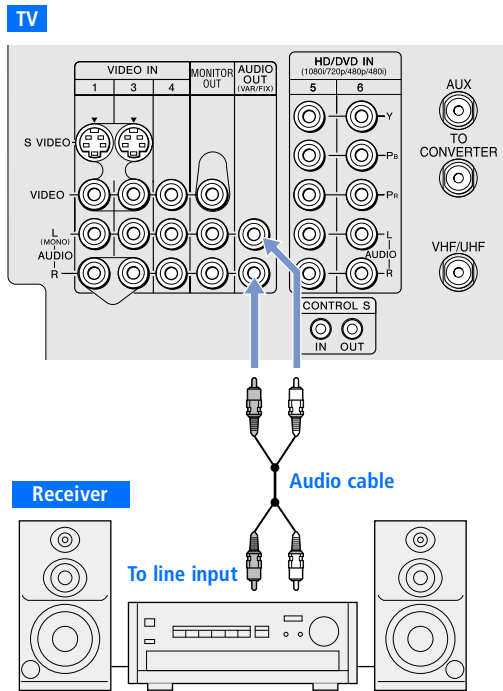

- 2 Using the TV's Audio Menu, set the **Speaker** option to **Off**. Then set the **Audio Out** option to **Fixed** or **Variable**, depending on how you want to control the volume. For details, see "Using the Audio Menu" on page 74.
- 3 Turn on the audio receiver, and then set the receiver's line input to the jack into which you connected the TV.

## Using the CONTROL S Feature

CONTROL S allows you to control your system and other Sony equipment with one remote control. In addition to allowing you to control multiple devices with one remote control, the CONTROL S feature allows you to always point your remote control at your TV, instead of having to point it at the other equipment, which might be hidden or out of direct line of sight.

Use CONTROL S IN to send signals to the TV.

Use CONTROL S OUT to send signals to connected equipment.

TV

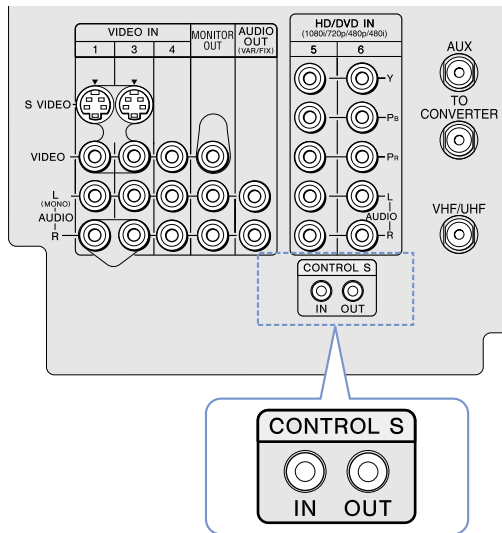

## Setting Up the Channel List

After you finish connecting your TV, you need to run Auto Setup to set up your channels. The Auto Setup screen appears when you turn on your TV for the first time after hooking it up. If you do not want to set up the channels at this time, you can do it later by selecting the Auto Program option in the Channel Menu (see page 78).

 **The Auto Setup feature does not apply for installations that use a cable box for all channel selection.**

### Using Auto Setup

- 1 Press **POWER** to turn on the TV.
- 2 Press **TV FUNCTION** on the remote control.
- 3 To continue running Auto Setup, press **CH+**. To exit Auto Setup, press **CH-**.

Auto Setup automatically creates a list of receivable channels. When finished, the lowest numbered channel is displayed.

#### To reset the TV to factory settings

- 1 Press **POWER** to turn on the TV.
- 2 Hold down **RESET** on the remote control.
- 3 Press **TV POWER** on the TV. (The TV will turn itself off, then back on.)
- 4 Release **RESET**.

## Adjusting the Convergence Automatically (Flash Focus)

The projection tube image appears on the screen in three colors (red, green and blue). If they do not converge, the color is poor and the picture blurs. Before you use your TV, be sure to adjust the convergence. The Flash Focus feature allows you to adjust the convergence automatically.

 It is recommended that you perform Flash Focus about 30 minutes after the TV is first turned on.

 You can also access Flash Focus in the Setup menu. For details, see page 85.

- 1 Tune to a TV or cable TV program.
- 2 Press the **FLASH FOCUS** button on the front panel of the TV (see pages 14-15).

The cross pattern appears and Flash Focus begins to work.

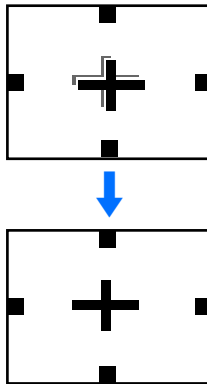

The adjustment is completed when the TV picture returns.

### To Obtain Optimum Convergence

Whenever you find that the picture blurs, press **FLASH FOCUS**.

 You cannot perform any other functions until Flash Focus has completed its cycle. If you perform any other operation while Flash Focus is in progress, the Flash Focus operation is canceled.

### To Perform Additional Fine Manual Adjustments

- Use the Convergence feature, described on page 45.

## Adjusting the Convergence Manually

The Convergence feature gives you more control over the picture's convergence than the Flash Focus feature, allowing you to fine-tune the convergence.

 Before using the manual Convergence, you must first perform Flash Focus (as described on page 44).

 For details on using the Setup Menu, see page 83.

- 1 Press **MENU** to display the Menu.
- 2 Move the joystick **←** or **→** to highlight the Setup icon and press **⊕**.
- 3 Move the joystick to highlight **Convergence** and press **⊕**.

A pattern of white crosses appears, with a yellow **[+]** around one of the crosses. Aligned crosses (which do not need adjustment) look white and have little or no red or blue showing. Crosses that are not aligned show red or blue shades beyond their edges.

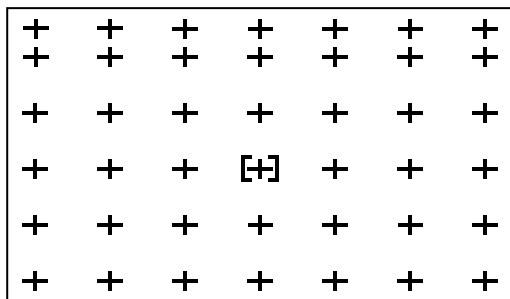

You can scroll up and down through the 9 x 7 field of crosses to manually converge all portions of the screen.

- 4 Using the joystick, move the **[+]** to surround a cross that you want to adjust. Press **⊕**. The **[+]** changes to red.
- 5 If the cross that you selected has red edges, move the joystick until the red image is replaced with a white cross. Once you have finished this (or the cross does not have red edges), press **⊕**. The **[+]** changes to blue.
- 6 If the cross you selected has blue edges, move the joystick until the blue image is replaced with a white cross. Once you have finished this, press **⊕**. The **[+]** changes to yellow again.
- 7 Repeat steps 4 to 6 to adjust other crosses. When finished, press **MENU** to exit the Setup Menu.

---

## **Notes on Adjusting the Convergence Manually**

- ❑ For best results, stand about 3 to 5 feet back from the picture when adjusting the convergence. Begin with the crosses in the center area of the screen and, once those are adjusted, move to the crosses on the edges of the screen.
- ❑ You can make separate adjustments to each wide mode: Full/Normal, Zoom, Wide Zoom, and Memory Stick/1080i high-definition input. (These features share a common convergence mode.) The cross pattern looks different in each of these, but the adjustment procedure is the same. Press the **WIDE MODE** button on the remote to toggle through the wide mode screens.
- ❑ To optimize the conditions for convergence adjustment, in the Video Menu, set **Mode** to **Pro** or **Movie** and lower the **Picture** level settings (see page 72). You can reset the adjustments by pressing the **RESET** button on the remote control.

# Using the Remote Control

## Overview

This chapter describes how to set up, program, and use the TV's remote control.

Topic	Page
Inserting Batteries	47
Button Descriptions	
Outside Panel	48
Inside Panel	50
Programming the Remote Control	51

## Inserting Batteries

- 1 Remove the battery cover from the remote control.
- 2 Insert two size AA (R6) batteries (supplied) by matching the **+** and **-** terminals on the batteries to the diagram inside the battery compartment.
- 3 Replace the battery cover.

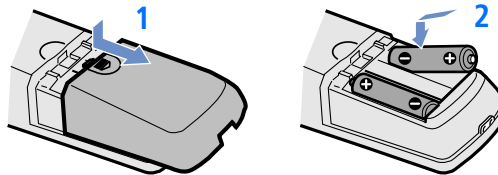

 Remove the batteries to avoid damage from possible battery leakage whenever you anticipate that the remote control will not be used for an extended period.

Handle the remote control with care.

Avoid dropping it, getting it wet, placing it in direct sunlight, near a heater, or where the humidity is high.





# Button Descriptions

## Outside Panel

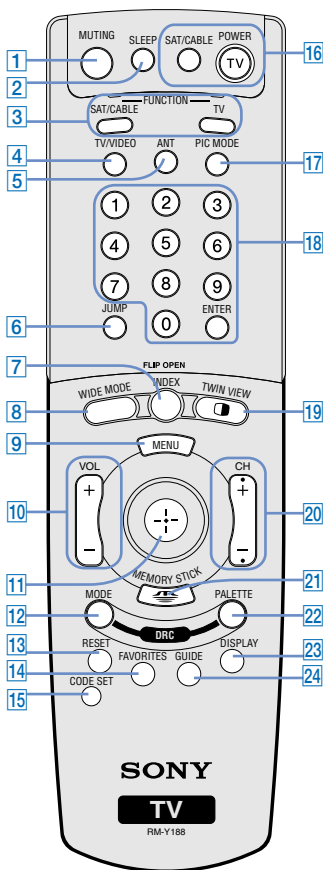
Remote Control



Button	Description
<b>1</b> MUTING	Press to mute the sound. Press again or press <b>VOL+</b> to restore the sound.
<b>2</b> SLEEP	Press repeatedly until the TV displays the time in minutes (15, 30, 45, 60, or 90) that you want the TV to remain on before shutting off automatically. To cancel press until <b>Sleep Off</b> appears. While the Sleep feature is set, press once to display the remaining time.
<b>3</b> FUNCTION Buttons	The indicator lights up momentarily when pressed to show which equipment the remote control is operating: <b>SAT/CABLE:</b> Press to have the remote control operate the satellite receiver or cable box. <b>TV:</b> Press to have the remote control operate the TV.
<b>4</b> TV/VIDEO	Press repeatedly to cycle through the video equipment connected to the TV's video inputs.
<b>5</b> ANT	Press to switch between the sources connected to the TV's VHF/UHF and AUX inputs.
<b>6</b> JUMP	Press to jump back and forth between two channels. The TV alternates between the current channel and the last channel that was selected.
<b>7</b> INDEX	Press to display the Scrolling Index. For details, see page 57.
<b>8</b> WIDE MODE	Press repeatedly to step through the Wide Mode settings: <b>Wide Zoom</b> , <b>Normal</b> , <b>Full</b> , <b>Zoom</b> . Also available in the Screen menu. For details, see pages 58 and 76.
<b>9</b> MENU	Press to display the Menu. Press again to exit from the Menu. For details, see page 71.
<b>10</b> VOL +/-	Press to adjust the volume.
<b>11</b> 	Move the joystick <b>▲</b> <b>▼</b> <b>◀</b> <b>▶</b> to move the on-screen cursor. To select an item, press the center of the joystick ( <b>⊕</b> ).
<b>12</b> DRC MODE	Press repeatedly to cycle through the available high-resolution picture modes: <b>Interlaced</b> , <b>Progressive</b> , <b>CineMotion</b> . Also available in the Video Menu. For details, see "Selecting Video Options" on pages 72-73.
<b>13</b> RESET	Press to reset the settings to the factory defaults. See pages 72 and 74. Also used to clear Favorite Channels (see page 62).
<b>14</b> FAVORITES	Press to display the Favorite Channels list. For details, see page 62.

<i>Button</i>	<i>Description</i>
<b>15</b> CODE SET	Press to program the remote control to operate non-Sony video equipment. For details, see "Programming the Remote Control" on page 51.
<b>16</b> POWER Buttons	<b>SAT/CABLE*</b> : Press to turn on and off the satellite receiver or cable box. <b>TV</b> : Press to turn on and off the TV.
<b>17</b> PIC MODE	Press repeatedly to cycle through the available video picture modes: <b>Vivid</b> , <b>Standard</b> , <b>Movie</b> , <b>Pro</b> . Also available in the Video Menu. For details, see "Selecting Video Options" on pages 72-73.
<b>18</b> 0 - 9 ENTER	Press <b>0 - 9</b> to select a channel; the channel changes after 3 seconds. Press <b>ENTER</b> to change channels immediately.
<b>19</b> TWIN VIEW 	Press to turn on and off Twin View. For details, see pages 59-61.
<b>20</b> CH +/-	Press to scan through channels. To scan quickly through channels, press and hold down either <b>CH</b> button.
<b>21</b> MEMORY STICK 	Press to display the Memory Stick Menu. For details, see "Using the Memory Stick Picture Viewer" on page 64.
<b>22</b> DRC PALETTE	Press repeatedly to cycle through the three Custom DRC Palette options. Also available in the Video Menu. For details, see "Selecting Video Options" on pages 72-73.
<b>23</b> DISPLAY	Press once to display the current channel number, current time, and channel label (if set). Press again to turn Display off.
<b>24</b> GUIDE*	Press to display the program guide of your satellite program provider.

\* Requires that you first program the remote control (page 51), if not Sony brand.

## Inside Panel

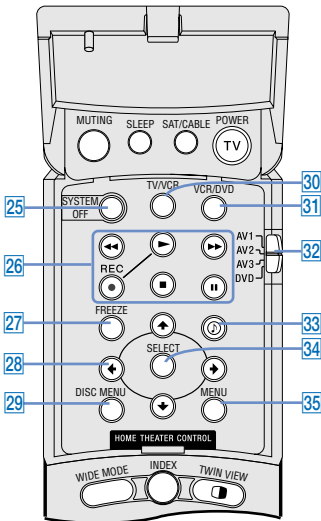
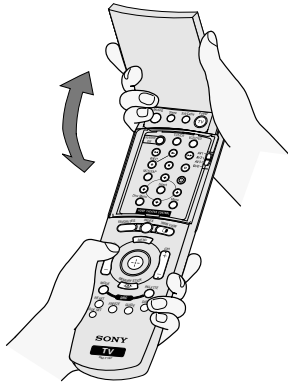

To access the inside panel, open the outside cover as shown.

Opening the outside cover automatically switches the remote control to operate your VCR or DVD player, depending on the position of the A/V slide switch. For details, see page 51.

VCR and DVD buttons require that you first program the remote (page 51), if the VCR and DVD player are not Sony brand.

Button	Description
<b>25</b> SYSTEM OFF	Press to turn off all Sony brand audio/video equipment at once. (May not function with older Sony equipment.)
<b>26</b> Transport Buttons	<ul style="list-style-type: none"> <li>◀◀ Rewind</li> <li>▶ Play</li> <li>● Record (press together with ▶)</li> <li>■ Stop</li> <li>▶▶ Fast forward</li> <li>   Pause</li> </ul>
<b>27</b> FREEZE	Press to freeze the picture. Press again to restore the picture. For details, see “Using the Freeze Function” on page 63.
<b>28</b> ⬆ ⬇ ⬅ ➡	Press ⬆ ⬇ ⬅ ➡ to move the VCR or DVD player’s on-screen cursor.
<b>29</b> DISC MENU	Press to display the DVD Menu.
<b>30</b> TV/VCR	Press to change to the VHF/UHF output of the VCR.
<b>31</b> VCR/DVD	Press to turn on and off the VCR or DVD player.
<b>32</b> AV1/2/3/DVD Slide Switch	Use the A/V slide switch to control connected video equipment. You can program one video source for each switch position. For details, see “Programming the Remote Control” on page 51.
<b>33</b>	Press repeatedly to step through the Audio Effect options. Also available in the Audio Menu. For details, see page 74.
<b>34</b> SELECT	Press to select an item in the VCR or DVD player’s menu.
<b>35</b> MENU	Press to display the DVD player setup menu.

# Programming the Remote Control

The remote control is preset to operate Sony brand video equipment.

Sony Equipment	Switch Position on Remote Control	Programmable Code Number
Beta, Ed Beta VCRs	AV1	303
8 mm VCR	AV2	302
VHS VCR	AV3	301
DVD player	DVD	751

If you have video equipment other than Sony brand that you want to control with the TV's remote control, use the following procedure to program the remote control.

**The equipment must have infrared (IR) remote capability in order to be used with the remote control.**

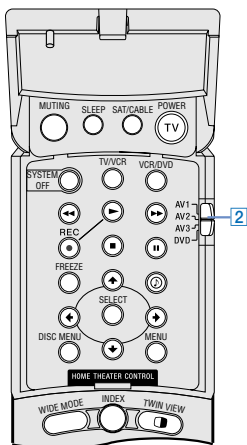

- 1 Turn to the list of "Manufacturer's Codes" on page 52, and find the three-digit code number for the manufacturer of your equipment. (If more than one code number is listed, use the number listed first.)
- 2 Open the remote control and set the A/V slide switch to 1, 2, 3, or DVD.
- 3 Press **CODE SET**.
- 4 Enter the three-digit manufacturer's code number.
- 5 Press **ENTER**.

**You must do step 5 within 10 seconds of step 4, or you must redo steps 3 through 5.**

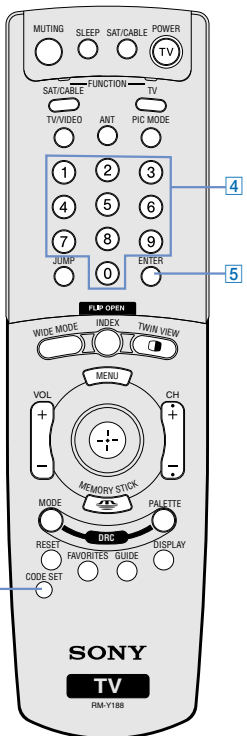

- 6 To check if the code number works, aim the TV's remote control at the equipment and press the **POWER** button that corresponds with that equipment. If it responds, you are done. If not, try using another code listed for that manufacturer.

### Notes

- ❑ If more than one code number is listed, try entering them one by one until you come to the correct code for your equipment.
- ❑ If you enter a new code number, the code number you previously entered at that setting is erased.
- ❑ In some cases, you may not be able to operate your equipment with the supplied remote control. In such cases, use the equipment's own remote control unit.
- ❑ Whenever you remove the batteries to replace them, the code numbers may revert to the factory setting and must be reset.

## Manufacturer's Codes

### VCRs

<i>Manufacturer</i>	<i>Code</i>
Sony	301, 302, 303
Admiral (M. Ward)	327
Aiwa	338, 344
Audio	314, 337
Dynamic	
Broksonic	319, 317
Canon	309, 308
Citizen	332
Craig	302, 332
Criterion	315
Curtis Mathes	304, 338, 309
Daewoo	341, 312, 309
DBX	314, 336, 337
Dimensia	304
Emerson	319, 320, 316, 317, 318, 341
Fisher	330, 335
Funai	338
General Electric	329, 304, 309
Go Video	322, 339, 340
Goldstar	332
Hitachi	306, 304, 305, 338
Instant Replay	309, 308
JC Penney	309, 305, 304, 330, 314, 336, 337
JVC	314, 336, 337, 345, 346, 347
Kenwood	314, 336, 332, 337
LXI (Sears)	332, 305, 330, 335, 338
Magnavox	308, 309, 310
Marantz	314, 336, 337
Marta	332
Memorex	309, 335
Minolta	305, 304
Mitsubishi/ MGA	323, 324, 325, 326
Multitech	325, 338, 321
NEC	314, 336, 337
Olympic	309, 308
Optimus	327

<i>Manufacturer</i>	<i>Code</i>
Orion	317
Panasonic	308, 309, 306, 307
Pentax	305, 304
Philco	308, 309
Philips	308, 309, 310
Pioneer	308
Quasar	308, 309, 306
RCA/ PROSCAN	304, 305, 308, 309, 311, 312, 313, 310, 329
Realistic	309, 330, 328, 335, 324, 338
Sansui	314
Samsung	322, 313, 321
Sanyo	330, 335
Scott	312, 313, 321, 335, 323, 324, 325, 326
Sharp	327, 328
Signature 2000 (M. Ward)	338, 327
SV2000	338
Sylvania	308, 309, 338, 310
Symphonic	338
Tashiro	332
Tatung	314, 336, 337
Teac	314, 336, 338, 337
Technics	309, 308
Toshiba	312, 311
Wards	327, 328, 335, 331, 332
Yamaha	314, 330, 336, 337
Zenith	331

### Laserdisc Players

<i>Manufacturer</i>	<i>Code</i>
Sony	701
Panasonic	704, 710
Pioneer	702

### DVD Players

<i>Manufacturer</i>	<i>Code</i>
Sony	751
General Electric	755
Hitachi	758
JVC	756
Magnavox	757
Mitsubishi	761
Oritron	759
Panasonic	753
Philips	757
Pioneer	752
RCA/Proscan	755
Samsung	758
Toshiba	754
Zenith	760

### Cable Boxes

<i>Manufacturer</i>	<i>Code</i>
Sony	230
Hamlin/Regal	222, 223, 224, 225, 226
Jerrold/G. I.	201, 202, 203, 204, 205, 206, 207, 208, 218
Oak	227, 228, 229
Panasonic	219, 220, 221
Pioneer	214, 215
Scientific	209, 210, 211
Atlanta	
Tocom	216, 217
Zenith	212, 213

### Satellite Receivers

<i>Manufacturer</i>	<i>Code</i>
Sony	801
Dish Network	810
Echostar	810
General Electric	802
Hitachi	805
Hughes	804
Mitsubishi	809
Panasonic	803
RCA/ PROSCAN	802, 808
Toshiba	806, 807

# Using Other Equipment with Your TV Remote Control

## All Equipment

To Do This ...	Do This ...
Switch the TV's input to the VCR, DVD player, or other connected equipment	Press <b>TV/VIDEO</b> repeatedly to cycle through the video equipment connected to the TV's video inputs.
Set up the TV remote control to operate non-Sony equipment	You must program the remote control the first time you use it. See "Programming the Remote Control" on pages 51 to 52.

## Operating a VCR

To Do This ...	Press
Activate the remote control to operate the VCR	Open the outside cover, as shown on page 50. Then set the A/V slide switch to the position you programmed for the VCR.
Change channels	<b>CH +/-</b>
Record	<b>▶</b> and <b>●</b> simultaneously
Play	<b>▶</b>
Stop	<b>■</b>
Fast forward	<b>▶▶</b>
Rewind the tape	<b>◀◀</b>
Pause	<b>  </b>
Search the picture forward or backward	<b>▶▶</b> or <b>◀◀</b> during playback (release to resume normal playback)
Change input mode	<b>TV/VCR</b>

## Operating a Satellite Receiver

To Do This ...	Press
Activate the remote control to operate the satellite receiver	<b>SAT/CABLE FUNCTION</b>
Turn on/off	<b>SAT/CABLE POWER</b>
Select a channel	<b>0-9, ENTER</b>
Change channels	<b>CH +/-</b>
Back to previous channel	<b>JUMP</b>
Display channel number	<b>DISPLAY</b>
Display SAT Guide	<b>GUIDE</b>
Display SAT Menu	<b>MENU</b>
Move highlight (cursor)	Move the joystick <b>▲ ▼ ◀ ▶</b>
Select item	<b>⊕</b>

## Operating a Cable Box

To Do This ...	Press
Activate the remote control to operate the cable box	SAT/CABLE FUNCTION
Turn on/off	SAT/CABLE POWER
Select a channel	0-9, ENTER
Change channels	CH +/-
Back to previous channel	JUMP

## Operating a DVD Player

To Do This ...	Press
Activate the remote control to operate the DVD	Open the outside cover, as shown on page 50. Then set the A/V slide switch to the position you programmed for the DVD player.
Play	▶
Stop	■
Pause	⏸
Step through different tracks of the disc	▶▶ to step forward or ◀◀ to step backward
Step through different chapters of a video disc	CH+ to step forward or CH- to step backward
Display the DVD player Menu (Setup)	MENU (inside panel)
Display the DVD Menu	DISC MENU
Move highlight (cursor)	⬆ ⬇ ⬅ ➡
Select item	SELECT

## Operating an MDP (Laserdisc Player)

To Do This ...	Press
Activate the remote control to operate the MDP	Open the outside cover, as shown on page 50. Then set the A/V slide switch to the position you programmed for the MDP player.
Play	▶
Stop	■
Pause	⏸
Search the picture forward or backward	▶▶ or ◀◀ during playback (release to resume normal playback)
Search a chapter forward or backward	CH +/-

# Using the Features

## Overview

This chapter describes how to use the features of your TV.

<i>Topic</i>	<i>Page</i>
Watching TV	56
Using the Scrolling Index	57
Using Wide Mode	58
Using Twin View	59
Using Favorite Channels	62
Using the Freeze Function	63
Using the Memory Stick Picture Viewer	64



## Watching TV

 For a complete list of all the functions of the remote control, see pages 47-52.

To Do This ...	Do This ...
Activate the remote control to operate the TV	Press <b>TV FUNCTION</b>
Turn on/off the TV	Press <b>TV POWER</b>
Tune directly to a channel	Press <b>0-9</b> and then <b>ENTER</b> (or wait 3 seconds) or Press <b>CH+/-</b>
Adjust the volume	Press <b>VOL +/-</b>
Mute the volume	Press <b>MUTING</b> (press again to unmute)
Alternate back and forth between two channels	Press <b>JUMP</b> The TV alternates between the current channel and the last channel tuned.
Display the current channel number (and other information)	Press <b>DISPLAY</b> once to display the channel number, current time, and channel label (if set). Press <b>DISPLAY</b> again to turn Display off.
Switch the TV's input to the VCR, DVD player, or other connected equipment	Press <b>TV/VIDEO</b> repeatedly to cycle through the video equipment connected to the TV's video inputs.
Change video and audio options, customize the TV's setup, set parental controls, and more	Press <b>MENU</b> to display the Menu. For details, see "Using the Menus" on page 71.
Switch the TV's input between sources connected to the TV's VHF/UHF and AUX inputs	Press <b>ANT</b> to alternate between sources connected to the TV's VHF/UHF and AUX inputs.

## Using the Scrolling Index

The Scrolling Index lets you select programs from a scrolling index of video pictures.

- 1 Press **INDEX**.

The Scrolling Index appears, with the currently selected program in the main (left) window, and four scrolling video pictures in the right.



As each picture on the right scrolls to the live preview window, it changes briefly from a frozen video picture to a live video. The right side continues to scroll through the entire channel list.

- 2 To change the direction of the scrolling, move the joystick **▲** or **▼**.
- 3 To change the speed of the scrolling, move and hold the joystick **▲** or **▼**.
- 4 To change a frozen video picture to a live video, move the joystick **▲** or **▼** to highlight the picture, then press **⊕**.
- 5 To move the live video (from step 4 ) from the right to the main (left) window of the Scrolling Index, press **⊕** again.

### To exit the Scrolling Index

- ❑ Press **INDEX**.

### Factors Affecting Scrolling Index

- ❑ Scrolling Index feature does not function if you use a cable box to view all channels.
- ❑ Sources connected to the AUX, VIDEO 5, VIDEO 6, and VIDEO 7 inputs display in the left window, but not the right windows.
- ❑ Scrolling Index does not function if parental controls are set (see page 80).

## Using Wide Mode

Wide Screen mode lets you watch 4:3 normal broadcasts in several Wide Screen modes (16:9 aspect ratio).

 When viewing high-definition programs broadcast in 720p/1080i, it is not possible to change between Wide Screen modes.

 You can also access the Wide Mode settings in the Screen menu. For details, see page 76.

 When you change channels or inputs, the Wide Mode settings revert to the 4:3 Default setting in the Screen menu. To retain the current Wide Mode setting as channels and inputs are changed, set 4:3 Default to Off. For details, see page 77.

- Press **WIDE MODE** repeatedly to toggle through the following Wide Mode settings.



Wide Zoom

Wide Zoom enlarges the 4:3 picture, while the upper and lower parts of the picture are condensed to fit the 16:9 screen.



Normal

Normal returns the 4:3 picture to its original size.



Full

Full Mode stretches the 4:3 picture horizontally only, to fill the 16:9 screen.



Zoom

Zoom Mode enlarges the 4:3 picture horizontally and vertically to an equal aspect ratio that fills the 16:9 screen. Useful for watching Letterbox movies.

## Using Twin View

Twin View lets you see two pictures from two sources — from an antenna, VCR, DVD, etc. — on the screen at the same time. You hear the sound from only one of the sources at a time, but you can choose which source's sound is selected. You can also change the relative size of each of the pictures.



### Displaying Twin Pictures

- 1 Tune the TV to a working channel.
- 2 Press .

A second picture appears. The active picture is highlighted in blue.



To cancel Twin View and watch the active picture

- Press  or .

### Factors Affecting Twin View

- If you use a cable box to view all channels, the same channel appears in both windows because the cable box unscrambles only one channel at a time.
- If you use a cable box, you can view the cable box output in one window and view a different source (such as a VCR or DVD player) in the second window by using the [TV/VIDEO](#) button. For details, see “Connecting Optional Equipment” on page 25.
- Sources connected to the AUX, VIDEO 5, VIDEO 6, and VIDEO 7 inputs display in the left window, but not the right.
- If you are viewing a 4:3 source and a 16:9 enhanced source (such as a DVD) side by side, the 4:3 source appears larger.
- Twin View does not display channels that are blocked by parental settings (see page 80).

## Activating the Picture

To activate the picture in the right window

- Move the joystick ➔.



To activate the picture in the left window

- Move the joystick ➜.

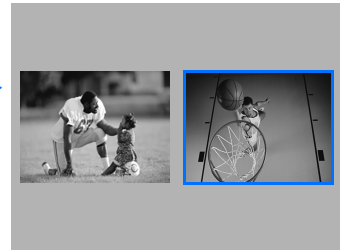

### Functions Available in the Active (Highlighted) Window

To Do This ...	Do This ...
Tune to a channel	Press <b>0-9</b> and then <b>ENTER</b> (or wait 3 seconds) or Press <b>CH+/-</b>
Adjust the volume	Press <b>VOL +/-</b>
Mute the volume	Press <b>MUTING</b> (press again to unmute)
Switch the TV's input between sources connected to the TV's VHF/UHF and AUX inputs	Press <b>ANT</b> (left window only)
Switch the TV's input between sources connected to the TV's A/V inputs	Press <b>TV/VIDEO</b>
Change the picture size	Move the joystick <b>▲</b> or <b>▼</b> . (For details, see "Changing the Picture Size" on page 61.)

## Changing the Picture Size

The zoom feature lets you vary the relative size of the left and right pictures.

- 1 Move the joystick **←** or **→** to activate the picture that you want to resize.
- 2 Move the joystick **▲** to enlarge the picture.
- 3 Move the joystick **▼** to make the picture smaller.

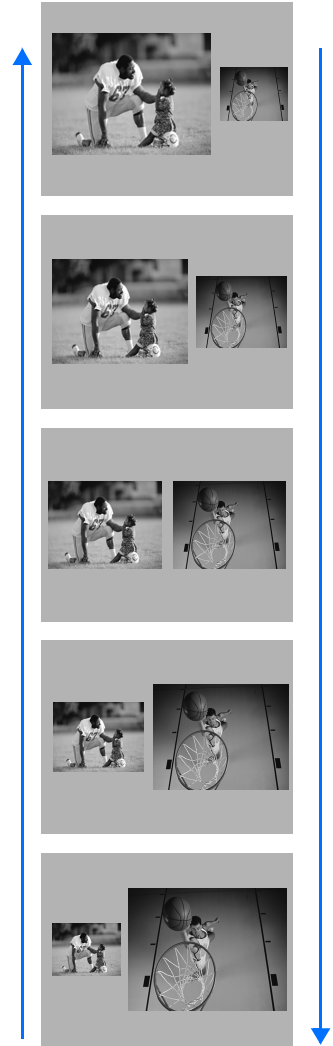

When you adjust the picture sizes, the TV memorizes the change. The next time you use the Twin View function, the memorized sizes appear.

## Using Favorite Channels

The Favorite Channels feature lets you select programs from a list of up to eight favorite channels that you specify.

### Creating a List of Favorite Channels

 For details on using the Channel Menu, see page 78.

- 1 Press **MENU** to display the Menu.
- 2 Move the joystick **←** or **→** to highlight the Channel icon and press **⊕**.
- 3 Press **⊕** to select **Favorite Channels**.
- 4 Move the joystick **▲** or **▼** to highlight a Favorite Channel number (1-8) and press **⊕**.
- 5 Move the joystick **▲** or **▼** to highlight a channel you want to assign to the Favorite Channel number. A preview of the highlighted channel appears in the upper right of the screen. Press **⊕** to select that channel as a Favorite Channel.
- 6 To add more channels to your favorites list, repeat steps 4-5. To clear a Favorite Channel, move the joystick **▲** or **▼** to highlight the channel you want to clear. Press **⊕** and then press **RESET**.
- 7 Press **MENU** to exit the Menu.

### Displaying a List of Favorite Channels

 To assign Channel Labels (e.g., ABC, HBO, MTV, etc.) to channel numbers, as shown at right, use the Channel Label feature in the Channel Menu (see page 79).

- 1 Press **FAVORITES**. The Favorite Channels list appears.

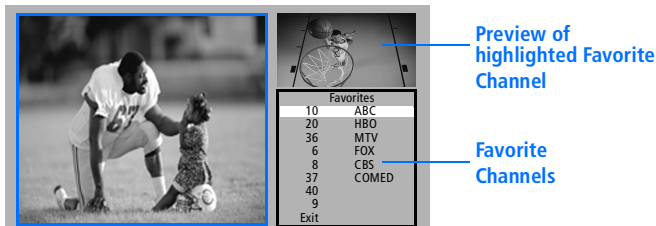

- 2 Move the joystick **▲** or **▼** to highlight the channel you want to watch. A preview of the highlighted Favorite Channel appears.
- 3 Press **⊕** to select the channel you want to watch.

## Using the Freeze Function

The **FREEZE** button allows you to temporarily capture a program's picture. You can use this feature to write down information such as phone numbers, recipes, etc.

 **The Freeze feature is not available while you are using the Twin View or Scrolling Index features.**

- 1 When the program information you want to capture is displayed, press **FREEZE**.
- 2 The TV switches to Twin View mode and displays the "frozen" picture on the right, while the current program continues on the left.

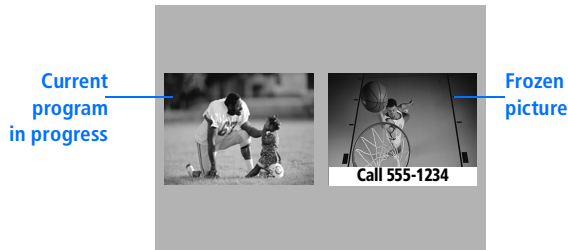

- 3 To cancel and return to normal viewing, press **FREEZE** (or just tune to another channel).



# Using the Memory Stick Picture Viewer

## About Memory Stick

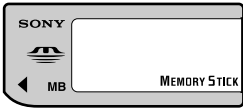

Memory Stick (sold separately) is a new, compact, portable, and versatile Integrated Circuit recording medium with a data capacity that exceeds that of a floppy disk. Memory Stick is specially designed for exchanging and sharing digital data among Memory Stick compatible products such as digital cameras and digital video cameras. Because it is removable, Memory Stick can also be used for external data storage.

 **You cannot write to Memory Stick media using the TV.**

Memory Stick technology allows you to view on your TV screen digital (jpeg) images that are stored on Memory Stick media. You can choose from an index of the images stored on the Memory Stick, or you can run a slideshow of those images. You can also customize the features of the slideshow by selecting the length of time that each image is displayed, toggling the display of file information, and rotating each image.

For more information about the using Memory Stick media, see “Notes on Using Memory Stick Media” on page 89.

## Supported Image Types

This TV’s Memory Stick viewer can display only still images that have been recorded on Memory Stick media by Sony brand digital still and video cameras.

 **The TV’s Memory Stick viewer is compatible with Memory Sticks up to and including 128MB. It is not compatible with Memory Sticks that exceed 128MB.**

Recorded images must also meet the following specifications:

- Compression format: JPEG
- File name format: DCF compliant

 **JPEG stands for “Joint Photographic Experts Group,” which is the organization that implemented this format. DCF stands for “Design Rules for Camera File Systems,” which are specifications established by the Japan Electronic Industry Development Association (JEIDA).**

### About DCF File Names

Most Sony brand digital still and video cameras automatically record still images using DCF compliant directory and file names, as shown in the following example:

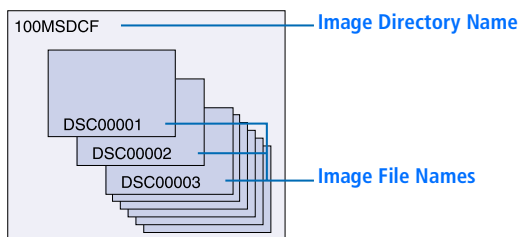

 **Do not rename directories. If the names are changed, the still images cannot be displayed on your TV.**

## Unsupported Image Types

This TV's Memory Stick viewer cannot display any of the following:

- Images recorded on digital still cameras and digital video cameras that are not Sony brand
- Images recorded using products that are not DCF compliant, including the following Sony products:

Digital still cameras	DSC-D700, DSC-D770
Digital video cameras	DCR-TRV900/DSR-PD100A

- Images stored on a Memory Stick that has a capacity that exceeds 128MB
- Images stored in TIFF or any other non-JPEG compression format
- Images in directories that were modified or renamed on a computer
- Images with less than 16 horizontal and/or vertical lines per dot
- Images with more than 4096 horizontal and/or vertical lines per dot
- Movie clips

## Inserting and Removing a Memory Stick

### To insert a Memory Stick

- 1 Locate the Memory Stick slot (see pages 14-15) and insert the Memory Stick into the Memory Stick slot as illustrated below. When inserted properly, it should slide in with little resistance and click into place.

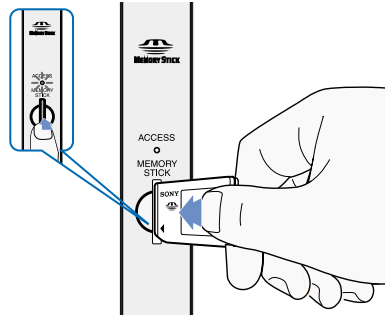

-  **Be sure to insert the Memory Stick in the correct direction. If the Memory Stick is forced in the wrong way, it may become damaged.**
- Insert only Memory Stick media into the Memory Stick slot. Attempting to insert other objects into the slot may damage the TV.**

### To remove a Memory Stick

- 1 Check that the Memory Stick indicator is off. (When the light is on, this indicates that the TV is reading data from the Memory Stick.)
- 2 Push the Memory Stick gently into the slot, and then release it. The Memory Stick media is ejected.

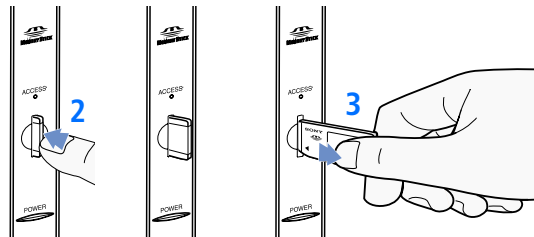

- 3 Pull the Memory Stick completely out of the slot.

-  **To protect small children from injury from Memory Stick Media, remove all Memory Stick media from the TV's Memory Stick slot and store it in a safe location when it is not in use.**

-  When removing the Memory Stick, do not attempt to just pull it from its slot. Follow steps 1-3 (right).

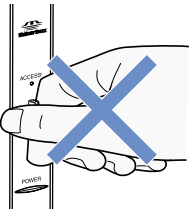

## Displaying the Memory Stick Menu

- 1 Insert a Memory Stick that contains the images you want to view. For details, see page 66.
- 2 Press the **MEMORY STICK** button on the remote control. The Memory Stick Menu appears.

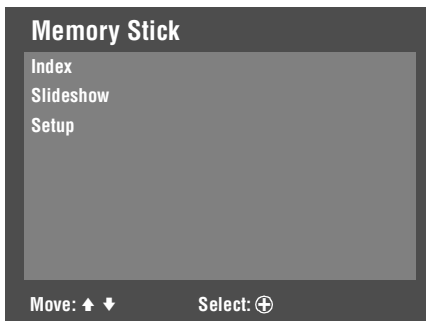

- 3 To select an option, move the joystick **↑** or **↓** to highlight the option and press **⊕**.

<i>Option</i>	<i>Description</i>
<a href="#">Index</a>	Displays an index of thumbnail images that are on the Memory Stick. For details, see “Using the Memory Stick Index” on page 68.
<a href="#">Slideshow</a>	Displays a slideshow of images that are on the Memory Stick. For details, see “Using the Memory Stick Slideshow” on page 69.
<a href="#">Setup</a>	Allows you to change slideshow options and rotate images. For details, see “Changing the Memory Stick Setup Options” on page 69.

- 4 To exit the Memory Stick Menu, press **CH +/-**, **TV/VIDEO**, **ANT**, or use the **0-9** buttons and **ENTER** (or wait 3 seconds) to select a channel.



 **Memory Stick functions are not available while using Twin View, Freeze or Favorite Channel functions.**

## Using the Memory Stick Index

The Memory Stick Index lets you view images that are on the Memory Stick in an index of thumbnail images.

 There is no audio signal available while viewing images on Memory Stick.

- 1 Insert a Memory Stick that contains the images you want to view. For details, see page 66.
- 2 Press the **MEMORY STICK** button on the remote control. The Memory Stick Menu appears.
- 3 Move the joystick to highlight **Index** and press **⊕**. The Memory Stick Index appears.

 The Page and folder  buttons are available only if the Memory Stick contains more images or folders than can be displayed on one screen.



The selected image is highlighted in yellow

Information about the selected image

- 4 Move the joystick **↑ ↓ ← →** to highlight an image and press **⊕** to select the image. Selecting an image displays that image at full size. While an image is displayed full size, you can do any of the following:

To Do This ...	Do This ...
Display the previous image	Move the joystick <b>←</b> .
Display the next image	Move the joystick <b>→</b> . If you move the joystick <b>→</b> while viewing the last image, the first image is displayed. If you move the joystick <b>←</b> while viewing the first image, the last image is displayed.
Display the Memory Stick Index	Press <b>⊕</b> .

- 5 To return to the Memory Stick Menu, move the joystick to **Menu** and press **⊕**.

 If a blank square appears instead of a thumbnail image, this indicates that the image does not support a thumbnail view. Selecting the icon, however, displays the full-size image on the screen. It could also indicate that both the thumbnail and full-size images are corrupted or not supported.

 Larger images will take longer to display on screen.

## Using the Memory Stick Slideshow

The Memory Stick Slideshow lets you watch a slideshow of the images that are on the Memory Stick.

- 1 Insert a Memory Stick that contains the images you want to view. For details, see page 66.
- 2 Press the **MEMORY STICK** button on the remote control. The Memory Stick Menu appears.
- 3 Move the joystick to highlight **Slideshow** and press **⊕**. The slideshow starts.
- 4 To end the slideshow, press **⊕**. The Memory Stick Menu is displayed.

## Changing the Memory Stick Setup Options

- 1 Press the **MEMORY STICK** button on the remote control. The Memory Stick Menu appears.
- 2 Move the joystick to highlight **Setup** and press **⊕**. The Memory Stick Setup Menu appears.

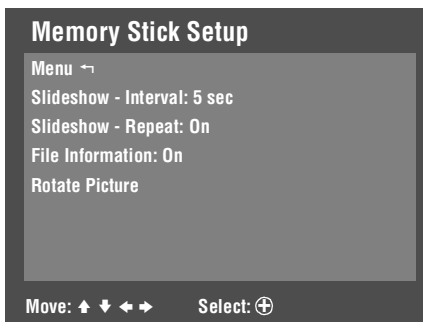

- 3 Move the joystick to highlight an option and press **⊕**.

Option	Description
<b>Menu</b>	Returns to the Memory Stick Menu.
<b>Slideshow – Interval</b>	Decrease or increase the length of time that each image is displayed: 5 seconds, 10 seconds, 1 minute, 5 minutes, or 15 minutes.
<b>Slideshow – Repeat</b>	Select <b>On</b> to set the slideshow to repeat after displaying all the images recorded on the Memory Stick. Select <b>Off</b> to not repeat the slideshow.
<b>File Information</b>	Select <b>On</b> to show file information of each image while that image is being displayed.
<b>Rotate Picture</b>	Displays the Rotate Picture screen. For details, see “Using the Rotate Picture Screen” on page 70.

- 4 Move the joystick **→** (or press **⊕**) to change settings. Move the joystick **←** (or press **⊕**) to select the changed setting.
- 5 To exit the Memory Stick Setup Menu, move the joystick to **Menu** and press **⊕**.

## Using the Rotate Picture Screen

The Rotate Picture Screen lets you rotate an image from an index of thumbnails.

 You cannot rotate images if the LOCK switch on the Memory Stick is on. To rotate the images, first set the LOCK switch to off.

 The Page and folder (📁) buttons are available only if the Memory Stick contains more images or folders than can be displayed on one screen.

- 1 In the Memory Stick Setup Menu, move the joystick to highlight **Rotate Picture** and press **⊕**. The Rotate Picture screen appears.









- 2 Move the joystick **⬆ ⬇ ⬅ ➡** to highlight an image that you want to rotate.
- 3 Press **⊕** to rotate an image 90 degrees in a clockwise direction.
- 4 To return to the Memory Stick Setup Menu, move the joystick to highlight **Menu ↵** and press **⊕**.

 If a blank square appears instead of the thumbnail image, this indicates that the image does not support a thumbnail view and cannot be rotated.

# Using the Menus

## Overview

The Menu gives you access to the following features:

Menu Icon	Description	Page
	Allows you to make adjustments to your picture settings. It also allows you to customize the Picture Mode based on the type of program you are viewing, select Advanced Video options, and more.	72
	Offers enhanced audio options such as listening to second audio programming (SAP) or customizing the Effect of the sound on your TV.	74
	Allows you to make Wide Mode adjustments and make changes to the screen's vertical center.	76
	Allows you to set up a Favorite Channel list, run the Auto Program function, skip and label channels, and more.	78
	Lets you control the viewing of programs based on their ratings.	80
	Provides options for setting up your system, including selecting closed caption modes, setting the Timer, labeling video inputs, selecting the language of the on-screen menus, and more.	83

 Press **MENU** to enter and exit Menus.

## Navigating Through Menus

To Do This ...	Press
Display the Menu	<b>MENU</b>
Move through the Menu	← →
Move through the Menu options	↑ ↓
Select an option to change	⊕
Change an option's settings	↑ ↓ ← →
Select (confirm) changed setting	⊕ or ←
Exit the Menu	<b>MENU</b>

 Menus include navigation help text that appears at the bottom of each Menu.





## Using the Video Menu

### To select the Video Menu

- 1 Press **MENU**.
- 2 Move the joystick **←** or **→** to highlight the Video icon and press **⊕**.
- 3 Move the joystick to highlight an option. Press **⊕** to select an option.
- 4 Move the joystick **↑** **↓** **←** **→** to change settings. Press **⊕** to select the changed setting.
- 5 Press **MENU** to exit the Menu.

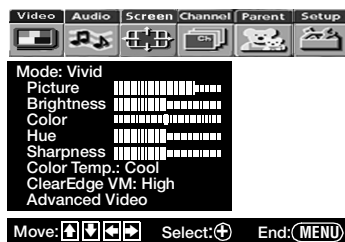

### To restore the factory default settings for the Video settings (excluding Advanced Video) of the Mode (Vivid, Standard, etc.) the TV is set to:

- Press **RESET** on the remote control when in the Video Menu.

## Selecting Video Options

 To change from one Mode to another, use the **PIC MODE** button on the remote control.

 You can alter the Video Menu settings (**Picture**, **Brightness**, **Color**, etc.) for each Mode.

The Video Menu includes the following options:

Option	Description
<b>Mode</b>	<b>Vivid</b> Select for enhanced picture contrast and sharpness.
<b>Customized picture viewing</b>	<b>Standard</b> Select for standard picture settings.
	<b>Movie</b> Select to display a softer picture.
	<b>Pro</b> Select to display a picture with minimum enhancements.
<b>Picture</b>	Adjust to increase picture contrast and deepen the color, or decrease picture contrast and soften the color.
<b>Brightness</b>	Adjust to brighten or darken the picture.
<b>Color</b>	Adjust to increase or decrease color intensity.
<b>Hue</b>	Adjust to increase or decrease the green tones.
<b>Sharpness</b>	Adjust to sharpen or soften the picture.
<b>Color Temp. White intensity adjustment</b>	<b>Cool</b> Select to give the white colors a blue tint.
	<b>Neutral</b> Select to give the white colors a neutral tint.
	<b>Warm</b> Select to give the white colors a red tint (NTSC-Standard).

Option	Description
<b>ClearEdge VM Velocity Modulation</b>	Sharpens picture definition to give every object a sharp, clean edge. Select from <b>High</b> , <b>Medium</b> , <b>Low</b> , <b>Off</b> .
<b>Advanced Video</b>	Select <b>Program</b> to choose among the <b>DRC Mode</b> and <b>DRC Palette</b> options while viewing NTSC sources.
<b>DRC Mode</b>	Creates a high-resolution picture with 4x density, for high quality sources (i.e., DVD player, satellite receiver).
<b>Interlaced</b>	Recommended for moving pictures.
<b>Progressive</b>	Recommended for still images and text.
<b>CineMotion</b>	Provides an optimized display by automatically detecting film content and applying a reverse 3/2 pulldown process. Moving pictures will appear clearer and more natural-looking.
<b>DRC Palette</b>	Allows you to customize the level of detail (Reality) and smoothness (Clarity) for up to three input sources. For example, you can create one Custom setting to optimize your cable input's picture, and create another to optimize your DVD player's picture. You can switch among the three Custom settings using the <b>DRC PALETTE</b> button on the remote control. <ol style="list-style-type: none"> <li>1 Move the joystick to highlight <b>Custom 1</b>, <b>Custom 2</b>, or <b>Custom 3</b> and then press <b>+</b>. The DRC palette appears.</li> </ol> <div data-bbox="792 1027 1038 1229" data-label="Diagram"> </div> <ol style="list-style-type: none"> <li>2 Move the joystick to adjust the position of the marker (●). As you move the ● higher along the Reality axis, the picture becomes more detailed. As you move the ● to the right along the Clarity axis, the picture becomes smoother.</li> <li>3 To save the setting, press <b>+</b>.</li> </ol> <p>To return the Custom options to the default factory settings, press the <b>RESET</b> button.</p>

 To change quickly from one DRC Mode to another, use the **DRC MODE** button on the remote control.

 **Advanced Video** options are not available (grayed out) when watching 480p, 720p, and 1080i sources.

 To change quickly from one DRC Palette to another, use the **DRC PALETTE** button on the remote control.

 For best results, adjust the Reality by moving the joystick **▲** **▼** until you are satisfied with the level of detail. Then adjust the Clarity by moving the joystick **◀** **▶** until you have a smooth image.



## Using the Audio Menu

### To select the Audio Menu

- 1 Press **MENU**.
- 2 Move the joystick **←** or **→** to highlight the Audio icon and press **⊕**.
- 3 Move the joystick to highlight an option. Press **⊕** to select an option.
- 4 Move the joystick **↑** **↓** **←** **→** to change settings. Press **⊕** to select the changed setting.
- 5 Press **MENU** to exit the Menu.



### To restore the factory default settings for Treble, Bass, and Balance

- Press **RESET** on the remote control when in the Audio Menu.

## Selecting Audio Options

 To change quickly from one Effect to another, use the **⊕** button on the inside panel of the remote control.

The Audio Menu includes the following options:

Option	Description
Treble	Adjust to decrease or increase higher-pitched sounds.
Bass	Adjust to decrease or increase lower-pitched sounds.
Balance	Adjust to emphasize left or right speaker balance.
Steady Sound	Auto Select to stabilize the volume.
	Off Select to turn off Steady Sound.
Effect	TruSurround Select for surround sound (for stereo programs only).
	Simulated Adds a surround-like effect to mono programs.
	Off Normal stereo or mono reception.
MTS <i>Enjoy stereo, bilingual and mono programs</i>	Stereo Select for stereo reception when viewing a program broadcast in stereo.
	Auto SAP Select to automatically switch the TV to second audio programs when a signal is received. (If no SAP signal is present, the TV remains in Stereo mode.)
	Mono Select for mono reception. (Use to reduce noise during weak stereo broadcasts.)

<i>Option</i>	<i>Description</i>
<b>Speaker</b>	<b>On</b> Select to turn on the TV speakers.
	<b>Off</b> Select to turn off the TV speakers and listen to the TV's sound only through your external audio system speakers.
<b>Audio Out</b> <i>Easy control of volume adjustments</i>	This option can be set only when the <b>Speaker</b> option is set to <b>Off</b> .
	<b>Variable</b> The TV's speakers are turned off, but the audio output from your audio system can still be controlled by the TV's remote control.
	<b>Fixed</b> The TV's speakers are turned off and the audio output of the TV is fixed. Use your audio receiver's remote control to adjust the volume (and other audio settings) through your audio system.



## Using the Screen Menu

### To select the Screen Menu

- 1 Press **MENU**.
- 2 Move the joystick **←** or **→** to move to the Screen icon and press **⊕**.
- 3 Move the joystick **↑** or **↓** to move to an option. Press **⊕** to select an option.
- 4 Move the joystick **←** **→** **↑** **↓** to change settings. Press **⊕** to select the changed setting.
- 5 Press **MENU** to exit the Menu.

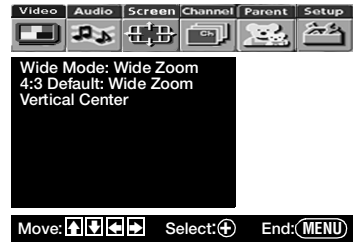

## Selecting Screen Mode Options

 To change from one Wide Mode to another, use the **WIDE MODE** button on the remote control.

 For Wide Zoom and Zoom modes, you can adjust the vertical position of the picture. For details, see page 77.



The Screen menu includes the following options:

Option	Description
<b>Wide Mode</b> <i>Select a Wide Mode to use for 4:3 sources.</i>	<b>Wide Zoom</b> Select to enlarge the 4:3 size picture, while the upper and lower parts of the picture are condensed to fit the wide screen.
<b>Normal</b>	Select to return the 4:3 picture to normal mode.
<b>Full</b>	Select to enlarge the 4:3 picture horizontally only, to fill the wide screen.
<b>Zoom</b>	Select to enlarge the 4:3 picture horizontally and vertically to an equal aspect ratio that fills the wide screen.

Wide Mode is unavailable while in Twin View, or when viewing HD (1080i, 720p) sources.

 **In some cases, wide-screen programs will be shown in aspect ratios that require the display of black bands at the top and bottom of your 16:9 screen. For more details, see page 92.**

 If 4:3 Default is set to anything but Off, the Wide Mode setting changes only for the current channel. When you change channels (or inputs), Wide Mode is automatically replaced with the 4:3 Default setting. To retain the current Wide Mode setting as channels and inputs are changed, set 4:3 Default to Off.

Option	Description	
4:3 Default <i>Select the default Screen Mode to use for 4:3 sources</i>	Wide Zoom	Select to enlarge the 4:3 size picture, while the upper and lower parts of the picture are condensed to fit the wide screen.
	Normal	Select to return the 4:3 picture to normal mode.
	Full	Select to enlarge the 4:3 picture horizontally only, to fill the wide screen.
	Zoom	Select to enlarge the 4:3 picture horizontally and vertically to an equal aspect ratio that fills the wide screen.
	Off	Select to continue using the current Wide Mode setting when the channel or input is changed.
Vertical Center	Allows you to move the position of the picture up and down in the window. (Available only in Wide Zoom and Zoom modes.)  Move the joystick  or  and press  to choose a correction between +15 and -15 (Zoom mode), and +10 and -10 (Wide Zoom mode).	



## Using the Channel Menu

### To select the Channel Menu

- 1 Press **MENU**.
- 2 Move the joystick **←** or **→** to highlight the Channel icon and press **⊕**.
- 3 Move the joystick to highlight an option. Press **⊕** to select an option.
- 4 Move the joystick **↑** **↓** **←** **→** to change settings. Press **⊕** to select the changed setting.
- 5 Press **MENU** to exit the Menu.



















## Selecting Channel Options

The Channel Menu includes the following options:

Option	Description
<b>Favorite Channels</b>	Lets you set up a list of your favorite channels. For details, see "Using Favorite Channels" on page 62.
<b>Cable</b>	<p><b>On</b> Select if you are receiving cable channels with a CATV cable.</p> <p><b>Off</b> Select if you are using an antenna.</p>
<b> You should run Auto Program after changing this option.</b>	
<b>Channel Fix</b> <i>Useful when you have a cable box or satellite receiver connected</i>	<p><b>Off</b> Turns off Channel Fix.</p> <p><b>2-6</b> "Fix" your TV's channel setting to 2-6 and use the cable box or satellite receiver to change channels. Select one of these settings if you connected the equipment to the VHF/UHF jack.</p> <p><b>AUX 2-6</b> Same as 2-6, except you select one of these settings if you connected the equipment to the AUX jack (see page 17).</p> <p><b>Video 1</b> Use this setting if you have connected the equipment to the A/V input jacks.</p>
<b>Auto Program</b>	Automatically sets up the channel list on the TV for all receivable channels.

 Channels that you set to be skipped can be accessed only with the 0-9 buttons.

 Channel Label is not available (grayed out) when watching 480p, 720p, and 1080i sources.

<i>Option</i>	<i>Description</i>
<a href="#">Channel Skip/Add</a>	<p>Allows you to customize the channel list that appears when you use the CH+/- buttons.</p> <ol style="list-style-type: none"><li>1 Move the joystick  or  to scroll through the channels until you find the channel you want to skip or add. Then press  to select it.</li><li>2 Move the joystick  or  to toggle between <a href="#">Add</a> or <a href="#">Skip</a>. Then press  to select.</li><li>3 To add or skip more channels, repeat steps 1 and 2.</li><li>4 Move the joystick  to return to the Channel Menu, or press <a href="#">MENU</a> to exit the Menus.</li></ol>
<a href="#">Channel Label</a>	<p>Allows you to assign labels (such as station call letters) to channel numbers. You can label up to 20 channels.</p> <ol style="list-style-type: none"><li>1 Move the joystick to highlight <a href="#">Channel</a> and press .</li><li>2 Move the joystick   to scroll through the channel numbers (1-125). Then press  to select the channel number that you want to assign a label.</li><li>3 Move the joystick to highlight <a href="#">Label</a> and press .</li><li>4 Move the joystick   to scroll through the label characters (A-Z, 0-9, etc.). Then press  to select the highlighted character.</li><li>5 Repeat to add up to 5 characters to the label.</li><li>6 To assign labels to more channels, repeat steps 1-4.</li><li>7 Move the joystick  to return to the Channel Menu, or press <a href="#">MENU</a> to exit the Menus.</li></ol>





## Using the Parent Menu

The Parent Menu allows you to set up the TV to block programs according to their content and rating levels.



### To select the Parent Menu

- 1 Press **MENU**.
- 2 Move the joystick **←** or **→** to highlight the Parent icon and press **⊕**.
- 3 Use the **0-9** buttons on the remote control to enter a four-digit password.
- 4 If this is the first time you are creating this password, confirm the password by entering it again. (The Parent Menu options appear.)
- 5 Move the joystick **↑ ↓ ← →** to change settings. Press **⊕** to select the changed setting.
- 6 Press **MENU** to exit the Menu.

**You need your password for any future access into the Parent Menu. If you lose your password, see "Lost password" on page 94.**

## Selecting Parent Options

If you are not familiar with the Parental Guideline rating system, you should select **Child**, **Youth**, or **Young Adult** to help simplify the rating selection. To set more specific ratings, select **Custom**.

For descriptions of **Child**, **Youth**, and **Young Adult** ratings, see page 81.

The Parent Menu includes the following options:

Option	Description
<b>Parental Lock</b>	<b>Off</b> Parental lock is off. No programs are blocked from viewing.
<b>Turn ratings on/off and select a rating system</b>	<p><b>Child</b> Maximum ratings permitted are:</p> <ul style="list-style-type: none"> <li><input type="checkbox"/> US: TV-Y, TV-G, G</li> <li><input type="checkbox"/> Canada: C, G, TV-Y</li> </ul> <p><b>Youth</b> Maximum ratings permitted are:</p> <ul style="list-style-type: none"> <li><input type="checkbox"/> US: TV-PG, PG</li> <li><input type="checkbox"/> Canada: C8+, PG, 8 ans+, TV-PG</li> </ul> <p><b>Y. Adult</b> Maximum ratings permitted are:</p> <ul style="list-style-type: none"> <li><input type="checkbox"/> US: TV-14, PG-13</li> <li><input type="checkbox"/> Canada: 14+, 13 ans+, TV-14</li> </ul> <p><b>Custom</b> Select to set ratings manually.</p> <ul style="list-style-type: none"> <li><input type="checkbox"/> US: See page 81 for details.</li> <li><input type="checkbox"/> Canada: See page 82 for details.</li> </ul>
<b>Change Password</b>	For changing your password.
<b>Select Country</b>	<p><b>U.S.A.</b> Select to use USA ratings (see page 81).</p> <p><b>Canada</b> Select to use Canadian ratings (see page 82).</p>

## US Models: Selecting Custom Rating Options

 The Content-Based Ratings are linked to the level of the Age-Based Rating. For example, a program with an Age-Based Rating of TV-PG V (Violence) rating may contain moderate violence, while a TV-14 V (Violence) rating may contain more intense violence.

 To ensure maximum blocking capability, set the Age-Based Ratings.

 If you block unrated TV programs, be aware that the following types of programs may be blocked: programs broadcast from another country, emergency broadcasts, political programs, sports, news, public service announcements, religious programs and weather.

## Viewing Blocked Programs

For US models, the Custom Rating Menu includes the following options. (For Canadian models, see page 82.)

Option	Description
<b>Movie Rating</b>	<b>G</b> All children and General Audience.
	<b>PG</b> Parental Guidance suggested.
	<b>PG-13</b> Parental Guidance for children under 13.
	<b>R</b> Restricted viewing, parental guidance is suggested for children under 17.
	<b>NC-17 and X</b> No one 17 or under allowed.
<b>TV Rating</b> <i>Block programs by their rating, content or both</i>	<b>Age-Based Ratings</b>
	<b>TV-Y</b> All children.
	<b>TV-Y7</b> Directed to children age 7 and older.
	<b>TV-G</b> General Audience.
	<b>TV-PG</b> Parental Guidance suggested.
	<b>TV-14</b> Parents Strongly cautioned.
	<b>TV-MA</b> Mature Audience only.
	<b>Content-Based Ratings</b>
	<b>FV</b> Fantasy Violence.
	<b>D</b> Suggestive Dialogue.
<b>L</b> Strong Language.	
<b>S</b> Sexual situations.	
<b>V</b> Violence.	
<b>Unrated</b> <i>Block programs or movies that are broadcast without a rating</i>	<b>Block</b> Blocks all programs and movies that are broadcast without a rating.
	<b>Allow</b> Allows programs and movies that are broadcast without a rating.

You can view blocked programs by entering the password. Press the **ENTER** button when tuned to a blocked program, then enter the password. This temporarily switches off the Parental Lock. To reactivate the Parental Lock settings, turn off the TV. When the TV is turned on again, your Parental Lock settings are reactivated.

## Canadian Models: Selecting Custom Rating Options

For Canadian models, the Custom Rating Menu includes the following options. (For US models, see page 81.)

Option	Description	
English Rating	C	All children.
	C8+	Children 8 years and older.
	G	General programming.
	PG	Parental Guidance.
	14+	Viewers 14 and older.
	18+	Adult programming.
French Rating	G	General programming.
	8 ans+	Not recommended for young children.
	13 ans+	Not recommended for ages under 13.
	16 ans+	Not recommended for ages under 16.
	18 ans+	Programming restricted to adults.
U.S.A. Rating	See "US Models" on page 81 for details.	

## Viewing Blocked Programs

You can view blocked programs by entering the password. Press the **ENTER** button when tuned to a blocked program, then enter the password. This temporarily switches off the Parental Lock. To reactivate the Parental Lock settings, turn off the TV. When the TV is turned on again, your Parental Lock settings are reactivated.



## Using the Setup Menu



### To select the Setup Menu

- 1 Press **MENU**.
- 2 Move the joystick **←** or **→** to highlight the Setup icon and press **⊕**.
- 3 Move the joystick to highlight an option. Press **⊕** to select an option.
- 4 Move the joystick **↑ ↓ ← →** to change settings. Press **⊕** to select the changed setting.
- 5 Press **MENU** to exit the Menu.



 To move from within one Menu to the main Menu of icons, move the joystick **←**.

## Selecting Setup Options

The Setup Menu includes the following options:

Option	Description
Caption Vision	Allows you to select from three closed caption modes (for programs that are broadcast with closed caption).
CC1, CC2, CC3, CC4	Displays a printed version of the dialog or sound effects of a program. (Should be set to <b>CC1</b> for most programs.)
Text1, Text2, Text3, Text4	Displays network/station information presented using either half or the whole screen (if available). For closed captioning, set to <b>CC1</b> .
Info	Displays the program name and the time remaining in the program (if the broadcaster offers this service). Displays when the channel is changed or the <b>DISPLAY</b> button is pressed.
Off	Turns off Caption Vision.

Option	Description							
Video Label	<p>Allows you to identify A/V equipment you connected to the TV, such as a VCR, DVD, etc. For example, if you have a DVD player connected to the VIDEO 5 jack, you can select the label <b>DVD</b> for the VIDEO 5 input. Then when you press the <b>TV/VIDEO</b> button to change inputs, the Video Label you assigned to that input appears on screen.</p> <ol style="list-style-type: none"> <li>1 Move the joystick <b>▲</b> or <b>▼</b> to highlight the video input (VIDEO 1-7) to which you want to assign a label. Then press <b>⊕</b> to select the input.</li> <li>2 Move the joystick <b>▲</b> or <b>▼</b> to highlight one of the displayed labels. Then press <b>⊕</b> to select the label.</li> </ol> <p>You can select from the following labels for each input:</p> <table border="1"> <tr> <td>Video 1/2/3/4</td> <td>VHS, DVD, Receiver, Satellite, Cable Box, 8mm, DTV, Game, LD, Web, Beta, Skip</td> </tr> <tr> <td>Video 5/6/7</td> <td>DVD, Satellite, Cable Box, DTV, HD, Skip</td> </tr> </table> <p><b>✍ If you select Skip, your TV skips this input when you press the TV/VIDEO button.</b></p>	Video 1/2/3/4	VHS, DVD, Receiver, Satellite, Cable Box, 8mm, DTV, Game, LD, Web, Beta, Skip	Video 5/6/7	DVD, Satellite, Cable Box, DTV, HD, Skip			
Video 1/2/3/4	VHS, DVD, Receiver, Satellite, Cable Box, 8mm, DTV, Game, LD, Web, Beta, Skip							
Video 5/6/7	DVD, Satellite, Cable Box, DTV, HD, Skip							
Language	Select to display all on-screen Menus in your language of choice.							
Clock/Timers	<p>Select to set the clock and to program your TV to turn on and off at two scheduled viewing times.</p> <table border="1"> <tr> <td>Timer 1</td> <td rowspan="2">You can use the Timers to program the TV to turn on and off and tune to a specific channel at two scheduled viewing times.</td> </tr> <tr> <td>Timer 2</td> </tr> </table> <p>Timer 1 and Timer 2 are not available to be set until you set the <b>Current Time</b>.</p> <ol style="list-style-type: none"> <li>1 Move the joystick <b>▲</b> or <b>▼</b> to highlight <b>Timer 1</b> or <b>Timer 2</b>. To set the timer, move the joystick <b>▶</b>.</li> <li>2 Move the joystick <b>▲</b> or <b>▼</b> to highlight one of the following options, then press <b>⊕</b>. <table border="1"> <tr> <td>Program</td> <td>Select to set the Timer by day, time, duration, and channel.</td> </tr> <tr> <td>Off</td> <td>Select to turn off the Timer. (Your previous settings are saved.)</td> </tr> </table> </li> <li>3 If you selected <b>Program</b> in step 2, move the joystick <b>▲</b> and <b>▼</b> to set the day(s), hour, minute, duration, and channel number. Press <b>⊕</b> or move the joystick <b>▶</b> to confirm each setting and move to the next setting. Move the joystick <b>◀</b> to go back to the previous setting.</li> <li>4 Press <b>MENU</b> to exit the Menu. An LED on the front panel will light, indicating the timer has been set.</li> </ol>	Timer 1	You can use the Timers to program the TV to turn on and off and tune to a specific channel at two scheduled viewing times.	Timer 2	Program	Select to set the Timer by day, time, duration, and channel.	Off	Select to turn off the Timer. (Your previous settings are saved.)
Timer 1	You can use the Timers to program the TV to turn on and off and tune to a specific channel at two scheduled viewing times.							
Timer 2								
Program	Select to set the Timer by day, time, duration, and channel.							
Off	Select to turn off the Timer. (Your previous settings are saved.)							

 The **Skip** label is useful for inputs that do not have equipment connected to them.

 To go directly to programming Timer 1 or 2, press **⊕** instead of moving the joystick **▶**.

 You can also access Flash Focus by pressing the **FLASH FOCUS** button on the front panel of the TV. For details, see pages 14-15.

<i>Option</i>	<i>Description</i>
<b>Clock/Timers</b> (continued)	<b>Current Time</b> <ol style="list-style-type: none"><li>1 Press <b>+</b> to select <b>Current Time</b>.</li><li>2 Move the joystick <b>↑</b> and <b>↓</b> to set the current time (day, hour, and minute). Press <b>+</b> (or move the joystick <b>→</b>) to confirm each setting and move to the next setting. Move the joystick <b>←</b> to go back to the previous setting.</li><li>3 Press <b>MENU</b> to exit the Menu.</li></ol>
<b>Flash Focus</b>	Allows you to adjust the convergence automatically. For details, see page 44.
<b>Convergence</b>	Allows you to fine-tune the convergence manually. For details, see page 45.
<b>Demo</b>	Runs a demonstration of on-screen Menus.



# Other Information

## Overview

This chapter includes the following topics:

<i>Topic</i>	<i>Page</i>
Glossary	88
Notes on Using Memory Stick Media	89
Contacting Sony	90
Troubleshooting	90
Specifications	95
Optional Accessories	96
Index	97



# Glossary

## analog signal

A signaling method that uses continuous changes in the amplitude or frequency of an electronic transmission to convey information.

## aspect ratio

Refers to the ratio between the width and height of the screen. This TV has a 16:9 (widescreen) aspect ratio, as opposed to a 4:3 aspect ratio.

### 4:3 aspect ratio



### 16:9 aspect ratio



## component video



Component video is sent through three cables: two color shade (chrominance) signals and one brightness (luminance) signal. Component video achieves greater color accuracy than composite video or S VIDEO by splitting chrominance into two separate portions.

## composite video



Composite video is sent through a single cable. Composite video combines the color shade (chrominance) and brightness (luminance) information into one video signal.

## digital television (DTV)

A new technology for transmitting and receiving broadcast television signals. DTV provides higher resolution and improved sound quality over analog television.

## National Television System Committee (NTSC)

A unit of the Federal Communications Commission, Washington, DC, that establishes television standards in the United States, such as NTSC Color, the standard used in this TV.

### RF

Radio Frequency. That part of the frequency spectrum in which it is possible to radiate (transmit) electromagnetic waves.

### S VIDEO



S VIDEO requires a single cable, which carries the brightness (luminance) and color (chrominance) signals of the picture separately. S VIDEO provides better resolution than composite video, which carries the signals together.

### VHF/UHF

VHF (Very High Frequency) is the part of the radio spectrum from 30 to 300 megahertz. UHF (Ultra High Frequency) is the part of the radio spectrum from 300 to 3,000 megahertz.

### 480i

Provides 480 lines of resolution. Displays images using interlaced scanning, which first transmits all the odd lines on the TV screen and then the even lines.

### 480p

Provides 480 lines of resolution. Displays images using progressive scanning, which transmits each line from top to bottom.

### 720p

Provides 720 lines of resolution. Displays images using progressive scanning, which transmits each line from top to bottom.

### 1080i

Provides 1080 lines of resolution. Displays images using interlaced scanning, which first transmits all the odd lines on the TV screen and then the even lines. 1080i is one of the formats used by HDTV (High Definition TV).

## Notes on Using Memory Stick Media

### Memory Stick Precautions

When using Memory Stick media, follow these precautions:

- ❑ To avoid permanent damage to still image data, do not turn off the TV or remove Memory Stick media from the insertion slot while data is being read (as indicated by the Memory Stick indicator light being on).
- ❑ Avoid touching the terminal of Memory Stick media or bringing it into contact with a metal object.
- ❑ Do not drop, bend, or submit Memory Stick media to external shock.
- ❑ Do not disassemble or modify Memory Stick media.
- ❑ Avoid getting liquid on Memory Stick media.
- ❑ Apply labels only within the designated label area.

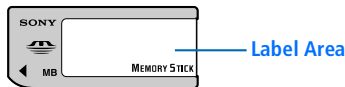

- ❑ To avoid permanent damage to still image data, do not use or store Memory Stick media in a location subject to:
  - ❑ High temperature (such as near a heater or inside a hot car)
  - ❑ High humidity
  - ❑ Direct sunlight
  - ❑ Corrosive substances
  - ❑ Magnetic fields
  - ❑ Excessive dust
  - ❑ Static electricity or electric noise
- ❑ Store and carry Memory Stick media in its original case to ensure protection of stored data.
- ❑ Save a backup of stored data.

## Contacting Sony

If, after reading these operating instructions, you have additional questions related to the use of your Sony television, please call our Customer Information Services Center at 1-800-222-SONY (7669) (US residents only) or (416) 499-SONY (7669) (Canadian residents only).

## Troubleshooting

If you are having problems with your TV, you can reset all the TV's settings to their original factory default settings, as follows.

 **Notice:** The following procedure resets all custom settings, channel lists, etc., to the factory default settings.

- 1 Turn on the TV.
- 2 Hold down the **RESET** button on the remote control.
- 3 Press the **POWER** button on the front panel of the TV.
- 4 Release the **RESET** button on the remote control.

### Twin View

Problem	Possible Remedies
I cannot get Twin View to work	<ul style="list-style-type: none"><li>❑ If you are using a cable box to unscramble all channels (as shown on page 24), you cannot use the Twin View feature. This is because the cable box can unscramble only one channel at a time. But if you need the cable box to unscramble only some (usually premium) channels, you can use Twin View for unscrambled channels if you connect both a cable and cable box, as shown on page 22.</li><li>❑ You can use Twin View to view a signal from a different source that is connected to the TV's A/V jacks (such as a VCR or DVD player) in the second window by pressing the <b>TV/VIDEO</b> button while in Twin View.</li><li>❑ Sources connected to the AUX, VIDEO 5, VIDEO 6, and VIDEO 7 inputs display in the left Twin View window, but not the right.</li></ul>
There is no Twin View window, or it is just static	<ul style="list-style-type: none"><li>❑ Be sure the Twin View window is set to a video input or channel that has a signal airing.</li><li>❑ You might be tuned to a video input with nothing connected to it. Try cycling through the video inputs by pressing the <b>TV/VIDEO</b> button.</li><li>❑ If you connected equipment to the TV's AUX jack, it will display in the left Twin View window, but not the right.</li></ul>
Twin View cannot display anything but TV channels	<ul style="list-style-type: none"><li>❑ Try cycling through the video inputs by pressing the <b>TV/VIDEO</b> button. Check that the <b>Video Label</b> option is not set to <b>Skip</b>. (See the Setup Menu on page 84.)</li></ul>
Twin View displays the same program in both windows	<ul style="list-style-type: none"><li>❑ Both Twin View windows might be set to the same channel. Try changing channels in either window.</li></ul>

## Remote Control

Problem	Possible Remedies
Remote control does not operate	<ul style="list-style-type: none"><li>❑ The batteries could be weak. Replace the batteries.</li><li>❑ Check the orientation of the batteries.</li><li>❑ Press the <b>TV FUNCTION</b> button. You may have inadvertently pressed the <b>SAT/CABLE FUNCTION</b> button, which changes the remote control to SAT or CABLE mode.</li><li>❑ Make sure the TV's power cord is connected securely to the wall outlet.</li><li>❑ Locate the TV at least 3-4 feet away from fluorescent lights.</li></ul>
Cannot change channels with the remote control	<ul style="list-style-type: none"><li>❑ If you are using the TV to change channels, first press the <b>TV FUNCTION</b> button.</li><li>❑ If you are using another device to change channels, be sure you have not inadvertently switched your TV from the channel 3 or 4 setting. Use the <b>Channel Fix</b> option to "fix" the channel based on the hookup you used (see page 78).</li><li>❑ If you are using another device to change channels, be sure to press the <b>FUNCTION</b> button for that device. For example, if you are using your cable box to change channels, be sure to press the <b>SAT/CABLE FUNCTION</b> button.</li></ul>
Remote control does not operate non-Sony video equipment	<ul style="list-style-type: none"><li>❑ If you replaced the batteries to the remote recently, the code numbers for the video equipment may need to be reset.</li><li>❑ There may be more than one code for the equipment that you are attempting to operate.</li><li>❑ There is a possibility that some non-Sony equipment cannot be operated by your Sony TV remote. You may need to use the equipment's original remote control.</li></ul>

## Memory Stick

Problem	Possible Remedies
Image does not display	<ul style="list-style-type: none"><li>❑ Make sure the image is supported by the TV (see pages 64-65).</li><li>❑ Make sure the Memory Stick is inserted properly (see page 66).</li><li>❑ Memory Stick functions are not available while using Twin View, Freeze or Favorite Channel functions.</li></ul>
Blank square appears instead of a thumbnail image	<ul style="list-style-type: none"><li>❑ This indicates that the image does not support a thumbnail view. Selecting the icon, however, displays the full-size image on the screen. It could also indicate that both the thumbnail and full-size images are corrupted or not supported.</li></ul>
Cannot rotate image, no thumbnail appears	<ul style="list-style-type: none"><li>❑ Be sure the LOCK switch on the Memory Stick is set to off.</li><li>❑ If a blank square appears instead of the thumbnail image, this indicates that the image does not support a thumbnail view and cannot be rotated.</li></ul>
Cannot hear audio while using Memory Stick	<ul style="list-style-type: none"><li>❑ There is no audio available while using Memory Stick.</li></ul>
Image file name does not appear; instead, dashes (--) appear	<ul style="list-style-type: none"><li>❑ Dashes appear instead of the file name if the image was recorded using equipment that is not DCF-compliant. Dashes also appear if a DCF-compliant file was renamed.</li></ul>

## Video

Problem	Possible Remedies
No picture (screen not lit), no sound	<ul style="list-style-type: none"><li>❑ If your TV does not turn on, and a red light keeps flashing, your TV may need service. Call your local Sony Service Center.</li><li>❑ Make sure the power cord is plugged in.</li><li>❑ Press the <b>POWER</b> button on the front of the TV.</li><li>❑ Press the <b>TV/VIDEO</b> button to cycle through the connected video sources.</li><li>❑ Try another channel; it could be station trouble.</li></ul>
Dark, poor or no picture (screen lit), good sound	<ul style="list-style-type: none"><li>❑ Adjust the <b>Picture</b> option in the Video Menu (see page 72).</li><li>❑ Adjust the <b>Brightness</b> option in the Video Menu (see page 72).</li><li>❑ Check the antenna/cable connections.</li></ul>
No color	<ul style="list-style-type: none"><li>❑ Adjust the <b>Color</b> option in the Video Menu (see page 72).</li></ul>
Only snow and noise appear on the screen	<ul style="list-style-type: none"><li>❑ Check the antenna/cable connections.</li><li>❑ Try another channel; it could be station trouble.</li><li>❑ Press <b>ANT</b> to change the input mode (see page 48).</li></ul>
Dotted lines or stripes	<ul style="list-style-type: none"><li>❑ Adjust the antenna.</li><li>❑ Move the TV away from noise sources such as cars, neon signs, or hair-dryers.</li></ul>
Double images or ghosts	<ul style="list-style-type: none"><li>❑ Using a highly directional outdoor antenna or a cable may solve the problem.</li></ul>
“Black box” on screen	<ul style="list-style-type: none"><li>❑ You have selected a text option in the Setup Menu and no text is available. (See page 83 to reset Setup selections.) To turn off this feature, set the <b>Caption Vision</b> option to <b>Off</b>. If you were trying to select closed captioning, select <b>CC1</b> instead of <b>TEXT 1-4</b>.</li></ul>
Black bands appear at the top and bottom of the screen	<ul style="list-style-type: none"><li>❑ Some wide-screen programs are filmed in aspect ratios that are greater than 16:9 (this is especially common with theatrical releases). Your TV will show these programs with black bands at the top and bottom of the screen. For more details, check the documentation that came with your DVD (or contact your program provider).</li></ul>
Certain programs on DVD or other digital sources display a loss of detail, especially during fast-motion or dark scenes	<ul style="list-style-type: none"><li>❑ The compression used by certain digital broadcasts and DVDs may cause your TV's screen to display less detail than usual, or cause artifacts (small blocks or dots, pixelations) to appear on your screen. This is due to your TV's large screen and ability to show very fine detail, and is normal for certain digitally recorded programs. Adjust the reality/clarity in the DRC Palette menu (see page 73) to optimize the picture while viewing these sources.</li></ul>

## Audio

<b>Problem</b>	<b>Possible Remedies</b>
Good picture, no sound	<ul style="list-style-type: none"><li>❑ Press <b>MUTING</b> so that <b>Muting</b> disappears from the screen (see page 48).</li><li>❑ Make sure the <b>Speaker</b> option is set to <b>On</b> in the Audio Menu (see page 75).</li></ul>
Cannot gain enough volume when using a cable box	<ul style="list-style-type: none"><li>❑ Increase the volume of the cable box using the cable box's remote control. Then press <b>TV FUNCTION</b> and adjust the TV's volume.</li></ul>
Sound seems weak or insufficient	<ul style="list-style-type: none"><li>❑ The TV's audio might be set to <b>Auto SAP</b> or <b>Mono</b>, when it might be better set to <b>Stereo</b>. In the Audio Menu (see page 74), set the <b>MTS</b> setting to <b>Stereo</b>. If already set to <b>Stereo</b>, switch to <b>Mono</b> (which may reduce background noise during weak stereo broadcasts).</li></ul>
Cannot raise the volume on external audio speakers	<ul style="list-style-type: none"><li>❑ If the <b>Speaker</b> option is set to <b>Off</b> and the <b>Audio Out</b> option is set to <b>Fixed</b> (in order to output the sound to your audio system) use your audio receiver to adjust the sound (see page 74). Or, to use the TV remote control, set the <b>Audio Out</b> option to <b>Variable</b>.</li><li>❑ To turn on the TV speakers, set the <b>Speaker</b> option to <b>On</b> (see page 74).</li></ul>

## Channels

<b>Problem</b>	<b>Possible Remedies</b>
Cannot receive upper channels (UHF) when using an antenna	<ul style="list-style-type: none"><li>❑ Change the <b>Cable</b> option to <b>Off</b> (see page 78).</li><li>❑ Use <b>Auto Program</b> in the Channel Menu to add receivable channels that are not presently in the TV's memory (see page 78).</li></ul>
TV is fixed to one channel	<ul style="list-style-type: none"><li>❑ Use <b>Auto Program</b> in the Channel Menu to add receivable channels that are not presently in the TV's memory (see page 78).</li><li>❑ Check your Channel Fix settings (see page 78).</li></ul>
Cannot receive any channels when using cable TV	<ul style="list-style-type: none"><li>❑ Use <b>Auto Program</b> in the Channel Menu to add receivable channels that are not presently in the TV's memory (see page 78).</li><li>❑ Make sure the <b>Cable</b> option is set to <b>On</b> in the Channel Menu (see page 78).</li></ul>
Cannot receive or select channels	<ul style="list-style-type: none"><li>❑ Use <b>Auto Program</b> in the Channel Menu to add receivable TV channels that are not presently in TV memory (see page 78).</li></ul>

## General

<b>Problem</b>	<b>Possible Remedies</b>
How to reset TV to factory settings	<ul style="list-style-type: none"><li>❑ Turn on the TV. While holding down the <b>RESET</b> button on the remote control, press the <b>POWER</b> button on the TV. (The TV will turn itself off, then back on again.) Release the <b>RESET</b> button.</li></ul>
How to restore Video settings to factory settings	<ul style="list-style-type: none"><li>❑ Press the <b>RESET</b> button on the remote control while in the Video Menu (see page 72).</li></ul>
How to restore Audio settings to factory settings	<ul style="list-style-type: none"><li>❑ Press the <b>RESET</b> button on the remote control while in the Audio Menu (see page 74).</li></ul>
Cannot cycle through the other video equipment connected to the TV	<ul style="list-style-type: none"><li>❑ Be sure the <b>Video Label</b> option is not set to <b>Skip</b> (see page 84).</li></ul>
Cannot operate Menu	<ul style="list-style-type: none"><li>❑ If a menu option appears in gray, this indicates that the TV is in a state in which the menu option is not available.</li></ul>
Lost password	<ul style="list-style-type: none"><li>❑ In the password screen (see page 80), enter the following master password: <b>4357</b>. The master password clears your previous password; it cannot be used to temporarily unblock channels.</li></ul>
LED on front panel is lit	<ul style="list-style-type: none"><li>❑ The <b>STAND BY LED</b> (see page 14) blinks when the TV is turned on, then shuts off when the picture is displayed. If the LED blinks continuously, this may indicate the TV needs service.</li><li>❑ The <b>TIMER LED</b> (see page 14) indicates that the timer is set. When the timer is set, this LED will remain lit even when the TV is turned off.</li></ul>

## Specifications

Projection System	3 picture tubes, 3 lenses, horizontal in-line system	
Picture Tube	7-inch high-brightness monochrome tubes (6.3 raster size), with optical coupling and liquid cooling system	
Projection Lenses	High performance, large diameter hybrid lens F1.1	
Antenna	75 ohm external terminal for VHF/UHF	
Television System	NTSC, American TV Standard	
Channel Coverage	VHF	2-13
	UHF	14-69
	CATV	1-125
Power Requirements	120V, 60 Hz	
Inputs/Outputs		
DVI-HDTV	1 terminal, 3.3V T.M.D.S., 50 ohms The DVI-HDTV input terminal is compliant with the EIA-861 standard and is not intended for use with personal computers.	
Video (IN)	4 total (1 on front panel)	1 Vp-p, 75 ohms unbalanced, sync negative
S Video (IN)	3 total (1 on front panel)	Y: 1 Vp-p, 75 ohms unbalanced, sync negative C: 0.286 Vp-p (Burst signal), 75 ohms
Audio (IN)	7 total (1 on front panel)	500 mVrms (100% modulation) Impedance: 47 kilohm
Component Video Input	2 (Y, P <sub>B</sub> , P <sub>R</sub> )	Y: 1.0 Vp-p, 75 ohms unbalanced, sync negative; P <sub>B</sub> : 0.7 Vp-p, 75 ohms P <sub>R</sub> : 0.7 Vp-p, 75 ohms
CONTROLS (IN/OUT)	1	
Variable/Fixed Audio (OUT)	1	More than 408 mVrms at the maximum volume setting (Variable) More than 408 mVrms (Fixed) Impedance (output): 2 kilohms
Supplied Accessories	Remote Control	RM-Y188
	AA (R6) Batteries	2 supplied for remote control
Screen Size (measured diagonally)	KP-57WV600/700	57 inches
	KP-65WV600/700	65 inches
Speaker Output	20W x 2	
Dimensions (W x H x D)	KP-57WV600/700	1361 x 1394 x 689 mm (53 <sup>5</sup> / <sub>8</sub> x 54 <sup>15</sup> / <sub>16</sub> x 27 <sup>1</sup> / <sub>8</sub> in)
	KP-65WV600/700	1542 x 1516 x 735 mm (60 <sup>3</sup> / <sub>4</sub> x 59 <sup>3</sup> / <sub>4</sub> x 28 <sup>15</sup> / <sub>16</sub> in)
Mass	KP-57WV600/700	98Kg (216 lbs)
	KP-65WV600	136Kg (300 lbs)
	KP-65WV700	134Kg (295 lbs)
Power Consumption	In Use	295 W
	In Standby	Under 1 W

Design and specifications are subject to change without notice.



## ***Optional Accessories***

- ❑ A/V Cable (VMC-810/820/830 HG)
- ❑ Audio Cable (RKC-515HG)
- ❑ Component Video Cable (VMC-10/30 HG)
- ❑ Control S Cable (RK-G69HG)
- ❑ Memory Stick media: 8 MB (MSA-8A); 16 MB (MSA-16A); 32 MB (MSA-32A); 64 MB (MSA-64A); 128 MB (MSA-128A)

# Index

0-9 buttons 49, 56  
16:9 aspect ratio 58  
4:3 aspect ratio 58  
4:3 Default settings 77

## A

Advanced Video 73  
ANT button 48, 56  
antenna, connecting 19  
Audio Menu 71, 74  
Audio Out 75  
audio receiver, connecting 41  
Auto Program (channel setup) 43, 78  
Auto SAP, MTS setting 74  
AUX jack, described 17  
AV1-3/DVD slide switch 50

## B

balance, adjusting 74  
bass, adjusting 74  
batteries, inserting in remote 47  
bilingual audio 74  
blocking programs. *See ratings.*  
brightness, adjusting 72

## C

cable  
    connecting 19  
    setting On/Off 78  
    with VCR, connecting 26  
cable box  
    connecting with VCR 28  
    Twin View issues 59  
    using with TV remote control 54  
Caption Vision 83  
carrying the TV 12  
CATV. *See cable*  
CH buttons 14, 15, 49, 56  
changing picture size, in Twin View 61  
Channel Menu 71, 78  
Channel Skip/Add 79  
channels

    creating labels 79  
    setting up 43  
CineMotion 10, 48, 73  
ClearEdge VM 10, 73  
clearing, Favorite Channels 62  
closed caption modes 71, 83  
CODE SET button 49  
color, adjusting 72  
CONTROL S 42  
CONTROL S IN/OUT jacks, described 17  
Convergence, adjusting automatically 44  
Convergence, adjusting manually 45  
Cool, Color Temperature 72

## D

Demo, Menus 85  
Digital Reality Creation 9  
Digital Visual Interface (DVI) 10, 17  
DISC MENU button 50, 54  
DISPLAY button 49, 56  
DRC Mode 73  
DRC MODE button 48  
DRC Palette 73  
DRC PALETTE button 49  
DRC. *See Digital Reality Creation.*  
DVD player  
    using with TV remote control 54  
    with A/V connectors, connecting 38  
DVI. *See Digital Visual Interface.*  
DVI-HDTV 17, 95

## E

Effect button 50  
ENTER button 49, 56

## F

Fast-forward button 50  
Favorite Channels  
    clearing 62  
    in Channel Menu 78  
    using 62  
FAVORITES button 48

features 9  
Fixed audio setting 75  
Flash Focus 44  
FREEZE button 50, 63  
Freeze, using 63  
Full mode, setting 76

## G

GUIDE button 49

## H

HD Detailer 10  
HD/DVD IN (1080i/720p/480p/480i) jacks,  
described 17  
hue, adjusting 72

## I

INDEX button 48, 57  
interlaced 9, 48, 73, 88

## J

joystick 48  
JUMP button 48, 56

## L

label  
channels 79  
Language, setting 84  
LOCK switch, Memory Stick 70

## M

MDP, using with TV remote control 54  
Memory Stick  
Index 68  
indicator (LED) 14, 15  
inserting 66  
insertion slot 14, 15  
Menu 67  
precautions 89  
Rotate Picture 70  
Setup options 69  
Slideshow 69  
supported and unsupported images 64  
troubleshooting 91  
using 64–70  
Memory Stick button 49  
MENU button 48, 50, 56, 71  
Menus

Audio 71, 74  
Channel 71, 78  
Parent 71, 80  
Setup 83  
Video 71, 72, 76

Mono, MTS setting 74  
Movie mode 72  
MTS 74  
MUTING button 48, 56

## N

Neutral, Color Temperature 72  
Normal mode, setting 76

## O

off, turning off the TV 14, 15  
on, turning on the TV 14, 15

## P

Parent Menu 71, 80  
parental control, described 10  
password, changing 80  
Pause button 50  
PIC MODE button 49  
picture contrast, adjusting 72  
Picture in Picture. *See Twin View.*  
Play button 50  
POWER button 14, 15  
powering on/off, the TV 14, 15  
presetting channels 78  
Pro (Video) mode 72  
problems, troubleshooting 90–94  
progressive 9, 48, 73, 88

## R

ratings, setting 80–82  
ratings, viewing blocked programs 81, 82  
Record buttons 50  
remote control  
inserting batteries 47  
programming 51–52  
removing, Favorite Channels 62  
RESET button 48  
resetting  
Audio options 74  
Rewind button 50  
rotate picture, Memory Stick 70

## S

- S VIDEO jack, described 13, 17
- SAT/CABLE FUNCTION button 48
- SAT/CABLE POWER button 49
- satellite receiver, using with TV remote control 53
- Scrolling Index, using 57
- SELECT button 50
- setting up channels 43
- Setup Menu 83
- sharpness, adjusting 72
- Simulated, Effect 74
- sizing, picture in Twin View 61
- SLEEP button 48
- slideshow 69
- speakers
  - turning on/off 75
  - using external speakers 75
- specifications 95
- STAND BY indicator 14, 15, 94
- Standard mode 72
- Steady Sound, described 10
- Steady Sound, setting 74
- Stereo, MTS setting 74
- Stop button 50
- surround sound 74
- SYSTEM OFF button 50

## T

- Timer 84
- TIMER indicator 14, 15, 94
- timers, setting 84
- transport buttons 50
- treble, adjusting 74
- troubleshooting 90–94
- TruSurround 74
- TruSurround, Effect 74
- turning on/off the TV 14, 15
- TV FUNCTION button 48, 56
- TV POWER button 49, 56
- TV/VCR button 50
- TV/VIDEO button 48, 56
- Twin View
  - described 10
  - using 59–61
- Twin View button 49

## U

- Uniform Brightness Screen 10

## V

- Variable audio setting 75
- VCR
  - using with TV remote control 53
  - with cable box, connecting 28
  - with cable, connecting 26
  - with satellite receiver, connecting 34
- VCR/DVD button 50
- Vertical Center, adjusting 77
- VHF/UHF jack, described 17
- VIDEO (L/R)/AUDIO jacks, described 17
- Video Menu 71, 72
- Video modes, selecting 72
- Vivid mode 72
- VOL buttons 14, 15, 48, 56

## W

- Warm, Color Temperature 72
- Wide Mode 76
- WIDE MODE button 48
- Wide Screen, described 9
- Wide Zoom mode, setting 76

## Z

- zoom feature, with Twin View 61
- Zoom mode, setting 76

