

SECTION I

BASIC FUNCTIONS

Descriptions of basic operations in frequent use

Your navigation system	2
Inputting letters and numbers	5
How to move the cursor	9
Destination input Explains 11 ways to input your destination Explains 11 ways to input your destination Explains 11 ways to input your destination	9
<i>Explains 11 ways to input your destination</i>	
Entering destination	28
Route guidance screen	31
Guidance screen	33
Map appearance	33
Current position display	35
Voice guidance	36
Typical voice guidance prompts	37
Registration of your home	39
Detour setting	41
Displaying points of interest	42
Turn list	45
Map scale	46
Screen scrolling	47
Orientation of the map	47
Limitations of the navigation system	49
Map database information and updates	52



AVALON_Navi_U (L/O 0307)

Your navigation system

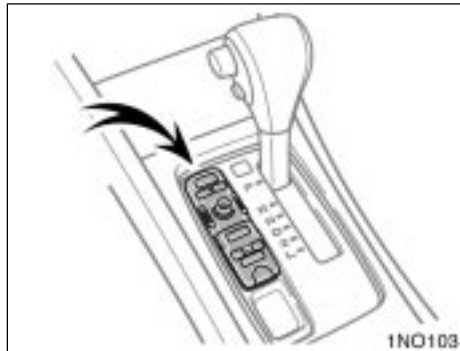

With bucket type front seat

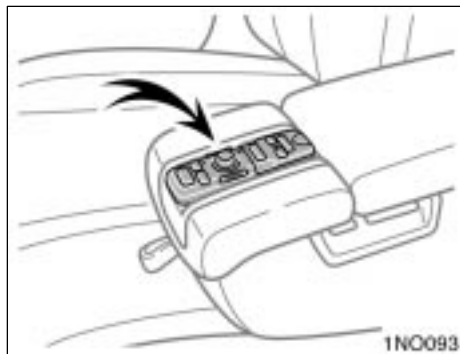

With bench type front seat

Your navigation system can be operated by the navigation controller when the ignition switch is in the “ACC” or “ON” position.

With bucket type front seat—The controller is located beside the automatic transmission selector lever.

With bench type front seat—The controller is located on the front armrest.

To turn on the system—Push the “MAP/VOICE”, “MENU”, “DEST” or “INFO” button.

To turn off the system—Push the “OFF” button.

NOTICE

To prevent the battery from being discharged, do not leave the navigation system on longer than necessary when the engine is not running.

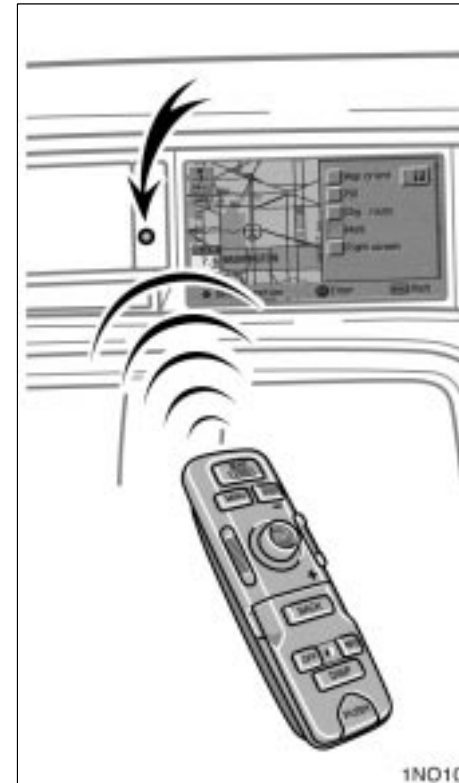

AVALON_Navi_U (L/O 0307)

The controller can be removed from its original position, and be used as a wireless remote controller. To use it as a remote controller, direct the signal output portion of the controller to the signal reception portion of the display.

CAUTION

If dropped, the navigation controller may interfere with the accelerator and brake pedals. To prevent this, keep the controller in its original position while driving.

NOTICE

Observe the following, otherwise the navigation controller may be damaged.

- ◆ *Do not leave the controller exposed to high temperatures (such as on the instrument panel) for a long time.*
- ◆ *Do not drop or knock the controller hard against other objects.*
- ◆ *Do not sit or place heavy objects on the controller.*
- ◆ *Do not modify or disassemble.*

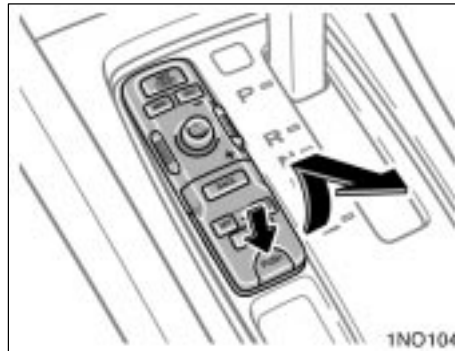

TO REMOVE THE CONTROLLER

1. Push the "PUSH" button.
2. Lift up the rear edge of the controller, and pull it to backward.



TO FIT THE CONTROLLER IN PLACE

1. Insert the front edge of the controller.
2. Push down the rear edge of the controller until it is fixed.

AVALON_Navi_U (L/O 0307)

REPLACING CONTROLLER BATTERY

For replacement of the batteries, use 2 AAA batteries.

With bucket type front seat only—While the controller is fixed in its original position, the power source is supplied from the vehicle. As long as you use the controller in this position, the controller can be used without batteries.

NOTICE

- ◆ *When replacing the batteries, use new batteries of the same manufacturer.*
- ◆ *Dispose of used batteries according to the local laws.*

Replace the batteries by the following procedures:



1. Remove the cover of the controller as shown.

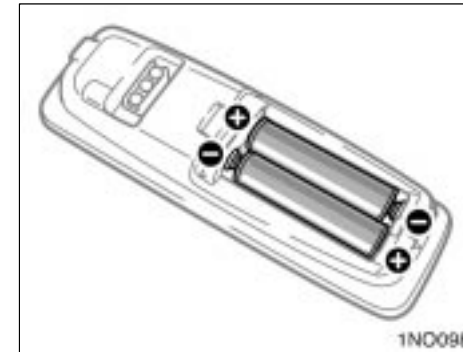

2. Put in new batteries as shown. Install the cover.

After replacing battery, check that the controller operates properly. If the controller still does not operate properly, contact your Toyota dealer.

AVALON_Navi_U (L/O 0307)

NOTICE



- ◆ *Make sure the positive side and negative side of the battery should be faced correctly.*
- ◆ *Do not replace the battery with wet hands. Water may cause unexpected rust.*

Inputting letters and numbers—

To input letters and/or numbers, move the select and scroll lever to the 8 directions, and when the letter or number you wish to input is lit up, push the “ENT” button. A beep sound is heard, and the letter or number is input. Repeat this procedure to input the name or number, etc.

You can also input letters and numbers with numeric keypad of the controller. For details, see “—Inputting with numeric keypad” on page 6 in this Section.



If you type a wrong letter, delete it with the  switch. Selecting the  switch erases one letter.

Selecting the “List” switch on the screen, the screen will be changed to display the database items that match the name or address that you have entered on the screen. The number of matching items is shown to the right side of the screen. If the matching item is more than 9,999, the system displays “****” on the screen.

Selecting the “” switch to display the diacritics input screen, the “0-9” switch to display the numeral input screen.



Selecting the “A-Z” switch changes the screen back to the alphabet input screen.

AVALON_Navi_U (L/O 0307)

—Inputting with numeric keypad

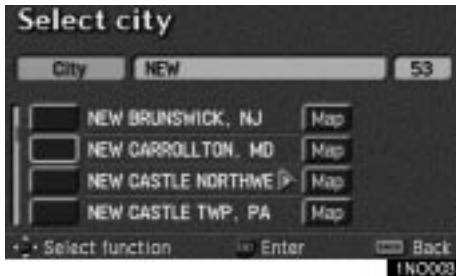

When a list is displayed, you can scroll the list by using select and scroll lever.



This expresses a displayed screen position.



If a ▶ or a ◀ appears to the right or left of the item name, the complete name is too long for the display. Select the ▶ or ◀ switch, and the name will scroll to the end or beginning of its name.

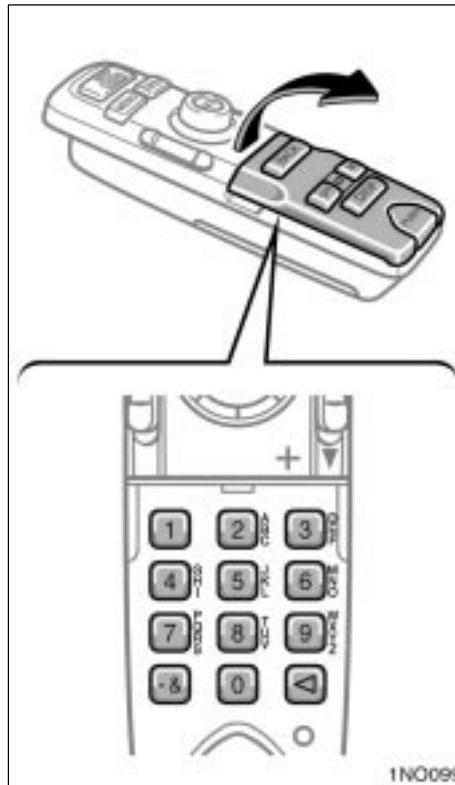

You can input letters and numbers or select the displayed numbers with the numeric keypad of the controller. To use the numeric keypad, open the lid.

The keypad is linked with 3 types of screen, and the inputting mode of the keypad changes as follows:

INPUTTING NUMBER MODE



When the above screen appears on the display, the keypad will change to the inputting number mode.

AVALON_Navi_U (L/O 0307)

Inputting numbers are assigned to each button of the keypad as follows:

Buttons	Inputting number
1	1
2	2
3	3
4	4
5	5
6	6
7	7
8	8
9	9
0	0
- &	-
◀	To delete a previous input number

INPUTTING LETTER MODE



When the above screen appears on the display, the keypad will change to the inputting letter mode.

When you select the “À-☐” switch, the screen will change to the diacritics input screen and the inputting letters will also change to the diacritics. When you select the “0-9” switch, the screen will change to the numeral input screen and the inputting letters will also change to the number.

Selecting the “A-Z” switch changes the screen back to the alphabet input screen and inputting letters back to the alphabet.

Inputting letters change according to how many times the button is pushed. For example, if you want to input “B”, push the “2” button two times. For details, see the list below.

When the letter you wish to input is highlighted on the screen, push the “ENT” button.

INFORMATION

If you want to input the same letter or assigned letters on the same button in continuation, input the first letter, push the “ENT” button, and then input the second letter. For example, if you want to input “NO”, push the “6” button two times, push the “ENT” button, and then push the “6” button three times.

AVALON_Navi_U (L/O 0307)

Inputting letters are assigned to each button of the keypad as follows:

Buttons	Inputting letters		
	Alphabet	Diacritics	Number
1	—	—	1
2	A→B→C	À→Á→Â→Ã→Ä→Å→Æ→Ç	2
3	D→E→F	È→É→Ê→Ë	3
4	G→H→I	Ì→Í→Î→Ï	4
5	J→K→L	—	5
6	M→N→O	Ñ→Ò→Ó→Ô→Õ→Ö→Ø	6
7	P→Q→R→S	—	7
8	T→U→V	Ù→Ú→Û→Ü	8
9	W→X→Y→Z	☑	9
0	—	—	0
- &	—	—	! → " → # → \$ → & → ' → (→) → * → + → , → - → . → / → : → < → ?
◀	To delete the previous input letter		

SELECTING PRESET NUMBER MODE



When the above screen appears on the display, you can select a number with the “1” through “5” buttons.

AVALON_Navi_U (L/O 0307)

How to move the cursor



1. Move the cursor  to the desired point by operating the select and scroll lever. When you release the lever, scrolling stops.

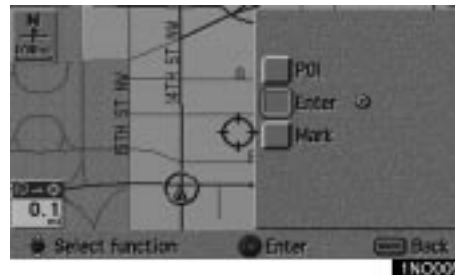



2. In case of making the position indicated by the cursor  on the display as a destination, push “ENT” button of the navigation controller and select your desired switch on the switch menu on the right of the screen.

Destination input

Push the “**DEST**” button on the navigation controller and the “Destination” screen appears.



The destination screen allows you to select the country to be searched for your destination.

-  To shift to the next or previous page.
- 

Select the “**Change**” switch on the screen to display a map of the United States divided into 10 regions and a part of Canada.

AVALON_Navi_U (L/O 0307)

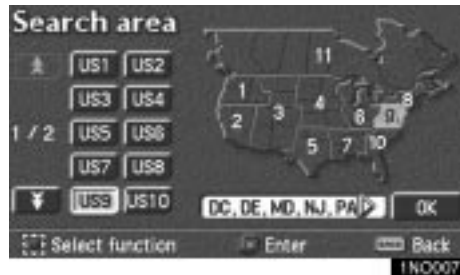

Select an area by the select and scroll lever to select the search area and the destination screen returns.

Once you choose the region of the country to search, you can use one of 11 different methods to enter your destination.

United States of America

US1	Idaho
	Oregon
	Washington
US2	California
	Neveda
US3	Arizona
	Colorado
	Montana
	New Mexico
	Utah
US4	Wyoming
	Iowa
	Kansas
	Minnesota
	Missouri
	Nebraska
	North Dakota
South Dakota	

US5	Oklahoma
	Texas
US6	Illinois
	Indiana
	Kentucky
	Michigan
US7	Ohio
	Winsconsin
	Alabama
	Arkansas
	Louisiana
	Mississippi
	Tennessee

AVALON_Navi_U (L/O 0307)

US8	Connecticut
	Maine
	Massachusetts
	New Hampshire
	New Jersey
	New York
	Rhode Island
	Vermont
US9	Delaware
	Maryland
	New Jersey
	Pennsylvania
	Virginia
	Washington, D.C.
	West Virginia
US10	Florida
	Georgia
	North Carolina
	South Carolina

CANADA

CAN	Alberta
	British Columbia
	Manitoba
	New Brunswick
	Newfoundland and Labrador
	Nova Scotia
	Ontario
	Prince Edward Island
	Québec
	Saskatchewan
	Yukon Territory

You can find your destination using various methods. See pages 13 through 28 for the detailed steps.

1. By Address: You can input the house number and the street address by using the input keys. See page 13 for the detailed steps.

2. By POI (Point of Interest): You can select one of the many points of interest that have been already stored in the system's database. There are 54 categories to choose from including restaurants, hotels and so on. See page 16 for the detailed steps.



3. By Marked Points: You can select your own favorite destinations as "Marked points". The system allows you to store up 100 marked points. See page 22 for the detailed steps.

4. By Previous Destination: You can select a destination from any of the last 20 previously set destinations. See page 23 for the detailed steps.

5. By Emergency: You can select one of the three points of emergency service points that have been already stored in the system's database. See page 23 for the detailed steps.

6. By Intersection: You can enter the names of two intersecting streets. This is helpful if you do not know the specific street address of your destination but know the general vicinity. See page 24 for the detailed steps.

AVALON_Navi_U (L/O 0307)

7. **By Previous Starting Point:** You can enter a point where the system has started to guide last time. See page 27 for the detailed steps.
8. **By Freeway Ent./Exit:** You can enter the name of the freeway (interstate) entrance or exit. See page 25 for the detailed steps.
9. **By Map Selection:** You can select a destination simply by selecting the location on the displayed map. See page 27 for the detailed steps.
10. **By Preset Destination** ( —  switches on the “Destination” screen): You can choose the destination by selecting one of the preset destination switch. In this case, it is necessary to register your desired destination beforehand. See page 28 for the detailed steps.
11. **By Home** ( switch on the “Destination” screen): You can select your own home without entering the address each time. In this case, it is necessary to register your home beforehand. See page 27 for the detailed steps.

INFORMATION

- *When inputting the destination, the response to the switch may be slow.*
- *“Points of interest” registration is made based on the NavTech “Standard POI Inclusion List” and infoUSA POI data.*
- *If there is no point registered, switches such as “Marked point”, “Home”, “Previous destination” or “Previous starting point” are dimmed and not available.*
- *The route for returning may not be the same as that for going.*
- *The route guidance to the destination may not be the shortest route or a route without traffic congestion.*
- *Route guidance may not be available if there is no road data for the specified location.*
- *When setting the destination, you should use the map on a scale of one half mile or smaller.*

- *To select an “Address”, “Point of interest”, “Freeway Ent./Exit” or “Intersection” in a different region, a search area’s change is necessary.*

CAUTION

While you are driving, be sure to follow traffic regulations and keep the road condition in mind. If a traffic sign on the road has been changed, the route guidance may provide wrong information.

AVALON_Navi_U (L/O 0307)

Destination input by ADDRESS

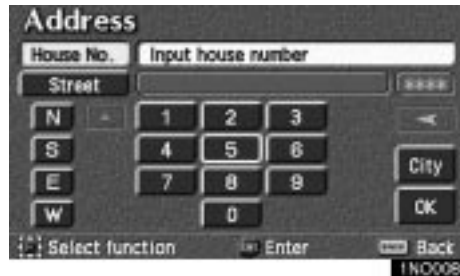

There are 2 ways to input a destination by address.

(a) Inputting a street name

Select the “Address” switch on the “Destination” screen. The “Address” screen appears, and then you can input a house number.

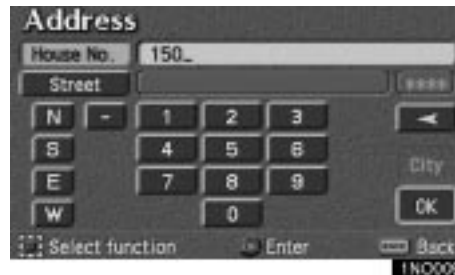

After inputting a house number, select the “OK” switch which you can input a street name.

It is possible to input a street name first. Select the “Street” switch on the display to display the screen which you can input a street name.



After each letter is inputted, the system searches the database for street names that match. Alphabet keys are dimmed if the database does not have a match for the next letter in the remaining list of matching street names.

Selecting the “À-Û” switch to display the diacritics input screen, the “0-9” switch to display the numeral input screen.

Based on your input, the number of matching sites appears at the top right of the screen. After the number decreases to some extent, select the “List” switch to display the street selection list. If the number of matches decreases to 4 or less, the screen changes automatically to the selection list.

AVALON_Navi_U (L/O 0307)

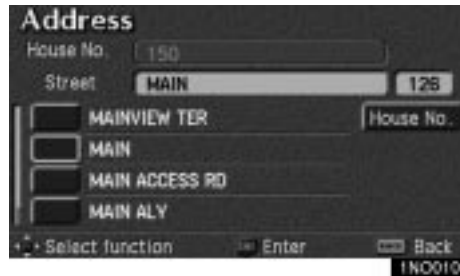

When you find your desired street name, select of the item. The screen changes and displays the map location of the selected destination and the route preference. (See “Entering destination” on page 28.)

If the same street exists in more than one city, the current screen changes to the “Select city” screen. Select or enter your desired city.



If you input a street name first, the screen changes. You can then input the house number.



If the above screen appears, you can select an address range on that screen.

(b) Inputting a city name

The screen for selecting the last 5 towns appears if you select the **“City”** switch on the “Address” screen on page 13.



5 cities are displayed on the screen.

Select the of the desired city name. The current screen changes to the screen which is for inputting a street name.

NOTICE

Under the initial condition, town name will not be displayed.

“All cities”: All cities are selected.

“5 near cities”: 5 near cities are displayed. Selecting a city in the list changes to the display to input a street name.

“Input city name”: The screen for inputting the city name appears.

The screen for inputting a city name appears if you select the **“Input city name”** switch on the “Address” screen.

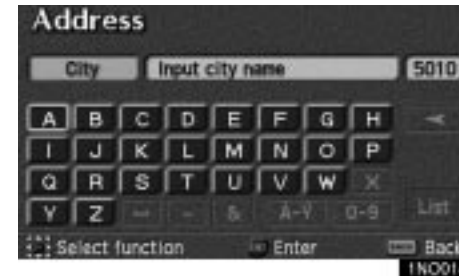

Input the city name.

After the number decreases to some extent, select the **“List”** switch to display the city selection list. If the number of matches decreases to 4 or less, the screen changes automatically to the selection list.

AVALON_Navi_U (L/O 0307)

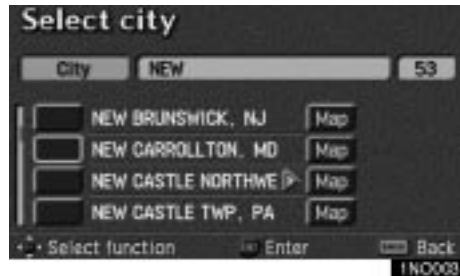

Select the of the desired city name.

Map: If you select this switch, the screen changes and displays the map location of the selected city and the route preference. (See “Entering Destination” on page 28.)

The current screen changes to the screen which is for inputting a street name.

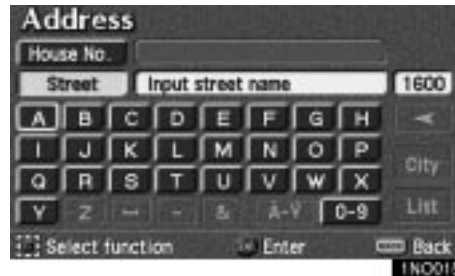

Input a street name. (See “Inputting a street name” on page 13.)

The screen changes and displays the map location of the selected destination and the route preference. (See “Entering destination” on page 28.)

Destination input by POI (Point of Interest)

There are 3 ways to select a point of interest location (POI).

- Input the name of the point of interest directly.
- Inputting a city name first.
- Selecting from the points of interest categories.

It will not take a long time for you to find your destination if you use a combination of the searching ways of (a), (b) and (c).

AVALON_Navi_U (L/O 0307)

(a) Input the name of the point of interest directly

Select the “POI” (Point of interest) switch on the “Destination” screen.

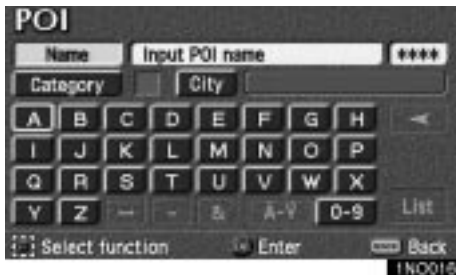

The “POI” (Point of Interest) screen appears, and then you can input the name of the point of interest.

Select letters on the screen to input a name.

Selecting the “À-☐” switch to display the diacritics input screen, the “0-9” switch to display the numeral input screen.

If the number of sites becomes 4 or less, or if you select the “List” switch at the bottom right of the screen, the screen changes and displays a list of sites.

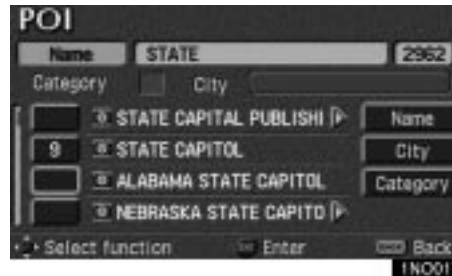

Select the of your desired destination.

You can search it more easily with the “City” and “Category” switches. (See (b) Inputting a city name and (c) Selection from the point of interest categories.)

(b) Inputting a city name

Select the “City” switch on the “POI” (Point of interest) screen.

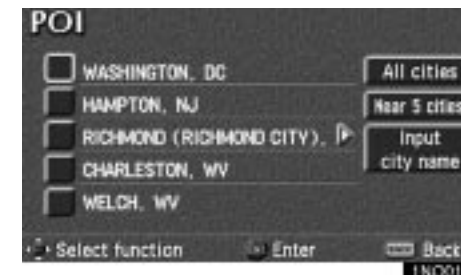

5 cities are displayed on the screen.

Select the of the desired city name. The current screen changes to the screen which is for inputting a name of point of interest.

INFORMATION

Under the initial condition, town name will not be displayed.

“All cities”: All cities are selected.

“Near 5 cities”: 5 near cities are displayed. Selecting a city in the list changes to the display to input the name of the point of interest.

AVALON_Navi_U (L/O 0307)

“Input city name”: The screen for inputting the city name appears.



Input the city name.

If the number of sites becomes 4 or less, or if you select the **“List”** switch at the bottom right of the screen, the screen changes and displays the selection list. Select the of the desired city name.

After entering the city name, input the name of the point of interest.

(c) Selection from the point of interest categories

Select the **“Category”** switch on the **“POI”** (Point of interest) screen.



The categories are shown on the screen. When you select the of your desired category, more detailed categories are shown.



When you select the of your desired category, the screen changes and displays the previous screen.

“All” categories: You can select the point of interest by the name in all categories.

AVALON_Navi_U (L/O 0307)

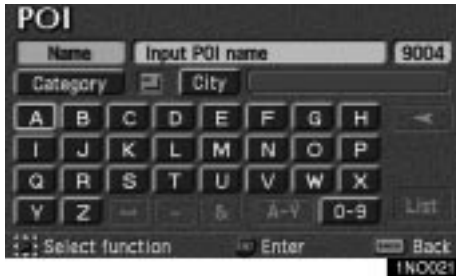

Once you have selected a category, select letters directly on the screen to input a name.

Selecting the "À-Û" switch to display the diacritics input screen, the "0-9" switch to display the numeral input screen.

If the number of sites becomes 4 or less, or if you select the "List" switch at the bottom right of the screen, the screen changes and displays a list of sites.

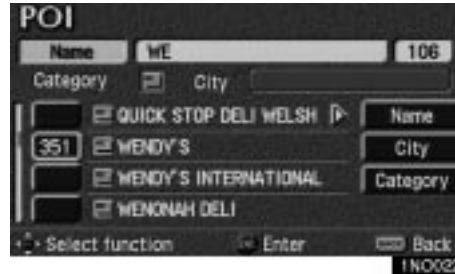

When you select the of your desired item, the screen changes and displays the map location and the route preference. (See "Entering destination" on page 28.)

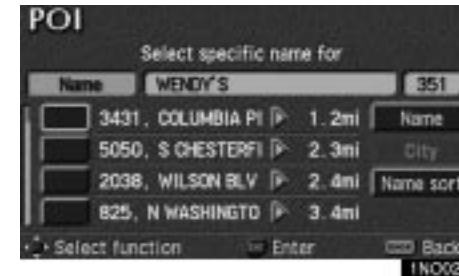

In case of having some POIs of the same name, this screen appears.

"Name sort": Select this switch to list the categories in alphabetical order.

"Dist. sort": Select this switch to list the categories in order of nearest place from your current location.

INFORMATION

The information on the desired point of interest can be displayed on the map screen.

AVALON_Navi_U (L/O 0307)

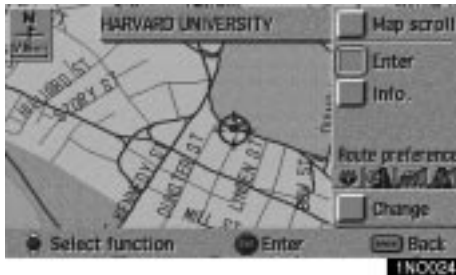

Select the **“Info.”** switch to display the selected destination name, address and telephone number.

List of points of interest



RESTAURANT



JAPANESE



CHINESE



FRENCH



ITALIAN



OTHER



AMERICAN



CONTINENTAL



MEXICAN



SEAFOOD



SHOPPING



GROCERY STORE



GAS STATION























PARKING GARAGE/HOUSE

















PARKING LOT

AVALON_Navi_U (L/O 0307)

	RENTAL CAR AGENCY		AMUSEMENT PARK		LIBRARY
	TOYOTA DEALERSHIPS		SPORTS COMPLEX		HOSPITAL
	LEXUS DEALERSHIPS		CASINO		PARK/RECREATION
	AUTOMOBILE CLUB		MARINA		CIVIC/COMMUNITY CENTER
	AUTO SERVICE & MAINTENANCE		TOURIST ATTRACTION		CONVENTION/EXHIBITION CENTER
	HOTEL		WINERY		COURT HOUSE
	GOLF COURSE		CITY HALL		TRAIN STATION
	SKI RESORT		POLICE STATION		AIRPORT

AVALON_Navi_U (L/O 0307)

	BUS STATION		MUSEUM
	COMMUTER RAIL STATION		BANK
	FERRY TERMINAL		SCHOOL
	PARK & RIDE		ATM
	REST AREA		HIGHER EDUCATION
	TOURIST INFORMATION		BUSINESS FACILITY
	HISTORICAL MONUMENT		CITY CENTER/NAMED PLACE
	PERFORMING ARTS		

Destination input by MARKED POINTS

Selecting the “Marked points” switch on the “Destination” screen displays your list of registered marked points. (Refer to pages 66 through 70 on “Registering”, “Editing” or “Deleting” marked points.)



When you select the of your desired item, the screen changes and displays the map location of the selected destination and the route preference. (See “Entering destination” on page 28.)

Then, select the “Enter” switch to start the route guidance. This new destination will not be registered as a marked point or alter the location of the marked point.

There are 3 ways to list the marked point by selecting switches.

AVALON_Navi_U (L/O 0307)

Sort by “Icon”: Select this switch to list the marked points by using the registered icon. There are 46 icons and 4 sound icons. (For details, see page 68.)

Sort by “Date”: Select this switch to list the marked points in order of registered date.

Sort by “Name”: Select this switch to list the marked points in alphabetical order.

Destination input by PREVIOUS DESTINATION

Select the “Previous destination” switch on the “Destination” screen.



The screen lists to 20 previously set destinations.

Select your desired destination. The screen changes and displays the map location of the selected destination and the route preference. (See “Entering destination” on page 28.)

You can delete the list of previous destinations while you stop your vehicle if you no longer need them. (See page 81 for details.)

Destination input by EMERGENCY

By selecting the “Emergency” switch on the “Destination” screen, the display changes to a screen to select police stations, hospitals or dealers. During driving, only nearby police stations, hospitals or dealers are shown. The current position is shown with an address, the latitude and the longitude at the top of the screen.



When you select your desired emergency category, the selected emergency category list is displayed.

AVALON_Navi_U (L/O 0307)



The distance from your current position up to the destination is displayed on the right of the name.

You can see the names of the emergency destinations in alphabetical order by selecting the **“Name sort”** switch on the screen.

Select the of your desired item. The screen changes and displays the map location of the selected destination and the route preference. (See **“Entering destination”** on page 28.)

Select the **“INFO”** switch to display the selected emergency destination name, address and telephone number.

INFORMATION

In an area which has not been registered for route guidance, the navigation does not guide. (See pages 51 and 52.)

Destination input by INTERSECTION

Select the **“Intersection”** switch on the **“Destination”** screen.



Input the name of the two intersecting streets which are located near the destination to be set.

When you select the **“List”** switch or the number of sites becomes 4 or less, the list of matching street names appears.

AVALON_Navi_U (L/O 0307)

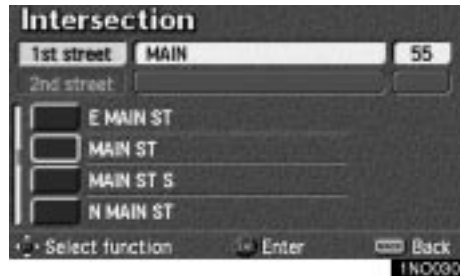

Select the of your desired item. After inputting the two intersecting streets, the screen changes and displays the map location of the selected destination and the route preference. (See “Entering destination” on page 28.)

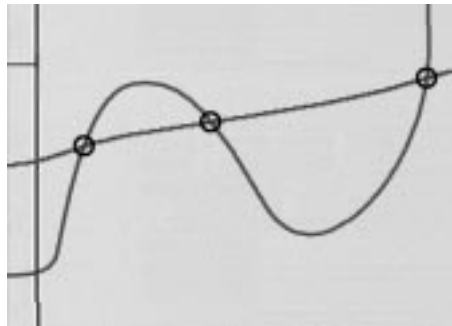

If the same two streets cross at more than one intersection, the screen changes and displays the menu to select the city name where the streets intersect. Select the city and the map location of the selected destination and the route preference. (See “Entering destination” on page 28.)

Destination input by FREEWAY ENTRANCE or EXIT

To input a freeway entrance or exit, select the “Freeway Ent./Exit” switch on the “Destination” screen.



Be sure to use the complete name of the freeway or highway, including the hyphen, when entering the destination. Freeways and interstates use an “I” (I-405). US highways use the state designation before the number (CA-118).

As the number of matching freeways decreases, you can select the “List” switch to display the list. When the number of sites becomes 4 or less, the list screen appears automatically.

AVALON_Navi_U (L/O 0307)



Choose the desired freeway by selecting the .



You can then select either a freeway “Entrance” or “Exit”.

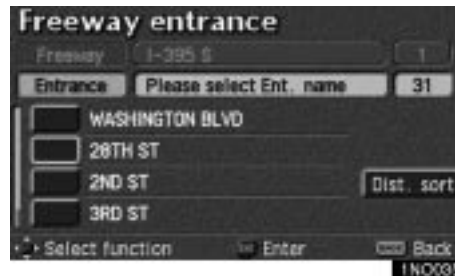

Select the of your desired entrance or exit name. The screen changes and displays the map location of the selected destination and the route preference. (See “Entering destination” on page 28.)

There are 2 ways to list the freeway entrance or exit.

“Dist. sort”: Select this switch to list the entrances or exits in order of distance from your current location.



“Name sort”: Select this switch to list the entrances or exits in alphabetical order.

AVALON_Navi_U (L/O 0307)

Destination input by PREVIOUS STARTING POINT

Select the “**Prev. start point**” switch on the “Destination” screen.

The screen changes and displays the map location of the previous starting point and the route preference. (See “Entering destination” on page 28.)

If you have not used the navigation yet, you can not set the destination by the “**Prev. start point**” switch.

Destination input by MAP

Select the “**Map**” switch on the “Destination” screen.



The screen change and displays the map location of the last map and the route preference. (See “Entering destination” on page 28.)

Destination input by HOME



Select the “ (**home**)” switch on the destination input screen.

The screen changes and displays the map location of your home and the route preference. (See “Entering destination” on page 28.)

The screen changes to display the map location of your home about 3 seconds, and then the system starts to search the way to your home.

If you have not registered your home yet, you can not set the destination by the “ (**home**)” switch.

For the steps to register or delete your home, see page 39.

Destination input by PRESET DESTINATION



Select one of the **1** — **5** switches on the “Destination” screen, the screen changes and displays the map location of your desired preset destination. In this case, it is necessary to register your desired preset destination beforehand. (Refer to pages 72 through 74, “Registering”, “Editing” or “Deleting” preset destination.)

Entering destination

After you input the destination by one of the 11 methods, the screen changes and displays the map location of the selected destination and the route preference.

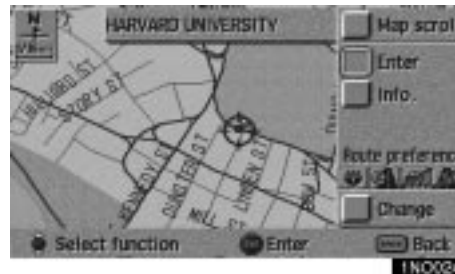

Select the “Map scroll” switch on the screen to move the cursor .

You can move and set the cursor  at a desired point. (For the method of how to move the cursor, see page 9.)

Change: Selecting this switch can change “Route preference”.

When you select the “Enter” switch, the system starts searching for a route to your destination using the conditions entered.

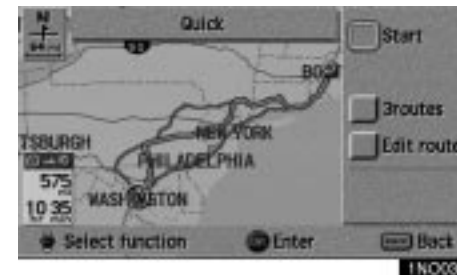

AVALON_Navi_U (L/O 0307)

If you want to set a preferred road point between the starting point and the destination or change the search condition, push the **“ENT”** button on the navigation controller to display the menu switches. And then select the **“Edit route”** switch on the screen. The screen changes and displays the edit route menu. (For details, see page 82.)

You can start the route guidance by selecting the **“Start”** switch on the screen or starting to move your vehicle.

When you keep pushing the **“ENT”** button on the navigation controller until you hear a beep, “demo” mode will start.

Route preference:

To change the conditions of the route preference.

Select the **“Edit route”** switch, and the **“Edit route”** screen appears.



Select the **“Route preference”** switch.



Select either **“Allow”** or **“Detour”** switch. When you select the **“OK”** switch, the system starts searching for a route up to the destination.

Even if you select the **“Detour”** switch, it cannot be avoid in some cases.

INFORMATION

If the calculated route includes a trip by ferry, the route guidance shows a sea route. After you travel by ferry, the current vehicle position may be incorrect. Upon reception of GPS signals, it is automatically corrected.

AVALON_Navi_U (L/O 0307)

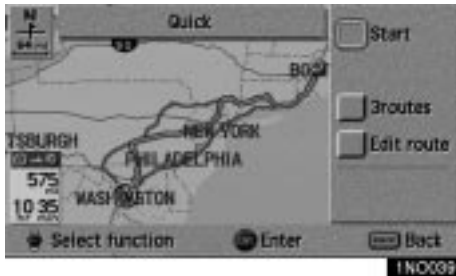

Select the **“3 routes”** switch.

“3 Routes”: You can choose your route out of 3 types of route.

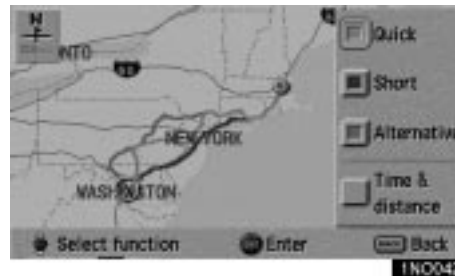

Choose one from the three routes.

“Quick”: A route on which you can reach the destination in the shortest time.

“Short”: A route on which you can reach the destination in the shortest distance.

“Alternative”: Other route.



Select the **“Time & distance”** switch to display the time and distance list.

AVALON_Navi_U (L/O 0307)

Route guidance screen

The route guidance system displays two different screen modes.



Single screen: Only map is shown in a screen mode like the above.



Split screen: Map and guidance screen are shown in a screen mode like the above. (For details about guidance screen, see page 33.)

The two route guidance screens have a number of indicators and switches with which you should be familiar.



Map screen with switch: When the “ENT” on the navigation controller is pushed while the map is displayed, the switch screen is displayed on the right side of the screen.

[GPS]: Upon reception of signals from the GPS (Global Positioning System), this mark appears. (For details, see page 49.)

“Map orient”: To switch the map orientation between “North-up” and “Heading-up”. (For details, see page 47.)

“POI”: Select this switch, and symbols of points of interest are shown on the screen. (For details, see page 42.)

“Chg. route”: The “Change route” screen appears and the following settings are available.

AVALON_Navi_U (L/O 0307)

“Mark”: Select this switch for quick registration of the marked point. (For details, see page 71.)

“Guide”: When POI icons are displayed on the map, select this switch, and the name of a POI icon near the cursor is displayed. Move the select and scroll lever to the right or left, and the name of the next POI icon is displayed. If no POI icons are displayed on the screen, “No guidance information available” is displayed. Push the **“ENT”** button while the name of a POI icon is displayed to see detailed information about that POI (name, location, phone number, etc.) displayed on the screen.

“Change”: Select this switch when you have several destinations to go. The distance and time from the current position to the destination can be displayed for each destination. When you are not traveling on the route, however, only the distance is displayed.

INFORMATION

- **The distance to your destination appears on the left of the screen.**
- **The time to your destination can also be displayed. (For the setting steps, see page 92.)**



Selecting these switches changes the guidance screen.



Selecting these switches changes the map screen.



Searching condition: To change the condition for reroute. (For details, see page 85.)

“Del. next dest.”: To delete the setting of the next destination.

“Delete preferred road”: To delete the preferred road that you registered.

“Start from adjacent road”: To start the route guidance from the adjacent road.

(ex. When the route guidance guides the route on the freeway, but you drive on the parallel way along a freeway.)

“Detour for”: To change the condition for detour. (For details, see page 41.)

“Whole route”: To calculate an entire new route to the destination.

AVALON_Navi_U (L/O 0307)

Guidance screen

The right half of the screen can be used as a guidance screen.

See also "Route guidance screen" on page 31.

Split screen near the intersection.

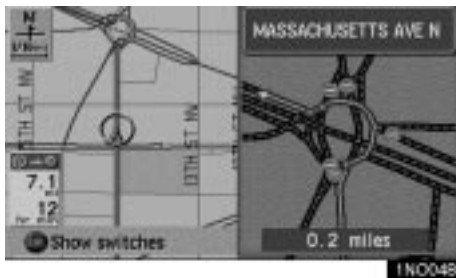

The distance to the intersection is shown at the bottom of the screen.

Split screen near the exit of the free-way.

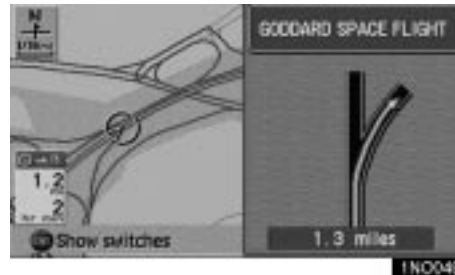

Map appearance

You can set the map mode and guidance mode.



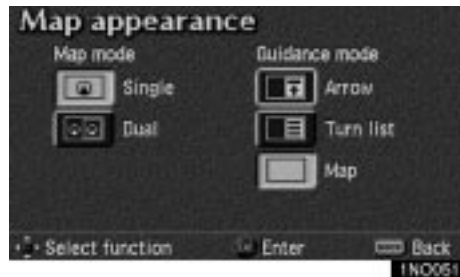

1. Push the "MENU" button on the navigation controller to display the "Menu" screen and select the "Map appearance" switch.

AVALON_Navi_U (L/O 0307)



2. It changes to the “Map appearance” screen and you can select the “Guidance mode”.

Guidance mode:

-  To display arrow screen
-  To display turn list screen
-  To display map screen

Arrow screen



This screen shows the current road name and the distance to the next corner.

Turn list screen





The screen shows the “turn list” like the above. You cannot scroll through the list of roads.

AVALON_Navi_U (L/O 0307)

Map screen



The map screen has 2 modes.

-  Single mode
-  Dual mode

Current position display



The current vehicle position mark appears in the center of the map screen. You can return to this map screen showing your current position at any time from any screen by pushing the “MAP/VOICE” button on the navigation controller.

During driving, the current vehicle position mark is fixed in the center of the screen and the map moves.

If you move the map, the current vehicle position mark continues to track your current location.

INFORMATION

When you use the map scroll feature, the current vehicle position mark may disappear from the screen. Move the map again with map scroll or push the “MAP/VOICE” button to return to the current vehicle position map location display.

The current position is automatically set as your vehicle receives signals from the GPS (Global Positioning System). If your current position is not correct, it is automatically corrected after your vehicle receives signals from the GPS.

INFORMATION

After the battery disconnection, or on a new vehicle, the current position may not be correct. As soon as the system receives signals from the GPS, the correct current position is displayed.

If you must correct the current position manually, follow the steps on page 78.

AVALON_Navi_U (L/O 0307)

The current street name will be displayed in the bottom of the screen when the setting of the current street name is on.

In some areas, the roads have not been completely digitalized in our database yet. For this reason, the route guidance may guide the road that is not allowed to pass.

Voice guidance

You can use voice guidance while driving to the destination.

You can adjust the volume of the voice or turn off voice guidance.



Push the **“MENU”** button on the navigation controller to display the **“Menu”** screen, and select the **“Volume”** switch.

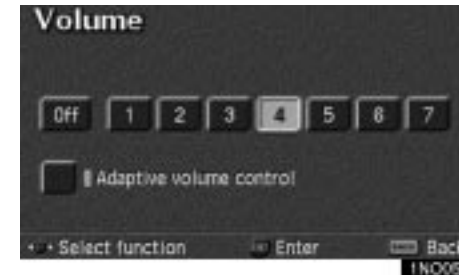

Select the volume using the switches **“1”**-**“7”**.

If you do not need voice guidance, select the **“Off”** switch.

The selected item is highlighted in green.

INFORMATION

During route guidance, the voice guidance continues even if the navigation screen is changed to other screens.

Adaptive volume control: If you select the **“Adaptive volume control”**, the volume is turned up automatically when the vehicle speed exceeds 50 mph (80 km/h).



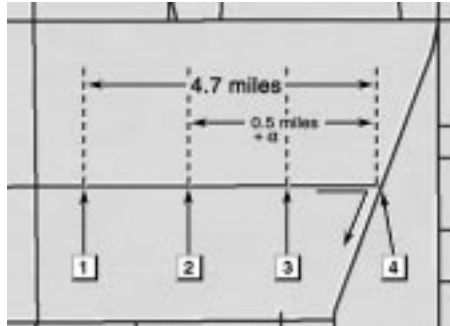

AVALON_Navi_U (L/O 0307)

To turn the system of the “**Adaptive volume control**” on, select the switch. The indicator will be highlighted.

Typical voice guidance prompts



The voice guidance provides various messages as you approach an intersection, or other point where you need to maneuver the vehicle.

- 1  “Proceed about 5 miles.”
- 2  “In a half of a mile, right turn.”
- 3  “Right turn.”
- 4  Beep sound only.

INFORMATION

On freeways, interstates or other highways with higher speed limits, the voice guidance will be made at earlier points than on city streets in order to allow time to maneuver.

AVALON_Navi_U (L/O 0307)

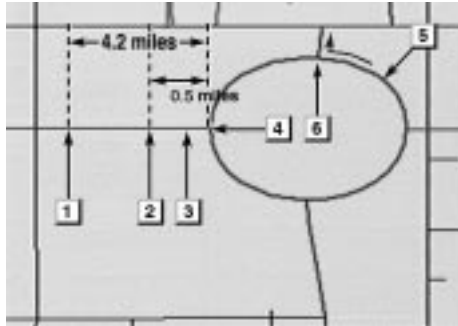

- 1 "Proceed about 4 miles to the traffic circle."
- 2 "In a half of a mile, traffic circle ahead, and then the 3rd exit."
- 3 "The 3rd exit ahead."
- 4 Beep sound only.
- 5 "The exit ahead."
- 6 Beep sound only.

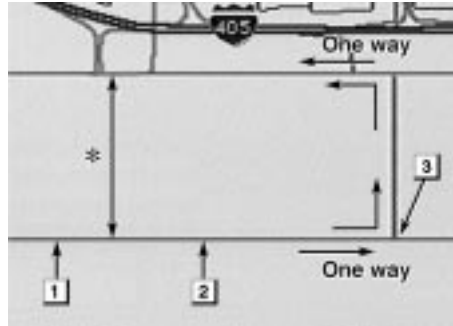

*: The system indicates a U-turn if the distance between two one-way roads (of opposite directions) is less than 15 m (50 ft.) in residential areas or 50 m (164 ft.) in non-residential areas.

- 1 "In half of a mile, make a legal U-turn ahead."
- 2 "Make a legal U-turn ahead."
- 3 Beep sound only.

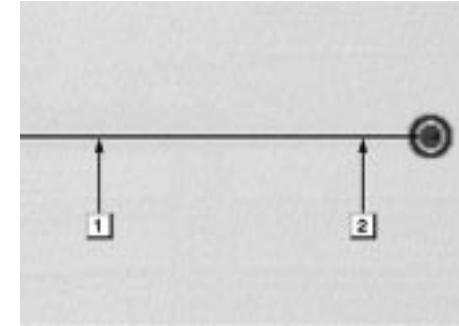

The system announces your approach to the final destination.

- 1 "Your destination is ahead."
- 2 "You have arrived at your destination. The route guidance is now finished."

AVALON_Navi_U (L/O 0307)

INFORMATION

- *Voice guidance may be made early or delayed.*
- *If the system cannot determine the current position correctly, you may not hear voice guidance or may not see the magnified intersection on the screen.*
- *If you did not hear voice guidance command, push the “MAP/VOICE” button to hear it again.*

Registration of your home

If you register your home address beforehand, you can easily set the route back to your home.



1. Push the “MENU” button on the navigation controller to display the “Menu” screen and select the “Marked points” switch.



2. Select the “Reg. home” switch for registering your home address.

If your home is already registered, the “Reg. home” switch changes to the “Delete home” switch.

AVALON_Navi_U (L/O 0307)



You may register the location of your home by some different methods: current position, address, map location, etc. Select your desired method from the menu on the screen.

Input your home in the same way as the destination input. (See page 27.)

DELETING YOUR HOME



1. Push the **“MENU”** button on the navigation controller to display the **“Menu”** screen and select the **“Marked points”** switch.



2. Select the **“Delete home”** switch.



The screen changes and displays the map location of the home and a message. If you are sure, select the **“Yes”** switch. If not, the **“No”** switch.

Detour setting

When you are driving while the route guidance is operating, you can change the route to detour around a section of the route where a delay is caused by road repairs, an accident, etc.

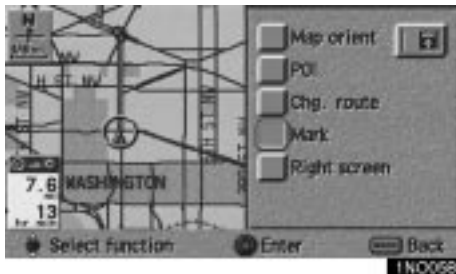

Select the **“Chg. route”** switch on the right side of the screen if you encounter a reason to divert from the selected route.

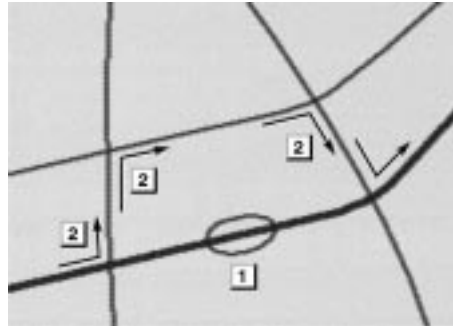

This picture shows an example of how the system would route you around a delay caused by a traffic jam.

- 1 This part indicates the location where traffic jam is occurring due to road repairs or an accident.
- 2 These show the detour route suggested by the system.



When you select the **“Chg. route”** switch, the screen changes to the **“Change route”** screen that allows you to select the distance you want to detour. Select one of the numeral keys to start the detour process. After detouring, the system returns to the original guidance route.

“Whole route”: If you select this switch, the system will calculate an entire new route to the destination.

INFORMATION
<ul style="list-style-type: none"> • <i>When your vehicle is on a freeway, the detour distance selections are 5, 15 and 25 miles.</i> • <i>The system may not be able to calculate a detour route depending on the selected distance and surrounding road conditions.</i>

“Search condition”: To change the conditions of the searching route. (See page 85.)

“Quick”: A route on which you can reach the destination in the shortest time.

“Short”: A route on which you can reach the destination in the shortest distance.

“Alternative”: Other route.

Displaying points of interest

Points of interest such as gas stations and restaurants can be displayed on the map screen. You can also set their location as a destination and use them for route guidance.

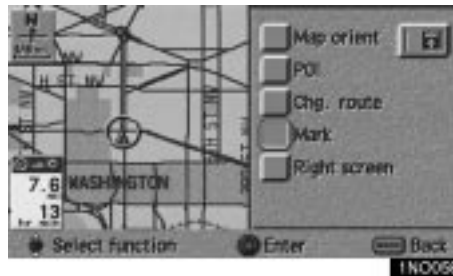

To display a particular type of point of interest on the screen, select the **“POI”** switch on the map right side of the screen.



A window with a limited choice of points of interest will be displayed. When you select your desired type of point of interest, icons will appear on the map screen indicating where the POI addresses are located.

“More”: If you cannot find your desired point of interest on the limited choice screen, select this switch. The screen then displays the more “Point of Interest” listing screen.

You can show up to 5 types of icons on the screen.

AVALON_Navi_U (L/O 0307)



When you select the point of interest type from more list, the screen will display the complete "Point of Interest" listing screen.

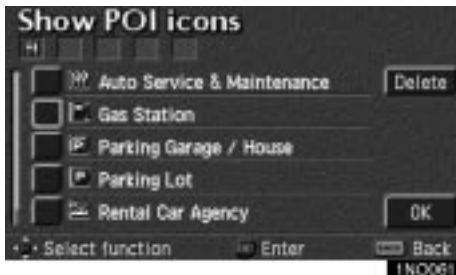

Selecting the **"Delete"** switch will delete the last selected icon.

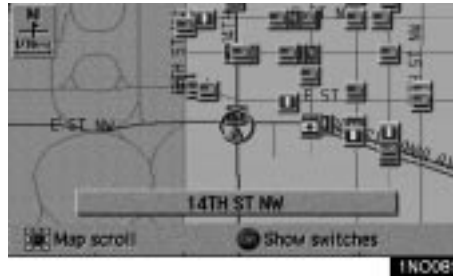

When you select a point of interest type from either the limited list or the complete list, the screen will display icons at those locations on the map screen.

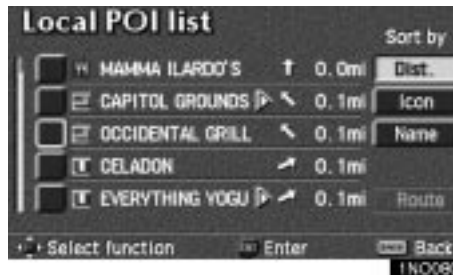

"Local POI list": Select this switch while selecting some categories of POI. The "Local POI list" screen will appear with a list of the points within 20 miles (32 km).

Sort by "Icon": Select this switch to list the points of interest in order of the type of symbol.

Sort by "Dist": Select this switch to list the points of interest in order of the distance.

Sort by "Name": Select this switch to list the points of interest in alphabetical order.

"Route": Select this switch to list the points of interest on the route in order of the distance.

To turn off the icons of the points of interest on the map screen, select the **"POI off"** switch on the screen **"Show POI icons"**.



AVALON_Navi_U (L/O 0307)

Setting a POI as a destination

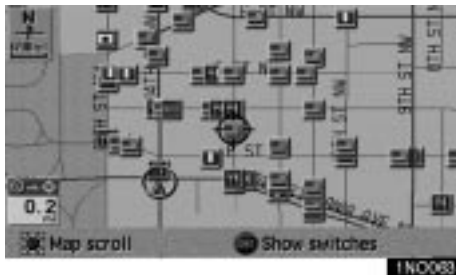
You can select one of the points of interest icons on the map screen as a destination and use it for a route guidance.



1. Select the icon of the point of interest that you want to set as a destination.

Operate the select and scroll lever to move the cursor  your desired POI icon. Then the icon "POI" is centered in the screen and it overlaps with the cursor .

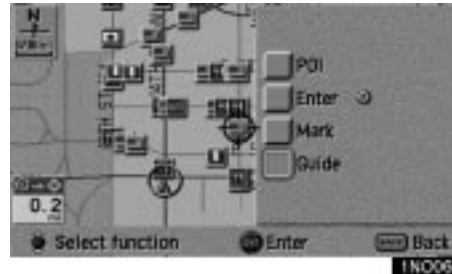

2. Push the "ENT" button on the navigation controller, and then the switch menu appears.
3. Select the "Guide" switch.

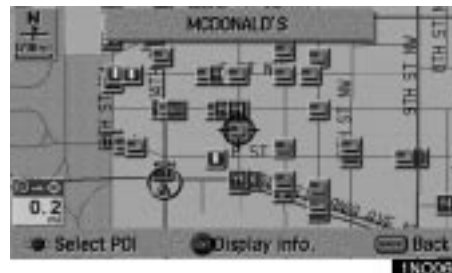

The name of the point of interest is displayed at the top of the screen. You can select the other POI icon on the displayed map.

When you push the "ENT" button on the navigation controller, the information such as the name and address, etc. are displayed.



4. If you set the point of interest as a destination, select the "Enter " switch. If not, push the "BACK" button on the navigation controller, then the previous screen returns.

AVALON_Navi_U (L/O 0307)

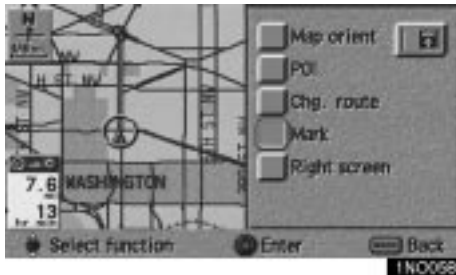

When there are 2 screens displayed, select **“Right screen”** switch. You can display the “Edit right screen”.



Select **“Show POI icons”**. POI icon is displayed when the indicator next to the is highlighted, and if not, the POI icon is not displayed.

Turn list

You can change from the map screen to a “Turn list” screen that displays the list of the roads up to your destination. This list can be used for a route guidance.



1. Push the **“MENU”** button on the navigation controller to display the menu screen and select the **“Route overview”** switch.



2. The screen will change to the “Entire route map” screen, push the **“ENT”** button on the navigation controller to display the menu switches. And then select the **“Turn list”** switch.



You can scroll through the list of roads. However, not all road names in the route may appear on the list. If a road changes its name without requiring a turn (such as on a street that runs through two or more cities), the name change will not appear on the list. The street name closest to the starting point will be displayed with a mileage to the next turn.

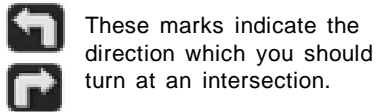

Select the **“Map”** switch on the “Turn list” screen of your desired point. The point which you choose is displayed on the map screen.

INFORMATION

- *The current vehicle position mark appears at the bottom of the screen next to the name of the street you are driving on. The mark does not move.*
- *If you leave the guidance route, the name of the street you are on is not shown on the list next to the current vehicle position mark.*
- *If the road type you are on changes between a highway, a main street or a residential street (at an interchange or fork), it will appear on the turn list.*
- *If a long route has been selected, it may take a long time to display the turn list.*
- *Push the “MAP/VOICE” button on the navigation controller to return to the map display with route guidance.*

Map scale



The map scale can be changed by sliding the zoom in/out buttons of the navigation controller to the **“+▼”** (zoom in) side or to the **“-▲”** (zoom out) side while the map is displayed and while guiding as well. The scale runs from 1/32nd of a mile to 128 miles. Slide and release the zoom in/out buttons to the **“+▼”** side or **“-▲”** side to change the scale one step at a time. Slide and hold either side of the buttons to zoom in or out smoothly.



The map scale is displayed under the “North-up” symbol or “Heading-up” symbol at the top left of the screen.

AVALON_Navi_U (L/O 0307)

Screen scrolling



If you wish to look at a different point on the map other than your current vehicle position, you can bring the desired point to the center of the screen by using the scroll feature.

Move the cursor mark  to the point you desire by operating the select and scroll lever of the navigation controller. Push the “ENT” button on the navigation controller, and select the “Enter ” switch.

If you continue to hold the lever by your finger on the navigation controller, the map will continue scrolling in that direction until you lift your finger.

After scrolling the screen, the map remains centered at the selected location until you push the “MAP/VOICE” button. The current vehicle position mark will continue to move along your actual route and may move off the screen. When you push the “MAP/VOICE” button, the current vehicle position mark returns to the center of the screen and the map moves as you proceed on your route.

INFORMATION

If you enter a destination using the screen scrolling function, the road nearest to the point you selected is set as the destination. At this time, if the nearest road is over 4 miles from destination point, the system may not be able to calculate a guidance route.

Orientation of the map



You can change the orientation of the map from “North-up” to “Heading-up”.

AVALON_Navi_U (L/O 0307)



“North-up” symbol

Regardless of the direction of vehicle travel, the north is always up.



“Heading-up” symbol

The direction of the vehicle travel is always up. A red arrow indicates the north.

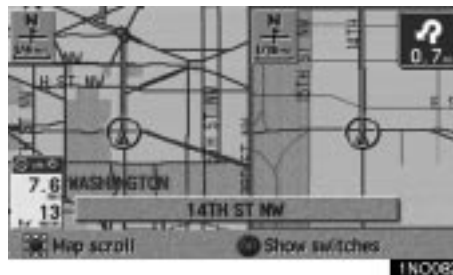

1. Push the “ENT” button while the map screen is displayed.

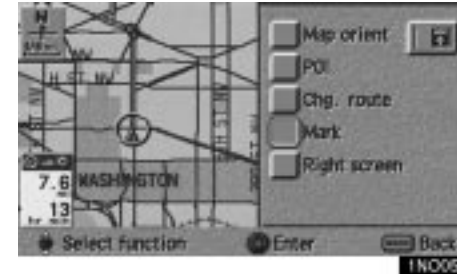

2. When the “Map orient” at the right side of the screen is selected, the orientation of the map screen is switched between the “North-up” and the “Heading-up.” When there are 2 map screens displayed, the “North-up” and the “Heading-up” of the left side map screen is switched by this operation.

AVALON_Navi_U (L/O 0307)

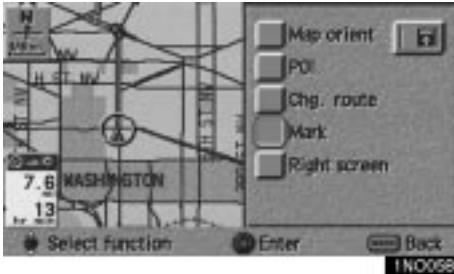

3. When there are 2 map screens displayed to switch the “North-up”/“Heading-up” of the right screen map, select “Right screen” switch.



4. Select the “Map orient” of the “Edit right screen”, and then the “North-up”/“Heading-up” of the right screen is switched.

When 2 map screens are displayed, you can set one as the “North-up” and the other one as the “Heading-up.”

Limitations of the navigation system

This navigation system calculates the current vehicle position using satellite signals, various vehicle signals, map data, etc. However, an accurate position may not be shown depending on the satellite condition, road configuration, vehicle condition or other circumstances.

The Global Positioning System (GPS) developed and operated by the U.S. Department of Defense provides an accurate current vehicle position using 3 to 4 satellites. The GPS system has a certain level of inaccuracy built in for security reasons. While the navigation system will compensate for this most of the time, occasional positioning errors up to 300 feet can and should be expected. Generally, position errors will be corrected within a few seconds.

AVALON_Navi_U (L/O 0307)



When your vehicle is not receiving signals from the satellites, the "GPS" mark does not appear at the screen.

The GPS signal may be physically obstructed, leading to inaccurate vehicle position on the map display. Tunnels, tall buildings, trucks, or even the placement of objects on the instrument panel may obstruct the GPS signals.

The installation of window tinting may also obstruct the GPS signals. Most window tinting contains some metallic content that will interfere with the GPS signal reception. We recommend not to use the window tinting on vehicles equipped with navigation systems.

The GPS satellites may not send signals due to repairs or improvements being made to them.

Even when the navigation system is receiving good GPS signals, the vehicle position may not be shown accurately or inappropriate route guidance may occur in some cases.

(a) Accurate current vehicle position may not be shown in the following cases:

- When driving on a small angled Y-shaped road.
- When driving on a spiral road.
- When driving on a slippery road such as in sand, gravel, snow, etc.
- When driving on a long straight road.
- When freeway and surface streets run in parallel.
- After moving by ferry or vehicle carrier.
- When a long route is searched during high speed driving.
- When driving without setting the current position calibration correctly.
- After repeating a change of directions by going forward and backward, or turning on a turntable in the parking lot.
- When leaving a covered parking lot or parking garage.
- When a roof carrier is installed.
- When driving with the tire chains installed.
- When the tires are worn.
- After replacing a tire or tires.

AVALON_Navi_U (L/O 0307)

- When using tires that are smaller or larger than the factory specifications.
- When the tire pressure in any of the four tires is not correct.

INFORMATION

If your vehicle cannot receive GPS signals, you can correct the current position manually. For the information on setting the current position calibration, see page 78.

(b) Inappropriate route guidance may occur in the following cases:

- When turning at a wrong intersection off the designated route guidance.
- If you are heading for a destination without passing through a set preferred road, automatic rerouting may display a route returning to the set preferred road.
- When turning at an intersection, there is no route guidance.
- When passing through the intersection, there is no route guidance.
- During automatic rerouting, the route guidance may not be available for the next turn to the right or left.
- It may take a long time to operate automatic rerouting during high speed driving. In automatic rerouting, a detour route may be shown.
- During automatic rerouting, the route may not be changed.
- The route in a U-turn may be shown or announced.
- A location may have multiple names and the system will announce one or more.
- Some routes may not be searched.
- If the route to your destination includes gravel, unpaved roads or alleys, the route guidance may not be shown.
- Your destination point might be shown on the opposite side of the street.
- When a portion of the route has regulations prohibiting the entry of the vehicle that vary by time or season or other reason.
- The road and map data stored in your navigation system may not be complete or may not be the latest release.

After replacing the tire, implement the operation described in the “Current position calibration”. (For details, see page 78.)

This navigation system uses the tire turning data and is designed to work with factory-specified tires for your Toyota. Installing tires that are larger or smaller than the originally equipped diameter may cause inaccurate display of the vehicle's position. The tire pressure also affects the diameter of the tires so please make sure the tire pressure of all four tires is correct.

AVALON_Navi_U (L/O 0307)

Map database information and updates

This system uses the maps of DENSO based on NAVTECH maps, GDT maps and infoUSA POIs.

©2002 Navigation Technologies. All rights reserved.

©GDT, Geographic Data Technology, Inc.

Data by infoUSA Copyright ©2002, All rights reserved.

This product contains proprietary and confidential property of NAVTECH, GDT and infoUSA. Unauthorized use, including duplication of this product is expressly prohibited.

There are two types of areas available for route guidance. (See the following pages.) In one type of area, primarily around metropolitan centers, detailed route guidance is available for the entire area. In the other type of area, all roads are displayed on the map but route guidance is limited. The navigation route might lack precision because the data (no right turns, one-way traffic, etc.) is not completed. It is still possible to reach the destination by following the arrow direction and distance as shown on the bottom left of the screen. The arrow points in the direction of the destination. The distance shown is as measured in a straight line from the current vehicle position to the destination area.

COPYRIGHT NOTICE: This area includes information taken with permission from Canadian authorities, including ©Her Majesty the Queen in Right of Canada, ©Queen's Printer for Ontario.

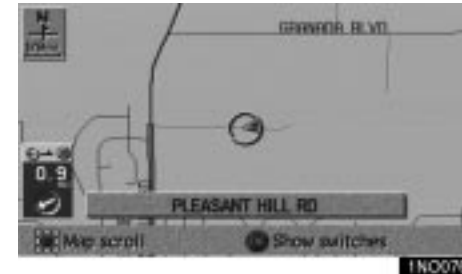

In order to provide you with accurate map information as much as possible, we are always gathering information such as road repairs and doing site investigation. However, the names of roads, streets, facilities, and their locations are often changed. In some places, construction on roads may be in progress. For that reason, information on some areas in this system might be different from the actual location.

AVALON_Navi_U (L/O 0307)



The map database is normally updated once a year. Contact your Toyota dealer for information about the availability and pricing of an update.



DVD: To determine which version of the database is currently in your vehicle, select the **“DVD”** switch on the “Menu” screen. The “DVD information” screen appears and displays the map database version.

ROUTE GUIDANCE AVAILABILITY

Route guidance available area for detailed roads and for main roads are provided.

The software covers the route guidance available area as shown in the following “Route guidance availability” illustrations.

Route guidance available areas may change due to the upgrading of the map data.

SECTION II

ADVANCED FUNCTIONS

Descriptions of functions for more effective use

Marked points	66
Preset destinations	72
Area to avoid	74
Current position calibration	78
Edit route	80
Setting a preferred road	82
Search condition	85
Route overview	85
Route preview	86



AVALON_Navi_U (L/O 0307)

Marked points

You can register and keep your own marked points of interest list (like restaurants, sports facilities, etc.) and use the marked points to input a destination.

(a) Registering marked points



1. Push the **“MENU”** button on the navigation controller to display the **“Menu”** screen and select the **“Marked points”** switch.



2. Select the **“Register”** switch of the **“Marked points”**.



- A screen similar to that for destination input appears. Input the address of the marked point in the same way as any destination input. See page 9.

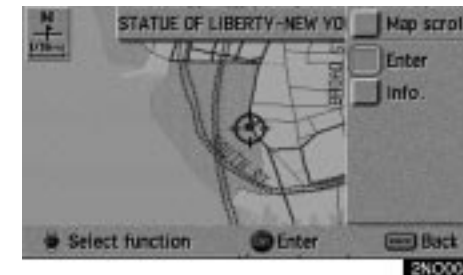

3. Select the **“Enter”** switch on the screen and push the **“ENT”** button on the navigation controller.

AVALON_Navi_U (L/O 0307)



The screen to register an icon appears a couple of seconds later.

Select your desired icon.

You can turn the page by selecting **“Page 1”** or **“Page 2”** switch.

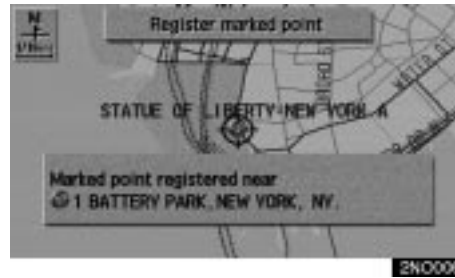

INFORMATION

Up to 100 marked points can be registered.



Selecting the **“With sound”** switch, select your desired sound. When your vehicle approaches the marked point, the sound which you chose will sound.

“Bell (with direction)”: The bell sounds only when your vehicle approaches to the marked point from your setting direction.

AVALON_Navi_U (L/O 0307)

(b) Editing marked points

Once a marked point is registered, you can edit the icon, name or telephone number.

1. Push the **"MENU"** button on the navigation controller to display the **"Menu"** screen and select the **"Marked points"** switch.

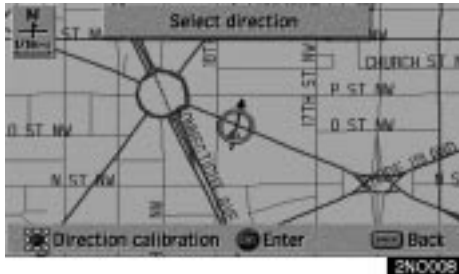

Operate the select and scroll lever of the navigation controller, so that the direction is facing to your desired direction.

Push the **"ENT"** button on the navigation controller and the map screen returns.



2. Select the **"Edit"** switch of the **"Marked points"**.



The screen lists the marked points.

Sort by "Icon": Select this switch to list the marked points in order of the type of icon.

Sort by "Date": Select this switch to list the marked points in order of the registered date.

Sort by "Name": Select this switch to list the marked points in alphabetical order.

Select switch of the desired marked point to display the edit marked point screen.

AVALON_Navi_U (L/O 0307)



3. Select the **“Change”** switch which you want to edit.

CHANGING THE ICON

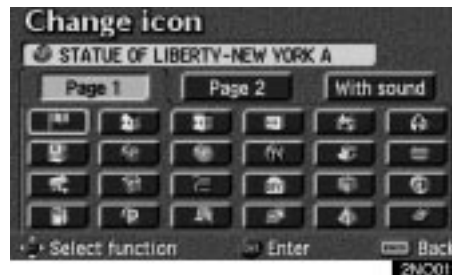

Select your desired icon.

CHANGING THE NAME



Select alphabet or numeral keys to input the name.

After you finish your entry, select the **“OK”** switch on the screen.

The previous screen will be displayed.

AVALON_Navi_U (L/O 0307)

CHANGING THE PHONE NUMBER



Select numeral keys.

After you finish your entry, select the “OK” switch on the screen.

The previous screen will be displayed.

EDITING THE LOCATION (position/map location)



Operate the select and scroll lever to move the cursor to the desired point on the map.

Push the “ENT” button on the navigation controller when the cursor is your desired point.

The previous screen will be displayed.

SHOW NAME

You can set the name of marked point either to show or not on the screen.

To show the name, select the “On” switch. Not to show it, select the “Off” switch.

(c) Deleting marked points

1. Push the “MENU” button on the navigation controller to display the “Menu” screen and select the “Marked points” switch.



2. Select the “Delete” switch of the “Marked points”.

(d) Quick marked point registration

You can register your current position or any points (See “Screen Scrolling” on page 47.) from the map screen.

1. Move the cursor  to the desired point, and if you wish to register that point, push the “ENT” button on the navigation controller.



3. Select switch of the marked point to delete. If you want to delete all of the marked points, select the “Del. all” switch.

To delete only specified marked points, use the sort by “Icon”, “Date” or “Name” switch to display the screen, so that you can easily find the marked points.

Messages appear depending on the type of deletion. If you want to delete, select the “Yes” switch. To cancel the deletion, select the “No” switch.

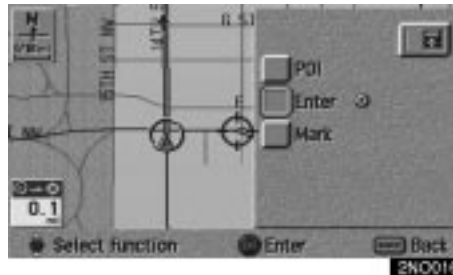

2. Select the “Mark” switch.



When you select the “Mark” switch, the above screen appears for a few seconds, and then the map screen will be displayed.

To change the icon or name, etc., see “(b) Editing marked points”.

AVALON_Navi_U (L/O 0307)

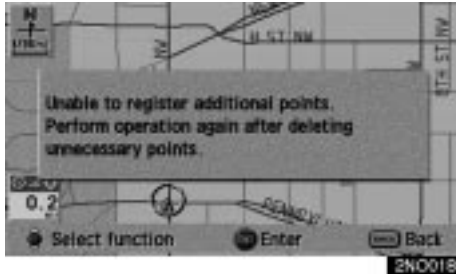

You can register up to 100 marked points. If you attempt to register more than 100, a message appears for confirmation.

If you want to register a new point, push the **"MENU"** button on the navigation controller to display the menu screen and select the **"Marked points"** switch. Delete several old points by following the "(c) Deleting marked points".

Preset destinations

You can set up to 5 destinations beforehand.

(a) Registering preset destinations

1. Push the **"MENU"** button on the navigation controller to display the **"Menu"** screen and select the **"Marked points"** switch.



2. Select the **"Register"** switch of **"Preset dest."**.

AVALON_Navi_U (L/O 0307)



3. Select the “①~⑤” switch to register the preset destination you want.

If you have already registered the preset destination, you can overwrite on the present registered destination.



4. Input the preset destination in the same way as the destination inputs. (See page 9.)

(b) Editing preset destinations

1. Push the “MENU” button on the navigation controller to display the “Menu” screen and select the “Marked points” switch.



2. Select the “Edit” switch of “Preset dest.”.



3. Select the switch that you want to edit.



You can change the name, location and phone No. of the preset destination.

Select the “Change” switch. (See page 68.)

(c) Deleting preset destinations

1. Push the “MENU” button on the navigation controller to display the “Menu” screen and select the “Marked points” switch.



2. Select the “Delete” switch of “Preset dest.”.



3. Select the preset destination that you want to delete and select the switch.

Messages appear depending on the type of deletion. If you want to delete, select the “Yes” switch. To cancel the deletion, select the “No” switch.

Area to avoid

Any areas you want to avoid due to traffic jams, construction work or other reasons can be registered as avoid areas.

Push the “MENU” button on the navigation controller to display the “Menu” screen and then select the “Marked points” switch to display the following screen.



INFORMATION

- Some areas and freeways may not be able to be set as an avoid point.
- If the route calculation cannot be made without running through the area to avoid, a route passing through the area to avoid may be shown.

AVALON_Navi_U (L/O 0307)

(a) Registering area to avoid

1. Select the “Register” switch of the “Area to avoid”.



2. Enter the location in the same way as you input any destination or display the map of the area you want to avoid. (See pages 13 through 28.)

INFORMATION

Only 10 points can be registered as area to avoid. If there are 10 points already registered, the message “Unable to register additional points. Perform operation again after deleting unnecessary points.” appears on the screen.

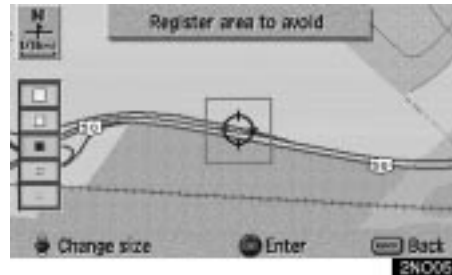

3. When any of the “detour gauge” at the left side of the screen is selected, a box appears around the cursor . This is to determine the area to avoid. Select the “detour gauge” you desire.

When you push the “ENT” button on the navigation controller, the message appears.

INFORMATION

When the above screen is displayed, if the map scale is larger than 1/80,000, the message “Position cannot be specified in this scale. Switch to more detailed map.” appears on the screen. Set the map scale, so that it is more detailed than 1/80,000.

AVALON_Navi_U (L/O 0307)

(b) Editing area to avoid

1. Select the “Edit” switch of the “Area to avoid” to display the “Edit area to avoid” screen.



2. Select the area to avoid switch you want to edit.



3. Select the “Name”, “Location” or “Change area size” on this screen.

CHANGING THE NAME



Select alphabet or numeral keys to input the name.

After you finish your entry, select the “OK” switch on the screen.

The previous screen will be displayed.

AVALON_Navi_U (L/O 0307)

CHANGING THE LOCATION

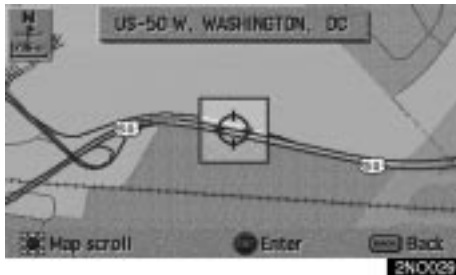

Move the cursor  to your desired point, and push the **“ENT”** button of the navigation controller.

CHANGING THE AREA SIZE

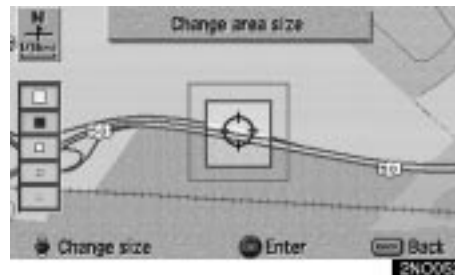

Select one of the “detour gauge” on the left side of this screen if you want to change the area size.

(c) Deleting area to avoid

1. Select the **“Delete”** switch of the “Area to avoid” to display the “Delete area to avoid” screen.



2. Select the area you want to delete from the list.

Del. all: All registered areas to avoid in the system are deleted.

3. Messages appear depending on the type of deletion. If you want to delete, select the **“Yes”** switch. To cancel the deletion, select the **“No”** switch.

AVALON_Navi_U (L/O 0307)

Current position calibration

The current vehicle position mark will be automatically corrected during driving on reception of GPS signals. If your vehicle cannot receive GPS signals, you can correct the current position mark manually.



1. Push the “MENU” button on the navigation controller to display the “Menu” screen, and then select the “Setup” switch.

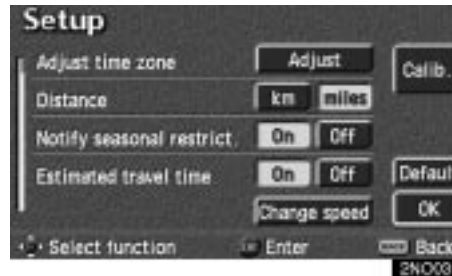

2. Select the “Calib.” switch on the right side of the screen.

The next screen appears.



3. Select the “Position/Direction” switch.

INFORMATION

For additional information on current position accuracy, see “Limitations of the Navigation System” on page 49.

AVALON_Navi_U (L/O 0307)

POSITION/DIRECTION CALIBRATION

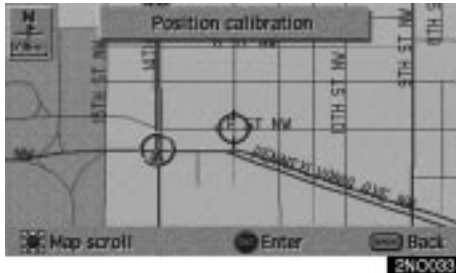

1. Move the cursor mark  to your desired point by operating the select and scroll lever of the navigation controller.

Push the **“ENT”** button on the navigation controller.



2. Operate the select and scroll lever of the navigation controller, so that the screen direction is facing to your desired direction.

Push the **“ENT”** button on the navigation controller, and then the map screen will be displayed.

TIRE CHANGE CALIBRATION

The tire change calibration function should be used when the tires are replaced. This will adjust for any possible change in tire circumference from the old tires to the new ones. If this procedure is not performed when tires are replaced, the current vehicle position mark may become incorrect.

To execute the fast distance tire calibration procedure, select the **“Tire change”** switch on the “Calibration” screen.

The message appears and the fast distance calibration is automatically started. A few seconds later, the map screen will be displayed.

AVALON_Navi_U (L/O 0307)

Edit route

(a) Adding a destination

1. Push the “MENU” button on the navigation controller to display the “Menu” screen.



2. Select the “Edit route” switch on the screen.



3. Select the “Add” switch of “Destination”.
4. Input an additional destination in the same way as the destination input. (See page 28.)



5. The “Add destination” screen appears. Select the “Add” switch on the right side of the screen that you want to add as destination.

AVALON_Navi_U (L/O 0307)

(b) Reordering a destination

1. Push the “MENU” button on the navigation controller to display the “Menu” screen and select the “Edit route” switch on the screen.



2. Select the “Reorder” switch of “Destination”.



3. Choose the destinations in the order of arrival by selecting the switch on the left side of the screen.

After you finished selecting the destinations, select the “OK” switch.

The previous screen will be displayed.

(c) Deleting a destination

1. Push the “MENU” button on the navigation controller to display the “Menu” screen and select the “Edit route” switch on the screen.



2. Select the “Delete” switch of “Destination”.

AVALON_Navi_U (L/O 0307)



3. Select the switch of the destination that you want to delete.

Select the **“Del. all”** switch if you want to delete all destinations.

4. Messages appear depending on the type of deletion. If you want to delete, select the **“Yes”** switch. To cancel the deletion, select the **“No”** switch.

To delete a previous destination:

1. Push the **“MENU”** button to display the **“Menu”** screen and select the **“Marked points”** switch on the screen.
2. Select the **“Del. prev. dest.”** switch.
3. Do the same procedure as deleting a destination.

Setting a preferred road (a) Adding a preferred road

1. Push the **“MENU”** button on the navigation controller to display the **“Menu”** screen and select the **“Edit route”** switch on the screen.



2. Select the **“Add”** switch of the **“Set preferred road”** and then the following screen appears.

AVALON_Navi_U (L/O 0307)



3. Move the cursor  to your desired location and push “**ENT**” button on the navigation controller.

Messages appear to confirm your request on the screen.

Select the “**Enter**” switch to register the road.

Select the “**Next**” switch when you change the road.



4. The “Add preferred road” screen appears. Select the “**Add**” switch if you want to add as preferred road.

(b) Modifying a preferred road

1. Push the “**MENU**” button on the navigation controller to display the “Menu” screen and select the “**Edit route**” switch on the screen.



2. Select the “**Modify**” switch of the “Set preferred road”. The “Modify preferred road” screen appears.

AVALON_Navi_U (L/O 0307)

(c) Deleting a preferred road



3. Select the preferred road which you want to modify and select the switch.

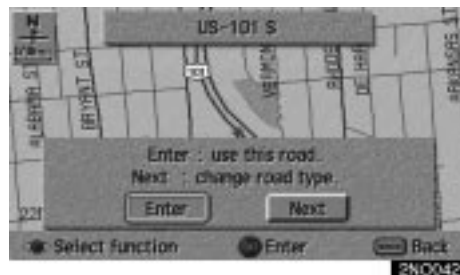

4. Do the same procedure as "Adding a preferred road". (See (a), page 82.)

1. Push the "MENU" button on the navigation controller to display the "Menu" screen and select the "Edit route" switch on the screen.



2. Select the "Delete" switch of the "Set preferred road". The "Delete preferred road" screen appears.



3. Select the preferred road which you want to delete. Select the "Del. all" switch if you want to delete all the preferred roads.
4. Messages appear depending on the type of deletion. If you want to delete, select the "Yes" switch. To cancel the deletion, select the "No" switch.

AVALON_Navi_U (L/O 0307)

Search condition

1. Push the **“MENU”** button on the navigation controller to display the **“Menu”** screen and select the **“Edit route”** switch on the screen.



2. Select the **“Search condition”** switch of **“Condition”**. The **“Search condition”** screen appears.



“Quick”: A route on which you can reach the destination in the shortest time.

“Short”: A route on which you can reach the destination in the shortest distance.

3. Select the **“Quick”** or **“Short”** switch and select the **“OK”** switch.

Route overview

You can see the entire route from the starting point to the destination.



1. Push the **“MENU”** button on the navigation controller to display the **“Menu”** screen and select the **“Route overview”** switch on the screen. The route overview screen appears.



AVALON_Navi_U (L/O 0307)

Route preview





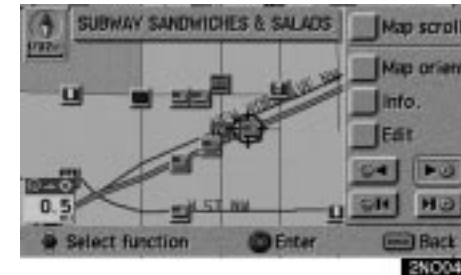

The entire route from the starting point to the destination is displayed.

You can preview the route from the starting point to the destination.



1. Push the “MENU” button on the navigation controller to display the “Menu” screen and select the “Route preview” switch on the screen. The route preview screen appears.



-  To display the next destination
-  To preview the route to the next destination
-  To preview the route to the next destination fast
-  To stop previewing
-  To preview the route to the previous departure position
-  To preview the route to the previous departure position fast
-  To display the previous departure position

AVALON_Navi_U (L/O 0307)

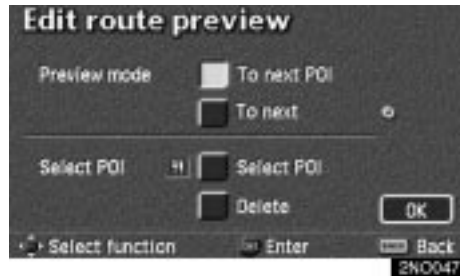

2. Select the **“Edit”** switch. The **“Edit route preview”** screen appears.

“To next POI”: To preview the next POI

“To next ☉”: To preview the next destination

If the points of interest you selected are on the route, they are displayed on the screen.

“Select POI”: To select the POI icon

“Delete”: To delete the POI icon



3. Select your desired category of point of interest.



4. Select your desired icon from the list and select the **“OK”** switch.

AVALON_Navi_U (L/O 0307)

SECTION III

MORE ADVANCED FUNCTIONS

Convenient features

Setup	90
Map color	91
Automatic rerouting	91
Time to destination	92
Adjust time zone	93
Distance	94
Notify seasonal restrict	95
Voice guide in all modes	95
Current street name	96
Maintenance information	97
Dealer setting	99
Calendar with memo	102



AVALON_Navi_U (L/O 0307)

Setup

You can set the values shown on the “Setup” screen.

1. Select the “MENU” button on the navigation controller.



2. Select the “Setup” switch to display the “Setup” menu screen. Select your desired items you want to set. Selected items will be highlighted in green.



3. Select the “OK” switch on the screen and then the previous screen will be displayed.

“Default”: Select the “Default” switch on the right side of the screen. All of the settings can be defaulted.

“Map color” (day or night): You can select your desired map color.

“Auto reroute”: You can set the system will or will not automatically search for a new route to the destination.

“Estimated travel time”: You can set to display the time required to reach the destination on the route guidance screen.

“Adjust time zone”: You can select your desired time zone.

“Distance”: You can change “km” or “miles” to display your desired units.

“Notify seasonal restrict”: You can select to notify or not to notify a seasonal restrict.

“Voice guide in all modes”: You can set the voice guide in all modes or not.

“Current street name”: You can select to show or not to show a current street name on the map screen.

“Operation guide on map”: Display or non-display of the operation guide on the display can be selected.

AVALON_Navi_U (L/O 0307)

Map color

1. Push the “MENU” button on the navigation controller.



2. Select the “Setup” switch.

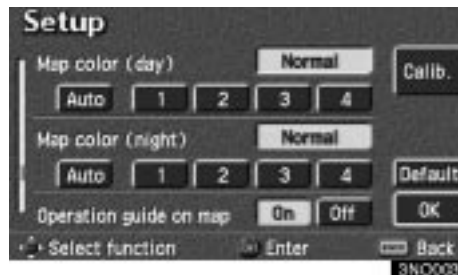

3. Select your desired day and/or night map color and then select the “OK” switch to return the map screen. See “The map color list” on this page for details.

Select the “Normal” switch to default the map color.

Select the “Auto” switch to select the map color automatically.

When you select the “Auto” switch, the map color is changed in every three month.

The map color list

Switch NO.	The map color	Schedule
1	Green	Mar. - May
2	Blue	Jun. - Aug.
3	Gray	Sep. - Nov.
4	Beige	Dec. - Feb.

Automatic rerouting

When the “Auto reroute” feature is turned on, the system will automatically search for a new route to the destination if you leave the guidance route. This feature does not operate while you are driving on roads where the guidance is not available.

To turn the “Auto reroute” mode on:

1. Push the “MENU” button on the navigation controller.



2. Select the “Setup” switch.

AVALON_Navi_U (L/O 0307)

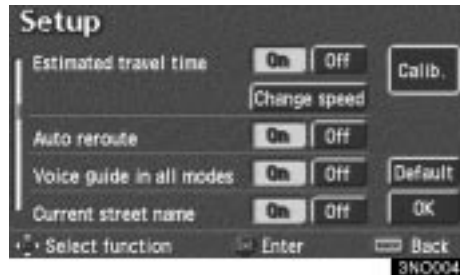

3. Select the “On” switch of “Auto reroute”.

Selected switch is highlighted in green.

INFORMATION

If your vehicle leaves the guidance route, the system searches for a new route to the destination. The new route may or may not take you back to the previous route depending on how far you are off the original guidance route.

Time to destination

When the “Estimated travel time” feature is turned on, the time preferred to reach the destination is displayed on the route guidance screen.



To turn the “Estimated travel time” mode “On”:

1. Push the “MENU” button on the navigation controller.



2. Select the “Setup” switch.

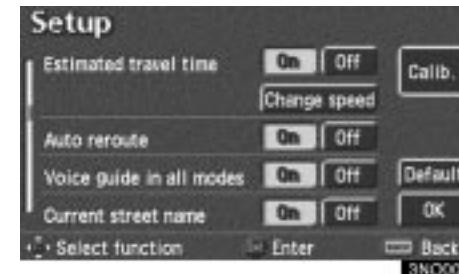

3. Select the “Change speed” switch on the “Setup” screen.

AVALON_Navi_U (L/O 0307)

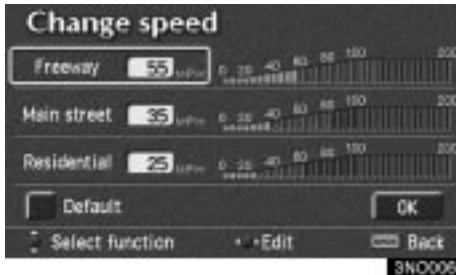

4. You can set the speed as your desire by operating the select and scroll lever of the navigation controller. Select the item by moving the lever vertically, and move the lever horizontally to set the speed.

If you select the “Default” switch, the default speed is set at each item.

5. After you finish setting the desired speeds, select the “OK” switch on the right side of the screen.
6. The “Setup” screen will be displayed. Select the “On” switch of “Estimated travel time”.

Selected switch is highlighted in green.

INFORMATION

- The displayed time to the destination is the approximate driving time calculated based on the speeds you selected and your actual position along the guidance route.
- The time shown may vary greatly depending on your progress along the route (which may be affected by road conditions such as traffic jams, construction work, etc.).
- Up to 99 hours 59 minutes can be displayed.

Adjust time zone

1. Push the “MENU” button on the navigation controller.



2. Select the “Setup” switch.

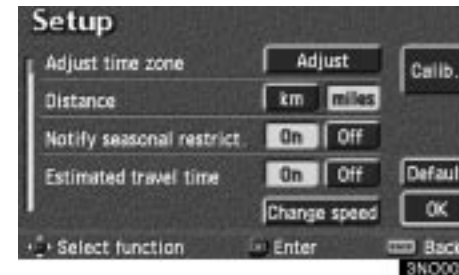

3. Select the “Adjust” switch. The “Adjust time zone” screen appears on the display.

AVALON_Navi_U (L/O 0307)



4. Select your desired time zone.

Selected switch is highlighted in green.

Daylight saving time: Select the “On” switch on the screen and then select 

or  to set the day light saving time.

5. Select the “OK” switch on the screen and the “Setup” screen will be displayed.

Distance

1. Push the “MENU” button on the navigation controller.



2. Select the “Setup” switch on the screen.

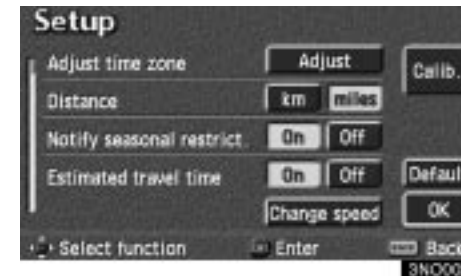

3. Choose the “km” or “miles” switch of “Distance” to select your desired units.

Selected switch is highlighted in green.

4. Select the “OK” switch.

AVALON_Navi_U (L/O 0307)

Notify seasonal restrict

1. Push the “MENU” button on the navigation controller.



2. Select the “Setup” switch on the screen.



3. Select the “On” switch of “Notify seasonal restrict” and select the “OK” switch.

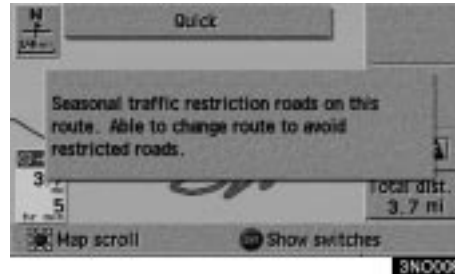

The restricted road icon and the message may appear on the screen.

Voice guide in all modes

1. Push the “MENU” button on the navigation controller.



2. Select the “Setup” switch on the screen.

AVALON_Navi_U (L/O 0307)

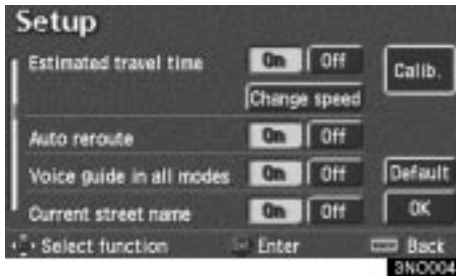

3. Select the **“On”** switch of **“Voice guide in all modes”** and select the **“OK”** switch.

Current street name

1. Push the **“MENU”** button on the navigation controller.



2. Select the **“Setup”** switch on the screen.

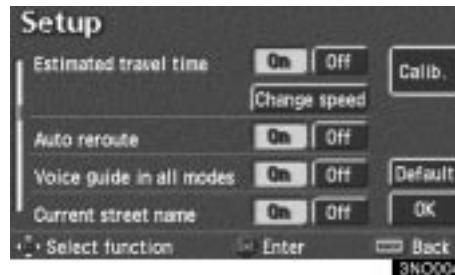

3. Select the **“On”** switch of **“Current street name”** and select the **“OK”** switch.



The current street name appears on the map screen.

AVALON_Navi_U (L/O 0307)

Maintenance information

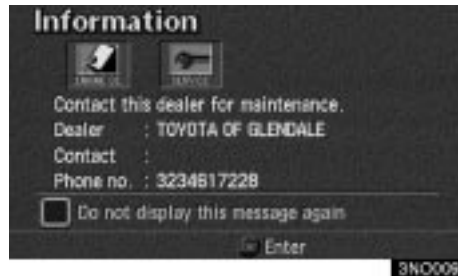

This system has a function which informs you of the time to replace certain parts or components as well as other information shown on the screen. (See “Information Items” on page 98.) When the system begins operating after reaching either the information item’s date or driving distance, the “Information” screen will be displayed.

The “Information” screen will not be displayed or start up by selecting the “Do not display this message again” switch.



1. Push the “INFO” button on the navigation controller to display the information menu screen. Select the “Maintenance” switch to display the “Maintenance” screen.



2. Select your desired icon and input the conditions.



“Date” of notice: Input the next maintenance date.

“Distance” of notice: Input the driving distance until the next maintenance check.

When you select the  switch on the “Maintenance” screen, the screen changes to display the change name screen. Select the keys to input your desired name and then input the conditions.

AVALON_Navi_U (L/O 0307)

After you input that information, select the “OK” switch. The screen then returns to the “Maintenance” screen. The icon’s color will change to green after the date or driving distance is inputted. The icon’s color will change to orange when your Toyota needs to be serviced. The following switches appear on the screen.

“Delete all”: Cancel all conditions which have been inputted.

“Reset all”: Reset all items which satisfy either condition.

Select the “Off” switch at the top of the “Maintenance” screen, and the information screen will no longer be displayed.

INFORMATION

- *For scheduled maintenance information, please refer to the “Owner’s Manual Supplement” or “Scheduled Maintenance”.*
- *Depending on your driving or the road conditions, the system may have a time-lag between the data which has been inputted and the actual date and driving distance.*

Information items



Scheduled maintenance



Oil change



Replace oil filter



Rotate tires



Replace tires



Replace battery



Replace brake lining



Replace wiper blades



Replace engine coolant



Replace brake fluid



Replace ATF



Replace air filter



Personal

AVALON_Navi_U (L/O 0307)

Dealer setting (a) Register dealer

You can register your dealer name and address.



1. Select the **“Set dealer”** switch on the **“Maintenance”** screen.



2. Enter your dealer's location address in the same way as you input any destination. (See pages 13 through 28.)

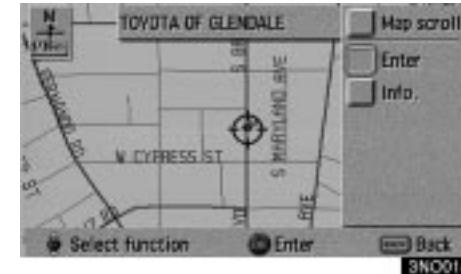

After you enter your dealer, the screen changes and displays the map location of the dealer. If it is OK, select the **“Enter”** switch at the right of the screen.

The current screen changes to the screen when you can edit the data of your dealer. (See (b) Edit dealer.)

AVALON_Navi_U (L/O 0307)

(b) Edit dealer



You can edit your dealer's name, staff, location and phone number if you already registered the dealer.

1. Select the **"Set dealer"** switch on the **"Maintenance"** screen. The **"Edit dealer"** screen appears on the display.



2. Select the **"Change"** switch to edit the item.

EDITING THE NAME OF THE DEALER OR CONTACT



Select alphabet, numeral or umlaut keys directly to input the name.

After you finish your entry, select the **"OK"** switch at the bottom right of the screen. The previous screen will be displayed.

AVALON_Navi_U (L/O 0307)

EDITING THE LOCATION



1. Move the cursor  to the desired point, and if you want to register that point, push the “ENT” button on the navigation controller.



2. Select the “Enter” switch.

EDITING THE PHONE NUMBER



Select numeral keys.

After you finish your entry, select the “OK” switch at the bottom right of the screen. The previous screen will be displayed.

(c) Delete dealer



1. Select the “Delete dealer” switch on the screen.
2. A selected point will appear. Also, a message will appear on the bottom of the screen. To delete, select the “Yes” switch. To cancel deletion, select the “No” switch.

AVALON_Navi_U (L/O 0307)

(d) View map



Select the **“View map”** switch on **“Edit dealer”** screen. The screen changes and displays the map location of the registered dealer and the route preference. (See **“Entering Destination”** on page 28.)

Calendar with memo



This system has a function which informs you the memo you entered. When the system begins operating after reaching the memo's date, the **“Information”** screen will be displayed.

The **“Information”** screen will not be displayed again by selecting the **“Do not display this message again”** switch.



Push the **“INFO”** button on the navigation controller to display the information menu screen. Select the **“Calendar”** switch to display the **“Calendar”** screen.

AVALON_Navi_U (L/O 0307)

(a) Inputting a memo



Today's date is highlighted. If today's date is not displayed on the screen, select **"Today"** switch to display a calendar of this month.



1. Select the day you want to input a memo.

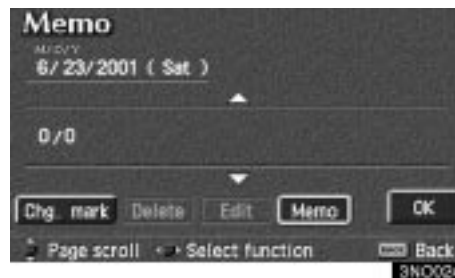

2. Select the **"Memo"** switch to display the **"Memo"** screen.



3. Select alphabet, umlaut keys directly to input a memo. You can input up to 24 letters.

After you input the memo, select the **"OK"** switch at the bottom right of the screen. The previous screen will be appeared.

You can input a memo until December 31, 2020.

AVALON_Navi_U (L/O 0307)



The date you inputted is displayed as above illustration.



You can select your desired date and/or mark color. Select the **“Chg. mark”** switch on the “Memo” screen.

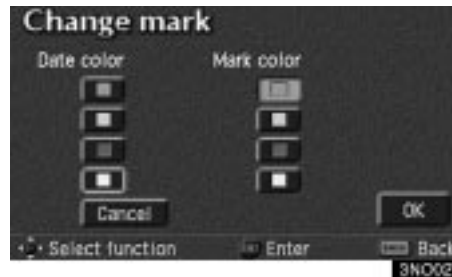

Select your desired date or mark color. If you want to default the date color you chose, select the **“Cancel”** switch on the screen **“Change mark”**. After you select the date and/or mark color, select the **“OK”** switch to display the previous screen.

(b) Adding a memo



When you want to add a memo, directly select the date you want to add the memo.

The **“Memo”** screen appears on the display. If selecting **“Memo”** switch, the memo input screen is displayed. (See page 103 for inputting a memo.)

You can input up to three memos a day.

AVALON_Navi_U (L/O 0307)

(c) Deleting a memo



Select the date you already inputted the memo. Displaying the memo you want to delete and then select the “Delete” switch on the “Memo” screen. A message appears on the display. To delete, select the “Yes” switch. If not, select the “No” switch.

(d) Editing a memo



If you want to edit the memo, select the date. Selecting the “Edit” switch will display the memo edit screen. (See page 102 for the details.)

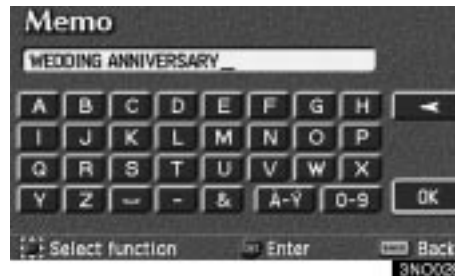

(e) Memo list



If you want to have a look of the memo you inputted, select the “List” switch to display the “Memo list”.

INFORMATION

Before changing to the “Memo list” screen, there is a case where “List searching” screen and “Period” screen will be displayed.

AVALON_Navi_U (L/O 0307)



Select your desired search condition to list the memo. The "Memo list" is displayed on the screen.

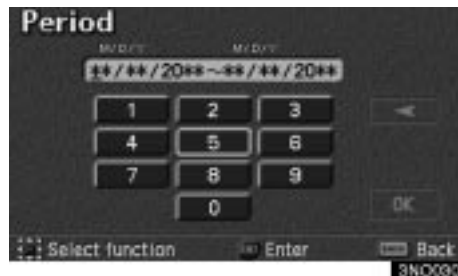

In case of selecting the "Period" switch, you can display the memo list as long as you desired. Select number keys to input your desired search period. After inputting a search period of time, select the "OK" switch. The "Memo list" screen will be displayed.

You can input a search period from January 1, 2000 through December 31, 2020.



If you want to delete and/or edit the memo, select the switch of the memo.

If you want to delete all of the memo, select the "Del. all" switch. A message appears on the display. To delete, select the "Yes" switch. If not, select the "No" switch.

If you want to remove all of the colors of date you inputted, select the "Remove color" switch on the "Memo list" screen. A message appears on the display. To remove, select the "Yes" switch. If not, select the "No" switch.

AVALON_Navi_U (L/O 0307)



To edit: Select the “**Edit**” switch. (See page 105 for details.)

To delete: Select the “**Delete**” switch. (See page 105 for details.)

AVALON_Navi_U (L/O 0307)

SECTION IV

OTHER FUNCTIONS

Clock adjustment	110
Outside temperature display	111
Trip information	111
Screen adjustment	113



AVALON_Navi_U (L/O 0307)

Clock adjustment

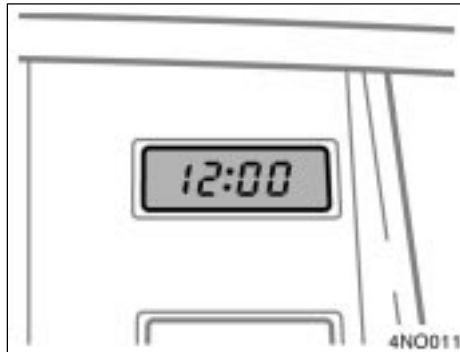

The clock can be corrected manually or by using signals from the GPS. Daylight Saving Time setting or your desired time setting is available.



Push the "INFO" button to display the "Information Menu" and select the "Adjust Clock" switch.

110



Auto Adjust: Before you use the auto adjust function, select the time zone (see "Time Zone" described below). When you select the "ON" switch, the time is automatically adjusted by the GPS clock. When you select the "OFF" switch, you can adjust the clock manually with "H", "M" and ":00" switches.

H: To set the hour with "Auto Adjust OFF", select this switch.

M: To set the minute with "Auto Adjust OFF", select this switch.

:00: To adjust the time to the nearest hour, select this switch.

Daylight Saving Time: Daylight saving time can be set or canceled.

Time Zone: You can select the time zone. When you select this switch, the display will be change to the time zone selection screen. The initial setting is "Eastern Standard Time".



Select the switch of your desired area. The time zone for the area is set and the previous screen returns.

AVALON_Navi_U (L/O 0307)

Outside temperature display

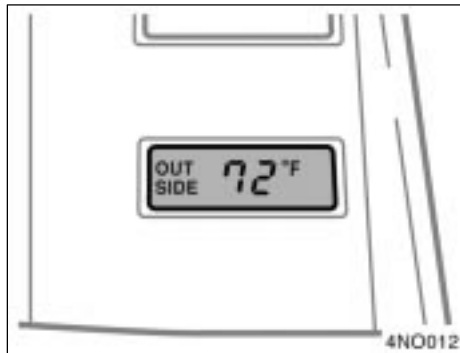

The outside temperature display indicates outside air temperatures when the ignition switch is on.

The displayed temperature ranges from -30°C (-22°F) up to 50°C (122°F).

If there is some abnormality in the connection of the outside air temperature sensor, "--" will appear on the display. If "--" appears on the display, contact your Toyota dealer.

There may be a case that "--" appears momentarily when the ignition is quickly turned to "ON". It is normal if it goes out soon.

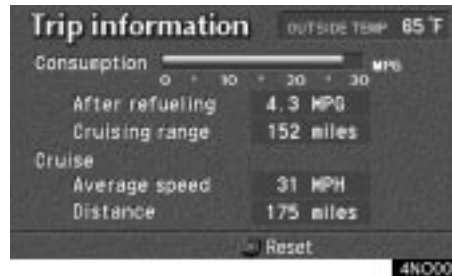

Outside temperature is also displayed on the "Trip information" screen. To display the "Trip information" screen, see "Trip information" described below.

Trip information

Trip information such as driving distance, average vehicle speed, fuel consumption, etc. can be displayed on the screen.



Push the "INFO" button to display the "Information Menu" and select the "Trip Information" switch.

AVALON_Navi_U (L/O 0307)

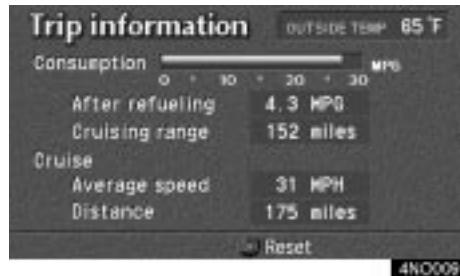

“OUTSIDE TEMP”

The display indicates the outside air temperatures.

“Consumption”

The instantaneous fuel consumption is calculated and displayed based on distance and fuel consumption for 1 second with the engine running.

The displayed value is updated every 1 second.

Note that an accurate figure may not be shown in the following cases.

- When the vehicle is stopped with the engine running, the display will indicate the extremely high fuel consumption.
- When the vehicle is driving down a long slope, applying the engine brake, the display will indicate the extremely low fuel consumption.

The calculation is reset when the ignition switch is turned off.

“After refueling”

The average fuel consumption is calculated and displayed based on total driving distance and total fuel consumption with the engine running.

The displayed value is updated every 10 seconds.

Every time you refuel the vehicle, the calculation is reset. When refueling, be sure to stop your vehicle and turn the ignition switch off.

“Cruising range”

The distance the vehicle can travel with the remaining fuel is calculated and displayed based on the quantity of remaining fuel and past fuel consumption.

The driving range display indicates the approximate distance that you can drive until the fuel gauge reaches “E”. It is different from the actual distance traveled.

The displayed value is updated every time the fuel equivalent for 1 mile or 1 km is consumed.

Every time you refuel the vehicle, the calculation is reset. When refueling, be sure to stop your vehicle and turn the ignition switch off.

The actual driving range varies with driving habits and road conditions. If fuel consumption is good, the driving range will be longer. If fuel consumption is poor, the driving range will be shorter.

If the low fuel level warning light comes on, refuel even if the display indicates that the vehicle can be driven further.

AVALON_Navi_U (L/O 0307)

“Average speed”

The average speed is calculated and displayed based on the total driving distance and the total driving time with the engine running.

The displayed value is updated every 10 seconds.

To reset the calculation, push the “ENT” button.

“Distance”

The distance after refueling is calculated and displayed based on the total distance after refuel.

Every time you refuel the vehicle, the calculation is reset. When refueling, be sure to stop your vehicle and turn the ignition switch off.

To reset the calculation, push the “ENT” button.

Screen adjustment

You can adjust the brightness or contrast of the screen depending on the brightness of your surroundings. You also can turn the display off.

Push the “DISP” button on the navigation controller to display the “Display” screen.

INFORMATION

The display may be tinged in purple due to the reflection of sunlight, but this is not a malfunction.



Contrast and brightness adjustment

“Contrast” “+”:

Strengthens the contrast of the screen.

“Contrast” “-”:

Weakens the contrast of the screen.

“Brightness” “+”:

Brightens the screen.

“Brightness” “-”:

Darkens the screen.

The screen turns off when you push the “**SCREEN OFF**” switch. To turn the display screen back on, push any buttons on the navigation controller such as “MAP/VOICE”, etc. The selected screen appears.

AVALON_Navi_U (L/O 0307)



When the headlight switch is at “ON” position, the screen changes to the day mode or night mode.

To display the screen in the day mode even with the head light switch on, select “**DAY MODE**” switch on the adjustment screen for brightness and contrast control.

If the screen is set in the day mode with the headlight switch turned to on, this condition is memorized in the system even with the engine turned off.