



THE NEW AMERICAN MOTORCYCLE™

2003

CLASSIC CRUISER

TOURING CRUISER

**WARNING**

The engine exhaust from this product contains chemicals known to cause cancer, birth defects or other reproductive harm.

We've created a web site just for YOU!

- Technical tips
- New product introductions
- Event schedules
- Parts and Service Manual information
- Exciting details about The Way Out

Check it out...

www.victory-usa.com



All text, photographs, and illustrations in this manual are based on the most current product information available at the time of publication. Product improvements or other changes may result in differences between this manual and the motorcycle. Polaris Industries reserves the right to make production changes at any time, without notice and without incurring any obligation to make the same or similar changes to motorcycles previously built.



2003 OWNER'S MANUAL

Classic Cruiser

Touring Cruiser

Victory Motorcycle Division, Polaris Industries Inc.

2100 Highway 55, Hamel, Minnesota 55340-9800 Tele: (763) 542-0500 Fax: (763) 542-0599

Copyright© 2002 Polaris Industries Inc. All rights reserved.

Victory Motorcycles is a registered trademark of Polaris Industries Inc.

Dunlop is a registered trademark of Dunlop Tire Corporation.

Features of Victory motorcycles are covered by U.S. Patent Nos. D,397,976; D,398,065;

D,407,169; D,409,551; D,416,831; D,436,561, with additional patents pending.

FOREWORD

Thank you for choosing a Polaris Victory motorcycle!

This owner's manual contains information for the Classic Cruiser and the Touring Cruiser. Some of the photographs and illustrations used in the manual are generalizations, so your model may be slightly different than what is shown.

If you misplace or damage your owner's manual, you should purchase a replacement copy from an authorized Victory dealer. This manual should be considered part of the motorcycle, and it should remain with the motorcycle when it's sold.

If you have questions about the operation or maintenance of the motorcycle after you've read this manual, please contact an authorized Victory dealer. To locate the nearest authorized Victory dealer, call 1-800-POLARIS and provide the area code or zip code of your location. Visit www.polarisindustries.com for a listing of authorized Victory dealers by state, zip code or area code.

Your authorized Victory dealer will resolve all issues regarding your motorcycle. If you're not satisfied with the performance of your Victory dealer, please contact the Polaris Consumer Advocate Department at 763-417-8650.

Victory motorcycles comply with all federal, state and local safety and emission regulations for the area of intended sale.

TABLE OF CONTENTS

FOREWORD	3
TABLE OF CONTENTS	4
INTRODUCTION	5
SAFETY	6
COMPONENT IDENTIFICATION	37
INSTRUMENTS, FEATURES AND CONTROLS	45
PRE-OPERATION CHECK	64
OPERATION	78
MAINTENANCE	92
CLEANING	148
STORAGE	154
WARRANTIES	158
SPECIFICATIONS	168
IDENTIFICATION NUMBERS	174
INDEX	175

Read the Owner's Manual

Your Victory owner's manual contains information that's essential to safe riding and proper maintenance of the motorcycle. Anyone who uses the motorcycle (operators and passengers) must read the owner's manual before riding.

Carefully read and understand the information found in the safety section beginning on page 6. Understand and follow the procedures in your owner's manual to keep your Victory motorcycle in top condition on the road or in storage. Bring the manual with you when you ride. Following the precautions and procedures in the manual will add to your enjoyment and keep you riding safely.

WARNING

Failure to follow the safety precautions and operation and maintenance procedures outlined in this manual may result in death or injury (to you or your passenger) or damage to the motorcycle.

SAFETY

Symbols and Terms Used in the Owner's Manual

The following safety signal words and symbols appear throughout the owner's manual. Your safety and the safety of others are involved when these words and symbols are used. Become familiar with their meanings before reading the manual.



The safety alert symbol indicates a potential for personal injury to you or others.

WARNING

The safety alert warning indicates a potential hazard that could result in serious injury or death.

Caution

The safety alert caution indicates a potential hazard that may result in minor personal injury or damage to the motorcycle.

Caution

A caution indicates a situation that may result in damage to the motorcycle.

Notice

A notice highlights important information you must pay attention to.

Safe Riding Practices

WARNING

Improper use of this motorcycle can result in serious injury or death to you, your passenger and others. To minimize the risk of injury, read and understand the information contained in this section before operating the motorcycle. This section contains safety information specific to the Victory motorcycle, as well as information about general motorcycle safety. Anyone who uses the motorcycle (operators and passengers) must follow these safety precautions.

Motorcycling has inherent risks. You can minimize those risks, but you can't eliminate them completely. Even if you're an experienced motorcycle operator or passenger, read all of the information in this safety section before operating the motorcycle.

- Your ability to safely operate the motorcycle depends on your judgment and your use of safe riding habits. Take a rider education course from the Motorcycle Safety Foundation or another qualified instructor. The course will help you develop or refresh your expertise in safe riding habits through instruction and riding. For information on Motorcycle Safety Foundation rider education courses in your area, call 1-800-446-9227 or visit their homepage at <http://msf-usa.org>.
- Read and understand all information in this owner's manual. It contains safety information specific to individual components and operations.
- Pay close attention to the motorcycle maintenance requirements in this manual. For additional information or assistance with technical services specified in the manual or required by mechanical circumstances, see the *Victory Service Manual* or your authorized Victory Dealer.

SAFETY

Safe Riding Practices

The following design characteristics affect how you should ride the Victory motorcycle:

- The motorcycle is designed for on-road use with one rider and one passenger. Do not exceed the gross vehicle weight rating (see the specifications section, beginning on page 168, or the certification label on the steering head). Riding off-road, riding with more than one passenger, or carrying weight exceeding the maximum weight rating can make handling difficult, which could cause loss of control.
- In the first 500 miles, operate the motorcycle according to the break-in procedures described on page 79. Operating the motorcycle without following break-in procedures can result in serious engine damage.
- Some Victory motorcycles include saddlebags, a windshield, and a passenger backrest as standard equipment. To maintain stability, be prepared to reduce the operating speed of motorcycles equipped with these accessories.

Safe Riding Practices

Follow these general safe riding practices:

- **Before each ride, make the checks described in the Pre-Operation Check section** beginning on page 64. Operating the motorcycle without completing the pre-operation check may cause damage to the motorcycle or result in an accident.
- Until you're thoroughly familiar with the Victory motorcycle and all of its controls, practice riding where there is little or no traffic. Practice riding at a moderate speed on varying road surfaces and under varying weather conditions.
- **Know your skills and limits, and ride within them.**
- Allow only licensed, experienced operators to ride your motorcycle, and then only after they have become familiar with its controls and operation.
- Do not ride when you're fatigued or under the influence of alcohol, prescription drugs, over-the-counter drugs or any other drugs. Fatigue, alcohol and drugs can cause drowsiness, loss of coordination and loss of balance. They can also affect your awareness and judgment.
- If your motorcycle operates abnormally, correct the problem immediately (see the *Victory Service Manual* or contact your authorized Victory dealer). If you continue to operate a motorcycle in this condition, you are likely to aggravate the initial problem, increase the cost of repairs and threaten your safety.

SAFETY

Safe Riding Practices

- The most common cause of accidents involving a motorcycle and an automobile is the automobile driver's failure to see the motorcycle. Ride defensively, as if you are invisible to other motorists, even in broad daylight. Ride where you're clearly visible to other motorists, and observe their behavior carefully, as they may not see or be aware of you.
- **Be especially cautious at intersections, as these are the most likely places for an accident.**
- To prevent loss of control while operating the motorcycle, keep your hands on the handlebars and your feet on the footrests.
- Obey the speed limit and adjust your speed and riding technique based on road, weather and traffic conditions. As you travel faster, the influence of all other conditions increases, which can affect the motorcycle's stability and increase the possibility of losing control.
- Do not move or operate the motorcycle with the steering locked, as the severely restricted steering could result in loss of control.
- **Reduce your speed when:**
 - The road has potholes or is otherwise rough or uneven.
 - The road has sand, dirt, gravel or other loose substances on it.
 - The road is wet, icy or oily.
 - The road contains painted surfaces, manhole covers, metal grating, railway crossings or other slippery surfaces.

Safe Riding Practices

- **Reduce your speed when:**
 - The weather is windy, rainy or otherwise causing slippery or rapidly changing conditions.
 - The traffic is heavy, congested, not allowing sufficient space between vehicles or otherwise not flowing smoothly.
 - You are being passed in either direction by a large vehicle that produces a wind blast in its wake.
- **To maximize braking effectiveness, use the front and rear brakes together.** Improper braking may cause loss of control or may not slow the vehicle in time to avoid a collision. Be aware of the following braking facts and practices:
 - The rear brake provides 40% of the motorcycle's stopping power, at most.
 - Consider road conditions before applying the brakes. When the road is wet or rough, or contains loose or other slippery substances, apply the brakes gradually.
 - Bring the motorcycle to the upright position before applying the brakes, and avoid applying the brakes in a corner if at all possible. When the motorcycle is leaning through a corner, the amount of traction available for braking is reduced, increasing the possibility of the tires skidding when the brakes are applied.
- When approaching a curve, choose a speed and lean angle that allows you to pass through the curve in your own lane without applying the brakes. Excessive speed, improper lean angle or braking in a curve can cause loss of control.

SAFETY

Safe Riding Practices

- Ground clearance is reduced when the motorcycle leans. Do not allow components to contact the road surface when leaning the motorcycle in a curve, as this could cause loss of control.
- Retract the sidestand fully before riding. If the sidestand is not fully retracted, it could contact the road surface and cause loss of control.
- Do not tow a trailer. Towing a trailer can make the motorcycle hard to handle, which could cause loss of control.

Carrying a Passenger

To carry a passenger safely, do the following:

- Direct the passenger to hold onto you or the seat strap with both hands and to keep both feet on the passenger footrests. Do not carry a passenger who cannot place both feet firmly on the passenger footrests. A passenger who is not holding on properly, or who cannot reach the passenger footrests, can shift their body erratically, which can make the motorcycle hard to handle and cause loss of control.
- If necessary, adjust the rear shock absorber preload according to the instructions on page 107. Improper preload adjustment can make your motorcycle hard to handle and can cause loss of control.
- Before riding, be sure your passenger knows safe riding procedures. Discuss any safety information unfamiliar to your passenger. A passenger who is unaware of safe riding procedures may distract you or make movements that make the motorcycle hard to handle.
- Adjust your riding style to compensate for the differences in handling, acceleration and braking caused by the additional weight of the passenger. Failure to do so can cause loss of control.

Safe Riding Practices

Protective Apparel

To decrease the risk of injury and increase riding comfort, wear protective riding apparel.

- Wear a Department of Transportation (DOT) or SNELL approved helmet. Some state laws require that you wear an approved helmet. **In accidents involving motorcycles, head injuries are the leading cause of motorcyclist fatalities, and statistics prove that an approved helmet is the most effective protection in preventing or reducing head injuries.**
- Wear eye protection. Some state laws require that you wear eye protection. Eye protection reduces the chance that your vision could be impaired by wind or by airborne particles and objects.
- You and your passenger should wear bright or light colored and/or reflective clothing to improve visibility to other motorists. **A motorist's failure to see or recognize a motorcycle is the leading cause of automobile/motorcycle accidents.**
- Wear gloves, a jacket, heavy boots and long pants to prevent or reduce abrasions, lacerations or burns should the motorcycle fall.
- Wear boots with low heels, as high heels can catch on pedals or footrests. The combination of boots and pants should completely cover legs, ankles and feet, protecting skin from engine and exhaust system heat. The engine and exhaust system get hot soon after the engine is started and stay hot for about half an hour after the engine is turned off.
- Do not wear loose, flowing clothing or long boot laces, as they can catch on handlebars, levers or footrests, or become entangled in the wheels, causing loss of control and serious injury.

SAFETY

Gross Vehicle Weight Rating (GVWR)

Gross vehicle weight is the total combined weight of the motorcycle, the operator and the passenger.

- The weight of the motorcycle includes the motorcycle and all of its fluids, any accessories and their contents, and any additional cargo on the motorcycle.
- The weight of the operator or passenger includes body weight, all apparel and objects in or on apparel.

Do not exceed the motorcycle's gross vehicle weight rating. Exceeding the weight rating can reduce stability and handling and could cause loss of control.

Refer to the specifications section of this manual (beginning on page 168) or the certification label on your motorcycle's steering head for model-specific GVWR information.

Example 1: Classic Cruiser with no accessories or cargo
Gross Vehicle Weight Rating 1150 lbs (522 kg)

Item	Weight
Classic Cruiser - with full capacity of all fluids	675 lbs (306 kg)
Operator - with recommended riding apparel	220 lbs (100 kg)
Passenger - with recommended riding apparel	155 lbs (70 kg)
Total Weight	1050 lbs (476 kg)

Example 2: Classic Cruiser with Touring package and cargo
Gross Vehicle Weight Rating 1150 lbs (522 kg)

Item	Weight
Classic Cruiser - with full capacity of all fluids	675 lbs (306 kg)
Weight of Touring package	33 lbs (15 kg)
Cargo - optional saddlebags at capacity	14 lbs (6 kg)
Operator - with recommended riding apparel	220 lbs (100 kg)
Passenger - with recommended riding apparel	155 lbs (70 kg)
Total Weight	1097 lbs (498 kg)

NOTE: The weight of any options (in this example the total weight of the Touring package) must be added to the base weight of the Classic Cruiser. NEVER exceed GVWR. If you have any questions regarding safe loading of your Victory motorcycle, please consult an authorized Victory dealer.

SAFETY

Example 3: Touring Cruiser with no cargo Gross Vehicle Weight Rating 1210 lbs (549 kg)

Item	Weight
Touring Cruiser - with full capacity of all fluids	759 lbs (344 kg)
Operator - with recommended riding apparel	220 lbs (100 kg)
Passenger - with recommended riding apparel	155 lbs (70 kg)
Total Weight	1134 lbs (514 kg)

Example 4: Touring Cruiser with Touring package and cargo Gross Vehicle Weight Rating 1210 lbs (549 kg)

Item	Weight
Touring Cruiser - with full capacity of all fluids	759 lbs (344 kg)
Weight of Touring package	11 lbs (5 kg)
Cargo - saddlebags at capacity	20 lbs (9 kg)
Operator - with recommended riding apparel	220 lbs (100 kg)
Passenger - with recommended riding apparel	155 lbs (70 kg)
Total Weight	1165 lbs (529 kg)

NOTE: The weight of any options (in this example the total weight of the Touring package) must be added to the base weight of the Touring Cruiser. NEVER exceed GVWR. If you have any questions regarding safe loading of your Victory motorcycle, please consult an authorized Victory dealer.

Carrying Cargo

Use the following guidelines when attaching cargo or accessories to the motorcycle. Where applicable, these guidelines also refer to the contents of any accessories.

- Keep cargo and accessory weight to a minimum, and keep items as close to the motorcycle as possible to minimize a change in the motorcycle's center of gravity. Changing the center of gravity can cause loss of stability and handling and result in loss of control.
- Distribute weight evenly on both sides of the motorcycle. Maintain even weight distribution by checking accessories and cargo to make sure they're securely attached to the motorcycle before riding and whenever you take a break from riding. Uneven weight distribution, or accessories or cargo that shift suddenly while you're riding can make the motorcycle hard to handle and result in loss of control.
- Do not attach large or heavy cargo such as sleeping bags, duffel bags or tents to the handlebars, front fork area or front fender. Cargo or accessories placed in these areas can cause instability (due to improper weight distribution or aerodynamic changes) and can cause loss of control. Such items can also block air flow to the engine and cause overheating that can damage the engine.
- Do not exceed the maximum cargo weight limit of any accessory (see accessory instructions and labels), and do not attach cargo to an accessory not designed for that purpose, as these could result in an accessory failure that could cause loss of control.
- Except for highway footrests, do not attach anything else to the highway bar.

SAFETY

Saddlebags

When operating a motorcycle with saddlebags:

- Never ride at speeds exceeding 80 mph (120 km/h). Depending on load and weather conditions, the maximum safe operating speed may be less than 80 mph (120 km/h). Saddlebags, combined with the lifting or buffeting effects of wind, can make the motorcycle unstable and cause loss of control.
- Distribute weight evenly in each of the saddlebags.
- Do not exceed the maximum cargo weight limit of the saddlebags.
 - Leather saddlebags = 7 lbs. (3.2 kg) each
 - Lockable hard saddlebags = 10 lbs. (4.5 kg) each
- Do not exceed the motorcycle's gross vehicle weight rating. Exceeding the weight rating can reduce stability and handling and cause loss of control.

Transporting the Motorcycle

If you must transport the motorcycle:

- Use a truck or trailer. Do not tow the motorcycle with another vehicle, as towing will impair the motorcycle's steering and handling, which can cause loss of control.
- Position and restrain the motorcycle so it remains upright on the truck or trailer, as gasoline may leak out of the fuel tank if the motorcycle leans to one side. Gasoline is a fire hazard and it can also damage the motorcycle's finish.
- Do not restrain the motorcycle using the handlebars. Place tie-downs around the fork tubes above the lower triple clamp.

Parking the Motorcycle

When leaving the motorcycle unattended, turn the engine off, engage the steering lock and remove the ignition key. See page 90.

Park the motorcycle where people are not likely to touch the hot engine or exhaust system or place combustible materials in close proximity to these hot areas. Do not park near a flammable source such as a kerosene heater or an open flame, where hot components could ignite combustible materials.

Park the motorcycle on a firm, level surface. Sloped or soft surfaces may not support the motorcycle when it's parked, and it may tip over. If you must park on a slope or soft surface, follow the precautions outlined on page 90.

Modifications

Modifying the motorcycle by removing any equipment or by adding equipment not approved by Victory may void your warranty. Such modifications may make the motorcycle unsafe to ride and could result in severe injury to operator or passengers, as well as damage to the motorcycle. Some modifications may also be illegal in some states. If in doubt, contact your authorized Victory Dealer.

SAFETY

Accessory Selection and Installation

Because Victory cannot test and make specific recommendations concerning every accessory or combination of accessories sold, the operator is responsible for determining that the motorcycle can be safely operated with any accessories or additional weight. Use the following guidelines when choosing and installing accessories:

- Do not install accessories that impair the stability, handling or operation of the motorcycle. Before installing an accessory, be sure that it does not:
 - Reduce ground clearance when the motorcycle is either leaned or in a vertical position.
 - Limit suspension or steering travel or your ability to operate controls.
 - Displace you from your normal riding position.
 - Obscure lights or reflectors.
- Bulky or large accessories can cause instability (due to the lifting or buffeting effects of wind) and loss of control.
- Do not install electrical accessories that exceed the capacity of the motorcycle's electrical system. An electrical failure could result and cause hazardous loss of engine power or lights or damage to the electrical system.
- If you want to add a windshield, backrest or luggage rack, choose one designed and approved by Victory specifically for your model. Follow the instructions for proper installation and use. An improperly designed or installed windshield, backrest or luggage rack can reduce stability, causing loss of control.

Gasoline and Exhaust

For complete fueling procedures, see page 81.

Gasoline is highly flammable and can be explosive in certain conditions. Observe the following precautions when you refuel or service the fuel system:

- Turn off the engine.
- Use a well-ventilated area.
- Remove the fuel cap slowly.
- Do not spill gasoline on the engine or the exhaust system. Immediately wipe, or rinse with water, gasoline spilled on any part of the motorcycle or the surrounding area.
- Do not smoke while fueling.
- Do not fuel in an area where there are sparks or open flame.

Gasoline and gasoline vapors are poisonous and can cause severe injury. Do not swallow gasoline, inhale gasoline vapors, or spill gasoline on yourself or your clothes. If you swallow gasoline, inhale more than a few breaths of gasoline vapor, or get gasoline in your eyes, see a physician immediately. If you spill gasoline on your skin, wash it off immediately with soap and water. If you spill gasoline on your clothes, change your clothes immediately.

Exhaust gases contain carbon monoxide, a colorless, odorless gas that can cause unconsciousness or severe injury. Observe the following precautions to avoid the effects of exhaust gases:

- Do not inhale exhaust gases.
- Do not start or run the engine in an enclosed area.

SAFETY

Maintenance

Maintain the motorcycle according to the following requirements:

- Before each ride, complete a pre-operation check as outlined beginning on page 64. Operating the motorcycle without completing the pre-operation check can cause damage to the motorcycle or result in an accident.
- Perform periodic maintenance according to the intervals outlined in the Periodic Maintenance Interval tables beginning on page 93. Operating the motorcycle without performing periodic maintenance can damage the motorcycle or result in bodily injury.
- Maintain proper tire pressure and tread condition and proper wheel and tire balance. Inspect tires regularly and replace them if they're worn or damaged. Use only an approved replacement tire and see the *Victory Service Manual* or your authorized Victory Dealer for tire replacement. Operating the motorcycle with improper tire pressure or tread condition, or improper wheel or tire balance, can make the motorcycle hard to handle and cause loss of control.
- Check proper steering head bearing adjustment. Regularly inspect the rear shock absorber and the front forks. Check for fork oil or shock absorber fluid leaks. Operating the motorcycle with a loose, worn, or damaged steering system or front or rear suspension system can make the motorcycle hard to handle and cause loss of control. To repair steering or suspension system wear or damage, see the *Victory Service Manual* or contact your authorized Victory Dealer.

Maintenance



- Keep the motorcycle clean. In addition to extending the service life and the original appearance of the motorcycle, a complete and thorough cleaning can reveal items in need of repair. For complete cleaning procedures, see page 148.
- Keep equipment required by federal, state, and local laws in place and in good working condition. Your license plate must be clean, clearly visible in all conditions, and installed in a position specified by law.
- Each fastener used in the motorcycle meets our quality specifications for strength, finish and type. When replacement fasteners are needed, use only genuine Victory parts, tightened to the proper torque. A fastener that does not meet original specifications could fail and result in damage to the motorcycle or injury to riders.

SAFETY

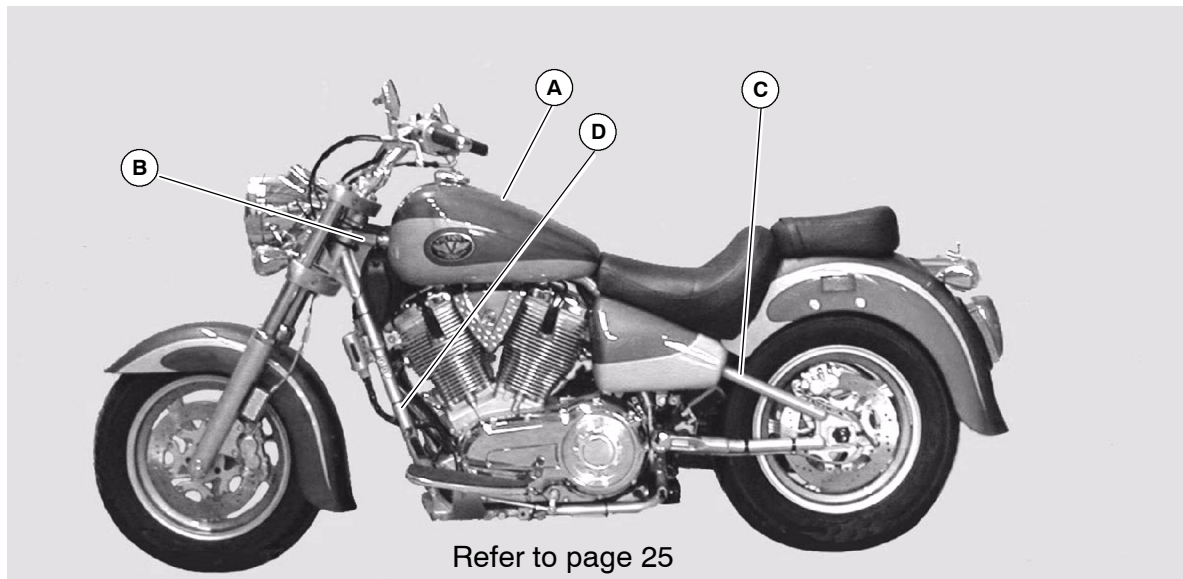
Location of Safety and Vehicle Information Labels (Classic Cruiser)



Location of Safety and Vehicle Information Labels (Classic Cruiser)

 WARNING	 AVERTISSEMENT
<ul style="list-style-type: none"> □ Read Owner's Manual and, during use, follow all safety precautions. □ Always wear an approved helmet, eye protection and protective clothing. □ If your Owner's Manual is missing, contact a Victory / Polaris dealer for a replacement. 	<ul style="list-style-type: none"> □ Lire le Manuel d'utilisation et suivre toutes les consignes de sécurité durant l'utilisation. □ Toujours porter un casque de sécurité approuvé, des lunettes et des vêtements de protection. □ Si il n'y a pas de manuel du propriétaire, en demander un auprès d'un concessionnaire Victory / Polaris.
UNLEADED FUEL RECOMMENDED	CARBURANT SANS PLOMB RECOMMANDÉ

Location A

Month/Year:

Mfd By: VICTORY MOTORCYCLE DIVISION, Polaris Industries, Inc.

GAWR:

Information on this decal will vary by model, features, and options. Refer to actual decal on the vehicle.

MOTORCYCLE

GAWR F:

GAWR R:

THIS VEHICLE CONFORMS TO ALL APPLICABLE FEDERAL MOTOR VEHICLE SAFETY STANDARDS IN EFFECT ON THE DATE OF MANUFACTURE SHOWN ABOVE.

7079051

Location B

MOTORCYCLE NOISE EMISSION CONTROL INFORMATION	INFORMATIONS SUR LA LUTTE CONTRE LE BRUIT ÉMIS PAR LES MOTO-CYCLES
<p>THIS MOTORCYCLE CONFORMS TO ALL APPLICABLE FEDERAL AND CALIFORNIA REGULATIONS APPLICABLE TO 2000 YEAR NEW MOTORCYCLES AND IS CERTIFIED TO 4.0 or 4.1 gbw (noise family) engine emission standard in California.</p>	<p>CETTE MOTO-CYCLETTE CONFORME À TOUTES LES RÉGLEMENTATIONS APPLICABLES AUX MOTO-CYCLES NEUFS DE 2000 ANS ET EST CERTIFIÉE À 4.0 ou 4.1 gbw (bruit familial) moteur.</p>
 <p>VICTORY MOTORCYCLE DIVISION Polaris Industries, Inc. HAMILL, MN, U.S.A. 55341-9800</p>	 <p>VICTORY MOTORCYCLE DIVISION Polaris Industries, Inc. HAMILL, MN, U.S.A. 55341-9800</p>

Location C

VEHICLE EMISSION CONTROL INFORMATION	
 <p>VICTORY MOTORCYCLE DIVISION Polaris Industries, Inc. 2100 HWY 55 HAMILL, MN, U.S.A. 55341-9800</p>	
<p>ENGINE DISPLACEMENT: 1507cc ENGINE FAMILY: VM3600L1V92 ENGINE EXHAUST CONTROL SYSTEM: SF1 ENGINE TUNING SPECIFIC ACTIONS: IDLE SPEED: 950 ±50 RPM IGNITION TIMING: PERMANENTLY FACTORY SET FUEL MIXTURE: FFI CONTROLLED FIF VALVE CLEARANCE: HYDRAULIC TAPPET SELF-ADJUSTING SPARK PLUG: NGK, CHT22 SPARK PLUG GAP: 0.032" (0.8 mm) FUEL: UNLEADED GASOLINE ONLY: 92 PUMP OCTANE OR HIGHER OIL: 20W40</p>	<p>ENGINE DISPLACEMENT: 1507cc ENGINE FAMILY: VM3600L1V92 ENGINE EXHAUST CONTROL SYSTEM: SF1 ENGINE TUNING SPECIFIC ACTIONS: IDLE SPEED: 950 ±50 RPM IGNITION TIMING: PERMANENTLY FACTORY SET FUEL MIXTURE: FFI CONTROLLED FIF VALVE CLEARANCE: HYDRAULIC TAPPET SELF-ADJUSTING SPARK PLUG: NGK, CHT22 SPARK PLUG GAP: 0.032" (0.8 mm) FUEL: UNLEADED GASOLINE ONLY: 92 PUMP OCTANE OR HIGHER OIL: 20W40</p>
<p>THIS VEHICLE CONFORMS TO U.S.EPA REGULATIONS APPLICABLE TO 2000 MODEL YEAR NEW MOTORCYCLES.</p>	

Location D (U.S. Models)

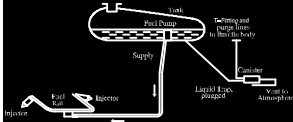
VEHICLE EMISSION CONTROL INFORMATION and EVAPORATIVE HOSE ROUTING - CALIFORNIA	
 <p>VICTORY MOTORCYCLE DIVISION Polaris Industries, Inc. 2100 HWY 55 HAMILL, MN, U.S.A. 55341-9800</p>	
<p>ENGINE DISPLACEMENT: 1507cc ENGINE FAMILY: VM3600L1V92 ENGINE EXHAUST CONTROL SYSTEM: SF1 ENGINE TUNING SPECIFIC ACTIONS: IDLE SPEED: 950 ±50 RPM IGNITION TIMING: PERMANENTLY FACTORY SET FUEL MIXTURE: FFI CONTROLLED FIF VALVE CLEARANCE: HYDRAULIC TAPPET SELF-ADJUSTING SPARK PLUG: NGK, CHT22 SPARK PLUG GAP: 0.032" (0.8 mm) FUEL: UNLEADED GASOLINE ONLY: 92 PUMP OCTANE OR HIGHER OIL: 20W40</p>	<p>EVAPORATIVE HOSE ROUTING DIAGRAM: Fuel Tank Fuel Drain Fuel Supply Exhaust Tailpipe and muffler hose routed in the body Catalytic Converter Exhaust Air Filter</p> 
<p>THIS VEHICLE CONFORMS TO U.S.EPA AND CALIFORNIA REGULATIONS APPLICABLE TO 2000 MODEL YEAR NEW MOTORCYCLES AND IS CERTIFIED TO 4.0 or 4.1 gbw (noise family) engine emission standard in California.</p>	

Location D (California Models)

VEHICLE EMISSION CONTROL INFORMATION	INFORMATION SUR LE CONTRÔLE DES ÉMISSIONS DES VÉHICULES
 <p>VICTORY MOTORCYCLE DIVISION Polaris Industries, Inc. 2100 HWY 55 HAMILL, MN, U.S.A. 55341-9800</p>	
<p>ENGINE DISPLACEMENT: 1507cc ENGINE FAMILY: VM3600L1V92 ENGINE EXHAUST CONTROL SYSTEM: SF1 ENGINE TUNING SPECIFIC ACTIONS: IDLE SPEED: 950 ±50 RPM IGNITION TIMING: PERMANENTLY FACTORY SET FUEL MIXTURE: FFI CONTROLLED FIF VALVE CLEARANCE: HYDRAULIC TAPPET SELF-ADJUSTING SPARK PLUG: NGK, CHT22 SPARK PLUG GAP: 0.032" (0.8 mm) FUEL: UNLEADED GASOLINE ONLY: 92 PUMP OCTANE OR HIGHER OIL: 20W40</p>	<p>CYLINDRITÉ DE MOTEUR: 1507 cm³ FAMILLE DE MOTEUR: VM3600L1V92 RÉGLEMENTATION ANTIPOLLUANT: INDICATEUR SÉRIE CARRURE (90) SPÉCIFICATIONS MOTEUR AU POINT DE MOTEUR: RÉGIME AU RALENTI: 950 ± 50 tr/min CALAGE À LA LUMIÈRE: RÉGÈLE À LA LUMIÈRE DE FAÇON PERMANENTE RÉGÈLE À LA LUMIÈRE DE FAÇON PERMANENTE BOÎTE À VITESSES: POSSÈDE UN RÉGÈLE À LA LUMIÈRE D'AVANT-GAUCHE BOÎTE À VITESSES: POSSÈDE UN RÉGÈLE À LA LUMIÈRE DE BOÎTE OIL: 20W40</p>
<p>THIS VEHICLE CONFORMS TO U.S.EPA REGULATIONS APPLICABLE TO 2000 MODEL YEAR NEW MOTORCYCLES.</p>	
<p>CE VÉHICULE EST CONFORME AUX DISPOSITIONS RÉGLEMENTAIRES APPLICABLES AUX MOTO-CYCLES NEUFS DE 2000 ANS ET EST CERTIFIÉ À 4.0 ou 4.1 gbw (bruit familial) moteur.</p>	

Location D (Canada Models)

SAFETY

Location of Safety and Vehicle Information Labels (Classic Cruiser)

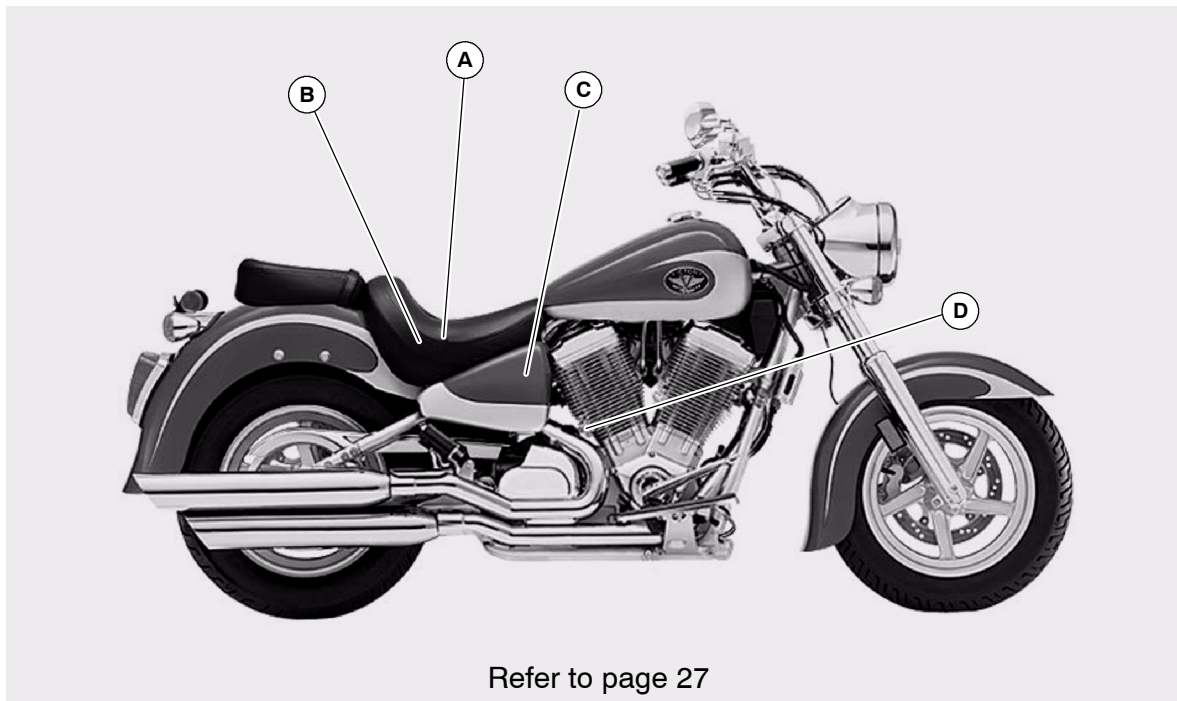

Location of Safety and Vehicle Information Labels (Classic Cruiser)

 <p>PATENT NOTICE</p> <p>Mfd. by Victory Motorcycle Division, Polaris Industries Inc., under one or more of the following patents: Other patents pending. U.S. Patents.</p> <p>D, 397, 976 D, 409, 551 D, 398, 065 D, 416, 831 D, 407, 169 D, 436, 561</p>	 <p>AVIS SUR LES BREVETS</p> <p>Fabriqué par Victory Motorcycle Division, Polaris Industries Inc. (Division motocyclettes de Victory), en vertu de l'un ou plusieurs des brevets suivants : Autres brevets en instance. Brevets américains.</p> <p>D, 397, 976 D, 409, 551 D, 398, 065 D, 416, 831 D, 407, 169 D, 436, 561</p> <p style="text-align: right;">7079796</p>
--	--

Location A (on subframe)

TIRE INFORMATION			
Cold Tire Pressures:			
Up to	lbs (kg) Load	Front	psi (kpa)
		Rear	psi (kpa)
Up to	Maximum Load Capacity	Front	psi (kpa)
		Rear	psi (kpa)
Maximum Load Capacity:	(kg)		
Tire Brand/Type:		Front	
		Rear	
Tire Size:		Front	
		Rear	
Minimum Recommended Tire Center Tread Depth:		Front	
		Rear	
READ OWNER 'S MANUAL			

Location B (on subframe)
(Information will vary by model)

PCM DIODE ←→		HEADLAMP RELAY (RELAIS DE PHARE)	PCM RELAY (RELAIS DE PCM)
← TO PWR CORD (VERS LE CORDON D'ALIMENTATION)			
IGNITION, COIL (ALLUMAGE, BOBINE) 15A	HORN, BRAKE, HEADLAMP (CLAXON, FREINS, PHARE) 20A	FLASHERS (CLIGNOT ANT) 15 A	FUEL PUMP RELAY (RELAIS DE POMPE À CARBURANT)
STARTER DIODE (DÉMARREUR À DIODE) ←→	PCM 20 A	FUEL PUMP (POMPE À CARBURANT) 10 A	

Location C (in fuse box cover)

**Engine Identification
Number Label**

Location D
(on left crankcase half)

SAFETY

Location of Safety and Vehicle Information Labels - Classic Cruiser (Shown with options)



Location of Safety and Vehicle Information Labels (Classic Cruiser)

▲ WARNING

- Additional accessories can reduce stability and safe operating speed. After windshield installation, if operation seems unsafe, immediately remove all accessories and cargo. Contact your dealer to fix the problem and remove the accessories.
- Windshields provide wind protection and increased riding comfort but will not protect you in a collision with another vehicle, the road, birds, or any other object.
- Do not ride with loose or damaged windshield or mounting hardware. Regularly check the hardware for tightness. Replace windshield if scratches cannot be removed.

▲ CAUTION

- Brake fluid and alcohol will permanently damage the plastic windshield.
- Do not clean the windshield with glass cleaners or rain protective products.

CLEANING

- Clean windshield with a soft cloth and plenty of warm water. Dry with a soft clean cloth. Remove minor scratches with a quality plastic polishing compound.
- See windshield installation instructions and the Victory Owner's Manual for complete instructions on the proper care of your windshield.

▲ AVERTISSEMENT

- En ajoutant des accessoires, on risque de diminuer la stabilité et la vitesse de conduite sécuritaire. Après installation du pare-brise, si la sécurité de conduite semble menacée, enlever immédiatement les accessoires et la charge transportée. Communiquer avec votre concessionnaire pour régler le problème et faire réinstaller les accessoires.
- Le pare-brise protège contre le vent et améliore le confort du pilote, mais n'offre aucune protection en cas de collision avec un autre véhicule, de chute sur la route, d'impact avec un objet ou tout autre objet.
- Ne pas conduire avec des pièces de fixation ou un pare-brise desserrés ou endommagés. Vérifier régulièrement si les attaches sont bien serrées. Remplacer le pare-brise si il est rayé de façon permanente et que les rayures nuisent à la visibilité.

▲ ATTENTION

- Tout contact avec du liquide de frein ou de l'alcool causera des dommages permanents au pare-brise en plastique.
- Ne pas utiliser des produits nettoyants pour les vitres ou des produits de protection contre la pluie sur le pare-brise.

NETTOYAGE

- Nettoyer le pare-brise avec un linge doux et beaucoup d'eau tiède. Sécher avec un linge propre et doux. Faire disparaître les petites rayures avec une pâte à polir de bonne qualité pour plastique.
- Se reporter à la notice d'installation du pare-brise et au manuel d'utilisation Victory pour les consignes détaillées sur l'entretien du pare-brise.

7076204

Location A

▲ WARNING

To prevent serious injury or death when using saddlebags:

- Never ride above 80 mph (120 kph) with saddlebags. Doing so could cause you to lose control. This maximum safe speed may be less. See Owner's Manual for more information.
- Do not exceed maximum load limit of 71 lbs (3.178 kg) in each saddlebag. Distribute weight evenly. Total weight of rider, passenger, accessories, and cargo must not exceed the Gross Vehicle Weight Rating in Owner's Manual and on Tire Information Label.

▲ AVERTISSEMENT

Afin d'éviter de graves blessures ou la mort lorsque vous utilisez des sacs à dos :

- Né jamais rouler à plus de 120 km/h (80 mi/h) avec des sacs à dos installés. On pourrait ainsi perdre le contrôle du véhicule. Cette vitesse sécuritaire peut être inférieure. Consultez votre Manuel d'utilisation pour obtenir plus amples renseignements.
- Ne pas dépasser la charge maximale de 3.178 kg (71 lb) dans chaque sac à dos. Répartir également le poids.
- Le poids total du conducteur, du passager, des accessoires et du chargement ne doit pas dépasser la charge maximale brute du véhicule indiquée dans le Manuel d'utilisation et sur l'étiquette de renseignements sur les pneus de la motocyclette.

7076204

Location B
(Inside Saddlebag)

▲ WARNING	▲ AVERTISSEMENT
USE ONLY CORRECT SIZES FOR ON-THE-ROAD TIRES. USING THE WRONG ONE, DO NOT EXCEED MAXIMUM RECOMMENDED INFLATION PRESSURE TO AVOID FLAT TIRE, TIRE BURST, OR OTHER FAILURE THAT COULD RESULT IN SERIOUS PERSONAL INJURY OR DEATH. (OWNER'S MANUAL)	NE MONTER QUE DES PNEUS DE DIMENSIONS SÛRES. C'EST LA MÊME INSTALLER EN UTILISANT LE LA BRANCHE À PNEUS. NE PAS DÉPASSER LA TENSION RECOMMANDÉE NI MAXIMUM RECOMMANDÉ POUR ACCROÎTRE LE TAUX DE PNEUS. L'AVERTISSEMENT DE NE PAS DÉPASSER LA MÊME TENSION DE LA BRANCHE À PNEUS PEUT RÉSULTER EN DE GRAVES BLESSURES PERSONNELLES OU LA MORT. (MANUEL D'UTILISATION)

Location C

SAFETY

Location of Safety and Vehicle Information Labels (Touring Cruiser)

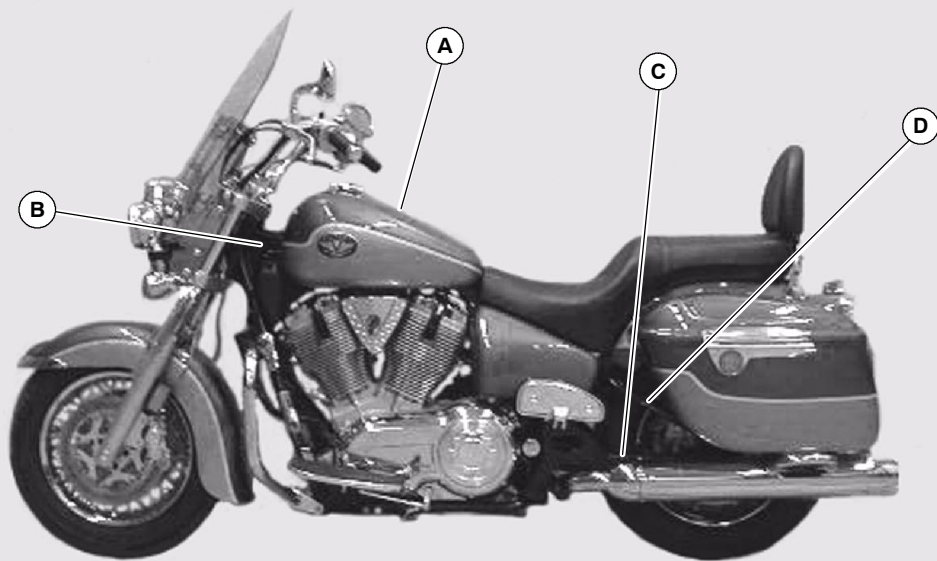

Refer to page 31

SAFETY

Location of Safety and Vehicle Information Labels - Touring Cruiser (Shown with options)



Location of Safety and Vehicle Information Labels (Touring Cruiser)

▲ WARNING

- Additional accessories can reduce stability and safe operating speed. After windshield installation, if operation seems unsafe, immediately remove all accessories and cargo. Contact dealer to fix the problem and re-mount the accessories.
- Windshields provide protection and increased riding comfort but will not protect you in a collision with another vehicle, the road, birds, or any other object.
- Do not ride with loose or damaged windshield or mounting hardware. Regularly check the hardware for tightness. Replace windshield if scratches cannot be removed.

▲ CAUTION

- Brake fluid and alcohol will permanently damage the plastic windshield.
- Do not clean the windshield with glass cleaners or rain protective products.

CLEANING

- Clean windshield with a soft cloth and plenty of warm water. Dry with a soft clean cloth. Remove minor scratches with a quality plastic polishing compound.
- See windshield installation instructions and the Victory Owner's Manual for complete instructions on the proper care of your windshield.

▲ AVERTISSEMENT

- En ajoutant des accessoires, on risque de diminuer la stabilité et la vitesse de conduite sécuritaire. Après installation du pare-brise, si la sécurité de conduite semble menacée, retirez immédiatement les accessoires et la charge transportée. Communiquez avec votre concessionnaire pour régler le problème et faire réinstaller les accessoires.
- Le pare-brise protège contre le vent et améliore le confort du pilote, mais n'offre aucune protection en cas de collision avec un autre véhicule, de chute sur le route, d'impact avec un obstacle ou tout autre objet.
- Ne pas conduire avec des pièces de fixations ou un pare-brise desserrés ou déformés. Vérifier régulièrement si les attaches sont bien serrées. Remplacer le pare-brise si il est rayé de façon permanente et que les rayures nuisent à la visibilité.

▲ ATTENTION

- Tout contact avec du liquide de frein ou de l'alcool causera des dommages permanents au pare-brise en plastique.
- Ne pas utiliser des produits nettoyants pour les vitres ou des produits de protection contre la pluie sur le pare-brise.

NETTOYAGE

- Nettoyer le pare-brise avec un linge doux et beaucoup d'eau tiède. Sécher avec un linge propre et doux. Faire disparaître les petites rayures avec une pâte à polir de bonne qualité pour plastique.
- Se reporter à la notice d'installation du pare-brise et au manuel d'utilisation Victory pour les consignes détaillées sur l'entretien du pare-brise.

Location A

▲ WARNING

Highway bar is not designed to protect you from injury in a collision.

▲ WARNING

To prevent serious injury or death when using saddlebags:

- Never ride above 80 mph (120 kph) with saddlebags. Doing so could cause you to lose control. This maximum safe speed may be less. See Owner's Manual for more information.
- Do not exceed maximum load limit of 101 lbs (45.4 kg) in each saddlebag. Distribute weight evenly.
- Total weight of rider, passenger, accessories, and cargo must not exceed the Gross Vehicle Weight Rating in Owner's Manual and on Tire Information Label.

▲ AVERTISSEMENT

Afin d'éviter de graves blessures ou la mort lorsque vous utilisez des sacs de selle :

- Né jamais rouler à plus de 120 km/h (80 mi/h) avec des sacs de selle installés, on pourrait à sa perte le contrôle du véhicule. Cette vitesse sécuritaire maximale peut être moindre. Consultez votre Manuel d'utilisation pour obtenir de plus amples renseignements.
- Ne pas dépasser la charge maximale de 45,4 kg (101 lb) dans chaque sac de selle. Répartir l'épandure uniformément.
- Le poids total du conducteur, du passager, des accessoires et du chargement ne doit pas dépasser le poids nominal brut du véhicule indiqué dans le Manuel d'utilisation et sur les pneus de la motocyclette.

Location B (Both Sides)

▲ WARNING	▲ AVERTISSEMENT
<p>DO NOT EXCEED SPEEDS TOP ON THIS ROAD DESIGN ENGINE TIRE SPEED RATING. DO NOT EXCEED MAXIMUM GROSS VEHICLE WEIGHT RATING. EXCEEDING THESE LIMITS CAN CAUSE PERSONAL INJURY. SEE OWNER'S MANUAL.</p>	<p>NE MONTEZ PAS PLUS DE PERSONNES EN PLUS SUR CE VÉHICULE. INSTALLER EN SUIVANT DE LA GRANDE CAPACITÉ. NE PAS EXCÉDER À TOUT MOMENT LA MARGE DE MARGE MAXIMUM POUR ACCÉDER À LA VITESSE DE PROTECTION. AU TRÈS HAUT, IL PEUT CAUSER TOUTE LA MARGE DE LA MARGE DE LA VITESSE DE PROTECTION. NE DÉPASSEZ PAS LA MARGE DE LA VITESSE DE PROTECTION. NE DÉPASSEZ PAS LA MARGE DE LA VITESSE DE PROTECTION.</p>

Location D

Location C
(Inside Saddlebag)

SAFETY

Location of Safety and Vehicle Information Labels (Touring Cruiser)

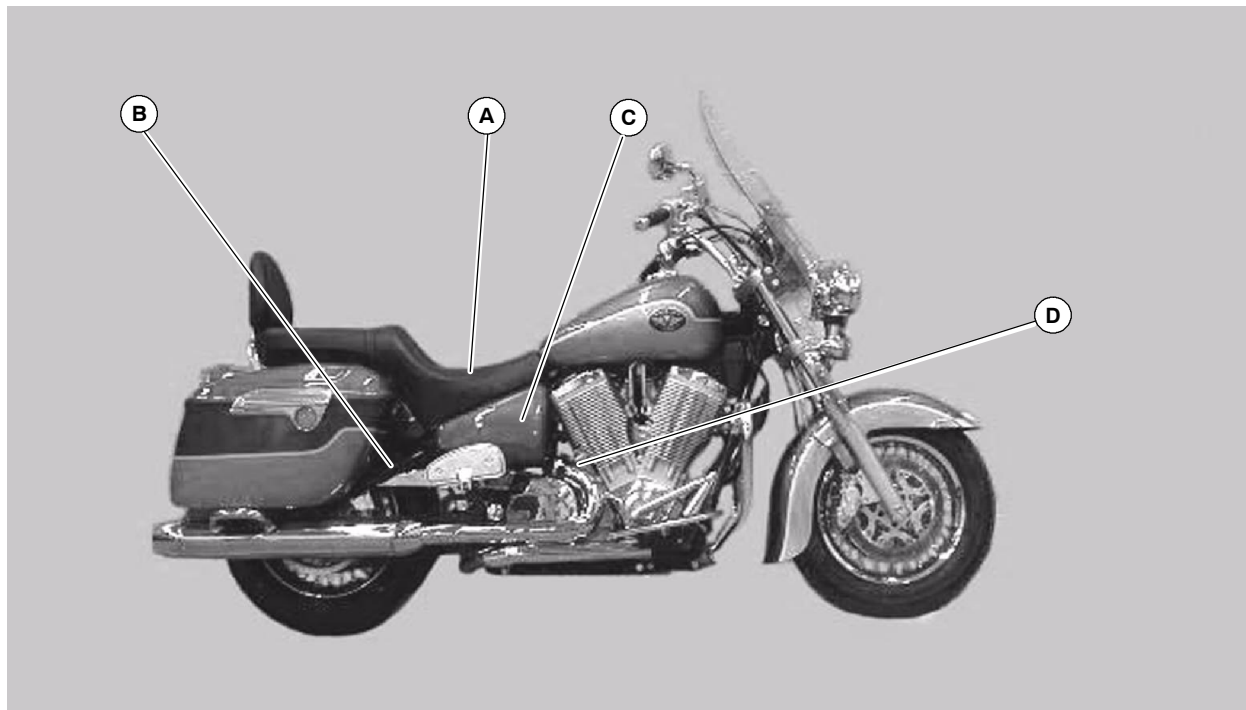

Location of Safety and Vehicle Information Labels (Touring Cruiser)

 <p>PATENT NOTICE</p> <p>Mfd. by Victory Motorcycle Division, Polaris Industries Inc., under one or more of the following patents: Other patents pending. U.S. Patents.</p> <p>D, 397, 976 D, 409, 551 D, 398, 065 D, 416, 831 D, 407, 169 D, 436, 561</p>	 <p>AVIS SUR LES BREVETS</p> <p>Fabriqué par Victory Motorcycle Division, Polaris Industries Inc. (Division motocyclettes de Victory), en vertu de l'un ou plusieurs des brevets suivants : Autres brevets en instance. Brevets américains.</p> <p>D, 397, 976 D, 409, 551 D, 398, 065 D, 416, 831 D, 407, 169 D, 436, 561</p> <p style="text-align: right;">7079796</p>
---	---

Location A (Under Seat)

TIRE INFORMATION			
Cold Tire Pressures:			
Up to	lbs (kg) Load	Front	psi (kpa)
		Rear	psi (kpa)
Up to	Maximum Load Capacity	Front	psi (kpa)
		Rear	psi (kpa)
Maximum Load Capacity:	(kg)		
Tire Brand/Type:		Front	
		Rear	
Tire Size:		Front	
		Rear	
Minimum Recommended Tire Center Tread Depth:		Front	
		Rear	
READ OWNER 'S MANUAL			

Location B (Information Will Vary By Model)

PCM DIODE ←→		HEADLAMP RELAY (RELAIS DE PHARE)	PCM RELAY (RELAIS DE PCM)
← TO PWR CORD (VERS LE CORDON D'ALIMENTATION)			
IGNITION, COIL (ALLUMAGE, BOBINE) 15A	HORN, BRAKE, HEADLAMP (CLAXON, FREINS, PHARE) 20A	FLASHERS (CLIGNOT ANT) 15 A	FUEL PUMP RELAY (RELAIS DE POMPE À CARBURANT)
STARTER DIODE (DÉMARREUR À DIODE) ←→	PCM 20 A	FUEL PUMP (POMPE À CARBURANT) 10 A	

Location C (In Fuse Box Cover)

<p>Engine Identification Number Label</p>
--

Location D (On Left Crankcase Half)

SAFETY

Reporting Safety Defects

If you believe that your vehicle has a defect that could result in a crash or cause injury or death, you should immediately inform the National Highway Traffic Safety Administration (NHTSA) in addition to notifying Polaris Industries in writing.

If NHTSA receives similar complaints, it may open an investigation, and if it finds that a safety defect exists in a group of vehicles, it may order a recall and remedy campaign. However, NHTSA cannot become involved in individual problems between you, your dealer or Polaris Industries.

To contact NHTSA, or obtain other information about motor vehicle safety, you may either call the Auto Safety Hotline toll-free at 1-800-424-9393, visit the NHTSA website at www.nhtsa.dot.gov, or write to:

NHTSA
US Department of Transportation
400 7th Street Southwest
Washington, DC 20590

COMPONENT IDENTIFICATION

Use the information on the following pages to identify and locate the major components of the Victory motorcycle, including the vehicle and engine identification numbers, model number and ignition key number.

Handlebar Components

1. Clutch Cable
2. Instrument Cluster
3. Fuel Cap
4. Front Brake Fluid Reservoir
5. Right Mirror
6. Throttle Control Grip
7. Front Brake Lever
8. Right Handlebar Switch
9. Throttle Cables
10. Left Handlebar Switch
11. Clutch Lever
12. Left Mirror

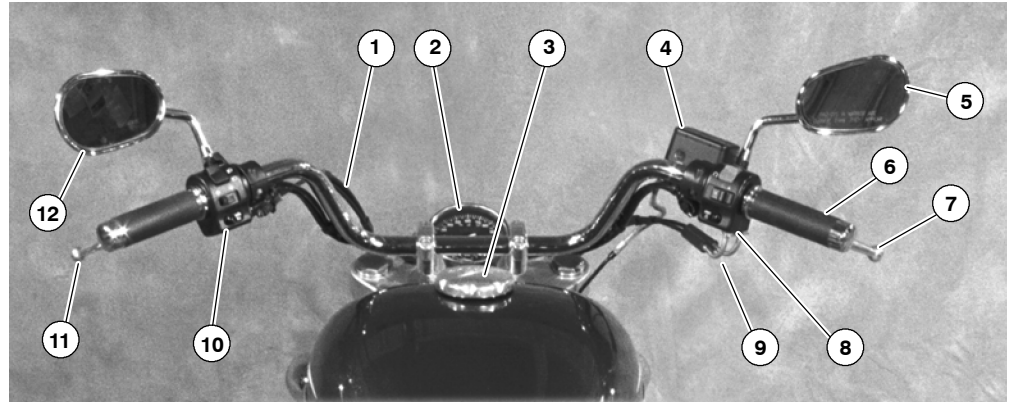

COMPONENT IDENTIFICATION

Classic Cruiser Components

1. Front Forks
2. Front Turn Signal/Running Light
3. Headlamp
4. Air Filter
5. Spark Plug (2)
6. Ignition Switch/Seat Release
7. Side Cover
8. Battery (under side cover)
9. Operator's Seat
10. Seat Strap
11. Passenger's Seat
12. Rear Brake Caliper
13. Rear Turn Signal
14. Taillight
15. Rear Axle Adjuster (1 each side)
16. Horn
17. Passenger's Foot Rest
18. Oil Filter
19. Sidestand
20. Evaporative Canister - California Models (lower left by swingarm)
21. Operator's Foot Rest
22. Gear Shift Lever
23. Front Brake Caliper



COMPONENT IDENTIFICATION

Classic Cruiser Components

1. Drive Belt (under guard)
2. Passenger's Seat
3. Seat Strap
4. Helmet Holders (under seat)
5. Operator's Seat
6. Rear Shock Absorber (under seat)
7. Side Cover
8. Engine Oil Fill Cap/Dipstick
9. Headlamp
10. Steering Lock
11. Front Turn Signal/Running Light
12. Front Fork
13. Oil Cooler
14. Rear Brake Pedal
15. Operator's Foot Rest
16. Engine Oil Drain Plug (under engine)
17. Rear Brake Fluid Reservoir (under side cover)
18. Drive Sprocket (under cover)
19. Passenger Foot Rest
20. Fuses (under side cover)
21. Exhaust Muffler (2)
22. Taillight
23. Rear Turn Signal

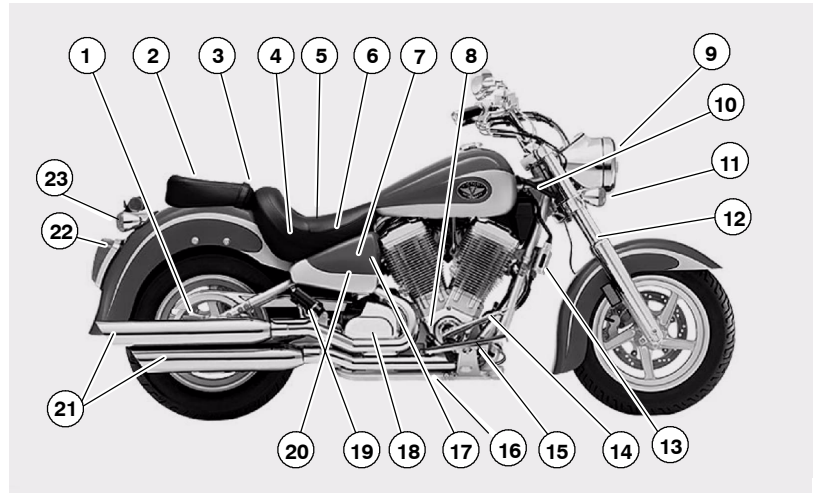

COMPONENT IDENTIFICATION

Touring Cruiser Components

1. Seat Strap
2. Drive Belt (under guard)
3. Rear Shock Absorber (under seat)
4. Side Cover
5. Engine Oil Fill Cap/Dipstick
6. Headlamp
7. Steering Lock
8. Front Turn Signal/Running Light
9. Front Fork
10. Oil Cooler
11. Rear Brake Pedal
12. Operator's Foot Rest
13. Engine Oil Drain Plug (under engine)
14. Drive Sprocket (under cover)
15. Rear Brake Fluid Reservoir (under side cover)
16. Passenger's Foot Rest
17. Fuses (under side cover)
18. Evaporative Canister (under seat) (California Models)

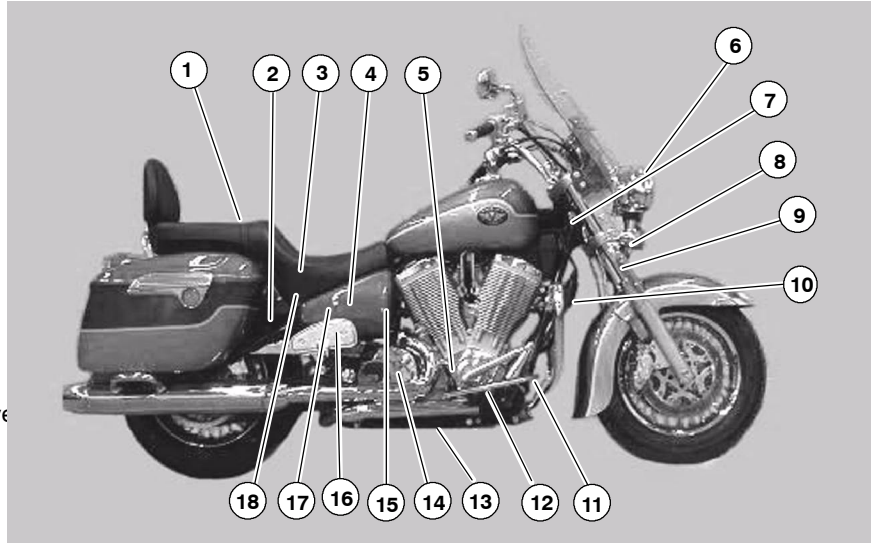

COMPONENT IDENTIFICATION

Touring Cruiser Components

- 1. Front Forks
- 2. Front Turn Signal/Running Light
- 3. Auxiliary Lights
- 4. Headlamp
- 5. Air Filter
- 6. Auxiliary Lights Switch
- 7. Spark Plug (2)
- 8. Ignition Switch
- 9. Side Cover
- 10. Battery (under side cover)
- 11. Seat (one piece)
- 12. Lockable Hard Saddlebags
- 13. Rear Turn Signal
- 14. Taillight
- 15. Exhaust Muffler
- 16. Rear Brake Caliper
- 17. Horn
- 18. Passenger Foot Rest
- 19. Oil Filter
- 20. Sidestand
- 21. Operator's Foot Rest
- 22. Gear Shift Lever
- 23. Front Brake Caliper

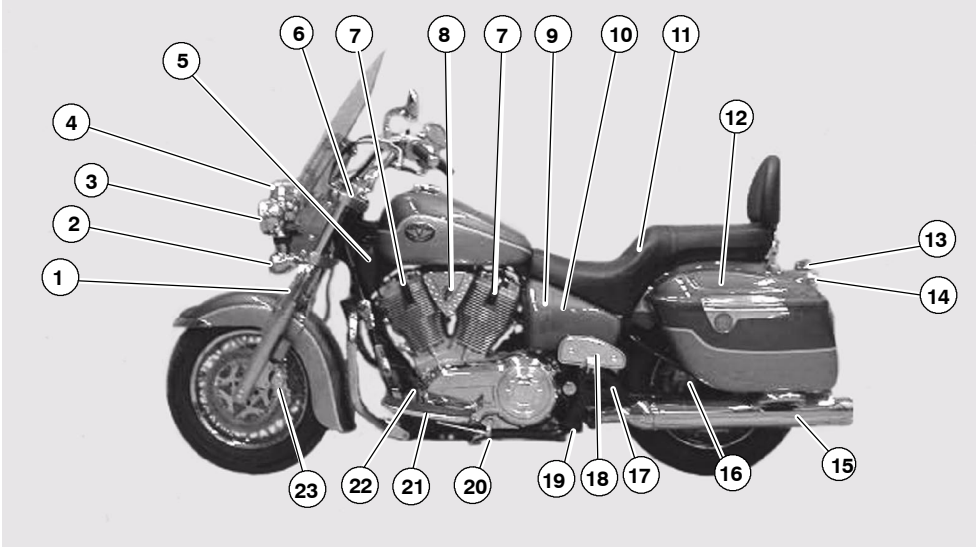

COMPONENT IDENTIFICATION

Vehicle Identification Number

The vehicle identification number (VIN) is stamped into the front of the steering head and also appears on the certification label. You will need the vehicle identification number to title, register, license or insure the motorcycle, or to order replacement parts.

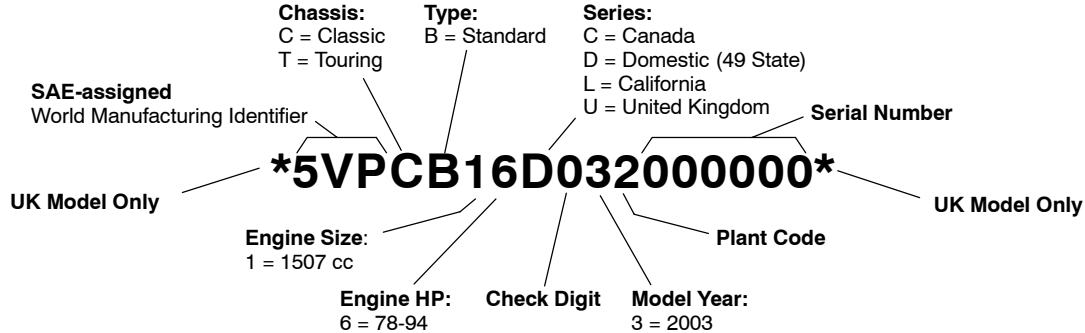

COMPONENT IDENTIFICATION

Engine Identification Number

The engine identification number is a combination of the engine model and serial numbers. The engine identification number is located on top of the crankcase behind the rear cylinder. The engine serial number is stamped into the rear of the crankcase just to the right of the oil filter.

You may need the engine identification number to title, register, license or insure the motorcycle, or to order replacement parts.

Ignition Key Number

The ignition key identification number is stamped into the shaft of each key.

With the ignition key number and proof of ownership, an authorized Victory dealer can assist you in obtaining a replacement key (have your dealer reference Voice of Victory April/May 2001).

Notice

For easy reference, record all vehicle numbers in the space provided on page 174.

- NOTES -

INSTRUMENTS, FEATURES AND CONTROLS

Ignition Key

The ignition key operates the ignition switch and the steering lock as well as the seat latch (Classic Cruiser only) and the saddlebag locks (Touring Cruiser only).

Steering Lock

The motorcycle is equipped with a steering lock to deter others from moving or using the motorcycle. The steering lock is on the right side of the steering head.

To lock the steering, turn the handlebars fully to the left and open the lock cover. Insert the key and turn it clockwise. To unlock the steering, move the handlebars to the left or right slightly and turn the key counterclockwise. Always remove the key after locking or unlocking the steering.

WARNING

Moving or operating the motorcycle with the steering locked severely restricts steering and can cause loss of control.

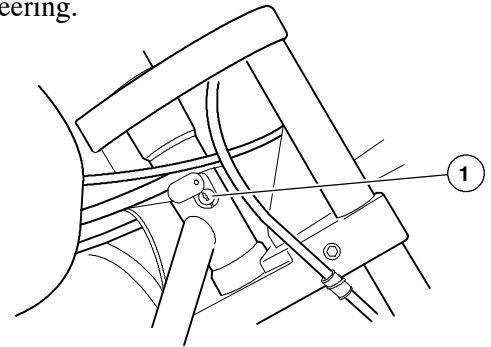

1. Steering Lock

INSTRUMENTS, FEATURES AND CONTROLS

Ignition Switch/Seat Release

The ignition switch/seat release energizes the ignition, the lighting system, and all electrical switches and buttons. It is also used to release the operator's seat (on Classic Cruiser).

Off Position

In the OFF position, all electrical circuits are inactive and the ignition key can be removed. Turn the ignition switch/seat release to the OFF position and remove the ignition key when leaving the motorcycle unattended.

On Position

In the ON position, all electrical circuits are energized and the ignition key cannot be removed. The headlamp, running lights, taillight, and instrument lights illuminate. With the engine stop/run switch set to the RUN position (see page 58) you can start the engine. You can also activate the emergency flashers, turn signals and all other electrical features.

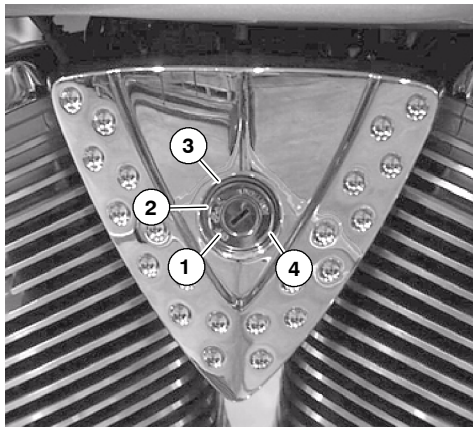

1. Off
2. On
3. P (Park)
4. Seat Release (Classic Cruiser)

Caution

Before starting the engine, read the instructions for starting the engine beginning on page 82.

INSTRUMENTS, FEATURES AND CONTROLS

Ignition Switch/Seat Release

Park Position (P)

In the PARK position, the taillight and running lights illuminate, the emergency flashers can be activated, and the ignition key can be removed. You must push the ignition key into the switch while selecting the Park position.

Seat Release Position (Classic Cruiser)

To release the operator's seat on the Classic Cruiser, insert the ignition key into the ignition switch/seat release and turn the key counterclockwise.

Helmet Holders (Classic Cruiser)

The helmet holders are a secure place to store your helmet while the motorcycle is parked. The Classic Cruiser has two helmet holders (one on each side). They're located under the operator's seat.

WARNING

Do not ride the motorcycle with a helmet in the helmet holder. The helmet can interfere with your ability to safely operate the motorcycle, causing loss of control.

To store your helmet, remove the operator's seat and slide the helmet D-ring into the helmet holder. Reinstall the operator's seat.

INSTRUMENTS, FEATURES AND CONTROLS

Instrument Cluster

The instrument cluster includes the speedometer, the tachometer, the indicator lights and the multi-function display.

- | | |
|-------------------------------|---------------------------------|
| 1. Speedometer | 5. Neutral Indicator |
| 2. Tachometer | 6. Turn Signal Indicators |
| 3. Low Oil Pressure Indicator | 7. Headlamp High Beam Indicator |
| 4. Low Fuel Indicator | 8. Multi-Function Display (MFD) |

Speedometer

The speedometer reports current motorcycle speed in miles per hour or kilometers per hour.

Tachometer

The tachometer reports current engine speed in revolutions per minute (RPM). A red line on the gauge indicates maximum safe engine RPM.

WARNING

Do not operate the engine over 5600 RPM. Excessive RPM could cause engine damage or failure that could result in you losing control of the motorcycle.

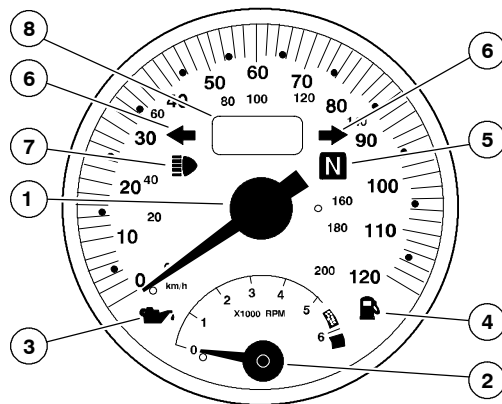

INSTRUMENTS, FEATURES AND CONTROLS

Indicator Lights

Low Oil Pressure Indicator



The low oil pressure indicator illuminates when engine oil pressure drops below safe operating pressure. If this indicator illuminates while the engine is running, turn the engine off immediately and check the oil level. Add oil if necessary. If the oil level is correct and the indicator remains illuminated after the engine is restarted, turn the engine off immediately.

The low oil pressure indicator also illuminates when the ignition switch is in the ON position and the engine is not running. This demonstrates that the indicator is functioning properly.

Low Fuel Indicator



The low fuel indicator illuminates when approximately 0.8 gallons (3.03 liters) of fuel remains in the fuel tank. The low fuel indicator also illuminates momentarily when the ignition switch is in the ON position and the engine is not running. This demonstrates that the indicator is functioning properly.

Neutral Indicator



The neutral indicator illuminates when the transmission is in neutral. It also illuminates momentarily when the ignition switch is in the ON position and the engine is not running. This demonstrates that the indicator is functioning properly.

INSTRUMENTS, FEATURES AND CONTROLS

Indicator Lights

Turn Signal Indicators



The left turn signal indicator flashes when the left turn signals are active.



The right turn signal indicator flashes when the right turn signals are active.

Both turn signal indicators flash when the emergency flashers are active.

If a turn signal bulb has failed, or if there is a short circuit in the turn signal system, the turn signal indicator flashes at more than twice the normal rate.

Headlamp High Beam Indicator



The headlamp high beam indicator illuminates when the headlamp switch is set to high beam (see page 56).

INSTRUMENTS, FEATURES AND CONTROLS

Multi-Function Display (MFD)

Use the MFD to view the odometer, trip odometer, clock, fuel gauge, voltmeter, instrument cluster light dimmer, headlamp high beam indicator light dimmer and check engine indicator. The MFD operates only when the ignition switch is in the ON position. To select the desired function, press the MODE button (page 59). To adjust a particular function, press the SET button (page 57).

Odometer

The odometer is the default mode of the MFD after starting the engine. The odometer shows total miles traveled.

To toggle the odometer and trip odometer reading between miles and kilometers, and the fuel gauge reading between gallons and liters, the ignition switch must be in the ON position with the MFD in odometer mode. Press and hold the SET button for three seconds.

To change to the next MFD function, press the MODE button.

Trip Odometer

“TRIP” appears in the display when in trip odometer mode. The trip odometer shows total miles traveled since the trip odometer was reset. You can use the trip odometer to calculate your miles per gallon and estimate the number of miles you can travel on a tank of fuel.

To reset the trip odometer, the ignition switch must be in the ON position with the MFD in trip odometer mode. Press and hold the SET button for three seconds.

To change to the next MFD function, press the MODE button.

INSTRUMENTS, FEATURES AND CONTROLS

Multi-Function Display (MFD)

Clock

A clock icon appears in the display when in clock mode. When the clock is operating normally, the colon between the hour and minutes flashes.

To set the clock, the ignition switch must be in the ON position with the MFD in clock mode.

1. Press and hold the SET button for THREE seconds when in clock mode. The hour digits should flash.
2. Press the SET button to select the desired hour.
3. Press the MODE button to accept the new hour setting. The ten-minute digit should flash.
4. Press the SET button to select the desired ten-minute.
5. Press the MODE button to accept the new ten-minute setting. The minute digit should flash.
6. Press the SET button to select the desired minute.
7. Press the MODE button to accept the new minute setting. The clock should return to normal operation, and the colon should flash.

To change to the next MFD function, press the MODE button.

Notice The multi-function display (MFD) clock will not function if the battery voltage drops below 11.5 volts. The clock will reset to 12:00 if the battery is disconnected.

INSTRUMENTS, FEATURES AND CONTROLS

Multi-Function Display (MFD)

Instrument Cluster Light Dimmer

“DIM” appears in display when in instrument cluster light dimmer mode. To change the intensity of the instrument cluster light, press the SET button to select from six (6) intensity levels. The engine does not need to be running to change the light intensity.

To change to the next MFD function, press the MODE button.

Headlamp High Beam Indicator Light Dimmer

“HB” appears in the display when in headlamp high beam indicator light dimmer mode. To change the intensity of the headlamp high beam indicator light, press the SET button to select from four (4) intensity levels. The engine does not need to be running to change the indicator intensity.

To change to the next MFD function, press the MODE button.

Fuel Gauge

The fuel gauge shows the amount of fuel in the fuel tank. The fuel gauge range is from LOW (0.8 gallons/3.03 liters) to FULL (5 gallons/18.9 liters).

To change to the next MFD function, press the MODE button.

Voltmeter

When the engine is not running, “BAT” and the battery voltage appear.

When the engine is running, “ALT” and the charging system voltage appear.

To return to the odometer function, press the MODE button.

INSTRUMENTS, FEATURES AND CONTROLS

Multi-Function Display (MFD)

Check Engine Indicator

The check engine indicator will flash “CH ENG” any time the ignition switch is in the ON position and the engine control module sensors report abnormal sensor or engine operation. The check engine indicator will continue to flash as long as the fault condition exists.

Caution

If the check engine indicator flashes repeatedly while the engine is running, a serious engine problem may exist. Contact an authorized Victory dealer as soon as possible.

INSTRUMENTS, FEATURES AND CONTROLS

Multi-Function Display (MFD) Functions

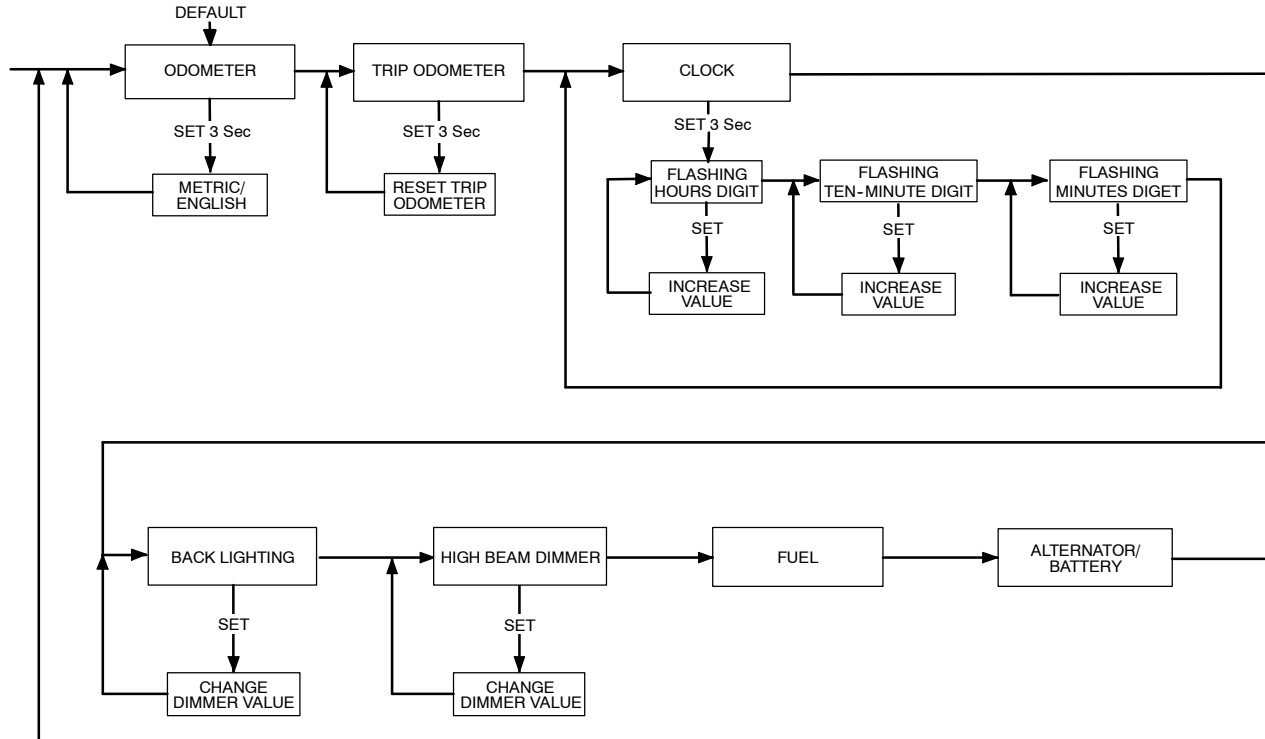

INSTRUMENTS, FEATURES AND CONTROLS

Left Handlebar Controls



Fast Idle Lever

The fast idle lever increases the engine idle speed when starting a cold engine (see page 82). To engage the fast idle lever, move the lever toward the rear of the motorcycle until the lever stops.

Headlamp High/Low Beam Switch

 The headlamp high/low beam switch toggles the headlamp between high beam, low beam, and momentary passing beam. To activate the high beam, press the upper portion of the switch; to activate the low beam, press the lower portion of the switch. To activate the momentary passing beam, press and hold the lower portion of the switch.

Turn Signal Switch

  The turn signal switch activates and cancels the turn signals. To activate the left turn signals, push the switch to the left; to activate the right turn signals, push the switch to the right. To cancel the turn signals, push the switch in, toward the handlebar.

The turn signals cancel automatically at speeds above 6 miles per hour (9.6 kilometers per hour).

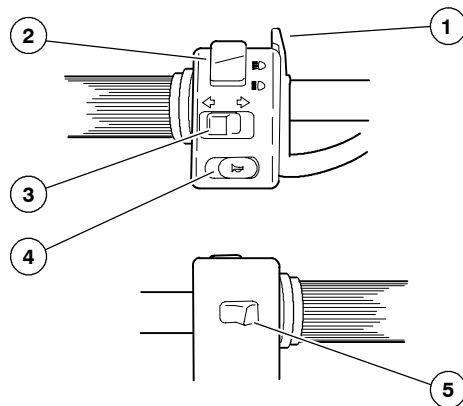

1. Fast Idle Lever
2. Headlamp High/Low Beam Switch
3. Turn Signal Switch
4. Horn Button
5. Multi-Function Display SET Button

INSTRUMENTS, FEATURES AND CONTROLS

Left Handlebar Controls

Horn Button



To sound the horn, press the horn button.

Clutch Lever

To disengage the clutch, pull the clutch lever toward the handlebar. To engage the clutch, gradually release the clutch lever. For smooth clutch operation, pull the lever quickly and release it gradually.

Notice The motorcycle is equipped with a clutch interlock switch that prevents the engine from starting when the transmission is in gear and the clutch is engaged (see page 82).

Multi-Function Display (MFD) Set Button

The MFD SET button is located on the back side of the left handlebar control. Use it in conjunction with the MFD MODE button to control the features of the multi-function display (see page 51).

INSTRUMENTS, FEATURES AND CONTROLS

Right Handlebar Controls

Engine Stop/Run Switch

 The engine stop/run switch completes or interrupts the ignition, starter, and fuel pump circuits. To complete the circuits, allowing the engine to start and run, press the lower portion of the engine stop/run switch (RUN position). To interrupt the circuits, press the upper portion of the switch (STOP position). The engine should not start or run when the switch is in the STOP position.



Use the engine stop/run switch to turn the engine off under either normal or emergency conditions.00000000

Emergency Flasher Switch

 The emergency flasher switch activates and cancels the emergency flashers. When the emergency flashers are active, all of the turn signals flash. To activate the emergency flashers, slide the switch to the left (to the triangle). To cancel the flashers, slide the switch to the right (to the dot).



Starter Button

 The starter button works only when the engine stop/run switch is in the RUN position and the transmission is in neutral or the clutch is disengaged. To engage the engine starter motor, press the right side of the starter button.

For complete engine starting procedures, see “Starting the Engine” on page 82.

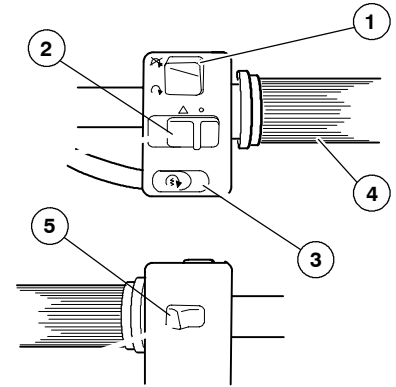

1. Engine Stop/Run Switch
2. Emergency Flasher Switch
3. Starter Button
4. Throttle Control Grip
5. Multi-Function Display MODE Button

INSTRUMENTS, FEATURES AND CONTROLS

Right Handlebar Controls

Front Brake Lever

The front brake lever is located on the far side of the right handlebar grip. To apply the front brake, pull the front brake lever toward the handlebar. For braking procedures in various riding conditions, see “Braking” on page 88.

Throttle Control Grip

The throttle control grip controls the engine speed. To increase engine speed, twist the throttle control grip toward you; to decrease engine speed, twist the grip away from you. When you release the grip, it returns to the idle speed position.

Multi-Function Display (MFD) Mode Button

The MFD MODE button is located on the back side of the right-hand handlebar control. Use it in conjunction with the MFD SET button to control the features of the multi-function display (see page 51).

INSTRUMENTS, FEATURES AND CONTROLS

Gear Shift Pedal

The gear shift pedal is located on the left side of the motorcycle. To shift to a lower gear, press down on the front of the gear shift pedal. To shift to a higher gear, press down on the rear, or lift up on the front of the gear shift pedal.

For proper gear shifting procedure, see “Shifting Gears” on page 84.

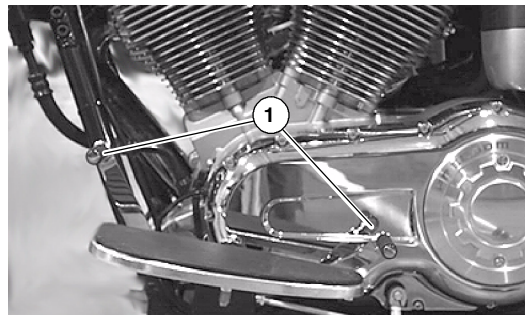

1. Gear Shift Pedal

Rear Brake Pedal

The rear brake pedal is on the right side of the motorcycle. To engage the rear brake, press down on the rear brake pedal.

For braking procedures in various riding conditions, see “Braking” on page 88.



2. Rear Brake Pedal

INSTRUMENTS, FEATURES AND CONTROLS

Fuel Cap

The fuel cap is right-hand threaded (turn clockwise to tighten, turn counterclockwise to loosen). When tightening the fuel cap, continue turning the cap until a clicking sound is heard, indicating proper tightness. Continue turning the fuel cap clockwise to align the Victory logo if desired.

For fueling procedure, see “Fueling and Fill Height,” page 81.

Auxiliary Light Switch (Touring Cruiser)

A toggle switch located under the left side of the upper triple clamp controls both auxiliary lights. The auxiliary lights operate only when the headlight is set to Low Beam. The auxiliary lights extinguish automatically when the headlight is set to High Beam. You can operate the motorcycle with the auxiliary light switch on or off.

INSTRUMENTS, FEATURES AND CONTROLS

Saddlebags (Leather)

Some Victory motorcycle models are equipped with leather saddlebags. For loading and operating speed information regarding models with saddlebags, see page 18. The load capacity for leather saddlebags is 7 lbs. (3.2 kg) each.

Saddlebags (Hard)

Touring Cruiser models are equipped with lockable hard saddlebags. Use the ignition key to lock or unlock the saddlebag. Each saddlebag has a net for small cargo. The load carrying capacity for lockable hard saddlebags is 10 lbs. (4.5 kg) each.

To open the saddlebag, depress the lock button to release the cover latch and open the cover outward, away from the motorcycle. To close the saddlebag, press down firmly near the lock button until the cover latch engages.

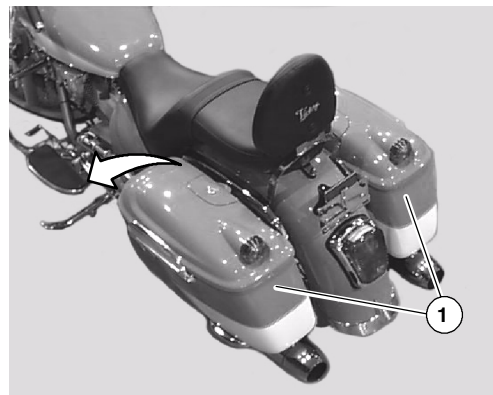

1. Lockable Hard Saddlebags

INSTRUMENTS, FEATURES AND CONTROLS

Side Covers

Your motorcycle is equipped with two removable side covers. Remove the left side cover to access the battery. Remove the right side cover to access the fuses and the rear brake fluid reservoir.

To remove either side cover, remove the operator's seat (see page 135) and pull the lower corners of the side cover out and away from the motorcycle until lower tab is disengaged. Lift the side cover up until top pins are clear of the mounting grommets, then remove cover from the motorcycle. Reverse this procedure to install the side cover.

Sidestand

The sidestand is located on the left side of the motorcycle.

WARNING

Correctly retract the sidestand before operating the motorcycle. An improperly retracted sidestand could come into contact with the ground and cause loss of control.

To extend the sidestand, swing it out from the end until it is fully extended. Lean the motorcycle toward the sidestand until the sidestand firmly supports the motorcycle.

To retract the sidestand, lean the motorcycle away from the sidestand until the motorcycle is fully upright. Swing the sidestand back into its fully retracted position.

PRE-OPERATION CHECK

To keep your Victory motorcycle in good operating condition, always perform the checks described in this section before each ride. This is especially important before making a long trip or when removing the motorcycle from storage. You must be familiar with the Victory motorcycle instruments and controls to make these checks. You can find additional service information in the maintenance section of this manual, in the *Victory Service Manual* or from an authorized Victory dealer.

During the pre-operation check you might use products that are potentially hazardous, such as oil or brake fluid. When using any of these products, follow the instructions and warnings on the product packaging.

WARNING

Failure to perform these checks before operating the motorcycle may result in serious injury or damage. Adjust components designed for normal wear adjustment, and repair or replace worn or damaged components as needed.

PRE-OPERATION CHECK

Check Electrical Equipment

To perform a pre-operation check on the electrical equipment, set the ignition switch to the ON position. Set the ignition switch to the OFF position after completing the electrical equipment portion of the pre-operation check.

Instrument Cluster

The low fuel indicator and the neutral indicator should illuminate momentarily. The multi-function display (MFD) should be in odometer mode. The low oil pressure indicator should illuminate. If the transmission is in neutral, the neutral indicator should remain illuminated.

Pressing the MFD MODE button should advance the MFD through the various functions (see page 51).

Headlamp

Check the headlamp to see that it is on. Set the headlamp switch to the high beam position. The headlamp brightness should increase and the headlamp high beam indicator in the instrument cluster should illuminate.

Taillight

With the ignition switch in the ON position, the taillight and the license plate light should illuminate. Apply slight pressure to the front brake lever; taillight brightness should increase. Apply slight pressure to the rear brake pedal; taillight brightness should increase.

PRE-OPERATION CHECK

Check Electrical Equipment

Turn Signals/Running Lights

The two amber front running lights should illuminate (US and Canadian models only). Move the turn signal switch to the left. The front and rear left turn signals and the left turn signal indicator in the instrument cluster should flash. Push the switch in toward the housing. The turn signals and turn signal indicator should stop flashing. Repeat the procedure for the right turn signals.

Emergency Flashers

Slide the emergency flasher switch to the left. All four turn signals and both turn signal indicators in the instrument cluster should flash. Slide the switch to the right. The turn signals and turn signal indicators should stop flashing.

Horn

Press the horn button. The horn should sound loudly.

Engine Stop/Run Switch

Be sure the engine stop/run switch stops the engine, or prevents the engine from starting when set to the STOP position.

Notice If you regularly use this switch to shut off the engine, you're already checking its operation each time you use the motorcycle.

PRE-OPERATION CHECK

Check Engine Oil Level

A dipstick attached to the oil fill cap registers the engine oil level. We recommend the use of only Victory brand Semi-Synthetic 20W-40 Motor Oil or equivalent.

1. With the transmission in neutral, start and run the engine for several minutes.
2. Shut the engine off and wait for 3-5 minutes.
3. Straddle the motorcycle on level ground and bring it to a vertical position. Remove the oil fill cap and wipe the dipstick clean. Reinstall the dipstick and turn the cap clockwise until it seats.
4. Remove the dipstick again and read the oil level.
5. If necessary, add or remove oil to bring the level into the area on the dipstick above the ADD mark and below the FULL mark. Repeat steps 1-2 each time you adjust the oil level.

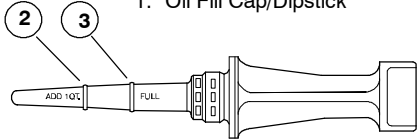
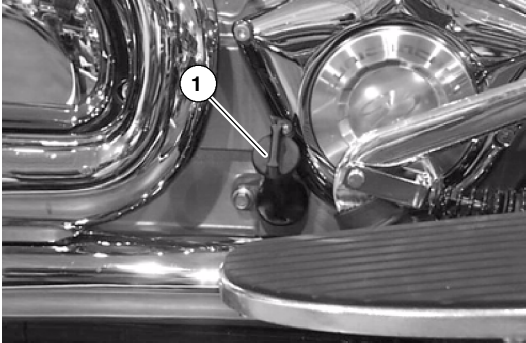

1. Oil Fill Cap/Dipstick

2. ADD Mark
3. FULL Mark

WARNING

Do not operate the motorcycle with the oil level above the FULL mark or below the ADD mark. Operating the engine with too much or too little oil can cause serious engine damage or engine seizure, resulting in loss of control.

PRE-OPERATION CHECK

Check Fuel Components

Fuel Level

1. Straddle the motorcycle on level ground and bring it to a vertical position.
2. Turn the ignition switch to the ON position and press the MFD MODE button until the fuel gauge appears in the MFD.
3. Check the fuel level.
4. Estimate your next fuel stop and plan accordingly to avoid running out of fuel.

Fuel Hose, Rail and Connections

Inspect the fuel hoses for cracks or damage. Inspect the hose connection at the fuel tank and at the fuel rail for dampness or stains from leaking or dried fuel.

Evaporative Emission Control System (California model only)

Visually inspect all evaporative emission control system hoses and connections. Make sure all connections are tight. Inspect the evaporative canister to make sure it has not been damaged.

PRE-OPERATION CHECK

Check Tires

Tire Pressure

Normal riding warms the tires and increases the tire air pressure. For an accurate reading, check the tire pressure before you ride. Adjust tire pressure as required for the total weight of your intended load. Refer to the tire pressure table on page 128.

Tire Condition

Inspect the tire sidewalls, road contact surface, and tread base for cuts, punctures, and cracking. Replace damaged tires immediately (see the *Victory Service Manual* or an authorized Victory dealer).

Tread Depth

Raised areas at the base of the tread, known as wear bars, act as easily visible tread depth indicators. See page 129. When the road contact surface has worn to the top of the wear bars, replace the tire.

PRE-OPERATION CHECK

Check Brakes

Front Brake Lever Movement

Squeeze the front brake lever toward the handlebar and release it. It should move freely and smoothly and should return to its rest position quickly when released. You should feel a firm resistance in the lever within the first 3/4-inch (19 mm) of lever travel.

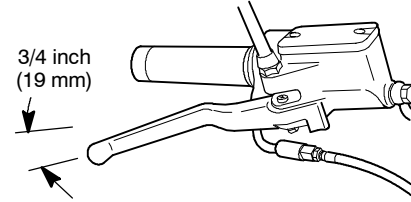

Front Brake Fluid Level

1. To check the front brake fluid level, rest the motorcycle on the sidestand and on level ground. Turn the handlebars until the front brake fluid reservoir is level.
2. View the brake fluid through the sight glass. The fluid should be clear and at a level in or above the sight glass. Add brake fluid if necessary (see page 121).

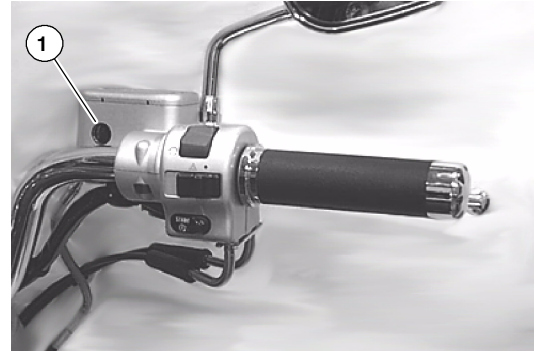

1. Front Brake Fluid Reservoir Sight Glass

PRE-OPERATION CHECK

Check Brakes

Rear Brake Pedal Freeplay and Movement

Rear brake pedal freeplay, the amount of brake pedal movement from the rest position to the point of contacting the master cylinder, should be 3/16-5/16 inch (5-8 mm). Adjust pedal freeplay as necessary (see page 123).

Press and release the rear brake pedal. It should move freely and smoothly and should return to its rest position quickly when you release it. You should feel a firm resistance in the pedal within the first 3/4 inch (19 mm) of pedal travel.

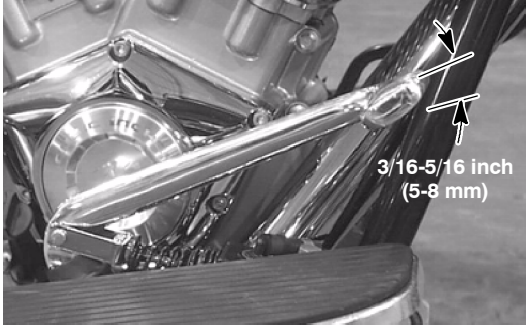

Check Rear Brake Fluid Level

1. To check the rear brake fluid level, remove the right side cover. Straddle the motorcycle and bring it to a vertical position.
2. View the brake fluid through the reservoir. The fluid should be clear and at a level between MIN and MAX. Add brake fluid if necessary (see page 124).

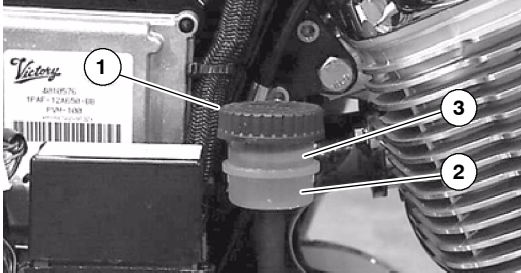

1. Rear Brake Fluid Reservoir
2. MIN Fluid Level
3. MAX Fluid Level

PRE-OPERATION CHECK

Check Brakes

Check Hoses and Connections

Inspect all brake hoses and connections for dampness or stains from leaking or dried fluid. Tighten any leaking connections and replace components as necessary.

Check Brake Pads

Look into the front brake caliper(s) from underneath to view the front pad friction material, and look into the rear brake caliper from behind to view the rear pad friction material. You should see at least 1/16 inch (1.6 mm) of friction material on each of the brake pads. If in doubt, measure the remaining friction material. Replace brake pads having less than the specified amount of friction material at their thinnest point.

Check Throttle Control Grip and Cables

1. Rotate the throttle control grip. It should rotate smoothly from its rest position to its completely open position and back again. It should return to its rest position quickly when released.
2. Throttle freeplay, the amount of throttle control grip movement from the rest position to the point of cable resistance, should be 1/8-1/4 inch (3-6 mm).
3. Adjust throttle cable freeplay if necessary (see page 115).

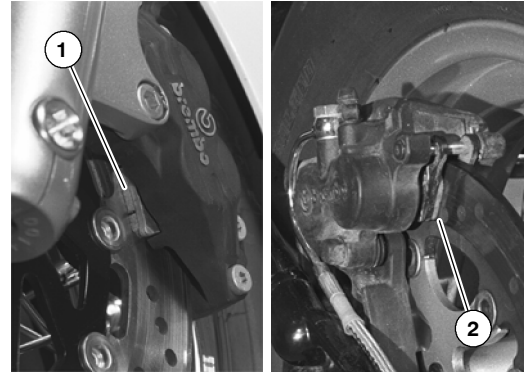

1. Front Brake Pad Friction Material

2. Rear Brake Pad Friction Material

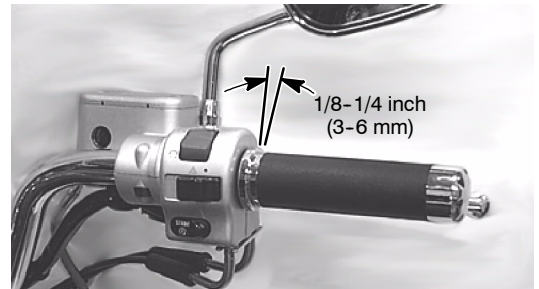

PRE-OPERATION CHECK

Check Clutch

1. Squeeze the clutch lever toward the handlebar and release it. It should move freely and smoothly and should return to its rest position quickly when released.
2. Clutch freeplay, the amount of clutch lever movement from the rest position to the point of cable resistance, should be between 0.02-0.04 inch (.5-1.0 mm). Measure the thickness of the gap between the clutch lever and the lever housing.
3. Adjust clutch lever freeplay if necessary (see page 118).

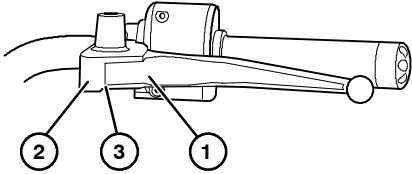

1. Clutch Lever
2. Lever Housing
3. Gap

Check Fast Idle Lever

1. Move the fast idle lever. It should move smoothly from its rest position to its completely open position and back again.
2. Fast idle lever freeplay, the amount of lever movement from the rest position to the point of cable resistance, should be 1/8-1/4 inch (3-6 mm).
3. Adjust fast idle lever freeplay if necessary (see page 114).

PRE-OPERATION CHECK

Check Front Suspension

1. To check the front suspension, straddle the motorcycle and bring it to a vertical position.
2. Apply the front brake and push down hard on the handlebars several times. The front suspension should operate smoothly and quietly.
3. Place the motorcycle on the sidestand and inspect the front forks. Make sure there is no fork oil present on the fork tube or around the fork seal.

Check Steering

Straddle the motorcycle and bring it to a vertical position. Turn the handlebars from stop to stop. The action should be smooth but not loose or interfered with by wires, hoses or control cables.

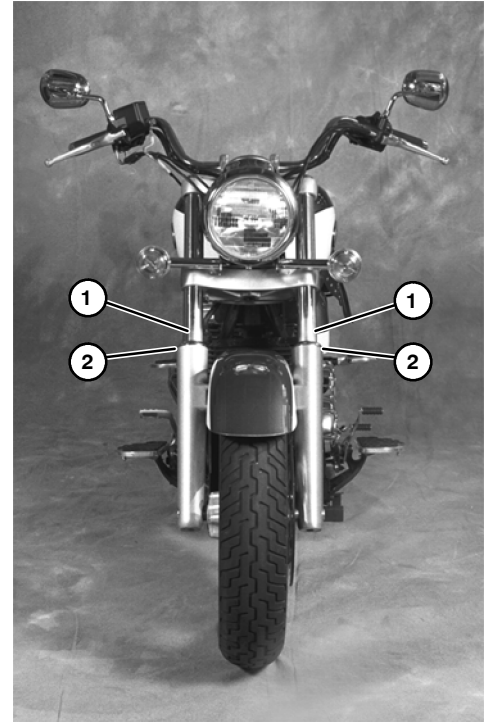

1. Front Fork Tube
2. Fork Seal

PRE-OPERATION CHECK

Check Rear Suspension

Proper rear suspension adjustment is essential for a safe and comfortable ride. Check the rear shock absorber movement and preload to ensure that the motorcycle has the correct amount of suspension travel and ground clearance (see page 107).



Inadequate ground clearance could allow components to come into contact with the ground, causing loss of control.

Check Drive Belt

The drive belt should fit tightly.

Replace the drive belt if it is cracked or has broken teeth or frayed edges (consult your *Victory Service Manual* or an authorized Victory dealer).

PRE-OPERATION CHECK

Check Sidestand

Straddle the motorcycle and bring it to a vertical position. Move the sidestand to its stored (up) position, then to its fully extended (down) position and back again. It should move smoothly and quietly. When the sidestand is in its stored position, the sidestand return spring should hold the sidestand tightly against the motorcycle.

Check the condition of the sidestand rubber pad, and make sure it's firmly attached to the sidestand.

Check Fasteners

Visually inspect the entire motorcycle chassis and engine for loose, damaged or missing fasteners. Tighten loose fasteners to the proper torque (see the specifications section of this manual or see the *Victory Service Manual*). Immediately replace stripped, damaged or broken fasteners with genuine Victory fasteners of equal size and strength immediately.

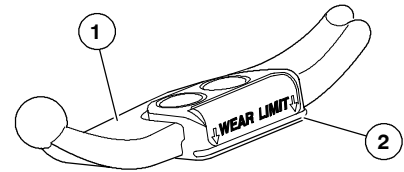

1. Sidestand
2. Rubber Pad

- NOTES -

OPERATION

The operation section describes how to operate your Victory motorcycle for best performance and longevity. Important areas covered include:

- Engine Break-in Period
- Fueling and Fill Height
- Starting the Engine
- Shifting Gears
- Accelerating
- Braking
- Stopping the Engine
- Parking

For safe operation and riding, see the safety section beginning on page 6.

Engine Break-in Period

During the first 500 miles (800 kilometers), critical engine parts require special wear-in procedures so they seat and mate properly. Read, understand and use the following rules for operating the motorcycle during the first 500 miles (800 kilometers) to ensure your engine's long-term performance and durability.

Caution

Do not put unnecessary load on the engine during the first 500 miles (800 kilometers). Avoid prolonged full throttle operation or any condition that creates excessive engine heat.

OPERATION

Engine Break-in Period

0-90 miles (0-145 kilometers)

- Do not operate the motorcycle for extended periods of time at throttle positions above 1/3 throttle. Vary the engine speed of the motorcycle. Do not operate the motorcycle for extended periods of time at any one set throttle position.

90-300 miles (145-483 kilometers)

- Do not operate the motorcycle for extended periods of time at throttle positions above 1/2 throttle. Vary the engine speed of the motorcycle. Do not operate the motorcycle for extended periods of time at any one set throttle position.

300-500 miles (483-800 kilometers)

- Do not operate the motorcycle for extended periods of time at throttle positions above 3/4 throttle.

At 500 miles (800 kilometers)

- Perform initial maintenance as described in the Maintenance section of the *Owner's Manual*. This maintenance is one of the most important services your motorcycle requires and should be performed by an authorized Victory dealer. Initial maintenance includes servicing all adjustments, tightening all fasteners, and changing engine oil. Performing this maintenance at the required mileage point helps the engine maintain top performance for its entire service life.

Caution

If engine trouble should occur during the engine break-in period, consult the *Maintenance* section of the *Owner's Manual*, the *Victory Service Manual*, or an authorized Victory dealer immediately.

Engine Break-in Period

Fueling and Fill Height

Fuel the motorcycle with the sidestand down and on level ground. Use only the recommended fuel (see “Fuel Specifications” on page 172). Fill the fuel tank to a level just below the bottom of the fuel filler insert.

WARNING

- **Do not allow gasoline to come into contact with a hot engine or exhaust system. This could cause a fire. Immediately wipe, or rinse with water, gasoline spilled on any part of the motorcycle or the surrounding area.**
 - **Do not fill the fuel tank above the fuel filler insert. Overfilling the fuel tank may cause fuel to overflow when it expands.**
 - **Fuel may leak from an improperly seated or tightened fuel cap. Tighten the fuel cap until you hear one or more distinct clicks. Be sure the fuel cap is properly seated and tightened before starting the engine.**
-

Caution

Fuel can damage painted surfaces and plastic parts. Wipe spilled fuel immediately from the motorcycle using a clean, dry, soft cloth.

Notice

If the motorcycle has run completely out of fuel, cycle the fuel pump 4-5 times to prime the system before starting the engine. To cycle the fuel pump, set the ignition switch to the ON position and toggle the engine stop/run switch from the STOP position to the RUN position 4-5 times.

OPERATION

Engine Break-in Period

Starting the Engine

The Victory motorcycle has a starter interlock system. The engine can be started only when the transmission is in neutral or when the transmission is in gear and the clutch is disengaged.

Follow these steps to start the motorcycle:

1. Unlock the steering lock (see page 45).
2. Perform the Pre-Operation Check as outlined beginning on page 64. If you're carrying cargo, inspect the cargo restraints for tightness.
3. Insert the ignition key into the ignition switch and turn the switch to the ON position (see page 46).
4. Mount the motorcycle and bring it to an upright position. Engage the front brake and place the sidestand in the stored (up) position. If the neutral indicator is not illuminated, shift the transmission to neutral (see Shifting Gears, page 84).
5. If the engine is cold (has not been run in a few hours) move the fast idle lever toward the rear of the motorcycle until the lever stops.
6. Set the engine stop/run switch to the RUN position. You should hear the fuel pump momentarily as it pressurizes the fuel system.

Engine Break-in Period

Starting the Engine

7. Leaving the throttle closed, press and hold the starter button until the engine starts. If the engine does not start within a few seconds after you press the starter button, release the button and wait several seconds. Then press and hold the starter button again. Hold the starter button for as short a time as possible to minimize battery drain, and do not push the starter button for more than 10 seconds at any one time.

NOTE: If either the check engine indicator or the low oil pressure indicator does not go out after the engine starts, stop the engine. See either “Check Engine Indicator” on page 54 or “Low Oil Pressure Indicator” on page 49.

8. As soon as the engine warms enough to idle smoothly, move the fast idle lever toward the front of the motorcycle until the lever stops.

Caution

Do not rev the engine or put the transmission in gear immediately after starting the engine. Allow the engine to idle for about one minute after a cold start, or 30 seconds after a warm start to allow the oil to reach all areas requiring lubrication before the engine is put under load.

OPERATION

Shifting Gears

WARNING

The clutch must be fully disengaged (clutch lever pulled completely in toward the handlebars) before you attempt to shift gears. Forced shifting (shifting without the clutch disengaged) may damage the engine, transmission and drive train, causing loss of control of the motorcycle.

The motorcycle is equipped with a five-speed transmission. The gear pattern is shown in the illustration to the right. The motorcycle has a heel-toe shift pedal which allows you to shift to a higher gear by depressing the rear of the pedal with your heel or by lifting the front of the pedal with your toe. To shift to a lower gear, depress the front of the pedal with your toe.

Neutral position is between first and second gear. The transmission is in neutral when the motorcycle moves forward or backward freely while the clutch is engaged. With the Ignition switch set to the ON position, the neutral indicator illuminates when the transmission is in neutral.

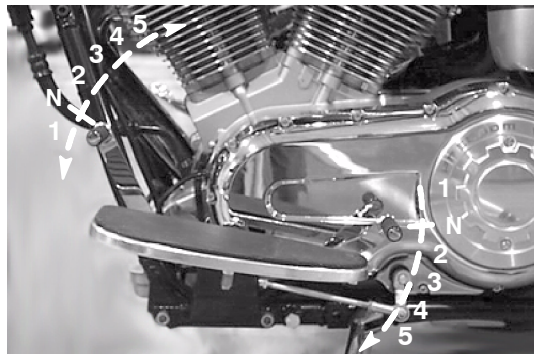

Shifting Gears

To engage first gear, start the engine (see “Starting the Engine” on page 82). With the engine at idle speed, engage the front brake (squeeze the brake lever) and disengage the clutch (squeeze the clutch lever). Push the shift pedal down until you feel it stop in first gear. Disengage the front brake (release the brake lever). Simultaneously moving both the clutch lever and the throttle control grip with a smooth, gentle motion, gradually engage the clutch (release the clutch lever) and open the throttle (roll the throttle control grip toward you). As the clutch begins to engage, the motorcycle begins to move forward.

To shift to the next higher gear, accelerate smoothly and easily to the recommended shift point (see “Recommended Shift Points” on page 86). With a quick motion, simultaneously close the throttle completely and disengage the clutch. Raise the shift pedal with your toe, or depress it with your heel, until you feel it stop at the next gear. Simultaneously moving both the clutch lever and the throttle with a smooth, gentle motion, gradually release the clutch lever and open the throttle.

Within the recommended speed ranges (see “Recommended Shift Points” on page 86), you can downshift (shift to a lower gear) to slow the motorcycle or to increase the available power. You may want to downshift when climbing a hill or passing. Downshifting also helps to decrease your speed when combined with closing the throttle.

To shift to a lower gear, simultaneously pull in the clutch lever and close the throttle. Shift into the next lower gear by depressing the shift pedal with your toe. Simultaneously release the clutch lever and open the throttle.

OPERATION

Shifting Gears

WARNING

- Downshifting at a speed in excess of the recommended downshift point may severely damage the transmission or cause the rear wheel to lose traction. It could also result in engine damage from running at excessive rpm. Reduce speed before downshifting and do not downshift at a speed above that in the table of recommended shift points.
 - Downshifting abruptly on wet, rough, loose, or slippery surfaces can cause the motorcycle to skid. When downshifting while passing over such surfaces, release the clutch lever very gradually.
 - Downshifting in a curve may cause the rear wheel to lose traction. Downshift before you enter a curve.
-

Recommended Shift Points

The following table shows the appropriate speed at which to shift up or down to each gear.

Upshift (Acceleration) Gear Change	Upshift Speed	Downshift (Deceleration) Gear Change	Downshift Speed
1st to 2nd	15 mph (24 km/h)	5th to 4th	35 mph (56 km/h)
2nd to 3rd	25 mph (40 km/h)	4th to 3rd	25 mph (40 km/h)
3rd to 4th	35 mph (56 km/h)	3rd to 2nd	15 mph (24 km/h)
4th to 5th	45 mph (72 km/h)	2nd to 1st	10 mph (16 km/h)

Accelerating

To accelerate, open the throttle (roll the throttle control grip toward you). For even acceleration, open the throttle with a smooth, continuous motion. When you reach the recommended speed for upshifting, shift up one gear according to the instructions in “Shifting Gears” on page 84. The more quickly you open the throttle, the more quickly the motorcycle accelerates.

WARNING

- **Abrupt acceleration can cause your body to shift suddenly toward the rear of the motorcycle.**
 - **Accelerating abruptly on wet, rough, loose, or slippery surfaces may cause the rear wheel to lose traction. When accelerating on such surfaces, whether you are at a stop or already in motion, open the throttle gradually.**
-

OPERATION

Braking

To slow the motorcycle with the brakes, close the throttle and apply the front and rear brakes evenly. As the motorcycle slows, either disengage the clutch or downshift each time your speed reaches a downshift point. Applying slightly more front brake than rear brake generally gives you the best braking performance. Do not apply the brakes so forcefully or quickly that either wheel stops rotating. Leave sufficient distance so you can apply the brakes gradually if you need to stop.

WARNING

- **Do not apply either brake so strongly that the wheel stops rotating. This may cause loss of control.**
 - **Braking hard on wet, rough, loose, or slippery surfaces can cause the motorcycle to skid, and you could lose control of the motorcycle. Apply the brakes lightly on such surfaces.**
 - **Braking while in a curve can cause loss of control. Bring the motorcycle to the upright position before applying the brakes, and avoid applying the brakes in a corner if at all possible.**
-

Stopping the Engine

Before stopping the engine, bring the motorcycle to a complete stop either in neutral or with the clutch disengaged. Once the motorcycle is at a complete stop, if it is not already in neutral, shift into neutral. To stop the engine, set the engine stop/run switch to the STOP position, turn the ignition switch to the OFF position, and remove the ignition key.

WARNING

- **Stopping the engine while the motorcycle is in motion and the transmission is engaged may damage the engine and the transmission or cause the rear wheel to lose traction. In either case, you may lose control.**
 - **If the motorcycle is in motion and the engine stops on its own, guide the motorcycle to a safe location off the road and away from traffic.**
-

OPERATION

Parking the Motorcycle

When parking the motorcycle, choose a flat, firm surface. Bring the motorcycle to a complete stop and, with the transmission in neutral, stop the engine. Fully extend the sidestand, turn the handlebars to the left, and lean the motorcycle to the left until the sidestand firmly supports the motorcycle. Lock the steering lock, and take the key with you.

WARNING

Moving or operating the motorcycle with the forks locked severely restricts steering and can cause loss of control.

If you must park on a slope, point the motorcycle toward the top of the slope. Put the transmission in gear and park the motorcycle so that it is stable when it rests on the sidestand.

If you must park on a soft surface, use a sidestand plate under the foot of the sidestand to provide a firm surface. The sidestand footrest must be strong enough and large enough to support the motorcycle's weight without sinking into the parking surface. Many motorcyclists carry a sidestand plate.

Parking the Motorcycle

Caution

Asphalt pavement can become soft in hot weather. The sidestand can sink into soft asphalt until the motorcycle falls over. When parking on asphalt in hot weather, use a sidestand footrest under the foot of the sidestand to prevent the sidestand from sinking into the asphalt.

WARNING

A hot engine or hot exhaust pipes can be hazardous. The engine and exhaust pipes are hot for some time after the engine is stopped. Touching the engine or exhaust pipes while hot can cause serious burns. Allowing flammable materials to contact a hot engine or exhaust pipes may cause a fire. Park the motorcycle where people will not touch the engine or exhaust pipes and where it is not near flammable materials.

MAINTENANCE

This section includes information for maintaining your Victory motorcycle. It includes recommended periodic maintenance intervals, which outlines the regular service required to keep your motorcycle in the best operating condition. Regular service increases motorcycle durability, safety, and dependability, and it provides greater riding pleasure. Also refer to the safety-related maintenance information beginning on page 22.

Before you begin any maintenance procedure, read the instructions for the entire procedure in this section of the *Owner's Manual*. Choose a flat, firm surface for servicing the motorcycle. Make sure you have the time, tools, and expertise to complete a procedure properly.

During maintenance you might use products that are potentially hazardous; such as oil or brake fluid. When using any of these products, follow the instructions and warnings on the product packaging.

For information on major repairs, see the *Victory Service Manual*. Major repairs typically require the technical skills and specially designed tools available from your authorized Victory dealer.

Your Victory dealer has the equipment and training required to properly perform emission system maintenance and repairs.

Initial Maintenance

Perform the initial maintenance after you've ridden your new motorcycle 500 miles (800 kilometers). This maintenance is one of the most important services your motorcycle requires and should be performed by an authorized Victory dealer. Initial maintenance includes servicing all adjustments, tightening all fasteners, and changing engine oil. Performing this maintenance at the required mileage point helps the engine maintain top performance for its entire service life.

Periodic Maintenance Intervals

Use the following table to determine how often you should perform maintenance on various components. For additional information on maintenance operations for each component listed in the table, refer to the instructions in this section.

Caution

If you regularly ride your motorcycle at high or low speed for extended periods of time, or in dusty or other adverse conditions, perform the required maintenance more frequently to help keep your motorcycle in safe operating condition.

Notice Use the space provided at the back of this manual to record information about maintenance performed on your motorcycle.

Periodic Maintenance Interval Table

Component (see operation codes below)	ODOMETER READING in MILES (KILOMETERS)																				
	500 (800)	2,500 (4,000)	5000 (8,000)	7,500 (12,000)	10,000 (16,000)	12,500 (20,000)	15,000 (24,000)	17,500 (28,000)	20,000 (32,000)	22,500 (36,000)	25,000 (40,000)	27,500 (44,000)	30,000 (48,000)	32,500 (52,000)	35,000 (56,000)	37,500 (60,000)	40,000 (64,000)	42,500 (68,000)	45,000 (72,000)	47,500 (76,000)	50,000 (80,000)
Engine Oil* - page 97	R	R	R	R	R	R	R	R	R	R	R	R	R	R	R	R	R	R	R	R	R
Engine Oil Filter* - page 97	R	R	R	R	R	R	R	R	R	R	R	R	R	R	R	R	R	R	R	R	R
Air Filter - page 100	I	I	R	I	R	I	R	I	R	I	R	I	R	I	R	I	R	I	R	I	R
Drive Sprocket and Sprocket Nut - page 101							I						I						I		
Drive Belt - page 102	I	I	I	I	I	I	I	I	I	I	I	I	R	I	I	I	I	I	I	I	I
Rear Wheel Alignment - page 105	I		I		I		I		I		I		I		I		I		I		I
Rear Shock Absorber - page 107	I		I		I		R		I		I		R		I		I		R		I
Swing Arm and Rear Axle - page 109	I		I		I		I		I		I		I		I		I		I		I
Front Fork Oil** - page 110	I		I		I		R		I		I		R		I		I		R		I
Front Forks and Front Axle - page 111	I		I		I		I		I		I		I		I		I		I		I
Fuel System - page 112	I	I	I	I	I	I	I	I	I	I	I	I	I	I	I	I	I	I	I	I	I
Operation Codes: I-Inspect (tighten, clean, adjust, correct or replace if necessary) R-Replace/Rebuild *Replace at specified interval or annually L-Lubricate with proper lubricant P-Perform **Replace at specified interval or every 2 years																					

Periodic Maintenance Interval Table (continued)

Component (see operation codes below)	ODOMETER READING in MILES (KILOMETERS)																				
	500 (800)	2,500 (4,000)	5000 (8,000)	7,500 (12,000)	10,000 (16,000)	12,500 (20,000)	15,000 (24,000)	17,500 (28,000)	20,000 (32,000)	22,500 (36,000)	25,000 (40,000)	27,500 (44,000)	30,000 (48,000)	32,500 (52,000)	35,000 (56,000)	37,500 (60,000)	40,000 (64,000)	42,500 (68,000)	45,000 (72,000)	47,500 (76,000)	50,000 (80,000)
Crankcase Ventilation System - page 112	I		I		I		I		I		I		I		I		I		I		I
Evaporative Emission Control System (Calif. Only) - page 112	I		I		I		I		I		I		I		I		I		I		I
Fuel Filter - page 113										R											R
Fast Idle Lever - page 114	I		I		L		I		L		I		L		I		L		I		L
Throttle - page 115	I	I	I	I	L	I	I	I	L	I	I	I	L	I	I	I	L	I	I	I	L
Clutch Lever - page 116	I		I		L		I		L		I		L		I		L		I		L
Control Cables - page 119	I		I		L		I		L		I		L		I		L		I		L
Front Brake Lever - page 120	I		I		L		I		L		I		L		I		L		I		L
Rear Brake Pedal - page 122	I		I		I		I		I		I		I		I		I		I		I
Brake Fluid** - page 121 & 123	I	I	I	I	I	I	I	I	I	I	I	I	R	I	I	I	I	I	I	I	I
Operation Codes: I-Inspect (tighten, clean, adjust, correct or replace if necessary) R-Replace/Rebuild *Replace at specified interval or annually L-Lubricate with proper lubricant P-Perform **Replace at specified interval or every 2 years																					

Periodic Maintenance Interval Table (continued)

Component (see operation codes below)	ODOMETER READING in MILES (KILOMETERS)																				
	500 (800)	2,500 (4,000)	5000 (8,000)	7,500 (12,000)	10,000 (16,000)	12,500 (20,000)	15,000 (24,000)	17,500 (28,000)	20,000 (32,000)	22,500 (36,000)	25,000 (40,000)	27,500 (44,000)	30,000 (48,000)	32,500 (52,000)	35,000 (56,000)	37,500 (60,000)	40,000 (64,000)	42,500 (68,000)	45,000 (72,000)	47,500 (76,000)	50,000 (80,000)
Brake Pads - page 126	I	I	I	I	I	I	I	I	I	I	I	I	I	I	I	I	I	I	I	I	I
Gear Shift Pedal - page & 127	I		I		I		I		I		I		I		I		I		I		I
Tires - page 128	I	I	I	I	I	I	I	I	I	I	I	I	I	I	I	I	I	I	I	I	I
Wheel Spokes - page 130	I		I		I		I		I		I		I		I		I		I		I
Spark Plugs - page 131	I		I		I		I		I		I		R		I		I		I		I
Engine Compression - page 133	I				I				I				I				I				I
Exhaust System - page 133	I	I	I	I	I	I	I	I	I	I	I	I	I	I	I	I	I	I	I	I	I
Battery - page 136	I		I		I		I		I		I		I		I		I		I		I
Headlamp - page 141	I				I				I				I				I				I
Auxiliary Lights - page 142	I		I		I		I		I		I		I		I		I		I		I
Sidestand - page 145	I		I		L		I		L		I		L		I		L		I		L
Fasteners - page 147	I		I		I		I		I		I		I		I		I		I		I
Road Test - page 147	P	P	P	P	P	P	P	P	P	P	P	P	P	P	P	P	P	P	P	P	P
Operation Codes:																					
I-Inspect (tighten, clean, adjust, correct or replace if necessary)						R-Replace/Rebuild						*Replace at specified interval or annually									
L-Lubricate with proper lubricant						P-Perform						**Replace at specified interval or every 2 years									

Engine Oil

Changing Engine Oil and Oil Filter

1. Start and run the engine until it reaches normal operating temperature. Stop the engine.
2. Securely support the motorcycle on the sidestand.
3. Place an oil drain pan under the drain plug and oil filter (center rear of the engine).
4. Remove the drain plug and seal, allowing the oil to drain into the pan.
5. Use an oil filter wrench to loosen the filter slowly. Allow oil in the filter to drain before removing the filter. Remove the oil filter.
6. Use a new seal and reinstall the drain plug.

Torque: 20 ft-lbs (27 Nm)

7. Clean any residue or debris from the oil filter mounting plate and threads.
8. Make sure the new oil filter gasket is properly seated in the oil filter, and apply a thin film of clean engine oil to the gasket. Screw the new filter on until the gasket contacts the filter mounting plate. Tighten the filter *by hand* an additional 3/4 turn.
9. Fill the crankcase through the oil fill cap with 6 quarts (5.7 liters) of oil. We recommend the use of only Victory Brand Semi-Synthetic 20W-40 Motor Oil or equivalent.
10. Reinstall the oil fill cap and then start and run the engine until it reaches normal operating temperature.

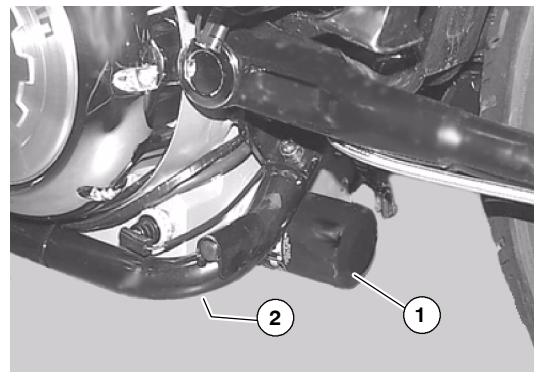

1. Oil Filter
2. Drain Plug (under engine)

MAINTENANCE

Engine Oil

Change Engine Oil and Oil Filter

Caution

After an oil change, the low oil pressure indicator remains illuminated longer than usual before going out. Revving the engine while the low oil pressure indicator is illuminated can damage the engine.

11. Stop the engine and make sure there are no leaks around the drain plug and oil filter. Check the oil level and adjust if needed.

Notice Recycle used oil and oil filter in accordance with local regulations.

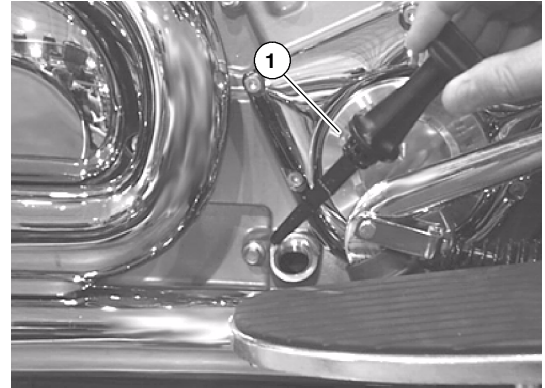
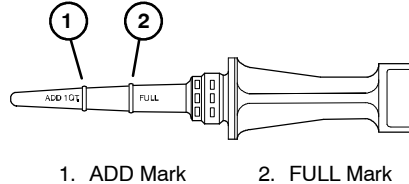

1. Oil Fill Cap/Dipstick

Engine Oil

Check Engine Oil Level

1. With the engine at normal operating temperature, straddle the motorcycle on level ground and bring it to a vertical position. Remove the oil fill cap and wipe the dipstick clean. Reinstall the dipstick and turn the cap clockwise until it seats.
2. Remove the dipstick again and note the oil level.
3. If necessary, add or remove oil to bring the level into the area on the dipstick, above the ADD mark and below the FULL mark (see page 67). Repeat steps 1-2 each time you adjust the oil level.

WARNING

Do not operate the motorcycle with the oil level above the FULL mark or below the ADD mark. Operating the engine with too much or too little oil can cause serious engine damage or engine seizure, resulting in loss of control of the motorcycle.

MAINTENANCE

Inspect Air Filter

The standard Victory air filter element is a dry paper design and does not require the use of air filter oil.

Notice Inspect the air filter often if riding in unusually wet or dusty conditions.

1. Remove the air filter access cover and the air filter element.
2. To remove debris from the element, use low-pressure air and blow from the rear forward.

WARNING

Wear face protection when using pressurized air.

3. Apply a small amount of lubricant to the edge of the air filter element frame and reinstall the element and access cover. Do not overtighten the access cover screws.

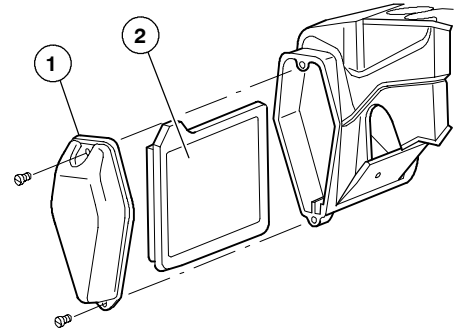

1. Air Filter Access Cover
2. Air Filter Element

Inspect Drive Sprocket and Sprocket Nut

1. Remove the drive sprocket cover.

Notice On some models you may have to remove portions of the exhaust system to access all of the drive sprocket cover screws (see the *Victory Service Manual* or an authorized Victory dealer).

2. Inspect drive sprocket and sprocket nut for wear or damage. Make sure the sprocket nut is tight.
3. If the sprocket nut is loose, remove the sprocket nut retainer screws and the retainer.
4. Remove the sprocket nut. Replace with a new sprocket nut if necessary.
5. Clean the output shaft threads and the sprocket nut threads.
6. Apply a few drops of Loctite Thread Locker #262 or equivalent to the output shaft threads.
7. Apply the rear brake and tighten the drive sprocket nut.

Torque: 125 ft-lbs (169 Nm)

8. Install the nut retainer and the retainer screws. Rotate the retainer plate clockwise and hold it against the nut when retainer screws are tightened.

Torque: 85 in-lbs (10 Nm)

Notice The nut retainer can be installed in many positions and on either side. If you cannot align the mounting holes, tighten the sprocket nut slightly and install the nut retainer.

9. Check rear wheel alignment (see page 105) and drive belt tension (see page 102).

MAINTENANCE

Drive Belt

Check Drive Belt Condition

Replace the drive belt if it is cracked or has broken teeth or frayed edges. No matter its condition, the drive belt should be replaced at periodic intervals (see the *Victory Service Manual* or an authorized Victory dealer).

Check Drive Belt Tension

This procedure involves using the belt tension gauge, part no. PV-43532, which is designed specifically for measuring drive belt tension.

Before beginning this procedure:

- Make sure the drive belt is dry and at room temperature.
 - Make sure the rear suspension is properly adjusted (see “Adjust Rear Shock Absorber” page 107).
1. Place the transmission in Neutral and lift the rear wheel off the ground with an appropriate motorcycle lift or a block of wood or steel placed securely under the frame.

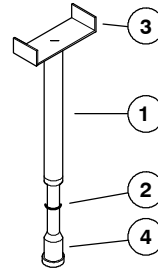

1. Belt Tension Gauge
2. Small O-Ring
3. Base
4. Plunger

Drive Belt

Check Drive Belt Tension

2. Position the small O-ring on the belt tension gauge directly over the 10 lbs. mark on the plunger as shown.
3. Place a tape measure or rule next to the drive belt as shown.
4. Place the base of the tension gauge bracket squarely against the lower strand of the drive belt halfway between the front and rear drive sprockets. Use the tape measure or ruler and record the position of the base of the tension gauge bracket. This position represents *zero force*.
5. Push the plunger upward until the small O-ring touches the tension gauge body. Make sure the tension gauge is seated squarely against the drive belt, and record the position of the base of the tension gauge bracket. This position represents *10 lbs. force*.
6. Calculate the difference between the *zero force* position and the *10 lbs. force* position you recorded.
 - Classic Cruiser: 5/16 inch (8.0 mm)
 - Touring Cruiser : 23/64 inch (9.0 mm)
7. Adjust belt tension as necessary.

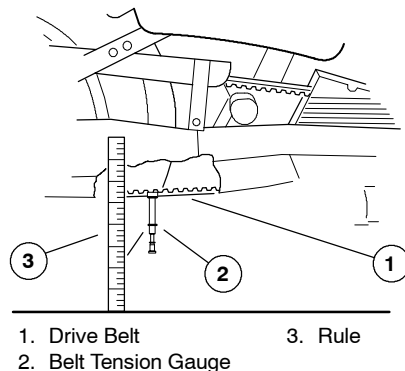

MAINTENANCE

Drive Belt

Adjust Drive Belt Tension

Notice Before adjusting drive belt tension, be sure the rear axle is properly aligned (see “Align Rear Wheel” page 105).

1. Remove and discard the rear axle cotter pin. Loosen the rear axle castle nut and the rear axle adjuster jam nuts.
2. Turn both rear axle adjusters an equal amount until the drive belt tension is correct (see “Check Drive Belt Tension,” page 102), making sure the adjusters are firmly seated against the axle spacers.
3. Tighten the adjuster jam nuts.

Torque: 12 ft-lbs (16 Nm)

4. Tighten the rear axle castle nut.

Torque: 65 ft-lbs (88 Nm)

5. Recheck drive belt tension, and install a new rear axle cotter pin.

WARNING

Do not reuse a cotter pin because it may fail, allowing the wheel to loosen and loss of control of the motorcycle.

6. Pump rear brake several times to reset brake pad distance.

Align Rear Wheel

This procedure involves using the rear wheel alignment tool, part no. PV-43528, which is designed specifically for aligning the rear wheel. Do not rely on the rear axle reference marks for wheel alignment.

WARNING

A skewed rear axle can damage the drive belt, causing it to fail and loss of control of the motorcycle.

1. Bring the motorcycle to a vertical position with an appropriate motorcycle lift or a block of wood or steel placed securely under the frame.
2. Remove the swing arm pivot caps and install the rear wheel alignment tool on the right side of the motorcycle.
3. Measure and record the distance from the tip of the alignment tool to the center of the rear axle.
4. Install the rear wheel alignment tool on the left side of the motorcycle.
5. Measure and record the distance from the base of the alignment tool to the center of the rear axle. The right side measurement and the left side measurement must be identical.
6. To adjust the rear wheel alignment, remove and discard the rear axle cotter pin and loosen the rear axle castle nut. Loosen the rear axle adjuster jam nuts.

MAINTENANCE

Align Rear Wheel

7. Turn the axle adjuster on the side with the longer measurement counterclockwise one flat (1/6 revolution). Turn the axle adjuster on the side with the shorter measurement clockwise one flat (1/6 revolution). Recheck rear wheel alignment as outlined in steps 2-5. Readjust if necessary.

Notice Whenever you turn the rear axle adjusters, push the rear wheel forward to keep the axle spacers seated against the axle adjusters.

8. Reinstall the swing arm pivot caps.
9. Check and adjust drive belt tension (see page 102).
10. Hold the axle adjusters in position and tighten the adjuster jam nuts.

Torque: 12 ft-lbs (16 Nm)

11. Tighten the rear axle nut.

Torque: 65 ft-lbs (88 Nm)

12. Recheck drive belt tension and install a new rear axle cotter pin.

WARNING

Do not reuse a cotter pin because it may fail, causing the wheel to loosen and loss of control of the motorcycle.

13. Pump rear brake several times to reset brake pad distance.

Rear Suspension

Adjust Rear Shock Absorber

This procedure involves using the shock absorber preload wrench PV-43507, which is designed specifically for adjusting the shock absorber preload.

Notice The distance measured while the motorcycle is elevated will not change, and needs only be measured once. After the measurement and the locations from where the measurement is taken is recorded (steps 1-4), you will only need to perform steps 5-8 to correctly adjust the rear shock absorber.

Have an assistant help you complete the following procedure.

1. Elevate the rear of the motorcycle until the rear wheel is about 1 inch (2.5 cm) off of the ground. Use an appropriate motorcycle lift or a block of wood or steel placed securely under the frame.

2. Measure the distance from the center of the rear axle to the bottom of the rear fender directly above the axle.

NOTE: On some models it may be easier to measure from the top of the drive belt guard to a convenient spot on the rear fender (along the pinstriping for example). Both locations must be directly above the rear axle.

3. Record the measurement and the locations from where the measurement is taken in the space provided.

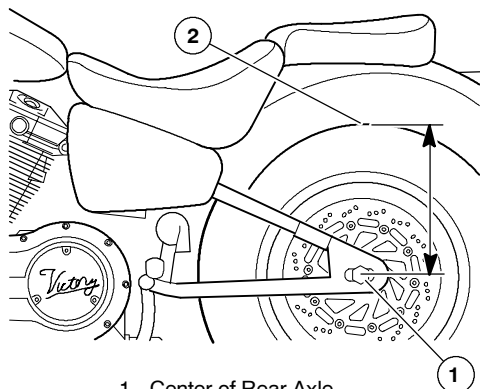

1. Center of Rear Axle
2. Bottom of Rear Fender

Measurement (step 2) _____

Upper Location (step 2) _____

Lower Location (step 2) _____

MAINTENANCE

Rear Suspension

Adjust Rear Shock Absorber

4. Remove the motorcycle lift apparatus and return the motorcycle to the ground.
5. Load the motorcycle with all the things you intend to carry (cargo and accessories). Sit in the operator's seat with your riding gear on, and if you plan on carrying a passenger, have them sit in the passenger seat with their riding gear on.
6. Have your assistant bounce the rear suspension a few times by pushing down on the rear fender slowly and releasing. Make sure the suspension moves freely without binding.
7. Without moving the motorcycle, have your assistant measure the distance from the center of the rear axle to the bottom of the rear fender directly above the axle. This measurement must be taken from the same locations recorded in step 2.
8. Subtract the second measurement (step 7) from the first measurement (recorded in step 2). The difference is called "sag" and should be $\frac{3}{4}$ to $1 \frac{1}{4}$ inch (19 to 32 mm). Adjust the shock absorber preload and recheck the sag if necessary. Rotate adjuster nut clockwise (viewed from the rear of shock absorber) to **DECREASE** the sag measurement, and counterclockwise to **INCREASE** the sag measurement.

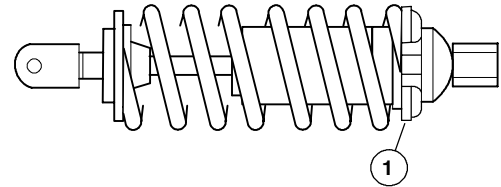

1. Preload Adjustment Collar

Rear Suspension

Inspect Swing Arm and Rear Axle

1. Remove the swing arm pivot covers and tighten the swing arm pivot nut.

Torque: 85 ft-lbs (115 Nm)

2. Reinstall the pivot nut covers.
3. Sit in the operator's seat and slowly bounce the rear suspension a few times. Make sure the suspension moves freely without binding.
4. Elevate the rear of the motorcycle until the rear wheel is off of the ground. Use an appropriate motorcycle lift or a block of wood or steel placed securely under the frame.
5. Grasp the rear tire and attempt to move the rear wheel side-to-side.
NOTE: If there is movement at the rear axle, inspect the wheel bearings and rear axle (see the *Victory Service Manual* or an authorized Victory dealer).
If there is movement at the front of the swing arm, check the swing arm pivot nut torque. If movement is still present, inspect the swing arm pivot bushings (see the *Victory Service Manual* or an authorized Victory dealer).
6. With the transmission in neutral, slowly rotate the rear wheel. If the wheel does not rotate smoothly, inspect the wheel bearings and rear axle (see the *Victory Service Manual* or an authorized Victory dealer).

MAINTENANCE

Front Suspension and Steering

Check Front Forks

1. To check the front suspension, straddle the motorcycle and bring it to a vertical position.
2. Apply the front brake and push down hard on the handlebars several times. The front suspension should operate smoothly and quietly.
3. Place the motorcycle on the sidestand and inspect the front forks. Make sure there is no fork oil present on the fork tube or around the fork seal.

Replace Front Fork Oil

Front fork oil condition and level is associated with front suspension performance and internal component wear. For fork oil replacement procedures and special tools required, see the *Victory Service Manual* or contact an authorized Victory dealer.

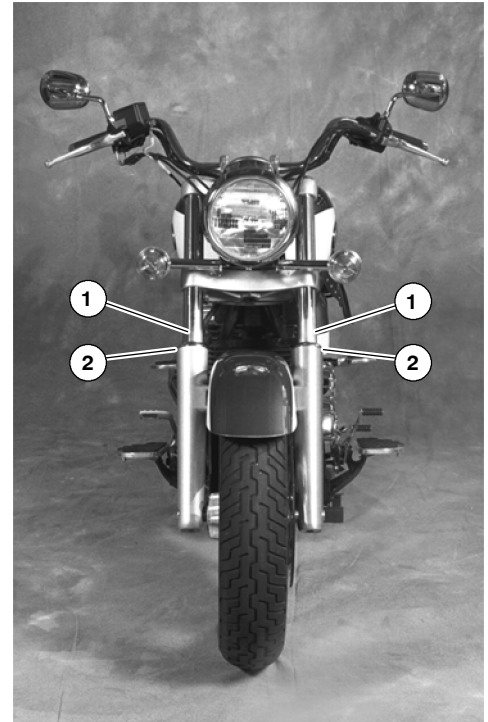

1. Front Fork Tube
2. Fork Seal

Front Suspension and Steering

Inspect Steering and Front Axle

1. Elevate the front of the motorcycle until the front wheel is off of the ground. Use an appropriate motorcycle lift or a block of wood or steel placed securely under the frame.
2. Turn the handlebars from stop to stop. The action should be smooth but not loose or interfered with by wires, hoses, or control cables.
3. Point the front wheel straight ahead. Grasp the front forks near the front axle and attempt to move the front wheel front-to-back.

NOTE: If there is front-to-back movement at the steering head, the steering head bearings should be inspected, lubricated, and adjusted (see the *Victory Service Manual* or an authorized Victory dealer).

Notice The steering head bearings require periodic lubrication even if there is no front-to-back movement at the steering head when checked (see the *Victory Service Manual* or an authorized Victory dealer).

4. Turn the handlebars all the way to the right or left. Grasp the front tire and attempt to move the front wheel side-to-side.

NOTE: If there is movement at the front axle, inspect the wheel bearings and front axle (see the *Victory Service Manual* or an authorized Victory dealer).

5. Slowly rotate the front wheel. If the wheel does not rotate smoothly, inspect the wheel bearings and front axle (see the *Victory Service Manual* or an authorized Victory dealer).

MAINTENANCE

Fuel System

Check Fuel Hose, Rail, and Connections

Inspect the fuel hoses for cracks or damage. Inspect the hose connection at the fuel pump and at the fuel rail for dampness or stains from leaking or dried fuel.

Check Crankcase Ventilation Hose and Connections

Remove the operators seat and fuel tank. Inspect the crankcase ventilation hose for cracks or damage. Inspect the hose connection at the air cleaner and at the crankcase for dampness or stains from leaking.

Evaporative Emission Control System (California models only)

Visually inspect all evaporative emission control system hoses and connections. Make sure all connections are tight. Also, inspect the evaporative canister to make sure it has not been damaged.

Fuel Tank

1. To remove the fuel tank, remove the operator's seat.
2. Remove the front and rear fuel tank mounting screws.
3. Unplug the fuel level sensor and fuel pump wire harness.
4. With engine and exhaust cool, remove fuel rail bleed valve cap. Wrap a clean rag around the valve and relieve the fuel line pressure by depressing the center of the bleed valve.

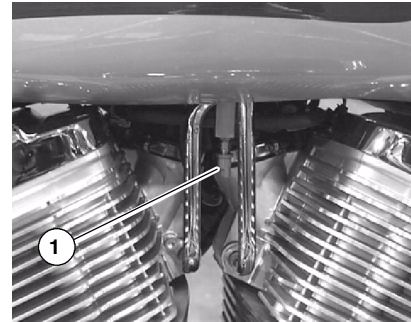

1. Fuel Rail Bleed Valve Cap

Fuel System

Caution

Fuel can damage painted surfaces and plastic parts. Wipe spilled fuel immediately from the motorcycle using a clean, dry, soft cloth.

5. Loosen hose clamp and disconnect the fuel line (1).
6. Disconnect the tank vent line (2).
7. To reinstall the fuel tank, reverse the removal steps, routing fuel line under breather hose.
8. Reinstall the fuel tank mounting screws.

Torque: 20 ft-lbs (27 Nm)

9. Reinstall the seat.

Replace Fuel Filter

The fuel filter is attached to the electric fuel pump located inside the fuel tank. Fuel filter condition is associated with engine performance and fuel economy. For fuel filter replacement procedures and special tools required, see the *Victory Service Manual* or contact an authorized Victory dealer.

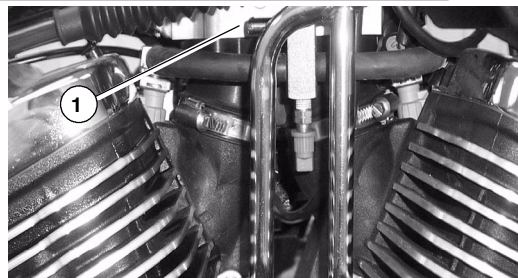

1. Fuel Line 2. Vent Line

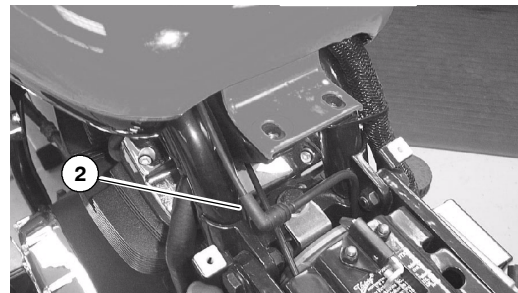

MAINTENANCE

Fast Idle Lever

Check Fast Idle Lever and Cable

1. Move the fast idle lever. It should move smoothly from its rest position to its completely open position and back again
2. Fast idle lever freeplay - the amount of lever movement from the rest position to the point of cable resistance - should be 1/8-1/4 inch (3-6 mm).
3. Adjust fast idle lever freeplay if necessary.

Adjust Fast Idle Lever Freeplay

1. Remove the operator's seat.
2. Remove the fuel tank.
3. Loosen the fast idle cable adjuster jam nut.
4. Turn the cable adjuster in or out until the fast idle lever freeplay is 1/8-1/4 inch (3-6 mm).
5. Tighten the adjuster jam nut and reinstall the fuel tank and operator's seat.

Throttle

Check Throttle Control Grip and Cable

1. Rotate the throttle control grip. It should rotate smoothly from its rest position to its completely open position and back again. It should return to its rest position quickly when released.
2. Throttle freeplay - the amount of throttle control grip movement from the rest position to the point of cable resistance - should be 1/8-1/4 inch (3-6 mm).
3. Adjust throttle freeplay if necessary.

Adjust Throttle Freeplay

1. Slide the rubber covers off both cable adjusters, and loosen both adjuster jam nuts.
2. Turn both cable adjusters into the cable as far as possible.
3. Turn the cable adjuster on the throttle opening cable out until the throttle freeplay is between 1/8-1/4 inch (3-6 mm).
4. Hold the throttle control grip at the fully closed position and turn the cable adjuster on the throttle closing cable out until resistance is felt.
5. Tighten the adjuster jam nuts on both cables, and reinstall both rubber covers.

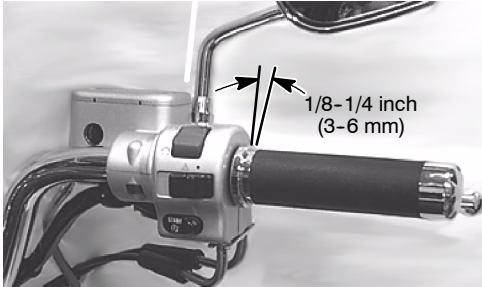

MAINTENANCE

Clutch

Check Clutch Lever and Cable

1. Squeeze the clutch lever toward the handlebar and release it. It should move freely and smoothly and should return to its rest position quickly when released.
2. Clutch freeplay - the amount of clutch lever movement from the rest position to the point of cable resistance - should be between 0.02-0.04 inch (.5-1 mm). Measure the gap between the clutch lever and the lever housing.
3. Adjust clutch freeplay if necessary (see page 118).

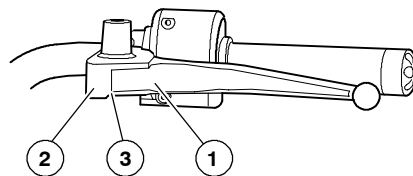

1. Clutch Lever
2. Lever Housing
3. Gap

Clutch

Lubricate Clutch Lever

1. Remove the operator's seat.
2. Remove the front and rear fuel tank screws.
3. Raise the rear of the fuel tank high enough to expose the clutch cable. Support the rear of the fuel tank with a block of wood.
4. Slide the rubber cover off the cable adjuster, and loosen the adjuster jam nut.
5. Turn the cable adjuster all the way in.
6. Remove clutch lever pivot nut and screw.
7. Disconnect the clutch cable from the clutch lever.
8. Remove any old grease and dirt from the clutch lever and lever housing.
9. Lubricate the clutch lever and lever pivot screw with Victory All Purpose Grease or equivalent.
10. Reconnect the clutch cable and reinstall the clutch lever, lever pivot screw, and nut.

Torque: 40 in-lbs (5 Nm)

11. Adjust clutch freeplay.

MAINTENANCE

Clutch

Adjust Clutch Freeplay

1. Remove the operator's seat.
2. Remove the front and rear fuel tank screws.
3. Raise the rear of the fuel tank high enough to expose the clutch cable. Support the rear of the fuel tank with a block of wood.
4. Slide the rubber cover off the cable adjuster, and loosen the adjuster jam nut.
5. Turn the cable adjuster in or out until the clutch freeplay is 0.02-0.04 inch (.5-1.0 mm).
6. Tighten the adjuster jam nut and reinstall the rubber cover.
7. Reinstall and tighten the front and rear fuel tank screws.

Torque: 20 ft-lbs (27 Nm)

8. Reinstall the seat.
9. Verify that the safety switch activates so the motorcycle can not be started in gear.

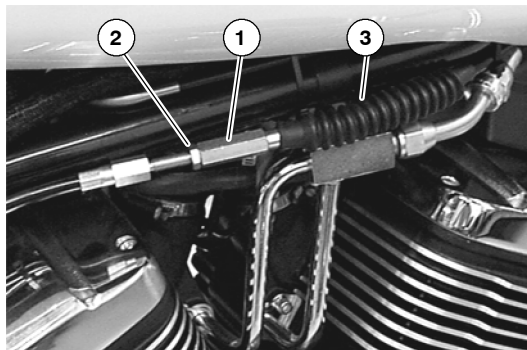

1. Clutch Cable Adjuster
2. Adjuster Jam Nut
3. Rubber Cover

Lubricate Control Cables

The following cables used on the motorcycle require periodic lubrication for smooth operation and longevity:

- Throttle Cables
 - Clutch Cable
 - Fast Idle Lever Cable
 - Seat Release Cable (Classic Cruiser)
1. Loosen the adjuster of the cable to be lubricated, and disconnect one end of the cable.
 2. Lubricate the cable and the inside of the cable housing with Victory Cable Lube (PN 2872861) or a commercially available cable lubricant.
 3. Lubricate the cable end with Victory All Purpose Grease or equivalent.
 4. Reconnect the cable and adjust as necessary.

MAINTENANCE

Brakes

Check Front Brake Lever Movement

Squeeze the front brake lever toward the handlebar and release it. It should move freely and smoothly and should return to its rest position quickly when released. You should feel a firm resistance in the lever within the first 3/4-inch (19 mm) of lever travel.

If the brake lever travels too far before beginning to engage the brake, see the *Victory Service Manual*, or contact an authorized Victory dealer for service.

Lubricate Front Brake Lever

1. Remove brake lever pivot nut and pin.
2. Remove any old grease and dirt from the brake lever and lever housing.
3. Lubricate the brake lever and lever pivot pin with Victory All Purpose Grease or equivalent.
4. Reinstall the brake lever, lever pivot pin, and nut.

Torque: 5 ft-lbs (6 Nm)

5. Check front brake lever movement.

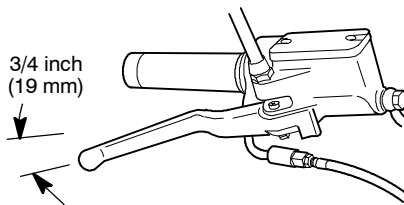

Brakes

Check Front Brake Fluid Level

1. To check the front brake fluid level, rest the motorcycle on the sidestand and on level ground. Turn the handlebars until the front brake fluid reservoir is level.
2. View the brake fluid through the sight glass. The fluid should be clear and at a level in or above the sight glass. Add brake fluid if necessary.

Add Front Brake Fluid

1. Straddle the motorcycle and bring it to a vertical position. Turn the handlebars until the reservoir is horizontal.
2. Wipe the area around the reservoir cover with a clean cloth.
3. Wipe the brake fluid container with a clean cloth.
4. Remove the reservoir cover and gasket.

Caution

Brake fluid attacks painted surfaces and plastic parts. Always clean spilled brake fluid immediately with plenty of water and a mild detergent.

MAINTENANCE

Brakes

WARNING

- Do not operate the front brake while its reservoir cover is removed. Fluid could overflow from the reservoir and cause air to enter the fluid system. Air in the brake fluid system could cause the brakes to malfunction.
 - Use only DOT 4 brake fluid from a sealed, clean container. Using the wrong brake fluid, or allowing contaminants into the brake fluid system, can damage the system seals, resulting in the brakes malfunctioning.
-

5. Carefully add enough brake fluid to bring the level just above the sight glass.
6. Reinstall the reservoir gasket and cover.

Check Rear Brake Pedal Freeplay and Movement

Rear brake pedal freeplay - the amount of brake pedal movement from the rest position to the point of contacting the master cylinder - should be 3/16-5/16 inch (5-8 mm). Adjust pedal freeplay as necessary (see page 123).

Press and release the rear brake pedal. It should move freely and smoothly and should return to its rest position quickly when you release it. You should feel a firm resistance in the pedal within the first 3/4 inch (19 mm) of pedal travel.

If the brake pedal travels too far before beginning to engage the brake, see the *Victory Service Manual*, or contact an authorized Victory dealer for service.



Brakes

Adjust Rear Brake Pedal Freeplay

1. Loosen the brake linkage rod locknuts.
2. Turn the linkage rod in or out as necessary.
3. Tighten the linkage rod locknuts.
4. Check the brake pedal freeplay.

Check Rear Brake Fluid Level

1. To check the rear brake fluid level, remove the right side cover. Straddle the motorcycle and bring it to a vertical position.
2. View the brake fluid through the reservoir. The fluid should be clear and at a level between MIN and MAX. Add brake fluid if necessary.

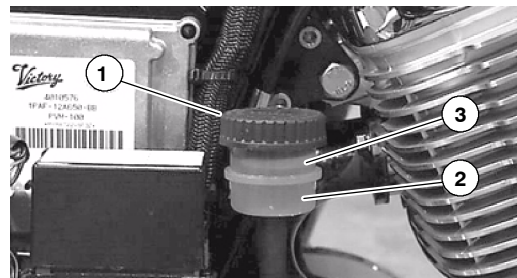

1. Rear Brake Fluid Reservoir
2. MIN Fluid Level
3. MAX Fluid Level

MAINTENANCE

Brakes

Add Rear Brake Fluid

1. Bring the motorcycle to a vertical position with an appropriate motorcycle lift or a block of wood or steel placed securely under the frame.
2. Remove the right side cover.
3. Wipe the area around the reservoir cover with a clean cloth.
4. Wipe the brake fluid container with a clean cloth.
5. Remove the reservoir cover and gasket.

Caution

Brake fluid attacks painted surfaces and plastic parts. Always clean spilled brake fluid immediately with plenty of water and a mild detergent.

WARNING

- **Do not operate the rear brake while its reservoir cover is removed. Fluid could overflow from the reservoir and cause air to enter the fluid system. Air in the brake fluid system could cause the brakes to malfunction.**
 - **Use only DOT 4 brake fluid from a sealed, clean container. Using the wrong brake fluid, or allowing contaminants into the brake fluid system, can damage the system seals, resulting in the brakes malfunctioning.**
-

6. Carefully add enough brake fluid to bring the level between MIN and MAX.
7. Reinstall the reservoir gasket and cover.
8. Reinstall the side cover.

MAINTENANCE

Brakes

Check Brake Pads

Look into the front brake caliper(s) from underneath, and into the rear brake caliper from behind, you should see at least 1/16 inch (1.6 mm) of friction material on each of the brake pads. If in doubt, measure remaining friction material. Replace brake pads having less than the specified amount of friction material at their thinnest point.

If the brake pads require replacement, see the *Victory Service Manual* or an authorized Victory dealer for assistance.

Check Brake Hoses and Connections

Inspect all brake hoses and connections for dampness or stains from leaking or dried fluid. Tighten any leaking connections and replace components as necessary.



1. Front Brake Pad Friction Material

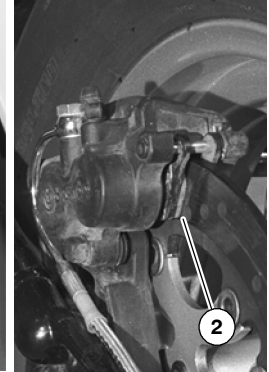

2. Rear Brake Pad Friction Material

Gear Shift Pedal

Adjust Gear Shift Pedal Height

1. Loosen the gear shift linkage rod locknuts.
2. Turn the linkage rod in or out as necessary.
3. Tighten the linkage rod locknuts.
4. Check the gear shift pedal height.

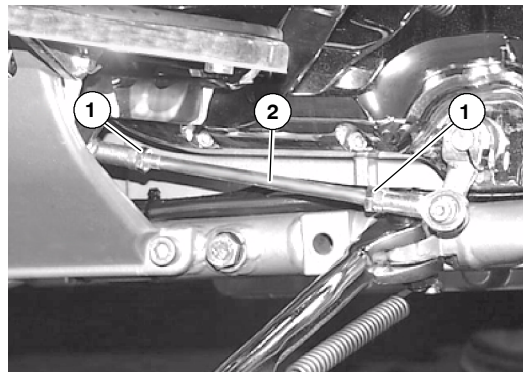

1. Gear Shift Linkage Rod Locknut
2. Linkage Rod

Caution

Do not remove and reposition the shift arm on the shift shaft to adjust gear shift pedal height. A $90^{\circ} \pm 5^{\circ}$ angle between the shift arm and the linkage rod must be maintained to ensure correct shift linkage operation.

MAINTENANCE

Tires

Check Tire Pressure

Normal riding warms the tires and increases the tire air pressure. For an accurate reading, check the tire pressure before you ride. Adjust tire pressure as required for the total weight of your intended load.

Tire Pressure Table

Classic Cruiser		
	Up to 200 lbs (91 kg) load	200-475 lbs (91-215 kg) load
FRONT: Dunlop 491 Elite II - MT90 B16 71H	34 psi (235 kpa)	40 psi (275 kpa)
REAR: Dunlop D417 - 160/80 B16 75H	36 psi (250 kpa)	41 psi (280 kpa)
Touring Cruiser		
	Up to 200 lbs (91 kg) load	200-449 lbs (91-204 kg) load
FRONT: Dunlop 491 Elite II - MT90 B16 71H	34 psi (235 kpa)	40 psi (275 kpa)
REAR: Dunlop D417 - 160/80 B16 75H	36 psi (250 kpa)	41 psi (280 kpa)
CRUISEMAX Tires (U.S. and U.K. only)		
	Up to 200 lbs (91 kg) load	200-475 lbs (91-215 kg) load
FRONT: Dunlop CRUISEMAX 130/90 16 67H	34 psi (235 kpa)	41 psi (280 kpa)
REAR: Dunlop CRUISEMAX 150/80 B16 71H	36 psi (250 kpa)	41 psi (280 kpa)

Tires

Check Tire Condition

Inspect the tire sidewalls, road contact surface, and tread base for cuts, punctures, and cracking. Replace damaged tires immediately (see your *Victory Service Manual* or an authorized Victory dealer).

Check Tread Depth

Raised areas at the base of the tread, known as wear bars; act as easily visible tread depth indicators. When the road contact surface has worn to the top of the wear bars, replace the tire.

For more precise measurement, use a depth gauge or an accurate ruler to measure the depth of the center tire tread. Replace the tire if the tread depth is less than 1/16 inch (1.6 mm).

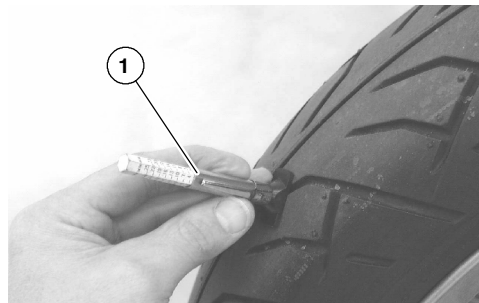

1. Tread Depth Gauge

MAINTENANCE

Check Wheel Spokes

If your motorcycle is equipped with spokes, inspect both wheels for loose, bent, broken or missing spokes. To identify loose spokes, grasp each spoke and try to move it side to side or up and down. All spokes should be equally tight and have the same amount of flex. Tighten loose spokes or replace bent, broken or missing spokes (see an authorized Victory dealer).

WARNING

Spokes adjusted or replaced improperly could distort the wheel, make the motorcycle difficult to handle, and cause loss of control.



Inspect Wheel Spokes

Check or Replace Spark Plugs

The spark plugs must be removed from the engine to inspect them. Spark plugs with bright white deposits, sooty black deposits, or with damaged insulators or electrodes can indicate engine problems. If these conditions exist, or if the condition of one plug is markedly different from the other, see the *Victory Service Manual* or an authorized Victory dealer for assistance.

1. Make sure the engine is at room temperature.
2. Disconnect the spark plug wire by pulling upward on the spark plug boot.
3. To prevent any debris from entering the engine through the spark plug hole, use pressurized air to blow clean the area around each spark plug before removing it.

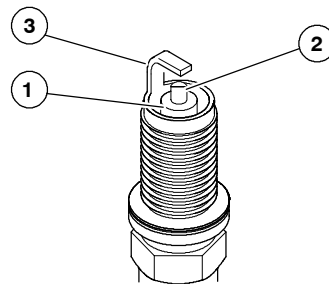

1. Insulator
2. Electrode Tip
3. Electrode Bridge

WARNING

Wear face protection when using pressurized air.

MAINTENANCE

Check or Replace Spark Plugs

4. Remove the spark plug from the cylinder head with a 5/8 inch spark plug socket.

Both spark plugs should have the same light or medium tan color deposits on the insulator around the electrode tip. The spark plug electrode tip and bridge should have sharp, square edges.

If spark plugs are in good condition and are not due for replacement, you can clean them with a non-metallic stiff bristle brush, set the gap and reinstall them.

Replace spark plugs (NGK CR7EB or equivalent) at the recommended intervals. Always replace spark plugs in pairs.

5. Set the electrode gap with a spark plug gauge.

Gap: 0.032 inch (0.8 mm)

6. Clean the mating surface on the cylinder head and install the spark plug with a spark plug socket.

Torque: 8 ft-lbs (11 Nm)

7. Reconnect both spark plug wires.

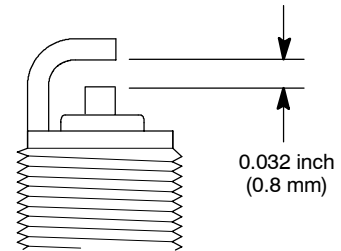

Check Engine Compression

An accurate periodic engine compression check documents engine wear and condition. For engine compression check procedures and special tools required, see the *Victory Service Manual* or contact an authorized Victory dealer.

Check Exhaust System

Check the exhaust system for stains from leaking exhaust gasses. Replace exhaust gaskets if necessary (see the *Victory Service Manual* or an authorized Victory dealer). Check all exhaust system fasteners.

1. Tighten exhaust header flange nuts.

Torque: 12 ft-lbs (16 Nm)

2. Tighten muffler clamps.

Torque: 45 ft-lbs (61 Nm)

3. Tighten muffler mounting screws.

Torque: 18 ft-lbs (24 Nm)

4. Tighten muffler bracket screws.

Torque: 18 ft-lbs (24 Nm)

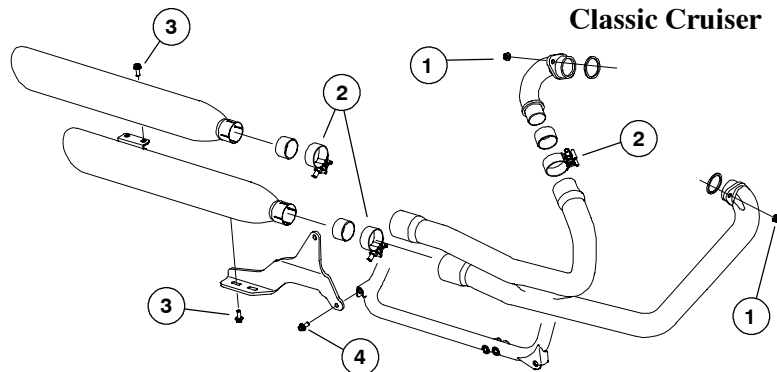

1. Header Flange Nut

2. Muffler Clamp

3. Muffler Mounting Screw

4. Muffler Bracket Screw

MAINTENANCE

Check Exhaust System

Check the exhaust system for stains from leaking exhaust gasses. Replace exhaust gaskets if necessary (see the *Victory Service Manual* or an authorized Victory dealer). Check all exhaust system fasteners.

1. Tighten exhaust header flange nuts.

Torque: 12 ft-lbs (16 Nm)

2. Tighten muffler clamps.

Torque: 45 ft-lbs (61 Nm)

3. Tighten muffler mounting screws.

Torque: 18 ft-lbs (24 Nm)

4. Tighten rear muffler bracket screws.

Torque: 18 ft-lbs (24 Nm)

5. Check Exhaust System (Touring Cruiser)

Touring Cruiser

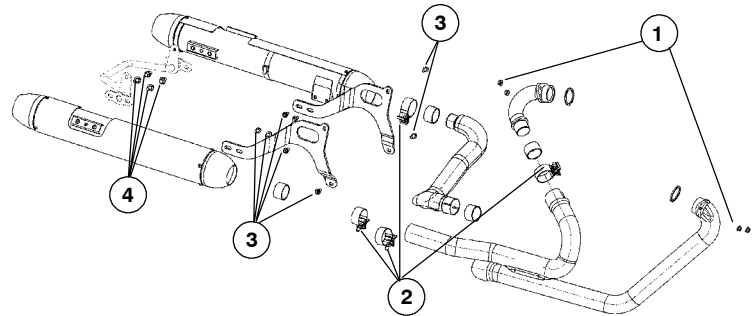

1. Header Flange Nut
2. Muffler Clamp

3. Muffler Brackets
4. Rear Muffler Brackets

Seat Removal and Installation

The Classic Cruiser has two separate seats, the operator's seat and the passenger's seat. The Touring Cruiser has a combined operator and passenger seat.

⚠ WARNING

Always make sure the seats are securely locked before riding the motorcycle. An unlocked seat could cause a sudden shift in riding position, causing loss of control.

Classic Cruiser

1. Insert the ignition key into the ignition switch/seat release and turn the key counterclockwise.
2. Lift the front of the seat and slide the seat forward and off of the motorcycle.
3. The passenger's seat mounting screws are located at the front of the seat. Removing the passenger seat is unnecessary for regular maintenance.
4. To reinstall the operator's seat, slide the tongue of the seat into the passenger's seat base. Push down on the front of the operator's seat until it locks.



Touring Cruiser

1. Remove the acorn nut from behind the seat.
2. Lift rear of seat slightly to clear the rear mounting stud, then push rear of seat forward to clear backrest.
3. Move rear of seat to left carefully until clear of backrest.
4. Pull seat rearward and to the left to disengage front tab and remove.
5. To reinstall the seat, slide it forward and into position on the motorcycle. Make sure the front seat mount is engaged. Lower the seat onto the rear mounting stud and reinstall the acorn nut.

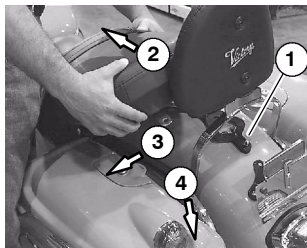

MAINTENANCE

Battery

WARNING

The battery contains sulfuric acid, which can cause severe burns. Do not allow sulfuric acid to contact skin, eyes, or clothing.

Antidotes:

- **External: Flush with water.**
 - **Internal: Drink large quantities of water or milk. Follow with milk of magnesia, beaten eggs, or vegetable oil. Call physician immediately.**
 - **Eyes: Flush with water for 15 minutes and get prompt medical attention.**
-

The motorcycle uses a permanently sealed, maintenance-free battery. Do not remove the battery cap strip for any reason. Keep the battery connections clean and tight at all times.

Notice If your Victory motorcycle will not be used for a period of 6 weeks or longer, a maintenance charger should be connected to the battery. A fused maintenance charger connection is provided beneath the left side cover. The connector is designed for use with the Victory Maintenance Charger available at your authorized Victory dealer.

Battery

Battery Removal

1. Remove the left side cover and remove the battery hold-down strap.
2. Disconnect the negative (-) battery cables (cable ends are exposed).
3. Disconnect the positive (+) cables (cable ends are covered with a red boot).

Caution

Disconnecting the positive cable first can produce an electric shock that could result in damage or injury.

4. Slide the battery out.

Notice The multi-function display (MFD) clock will not function if the battery voltage drops below 11.5 volts. The clock will reset to 12:00 if the battery is disconnected.

MAINTENANCE

Battery

Battery Charging

WARNING

The battery may contain explosive gases.

- **Keep sparks, cigarettes, or any flame away from the battery.**
 - **Shield eyes and protect skin and clothing when handling or working near the battery.**
 - **Make sure ventilation is adequate when charging or using the battery in an enclosed space.**
 - **During charging, if the battery gets very hot to the touch, stop charging and let the battery cool down before continuing.**
-

1. Clean oxidation from the battery posts and cable connectors with a wire brush. Wash the posts and cable connectors with a solution of 1 part baking soda to 16 parts water. Rinse with clean water and wipe dry. Apply a thin film of dielectric grease to the posts and cable connectors.
2. Following the charger manufacturer's instructions, use a battery charger designed for use with 12 volt batteries. The charger should have a maximum charging rate of 1.8 amps. Charge the battery for approximately 10 hours at a rate of 1.8 amps. If you use a taper or trickle charger, it will take longer to charge the battery.
3. After charging the battery, use a voltmeter to check the condition of the battery. Allow battery to sit 1-2 hours before checking the charge. The charge should be a minimum of 12.5 volts. Repeat the charging cycle if the charge is less than the minimum. Replace the battery if it fails to reach a 12.5 volt charge after 2 complete charging cycles.

Battery

Battery Installation

1. Before installing the battery, make sure it is fully charged and clean.
2. Slide the battery into position in the battery tray.
3. Connect the positive (+) battery cables, tighten securely and install the red boot).
4. Connect the negative (-) cables, tighten securely. Be sure cables have adequate side cover clearance.

Caution

- Connecting the negative cable first can produce an electric shock that could result in damage or injury.
 - Connecting the battery cables to the wrong terminals can severely damage the electrical system.
-
5. Reinstall the battery hold-down strap.
 6. Reinstall the left side cover.

MAINTENANCE

Fuses

Caution

Use only recommended amperage fuses or you can damage the electrical system.

1. Remove the seat and the right side cover.
2. Release the tabs on each side of the fuse box cover, and remove the cover.
3. Remove the damaged fuse from the fuse box and seat the new fuse firmly in its place.
4. Reinstall the fuse box cover with the double cutout toward the front of the motorcycle. The fuse box decal should be readable from the right side of the motorcycle.
5. Reinstall the side cover and the operator's seat.

Fuse Application	Fuse Size
Ignition/Coil	15 amp
Horn/Brake/Headlamp	20 amp
Flashers	15 amp
Powertrain Control Module (PCM)	20 amp
Fuel Pump	10 amp

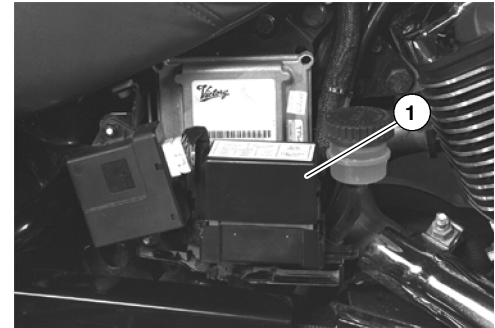

1. Fuse Box

Headlamp Adjustment

The headlamp should shine straight ahead of the motorcycle. The top of the headlamp High beam should be just below the center of the lamp at a distance of 25 feet (7.62 m).

1. Check and adjust the tire pressure.
2. Verify suspension sag is 19-32mm (see page 107) before adjusting headlight.
3. Straddle the motorcycle in an upright position and sit in the operator's seat.
4. Set the ignition switch to the ON position and set the headlamp to High beam. Check the headlamp for correct aim.
5. To adjust the headlamp, remove the headlamp bezel to expose the adjusting screws. Turn the desired adjusting screw clockwise one revolution, and turn the screw directly across the headlamp counterclockwise one revolution. Repeat if necessary, one revolution at a time.
6. Reinstall the headlamp bezel.

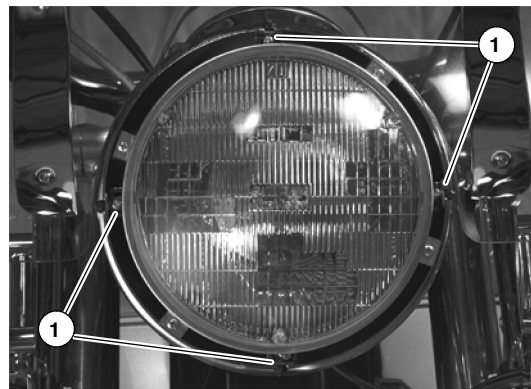
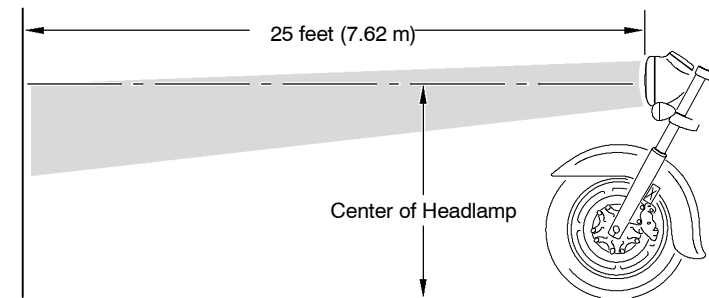

1. Headlamp Adjusting Screws (Bezel Removed)

MAINTENANCE

Auxiliary Lights Adjustment (Touring Models)

Each lamp should shine straight ahead or slightly to the right of the motorcycle. The top of each lamp beam should be just below the center of the lamp at a distance of 25 feet (7.62 m).

1. Check and adjust the tire pressure and rear shock absorber (see page 107).
2. Straddle the motorcycle in an upright position and sit in the operator's seat.
3. Set the ignition switch to the ON position and turn the auxiliary lights on. Check the auxiliary lights for correct aim.
4. To adjust the lights, remove the front running light/turn signal bracket to expose the auxiliary light nut. Loosen the nut and adjust the auxiliary light.
5. Tighten the auxiliary light nut and recheck the light for correct aim.
6. Reinstall the front running light/turn signal bracket.

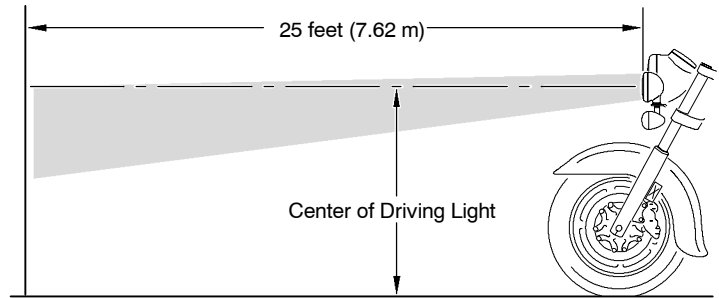

1. Running Light/Turn Signal Bracket

Saddlebag Removal and Installation

Leather Saddlebags

1. Remove the screws, washers, and spacers from inside the saddlebag, and remove the saddlebag from the motorcycle.
2. To reinstall the saddlebag, return all spacers and fasteners to their original location and tighten.

Torque: 12 ft-lbs (17 Nm)

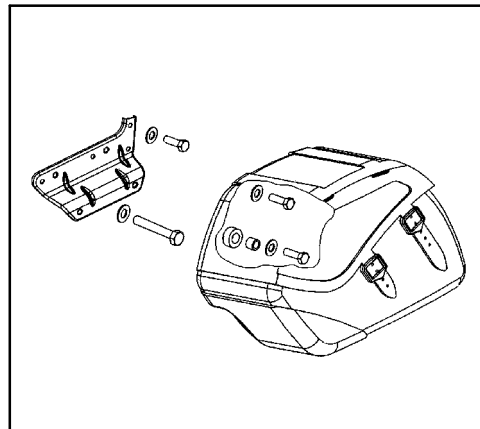

1. Mounting Bolts (Leather Bags)

MAINTENANCE

Saddlebag Removal and Installation

Hard Saddlebags

1. Remove the two (2) upper saddlebag mounting screws located inside the saddlebag.
2. Pull trim straight outward to expose wiring harness connector.
3. Disconnect the wiring harness connector.
4. Disengage bracket on bottom of bag from muffler bracket and remove bag.
5. To reinstall the saddlebag, engage bottom of bag into bracket on muffler. Reconnect the wire harness and trim, and install all spacers and fasteners in their original location.

Torque: 18 ft-lbs (25 Nm)



2. Remove Trim



3. Disconnect Wire Harness

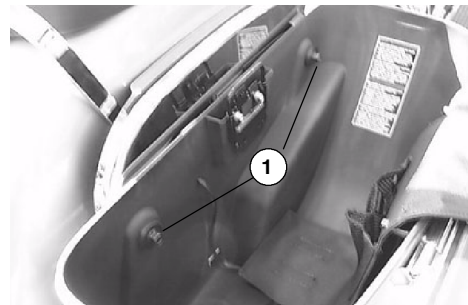

1. Upper Mounting Bolts

Sidestand

Straddle the motorcycle and bring it to a vertical position. Move the sidestand to its stored (up) position, then to its fully extended (down) position, and back again. It should move smoothly and quietly. When the sidestand is in its stored position, the sidestand return spring should hold the sidestand tightly against the motorcycle.

If the sidestand is bent, it should be replaced immediately.

Caution

Do not try to straighten a bent sidestand. The sidestand will be weakened, and may not be able to support the motorcycle.

Inspect Sidestand Pad

1. Check the condition of the sidestand rubber pad, and make sure it is firmly attached to the sidestand.
2. Inspect the sidestand rubber pad for wear. Replace the rubber pad if it is worn above the wear limit (see the *Victory Service Manual* or an authorized Victory dealer).

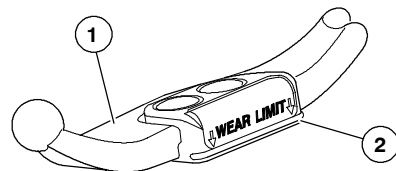

1. Sidestand
2. Rubber Pad

MAINTENANCE

Sidestand

Sidestand Lubrication

1. Bring the motorcycle to a vertical position with an appropriate motorcycle lift or a block of wood or steel placed securely under the frame.
2. Move the sidestand to its stored (up) position and remove the sidestand return spring.

WARNING

Wear face protection. The sidestand return spring is under tension and can injure your eyes and face when released.

3. Remove the sidestand pivot bolt.
4. Remove any old grease and dirt from the sidestand, frame, and pivot bolt.
5. Lubricate the sidestand and pivot bolt with Victory All Purpose Grease or equivalent.
6. Reinstall the sidestand pivot bolt.

Torque: 35 ft-lbs (47 Nm)

7. Move the sidestand to its stored (up) position and reinstall the sidestand return spring.

Check Fasteners

Visually inspect the entire motorcycle chassis and engine for loose, damaged, or missing fasteners. Tighten loose fasteners to the proper torque (see the Specifications section of the *Owner's Manual*, or the *Victory Service Manual*). Replace stripped, damaged, or broken fasteners with genuine Victory fasteners of equal size and strength immediately.

Road Test

Before returning the motorcycle to regular use, road test it in a safe environment. Pay special attention to the proper fit and operation of all serviced components. Make any corrections or additional adjustments as necessary to ensure safe and enjoyable vehicle performance.

WARNING

Improperly installed or adjusted components can make the motorcycle unstable or hard to handle. Improperly installed electrical components can cause engine or electrical system failure. In either case, damage or serious injury could result.

CLEANING

This section explains how to properly clean the various parts of your Victory motorcycle to keep it in good working order and appearance.

General Cleaning

Clean your motorcycle regularly to protect it from corrosion and to keep it looking new. As you clean your motorcycle you perform a complete and thorough visual inspection that may reveal components in need of repair.

Clean the motorcycle if it is dusty or muddy, or if it has picked up foreign material such as road salt, insects, oil, tar, or tree sap. If you ride in an area with salty or polluted air, wash your motorcycle frequently. Proper cleaning requires washing and drying the motorcycle, and then applying wax, polish, and protectants to extend the service life and appearance of various components.

During cleaning you might use products that are potentially hazardous, such as polishing compounds. When using any of these products, follow the instructions and warnings on the product packaging.

Some foreign materials like insects, oil, tar, and tree sap can damage the motorcycle's fit and finish, and you should remove these materials as soon as possible. If normal washing does not remove these materials, you may need to use a special cleaner. Choose a cleaner designed for use on the type of surface you need to clean.

Washing and Drying the Motorcycle

Before washing the motorcycle, make sure the exhaust pipes are not hot. Cover each exhaust pipe opening with a plastic bag and attach the bag to the pipe with a strong rubber band. To prevent contamination from water, check that the spark plugs, spark plug wire caps, oil fill cap, and fuel caps are properly seated.

1. Park the motorcycle in the shade to prevent water spotting.
2. The engine cases are painted. If you choose to use a degreaser, follow the degreaser manufacturer's instructions.
3. Rinse off as much dirt and mud as possible with water running at low pressure.

Caution

- Don't use high water pressure or high-pressure sprayers such as those found at car washes. Excessive water pressure may allow water to seep in and deteriorate wheel bearings, brake caliper assemblies, brake master cylinders, electrical connectors, steering head bearings, and transmission seals.
 - Electrical components may be damaged by contact with water. Do not spray or allow water to come into contact with electrical components or connectors.
-
4. Wash the entire motorcycle using a soft cloth or sponge soaked in a solution of mild detergent and warm water, applying minimal pressure as you wash. Let the detergent do the cleaning, not the pressure you apply. Excessive washing pressure may cause dirt, sand, or other foreign materials on the motorcycle to scratch the finish. Keep the cloth or sponge clean by rinsing it frequently, and soak it in the detergent and water solution to provide plenty of soapy water for washing. A toothbrush or bottle brush can help you wash places that are difficult to reach with a cloth or a sponge.

CLEANING

Washing and Drying the Motorcycle

Caution

Use as little water as possible when washing near the air cleaner or the exhaust pipe openings. An excessively wet air cleaner, or water in the exhaust pipes, may cause the engine to start and run poorly. Dry these components thoroughly before using the motorcycle.

5. Clean the front fork tubes thoroughly to reduce fork seal wear and leakage.
6. If insects, oil, tar, tree sap, or other foreign material is difficult to remove by applying gentle pressure using the warm water and mild detergent mixture, you may need to use a special cleaner. Choose a cleaner designed for use on the type of surface you plan to clean.
7. Rinse the motorcycle with water running at low pressure.
8. Remove the rubber bands and plastic bags from the exhaust pipes, and wipe the motorcycle dry with a soft cloth or chamois.
9. After washing the motorcycle, start the engine and let it idle for a few minutes. Make sure the brakes are functioning properly before riding.

WARNING

Excessively wet brake pads or discs may diminish braking effectiveness. Dry these components thoroughly before using the motorcycle.

Waxing, Polishing and Applying Protectants

(Items Other Than Windshields and Leather Saddlebags)

After washing and drying the motorcycle, you can help extend the life and appearance of its components by waxing painted surfaces, polishing chrome surfaces, and applying a protectant to exposed rubber, vinyl, and plastic parts. Avoid cleaning-waxing compounds, as they may contain abrasives that may damage the finish of painted parts. For chrome surfaces, use either a window-cleaning solution or a polish specifically designed for chrome. Follow manufacturer's instructions for proper application and use of wax, polish, or protectants.

After washing and drying the motorcycle, to help extend the life and appearance of its components:

- Wax painted surfaces. Avoid cleaning-waxing compounds, as they may contain abrasives that may damage the finish of painted surfaces.
- Polish chrome surfaces. Use either a window-cleaning solution or a polish specifically designed for chrome.
- Apply a protectant to exposed rubber, vinyl, and plastic components.

WARNING

- **Do not use a protectant on the seats, footboard inserts, or handgrips that leaves a slippery coating after it dries. If these surfaces are slippery, you may have difficulty holding your position on the motorcycle while riding, which may cause loss of control.**
 - **Follow manufacturer's instructions and safety precautions on wax, polish, and protectant labels to prevent injury or damage.**
-

CLEANING

Windshield Care

A windshield is included with some Victory models.

Wash the windshield using a soft cloth or sponge soaked in a solution of mild detergent and warm water, applying minimal pressure as you wash. Let the detergent do the cleaning, not the pressure you apply. Excessive washing pressure may cause dirt, sand, or other foreign materials on the windshield to scratch it. Soak the cloth or sponge in the detergent and water solution frequently to provide plenty of soapy water for washing, and keep the cloth or sponge clean by rinsing it frequently.

- Minor scratches may be removed with a quality plastic polishing compound. Follow the manufacturer's instructions when using plastic polishing compounds.
- Insects, oil, tar, and tree sap may also damage the motorcycle's finish. If normal washing does not remove these materials, you may need to use a special cleaner. Choose a cleaner designed for use on clear plastic and follow the manufacturer's instructions when using special cleaners.

Caution

Do not use glass cleaners, water or soil repellents, or alcohol based cleaners as these products can damage the windshield.

Leather Saddlebag Care

Leather saddlebags are included with some Victory models.

Natural leather has “character.” Each piece used in the construction of these saddlebags is unique, and will settle into its own distinct form over time and miles. Mature leather is one-of-a-kind, and if properly cared for, gets better with age.

Caring for natural leather is similar to caring for your own skin. To prevent leather from becoming hard and dry, occasionally apply a leather conditioner. A good quality leather conditioner replaces the natural oils lost by repeated exposure to sun, wind and rain. Leather subject to drier climates will require more frequent conditioning.

To retain the beauty and character of your leather saddlebags, please follow these steps.

1. Vacuum or blow any loose dust or dirt from the saddlebag.
2. Use a good quality saddle soap and a sponge or soft cloth to clean the saddlebag. Always follow the manufacturer’s directions. Rinse the saddlebag with a clean wet cloth or sponge.
3. Once the leather is dry, treat it with a good quality leather conditioner. Always follow the manufacturer’s directions.
4. Allow the conditioner to dry, and wipe off any excess before using the saddlebag.

Repairing Painted Surface Damage

After cleaning the motorcycle, inspect it for damage to the painted surfaces. If you discover chips or scratches in the paint, apply genuine Victory touch-up paint as soon as possible to prevent corrosion.

STORAGE

If you will not operate the motorcycle for several months, such as during the winter, store the motorcycle to prevent damage to the fuel system and the battery and to protect components from corrosion or deterioration. During storage you might use products that are potentially hazardous; such as fuel stabilizer. When using any of these products, follow the instructions and warnings on the product packaging.

This section includes instructions for preparing the motorcycle for storage, maintaining it during storage and removing it from storage.

Storage Area Preparation

Choose a dry, well-ventilated storage location, inside a garage or other structure if possible. The location should have a firm, flat surface and allow enough space for the motorcycle.

To best preserve tire condition:

- The storage area should have a relatively constant and moderate temperature.
- The motorcycle should not be near a radiator or other heat source, or any type of electric motor.
- The storage surface should be free of oil and gasoline.

Clean and Protect the Motorcycle

To prepare the motorcycle for storage, begin by cleaning it as outlined beginning on page 148. Wax painted surfaces and polish chromed surfaces. Apply protectant to exposed rubber, vinyl, and plastic parts.

Caution

Do not apply rubber protectant to the tire tread surfaces.

Fuel Stabilizer

1. Using a mixture of fuel and the recommended amount of Victory Premium Carbon Clean Plus or other gasoline stabilizer, fill the fuel tank only to the top of the filler insert.
2. Start and run the engine for 15 minutes in a well ventilated area to pass the stabilized fuel through entire fuel-injection system.

Engine Component Protection

1. Change the engine oil (see page 97). You don't need to replace the oil filter at this time, but you must replace the oil filter when you remove the motorcycle from storage.

Caution

Carbon deposits, normally suspended in engine oil that is in service, settle on internal engine components during storage. Settled carbon deposits can cause engine damage.

2. Using pressurized air, blow any debris from the area around each spark plug.

WARNING

Wear face protection when using pressurized air.

3. Remove the spark plugs (see page 131). Pour one tablespoon of clean motor oil into each spark plug hole.
4. Connect the spark plugs to the spark plug wires and ground the spark plugs to the engine. With the main switch in the ON position, the stop/run switch set to RUN, and the transmission in neutral, press the electric starter button to crank the engine a few times. This procedure inhibits corrosion by coating the cylinder walls with the oil you poured in the spark plug holes.
5. Set the main switch to the OFF position and reinstall the spark plugs.

STORAGE

Tire Inflation

Inflate the tires to normal pressure.

Battery Care

1. Remove the battery (see “Remove Battery” page 137).
2. To clean oxidation from the battery posts and cable connectors, use a wire brush. Wash the posts and cable connectors with a solution of 1 part baking soda to 16 parts water. Rinse with clean water and wipe dry. Apply a thin film of dielectric grease (available from your Victory dealer) to the posts and cable connectors.
3. Clean the outside of the battery with a solution of mild detergent and warm water.
4. Store the battery in a dry location that maintains a temperature of 32° to 90°F (0° to 32°C).
5. While in storage, fully charge the battery once a month (see “Charge Battery” page 138).

Park and Cover the Motorcycle

Park the motorcycle in its storage location and lock the steering. Cover the motorcycle with a genuine Victory motorcycle cover, or a cover made from a durable, breathable material designed for storage. Covering the motorcycle helps protect it from dust and other airborne materials. The cover must be of a breathable material to prevent moisture from building up on the motorcycle.

Maintenance During Storage

Check and maintain normal tire pressure and battery voltage during storage.

Removal from Storage

1. Remove the cover and unlock the front forks.
2. Check the tire pressure and inflate the tires if necessary.
3. Reinstall the battery (see page 139).
4. Wash and dry the entire motorcycle (see page 149).
5. Prior to starting the engine, change the engine oil and filter (see page 97, beginning with step 2).

Caution

During storage, temperature and humidity changes can cause condensation to form in the crankcase and mix with engine oil. Running the engine with oil that contains condensation can cause engine damage.

6. Wax, polish or apply protectant to the appropriate motorcycle components (see page 151).
7. Perform the pre-operation check as outlined on page 64.
8. Road test the motorcycle before returning it to regular use (see page 147).

WARRANTIES

Motorcycle Noise Regulation

Tampering with noise control systems is prohibited. Federal law prohibits the following acts or causing thereof:

- The removal or rendering inoperative by any person other than for purposes of maintenance, repair, or replacement, of any device or element of design incorporated into any new vehicle for the purpose of noise control prior to its sale or delivery to the ultimate purchaser or while it is in use, or
- The use of the vehicle after such device or element of design has been removed or rendered inoperative by any person.

Among those acts presumed to constitute tampering are:

- Removal or puncturing of the muffler, baffles, header pipes or any other component which conducts exhaust gases.
- Removal or puncturing of any part of the intake system.
- Lack of proper maintenance.
- Replacing any moving part of the vehicle, or parts of the exhaust or intake system, with parts other than those specified by the manufacturer.

This product should be checked for repair or replacement if the motorcycle noise has increased significantly through use. Otherwise, the owner may become subject to penalties under state and local ordinances.

Noise Emission Warranty

Victory Motorcycle Division warrants that this exhaust system, at the time of sale, meets all applicable U.S. EPA Federal noise standards. This warranty extends to the first person who buys this exhaust system for purposes other than resale, and to all subsequent buyers. Warranty claims should be directed to: an authorized Victory dealer or Victory Motorcycle Division, Polaris Sales Inc., P.O. Box 47700, Hamel, MN 55340-9960

Emissions Control System Warranty

Victory Motorcycles, Polaris Sales Inc. - Emission Control System Warranty Statement

Your Warranty Rights and Obligations

The California Air Resources Board and Victory Motorcycle Division, Polaris Sales Inc. (hereinafter Victory) are pleased to explain the emission control system warranty on your 2003 or later Victory motorcycle. In California, new motor vehicles must be designed, built and equipped to meet the state's stringent anti-smog standards. Victory must warrant the emission control system on your motorcycle for the periods of time listed below provided there has been no abuse, neglect or improper maintenance of your motorcycle.

Your emission control system may include parts such as the fuel-injection system, the ignition system, catalytic converter and engine computer. Also included may be hoses, belts, connectors and other emission-related assemblies.

Where a warrantable condition exists, Victory will repair your motorcycle at no cost to you, including diagnosis, parts and labor.

Manufacturer's Warranty Coverage

Class III motorcycles (280 cc and larger): for a period of use of five (5) years or 30,000 kilometers (18,641 miles), whichever first occurs.

If an emission-related part on your motorcycle is defective, the part will be repaired or replaced by Victory. This is your emission control system DEFECTS WARRANTY.

WARRANTIES

Owner's Warranty Responsibilities

As the motorcycle owner, you are responsible for the performance of the required maintenance listed in your owner's manual. Victory recommends that you retain all receipts covering maintenance on your motorcycle, but Victory cannot deny warranty solely for the lack of receipts or for your failure to ensure the performance of all scheduled maintenance.

You are responsible for presenting your motorcycle to a Victory dealer as soon as a problem exists. The warranty repairs should be completed in a reasonable amount of time, not to exceed 30 days.

As the motorcycle owner, you should be aware that Victory may deny your warranty coverage if your motorcycle or part has failed due to abuse, neglect, improper maintenance or unapproved modifications.

If you have any questions regarding your warranty rights and responsibilities, you should contact Victory Motorcycle Division, Polaris Sales Inc., P.O. Box 47700, Hamel, Minnesota 55340-9960, or the California Air Resources Board, P.O. Box 8001, 9528 Telstar Avenue, El Monte, CA 91734-8001.

Victory Motorcycle Division, Polaris Sales Inc. - Limited Warranty on Emission Control System

Victory Motorcycle Division, Polaris Sales Inc., (hereinafter Victory) warrants that each new 2003 and later Victory Motorcycle that includes as standard equipment a headlight, taillight and stoplight, and is street legal:

- A. is designed, built and equipped so as to conform at the time of initial retail purchases with all applicable regulations of the United States Environmental Protection Agency, and the California Air Resources Board; and
- B. is free from defects in material and workmanship which cause such motorcycle to fail to conform with applicable regulations of the United States Environmental Protection Agency or the California Air Resources Board for a period of use, depending on the engine displacement, of 12,000 kilometers (7,456 miles), if the motorcycle's engine displacement is less than 170 cubic centimeters; of 18,000 kilometers (11,185 miles), if the motorcycle's engine displacement is equal or greater than 170 cubic centimeters but less than 280 cubic centimeters; or of 30,000 kilometers (18,641 miles), if the motorcycle's engine displacement is 280 cubic centimeters or greater; or 5 (five) years from the date of initial retail delivery, whichever occurs first.

WARRANTIES

I. Coverage

Warranty defects shall be remedied during customary business hours at any authorized Victory motorcycle dealer located within the United States of America in compliance with the Clean Air Act and applicable regulations of the United States Environmental Protection Agency and the California Air Resources Board. Any part or parts replaced under this warranty shall become the property of Victory.

In the State of California only, emission related warranted parts are specifically defined by the state's Emission Warranty Parts List. These warranted parts are: carburetor and internal parts; intake manifold; fuel tank; fuel injection system; spark advance mechanism; crankcase breather; air cutoff valves; fuel tank cap for evaporative emission controlled vehicles; oil filler cap; pressure control valve; fuel/vapor separator; canister; igniters; breaker governors; ignition coils; ignition wires; ignition points; condensers, and spark plugs if failure occurs prior to the first scheduled replacement; and hoses, clamps, fittings and tubing used directly in these parts. Since emission related parts may vary from model to model, certain models may not contain all of these parts and certain models may contain functionally equivalent parts.

In the State of California only, Emission Control System emergency repairs, as provided for in the California Administrative Code, may be performed by other than an authorized Victory dealer. An emergency situation occurs when an authorized Victory dealers is not reasonably available, a part is not available within 30 days, or a repair is not complete within 30 days. Any replacement part can be used in an emergency repair. Victory will reimburse the owner for expenses, including diagnosis, not to exceed Victory's suggested retail price for all warranted parts replaced and labor charges based on Victory's recommended time allowance for the warranty repair and the geographically appropriate hourly labor rate. The owner may be required to keep receipts and failed parts in order to receive compensation.

WARRANTIES

II. Limitations

This Emission Control System warranty shall not cover any of the following:

- A. Repair or replacement required as a result of:
 - (1) accident
 - (2) misuse
 - (3) repairs improperly performed or replacements improperly installed
 - (4) use of replacement parts or accessories not conforming to Victory specifications which adversely affect performance and/or
 - (5) use in competitive racing or related events.
- B. Inspections, replacement of parts, and other services and adjustments necessary for required maintenance
- C. Any motorcycle on which the odometer mileage has been changed so that actual mileage cannot be readily determined.

III. Limited Liability

A. The liability of Victory under this Emission Control System Warranty is limited solely to the remedying of defects in material or workmanship by an authorized Victory motorcycle dealer at its place of business during customary business hours. This warranty does not cover inconvenience or loss of use of the motorcycle or transportation of the motorcycle to or from the Victory dealer. VICTORY SHALL NOT BE LIABLE FOR ANY OTHER EXPENSES, LOSS OR DAMAGE, WHETHER DIRECT, INCIDENTAL, CONSEQUENTIAL OR EXEMPLARY ARISING IN CONNECTION WITH THE SALE OR USE OF OR INABILITY TO USE THE VICTORY MOTORCYCLE FOR ANY PURPOSE. SOME STATES DO NOT ALLOW THE EXCLUSION OR LIMITATION OF ANY INCIDENTAL OR CONSEQUENTIAL DAMAGES, SO THE ABOVE LIMITATIONS MAY NOT APPLY TO YOU.

B. NO EXPRESS EMISSION CONTROL SYSTEM WARRANTY IS GIVEN BY VICTORY EXCEPT AS SPECIFICALLY SET FORTH HEREIN. ANY EMISSION CONTROL SYSTEM WARRANTY IMPLIED BY LAW, INCLUDING ANY WARRANTY OF MERCHANTABILITY OR FITNESS FOR A PARTICULAR PURPOSE, IS LIMITED TO THE EXPRESS EMISSION CONTROL SYSTEM WARRANTY TERMS STATED IN THIS WARRANTY. THE FOREGOING STATEMENTS OF WARRANTY ARE EXCLUSIVE AND IN LIEU OF ALL OTHER REMEDIES. SOME STATES DO NOT ALLOW LIMITATIONS ON HOW LONG AN IMPLIED WARRANTY LASTS SO THE ABOVE LIMITATIONS MAY NOT APPLY TO YOU.

C. No dealer is authorized to modify this Victory Limited Emission Control System Warranty.

WARRANTIES

IV. Legal Rights

THIS WARRANTY GIVES YOU SPECIFIC LEGAL RIGHTS, AND YOU MAY ALSO HAVE OTHER RIGHTS WHICH VARY FROM STATE TO STATE.

V. This Warranty Is In Addition To The Victory Limited Motorcycle Warranty.

VI. Additional Information.

Any replacement part that is equivalent in performance and durability may be used in the performance of any maintenance or repairs. However, Victory is not liable for these parts. The owner is responsible for the performance of all required maintenance. Such maintenance may be performed at a service establishment or by any individual. The warranty period begins on the date the motorcycle is delivered to an ultimate purchaser.

**Victory Motorcycle Division, Polaris Sales Inc.
P.O. Box 47700
Hamel, MN 55340-9960
ATTN: Warranty Department**

Victory Motorcycle Warranty Policy

Limited Warranty

Victory Motorcycle Division, Polaris Sales Inc., P.O. Box 47700, Hamel, Minnesota 55340-9960, gives a ONE YEAR LIMITED WARRANTY on all components of the Victory Motorcycle against defects in material or workmanship. This warranty covers the parts and labor charges for repair or replacement of defective parts which are covered by this warranty. This warranty begins on the date of purchase. This warranty is transferrable to another consumer during the warranty period through a Victory Motorcycle dealer.

Registration

At the time of sale, the Warranty Registration Form must be completed by your dealer and submitted to Victory Motorcycle Division, Polaris Sales Inc. within ten days. Upon receipt of this registration, Victory Motorcycle Division, Polaris Sales Inc. will record the registration for warranty. No verification of registration will be sent to the purchaser as the copy of the Warranty Registration Form will be the warranty entitlement. If you have not signed the original registration and received the “customer copy”, please contact your dealer immediately. **NO WARRANTY COVERAGE WILL BE ALLOWED UNLESS YOUR VICTORY MOTORCYCLE IS REGISTERED WITH VICTORY MOTORCYCLES DIVISION OF POLARIS SALES INC.**

Initial dealer preparation and set-up of your Victory Motorcycle is very important in ensuring trouble-free operation. Purchasing a motorcycle in the crate or without proper dealer set-up will void your warranty coverage.

WARRANTIES

Warranty Coverage And Exclusions:

Limitations Of Warranties And Remedies

The warranty excludes any failures that are not caused by a defect in material or workmanship. This warranty does not cover accidental damage, normal wear and tear, abuse or improper handling. This warranty also does not cover any Victory Motorcycle that has been altered structurally, modified, neglected, improperly maintained, used for racing, or used for purposes other than for which it was manufactured, or for any damages which occur during trailer transit or as a result of unauthorized service or the use of unauthorized parts. In addition, this warranty does not cover physical damage to paint or finish, stress cracks, tearing or puncturing of upholstery material, corrosion, or defects in parts, components or Victory Motorcycle due to fire, explosions or any other cause beyond Victory Motorcycle Division, Polaris Sales Inc. control.

This warranty does not cover the use of unauthorized lubricants, chemicals, or fuels that are not compatible with the Victory Motorcycle.

The exclusive remedy for breach of this warranty shall be, at Victory Motorcycle Division, Polaris Sales Inc. exclusive option, repair or replacement of any defective materials, or components or products. **THE REMEDIES SET FORTH IN THIS WARRANTY ARE THE ONLY REMEDIES AVAILABLE TO ANY PERSON FOR BREACH OF THIS WARRANTY. VICTORY MOTORCYCLES DIVISION OF POLARIS SALES INC. SHALL HAVE NO LIABILITY TO ANY PERSON FOR INCIDENTAL, CONSEQUENTIAL OR SPECIAL DAMAGES OF ANY DESCRIPTION, WHETHER ARISING OUT OF EXPRESS OR IMPLIED WARRANTY OR ANY OTHER CONTRACT, NEGLIGENCE, OR OTHER TORT OR OTHERWISE.** Some states do not permit the exclusion or limitation of incidental or consequential damages or implied warranties, so the above limitations or exclusions may not apply to you if inconsistent with controlling state law.

WARRANTIES

ALL IMPLIED WARRANTIES (INCLUDING BUT NOT LIMITED TO THE IMPLIED WARRANTIES OF MERCHANTABILITY AND FITNESS FOR A PARTICULAR PURPOSE) ARE LIMITED IN DURATION TO THE ABOVE ONE YEAR WARRANTY PERIOD. VICTORY MOTORCYCLES DIVISION OF POLARIS SALES INC. FURTHER DISCLAIMS ALL EXPRESS WARRANTIES NOT STATED IN THIS WARRANTY OTHER THAN EMISSIONS AND EXCISE WARRANTIES. Some states do not allow limitations on how long an implied warranty lasts, so the above limitation may not apply to you if inconsistent with controlling state law.

How To Obtain Warranty Service

If your Victory Motorcycle requires warranty service, you must take it to a Victory Motorcycle Servicing Dealer. When requesting warranty service you must present your copy of the Warranty Registration form to the dealer. (THE COST OF TRANSPORTATION TO AND FROM THE DEALER IS YOUR RESPONSIBILITY). Victory Motorcycles division of Polaris Sales Inc. suggests that you use your original selling dealer; however, you may use any Victory Motorcycle Servicing Dealer to perform warranty service.

Please work with your dealer to resolve any warranty issues. Should your dealer require any additional assistance they will contact the appropriate person at Victory Motorcycles division of Polaris Sales Inc.

This warranty also gives you specific legal rights, and you may also have other rights which vary from state to state.

If any of the above terms are void because of state or federal law, all other warranty terms will remain in effect.

SPECIFICATIONS

Model Year 2003	Classic Cruiser	Touring Cruiser
Dimensions		
Overall Length	94 in (239 cm)	98 in (249 cm)
Overall Width	29.5 in (75 cm)	42 in (107 cm)
Overall Height	44.5 in (113 cm)	60.8 (154 cm)
Seat Height	28.3 in (72 cm)	28.3 in (72 cm)
Wheelbase	63.3 in (161 cm)	65.5 in (166 cm)
Ground Clearance	5.5 in (14 cm)	5.5 in (14 cm)
Rake/Trail	30.0° / 4.76 in. (12.1 cm)	30.0° / 6.89 in. (17.5 cm)
Weight		
Dry Weight	634 lbs (288 kg)	720 lbs (326.6 kg)
Wet Weight	675 lbs (306.2 kg)	759 lbs (344.3 kg)
Gross Vehicle Weight Rating (GVWR)	1150 lbs (523 kg)	1210 lbs (549 kg)
Capacities		
Engine Oil	6 Qt (5.7 Ltr)	6 Qt (5.7 Ltr)
Fuel	5 US Gal (19 Ltr)	5 US Gal (19 Ltr)

NOTE: Dimensions and specifications may vary with features, options and accessories.

SPECIFICATIONS

Model Year 2003	Classic Cruiser	Touring Cruiser
Engine		
Engine Model Number	MCVT1507D 2003	MCVT1507D 2003
Configuration	50° V-Twin	50° V-Twin
Displacement	92 cu in (1507 cc)	92 cu in (1507 cc)
Cooling System	Air & Oil	Air & Oil
Compression Ratio	9.2:1	9.2:1
Valve Train	4 Valves Per Cylinder With Hydraulic Lifters	4 Valves Per Cylinder With Hydraulic Lifters
Bore and Stroke	97 x 102 mm	97 x 102 mm
Throttle Body Bore	44 mm	44 mm
Exhaust System	Dual-Staggered	Dual-Crossover
Lubrication System	Wet Sump	Wet Sump
Spark Plug/Gap	NGK CR7EB .032 in (0.8 mm)	NGK CR7EB .032 in (0.8 mm)

SPECIFICATIONS

Model Year 2003	Classic Cruiser	Touring Cruiser
Drive System		
Final Drive Type	Fiberglass Reinforced Belt	Fiberglass Reinforced Belt
Transmission Type	5 speed - Constant Mesh	5 speed - Constant Mesh
Primary Drive	Gear With Torque Compensator	Gear With Torque Compensator
Primary Reduction Ratio	1.5:1	1.5:1
Gear Shift Pattern	1 Down, 4 Up	1 Down, 4 Up
Internal Gear Ratios		
1st	3.2:1	3.2:1
2nd	2.19:1	2.19:1
3rd	1.53:1	1.53:1
4th	1.24:1	1.24:1
5th	1:1	1:1
Final Drive Ratio	2.13:1	2.13:1
Clutch Type	Wet Multi-Plate Diaphragm Spring	Wet Multi-Plate Diaphragm Spring
Chassis		
Front Suspension Type/Travel	Telescopic Fork 5.1 in (13 cm)	Telescopic Fork 5.1 in (13 cm)
Rear Suspension Type/Travel	Single, Monotube Gas, Preload Adjustable 4 in (10 cm)	Single, Monotube Gas, Preload Adjustable 4 in (10 cm)
Swingarm	Triangulated Steel/Quick Change Belt Feature	Triangulated Steel/Quick Change Belt Feature
Front Brakes	Single 300 x 5 mm Floating Rotor 4 Piston Caliper	Dual 300 x 5 mm Floating Rotor 4 Piston Caliper
Rear Brakes	Single 300 x 6 mm Floating Rotor 2 Piston Caliper	Single 300 x 6 mm Floating Rotor 2 Piston Caliper

SPECIFICATIONS

Model Year 2003	Classic Cruiser	Touring Cruiser	
Wheels and Tires			
Front Wheel Type/Size	Cast 5 Spoke 16 x 3 in	Cast 5 Spoke 16 x 3 in	
Rear Wheel Type Size	Cast 5 Spoke 16 x 3.5 in	Cast 5 Spoke 16 x 3 in	
Front Tire Type/Size	Dunlop 491 Elite II MT90B/16 71H	Dunlop 491 Elite II MT90 B16 71H	
Rear Wheel Type/Size	Dunlop D417 160/80B/16 75H	Dunlop D417 160/80 B16 75H	
Electrical			
Alternator	38 Amp Max Output	38 Amp Max Output	
Battery	12 Volts 18 Amp Hour	12 Volts 18 Amp Hour	
Lights and Fuses			
Fuses	Ignition / Coil	15 amp	15 amp
	Horn/Brake/Headlamp	20 amp	20 amp
	Flashers	15 amp	15 amp
	PCM	20 amp	20 amp
	Fuel Pump	10 amp	10 amp
Bulbs	Headlamp (Intl.)	ANSI HG024XV (H4)	ANSI HG024XV (H4)
	Taillight	ANSI 198	ANSI 198
	Running/Front Turn	ANSI 198	ANSI 198
	Rear Turn Signals	ANSI 199	ANSI 199
	UK Models Front Position Light	ANSI 193	ANSI 193

SPECIFICATIONS

Fuel Specifications

Use only unleaded gasoline, 92 pump octane minimum.

DO NOT USE GASOLINE CONTAINING METHANOL.

Using gasoline/methanol blends can result in poor starting and driveability, and may damage critical fuel system components.

Gasoline containing up to 15% Methyl Tertiary Butyl Ether (MTBE) can be used.

Gasoline containing up to 10% Ethanol can be used.

Gasoline that has been Reformulated or Oxygenated can be used.

Engine Oil Specifications

Polaris recommends the use of Victory Brand Semi-Synthetic 20W-40 Motor Oil or equivalent.

Service Manual Available

You can purchase a genuine 2003 Victory Service Manual through your dealer. Order part number 9918370.

IDENTIFICATION NUMBERS

Record important numbers below.

Vehicle Identification Number: _____

(Located on right side of steering head, see page 42)

Engine Identification Number: _____

(Located on top of crankcase behind rear cylinder, see page 43)

Ignition Key Number: _____

(Stamped on shaft of key, see page 43)

Model Number: _____

(Located on left side of steering head, see page 43)

INDEX

A

Accelerating	87
Accessory Selection and Installation	20
Air Filter	100
Auxiliary Lights Adjustment	142
Axle Front	111
Axle Rear	109

B

Battery	136-139
Battery Charging	138
Battery Installation	139
Battery Removal	137
Brake Fluid	124
Brake Fluid Level	70-71, 121-123
Brake Hoses	126
Brake Lever Lubrication	120
Brake Lever Movement	70, 120
Brake Pads	72, 126
Brake Pedal Freeplay	71, 123
Brake Pedal Freeplay	122
Brakes	70-71, 120-126
Braking	88
Break-in Period	79-83

C

Carrying a Passenger	12
Carrying Cargo	17
Changing Engine Oil	97-98
Changing Oil	97-98
Changing Oil Filter	97-98
Check Engine Indicator	54
Clock	52
Clutch	73, 116-118
Clutch Freeplay	118
Clutch Lever	57
Clutch Lever and Cable	116
Clutch Lever Lubrication	117
Components, Classic Cruiser	38-39
Components, Touring Cruiser	40-41
Control Cable Lubrication	119
Crankcase Ventilation Hose	112

D

Defects	36
Drain Plug	97
Drive Belt	75, 102-104
Drive Belt Condition	102
Drive Belt Tension	102-104
Drive Sprocket	101
Drive Sprocket Nut	101

E

Electrical Equipment	65-66
Emergency Flasher Switch	58
Emergency Flashers	66
Emissions Control System Warranty	159
Engine Break-in Period	79-83
Engine Compression	133
Engine Identification Number	43
Engine Oil	97-99
Engine Oil Level	67, 99
Engine Oil Specifications	173
Engine Stop/Run Switch	58, 66
Evaporative Emission Control System (California model only)	68, 112
Exhaust	21
Exhaust System	133-134

F

Fast Idle Lever	56, 73, 114
Fast Idle Lever Freeplay	114
Fasteners	76, 147
Fork Oil	110
Forks	110
Front Axle	111
Front Brake Fluid Level	70
Front Brake Lever	59
Front Brake Lever Movement	70
Front Suspension	74, 110-111
Fuel	21

INDEX

F

Fuel Cap	61
Fuel Components	68
Fuel Filter	113
Fuel Gauge	53
Fuel Hose	68
Fuel Hose, Rail and Connections	68, 112
Fuel Level	68
Fuel Specifications	172
Fuel Stabilizer	155
Fuel System	112-113
Fuel Tank	112
Fueling and Fill Height	81
Fuses	140

G

Gasoline	21
Gear Shift Pedal	60, 127
Gross Vehicle Weight Rating (GVWR)	14-16

H

Handlebar Components	37
Handlebar Controls, Left	56-57
Handlebar Controls, Right	58-59
Hazardous Materials, Handling	92
Headlamp	65
Headlamp Adjustment	141

H

Headlamp High Beam Indicator	50
Headlamp High Beam Indicator Light Dimmer	53
Headlamp High/Low Beam Switch	56
Helmet Holders	47
Horn	66
Horn Button	57
Hoses and Connections	72

I

Ignition Key	45
Ignition Key Number	43
Ignition Switch	46-47
Indicator Lights	49-50
Initial Maintenance	93
Instrument Cluster	48, 65
Instrument Cluster Light Dimmer	53

L

Light Switch	61
Low Fuel Indicator	49
Low Oil Pressure Indicator	49

M

Maintenance	22-23
Maintenance Interval Table	94-96
MFD Functions	55

M

MFD Mode Button	59
MFD Set Button	57
Modifications	19
Multi-Function Display (MFD)	51-54

N

Neutral Indicator	49
Noise Emission Warranty	158
Noise Regulation	158

O

Odometer	51
Oil	97-99
Oil Fill Cap/Dipstick	98
Oil Filter	97-98
Oil Level	67, 98-99
Oil Specifications	173

P

Park Position (P)	47
Parking the Motorcycle	19, 90-91
Periodic Maintenance Intervals	93
Protective Apparel	13

R

Rear Axle	109
Rear Brake Fluid Level	71
Rear Brake Pedal	60

R

Rear Brake Pedal Freeplay	71
Rear Shock Absorber	107-108
Rear Suspension	75, 107-109
Rear Wheel	105-106
Recommended Oil	97
Recommended Shift Points	86
Removal from Storage	157
Repairing Painted Surface Damage ..	153
Reporting Safety Defects	36
Road Test	147
Running Lights	66

S

Saddlebag Care, Leather	153
Saddlebag Removal/Installation .	143-144
Saddlebags	18
Saddlebags (Hard)	62, 144
Saddlebags (Leather)	62, 143
Safe Riding Practices	7-13
Safety and Vehicle Information Labels	24-35
Seat Release	46-47
Seat Removal and Installation	135
Service Manual	173
Set Button	57
Shift Points	86

S

Shifting Gears	84-86
Shock Absorber	107-108
Side Covers	63
Sidestand	63, 76, 145-146
Sidestand Lubrication	146
Sidestand Pad	145
Spark Plugs	131-132
Speedometer	48
Starter Button	58
Starting the Engine	82-83
Steering	74, 110-111
Steering Lock	45
Stop/Run Switch	58, 66
Stopping the Engine	89
Suspension, Front	74, 110-111
Suspension, Rear	75, 107-109
Swing Arm	109
Symbols and Terms Used in the Owner's Manual	6

T

Tachometer	48
Taillight	65
Test Drive	147
Throttle	115
Throttle Control Cable	115

T

Throttle Control Cables	72
Throttle Control Grip	59, 72, 115
Throttle Freeplay	115
Tire Condition	69, 129
Tire Pressure	128
Tire Pressure Table	128
Tire Tread Depth	69, 129
Tires	69, 128-129
Transporting the Motorcycle	18
Trip Odometer	51
Turn Signal Indicators	50
Turn Signal Switch	56
Turn Signals	66

V

Vehicle Identification Number	42
Victory Motorcycle Warranty Policy .	165
VIN	42
Voltmeter	53

W

Washing and Drying the Motorcycle	149-150
Waxing, Polishing and Applying Protectants	151
Wheel Alignment, Rear	105-106
Wheel Spokes	130
Windshield Care	152



POLARIS[®]
The Way Out.

Part No. 9918229

PRINTED IN THE USA